

RACK TROLLEY

Tél : (514) 492-1234

Email : info@distribution-vision.com

Site web : www.distribution-vision.com

TRANSPORT



VISION
DISTRIBUTION
BUY IT AT LESSER PRICES.

BUY IT AT LESSER PRICES

Runner Option:  
M Shape Small L



6-TIER RACK TROLLEY

- Designed to pack GN and transport them
- Suitable for GN sizes 2/1,1/1,1/2,1/3,2/3 in 65mm depth
- PVC/TPR wheels are available 2 with brakes
- M shape layers, its construction is enough strong to support 15kg/shelf
- Stop lever at diagonal sides, to avoid the pans sliding out



| code | mm |
|--------|-------------|
| 111701 | 380x550x950 |
| 111702 | 590x670x950 |

GN RACK TROLLEY WITH TABLE TOP

- Designed to pack GN and offer a table top
- Suitable for GN sizes 2/1,1/1,1/2,1/3,2/3 in 65mm depth
- PVC/TPR wheels are available 2 with brakes
- M shape layers, its construction is enough strong to support 15kg/shelf
- Stop lever at diagonal sides, to avoid the pans sliding out



| code | mm |
|--------|-------------|
| 111601 | 380x550x950 |
| 111602 | 380x550x950 |
| 111603 | 590x670x950 |
| 111604 | 590x670x950 |



-Bending square tube as the mainly frame



Connection between tubes



-The layers was welded on the tubes, suitable for the GN pan



-Stop lever for preventing pans from slipping off



GN & BAKING 2 IN 1 SHELF CART

- Material: Stainless steel 201
- Special layer design for 1/1 GN pans and 40x60cm baking trays
- Tiers with stop ridge, width 15mm
- Distance between tiers: 75mm
- Payload: max.150kg
- Customized height to meet different occasions
- Fitted with four castors of which have two brakes .
- Extra heavy construction
- Delivered in a carton, flat packed



| code | CBM | mm |
|--------|-------|---------------|
| 110410 | 0.162 | 465x620xH1735 |

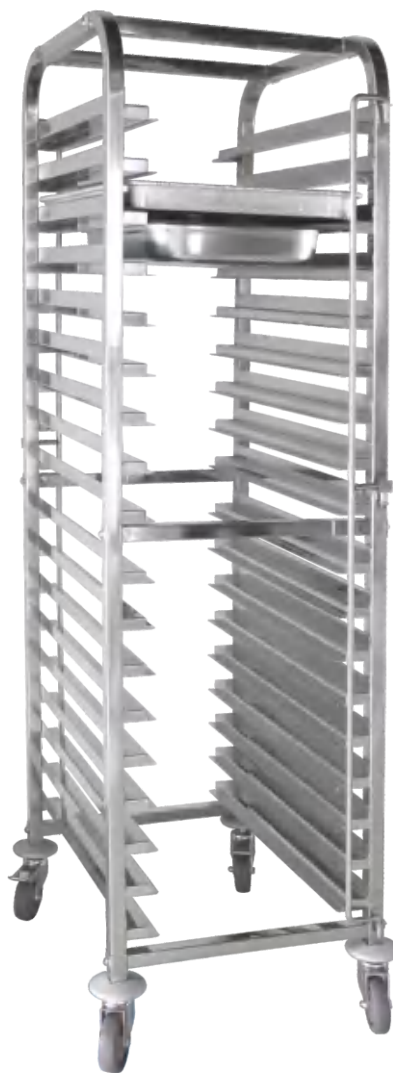

GN & BAKING 2 IN 1 SHELF CART

- Material: Stainless steel 201
- Special layer design for 1/1 GN pans and 40x60cm baking trays
- Tiers with stop ridge, width 15mm
- Distance between tiers: 75mm
- Payload: max.150kg
- Customized height to meet different occasions
- Fitted with four castors of which have two brakes .
- Extra heavy construction
- Delivered in a carton, flat packed



| code | CBM | mm |
|--------|-------|---------------|
| 110411 | 0.087 | 465x620xH1000 |

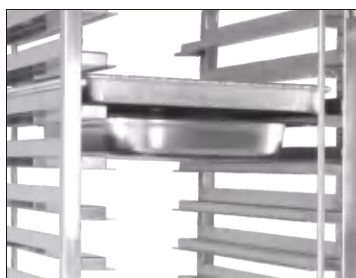
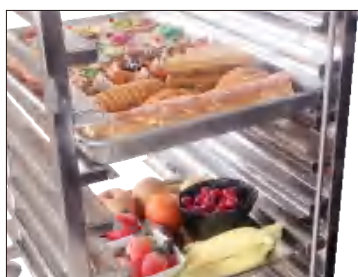

- Special layers design, suitable for GN pan and baking tray
- Smooth edge of the layers, without any sharp burs , safety for used.
- Each size with stop lever for preventing pans from slipping off

Z-TYPE SHELF CART

- In order to save space during storage trolleys can be pushed into one another.
- GN 1/1with 15 layers- inters paced at 80mm.
- Tray locks on either side.
- Fitted with four castors of which two have brakes.
- Flat pack delivery.

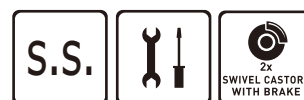

Runner Option:



Small L Big L BM Shape

| code | CBM | mm |
|--------|-------|--------------|
| 110301 | 0.085 | 380x550x1700 |
| 110302 | 0.107 | 590x670x1700 |
| 110303 | 0.110 | 470x620x1700 |



110303



110301



-Spot welding layers and the stop lever



-Stackable structure for space saving

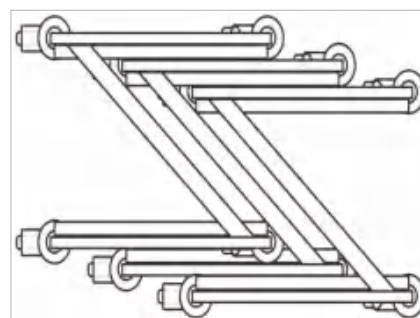

-Stackable structure for space saving



Runner Option:  
Small L Big L



BAKERY RACK TROLLEY

- In order to pack and storage the baking pans
- Tray locks on either side.
- Max loading 150kg
- Smooth edge without sharp burs , safety for used
- Customized height from 12 tiers to 20 tiers
- Layers fixed on the tube by strong spot welding , stable and durable
- Fitted with four castors of which two have brakes.
- 15-tier,for 15pcs 40x60 pans



| code | CBM | mm |
|--------|-------|---------------|
| 110102 | 0.113 | 470x620xH1700 |

BAKERY RACK TROLLEY

- In order to pack and storage the baking pans
- Tray locks on either side.
- Max loading 150kg
- Smooth edge without sharp burs , safety for used
- Customized height from 12 tiers to 20 tiers
- Layers fixed on the tube by strong spot welding , stable and durable
- Fitted with four castors of which two have brakes.
- 15-tier,for 15pcs 40x60 pans



| code | CBM | mm |
|--------|-------|---------------|
| 110101 | 0.146 | 620x820xH1700 |

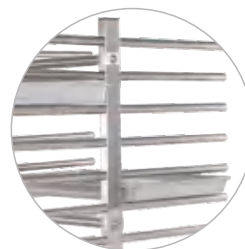

18-TIER BAKERY TROLLEY

- In order to pack and storage the baking pans
- Max loading 150kg
- Smooth edge without sharp burs , safety for used
- Customized height from 12 tiers to 20 tiers
- Fitted with four castors of which two have brakes.
- Flat pack delivery.



| code | CBM | mm |
|--------|-------|----------------|
| 110411 | 0.158 | 1200x800xH1800 |



16-TIER ROTARY OVEN TROLLEY



- In order to pack and storage the baking pans
- Tray locks on either side.
- Max loading 150kg
- Smooth edge without sharp burs , safety for used
- Customized height from 12 tiers to 20 tiers
- Layers fixed on the tube by strong spot welding, stable and durable
- Fitted with four castors of which two have brakes.
- 16pcs 40x60 pans/ 32pcs 40x60 pans



| code | CBM | mm |
|--------|-------|---------------|
| 110201 | 0.087 | 610x468xH1700 |
| 110202 | 0.090 | 658x810xH1700 |



ROTARY OVEN RACK TROLLEY WITH WINDOW



| code | CBM | mm |
|--------|-------|---------------|
| 111201 | 0.184 | 510x730xH1800 |
| 111202 | 0.259 | 650x860xH1800 |



ROTARY OVEN RACK TROLLEY WITH WINDOW



| code | CBM | mm |
|--------|-------|---------------|
| 111301 | 0.254 | 670x840xH1850 |





6-TIER DUAL-ROW GN RACK TROLLEY (111801)

7-TIER DUAL-ROW GN RACK TROLLEY (111901)

- Designed to pack GN and offer a table top
- Suitable for GN sizes 2/1,1/1,1/2,1/3,2/3 in 65mm depth
- PVC / TPR wheels are available,2 with brakes
- M shape layers, its construction is enough strong to support 15kg/shelf
- Stop lever at diagonal sides, to avoid the pans sliding out

GN RACK DUAL-ROW TROLLEY WITH TABLE TOP

- Designed to pack GN and offer a table top
- Suitable for GN sizes 2/1,1/1,1/2,1/3,2/3 in 65mm depth
- PVC / TPR wheels are available,2 with brakes
- M shape layers, its construction is enough strong to support 15kg/shelf
- Stop lever at diagonal sides, to avoid the pans sliding out



| code | CBM | mm |
|--------|-------|--------------|
| 111801 | 0.064 | 740x550xH950 |
| 111901 | 0.079 | 740x670xH950 |



| code | CBM | mm |
|--------|-------|--------------|
| 111401 | 0.064 | 740x550xH950 |
| 111501 | 0.079 | 740x670xH950 |



Runner Option:



M Shape



Small L



| code | CBM | mm |
|--------|-------|---------------|
| 111412 | 0.717 | 550x738xH1725 |



| code | CBM | mm |
|--------|-------|--------------|
| 190202 | 0.457 | 900x620xH800 |



BASE FRAME

- Material; Stainless steel
- Number bf drawers:4
- Format dawers: 600 x 400 mm
- Size: 675 x835 X 855 mm
- Weight: 14 kg



| code | mm |
|--------|----------------|
| 190301 | 675 x835 X 855 |



TRANSPORT

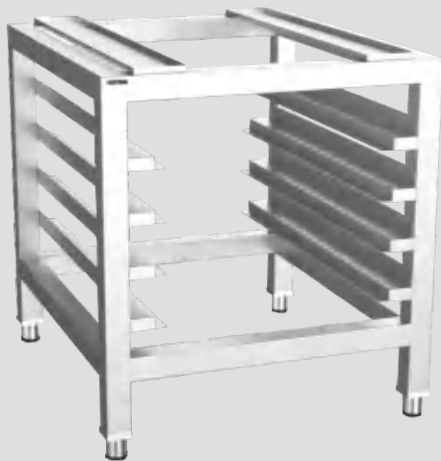

BASE FRAME

- Material; Stainless steel
- Number bf drawers:4
- Format dawers: 600 x 400 mm
- Size: 675 x835 X 855 mm
- Weight: 14 kg



| code | mm |
|--------|----------------|
| 190302 | 675 x835 X 855 |



- Gastronome trolleys ideal for a wide range of food transport, serving and storage tasks within the catering industry.
- 100% avoid rails-dropping by strong spot welding.
- Fitted with GN sizes 1/1, 1/2, 2/3, 1/3 and 2/1 from 6 tiers to 20 tiers. - Single or double row designs will meet your different demands
- Stable layers option for supporting heavy duty service, max loading 15kg/shelf - Tray locks on either side for anti-sliding the pans
- Smooth edge of each bars caring your hand
- Fitted with 4 pcs TPR / PVC swivel castors, 2 with brakes



-The layers was welded on the tubes, suitable for the GN pan



-Stop lever for preventing pans from slipping off



-Bending square tube as the mainly frame



-Connection between tubes

VISION DISTRIBUTION



160101-160201



112001-112201



112401-112501

Runner Option:  
M Shape Small L

15-TIER DUAL-ROW GN RACK TROLLEY 16-TIER DUAL-ROW GN RACK TROLLEY



| code | CBM | mm |
|--------|-------|---------------|
| 160101 | 0.132 | 740x550xH1700 |
| 160201 | 0.132 | 740x550xH1700 |

1/1 GN RACK TROLLEY 2/1 GN RACK TROLLEY

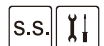

| code | CBM | mm |
|--------|-------|---------------|
| 112001 | 0.092 | 380x550xH1700 |
| 112101 | 0.092 | 380x550xH1700 |
| 112201 | 0.095 | 385x555xH1750 |
| 112401 | 0.109 | 590x670xH1700 |
| 112501 | 0.109 | 590x670xH1700 |

12-TIER WIRE RACK TROLLEY

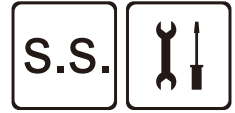

- Material : stainless steel 201
- Suitable for packing the GN pan , fast food tray
- Customized height from 12 tiers to 20 tiers.
- Side panels designs for your selection
- max loading 8kg/shelf
- Fitted with 4pcs TPR / PVC swivel castors, 2 with brakes

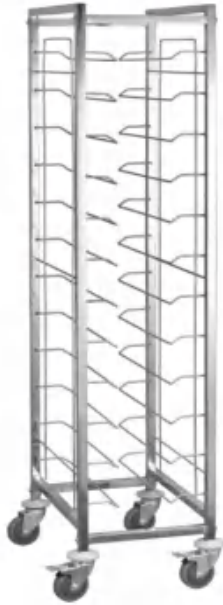

110801



110901



111001



111101



-Suitable for GN size 1/1 x 65



-Spot welding to connect the tubes and tube



-Bumper protector and wheels with brake

| code | CBM | mm | Remark |
|--------|-------|----------------|--------------------------------------|
| 110801 | 0.174 | 380x550xH1800 | 12tiers, single row, w/o side panels |
| 111901 | 0.205 | 380x550xH1800 | 12tiers single row, with side panels |
| 111001 | 0.349 | 850x570xH1800 | 12tiers, dual rows, w/o side panels |
| 111101 | 0.410 | 850x 570xH1800 | 12tiers, dual rows, with side panels |



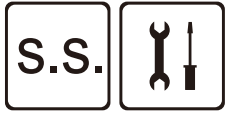

TRANSPORT



-Design to packing plates and trays



-Each tubes fitted with the anti-skidding pipe



-Suitable for the plates no less than dia.230mm



-With 4pcs swivel castors, 2 with brakes

PLATES RACK TROLLEY ,FOR DISH PLATES & FAST FOOD TRAY



| code | CBM | meas. | mm | Remark |
|--------|-------|--------------|---------------|--------------------------------------|
| 180101 | 0.181 | 755x640xH375 | 606x598xH1635 | 20 tiers, for 80pcs dia.230mm plates |

BUY IT AT LESSER PRICES



7-TIER BAKERY TROLLEY

| code | CBM | mm |
|--------|-------|---------------|
| 170101 | 0.085 | 740x460xH1800 |



RACK TROLLEY FOR DISHWASHER BASKETS

| code | CBM | Remark | mm |
|--------|-------|-------------------|----------------|
| 110601 | 0.052 | 4 tiers | 505x550xH 1000 |
| 110602 | 0.096 | 7 tiers | 505x550xH 1800 |
| 110501 | 0.178 | 9tiers, dual rows | 1095x505xH1700 |

18-TIER ALUMINUM BAKING TROLLEY

- In order to pack and storage the baking pans / trays
- Max loading 150kg
- Aluminum baking trolley
- Smooth edge without sharp burs , safety for used
- Customized height from 12 tiers to 20 tiers
- Layers fixed on the tube by strong screw ,stable and durable
- Fitted with four castors of which two have brakes.
- With / without door designed for meeting different demands
- Surface: Anodizing / Suitable for 600x400mm pans
- Flat pack delivery.
- With PC board / door, fixed layers



| code | CBM | mm |
|--------|-------|---------------|
| 170105 | 0.052 | 665x525xH1790 |

Runner Option:

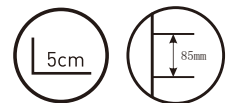

Big L



-Door designed



-Wheel with brakes



-Layers fixed by screw





For 40x60mm Bakery pan



9 TIERS RACK TROLLEY FOR DISHWASHER BASKETS

| code | mm | mm |
|--------|-------|--------------|
| 805109 | 0.104 | 605x465xH980 |



15 TIERS RACK TROLLEY FOR DISHWASHER BASKETS

| code | mm | mm |
|--------|-------|---------------|
| 805020 | 0.144 | 605x465xH1485 |



18 TIERS RACK TROLLEY FOR DISHWASHER BASKETS

| code | mm | mm |
|--------|-------|---------------|
| 805021 | 0.175 | 605x465xH1790 |

2-TIER WOODEN TROLLEY

- Material: oak
- Fungus proofing
- Easy maintenance
- Anti-corrosion
- Include 4 TPR castors, dia. 100mm, 2 with brakes
- Color light/bark/brown
- Flatpack delivery



| code | CBM | mm |
|--------|-------|--------------|
| 102013 | 0.144 | 700x500xH800 |
| 102014 | 0.144 | 700x500xH800 |



2-TIER WOODEN TROLLEY

- Material: oak
- Fungus proofing
- Easy maintenance
- Anti-corrosion
- Include 4 TPR castors, dia. 100mm, 2 with brakes
- Color light/bark/brown
- Flatpack delivery



| code | CBM | mm |
|--------|-------|--------------|
| 102015 | 0.220 | 900x450xH800 |
| 102016 | 0.220 | 900x450xH800 |





2 TIERS-HEAVY DUTY TROLLEY

Material :SS201+pp



| code | CBM | mm |
|--------|-------|--------------|
| 150101 | 0.120 | 910x600xH920 |
| 150102 | 0.080 | 730x490xH890 |



3 TIERS-HEAVY DUTY TROLLEY

Material :SS201+pp



| code | CBM | mm |
|--------|-------|--------------|
| 150201 | 0.143 | 910x600xH920 |
| 150202 | 0.096 | 730x480xH890 |



MULTIFUNCTIONAL TROLLEY



| code | CBM | mm |
|--------|-------|-------------|
| 120401 | 0.065 | 820x440x950 |



HEAVY DUTY PLATFORM TROLLEY (KNOCK-DOWNED)



| code | CBM | mm |
|--------|-------|-------------|
| 120501 | 0.095 | 910x600x920 |
| 120502 | 0.057 | 730x480x890 |

HEAVY DUTY PLATFORM TROLLEY (FOLDING TYPE)

- Material: Stainless steel 201 and polypropylene
- Fitted with 4 PVC heavy duty swivel castors
- Round tube handles
- Anti-skid design on the PP board
- Folding structure
- Qty / ctn :1pcs
- Flat pack delivery



| code | CBM | mm |
|--------|-------|-------------|
| 120301 | 0.095 | 910x600x920 |
| 120302 | 0.057 | 730x480x890 |





FOLDABLE PLATFORM TROLLEY

-Material: stainless steel 201
-Tube: dia.38 mm,0.8mm thickness
-S/S board: Ss201, 0.8mm thickness



| code | CBM | mm |
|--------|-------|-------------|
| 120301 | 0.076 | 820x520x970 |
| 120302 | 0.059 | 720x450x850 |



KNOCK-DOWNED PLATFORM CART

-Material: stainless steel 201
-Tube: dia.38 mm,0.8mm thickness
-S/S board: Ss201, 0.8mm thickness



| code | CBM | mm |
|--------|-------|-------------|
| 120501 | 0.092 | 900x550x770 |

PLATES COLLECTING TROLLEY



| code | CBM | mm |
|--------|-------|-------------|
| 140601 | 0.088 | 975x515x800 |



KNOCK-DOWNED PLATFORM CART



| code | CBM | mm |
|--------|-------|-------------|
| 140101 | 0.423 | 720x520x930 |



PLATES COLLECTING TROLLEY



| code | CBM | mm |
|--------|-------|-------------|
| 140102 | 0.333 | 810x515x905 |



MULTI-FUNCTION STORAGE SHELF

- Material : stainless steel 201 tube ,1.2mmT + Nylon + PP tray, 3.5mmT
- Adjustable shelf distance, offer more different selection, more flexible
- Assembly without screws,
- Can remove the tray and put the GN pans
- As the roles of storage rack and GN rack
- Add the handles and wheels, the storage rack / GN shelf can be removed conveniently
- Max loading: 50kg/shelf,total 200kg



| code | CBM | mm |
|--------|-------|----------------|
| 320701 | 0.091 | 846x372xH1610 |
| 320702 | 0.127 | 1196x372xH1610 |
| 320703 | 0.139 | 1546x372xH1610 |
| 320704 | 0.163 | 1896x372xH1610 |



Adjustable shelves distance

Removable PP tray

Suitable for 1/1,1/2,2/3,1/3 GN pan

VISION DISTRIBUTION

REMOVABLE MULTI-FUNCTION STORAGE SHELF

- Material : stainless steel 201 tube ,1.2mmT + Nylon + PP tray, 3.5mmT
- Adjustable shelf distance, offer more different selection, more flexible
- Assembly without screws,
- Can remove the tray and put the GN pans
- As the roles of storage rack and GN rack
- Add the handles and wheels, the storage rack / GN shelf can be removed conveniently
- Max loading: 50kg/shelf,total 200kg



| code | CBM | mm |
|--------|-------|----------------|
| 320705 | 0.049 | 856x372xH1021 |
| 320706 | 0.057 | 1033x372xH1021 |

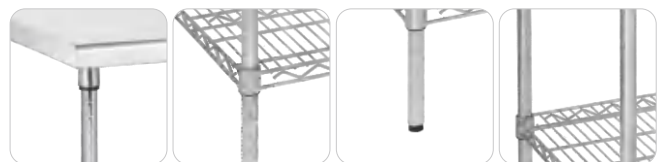

Round edge design

Removable shelf design

Rubber feet

Fasten without screw

WIRE STORAGE RACK



| code | CBM | mm |
|--------|-------|----------------|
| 320601 | 0.097 | 1200x450xH1550 |
| 320602 | 0.137 | 1200x600xH1550 |
| 320603 | 0.130 | 1500x450xH1550 |
| 320604 | 0.171 | 1500x600xH1550 |
| 320605 | 0.156 | 1800x450xH1550 |
| 320606 | 0.204 | 1800x600xH1550 |



BUY IT AT LESSER PRICES



ADJUSTABLE STORAGE RACK

- Ideal for home use or commercial purposes
- Customized size available
- Knocked-down structure, low transportation cost and easy to assemble
- Material: stainless steel 201 , 0.9mm thickness
- Adjustable bullet feet



| code | CBM | mm |
|--------|-------|----------------|
| 320501 | 0.140 | 1200×500×H1550 |
| 320502 | 0.166 | 1200×600×H1550 |
| 320503 | 0.142 | 1500×500×H1550 |
| 320504 | 0.169 | 1500×600×H1550 |
| 320505 | 0.169 | 1800×500×H1550 |
| 320506 | 0.200 | 1800×600×H1550 |

VISION
DISTRIBUTION



Screw assemble the shelf



Rib rack



Adjustable bullet feet



SQUARE TUBE STORAGE RACK



| code | CBM | mm |
|--------|-------|----------------|
| 320401 | 0.170 | 1200×500×H1550 |
| 320402 | 0.201 | 1200×600×H1550 |
| 320403 | 0.170 | 1500×500×H1550 |
| 320404 | 0.201 | 1500×600×H1550 |
| 320405 | 0.196 | 1800×500×H1550 |
| 320406 | 0.233 | 1800×600×H1550 |



ROUND TUBE STORAGE RACK(BOARD TYPE)

| code | CBM | mm |
|--------|-------|----------------|
| 320201 | 0.140 | 1200×500×H1550 |
| 320202 | 0.166 | 1200×600×H1550 |
| 320203 | 0.142 | 1500×500×H1550 |
| 320204 | 0.169 | 1500×600×H1550 |
| 320205 | 0.169 | 1800×500×H1550 |
| 320206 | 0.200 | 1800×600×H1550 |

ROUND TUBE STORAGE RACK(LADDER TYPE)

| code | CBM | mm |
|--------|-------|----------------|
| 320301 | 0.140 | 1200×500×H1550 |
| 320302 | 0.166 | 1200×600×H1550 |
| 320303 | 0.142 | 1500×500×H1550 |
| 320304 | 0.169 | 1500×600×H1550 |
| 320305 | 0.169 | 1800×500×H1550 |
| 320306 | 0.200 | 1800×600×H1550 |

BUY IT AT LESSER PRICES

FOLDABLE TROLLEY

- Material:SS201+PP+TPR
- 3 or 4 shelves design,the shelf distance is 2pcm
- Folded structure could help you to save space
- Portable carrying, especially could put in your car easily
- Plastic tray without any smells,with a long ierving life

NEW

TRANSPORT



Suitable;for 50x50 glass rack

3 TIERS / SHELVES

| code | CBM | mm |
|--------|-------|--------------|
| 102103 | 0.210 | 930x510xH930 |

4 TIERS / SHELVES

| code | CBM | mm |
|--------|-------|---------------|
| 102104 | 0.210 | 930x510xH1196 |



- Supporting bar underneath the tray, which could make the structure more stable
- Smooth plastic handle
- Each tray with profile edge



- Fully folded view
- with the stop brake
- 3-Tier cart fully folded dimrnsions:93x20.5xH110cm



- Fully folded structure could be packed in thecart for outdoor activities using
- Portable and flexible

BUY IT AT LESSER PRICES

FOLDABLE TROLLEY

- Material:SS201;
- Folded structure could help you to save space
- Suitable for the hotel ,restaurant , outdoor or parties
- Assembly delivery could save your time for immediately use-Easy to operate
- Outstanding loading capacity, max loading 250kg-TPR wheels,2 with brakes

FOLDABLE TROLLEY

| code | CBM | mm |
|--------|-------|--------------|
| 102101 | 0.135 | 635x401xH960 |
| 102102 | 0.194 | 885x501xH960 |



BUY IT AT LESSER PRICES



ROUND TUBE SERVING TROLLEY

- Material : SS201 / SS430 / SS304 is available
- Tray thickness:0.5/ 0.6 / 0.8mm,Tube thickness:0.6 / 0.8mm
- Brushed polished surface
- Knocked-down or sold welding structure is by your choice
- Max. load capacity: 50kg/per shelf
- Fitted with 4 PCS TPR swivel castors, 2 with brakes, can stop on the slope
- Flat pack delivery

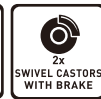

**VISION
DISTRIBUTION**

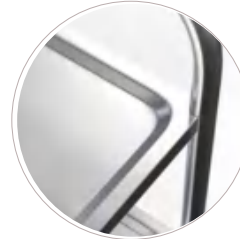

- Connected tightly
- Profile edge

2-TIERS S/S TROLLEY

- Round tube structure
- There's mute damper underneath the tray
- With the corner protectors
- Max loading 100kg,50kg per shelf

| code | CBM | mm |
|--------|-------|----------------|
| 101001 | 0.094 | 1040x625xH1030 |
| 101002 | 0.062 | 845x525xH940 |
| 101003 | 0.050 | 805x460xH900 |
| 101004 | 0.041 | 705x405xH810 |



3-TIERS S/S TROLLEY

- Material: SS201/SS430/SS304
- Max loading capacity 150kg,50kg each shelf

| code | CBM | mm |
|--------|-------|----------------|
| 101101 | 0.119 | 1100x600xH1200 |
| 101102 | 0.079 | 845x525xH940 |
| 101103 | 0.064 | 805x460xH900 |
| 101104 | 0.053 | 705x405xH810 |





4-TIERS S/S TROLLEY

- Fitted with 4 shelves
- Especially for hotel, restaurant, lab, kitchen, library used
- Max loading capacity 200kg,50kg each shelf

| code | CBM | mm |
|--------|-------|---------------|
| 101201 | 0.124 | 845x525xH1240 |
| 101202 | 0.100 | 805x460xH1180 |
| 101203 | 0.079 | 705x405xH1070 |

**VISION
DISTRIBUTION**

TRANSPORT



2 Swivel castors with brakes



TPR Wheel



Mute Damper

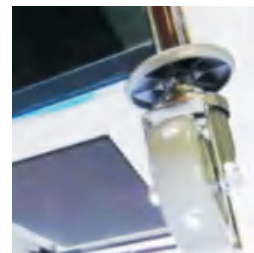

Impact Protect



Profile Edge



5-TIERS S/S TROLLEY

- Fitted with 5 shelves
- Material stainless steel 201 / 430 / 304 may meet your specific requirements
- Thickness 0.5 / 0.6 / 0.8 mm is available, satisfy different markets
- Customized logo is available
- Brushed polishing surface-Shelf distance: 270mm
- Fitted with 4TPR swivel castors, less noise, including 2 brakes, can stop on the 10 degree slope when loading weights
- Especially for hotel, restaurant, lab, kitchen, library used
- Max loading capacity 200kg,from bottom to top is 50/50/50/30/20kg-Flatpack delivery

| code | CBM | mm |
|--------|-------|---------------|
| 101101 | 0.157 | 845x525xH1540 |
| 101102 | 0.128 | 805x460xH1460 |
| 101103 | 0.099 | 705x405xH1250 |

BUY IT AT LESSER PRICES



-Tightly connected between tube and tray



-With 4pcs TPR swivel castors ,dia. 100x27mm,2 with brakes
-With impact protection

TROLLEY W/O HANDLES



| code | CBM | mm |
|--------|--------------|-------|
| 101401 | 845x525xH800 | 0.062 |
| 101402 | 805x460xH755 | 0.052 |
| 101403 | 705x405xH690 | 0.041 |

BEVERAGE TROLLEY

- Material:SS201,0.8mm thickness
- Both tray with the mute damper
- Max loading capacity 100kg,50kg each shelf-Qty/ctn: 1pcs
- with side support bars
- Round stainless steel tube structure
- Sound deadening castors with bumpers and two brakes
- TPR wheels, soft texture and low noise,can fully stop at the 10-15degree slope
- Flat pack delivery



| code | CBM | mm |
|--------|-------|--------------|
| 101801 | 0.062 | 845x525xH945 |
| 101802 | 0.050 | 805x460xH905 |
| 101803 | 0.039 | 705x405xH805 |



**VISION
DISTRIBUTION**



CLEARING TROLLEY

- Material Stainless steel 201f 430 is available
- Tube thickness : 0.8mm
- Packing size:860x555x140mm (L),820x485x140mm(M) , 720x435x140mm(S)
- Flat pack delivery

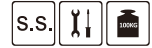

| code | CBM | mm |
|--------|-------|--------------|
| 101501 | 0.067 | 850x525xH945 |
| 101502 | 0.056 | 805x460xH905 |
| 101503 | 0.044 | 705x405xH805 |



CLEARING TROLLEY

- Material Stainless steel 201/ 430 is available
- Tube thickness : 0.8mm
- Fitted with 1pcs tray and 1pcs deep tray
- Max loading 100kg,50kg/shelf
- Qty/ctn:1pcs
- Packaging: each tray packs in 1 poly bag, each tube packs in poly bag
- Flat pack delivery



| code | CBM | mm |
|--------|-------|--------------|
| 101601 | 0.062 | 845x525xH940 |
| 101602 | 0.051 | 805x460xH900 |
| 101603 | 0.040 | 705x405xH810 |

VISION
DISTRIBUTION



CLEARING TROLLEY

- Material Stainless steel 201/ 430 is available
- Tube thickness : 0.8mm
- Fitted with 1pcs tray and 1pcs deep tray
- Max loading 100kg,50kg/shelf
- Qty/ctn:1pcs
- Packaging: each tray packs in 1 poly bag, each tube packs in poly bag
- Flat pack delivery



| code | CBM | mm |
|--------|-------|--------------|
| 101701 | 0.079 | 860x525xH940 |
| 101702 | 0.066 | 810x460xH900 |
| 101703 | 0.052 | 740x405xH810 |





VISION DISTRIBUTION

BUY IT AT LESSER PRICES



BUY IT AT LESSER PRICES

WATER TRANSFER SERVING TROLLEY

- Made of stainless steel
- Water transfer printing technology
- Max. load capacity: 50kg/per shelf
- Include 4 TPR castors, dia.100mm, 2 with brakes
- with plastic bumper to protect the corner
- Flatpack delivery



2-TIER WATER TRANSFER SERVING TROLLEY

| code | CBM | mm |
|--------|-------|--------------|
| 102301 | 0.079 | 845x525xH940 |
| 102302 | 0.064 | 805x460xH900 |
| 102303 | 0.052 | 705x405xH810 |



**VISION
DISTRIBUTION**



WATER TRANSFER SERVING TROLLEY

- Made of stainless steel 201 or 430
- Water transfer printing technology, customized color available
- Mute damper underneath the tray, less noise level
- Max. load capacity: 50kg/per shelf
- Include 4 TPR castors, dia.100x27(D)mm, 2 with brakes
- with plastic bumper to protect the corner
- Especially for the hotel, restaurant, buffet, parties
- Flatpack delivery

| code | CBM | mm |
|--------|-------|--------------|
| 102201 | 0.079 | 845x525xH940 |
| 102202 | 0.064 | 805x460xH900 |
| 102203 | 0.052 | 705x405xH810 |

3-TIER WATER TRANSFER SERVING TROLLEY (Single handle)

- Made of stainless steel 201 or 430
- Water transfer printing technology, customized color available
- Mute damper underneath the tray, less noise level
- Max. load capacity: 50kg/per shelf
- Fitted with 3 shelves, wooden color, single handle
- Include 4 TPR castors, dia. 100x27(D)mm, 2 with brakes
- with plastic bumper to protect the corner
- Especially for the hotel, restaurant, buffet, parties
- Flatpack delivery

| code | CBM | mm |
|--------|-------|--------------|
| 102101 | 0.079 | 845x525xH940 |
| 102102 | 0.064 | 805x460xH900 |
| 102103 | 0.052 | 705x405xH810 |



WATER TRANSFER SERVING TROLLEY

- Material stainless steel 201/ 430 are available
- Thickness:0.6/0.8 mm
- Qty/ctn:1pcs
- Flatpack delivery

**VISION
DISTRIBUTION**



| code | CBM | mm |
|--------|-------|--------------|
| 102010 | 0.079 | 845x525xH940 |
| 102011 | 0.064 | 805x460xH900 |
| 102012 | 0.052 | 705x405xH810 |



bamboo pattern color



wood grain pattern color



dark wood grain pattern color



-Nice quality TPR wheels



-Tightly connected between tube and trays



-Customized color

BUY IT AT LESSER PRICES



2-TIERS SQUARE TUBE TROLLEY

- Fitted with square tubes and 2 trays
- With f without the protective bumper is available

| code | CBM | mm |
|--------|-------|--------------|
| 100101 | 0.074 | 950x500xH940 |
| 100102 | 0.058 | 850x450xH895 |
| 100103 | 0.049 | 750x400xH840 |



4-TIERS SQUARE TUBE TROLLEY

- Material stainless steell 201/430 / 304 are available
- Qty/ctn:1pcs,flatpack delivery

| code | CBM | mm |
|--------|-------|---------------|
| 100401 | 0.110 | 950x500xH1255 |
| 100402 | 0.093 | 850x450xH1175 |
| 100403 | 0.075 | 750x400xH1140 |



-Mute damper, less noise level



-Swivel castors with brakes, tightconnection between tubes and trays



-Triangle board for supporting heavy loading

VISION DISTRIBUTION

3-TIERS SQUARE TUBE TROLLEY

- Material stainless 201 / 430 are available
- Designed to use the 25x25mm square tube
- Fitted with 4 castors while 2 with brakes
- Qty/ctn:1pcs
- Flatpack delivery

| code | CBM | mm |
|--------|-------|--------------|
| 100201 | 0.074 | 950x500xH940 |
| 100202 | 0.058 | 850x450xH895 |
| 100203 | 0.049 | 750x400xH840 |



BEVERAGE TROLLEY

- Square tube style
- Suitable for the hotel , kitchen , salons ,restaurants for transferring
- Fitted with the protective bars and to prevent the barrels / articles for dropping
- With plastic bumper to protect the corner for crashing
- Fitted with 4 swivel castors,2 with brakes
- Tight connection between the tubes and the trays
- Max loading capacity total 100kg,50kg l shelf
- Brushed polishing surface



| code | CBM | mm |
|--------|-------|--------------|
| 100501 | 0.077 | 950x500xH955 |
| 100502 | 0.061 | 850x450xH905 |
| 100503 | 0.045 | 750x400xH855 |



KETTLE TROLLEY

- Materiall stainless steel 201f 430 can be met
- No sharp burrs and smooth edge
- Fitted with 3 trays, one tray is with 8holes for packing the kettles
- Qty/ctn: 1pcs
- Flat pack delivery



| code | CBM | mm |
|--------|-------|--------------|
| 100601 | 0.077 | 950x500xH945 |
| 100602 | 0.061 | 850x450xH895 |
| 100603 | 0.045 | 750x400xH840 |



SEASONING TROLLEY

- Materiall stainless steel 201/ 430 are available
- Fitted with small size, suitable for the restaurant use
- Qty/ctn : 1pcs
- Flat pack delivery



| code | CBM | remark | mm |
|--------|-------|-------------------|--------------|
| 100801 | 0.024 | 3 tiers / shelves | 625x305xH785 |
| 100802 | 0.026 | 3 tiers / shelves | 480x305xH785 |
| 100901 | 0.030 | 4 tiers / shelves | 625x305xH785 |
| 100902 | 0.036 | 4 tiers / shelves | 480x305xH785 |





CLEARING TROLLEY

- Fitted with 2 square tubes and 2 deep trays
- Dimension of the tray:
L size--900x500x100mm,inside--850x450x95mm
M size--80x450x100mm,inside--800x400x95mm
S size--700x400x100mm,inside--700x350x95mm
- Material stainless steel 201 or 430 or 304 is available
- Qty/ctn:1 pcs
- Flat pack delivery



| code | CBM | mm |
|--------|-------|--------------|
| 100701 | 0.073 | 950x500xH945 |
| 100702 | 0.057 | 850x450xH905 |
| 100703 | 0.042 | 750x400xH855 |



VISION DISTRIBUTION

COLLECTING TROLLEY

- Fitted with 5 square tubes and 5 stainless steel boards
- 2 S/S board was welding on the square tube,the lowest shelf was a slope in order to prevent goods from sliding
- Material: stainless steel 201
- Thickness: 0.8mm
- With plastic bumper to protect the corner
- Include 4 TPR swivel castors, 2 with brakes
- Especially for packing the GN pan, fast food tray, plates and other goods



| code | CBM | mm |
|--------|-------|--------------|
| 100904 | 0.216 | 975x515xH800 |



CLEARING TROLLEY

- Fitted with 4 square tubes and 4 stainless steel boards
- Material: stainless steel 201
- Thickness: 0.8mm
- With plastic bumper to protect the corner
- Include 4 TPR swivel castors,2 with brakes
- Especially for packing the GN pan, fast food tray, plates and other goods



| code | CBM | mm |
|--------|-------|--------------|
| 100903 | 0.162 | 975x515xH800 |



Z-TYPE SQUARE TUBE CATERING TROLLEY

- Material stainless steel 201
- Knocked-down / stable structure
- Suitable for transferring 1pcs 2/1 GN,2PC5 1/1 GN,4pcs 2/4 GN

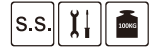

| code | qty/ctn | mm |
|--------|---------|--------------|
| 104502 | 1 | 705x555xH860 |

**VISION
DISTRIBUTION**



100906



100907

Z-TYPE SQUARE TUBE TROLLEY



| code | CBM | remark | mm |
|--------|-----|-------------------|--------------|
| 100906 | 1 | 2 tiers / shelves | 900x495xH955 |

Z-TYPE SQUARE TUBE TROLLEY



| code | CBM | remark | mm |
|--------|-----|-------------------|--------------|
| 100907 | 1 | 2 tiers / shelves | 900x495xH955 |



WIRES TROLLEY

- Material: Acero carbono+Chromium plating
- Max loading capacity: 50kg /shelf
- Fitted with 2 or 3 shelves
- Knocked-down structure, without using any screws
- with 4 TPR swivel castors,2 with brakes
- Flat pack delivery



| code | CBM | remark | mm |
|--------|-------|-------------------|---------------|
| 103001 | 0.127 | 2 tiers / shelves | 900x450xH1050 |
| 103002 | 0.163 | 3 tiers / shelves | 900x450xH1050 |



WIRE BASKET TROLLEY

- Product size: 508*610*H914mm
- Tube: ϕ 19, 1mm thickness
- Work table top: SS443, 0.8mm thickness
- Wire: ϕ 5.0/4.0/2.5mm \pm 0.2mm
- Wheels: 3" TPR



| code | mm |
|--------|--------------|
| 105602 | 508x610xH914 |



NEW



GN PAN TROLLEY

- Product size: 815x530xH940mm
- Suitable for 12 pieces 1/6 GN pan in one layer
- Tube: SS201, 25.4x25.4x0.8mm
- Board: SS201, 0.8mm thickness
- Packing size: 845x570xH110mm



| code | mm |
|--------|--------------|
| 105502 | 815x530xH940 |





TRANSPORT

RED WINE TROLLEY

- Material: stainless steel 201
- packing size: 450x820xH300mm
- Qty/ctn: 1pcs
- Suitable for 24pcs wines



| code | CBM | mm |
|--------|--------|--------------|
| 140403 | 0.1107 | 800x400xH800 |

PLATES COLLECTING TROLLEY

- Material : stainless steel 201 or 430 are available
- Packing size : 800x580xH140mm
- Qty/ctn: 1pcs
- Max loading 100kg



| code | CBM | mm |
|--------|-------|--------------|
| 141101 | 0.065 | 610x450xH900 |



141201



141301



141402



CUTLERY CART /HOLDER

| code | CBM | mm |
|--------|-------|---------------|
| 141201 | 0.049 | 536x510xH1055 |



CUTLERY CART /HOLDER

| code | CBM | mm |
|--------|-------|--------------|
| 141301 | 0.025 | 536x510xH330 |



CUTLERY CART /HOLDER

| code | CBM | mm |
|--------|-------|--------------|
| 141401 | 0.044 | 536x510xH580 |



- Fitted with the single round tube as the handle
- Easy to carry and touch comfortable
- Enough stable to support carrying in thousands of times



- Thick stainless steel board with holes
- Easy to clean and keep dry
- Strong tube and tray design for carrying/transferring Heavy duty works
- Screws to assembly and fasten the tray



- Table-top with the thick non-fumigation wooden board, smooth and flat surface
- Stable and strong designed for supporting heavy duty works on it.

COLLECTING TROLLEY

| code | CBM | mm |
|--------|-------|--------------|
| 100910 | 0.079 | 556x856xH860 |

VISION DISTRIBUTION



-Round smooth handle



-Front view

COLLECTING TROLLEY

- Material: Be made of stainless steel 201
- Fitted with 3 trays and 4 swivel swivel castors wheels
- Trays with profile edges
- TPR wheels, dia.100x27mm, 2 with brakes
- Max loading capacity is 150kg, 50kg each shelf
- Qty/ctn: 1pcs
- Flat pack delivery



| code | CBM | mm |
|--------|-------|--------------|
| 100905 | 0.065 | 800x450xH935 |

3 TIER WITH COLOURFUL TRAYS

- Material stainless 201/ 430 are available
- Designed to use the 25x25mm square tube
- Fitted with 4 castors while 2 with brakes
- Qty/ctn:1pcs
- Flatpack delivery



| code | CBM | mm |
|--------|-------|--------------|
| 100301 | 0.074 | 950x500xH945 |
| 100302 | 0.058 | 850x450xH895 |
| 100303 | 0.049 | 750x400xH840 |





VISION DISTRIBUTION

3 TIER WITH COLOURFUL TRAYS

- Material stainless 201/ 430 are available
- Designed to use the 25x25mm square tube
- Fitted with 4 castors while 2 with brakes
- Qty/ctn:1 pcs
- Flatpack delivery



| code | CBM | mm |
|--------|-------|--------------|
| 100301 | 0.074 | 950x500xH945 |
| 100302 | 0.058 | 850x450xH895 |
| 100303 | 0.049 | 750x400xH840 |



-Card slot for locating the GN pan



-Connected by screws between shelf and tube



-Knocked-down structure

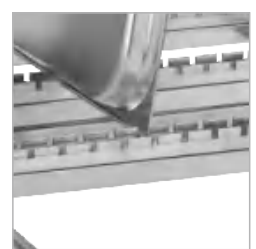

-Card slot for locating the GN

STORAGE RACK FOR GN PANS

- Material: Made of Stainless steel 201
- Fitted with 2 shelves, it consists of 2 single rack and connects by fastening the screws
- Suitable for packing the GN pan for storage, airing after washing
- Suitable for packing the GN 2/1 ,1/1,1/2,2/3
- Especially for the kitchen, hotel using
- Qty/ctn: 1pcs
- Flat pack delivery



| code | CBM | mm |
|--------|-------|---------------|
| 140505 | 0.064 | 600x550xH1155 |

BUY IT AT LESSER PRICES

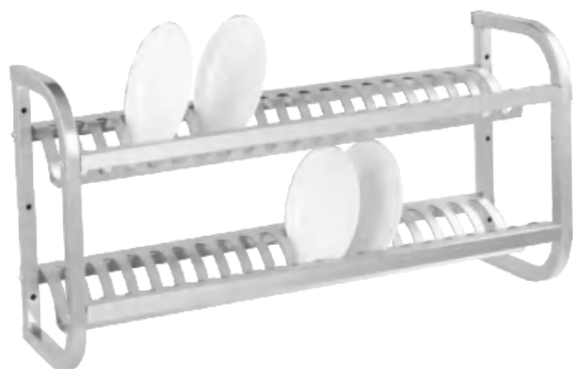

PLATE STORAGE

- Material: Made of Stainless steel 201
- Suitable for packing the GN pan for storage, airing after washing
- Suitable for packing the GN 2/1 ,1/1 1/2,2/3
- Especially for the kitchen, hotel using
- Qty/ctn: 1pcs
- Flat pack delivery



| code | CBM | mm |
|--------|-------|--------------|
| 140504 | 0.037 | 600x550xH600 |



PLATE STORAGE

- Material: made of stainless steel 201
- Suitable for 40 pcs plates
- Plates size in diameter 20cm-23cm is available
- Knocked-down structure
- Wall mounted plates rack
- Qty/ctn: 1pcs
- Packing size:1025x.280x155mm
- Flat pack delivery



| code | CBM | mm |
|--------|-------|---------------|
| 150501 | 0.040 | 1000x255xH500 |



NEW

PLATE STORAGE TROLLEY

- Material: made of stainless steel 201
- Suitable for 120 pcs plates
- Plates size in diameter 20cm-23cm is available
- Knocked-down structure
- Fitted with 6pcs plates racks
- Qty/ctn: 1pcs
- packing size:1230x685x200mm-Flat pack delivery



| code | CBM | mm |
|--------|-------|---------------|
| 150501 | 0.040 | 1000x255xH500 |





VISION
DISTRIBUTION

**INSULATED CONTAINER TOP LOADING STYLE
LAUNDRY TROLLEY**

- Fitted with 4 TPR wheels,2 with brakes
- With 4 tubes and supporting frame
- Nylon bag with button, yellow or blue color available
- Assembled or fully welding

S.S.

| code | CBM | mm |
|--------|-------|---------------|
| 130201 | 0.084 | 910 x560xH920 |



BUY IT AT LESSER PRICES



CONE LAUNDRY TROLLEY

- Fitted with 4 TPR wheels,2 with brakes
- With 4 tubes and supporting frame
- Nylon bag with button, yellow or blue color available
- Assembled or fully welding

S.S.

| code | CBM | mm |
|--------|-------|---------------|
| 130401 | 0.211 | 900 x650xH850 |



ROUND LAUNDRY TROLLEY

- Fitted with 4 TPR wheels,2 with brakes
- With 4 tubes and supporting frame
- Nylon bag with button, yellow or blue color available
- Assembled or fully welding

S.S.

| code | CBM | mm |
|--------|-------|--------------|
| 130301 | 0.063 | 600x600xH810 |
| 130302 | 0.054 | 500x500xH810 |



X-FRAME LAUNDRY TROLLEY

- Fitted with 4 TPR wheels,2 with brakes
- With 4 tubes and supporting frame
- Nylon bag with button, yellow or blue color available
- Assembled or fully welding

S.S.

| code | CBM | mm |
|--------|-------|---------------|
| 130101 | 0.156 | 770x550xH1020 |
| 130102 | 0.114 | 600x600xH1060 |

VISION DISTRIBUTION



BUY IT AT LESSER PRICES



- Material: Stainless steel 201
- Designed base on the 2-tier serving trolley
- Fitted with 4 TPR swivel castors,2 with brakes
- With the plastic bumper to protect the corner
- Shelf distance is 560mm
- Easy to transport the trash in a long distance and keep clean
- Suitable for the hotel ,outdoor, restaurant , lab, social occasions using
- Qty / ctn :1pcs

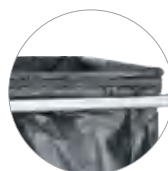

-Fasten the waste bag by the rubber ring



-Stainless steel handle



-Swivel castors with 2 brakes

CLASSIFYING GARBAGE CART



| code | CBM | mm |
|--------|-------|---------------|
| 140702 | 0.062 | 845 x525xH940 |

REFUSE-SACK CART



| code | CBM | mm |
|--------|-------|---------------|
| 140702 | 0.062 | 845 x525xH940 |



CLASSIFYING GARBAGE CART STATION



| code | CBM | mm |
|--------|-------|----------------|
| 140902 | 0.141 | 1000 x600xH800 |



The front

the back

-Material: stainless steel 201 or 304 available

TOW-IN-ONE GARBAGE CAN



| code | CBM | mm |
|--------|-------|------------|
| 180101 | 0.058 | Φ 250xH900 |



CLEARING TROLLEY

-Clearing Trolleys with 5 plastic bowls are effective in dishes collecting and classification after meals. There are 5 structure designs for your choice.



ROUND TUBE DISH COLLECTING TROLLEY

| code | CBM | mm |
|--------|-------|---------------|
| 120901 | 0.070 | 850x455xH935 |
| 102018 | 0.087 | 950x475xH920 |
| 102903 | 0.099 | 1065x560xH970 |



SQUARE TUBE DISH COLLECTING TROLLEY

| code | CBM | mm |
|--------|-------|--------------|
| 120602 | 0.059 | 810x440xH935 |



ROUND TUBE DISH COLLECTING TROLLEY

| code | CBM | mm |
|--------|-------|--------------|
| 120701 | 0.059 | 810x440xH935 |



SQUARE TUBE DISH COLLECTING TROLLEY

| code | CBM | mm |
|--------|-------|--------------|
| 120702 | 0.059 | 810x440xH935 |



ROUND TUBE DISH COLLECTING TROLLEY



| code | CBM | mm |
|--------|-------|--------------|
| 190301 | 0.163 | 500x500xH600 |
| 190302 | 0.230 | 600x600xH600 |





TRANSPORT CART FOR STOCK POT

S.S.

| code | CBM | mm |
|--------|-------|------------|
| 140301 | 0.034 | Φ 420xH130 |
| 140302 | 0.042 | Φ 470xH130 |
| 140303 | 0.052 | Φ 520xH130 |
| 140304 | 0.062 | Φ 570xH130 |
| 140305 | 0.073 | Φ 620xH130 |



TRANSPORT CART FOR STOCKPOT

S.S.

| code | CBM | mm |
|--------|-------|------------|
| 140201 | 0.034 | Φ 380xH400 |
| 140202 | 0.042 | Φ 480xH400 |
| 140203 | 0.052 | Φ 580xH400 |
| 140204 | 0.062 | Φ 680xH400 |



-Fasten the wasted bag by rubber ring



TRASH BIN BAG HOLDER

Trash Trolley range provide an easy way to dispose trash.

- Waste bag holder is extraordinarily flexible to collect garbage anywhere by portable-lightweight structure.
- Material: stainless steel 201
- Multi functional using in hotel ,kitchen ,restaurant , school , street, hospital, supermarket ,etc.
- Portable and easy to operate it or deal with the waste bag

S.S.

| code | CBM | mm |
|-------|-------|---------------|
| 14070 | 0.078 | 450 x600xH960 |



-Rubber pipe for anti-skid when food operating



-Tubes connected without gap





WORK TABLE

- Material: Stainless steel 201 / 304 / Galvanized is available
- S/S Board thickness: 0.8mm / 1.0mm / 1.2mm
- Reinforced bars for supporting the heavy duty
- S/S Tube thickness: 0.9mm,galvanized tube is 1.3mm
- Second floor is removable to everywhere
- Adjustable feet , stainless bullet feet or plastic bullet feet can be met
- Flat pack delivery



-Folded edge design, without the straight angle



-Classical straight design is available



ECONOMIC WORKING TABLE IN 600 WIDTH

| code | CBM | mm |
|--------|-------|---------------|
| 302203 | 0.091 | 750x600xH800 |
| 302206 | 0.107 | 1000x600xH800 |
| 302208 | 0.128 | 1200x600xH800 |
| 302210 | 0.149 | 1400x600xH800 |
| 302211 | 0.159 | 1500x600xH800 |
| 302212 | 0.169 | 1600x600xH800 |
| 302214 | 0.190 | 1800x600xH800 |
| 302216 | 0.211 | 2000x600xH800 |
| 302220 | 0.253 | 2400x600xH800 |

ECONOMIC WORKING TABLE IN 700 WIDTH

| code | CBM | mm |
|--------|-------|---------------|
| 302303 | 0.106 | 750x700xH800 |
| 302306 | 0.124 | 1000x700xH800 |
| 302308 | 0.148 | 1200x700xH800 |
| 302310 | 0.172 | 1400x700xH800 |
| 302311 | 0.184 | 1500x700xH800 |
| 302312 | 0.196 | 1600x700xH800 |
| 302314 | 0.220 | 1800x700xH800 |
| 302316 | 0.245 | 2000x700xH800 |
| 302320 | 0.291 | 2400x700xH800 |

ECONOMIC WORKING TABLE IN 750 WIDTH

| code | CBM | mm |
|--------|-------|---------------|
| 302403 | 0.113 | 750x750xH800 |
| 302406 | 0.133 | 1000x750xH800 |
| 302408 | 0.158 | 1200x750xH800 |
| 302410 | 0.184 | 1400x750xH800 |
| 302411 | 0.197 | 1500x750xH800 |
| 302412 | 0.210 | 1600x750xH800 |
| 302414 | 0.236 | 1800x750xH800 |
| 302416 | 0.261 | 2000x750xH800 |
| 302420 | 0.313 | 2400x750xH800 |

ECONOMIC WORKING TABLE IN 800 WIDTH

| code | CBM | mm |
|--------|-------|---------------|
| 302503 | 0.121 | 750x800xH800 |
| 302506 | 0.141 | 1000x800xH800 |
| 302508 | 0.168 | 1200x800xH800 |
| 302510 | 0.196 | 1400x800xH800 |
| 302511 | 0.210 | 1500x800xH800 |
| 302512 | 0.223 | 1600x800xH800 |
| 302514 | 0.251 | 1800x800xH800 |
| 302516 | 0.278 | 2000x800xH800 |
| 302520 | 0.333 | 2400x800xH800 |





ECONOMIC WORKING TABLE WITH BACK SPLASH

- Material: Stainless steel 201 / 304 / Galvanized is available
- S/S Board thickness: 0.8mm / 1.0mm / 1.2mm
- Reinforced bars for supporting the heavy duty
- S/S Tube thickness: 0.9mm,galvanized tube is 1.3mm
- Adjustable feet , stainless bullet feet or plastic bullet feet can be met
- Flat pack delivery



-Aluminum corner designed



-Pipe tube designed

ECONOMIC WORKING TABLE WITH BACK SPLASH IN 600 WIDTH

| code | CBM | mm |
|--------|-------|-------------------|
| 301803 | 0.116 | 750x600xH800+100 |
| 301806 | 0.136 | 1000x600xH800+100 |
| 301808 | 0.163 | 1200x600xH800+100 |
| 301810 | 0.189 | 1400x600xH800+100 |
| 301811 | 0.202 | 1500x600xH800+100 |
| 301812 | 0.216 | 1600x600xH800+100 |
| 301814 | 0.242 | 1800x600xH800+100 |
| 301816 | 0.269 | 2000x600xH800+100 |
| 301820 | 0.321 | 2400x600xH800+100 |

ECONOMIC WORKING TABLE WITH BACK SPLASH IN 700 WIDTH

| code | CBM | mm |
|--------|-------|-------------------|
| 301903 | 0.135 | 750x700xH800+100 |
| 301906 | 0.158 | 1000x700xH800+100 |
| 301908 | 0.189 | 1200x700xH800+100 |
| 301910 | 0.219 | 1400x700xH800+100 |
| 301911 | 0.235 | 1500x700xH800+100 |
| 301912 | 0.520 | 1600x700xH800+100 |
| 301914 | 0.281 | 1800x700xH800+100 |
| 301916 | 0.311 | 2000x700xH800+100 |
| 301920 | 0.373 | 2400x700xH800+100 |

ECONOMIC WORKING TABLE WITH BACK SPLASH IN 750 WIDTH

| code | CBM | mm |
|--------|-------|-------------------|
| 302003 | 0.144 | 750x750xH800+100 |
| 302006 | 0.169 | 1000x750xH800+100 |
| 302008 | 0.201 | 1200x750xH800+100 |
| 302010 | 0.234 | 1400x750xH800+100 |
| 302011 | 0.251 | 1500x750xH800+100 |
| 302012 | 0.267 | 1600x750xH800+100 |
| 302014 | 0.300 | 1800x750xH800+100 |
| 302016 | 0.333 | 2000x750xH800+100 |
| 302020 | 0.398 | 2400x750xH800+100 |

ECONOMIC WORKING TABLE WITH BACK SPLASH IN 800 WIDTH

| code | CBM | mm |
|--------|-------|-------------------|
| 301803 | 0.153 | 750x800xH800+100 |
| 301806 | 0.180 | 1000x800xH800+100 |
| 301808 | 0.214 | 1200x800xH800+100 |
| 301810 | 0.249 | 1400x800xH800+100 |
| 301811 | 0.267 | 1500x800xH800+100 |
| 301812 | 0.284 | 1600x800xH800+100 |
| 301814 | 0.319 | 1800x800xH800+100 |
| 301816 | 0.354 | 2000x800xH800+100 |
| 301820 | 0.424 | 2400x800xH800+100 |



ROUND TUBE WORK TABLE WITH BACKSPLASH

- Material: SS201
- Board thickness: 0.8mm
- Tube thickness: 0.9mm
- Adjustable feets
- Pcs/Ctn: 1



Screw assembling the lower tray



Reinforcing Rid



Foaming



IN 800 WIDTH

| code | CBM | mm |
|--------|-------|-------------------|
| 300402 | 0.173 | 1000x800xH910+100 |
| 300403 | 0.206 | 1200x800xH910+100 |
| 300404 | 0.240 | 1400x800xH910+100 |
| 300405 | 0.256 | 1500x800xH910+100 |
| 300406 | 0.306 | 1800x800xH910+100 |
| 300407 | 0.340 | 2000x800xH910+100 |



IN 800 WIDTH

| code | CBM | mm |
|--------|-------|---------------|
| 300302 | 0.086 | 1000x800xH910 |
| 300303 | 0.103 | 1200x800xH910 |
| 300304 | 0.120 | 1400x800xH910 |
| 300305 | 0.128 | 1500x800xH910 |
| 300306 | 0.153 | 1800x800xH910 |
| 300307 | 0.170 | 2000x800xH910 |

IN 700 WIDTH

| code | CBM | mm |
|--------|-------|-------------------|
| 300410 | 0.152 | 1000x700xH910+100 |
| 300411 | 0.182 | 1200x700xH910+100 |
| 300412 | 0.211 | 1400x700xH910+100 |
| 300413 | 0.226 | 1500x700xH910+100 |
| 300414 | 0.270 | 1800x700xH910+100 |
| 300415 | 0.299 | 2000x700xH910+100 |

IN 700 WIDTH

| code | CBM | mm |
|--------|-------|---------------|
| 300310 | 0.076 | 1000x700xH910 |
| 300311 | 0.091 | 1200x700xH910 |
| 300312 | 0.105 | 1400x700xH910 |
| 300313 | 0.113 | 1500x700xH910 |
| 300314 | 0.135 | 1800x700xH910 |
| 300315 | 0.150 | 2000x700xH910 |

IN 600 WIDTH

| code | CBM | mm |
|--------|-------|-------------------|
| 300418 | 0.131 | 1000x600xH910+100 |
| 300419 | 0.157 | 1200x600xH910+100 |
| 300420 | 0.182 | 1400x600xH910+100 |
| 300421 | 0.195 | 1500x600xH910+100 |
| 300422 | 0.233 | 1800x600xH910+100 |
| 300423 | 0.258 | 2000x600xH910+100 |

IN 600 WIDTH

| code | CBM | mm |
|--------|-------|---------------|
| 300318 | 0.066 | 1000x600xH910 |
| 300319 | 0.078 | 1200x600xH910 |
| 300320 | 0.091 | 1400x600xH910 |
| 300321 | 0.097 | 1500x600xH910 |
| 300322 | 0.117 | 1800x600xH910 |
| 300323 | 0.129 | 2000x600xH910 |

BUY IT AT LESSER PRICES



SQUARE TUBE FOLDING WORK TABLE W/O BACKSPLASH

- Material: SS201
- Board thickness: 0.8mm
- Tube thickness: 0.9mm
- Adjustable feets
- Pcs/Ctn: 1



IN 800 WIDTH



| code | CBM | mm |
|--------|-------|---------------|
| 300802 | 0.116 | 1000x800xH910 |
| 300803 | 0.138 | 1200x800xH910 |
| 300804 | 0.161 | 1400x800xH910 |
| 300805 | 0.172 | 1500x800xH910 |
| 300806 | 0.206 | 1800x800xH910 |
| 300807 | 0.228 | 2000x800xH910 |

IN 700 WIDTH

| code | CBM | mm |
|--------|-------|---------------|
| 300809 | 0.082 | 700x700xH910 |
| 300810 | 0.102 | 1000x700xH910 |
| 300811 | 0.122 | 1200x700xH910 |
| 300812 | 0.141 | 1400x700xH910 |
| 300813 | 0.151 | 1500x700xH910 |
| 300814 | 0.181 | 1800x700xH910 |
| 300815 | 0.201 | 2000x700xH910 |

IN 600 WIDTH

| code | CBM | mm |
|--------|-------|---------------|
| 300817 | 0.071 | 600x600xH910 |
| 300818 | 0.088 | 1000x600xH910 |
| 300819 | 0.105 | 1200x600xH910 |
| 300820 | 0.122 | 1400x600xH910 |
| 300821 | 0.131 | 1500x600xH910 |
| 300822 | 0.156 | 1800x600xH910 |
| 300823 | 0.173 | 2000x600xH910 |



SQUARE TUBE WORK TABLE W/O BACKSPLASH IN 600 WIDTH IN 700 WIDTH

| code | CBM | mm |
|--------|-------|---------------|
| 300716 | 0.099 | 800x600xH850 |
| 300717 | 0.115 | 1000x600xH850 |
| 300718 | 0.138 | 1200x600xH850 |
| 300719 | 0.160 | 1400x600xH850 |
| 300720 | 0.171 | 1500x600xH850 |
| 300721 | 0.197 | 1800x600xH850 |
| 300722 | 0.218 | 2000x600xH850 |

| code | CBM | mm |
|--------|-------|---------------|
| 300709 | 0.113 | 800x700xH850 |
| 300710 | 0.132 | 1000x700xH850 |
| 300711 | 0.158 | 1200x700xH850 |
| 300712 | 0.184 | 1400x700xH850 |
| 300713 | 0.196 | 1500x700xH850 |
| 300714 | 0.227 | 1800x700xH850 |
| 300715 | 0.252 | 2000x700xH850 |

IN 800 WIDTH

| code | CBM | mm |
|--------|-------|---------------|
| 300701 | 0.128 | 800x800xH850 |
| 300702 | 0.149 | 1000x800xH850 |
| 300703 | 0.178 | 1200x800xH850 |
| 300704 | 0.207 | 1400x800xH850 |
| 300705 | 0.222 | 1500x800xH850 |
| 300706 | 0.257 | 1800x800xH850 |
| 300707 | 0.285 | 2000x800xH850 |

SQUARE TUBE WORK TABLE WITH BACKSPLASH IN 600 WIDTH IN 700 WIDTH

| code | CBM | mm |
|--------|-------|-------------------|
| 300916 | 0.124 | 800x600xH850+100 |
| 300917 | 0.145 | 1000x600xH850+100 |
| 300918 | 0.173 | 1200x600xH850+100 |
| 300919 | 0.200 | 1400x600xH850+100 |
| 300920 | 0.214 | 1500x600xH850+100 |
| 300921 | 0.256 | 1800x600xH850+100 |
| 300922 | 0.284 | 2000x600xH850+100 |

| code | CBM | mm |
|--------|-------|-------------------|
| 300909 | 0.143 | 800x700xH850+100 |
| 300910 | 0.167 | 1000x700xH850+100 |
| 300911 | 0.200 | 1200x700xH850+100 |
| 300912 | 0.232 | 1400x700xH850+100 |
| 300913 | 0.248 | 1500x700xH850+100 |
| 300914 | 0.297 | 1800x700xH850+100 |
| 300915 | 0.329 | 2000x700xH850+100 |

IN 800 WIDTH

| code | CBM | mm |
|--------|-------|-------------------|
| 300901 | 0.163 | 800x800xH850+100 |
| 300902 | 0.190 | 1000x800xH850+100 |
| 300903 | 0.227 | 1200x800xH850+100 |
| 300904 | 0.264 | 1400x800xH850+100 |
| 300905 | 0.282 | 1500x800xH850+100 |
| 300906 | 0.337 | 1800x800xH850+100 |
| 300907 | 0.374 | 2000x800xH850+100 |



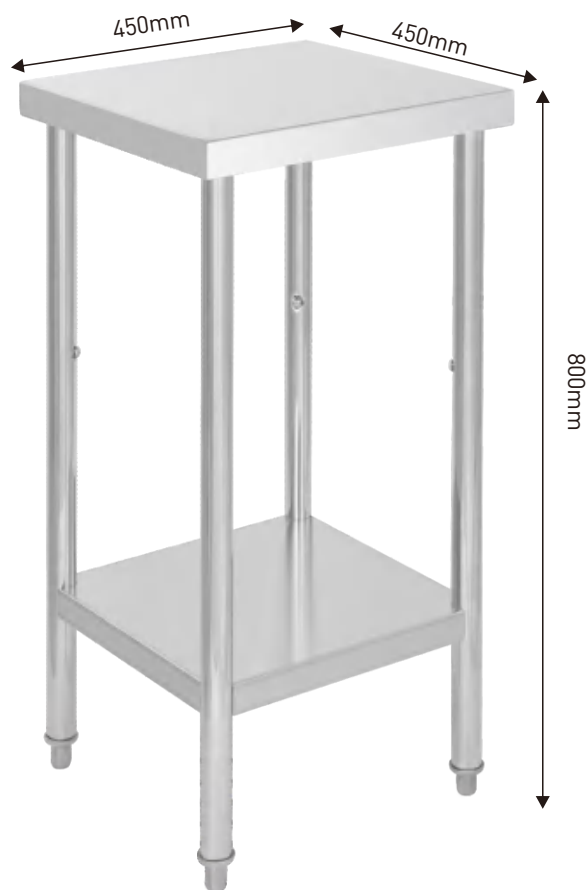

STRONGEST STYLE WORK TABLE

Other sizes and materials are available

- Three shelf is available
- Screws to assemble the shelves
- Stainless steel 201 / 304 can be met
- Brushed surface
- Flat pack delivery



STRONGEST STYLE ROUND TUBE WORK TABLE IN 450 WIDTH

| code | CBM | mm |
|--------|-------|---------------|
| 301601 | 0.036 | 300×450×H800 |
| 301602 | 0.040 | 350×450×H800 |
| 301603 | 0.049 | 400×450×H800 |
| 301604 | 0.049 | 450×450×H800 |
| 301605 | 0.049 | 500×450×H800 |
| 301606 | 0.049 | 600×450×H800 |
| 301607 | 0.049 | 700×450×H800 |
| 301608 | 0.049 | 750×450×H800 |
| 301609 | 0.049 | 800×450×H800 |
| 301610 | 0.052 | 900×450×H800 |
| 301611 | 0.058 | 1000×450×H800 |
| 301612 | 0.069 | 1200×450×H800 |
| 301613 | 0.086 | 1500×450×H800 |

IN 600 WIDTH

| code | CBM | mm |
|--------|-------|---------------|
| 301701 | 0.036 | 300×600×H800 |
| 301702 | 0.040 | 350×600×H800 |
| 301703 | 0.040 | 400×600×H800 |
| 301704 | 0.040 | 450×600×H800 |
| 301705 | 0.040 | 500×600×H800 |
| 301706 | 0.062 | 600×600×H800 |
| 301707 | 0.062 | 700×600×H800 |
| 301708 | 0.062 | 750×600×H800 |
| 301709 | 0.062 | 800×600×H800 |
| 301710 | 0.066 | 900×600×H800 |
| 301711 | 0.073 | 1000×600×H800 |
| 301712 | 0.088 | 1200×600×H800 |
| 301713 | 0.109 | 1500×600×H800 |
| 301714 | 0.130 | 1800×600×H800 |

