



**VISION**  
**DISTRIBUTION**  
BUY IT AT LESSER PRICES.

Tel : (514)492-1234  
Email : [info@distribution-vision.com](mailto:info@distribution-vision.com)  
Site Web : [www.distribution-vision.com](http://www.distribution-vision.com)

**BUY IT AT LESSER PRICES**

**INSULATED CONTAINER TOP LOADING STYLE  
LAUNDRY TROLLEY**

- Fitted with 4 TPR wheels,2 with brakes
- With 4 tubes and supporting frame
- Nylon bag with button, yellow or blue color available
- Assembled or fully welding

S.S.

code	CBM	mm
130201	0.084	910 x560xH920





**CONE LAUNDRY TROLLEY**

- Fitted with 4 TPR wheels,2 with brakes
- With 4 tubes and supporting frame
- Nylon bag with button, yellow or blue color available
- Assembled or fully welding

S.S.

code	CBM	mm
130401	0.211	900 x650xH850



**ROUND LAUNDRY TROLLEY**

- Fitted with 4 TPR wheels,2 with brakes
- With 4 tubes and supporting frame
- Nylon bag with button, yellow or blue color available
- Assembled or fully welding

S.S.

code	CBM	mm
130301	0.063	600x600xH810
130302	0.054	500x500xH810



**X-FRAME LAUNDRY TROLLEY**

- Fitted with 4 TPR wheels,2 with brakes
- With 4 tubes and supporting frame
- Nylon bag with button, yellow or blue color available
- Assembled or fully welding

S.S.

code	CBM	mm
130101	0.156	770x550xH1020
130102	0.114	600x600xH1060





- Material: Stainless steel 201
- Designed base on the 2-tier serving trolley
- Fitted with 4 TPR swivel castors,2 with brakes
- With the plastic bumper to protect the corner
- Shelf distance is 560mm
- Easy to transport the trash in a long distance and keep clean
- Suitable for the hotel ,outdoor, restaurant , lab, social occasions using
- Qty / ctn :1pcs

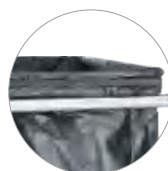

-Fasten the waste bag by the rubber ring



-Stainless steel handle



-Swivel castors with 2 brakes

**CLASSIFYING GARBAGE CART**



code	CBM	mm
140702	0.062	845 x525xH940

**REFUSE-SACK CART**



code	CBM	mm
140702	0.062	845 x525xH940



The front

the back

-Material: stainless steel 201 or 304 available

**CLASSIFYING GARBAGE CART STATION**



code	CBM	mm
140902	0.141	1000 x600xH800

**TOW-IN-ONE GARBAGE CAN**



code	CBM	mm
180101	0.058	Φ 250xH900



**CLEARING TROLLEY**

-Clearing Trolleys with 5 plastic bowls are effective in dishes collecting and classification after meals. There are 5 structure designs for your choice.



**ROUND TUBE DISH COLLECTING TROLLEY**

code	CBM	mm
120901	0.070	850x455xH935
102018	0.087	950x475xH920
102903	0.099	1065x560xH970



**SQUARE TUBE DISH COLLECTING TROLLEY**

code	CBM	mm
120602	0.059	810x440xH935



**ROUND TUBE DISH COLLECTING TROLLEY**

code	CBM	mm
120701	0.059	810x440xH935



**SQUARE TUBE DISH COLLECTING TROLLEY**

code	CBM	mm
120702	0.059	810x440xH935



**ROUND TUBE DISH COLLECTING TROLLEY**



code	CBM	mm
190301	0.163	500x500xH600
190302	0.230	600x600xH600





**TRANSPORT CART FOR STOCK POT**

S.S.

code	CBM	mm
140301	0.034	Φ 420xH130
140302	0.042	Φ 470xH130
140303	0.052	Φ 520xH130
140304	0.062	Φ 570xH130
140305	0.073	Φ 620xH130



**TRANSPORT CART FOR STOCKPOT**

S.S.

code	CBM	mm
140201	0.034	Φ 380xH400
140202	0.042	Φ 480xH400
140203	0.052	Φ 580xH400
140204	0.062	Φ 680xH400

DISH WASHES AND HYGIENE



-Fasten the wasted bag by rubber ring



**TRASH BIN BAG HOLDER**

Trash Trolley range provide an easy way to dispose trash.

- Waste bag holder is extraordinarily flexible to collect garbage anywhere by portable-lightweight structure.
- Material: stainless steel 201
- Multi functional using in hotel ,kitchen ,restaurant , school , street, hospital, supermarket ,etc.
- Portable and easy to operate it or deal with the waste bag



-Rubber pipe for anti-skid when food operating



-Tubes connected without gap

S.S.

code	CBM	mm
14070	0.078	450 x600xH960



**WORK TABLE**

- Material: Stainless steel 201 / 304 / Galvanized is available
- S/S Board thickness: 0.8mm / 1.0mm / 1.2mm
- Reinforced bars for supporting the heavy duty
- S/S Tube thickness: 0.9mm,galvanized tube is 1.3mm
- Second floor is removable to everywhere
- Adjustable feet , stainless bullet feet or plastic bullet feet can be met
- Flat pack delivery



-Folded edge design, without the straight angle



-Classical straight design is available



**ECONOMIC WORKING TABLE IN 600 WIDTH**

code	CBM	mm
302203	0.091	750x600xH800
302206	0.107	1000x600xH800
302208	0.128	1200x600xH800
302210	0.149	1400x600xH800
302211	0.159	1500x600xH800
302212	0.169	1600x600xH800
302214	0.190	1800x600xH800
302216	0.211	2000x600xH800
302220	0.253	2400x600xH800

**ECONOMIC WORKING TABLE IN 700 WIDTH**

code	CBM	mm
302303	0.106	750x700xH800
302306	0.124	1000x700xH800
302308	0.148	1200x700xH800
302310	0.172	1400x700xH800
302311	0.184	1500x700xH800
302312	0.196	1600x700xH800
302314	0.220	1800x700xH800
302316	0.245	2000x700xH800
302320	0.291	2400x700xH800

**ECONOMIC WORKING TABLE IN 750 WIDTH**

code	CBM	mm
302403	0.113	750x750xH800
302406	0.133	1000x750xH800
302408	0.158	1200x750xH800
302410	0.184	1400x750xH800
302411	0.197	1500x750xH800
302412	0.210	1600x750xH800
302414	0.236	1800x750xH800
302416	0.261	2000x750xH800
302420	0.313	2400x750xH800

**ECONOMIC WORKING TABLE IN 800 WIDTH**

code	CBM	mm
302503	0.121	750x800xH800
302506	0.141	1000x800xH800
302508	0.168	1200x800xH800
302510	0.196	1400x800xH800
302511	0.210	1500x800xH800
302512	0.223	1600x800xH800
302514	0.251	1800x800xH800
302516	0.278	2000x800xH800
302520	0.333	2400x800xH800





**ECONOMIC WORKING TABLE WITH BACK SPLASH**

- Material: Stainless steel 201 / 304 / Galvanized is available
- S/S Board thickness: 0.8mm / 1.0mm / 1.2mm
- Reinforced bars for supporting the heavy duty
- S/S Tube thickness: 0.9mm,galvanized tube is 1.3mm
- Adjustable feet , stainless bullet feet or plastic bullet feet can be met
- Flat pack delivery



-Aluminum corner designed



-Pipe tube designed

**ECONOMIC WORKING TABLE WITH BACK SPLASH IN 600 WIDTH**

code	CBM	mm
301803	0.116	750x600xH800+100
301806	0.136	1000x600xH800+100
301808	0.163	1200x600xH800+100
301810	0.189	1400x600xH800+100
301811	0.202	1500x600xH800+100
301812	0.216	1600x600xH800+100
301814	0.242	1800x600xH800+100
301816	0.269	2000x600xH800+100
301820	0.321	2400x600xH800+100

**ECONOMIC WORKING TABLE WITH BACK SPLASH IN 700 WIDTH**

code	CBM	mm
301903	0.135	750x700xH800+100
301906	0.158	1000x700xH800+100
301908	0.189	1200x700xH800+100
301910	0.219	1400x700xH800+100
301911	0.235	1500x700xH800+100
301912	0.520	1600x700xH800+100
301914	0.281	1800x700xH800+100
301916	0.311	2000x700xH800+100
301920	0.373	2400x700xH800+100

**ECONOMIC WORKING TABLE WITH BACK SPLASH IN 750 WIDTH**

code	CBM	mm
302003	0.144	750x750xH800+100
302006	0.169	1000x750xH800+100
302008	0.201	1200x750xH800+100
302010	0.234	1400x750xH800+100
302011	0.251	1500x750xH800+100
302012	0.267	1600x750xH800+100
302014	0.300	1800x750xH800+100
302016	0.333	2000x750xH800+100
302020	0.398	2400x750xH800+100

**ECONOMIC WORKING TABLE WITH BACK SPLASH IN 800 WIDTH**

code	CBM	mm
301803	0.153	750x800xH800+100
301806	0.180	1000x800xH800+100
301808	0.214	1200x800xH800+100
301810	0.249	1400x800xH800+100
301811	0.267	1500x800xH800+100
301812	0.284	1600x800xH800+100
301814	0.319	1800x800xH800+100
301816	0.354	2000x800xH800+100
301820	0.424	2400x800xH800+100



## ROUND TUBE WORK TABLE WITH BACKSPLASH

- Material: SS201
- Board thickness: 0.8mm
- Tube thickness: 0.9mm
- Adjustable feets
- Pcs/Ctn: 1



Screw assembling the lower tray



Reinforcing Rid



Foaming



### IN 800 WIDTH

code	CBM	mm
300402	0.173	1000x800xH910+100
300403	0.206	1200x800xH910+100
300404	0.240	1400x800xH910+100
300405	0.256	1500x800xH910+100
300406	0.306	1800x800xH910+100
300407	0.340	2000x800xH910+100



### IN 800 WIDTH

code	CBM	mm
300302	0.086	1000x800xH910
300303	0.103	1200x800xH910
300304	0.120	1400x800xH910
300305	0.128	1500x800xH910
300306	0.153	1800x800xH910
300307	0.170	2000x800xH910

### IN 700 WIDTH

code	CBM	mm
300410	0.152	1000x700xH910+100
300411	0.182	1200x700xH910+100
300412	0.211	1400x700xH910+100
300413	0.226	1500x700xH910+100
300414	0.270	1800x700xH910+100
300415	0.299	2000x700xH910+100

### IN 700 WIDTH

code	CBM	mm
300310	0.076	1000x700xH910
300311	0.091	1200x700xH910
300312	0.105	1400x700xH910
300313	0.113	1500x700xH910
300314	0.135	1800x700xH910
300315	0.150	2000x700xH910

### IN 600 WIDTH

code	CBM	mm
300418	0.131	1000x600xH910+100
300419	0.157	1200x600xH910+100
300420	0.182	1400x600xH910+100
300421	0.195	1500x600xH910+100
300422	0.233	1800x600xH910+100
300423	0.258	2000x600xH910+100

### IN 600 WIDTH

code	CBM	mm
300318	0.066	1000x600xH910
300319	0.078	1200x600xH910
300320	0.091	1400x600xH910
300321	0.097	1500x600xH910
300322	0.117	1800x600xH910
300323	0.129	2000x600xH910





**SQUARE TUBE FOLDING WORK TABLE W/O BACKSPLASH**

- Material: SS201
- Board thickness: 0.8mm
- Tube thickness: 0.9mm
- Adjustable feet
- Pcs/Ctn: 1



**IN 800 WIDTH**



code	CBM	mm
300802	0.116	1000x800xH910
300803	0.138	1200x800xH910
300804	0.161	1400x800xH910
300805	0.172	1500x800xH910
300806	0.206	1800x800xH910
300807	0.228	2000x800xH910

**IN 700 WIDTH**

code	CBM	mm
300809	0.082	700x700xH910
300810	0.102	1000x700xH910
300811	0.122	1200x700xH910
300812	0.141	1400x700xH910
300813	0.151	1500x700xH910
300814	0.181	1800x700xH910
300815	0.201	2000x700xH910

**IN 600 WIDTH**

code	CBM	mm
300817	0.071	600x600xH910
300818	0.088	1000x600xH910
300819	0.105	1200x600xH910
300820	0.122	1400x600xH910
300821	0.131	1500x600xH910
300822	0.156	1800x600xH910
300823	0.173	2000x600xH910



**SQUARE TUBE WORK TABLE W/O BACKSPLASH**

**IN 600 WIDTH**

code	CBM	mm
300716	0.099	800x600xH850
300717	0.115	1000x600xH850
300718	0.138	1200x600xH850
300719	0.160	1400x600xH850
300720	0.171	1500x600xH850
300721	0.197	1800x600xH850
300722	0.218	2000x600xH850

**IN 700 WIDTH**

code	CBM	mm
300709	0.113	800x700xH850
300710	0.132	1000x700xH850
300711	0.158	1200x700xH850
300712	0.184	1400x700xH850
300713	0.196	1500x700xH850
300714	0.227	1800x700xH850
300715	0.252	2000x700xH850

**IN 800 WIDTH**

code	CBM	mm
300701	0.128	800x800xH850
300702	0.149	1000x800xH850
300703	0.178	1200x800xH850
300704	0.207	1400x800xH850
300705	0.222	1500x800xH850
300706	0.257	1800x800xH850
300707	0.285	2000x800xH850

**SQUARE TUBE WORK TABLE WITH BACKSPLASH**

**IN 600 WIDTH**

code	CBM	mm
300916	0.124	800x600xH850+100
300917	0.145	1000x600xH850+100
300918	0.173	1200x600xH850+100
300919	0.200	1400x600xH850+100
300920	0.214	1500x600xH850+100
300921	0.256	1800x600xH850+100
300922	0.284	2000x600xH850+100

**IN 700 WIDTH**

code	CBM	mm
300909	0.143	800x700xH850+100
300910	0.167	1000x700xH850+100
300911	0.200	1200x700xH850+100
300912	0.232	1400x700xH850+100
300913	0.248	1500x700xH850+100
300914	0.297	1800x700xH850+100
300915	0.329	2000x700xH850+100

**IN 800 WIDTH**

code	CBM	mm
300901	0.163	800x800xH850+100
300902	0.190	1000x800xH850+100
300903	0.227	1200x800xH850+100
300904	0.264	1400x800xH850+100
300905	0.282	1500x800xH850+100
300906	0.337	1800x800xH850+100
300907	0.374	2000x800xH850+100





### STRONGEST STYLE WORK TABLE

Other sizes and materials are available

- Three shelf is available
- Screws to assemble the shelves
- Stainless steel 201 / 304 can be met
- Brushed surface
- Flat pack delivery



### STRONGEST STYLE ROUND TUBE WORK TABLE IN 450 WIDTH

code	CBM	mm
301601	0.036	300×450×H800
301602	0.040	350×450×H800
301603	0.049	400×450×H800
301604	0.049	450×450×H800
301605	0.049	500×450×H800
301606	0.049	600×450×H800
301607	0.049	700×450×H800
301608	0.049	750×450×H800
301609	0.049	800×450×H800
301610	0.052	900×450×H800
301611	0.058	1000×450×H800
301612	0.069	1200×450×H800
301613	0.086	1500×450×H800

### IN 600 WIDTH

code	CBM	mm
301701	0.036	300×600×H800
301702	0.040	350×600×H800
301703	0.040	400×600×H800
301704	0.040	450×600×H800
301705	0.040	500×600×H800
301706	0.062	600×600×H800
301707	0.062	700×600×H800
301708	0.062	750×600×H800
301709	0.062	800×600×H800
301710	0.066	900×600×H800
301711	0.073	1000×600×H800
301712	0.088	1200×600×H800
301713	0.109	1500×600×H800
301714	0.130	1800×600×H800





-Round edge design



-Removable shelf design



-Rubber feet



-Fasten without screw



**WIRE BASE WORK TABLE-2 TIERS**

Material: SS201+Chrome Wire



code	CBM	mm
302601	0.096	1000x700xH900
302602	0.124	1300x700xH900



**WIRE BASE WORK TABLE-3 TIERS**

Material: SS201+Chrome Wire



code	CBM	mm
302701	0.127	1000x700xH900
302702	0.163	1300x700xH900

**ROUND TUBE WORK TABLE WITH EXTRA SHELF**



code	CBM	mm
300901	0.136	800x800xH910+1320
300902	0.169	1000x800xH910+1320
300903	0.201	1200x800xH910+1320
300904	0.234	1400x800xH910+1320
300905	0.250	1500x800xH910+1320
300906	0.299	1800x800xH910+1320
300907	0.331	2000x800xH910+1320
300908	0.364	2200x800xH910+1320

code	CBM	mm
300909	0.120	800x700xH910+1320
300910	0.148	1000x700xH910+1320
300911	0.177	1200x700xH910+1320
300912	0.206	1400x700xH910+1320
300913	0.220	1500x700xH910+1320
300914	0.263	1800x700xH910+1320
300915	0.292	2000x700xH910+1320
300916	0.320	2200x700xH910+1320

code	CBM	mm
300917	0.119	800x600xH910+1320
300918	0.148	1000x600xH910+1320
300919	0.176	1200x600xH910+1320
300920	0.205	1400x600xH910+1320
300921	0.219	1500x600xH910+1320
300922	0.262	1800x600xH910+1320
300923	0.291	2000x600xH910+1320
300924	0.319	2200x600xH910+1320



BUY IT AT LESSER PRICES

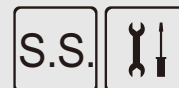

320001



320002



320003

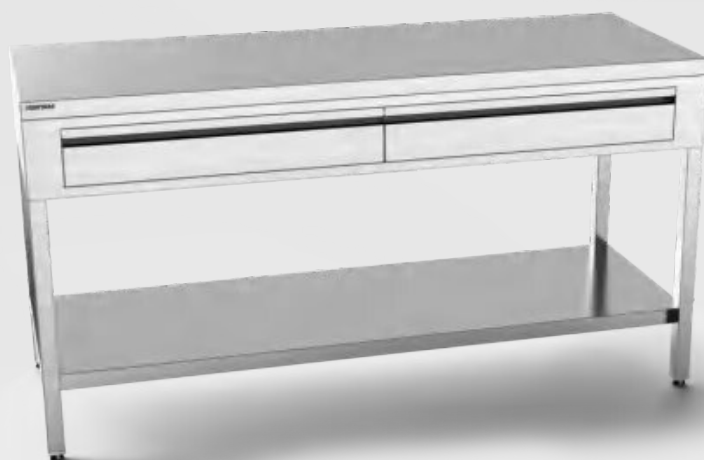

320004

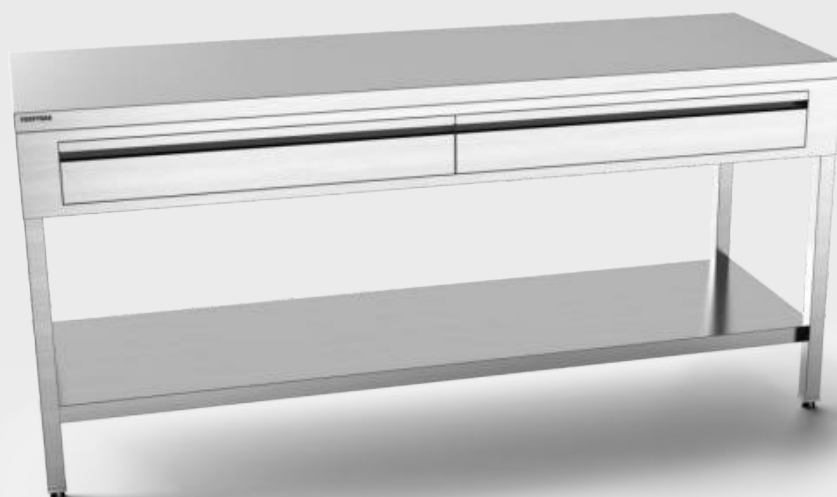

320005

### WORKBENCH(WITH DRAWER)

code	mm
320001	1000x600xH850
320002	1200x600xH850
320003	1400x600xH850
320004	1600x600xH850
320005	1800x600xH850



BUY IT AT LESSER PRICES

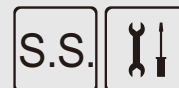

320101



320102



320103



320104

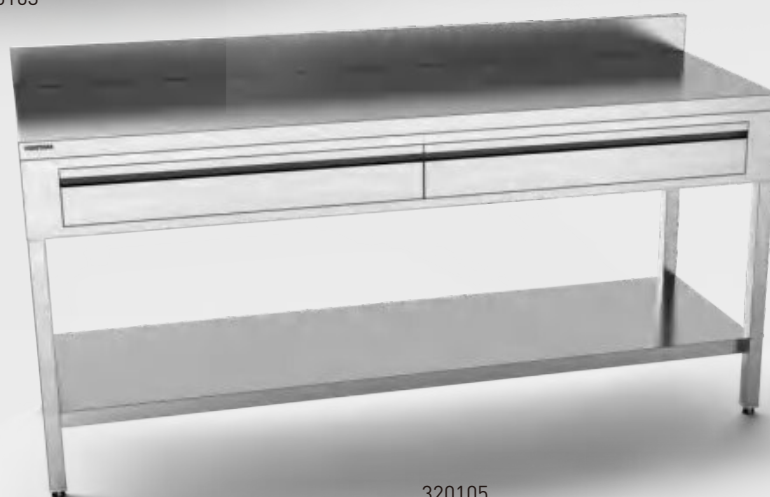

320105

**WORKBENCH(WITH DRAWER&BACKREST)**

code	mm
320101	1000x600xH850+100
320102	1200x600xH850+100
320103	1400x600xH850+100
320104	1600x600xH850+100
320105	1800x600xH850+100



BUY IT AT LESSER PRICES

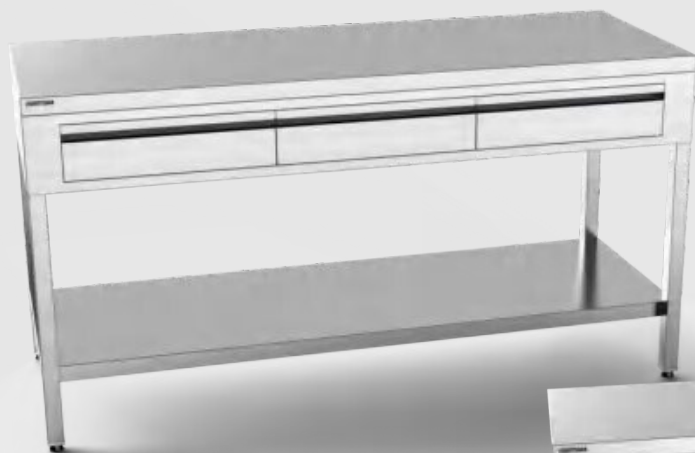
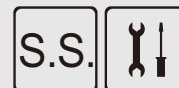

320201

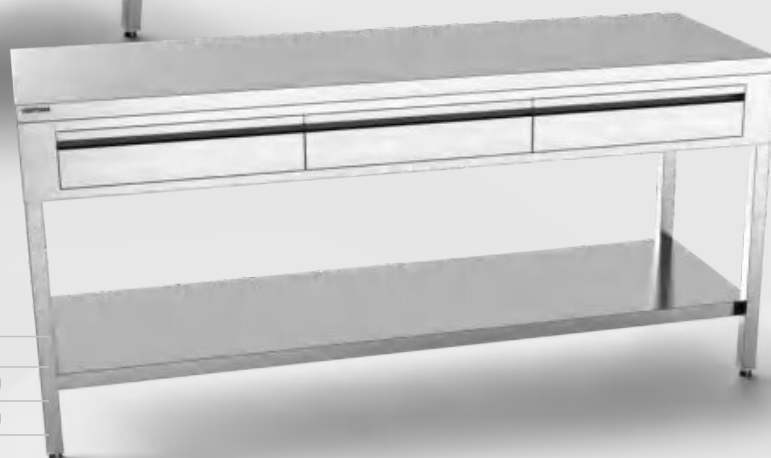

320202

**WORKBENCH(WITH DRAWER)**

code	mm
320201	1600x600xH850
320202	1800x600xH850

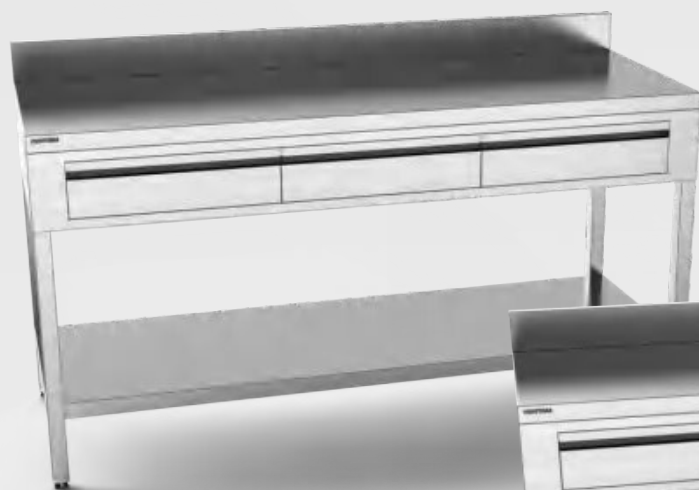

320301



320302

**WORKBENCH(WITH DRAWER&BACKREST)**

code	mm
320301	1600x600xH850+100
320302	1800x600xH850+100



S.S.



**WORKBENCH(WITH DRAWER&BACKREST)**

code	mm
320501	600x600xH850
320502	1200x600xH850
320503	1500x600xH850
320504	2000x600xH850

320501



320502



320503



320504

FURNITURE

**WORKBENCH(WITH DRAWER&BACKREST)**

code	mm
320601	600x600xH850+100
320602	1200x600xH850+100
320603	1500x600xH850+100
320604	2000x600xH850+100

320601



320602



320604



320603

**WARM CABINET**

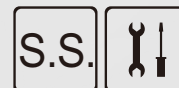

code	mm
320701	1000x600xH850
320702	1400x600xH850
320703	2000x600xH850



320701



320702



320703

**WARM CABINET(WITH DRAWER&BACKREST)**

code	mm
320801	1000x600xH850+100
320802	1400x600xH850+100
320803	2000x600xH850+100



320801



320802



320803





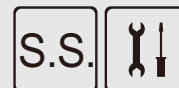

320901

**WALL CABINET**

code	mm
320901	600x400xH600
320902	1200x400xH600
320903	1600x400xH600



320902

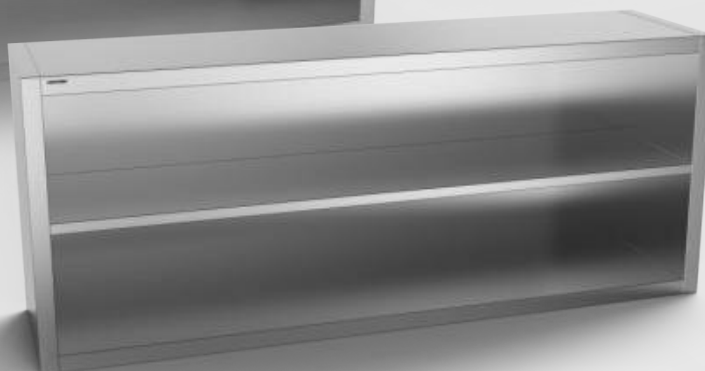

320903



321001



321002



321003



321004

**WALL CABINET(**

code	mm
321001	600x400xH600
321002	1200x400xH600
321003	1600x400xH600
321004	2000x400xH600



**SINK SERIES**

code	mm
321101	1200x600xH850+100



**SINK SERIES**

code	mm
321201	1200x600xH850+100



**SINK SERIES**

code	mm
321301	1200x600xH850+100



**SINK SERIES**

code	mm
321401	1400x700xH850+100



**SINK SERIES**

code	mm
321501	1200x600xH850



**SINK SERIES**

code	mm
321601	1400x700xH850



321701



321702

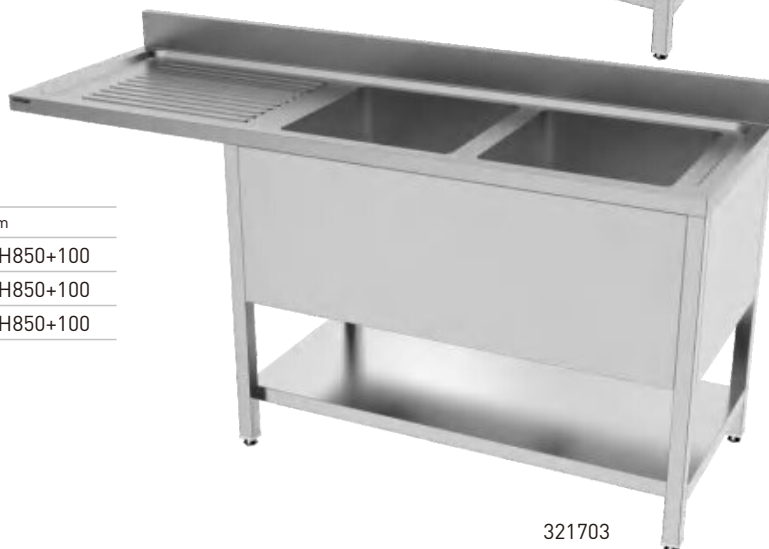

321703

**SINK SERIES**

code	mm
321701	1400x600xH850+100
321702	1600x600xH850+100
321703	1800x600xH850+100

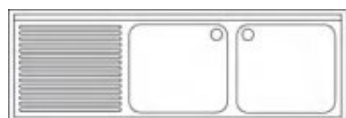

321801



321802



321803

**SINK SERIES**

code	mm
321801	1400x600xH850+100
321802	1600x600xH850+100
321803	1800x600xH850+100

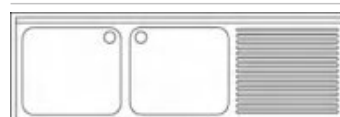



**SINK SERIES**

code	mm
321901	1400x600xH850+100
321902	1600x600xH850+100
321903	1800x600xH850+100

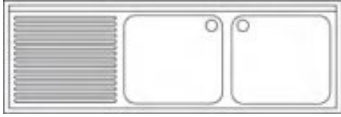

321903



321902



321901



322003

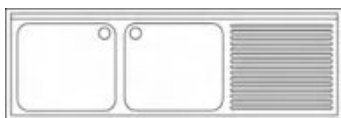

322002



322001

**SINK SERIES**

code	mm
322001	1400x600xH850+100
322002	1600x600xH850+100
322003	1800x600xH850+100





322301



322302



322303

**SINK SERIES**

code	mm
322301	600x700xH950
322302	700x700xH950
322303	800x700xH950

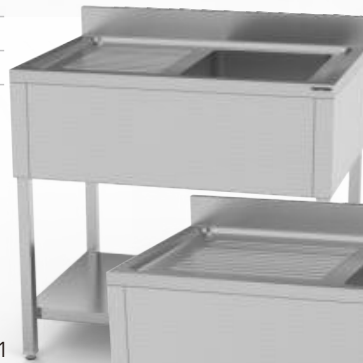

322401



322502



322403

**SINK SERIES**

code	mm
322401	1000x700xH950
322402	1200x700xH950
322403	1400x700xH950

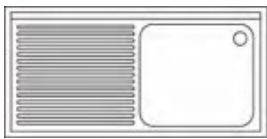

322501

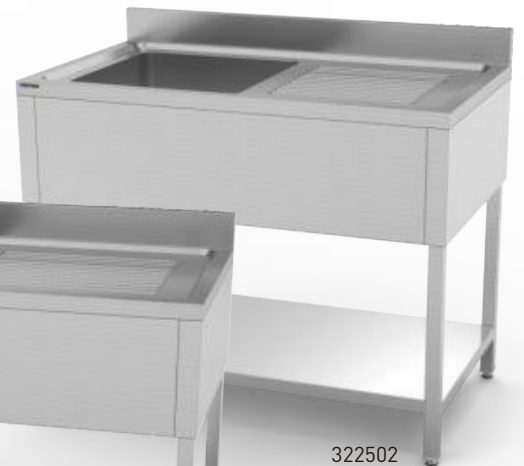

322502

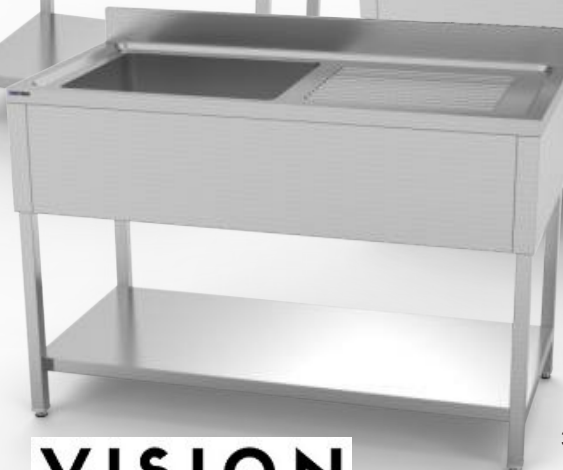

322503

**SINK SERIES**

code	mm
322501	1000x700xH950
322502	1200x700xH950
322503	1400x700xH950



BUY IT AT LESSER PRICES



**SINK SERIES**

code	mm
322601	1400x600xH950
322602	1600x600xH950
322603	1800x600xH950

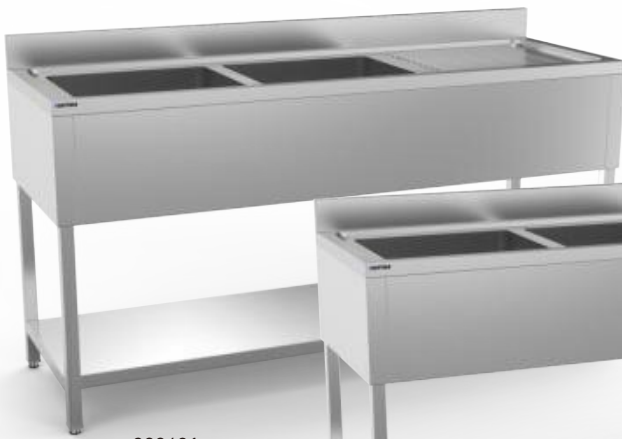
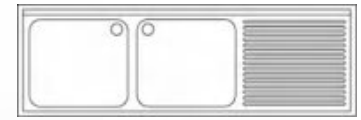

322601



322602



322603

**SINK SERIES**

code	mm
322701	1400x600xH950
322702	1600x600xH950
322703	1800x600xH950

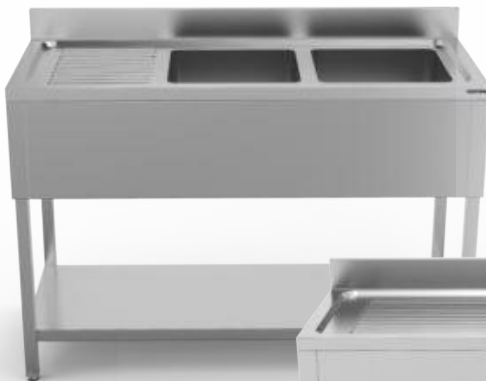
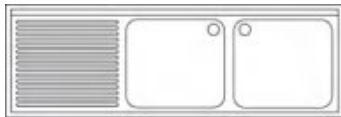

322701



322702



322703



322801

**SINK SERIES**

code	mm
322801	2000x600xH950





**A PREPARATION TABLE USED FOR SCRAPPING, SORTING, AND PREWASHING OF DISHWARE.**

- Clearing table with scrap block and ring.
- Top shelf for empty rack storage.
- Sloped shelf for racks in use.
- Constructed entirely in 18/10 AISI 304 heavy gauge 12/10 stainless steel.
- Available on wheels if required



code	mm
305001	1800x780xH880



**PRERINSE OF DISHWARE.**

- Flexible spray hose.
- Cold/hot water faucet. 1/2"
- Gas fitting (mm 21).
- Can be mounted on all prewash tables.



code	mm
305001	800x300xH10



**A PREPARATION TABLE USED FOR SCRAPPING, SORTING, AND PREWASHING OF DISHWARE.**

- Sink complete with drain.
- With prerinse hose attachment.
- Back splash, and scrap block.
- Lower rack shelf.
- Can be mounted either left to right or vice versa. (Clarify when ordering)
- Constructed entirely in 18/10 AISI 304 12/10 heavy gauge stainless steel.



code	mm
305001	1800x780xH880



**A PREPARATION TABLE FOR THE SOAKING AND PREWASHING OF DISHWARE.**

- Sink complete with drain.
- With prerinse hose attachment.
- Back splash, lower rack shelf.
- Can be mounted either left to right or vice versa. (Clarify when ordering).
- Available in two lengths: 1.200, 1.800 mm.
- Constructed entirely in 18/10 AISI 304 heavy gauge 12/10 stainless steel.



code	mm
305001	1200x780xH880
305001	1800x780xH880



**A COMPACT MODEL OF THE SORTING TABLE WITH OVERSHELF.**

- Clearing table with scrap block and ring.
- Top shelf for empty rack storage.
- Sloped shelf for 'racks in use.
- Constructed entirely in 18/10 AISI 304 heavy gauge 12/10 stainless steel.
- Available on wheels if required



code	mm
305001	1700x1150xH880
305001	2200x1150xH880
305001	2700x1150xH880



**A COMPACT MODEL OF THE SORTING TABLE WITH OVERSHELF.**

- Clearing table with scrap block and ring.
- Top shelf for empty rack storage.
- Sloped shelf for racks in use.
- Constructed entirely in 18/10 AISI 304 heavy gauge 12/10 stainless steel.
- Available on wheels if required



code	mm
305001	1070x630xH1830



**A COMPACT MODEL OF THE SORTING TABLE WITH OVERSHELF.**

- Top two sided rack over shelf.
- Table top with scrap block for easy scrapping.
- Possibility of joining a table at either side of the sorting table.
- Possibility of connecting two machines at both sides for peak periods.
- Available in three lengths 1.700, 2.200, 2.700 mm.
- Constructed in 18/10 AISI 304 heavy gauge 12/10 S/S.
- Side borders 30 mm high.



code	mm
305001	2700x1150xH1470
305001	2200x1150xH1470
305001	2700x1150xH1470



**AN INCLINED SHELF WITH FLOOR MOUNTS FOR THE PLACEMENT OF GLASS AND CUP RACKS.**

- Fixed to floor.
- Inclined shelf with water drain.
- Available in three lengths 1.070, 1.570 and 2.070 mm.
- Constructed entirely in heavy gauge 18/10 AISI 304 S/S.
- Stainless steel 40x40 S/S frame.



code	mm
305001	1070x525xH1880
305001	1570x525xH1880
305001	1070x525xH1880







**ROUND TUBE KITCHEN SINK(SINGLE BOWL)**

code	CBM	Dimension(mm)	Bowl size
310101	0.165	600x600xH850+100	400x400x250
310102	0.219	700x700xH850+100	500x500x250
310103	0.248	700x700xH850+100	500x500x300



**ROUND TUBE KITCHEN SINK(DOUBLE BOWL)**

code	CBM	Dimension(mm)	Bowl size
310201	0.266	1000x600xH850+100	400x400x250
310202	0.366	1200x700xH850+100	500x500x250
310203	0.413	1200x700xH850+100	500x500x300



**ROUND TUBE KITCHEN SINK(THREE BOWLS)**

code	CBM	Dimension(mm)	Bowl size
310401	0.393	1500x600xH850+100	400x400x250
310402	0.541	1800x700xH850+100	500x500x250
310403	0.611	1800x700xH850+100	500x500x300

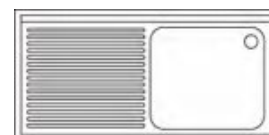

**ROUND TUBE KITCHEN SINK(SINGLE BOWL)**

code	CBM	Dimension(mm)	Bowl size
310304	0.266	1000x600xH850+100	400x400x250
310305	0.366	1200x700xH850+100	500x500x250
310306	0.413	1200x700xH850+100	500x500x300



**HAND-WASHING BASIN**

18/10

code	CBM	Dimension(mm)
311201	0.052	400x300xH400



- Material: stainless steel 201 or 304 is available
- Mold drawing for the bench and sink
- Square tube with adjustable bullet feet
- With the back splash
- With the second floor for putting the goods on it
- High edge for preventing over flow
- Adjustable feet
- Bowl in 250mm or 300mm depth
- The location of the drain or hole for your reference

**KITCHEN SINK (RIGHT BOWL)**



code	CBM	Bowl size	Dimension(mm)
310601	0.273	400x400x250	1000x600xH850+100
310602	0.375	500x500x250	1200x700xH850+100
310603	0.422	500x500x300	1200x700xH850+100

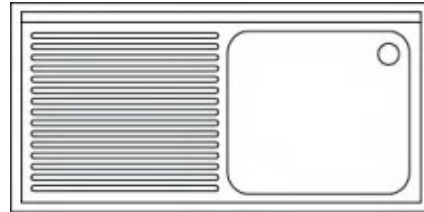

**KITCHEN SINK (LEFT BOWL)**



code	CBM	Bowl size	Dimension(mm)
310604	0.273	400x400x250	1000x600xH850+100
310605	0.375	500x500x250	1200x700xH850+100
310606	0.422	500x500x300	1200x700xH850+100

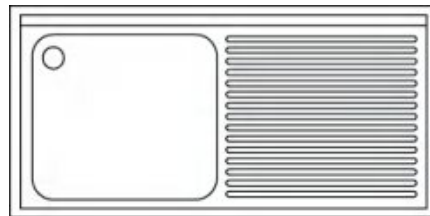

**KITCHEN SINK (DOUBLE BOWL)**



code	CBM	Bowl size	Dimension(mm)
310607	0.273	400x400x250	1000x600xH850+100
310608	0.375	500x500x250	1200x700xH850+100
310609	0.422	500x500x300	1200x700xH850+100

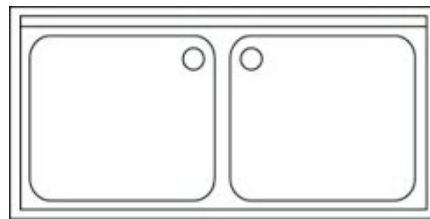

- Mould drawing for the bench and sink
- High edge for preventing over flow
- Adjustable feet
- Bowl in 250mm depth



**COMMERCIAL KITCHEN SINK**

code	CBM	Bowl size	Dimension(mm)
310501	0.169	400x400x250	600x600xH850+100
310502	0.225	500x500x250	700x700xH850+100
310503	0.253	500x500x300	700x700xH850+100



**KITCHEN SINK WITH REFUSE BAG TROLLEY**

code	CBM for trolley	CEM for sink	Dimension(mm)
312001	0.141	0.391	1800x600xH850+100





The drawn

Nice polishing finish after welding

**KITCHEN SINK(2PCS RIGHT BOWLS)**



code	CBM	Bowl size	Dimension(mm)
310911	0.403	400x400x250	1500x600xH850+100
310912	0.555	500x500x250	1800x700xH850+100
310913	0.624	500x500x300	1800x700xH850+100

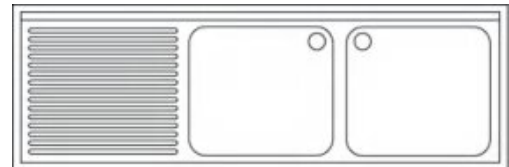

**KITCHEN SINK(2PCS LEFT BOWLS)**



code	CBM	Bowl size	Dimension(mm)
310901	0.403	400x400x250	1500x600xH850+100
310902	0.555	500x500x250	1800x700xH850+100
310903	0.624	500x500x300	1800x700xH850+100

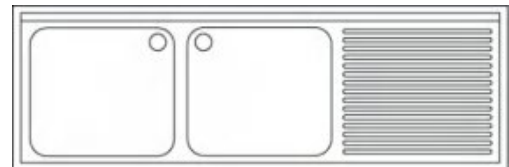

**KITCHEN SINK(3PCS BOWLS)**



code	CBM	Bowl size	Dimension(mm)
310801	0.403	400x400x250	1500x600xH850+100
310802	0.555	500x500x250	1800x700xH850+100
310803	0.624	500x500x300	1800x700xH850+100

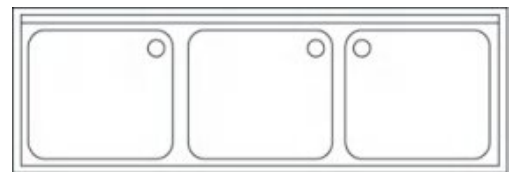

**DEEP DRAW SQUARE SINK**



code	CBM	Dimension(mm)
311201	0.054	500x400xH250
311202	0.068	500x500xH250
311203	0.081	500x500xH300
311204	0.055	450x450xH250
311205	0.066	450x450xH300
311206	0.044	400x400xH250
311207	0.053	400x400xH300



**DEEP DRAW SQUARE SINK**



code	CBM	Dimension(mm)
311301	0.054	500x400xH250
311302	0.068	500x500xH250
311303	0.081	500x500xH300
311304	0.055	450x450xH250
311305	0.066	450x450xH300
311306	0.044	400x400xH250
311307	0.053	400x400xH300





**ENCLOSED BASE WORK CUPBOARD**



code	CBM	Dimension(mm)
340101	0.205	1500x600xH800+ 150
340102	0.218	1600x600xH800+ 150
340103	0.245	1800x800xH800+ 150



**ENCLOSED BASE WORK CUPBOARD**



code	CBM	Dimension(mm)
340105	0.300	1000x600xH800+ 150



**KITCHEN SINK(SINGLE BOWL)**



code	CBM	Dimension(mm)
310304	0.300	1000x600xH850+ 100
310305	0.404	1200x700xH850+ 100
310306	0.457	1200x700xH850+ 100



**SINK NET**



code	Dimension(mm)
310610	470x410
310611	470x460
310612	495x390
310613	410x200
310614	410x240
310615	405x515



**KITCHEN SINK(3PCS BOWLS)**



code	CBM	Dimension(mm)
311001	0.292	500x590xH900



**KITCHEN SINK**

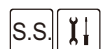

code	CBM	Dimension(mm)
313001	0.243	500x500xH875



**KNEE OPERATED WASH BASIN**

- Other sizes and materials are available
- With knee-operated faucet and soap dispenser.
- 1/2" water connection.
- Basin and backsplash made of 18/10 stainless steel.
- Optional:with warm&cold water accessories.



311102



311101

**KNEE OPERATED WASH BASIN-SQUARE BOWL**

code	CBM	mm
311101	0.089	400x330xH570

**KNEE OPERATED WASH BASIN-ROUND BOWL**

code	CBM	mm
311102	0.059	500x400xH225



311201



311202



**FOOT OPERATED HAND-WASHING BASIN**

- Material : Stainless steel 304 or 201 is available
- Portable and removable design with 2pcs 2" wheel
- Brushed surface treatment
- Foot operated without any electricity
- Fitted with 2pcs 10-15L barrels , one for stock the clean water one for packing the dirty water
- Especially suit for outdoor activities using, like the picnic , parties, mobile washing stations

18/10

code	mm
311201	729x520xH1230
311202	520x459xH1230





**WALL MOUNTED HOOK**

Material: Plastic+SS430+magnet

S.S.

code	CBM	pcs/ctn	mm
360101	0.020	36	13"
360102	0.019	24	18"
360103	0.025	24	24"

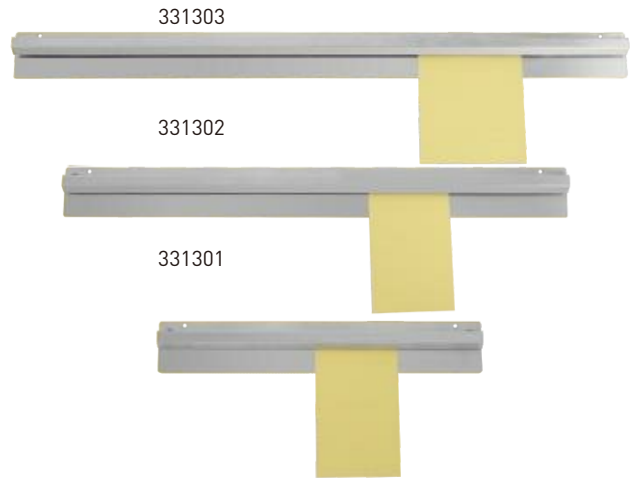

**WALL MOUNTED BILL RAIL**

S.S.

code	CBM	material	mm
331301	0.001	SS304	500x80
331302	0.002	SS304	800x80
331303	0.002	SS304	1000x80
331304	0.001	SS201	500x80
331305	0.002	SS201	800x80
331306	0.002	SS201	1000x80
331307	0.001	SS201	300x80
331308	0.003	SS201	1200x80
331309	0.001	SS304	300x80
331310	0.003	SS304	1200x80



**SPICE SHELVES FOR GN 1/6**

S.S.

code	CBM	PCS/ctn	mm
330801	0.018	4	800x300
330802	0.023	5	1000x300
330803	0.027	6	1200x300
330804	0.031	6	1400x300
330805	0.033	8	1500x300
330806	0.040	10	1800x300



-Railway design for hanging the GN pan



-Front view of packing the GN



**WALL MOUNTED SHELF (BOARD TYPE)**

S.S.

code	CBM	mm
330101	0.019	600×300×2FEET
330102	0.028	900×300×2FEET
330103	0.037	1200×300×2FEET
330104	0.046	1500×300×2FEET
330105	0.055	1800×300×2FEET
330106	0.064	300×2100×2FEET
330107	0.073	300×2400×2FEET



**WALL MOUNTED SHELF (TUBE TYPE)**

S.S.

code	CBM	mm
330201	0.019	300×600
330202	0.028	300×900
330203	0.037	300×1200
330204	0.046	300×1500
330205	0.055	300×1800
330206	0.064	300×2100
330207	0.073	300×2400

70  
kg/m<sup>2</sup>



Underneath view of the wall shelf

**WALL MOUNTED SHELF (BOARD TYPE)**

S.S.

code	CBM	mm
330701	0.019	600×300×H40
330702	0.028	900×300×H40
330703	0.037	1200×300×H40
330704	0.046	1500×300×H40
330705	0.055	1800×300×H40
330706	0.064	2100×300×H40
330707	0.073	2400×300×H40



**WALL MOUNTED SHELF (BOARD TYPE)**

S.S.

code	CBM	mm
330401	0.013	600×300
330402	0.019	900×300
330403	0.024	1200×300
330404	0.030	1500×300
330405	0.036	1800×300
330406	0.042	2100×300
330407	0.048	2400×300



**WALL MOUNTED SHELF (TUBE TYPE)**

**SOLID WELDED WALL SHELF**

S.S.

code	CBM	mm
330601	0.019	900×300
330602	0.037	1200×300
330603	0.046	1500×300
330604	0.055	1800×300
330605	0.064	2100×300
330606	0.073	2400×300

code	CBM	mm
330301	0.006	600×300×2FEET
330302	0.009	900×300×2FEET
330303	0.012	1200×300×2FEET
330304	0.015	1500×300×3FEET
330305	0.018	1800×300×3FEET
330306	0.020	2100×300×3FEET
330307	0.023	2400×300×3FEET
330308	0.017	1500×350×3FEET
330309	0.020	1800×350×3FEET
330310	0.023	2100×350×3FEET
330311	0.026	2400×350×3FEET





**FODABLE WALL SHELF WITHOUT BACK**

-Material: stainless steel 201  
-Thickness : 0.8mm



code	mm
331501	300x300x2T
331502	400x300x2T
331503	500x300x2T
331504	600x300x2T
331505	700x300x2T
331506	800x300x2T
331507	900x300x2T
331508	1000x300x2T
331509	1100x300x2T
331510	1200x300x2T
331511	1300x300x2T
331512	1400x300x2T
331513	1500x300x3T
331514	1600x300x3
331515	T1700x300x3
331516	T1800x300x3T
331517	1900x300x3T
331518	2000x300x3T

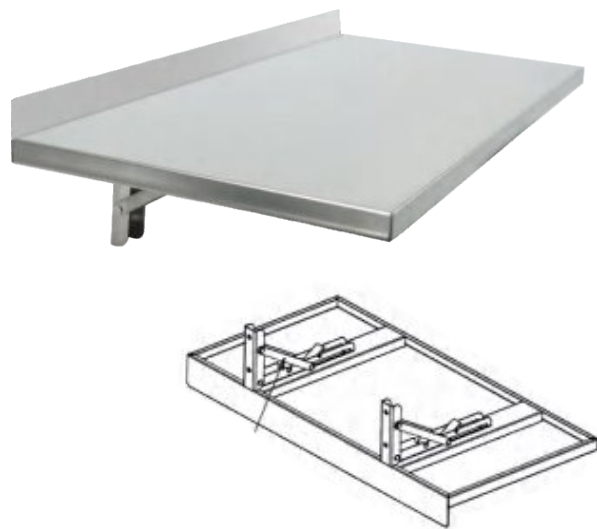

**FODABLE WALL SHELF WITH BACK**

-Material: stainless steel 201  
-Thickness : 0.8mm



code	mm
331601	300x300x2T
331602	400x300x2T
331603	500x300x2T
331604	600x300x2T
331605	700x300x2T
331606	800x300x2T
331607	900x300x2T
331608	1000x300x2T
331609	1100x300x2T
331610	1200x300x2T
331611	1300x300x2T
331612	1400x300x2T
331613	1500x300x3T
331614	1600x300x3
331615	T1700x300x3
331616	T1800x300x3T
331617	1900x300x3T
331618	2000x300x3T

**ADJUSTABLE WALL SHELF**

-Material: stainless steel 201  
-Thickness : 0.8mm  
-Removable shelf distance, more flexible  
-Two tiers structure, board type  
-Fitted with 2 location bars  
-PCS/CTN : 1pcs  
-FI



code	CBM	mm
330501	0.019	600x300x2FEET
330502	0.025	800x300x2FEET
330503	0.028	900x300x2FEET
330504	0.031	1200x300x2FEET
330505	0.037	1400x300x2FEET
330506	0.043	1600x300x3FEET
330507	0.046	1800x300x3FEET
330508	0.049	2000x300x3FEET
330509	0.055	1000x300x2FEET
330510	0.061	1500x300x3FEET
330511	0.025	600x400x2FEET
330512	0.033	800x400x2FEET
330513	0.041	1000x400x2FEET
330514	0.048	1200x400x2FEET
330515	0.056	1400x400x2FEET
330516	0.060	1500x400x3FEET
330517	0.064	1600x400x3FEET
330518	0.072	1800x400x3FEET
330519	0.080	2000x400x3FEET

