

OUTDOOR

Outdoor LED Lighting Catalog

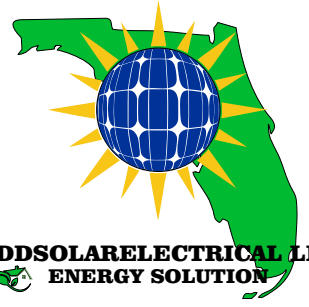

ADDSOLARELECTRICAL LLC
ENERGY SOLUTION



Wallpack
Lights



Wall
Lights



Walkway
Lights



Parking Lot
Lights



Area
Lights



Canopy
Lights



Submergible
Strip Lights



Neon Rope
Lights



Flood
Lights



Pg. 1 | 30 Watt K Series LED Flood Light with Photocell Sensor (Dusk-to-Dawn)



Pg. 12 LED Canopy Lights





Pg. 19 LED Rope Lights



Pg. 11 LED Wallpack Lights

 www.addslarelectrcal.com

 786-312-2895

 sales@addsolarelectrical.com



LED OUTDOOR LIGHTING APPLICATIONS

LED outdoor lighting is more than just illumination. It benefits homes and businesses at night with efficient high output and low power consumption lighting

1. Extending daytime hours - displays your business or sign even at night time
2. Improve employee working efficiency - employees that see well, work faster
3. Brighter - 3x-5x more lux than previous technology
4. Longer life - LED lasts up to 100,000+ hours (35 years, 8 hours per day)
5. Energy saving - LED technology can reduce your electrical costs by up to 70%
6. Cold Temp - LEDs have 5% higher efficacy at -5°C than at room temperatures
7. Durability - LED is a solid state light form resistant to vibrations and impacts

Symbols



Our extended warranty terms ensure issue-free lighting. We know our products are built with the highest quality materials and have the warranty and after-sales support to prove it.



This symbol displays the recommended hours of lifetime for the fixture before seeing degradation usually signifying that the light is built with quality materials.



An international qualification that signifies performance and energy efficiency standards. Products that are DLC Listed get access to national and state rebates.



This symbol is the beam angle of the light. The higher the beam angle the more area the light hits. The less the beam angle, the tighter the light is creating spot light effects.



RoHS certifies a product to be free from hazardous materials such as lead, mercury, and others to ensure a safer environment.

CRI >80

Color Rendering Index is the quantifiable measurement of the light's ability to reveal true colors of objects. High CRI lighting illuminates true-to-life vivid colors of the world around you.

PF >90

Power Factor is the ratio of electricity that passes through the circuit to supply the light. Higher percentages mean more efficient lighting.



Working temperature describes the optimal temperature range the light should function within.



UL and ETL Certifications are required for commercial constructions. These are symbols that indicate the product has passed through rigorous safety testing before reaching the market.



Dimmable. The lighting fixture includes a dimmable driver. A dimming control can be bought separately to dim the lights.

IP65

The IP rating is used to define levels of sealing effectiveness. The first digit (6) indicates protection against the ingress of dust and all other solid objects. The second digit (5) indicates protection against low pressure jets of water from any direction.



Energy Star certifies that products meet strict standards of energy efficiency. Certified products lead the market in efficient lighting.



Input Voltage describes the incoming voltage needed to power the fixture.



An opt-in program for lighting businesses which commit to testing their products at certified labs and therefore report true performance results. Facts such as lumen output, lumen/watt, CRI, and CCT.



Complies with California's Title 24 Building Energy Efficiency Standards. The fixture preserves outdoor and indoor environmental quality.

BEST SELLER

The fixture is moving very quickly off our shelves. Call in to see how many we have in stock.

LUMIPRO

LUMIPRO Lighting is a LED fixture manufacturer that is known for their quality, longevity, and performance. All fixtures are ensured to have passed through extreme quality control before being distributed to sellers.



Distribution type lighting is similar to beam angle. However, it classifies the x and y axis of the beam for area fixtures with a more specific beam angle.

LED Area & Roadway Lights	1-6
LED Flood Lights	1-2, 7-9
LED Pole Lights	10
LED Wallpack Lights	11
LED Canopy Lights	12
LED Tube Lights	13
LED Ground Lights	14-15
LED Wall Lights	15-16
LED Motion Sensor/Solar Lights	16
LED Wall Step Lights	17
LED Under Water Spot Lights	17
LED Security Lights	18
LED Underground Lights	18
LED Flexible Rope/Neon Lights	19-20
LED Strip Lights	21-22
LED Outdoor Modules	23-24
Outdoor Power Supplies	25
LED Wall Washers	26

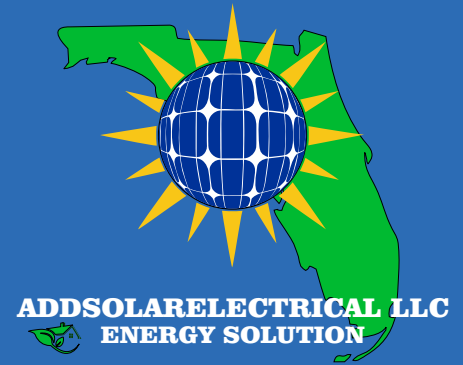

CALL:
786-312-2895
 or
online
www.addsolarelectrical.com

BENEFITS

- 1) Access to 1000+ led lighting products
- 2) Same-Day Delivery and Pickup
- 3) Installation service

K Series LED Flood Light

The K Series is best-in-class when it comes to general purpose flood lighting. It uses Philips SMD3030 LED chips fixed onto a durable aluminum die-cast shell that has passed multiple impact, drop, and water protection ratings. The fixture itself has been awarded multiple safety certifications such as ETL, cETL, and DLC certifications.

The K Series will withstand a minimum of 27.39 years (80,000 hours) with regular usage of 8 hours per day.

Product Specifications

- Manufactured by LUMIPRO Lighting
- 3 mount options: U Bracket, Knuckle, and Trunnion
- ETL and cETL Listed
- DLC Listed
- Philips LUMILEDS SMD 3030 LED chips
- Color Rendering Index >70
- L70>80,000 LED lifetime hours.
- >93% power efficiency
- 100° beam angle
- Working temp: -20°C ~ 50°C
- Storage temp: -40°C ~ 70°C
- 120 lumen/watt
- Input Voltage: 100~277VAC 50/60Hz
- Optional Photocell Sensor (Dusk-to-Dawn)

Construction

- One piece die-cast aluminum shell
- Slate powder coating prevents rust & scratches
- Tempered glass lens
- Explosion-Proof Class 1 protection rating
- IK07 impact protection
- IP65 waterproof
- 5 year warranty

We can manufacture other color temperatures (3000K ~ 5700K), custom powder coat colors, input voltages, and mounting types. Call 305.468.8986 for a custom ordering sheet and more detailed specifications.

sku	wattage	color	lumens	replaces	sensor	mount
F-30W-K	30	Daylight White 5000K	3600 lm	180W Incandescent/100W HID	none	U Bracket
F-50W-K	50	Daylight White 5000K	6000 lm	300W Incandescent/170W HID	none	U Bracket
F-30W-K-S	30	Daylight White 5000K	3600 lm	180W Incandescent/100W HID	photocell	U Bracket
F-50W-K-S	50	Daylight White 5000K	6000 lm	500W Incandescent/170W HID	photocell	U Bracket
F-30W-K1	30	Daylight White 5000K	3600 lm	180W Incandescent/100W HID	none	Knuckle
F-50W-K1	50	Daylight White 5000K	6000 lm	300W Incandescent/170W HID	none	Knuckle
F-30W-K1-S	30	Daylight White 5000K	3600 lm	180W Incandescent/100W HID	photocell	Knuckle
F-50W-K1-S	50	Daylight White 5000K	6000 lm	300W Incandescent/170W HID	photocell	Knuckle

U Bracket

Knuckle Mount



Optional Photocell Sensor

30 Watt Knuckle Mount

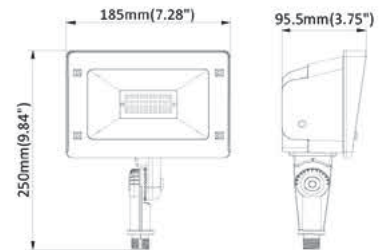

30 Watt U Bracket Mount

30 Watt Trunnion Mount

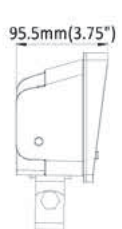
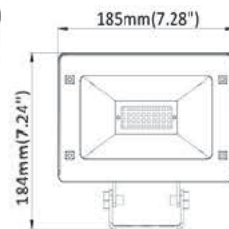
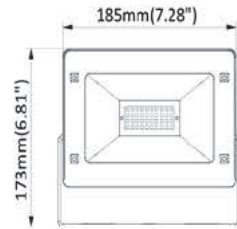

See more dimensional drawings on the product page at polled.com

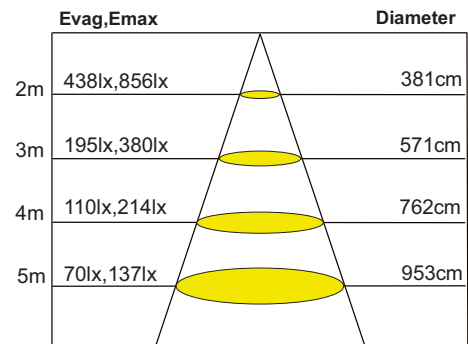
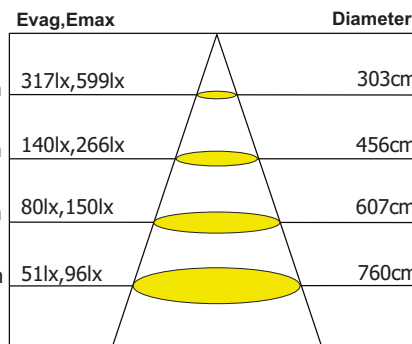

Black K Series LED Area Light



The Black K Series carries everything the original K Series does but in a redesigned housing with a larger surface area. This surface area offers a 100% increase in cooling efficiency ideal for long sessions. This new shell also provides Type 3 or Type 5 coverage ideal for area lighting.

The Black K Series will withstand a minimum of 27.39 years (80,000 hours) with regular usage of 8 hours per day.

Product Specifications

- Manufactured by LUMIPRO Lighting
- 3 mounting types: U Bracket, Slip Fitter, and Trunnion
- ETL & cETL Listed
- DLC Listed
- Philips LUMILEDS SMD 3030 LED chips
- 120 lumen/watt
- Color Rendering Index >70
- Color Temp: 3000K, 4000K, 5000K, 5700K
- Distribution Type: Type 3 (70°x145°) or Type 5 (90°)
- >93% Power Efficiency
- L70>80,000 LED lifetime hours.
- IP65 waterproof
- Working temp: -20°C ~ 50°C
- Storage temp: -40°C ~ 70°C
- Input Power: 100~277VAC 50/60Hz
- Optional Photocell Sensor (Dusk-to-Dawn)

Construction

- Redesigned heat-dissipating fin design for non-stop usage.
- One piece die-cast aluminum shell
- Explosion-Proof Class 1 protection rating
- Wear-resistance coating prevents rust and scratches
- Silicone sealed polycarbonate diffuser
- IK07 impact rated
- 5 year warranty

We can manufacture other color temperatures (3000K ~ 5700K), custom powder coat colors, input voltages, distribution types and mounting types. Call 305.468.8986 for a custom ordering sheet and more detailed specifications.

U Bracket

1.5"~2.5" Slip Fitter



Type 5 (90° beam angle)

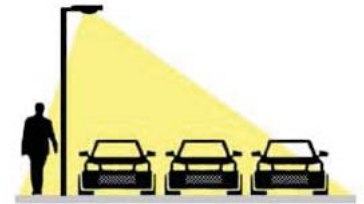

Type 3 (70°x145° beam angle)



Photocell sensor detects light and automatically turns on from dusk to dawn



sku	wattage	color	lumens	replaces	sensor	distribution	Mount
Universal Bracket Mount							
F-80W-K	80	Daylight White 5000K	9600 lm	480W Incandescent/270W HID	none	Type 5	U Bracket
F-100W-K	100	Daylight White 5000K	12000 lm	600W Incandescent/335W HID	none	Type 5	U Bracket
F-150W-K	150	Daylight White 5000K	18000 lm	900W Incandescent/500W HID	none	Type 5	U Bracket
F-80W-K-S	80	Daylight White 5000K	9600 lm	480W Incandescent/270W HID	photocell	Type 5	U Bracket
F-100W-K-S	100	Daylight White 5000K	12000 lm	600W Incandescent/335W HID	photocell	Type 5	U Bracket
F-150W-K-S	150	Daylight White 5000K	18000 lm	900W Incandescent/500W HID	photocell	Type 5	U Bracket
Standard Slip Fitter 1.25" ~ 3"							
1-ST-K80W	80	Daylight White 5000K	9600 lm	480W Incandescent/270W HID	none	Type 5	Adj. Slip Fitter
1-ST-K100W	100	Daylight White 5000K	12000 lm	600W Incandescent/335W HID	none	Type 5	Adj. Slip Fitter
1-ST-K150W	150	Daylight White 5000K	18000 lm	900W Incandescent/500W HID	none	Type 5	Adj. Slip Fitter
1-ST-K80W-S	80	Daylight White 5000K	9600 lm	480W Incandescent/270W HID	photocell	Type 5	Adj. Slip Fitter
1-ST-K100W-S	100	Daylight White 5000K	12000 lm	600W Incandescent/335W HID	photocell	Type 5	Adj. Slip Fitter
1-ST-K150W-S	150	Daylight White 5000K	18000 lm	900W Incandescent/500W HID	photocell	Type 5	Adj. Slip Fitter



C Series LED Roadway Area Light

The LUMIPRO C Series is today's most popular slim roadway fixture. It has a type 3 distribution ideal for streets and border lights. Large aerated aluminum fins dissipate heat so efficiently it allows for 24/7 usage in necessary situations such as for public roadway lighting.

The C Series will withstand a minimum of 27.39 years (80,000 hours) with regular usage of 8 hours per day.

Product Specifications

- Manufactured by LUMIPRO Lighting
- 4 mounts: Slip Fitter, Pole Mount, Trunnion, and Wall Mount
- ETL and cETL Listed
- DLC Listed
- Philips LUMILEDS SMD 3030 LED chips
- Color Rendering Index >70
- Color Temp Options: 3000K, 4000K, 5000K, 5700K
- L70>80,000 LED lifetime hours.
- >90% power efficiency
- Type 3 distribution (70°x145°), Type 4, or Type 5 (90°)
- Working temp: -20°C ~ 50°C
- Storage temp: -40°C ~ 70°C
- 125 lumen/watt
- Input Voltage: 100~277VAC 50/60Hz
- Photocell Sensor (Dusk-to-Dawn) or Bi-Level Sensor (Motion)

Construction

- One piece die-cast aluminum shell
- Slate powder coating prevents rust & scratches
- IK08 impact protection
- IP65 waterproof
- 5 year warranty

We can manufacture other color temperatures (3000K ~ 5700K), custom powder coat colors, input voltages, and mounting types, sensor options. Call 305.468.8986 for a custom ordering sheet and more detailed specifications.

sku	wattage	color	lumens	replaces	sensor	mount
1-ST-C240W	240	Daylight White 5000K	30000 lm	1500W Incandescent/850W HID	none	Adj. Slip Fitter
1-ST-C240W-S	240	Daylight White 5000K	30000 lm	1500W Incandescent/850W HID	photocell	Adj. Slip Fitter
1-ST-C300W	300	Daylight White 5000K	37500 lm	1875W Incandescent/1050W HID	none	Adj. Slip Fitter
1-ST-C300W-S	300	Daylight White 5000K	37500 lm	1875W Incandescent/1050W HID	photocell	Adj. Slip Fitter

240 Watt w/ Photocell Sensor

300 Watt w/ Slip Fitter Mount

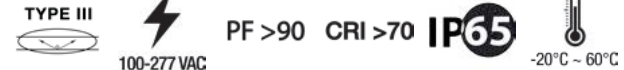
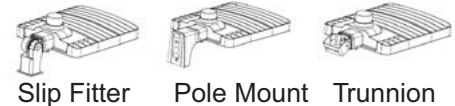

PHILIPS LUMILEDS INVENTRONICS

Accessories

sku	description
1-ST-C/SF	adj. slip fitter mount for poles 1.5"~2.5"
1-ST-C/MW	round / square pole / direct wall mount
1-ST-C/TM	wall trunnion mount with adjustable angle
1-ST/ShortingCap	removes dusk-to-dawn capability

G Series LED Area Light

The LUMIPRO G Series offers higher lumens per watt with new advances in chip technology. The body design allows instant heat dissipation through a very airy aluminum frame.

- Manufactured by LUMIPRO Lighting
- ETL Listed and DLC Certified
- L80>50,000 hour lifetime
- Type 3 Distribution (80°x150° beam angle) ideal for edge installations and roadways
- Adjustable Slip Fitter mount for pole insert mounting
- 5 year warranty
- 130 lm/watt

We can manufacture other color temperatures, powder coat colors, input voltages, mounting types, and sensor options.



Accessories

retail price	sku	description
\$19.95	1-ST-G/SF	adj. slip fitter mount for poles 1.5"~2.5"
\$17.95	1-ST-G/DM	Round / Square Pole / Direct Wall Mount
\$19.95	1-ST-G/TM	wall trunnion mount with adjustable angle
\$8.95	1-ST/ShortingCap	removes dusk-to-dawn capability

sku	wattage	color	lumens	replaces
1-ST-G200W	200	Daylight White 5700K	26000 lm	1300W Incandescent/750W HID



H Series LED Roadway Area Light

The LUMIPRO H Series is a shoebox style roadway fixture with a tighter type 3 distribution. UL Listed. Designed specifically for roadway and border lighting.

The H Series will withstand a minimum of 27.39 years (80,000 hours) with regular usage of 8 hours per day.

Product Specifications

- Manufactured by LUMIPRO Lighting
- 4 mounts: Slip Fitter, Pole Mount, Trunnion, and Wall Mount
- Available in Black or White Finish
- UL and cUL Listed, TÜV Listed, CE, CB, RCM, and GS
- DLC Listed
- Philips LUMILEDS SMD 3030 LED chips
- Meanwell Driver
- Color Rendering Index >80
- Color Temp Options: 3000K, 4000K, 5000K, 5700K, 6500K
- L70>80,000 LED lifetime hours.
- >93% power efficiency
- Optional Type 3 distribution (60°x150°)
- Working temp: -30°C ~ 50°C
- Storage temp: -40°C ~ 70°C
- Operating Humidity: 15-90%RH
- 125 lumen/watt
- Input Voltage: 100~277VAC 50/60Hz
- Photocell Sensor (Dusk-to-Dawn) or Microwave Sensor
- Optional 0-10V dimmable and DALI dimmable

Construction

- Heat sink body is constructed with pure 1070 aluminum, 40% lighter than die-cast metals with better heat dissipation
- Slate powder coating prevents rust & scratches
- IP65 waterproof
- 5 year warranty

We can manufacture other color temperatures (3000K ~ 6500K), custom powder coat colors, input voltages, and mounting types, sensor options. Call 305.468.8986 for a custom ordering sheet and more detailed specifications.

150 Watt w/ Slip Fitter Mount

150 Watt w/ Photocell Sensor

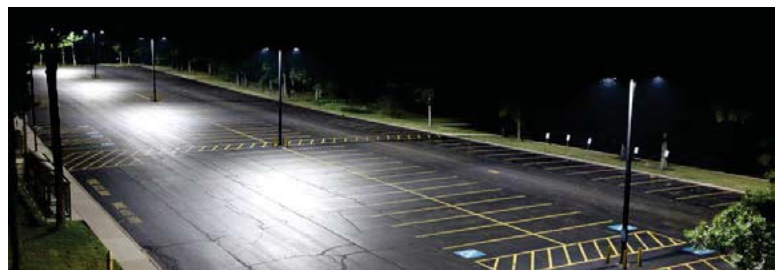

Accessories

sku	description
1-ST-H/SF	adj. slip fitter mount for poles 1.5"~2.5"
1-ST-H/TM	wall trunnion mount with adjustable angle
1-ST/ShortingCap	removes dusk-to-dawn capability



PF >93 CRI >80 IP65 -30°C ~ 50°C

sku	wattage	color	lumens	replaces	sensor	mount
1-ST-H150W-S	150	Daylight White 5000K	18750 lm	950W Incandescent/550W HID	photocell	Adj. Slip Fitter
1-ST-H200W-S	200	Daylight White 5000K	25000 lm	1250W Incandescent/700W HID	photocell	Adj. Slip Fitter

S Series LED Area Light

The LUMIPRO S Series is a high CRI, type 5 circular distribution that has the same intensity at all angles. Ideal for parking lots, intersections, center of roadways and islands.

- Manufactured by LUMIPRO Lighting
- ETL Listed, L70>80,000 hour lifetime, CE, and RoHS
- Type 5 distribution (90°x180° beam angle)
- Cool White 6500K offers the highest CRI allowing pure vision even in dark nights. 0% muddy figures great for CCTV
- Samsung LED chips and Meanwell driver
- Adjustable Slip Fitter mount for pole insert mounting
- Samsung LED chips and Meanwell driver
- 100±5 lm/watt
- 3 year warranty



PF >90 CRI >90 IP65 -20°C ~ 60°C

sku	wattage	color	lumens	replaces
1-ST-S150W	150	Cool White 6500K	13500 lm	675W Incandescent/375W HID
1-ST-S240W	240	Cool White 6500K	25200 lm	1260W Incandescent/700W HID

LUMIPRO

PK Series LED Area Light

The PK (Parking Lot) Series is a shoebox designed for daily parking lot use. Constructed with Cree LED chips ensuring longevity past 20 years. The shell is a hollow aluminum that dissipates heat efficiently. Ease of construction with function in mind leaves you with a cost-effective parking lot solution.

- UL Listed, L70>50,000 hour lifetime, CE, RoHS
- Extremely cost effective parking lot solution
- Cree LED Chips
- Optional: Slip Fitter or Trunnion Mount
- Cool White 6500K offers high CRI great for CCTV
- Shoebox style design created for heat dissipation
- Adjustable Slip Fitter mount for pole insert mounting
- 3 year warranty



CREE LEDs



sku	wattage	color	lumens	replaces
1-ST-PK90RE-W(UL)	90	Cool White 6500K	7200 lm	675W Incandescent/375W HID
1-ST-PK120S-W(UL)	120	Cool White 6500K	9600 lm	1260W Incandescent/700W HID
1-ST-PK/TM	trunnion mount allows PK series to be wall mounted and angle adjusted			

AL Series LED Area Light

The AL Series in form is one big heat sink. It distributes heat away from the components and into the body and fins allowing the light to stay cool well past 24 hour sessions. Ideal as a cost-effective and reliable parking lot and area light.

- CE and RoHS Certified
- Heatsink design allows instantaneous dissipation of heat
- Attaches to 2.4" horizontal pole
- 120° beam angle distributes to a wide area
- Epistar chipset
- 1 year warranty



1-ST-AL50W



1-ST-AL100W



1-ST-AL150W

sku	wattage	color	lumens	replaces
1-ST-AL50W	50	Cool White 6500K	5000 lm	250W Incandescent/150W HID
1-ST-AL100W	100	Cool White 6500K	10000 lm	500W Incandescent/285W HID
1-ST-AL150W	150	Cool White 6500K	15000 lm	750W Incandescent/430W HID



B Series LED Area Light

The B Series is a budget area light that gets the job done for low altitude installations between 10-20 feet.

- Attaches to 2.4" horizontal pole
- 120° beam angle distributes to a wide area
- Tempered glass lens with aluminum body construction
- 1 year warranty, CE and RoHS Certified



1-ST-B60W

sku	wattage	color	lumens	replaces
1-ST-B40W	40	Cool White 6500K	4000 lm	200W Incandescent/115W HID
1-ST-B60W	60	Cool White 6500K	6000 lm	300W Incandescent/175W HID



Y Series LED Area Light

The Y Series is a wall mounted dusk-to-dawn security fixture ideal for businesses entrances and exits. Choose between direct wall mounting or installation with a 130° pole extension.

- Manufactured by LUMIPRO Lighting
- ETL Listed, DLC Certified, CE, and RoHS
- Dusk-to-dawn photocell sensor removes the need for a manual switch and turns on and off automatically
- L70>50,000 hour lifetime
- Type 5 distribution (120° beam angle)
- 135° existing pole allows you to easily wall mount with included clips
- 95~130 lm/watt



sku	wattage	color	lumens	replaces
1-ST-Y40W-S	40	Cool White 6500K	3900 lm	195 Incandescent/125W HID
1-ST-Y50W-S	50	Daylight White 5000K	6500 lm	260W Incandescent/185W HID
1-ST-Y70W-S	70	Daylight White 5000K	9100 lm	365W Incandescent/260W HID

SL Series Solar LED Area Light

The SL Series is a wall mounted rechargeable solar area light. An onboard battery carries a 12 hour charge for the full night.

- 6-7 hours charge time depending on sunshine
- 20+ hour discharge time good for multiple nights
- Photocell dusk-to-dawn sensor turns on only at night
- Monocrystalline 18V/60W/Lithium 12V/21Ah, 5 year battery life
- High Efficiency Bridgelux LED chip
- Ideal mounting height: 6-7m high creates a 20-25m light beam
- Ideal for gardens, lawns, parks, pathways, and roadways
- 1 year warranty



sku	wattage	color	lumens	half-charge	replaces
1-ST-SL30W	30	Cool White 6500K	3900 lm	1300 lm	190W Incandescent/110W HID

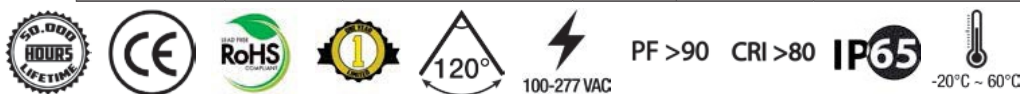

V Series LED Area Light

The V Series is a 300 watt HID replacement capable of illuminating parking lots efficiently.

- Pole insert mount tightens to pole
- UL Listed Power Supply
- 100 lm/watt
- 120° beam angle
- Ideal mount height: 6-8m for a 20-25m light area
- Size: 65x27x17cm
- 1 year warranty



sku	wattage	color	lumens	replaces
1-ST-V100W	100	Cool White 6500K	10000 lm	500W Incandescent/300W HID



ETL Series LED Flood Light

The ETL Series is built with heat dissipation in mind; huge aluminum fins swoop across the back panel. Meanwell drivers give it an unprecedented lifetime. The aluminum copping on the reflectors ensure zero light leakage and increased amplification.



Product Specifications

- ETL listed for commercial application
- Separate driver cabin offers easy one-man repairs
- Meanwell driver
- 90 lumen/watt
- L70>50,000 LED Lifetime hours
- 100~277VAC
- U Bracket Mount
- Extensive aluminum finned back provides 24/7 heat dissipation

sku	wattage	color	lumens	replaces
F-20W-UL	20	Daylight White 5000K	1800 lm	120W Incandescent/70W HID
F-30W-UL	30	Daylight White 5000K	2700 lm	180W Incandescent/100W HID
F-100W-UL	100	Daylight White 5000K	9000 lm	600W Incandescent/330W HID
F-200W-UL	200	Daylight White 5000K	18000 lm	1200W Incandescent/660W HID



BKES Series LED Area Light

The BKES Series is the next generation of flood lighting. Slim aluminum body with an Epistar chipset and 5 year warranty. This fixture will save you 70% in lighting energy and maintenance costs.

Product Specifications

- Instantly see up to 70% in energy savings
- 6500K Cool White
- Adjustable U bracket mount
- 110 lumen/watt
- L70>50,000 LED Lifetime Hours
- Input: 100 VAC ~ 277 VAC
- IP65 rated for water protection
- Epistar Chip Set
- Ideal for mounting to any wall or ceiling surface

Construction

- Glass lens front cover
- Black finish painted over aluminum cast
- 5 year warranty



sku	wattage	color	lumens	replaces
F-50W-BKES	50	Cool White 6500K	5500 lm	275W Incandescent/160W HID
F-100W-BKES	100	Cool White 6500K	11000 lm	550W Incandescent/315W HID



Illuminated loading docks at night extend your working hours and keep your logistics running 24/7.



WT Series LED Flood Light

The WT Series are driverless slim white LED flood lights ideal for mobile or indoor applications such as factories, warehouse interiors, and exhibitions.

- CE and RoHS Certified
- Frosted lens diffuses and distributes light evenly with minimal light loss
- Reduces glare for sensitive operations
- Extremely slim and small form factor with high power output
- Driverless operation
- 1 year warranty



F-100W-WT

sku	wattage	color	lumens	replaces	lens
F-20W-WT	20	Daylight White 5000K	1800 lm	90W Incandescent/50W HID	frosted
F-50W-WT	50	Daylight White 5000K	4500 lm	225W Incandescent/130W HID	frosted
F-100W-WT	100	Daylight White 5000K	9000 lm	450W Incandescent/260W HID	frosted

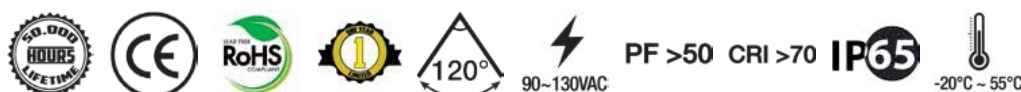

BK Series LED Flood Light

The BK Series has a new amplifying design on the aluminum side reflectors which allow for more light to be directed forward leading to higher lumen efficiency and better energy savings. Fin backing allows for more surface area and better dissipation of heat.



The BK series will withstand a minimum of 17 years with regular usage of 8 hours per day.

Product Specifications

- Instantly see up to 70% in energy savings
- 100 lumen/watt ±10%
- L70>50,000 LED Lifetime Hours
- Input: 85 VAC ~ 265 VAC
- IP65 rated for water protection
- Working Environment Humidity: <85%
- High Potential Testing Standard: 3000V/5mA/3s

Construction

- Glass lens front cover
- Black finish painted over aluminum cast
- Adjustable U bracket mount
- 1 year warranty



BK Series LED flood lights engulf the loading docks with light increasing security, camera visibility, and allowing for extended work hours.

sku	wattage	color	lumens	replaces
F-10W-BK	10	Cool White 6000K	1000 lm	60W Incandescent/35W HID
F-10WW-BK	10	Daylight White 4000K	1000 lm	60W Incandescent/35W HID
F-20W-BK	20	Cool White 6000K	2000 lm	120W Incandescent/70W HID
F-20WW-BK	20	Daylight White 4000K	2000 lm	120W Incandescent/70W HID
F-30W-BK	30	Cool White 6000K	3000 lm	180W Incandescent/105W HID
F-30WW-BK	30	Daylight White 4000K	3000 lm	180W Incandescent/105W HID
F-50W-BK	50	Cool White 6000K	5000 lm	300W Incandescent/175W HID
F-50WW-BK	50	Daylight White 4000K	5000 lm	300W Incandescent/175W HID
F-80W-BK-T	80	Cool White 6500K	8000 lm	480W Incandescent/240W HID
F-100W-BK	100	Cool White 6000K	10000 lm	600W Incandescent/330W HID
F-100WW-BK	100	Daylight White 4000K	10000 lm	600W Incandescent/330W HID
F-120W-BK-T	120	Cool White 6500K	12000 lm	720W Incandescent/400W HID
F-150W-BK	150	Cool White 6000K	15000 lm	900W Incandescent/500W HID
F-150WW-BK	150	Daylight White 4000K	15000 lm	900W Incandescent/500W HID
F-180W-BK-T	180	Cool White 6500K	18000 lm	3000W Incandescent/600W HID
F-210W-BK-T	210	Cool White 6500K	21000 lm	3500W Incandescent/700W HID
F-280W-BK-T	280	Cool White 6500K	28000 lm	1680W Incandescent/950W HID



100W BK Series with cobbled aluminum reflectors redistribute lost lumen forward



RGB BK Series LED Flood Light

The RGB BK Series is ideal for adding color to your building or exterior landscaping. It uses the housing of the popular BK Series with the inclusion of an RGB capable LED chip and control box.

The RGB BK Series will withstand a minimum of 17 years with regular usage of 8 hours per day.

- U Bracket Universal Mounting
- IR Frequency remote
- One remote can control multiple RGB BK Series flood lights.
- To synchronize effects, set all fixtures to the same effect and turn off and on the main switch to match their timing
- 16 color options and 4 effects (flashing, strobe, fade, and smooth)

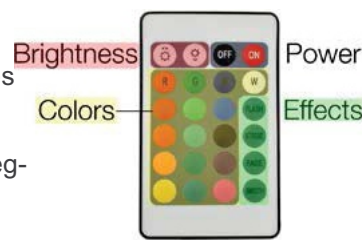

sku	wattage	color	lumens	replaces
F-10RGB-BK	10	RGB	1200 lm	60W Incandescent/35W HID
F-20RGB-BK	20	RGB	2400 lm	120W Incandescent/70W HID
F-30RGB-BK	30	RGB	3600 lm	180W Incandescent/105W HID



G Series LED Flood Light

The G Series is a very cost-efficient solution that provides constant illumination year after year with zero maintenance. Ideal for budget-conscious buyers who expect quality and reliability.

- Motion Sensor, 12VDC, and RGB options available
- Universal U Bracket mount allows installation to any surface
- 100 lumen/watt provides great efficiency for half the price
- 1 year warranty



F-100W



F-50W



F-S10-W



F-100RGB

sku	wattage	color	lumens	replaces
90~265VAC				
F-10W	10	Cool White 6500K	1000 lm	60W Incandescent/35W HID
F-10WW	10	Warm White 3000K	1000 lm	60W Incandescent/35W HID
F-20W	20	Cool White 6500K	2000 lm	120W Incandescent/70W HID
F-20WW	20	Warm White 3000K	2000 lm	120W Incandescent/70W HID
F-30W	30	Cool White 6500K	3000 lm	180W Incandescent/100W HID
F-30WW	30	Warm White 3000K	3000 lm	180W Incandescent/100W HID
F-50W	50	Cool White 6500K	5000 lm	300W Incandescent/170W HID
F-50WW	50	Warm White 3000K	5000 lm	300W Incandescent/170W HID
F-70W	70	Cool White 6500K	7000 lm	420W Incandescent/240W HID
F-70WW	70	Warm White 3000K	7000 lm	420W Incandescent/240W HID
F-100W	100	Cool White 6500K	10000 lm	600W Incandescent/335W HID
F-100WW	100	Warm White 3000K	10000 lm	600W Incandescent/335W HID
F-150W	150	Cool White 6500K	15000 lm	900W Incandescent/500W HID
F-280W	280	Cool White 6500K	28000 lm	1680W Incan. /935W HID
12VDC				
F-10W-12V	10	Cool White 6500K	1000 lm	60W Incandescent/35W HID
F-20W-12V	20	Cool White 6500K	2000 lm	120W Incandescent/70W HID
F-30W-12V	30	Cool White 6500K	3000 lm	180W Incandescent/105W HID
F-50W-12V	50	Cool White 6500K	5000 lm	300W Incandescent/150W HID
90~265VAC with Motion Sensor				
F-S10-W	10	Cool White 6000K	1000 lm	60W Incandescent/35W HID
F-S20-W	20	Cool White 6000K	2000 lm	120W Incandescent/70W HID
F-S30-W	30	Cool White 6000K	3000 lm	180W Incandescent/105W HID
F-S50-W	50	Cool White 6000K	5000 lm	300W Incandescent/170W HID
90~265 V C RGB				
F-100RGB	100	RGB	10000 lm	600W CFL/300W HID



Ground Spike for Flood Lights

The Ground Spike attaches to any U Bracket. Mounts to dirt or soil. Compatible with: G, BK, ETL, WT, K, Black K Series LED Floodlights

sku	height	diameter
1-Z-SPIKE/6"	6"	1.8"
1-Z-SPIKE/6"-S	6"	1.4"
1-Z-SPIKE/10"	10"	2.4"



Solar LED Pole Area Light 12'

Solar function allows the light to run standalone without external wiring. 30 watt at 12' is capable of illuminating a walkway.

- Samsung LED Chips
- Solar Panel 60W/18V
- 14.8V 15Ah internal battery recharged by the solar panel
- Discharge rate: 8 hours
- Battery Capacity: 15000 mAh
- Maximum Charge/Discharge Current: 5000mA
- Standard Discharge Current: 2000mA
- Nominal Voltage 14.8V Max Charge: 16.8V
- Discharge Cutoff Voltage: 12V
- 100lm/watt
- 57,000 Lifetime Hours
- 1 year warranty

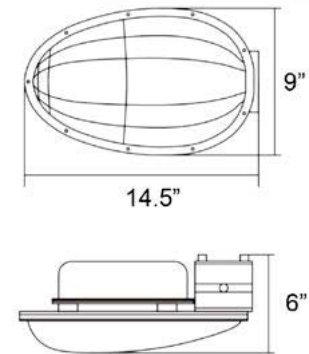

sku	wattage	color	lumens	replaces
1-P-SL30W-12'	30	Cool White 6500K	3000 lm	1260W Incandescent/700W HID



PF >90

CRI >90

IP65



LED Circular Pole Area Light 10'

Ideal for gardens, walkways, roadways, and parking lots.

- 10' height provides illumination for 20'x20' area
- 90~260VAC Input Voltage
- Cool White 6000K
- L70>50,000 hour lifetime
- Type 5 distribution (120° beam angle)
- 1 year warranty
- 100 lm/watt
- Aluminum construction with polycarbonate lens



sku	wattage	color	lumens	replaces
1-P-30W-10'	30	Cool White 6000K	3000 lm	150W Incandescent/85W HID



PF >90

CRI >70

IP65



E27 Socket Garden Light Post

- Existing E27 Socket
- Glass pane protects the bulb from water entry
- Sold in 9' or 13' height
- Ideal for parks and walkways

sku	height
1-P-E27-9'	9'
1-P-E27-13'	13'



ETL Series LED Wallpack Light



The LUMIPRO ETL Series is equipped with a photocell (dusk-to-dawn) sensor. Ideal for replacing all exterior wall mounted lighting.

Product Specifications

- cETLus Listed suitable for wet locations
- Certified to ANSI C136.31-2001, 3G vibration standards
- Internal 10kV surge protection tested with IEEE / ANSI C62.41.2
- CCT 3000K~5700K; DW 5000K is standard
- Optional photocell sensor or shorting cap (dusk-to-dawn)
- Forward throw illumination
- 120 lumen/watt
- L90>100,000 LED Lifetime Hours
- Input: 120VAC~277 VAC, 0-10V dimmable
- IP65 rated for water protection
- Ideal for mounting to exterior wall surfaces



13W-26W



45W-80W

Construction

- Aluminum construction w/ polycarbonate lens
- Slate grey anti-rust powder coated
- 10 year warranty



We can manufacture CCT (3000K~5700K), photocell or motion sensors, and custom thermoset color finishes. Call 305.468.8986 for a custom ordering sheet and more detailed specifications.

sku	wattage	color	lumens	replaces	sensor
1-WP13W-ETL-S	13	Daylight White 5000K	1500 lm	60W Incandescent/45W HID	optional
1-WP26W-ETL-S	26	Daylight White 5000K	3000 lm	120W Incandescent/90W HID	optional
1-WP45W-ETL	45	Daylight White 5000K	5500 lm	220W Incandescent/160W HID	optional
1-WP60W-ETL	60	Daylight White 5000K	7200 lm	360W Incandescent/205W HID	optional
1-WP80W-ETL	80	Daylight White 5000K	9600 lm	480W Incandescent/275W HID	optional
1-WP100W-ETL	100	Daylight White 5000K	12000 lm	600W Incandescent/350W HID	optional
1-WP120W-ETL	120	Daylight White 5000K	14400 lm	720W Incandescent/425W HID	optional
1-WP140W-ETL	140	Daylight White 5000K	16800 lm	840W Incandescent/675W HID	optional

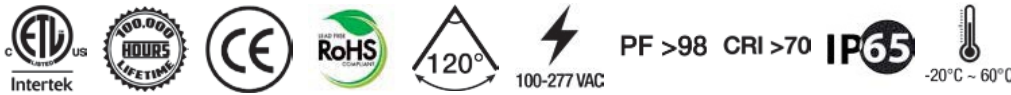

UL Series LED Wallpack Light



The UL Series is equipped with a photocell (dusk-to-dawn) sensor. Ideal for replacing all exterior wall mounted lighting.

Product Specifications

- UL, cUL, DLC, FCC, CE, and RoHS Listed
- Cool White 6000K
- Forward throw illumination
- Up to 100 lumen/watt
- L90>50,000 LED Lifetime Hours
- Input: 120VAC~277 VAC, 0-10V dimmable
- IP65 rated for water protection
- Ideal for mounting to exterior wall surfaces



1-WP80W-UL



1-WP120W-UL

Construction

- Aluminum construction w/ tempered glass lens
- 5 year warranty



Illuminated docks extend your working hours and keep your logistics running 24/7. Invaluable.

sku	wattage	color	lumens	replaces
1-WP60W-UL	60	Cool White 6000K	6000 lm	300W Incandescent/175W HID
1-WP80W-UL	80	Cool White 6000K	8000 lm	400W Incandescent/230W HID
1-WP120W-UL	120	Cool White 6000K	12000 lm	600W Incandescent/350W HID
1-WP150W-UL	150	Cool White 6000K	15000 lm	750W Incandescent/450W HID



UD Series LED Canopy Light



The LUMIPRO UD Series is a high-power canopy light ideal for tall gas station canopies.

Product Specifications

- UL, cUL, DLC, FCC, CE, and RoHS Listed
- Philips LUMILEDS SMD3030 1.5W chips and CEN-100-48 Mean Well driver
- Up to 120 lumen/watt
- L90>50,000 LED Lifetime Hours
- Input: 120VAC~277 VAC, 0-10V dimmable
- IP65 rated for water protection

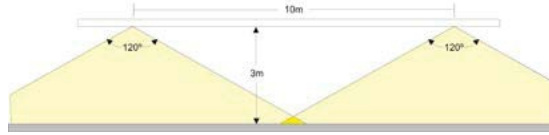

Construction

- Aluminum construction w/ tempered glass lens
- 5 year warranty



We can manufacture CCT (3000K~5700K), photocell or motion sensors, and custom thermoset color finishes. Call 305.468.8986 for a custom ordering sheet and more detailed specifications.

sku	wattage	color	lumens	replaces
1-CP-UD100W	100	Daylight White 5700K	11500 lm	575W Incandescent/350W HID
1-CP-UD150W	150	Daylight White 5700K	17250 lm	900W Incandescent/500W HID



PF >95

CRI >80



R Series & S Series LED Canopy Light



The Round Series & Square Series canopy light is ideal for low to medium canopies and provides diffused 180° lighting.

- UL, cUL, CE, and RoHS Certified
- Cree LED chips
- Frosted lens distributes light evenly while reducing glare
- 50,000 Lifetime Hours



1-CP-S Series



1-CP-R Series

sku	wattage	color	lumens	replaces
1-CP-S30W	30	Cool White 6000K	2200 lm	110W Incandescent/35W HID
1-CP-S60W	60	Cool White 6000K	4200 lm	210W Incandescent/150W HID
1-CP-R90W	90	Cool White 6000K	6100 lm	305W Incandescent/200W HID



PF >90

SP Series LED Canopy Light



The LUMIPRO SP Series offers a slim profile body that effectively illuminates under canopy areas with high efficiency.

Product Specifications

- ETL or UL, cUL, DLC, FCC, CE, and RoHS Listed
- CCT 3000K~6500K; standard 5000K
- 120~130 lumen/watt
- L90>50,000 LED Lifetime Hours
- Optional: Non-dimmable, 0-10V, Dimmable, or Motion Sensor
- Input: 120VAC~277 VAC
- IP65 rated for water protection
- Ideal for mounting to exterior wall surfaces

Construction

- Aluminum construction w/ tempered glass lens
- 5~10 year warranty depending on the model

We can manufacture CCT (3000K~6500K) and custom powder coat finishes. Call 305.468.8986 for a custom ordering sheet and more detailed specifications.

sku	wattage	color	lumens	replaces	finish
1-CP-SP35W-5K-BK	35	Daylight White 5000K	4550 lm	230W Incandescent/130W HID	black
1-CP-SP40W-5K-BK	40	Daylight White 5000K	4800 lm	240W Incandescent/140W HID	black
1-CP-SP60W-5K-WH	60	Cool White 6500K	7800 lm	390W Incandescent/225W HID	white
1-CP-SP70W-5K-BK	70	Daylight White 5000K	8020 lm	400W Incandescent/235W HID	black
1-CP-SP80W-5K-BK	80	Daylight White 5000K	9600 lm	480W Incandescent/275W HID	black

WH Powder Coat



BK Powder Coat



PF >95

CRI >80



UL Series LED Tri Proof Light



The LUMIPRO UL Series LED Tri Proof Light is resistant against weather, tampering, vibration, corrosion, and pressure. It is the ideal fixture for public areas such as subways, parks, streets, communal and city areas because of its resistance to tampering.

Product Specifications

- UL, cUL, DLC, CE, and RoHS Certifications
- Epistar SMD2835 Chip - Cool White 6000K
- 50,000 hour lifetime
- 180° beam angle distributes light across a wide area
- 100~277VAC Input Voltage
- 120 lm/watt
- High stability isolated driver for increased protection

Construction

- Aluminum construction
- Polycarbonate cover
- 5 year warranty



sku	length	wattage	color	lumens	replaces
1-TP48-50W-UL	4'	50	Cool White 6000K	4500 lm	225W Incandescent/130W HID
1-TP60-60W-UL	5'	60	Cool White 6000K	5400 lm	270W Incandescent/175W HID



TP Series LED Tri Proof Light



The TP Series is built with exactly the same quality control as our UL Series. It is for customers that need weather, tamper, vibration, corrosion, and pressure proof lighting on a budget.

Product Specifications

- CE, and RoHS Certifications
- SMD2835 Chip - Daylight White 5000K
- 50,000 hour lifetime
- 180° beam angle distributes light across a wide area
- 100~277VAC Input Voltage
- 120 lm/watt
- High stability isolated driver for increased protection

Construction

- Aluminum construction
- Polycarbonate cover
- 3 year warranty



sku	wattage	color	lumens	replaces
1-TP48-50W	50	Daylight White 5000K	4600 lm	225W Incandescent/130W HID



12V LED Ground Spot Light

The 12V Series is ideal for outdoor walkways.

Product Specifications

- CE & RoHS Certifications
- Epistar SMD3528 Chip - CW 6000K or DW 4000K
- 12VDC Input Voltage
- 50,000 hour lifetime
- 90 lumen/watt
- 60° beam angle focuses the light onto foliage
- Included ground spike for mounting in soil

Construction

- Aluminum construction
- Polycarbonate cover
- 1 year warranty

sku	wattage	color	lumens	replaces
1-G3W-12V	3	Cool White 6000K	270 lm	13W Incandescent/8W HID
1-G3DW-12V	3	Daylight 4000K	270 lm	13W Incandescent/8W HID
1-G5W-12V	5	Cool White 6000K	450 lm	23W Incandescent/13W HID
1-G5DW-12V	5	Daylight 4000K	450 lm	23W Incandescent/13W HID
1-G7W-12V	7	Cool White 6000K	630 lm	32W Incandescent/18W HID
1-G7DW-12V	7	Daylight 4000K	630 lm	32W Incandescent/18W HID
1-G12W-12V	12	Cool White 6000K	1080 lm	54W Incandescent/31W HID
1-G12DW-12V	12	Daylight 4000K	1080 lm	54W Incandescent/31W HID



Adjustable Head Angle



24V LED Ground Spot Light

Utilizes 24VDC.

Product Specifications

- CE & RoHS Certifications
- Epistar SMD3528 Chip - CW 6000K or DW 4000K
- 24VDC Input Voltage
- 50,000 hour lifetime
- 90 lumen/watt
- 60° beam angle focuses the light onto foliage
- Included ground spike for mounting in soil

Construction

- Aluminum construction
- Polycarbonate cover
- 1 year warranty

Construction

- IP65 sealed waterproof construction
- 1 year warranty

sku	wattage	color	lumens	replaces
1-G7W	7	Cool White 6000K	630 lm	32W Incandescent/18W HID



Ridged Series LED Walkway and Wall Light

Our Ridged Series LED Ground and Wall Lights have been the outdoor lighting of choice for many hotels and restaurants.

Product Specifications

- CE and RoHS Certifications
- Epistar SMD2835 Chip - Cool White 6000K
- 50,000 hour lifetime
- 180° beam angle distributes light across a wide area
- 85~265VAC Input Voltage
- 100 lm/watt

Construction

- Aluminum body construction
- Clear acrylic head
- 1 year warranty



sku	style	wattage	color	lumens	replaces
1-G-A3.5W-14"	ground 14"	3.5	Cool White 6000K	350 lm	18W Incandescent/10W HID
1-G-A3RGB-14"	ground 14"	3	RGB remote control	300 lm	15W Incandescent/10W HID
1-G-A3.5W-26"	ground 26"	3.5	Cool White 6000K	350 lm	18W Incandescent/10W HID
1-G-A3RGB-26"	ground 26"	3	RGB remote control	300 lm	15W Incandescent/10W HID
1-W-A3.5W	wall one-side	3.5	Cool White 6000K	350 lm	18W Incandescent/10W HID
1-W-A3RGB	wall one-side	3	RGB remote control	300 lm	15W Incandescent/10W HID
1-W-A7W	wall two-side	7	Cool White 6000K	700 lm	35W Incandescent/20W HID

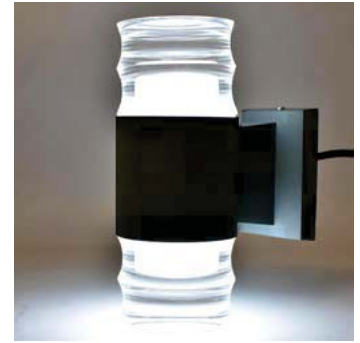

IN ACTION



Bubble Series LED Walkway and Wall Light

The Bubble Series houses air bubbles within

Product Specifications

- CE and RoHS Certifications
- Cool White 6000K or RGB w/ remote control
- 50,000 hour lifetime
- 180° beam angle distributes light across a wide area
- 85~265VAC Input Voltage
- 100 lm/watt
- Ideal for walkways, docks, garden, hotels, restaurants, and more

Construction

- Aluminum body construction
- Clear acrylic head
- 1 year warranty



sku	style	wattage	color	lumens	replaces
1-G-B3RGB-14"	ground 14"	3.5	RGB remote control	350 lm	18W Incandescent/10W HID
1-G-B3RGB-26"	ground 26"	3.5	RGB remote control	350 lm	18W Incandescent/10W HID
1-W-B3.5W	wall one-side	3.5	Cool White 6000K	350 lm	18W Incandescent/10W HID
1-W-B3RGB	wall one-side	3	RGB remote control	300 lm	15W Incandescent/10W HID
1-W-B7W	wall two-side	7	Cool White 6000K	700 lm	35W Incandescent/20W HID



LED Solar Wall Light (W-SL1-W)

Product Specifications

- Motion Sensor & Photocell Dusk-to-Dawn Sensor
- 4 Mode: OFF / LOW / HIGH / AUTO (Sensor Mode)
- Monocrystal Silicone 2W, 5.5V, 370mA
- 36x SMD2835 Chips
- 720 lumens (HIGH) 360 lumens (LOW)
- Sensor Distance: 0-10 meters - Motion On:12s delay
- 120° beam angle
- IP65 water proof
- Internal 2x18650Li-ion(1400mAh) - Total: 2800 mAh
- Charge time until full: 8 hours
- Discharge time (full load): 2 hours



W-SL1-W

LED Solar Wall Light (W-SL2-W)

Product Specifications

- Motion Sensor & Photocell Dusk-to-Dawn Sensor
- 2 Mode: OFF / AUTO (Sensor Mode)
- Monocrystal Silicone 1W, 5.5V, 170mA
- 2x CREE SMD3535 Chips
- Output Power: 240 lumens
- Sensor Distance: 0-8 meters - Motion On:12s delay
- 30° beam angle
- IP65 waterproof
- Internal 1x18650Li-ion(1400mAh)
- Charge time until full: 8 hours
- Discharge time: 2.59 hours



W-SL2-W

Security Cam. Light (W-B-SR1-W)

Product Specifications

- Battery operated w/ 4x AA batteries
- Motion Sensor
- 6x F5 Chips
- Output power: 50 lumens
- Sensor Angle: 120°
- Motion On:22s delay
- 30° beam angle
- IP44 waterproof

SOLAR OPERATED

sku	color	lumens
W-SL1-W	Cool White 6000K	720 lm
W-SL2-W	Cool White 6000K	240 lm

White Aimable Light (W-B-SR3-W)

Product Specifications

- Battery operated w/ 4x AA batteries
- Motion Sensor
- 1x SMD5730 Chips
- Output power: 55 lumens
- Sensor Distance: 0-5M 120°
- Motion On:22s delay
- 30° beam angle
- IP44 waterproof

BATTERY OPERATED

sku	color	lumens
W-B-SR1-W	Cool White 6000K	720 lm
W-B-SR2-W	Cool White 6000K	240 lm
W-B-SR3-W	Cool White 6000K	55 lm



PF >90 CRI >80 IP67

W-B-SR1-W



W-B-SR2-W



W-B-SR3-W

LED Wall Step Lights

No outdoor patio or stairs should be without step lighting. They illuminate at night, offer step visibility, and increased home appeal.

- CE & RoHS certifications
- Different styles and sizes
- Cool White 6000K
- 1 year warranty



1-WS4x2-2W

1-WS4x2-2W/A

1-WS6.5x2.5-3W

1-WS6x6-5W

1-WS7x2.5-3W

1-WS9x5-5W

wattage	dimensions	color	lumens
1-WS4x2-2W	4" x 2"	Cool White 6000K	180 lm
1-WS4x2-2W/A	4" x 2"	Cool White 6000K	180 lm
1-WS6.5x2.5-3W	6.5" x 2.5"	Cool White 6000K	270 lm
1-WS6x6-5W	6" x 6"	Cool White 6000K	450 lm
1-WS7x2.5-3W	7" x 2.5"	Cool White 6000K	270 lm
1-WS9x5-5W	9" x 5"	Cool White 6000K	450 lm

LED Under Water Spot Lights

LED Under Water Spot Light

Submersible lights with available waterproof connectors for long connections.

Product Specifications

- CE and RoHS Certifications
- Cool White 6000K
- 50,000 hour lifetime
- 60° beam angle
- 24VDC Input Voltage
- 100 lm/watt
- Ideal for underwater lighting

Construction

- Stainless steel construction w/ interior rubber seal
- 1 year warranty



sku	wattage	color	lumens	replaces
1-G9W	9	Cool White 6000K	810 lm	40W Incandescent/25W HID



PF > 90 CRI > 80 IP67



LED Pool Light

Submersible; waterproof connector needed for long connections

Product Specifications

- CE and RoHS Certifications
- RGB w/ remote control
- 50,000 hour lifetime
- 60° beam angle
- 24V AC/DC Input Voltage
- 100 lm/watt
- Ideal for underwater lighting

Construction

- Stainless steel construction w/ rubber seals
- 1 year warranty



sku	wattage	color	lumens	replaces
1-SW24RGB	24	RGBw/ remote control	2400 lm	100W Incandescent/70W HID



PF > 90 CRI > 80 IP67



Under Water 3 Pin Connector

IP67 sealed. Allows for underwater connection and cable extensions.

sku
E-CON-Tube



DMP5 Series LED Security Light

Dual head motion sensor and photocell dusk-to-dawn security lighting.

Product Specifications

- ETL, CE, and RoHS Certified
- Motion sensor detects motion up to 70 ft away and 180°
- Photocell sensor enables dusk-to-dawn operation
- Daylight White 5000K
- Osram LED chips
- 50,000 hour lifetime
- Recommended mounting: up to 16ft

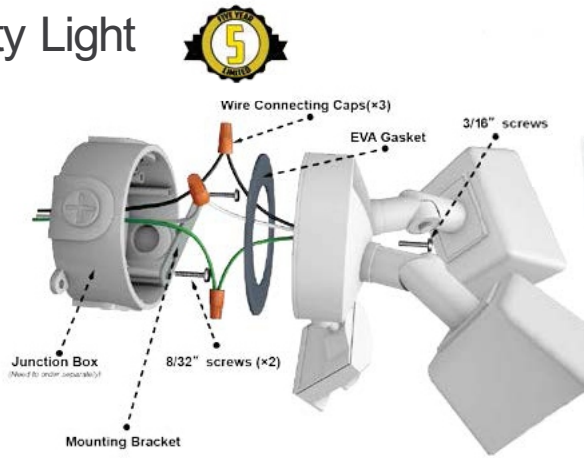

We can manufacture CCT (3000K~6000K) and white or slate grey thermoset color finishes. Call 305.468.8986 for a custom ordering sheet and more detailed specifications.

sku	wattage	color	lumens	replaces
1-SL-DMP5-5K-20W-WH	20	Daylight White 5000K	1800 lm	100W Incandescent/70W HID



LED Underground Lights

LED Underground Light

Insert into floor cutouts to seamlessly create lighting that illuminates from the ground.

Product Specifications

- CE and RoHS certified
- A wide variety of brightness and sizes
- 35° beam angle
- IP67 waterproof
- 50,000 hour lifetime
- 1 year warranty



Dragonfly Izakaya & Fish Market in Doral, FL



sku	wattage	color	lumens	replaces	input voltage	diameter	shape
1-UG1W	1	Cool White 6000K	90 lm	4.5W Incandescent/3W HID	12VDC	2.6"	round
1-UG1DW	1	Daylight White 4000K	90 lm	4.5W Incandescent/3W HID	12VDC	2.6"	round
1-UG3W	3	Cool White 6000K	270 lm	14.5W Incandescent/9W HID	12VDC	4"	round
1-UG3G	3	Green	270 lm	14.5W Incandescent/9W HID	24VDC/AC	4"	round
1-UG3RGB	3	RGB	270 lm	14.5W Incandescent/9W HID	24VAC	4"	round
1-UG6W	6	Cool White 6000K	530 lm	26.5W Incandescent/18W HID	24VDC/AC	5.9"	round
1-UG6DW	6	Daylight White 4000K	530 lm	26.5W Incandescent/18W HID	12VDC	5.9"	round
1-UG6G	6	Green	530 lm	26.5W Incandescent/18W HID	24VDC/AC	5.9"	round
1-UG6RGB	6	RGB	530 lm	26.5W Incandescent/18W HID	24VAC	4.7"	round
1-UG9W	9	Cool White 6000K	810 lm	40.5W Incandescent/27W HID	24VDC/AC	7"	round
1-UG9DW	9	Daylight White 4000K	810 lm	40.5W Incandescent/27W HID	24VDC/AC	5.9"	round
1-UG9G	9	Green	810 lm	40.5W Incandescent/27W HID	24VDC	7"	round
1-UG9RGB	9	RGB	810 lm	40.5W Incandescent/27W HID	24VAC	7"	round
1-UG12W	12	Cool White 6000K	1180 lm	59W Incandescent/40W HID	24VDC	7"	round
1-UG12W-S	12	Cool White 6000K	1180 lm	59W Incandescent/40W HID	12VDC	7.5"	square
1-UG12WW-S	12	Daylight White 4000K	1180 lm	59W Incandescent/40W HID	12VDC	7.5"	square
1-UG12RGB	12	RGB	1180 lm	59W Incandescent/40W HID	24VAC	7"	round
1-UG15W	15	Cool White 6000K	1350 lm	67.5W Incandescent/45W HID	24VDC	7.9"	round
1-UG15DW	15	Daylight White 4000K	1350 lm	67.5W Incandescent/45W HID	24VDC	7.9"	round
1-UG24W	24	Cool White 6000K	2160 lm	108W Incandescent/72W HID	24VDC	8.7"	round
1-UG24DW	24	Daylight White 4000K	2160 lm	108W Incandescent/72W HID	24VDC	8.7"	round



ETL Series LED Rope Light **LUMIPRO**

The ETL Series is ideal for outdoor accent lighting.

Product Specifications

- ETL, CE, and RoHS Certifications
- SMD2835/5730 Chip - 12lm-18lm per chip
- 80,000 hour lifetime
- 180° beam angle
- 120VAC Input Voltage
- 132 lumen/watt
- Isolated waterproof driver

Construction

- IP65 rated for waterproofing
- Can be cut every 20"(1/2 meter)
- Sold by the meter (3.2 ft)
- 50 meters per roll
- 2 year warranty



sku	color	lumens/ meter	watt usage	dimensions
M-H-28-60-W-ETL	Cool White 6000K	720 lm/m	6.5w/m	W:15mm D:8mm
M-H-28-72-BL-ETL	Blue	860 lm/m	6.5w/m	W:15mm D:8mm
M-H-28-72-W-ETL	Cool White 6000K	860 lm/m	6.5w/m	W:15mm D:8mm
M-H-57-60-W-ETL	Cool White 6000K	1080 lm/m	8w/m	W:15mm D:8mm

sku	description	retail price	sku	description
M-H-Cap	end cap	\$4.80	M-H-Cnt-90°	90° corner conn.
M-H-Clip	wall mount clip	\$2.40	M-H-Cnt-I	two end conn.
M-H-Cnt-4"	4" two-end conn.	\$0.90	M-H-Pin	connection pin
M-H-Cord	5 ft power cord - pin included			



M-H-Cap



M-H-Clip



M-H-Cnt-90°



M-H-Cnt-I



M-H-Cnt-4"



M-H-Cord & Pin

HL Series LED Rope Light **LUMIPRO**

The HL Series is ideal for brighter outdoor applications such as general purpose or building lights.

Product Specifications

- CE and RoHS Certifications
- SMD5050/5730 Chip - 20lm or 38lm per chip
- 50,000 hour lifetime
- 180° beam angle
- 120VAC Input Voltage
- 150 or 380 lumen/watt
- Isolated waterproof driver
- High power chips produce a glow ideal for architectural, building, and indirect lighting

Construction

- IP65 rated for waterproofing
- Can be cut every 20"(1/2 meter)
- Sold by the meter (3.2 ft)
- 50 meters per roll
- 1 year warranty



sku	color	lumens/ meter	watt usage	dimensions
M-HL-50-60-BL	Blue	1200 lm/m	8w/m	W:15mm D:8mm
M-HL-50-60-R	Red	1200 lm/m	8w/m	W:15mm D:8mm
M-HL-50-60-RGB	RGB	1200 lm/m	8w/m	W:15mm D:8mm
M-HL-50-60-W	Cool White 6000K	1200 lm/m	8w/m	W:15mm D:8mm
M-HL-50-60-WW	Warm White 3000K	1200 lm/m	8w/m	W:15mm D:8mm
M-HL-50-60-Y	Yellow	1200 lm/m	8w/m	W:15mm D:8mm
M-HL-57-120-W	Cool White 6000K	4560 lm/m	12w/m	W:18mm D:8mm
M-HL-57-120-WW	Warm White 3000K	4560 lm/m	12w/m	W:18mm D:8mm

sku	description	retail price	sku	description
M-HL-Cap	waterproof end cap	\$4.80	M-HL-CON-90°	90° corner conn.
M-HL-Clip	wall mount clip	\$17.95	M-HL-50-60-RGB/RC	RGB controller w/ remote
M-HL-57-Cnt	straight connector	\$2.40	M-HL-50-Cnt	straight connector
M-HL-57-Cord	20" power cord	\$4.50	M-HL-50-Cord	20" power cord
M-HL-57-PIN	connection pin	\$0.60	M-HL-50-PIN	connection pin



Neon Series LED Rope Light **LUMIPRO**

Imitating the look of neon tubes with LED technology



Product Specifications

- ETL, CE, and RoHS Certifications
- SMD5050- 18-20lm per chip
- 80,000 Lifetime Hours
- 120VAC Input Voltage
- Isolated waterproof driver

Construction

- IP65 rated for waterproofing
- Can be cut every 18" (1/2 yard)
- Sold by the yard (3 ft)
- 50 yards (150 ft) per roll
- 2 year warranty

sku	color	watt usage	dimensions
M-N11-120-BL	465 nm Blue	8w/yard	W:10.5mm D:18mm
M-N11-120-G	520 nm Green	8w/yard	W:10.5mm D:18mm
M-N11-120-R	625 nm Red	8w/yard	W:10.5mm D:18mm
M-N11-120-W	Cool White 6000K	8w/yard	W:10.5mm D:18mm
M-N11-120-Y	590 nm Yellow	8w/yard	W:10.5mm D:18mm
M-N15-120-BL	625 nm Blue	8w/yard	W:15mm D:26mm
M-N15-120-G	520 nm Green	8w/yard	W:15mm D:26mm
M-N15-120-R	625 nm Red	8w/yard	W:15mm D:26mm
M-N15-120-W	Cool White 6000K	8w/yard	W:15mm D:26mm
M-N15-120-Y	590 nm Yellow	8w/yard	W:15mm D:26mm



sku	description	retail price	sku	description
M-N11-Cap	waterproof end cap	\$0.36	M-N15-Cap	waterproof end cap
M-N11-Ch	wall mount channel	\$6.00	M-N15-Ch	40" clip wall mount
M-N11-Clip	wall mount clip	\$0.42	M-N15-Clip	wall mount clip
M-N11-Cnt-I	two-end conn.	\$1.50	M-N15-Cnt	two-end conn.
M-N11-Cnt-4"	8" two-end conn.	\$3.60	M-N15-Cnt-8"	8" two-end conn.
M-N11-Cord	5 ft power cord	\$10.80	M-N15-Cord	5 ft power cord
M-N11-Pin	connection pin	\$0.60	M-N15-Pin	connection pin

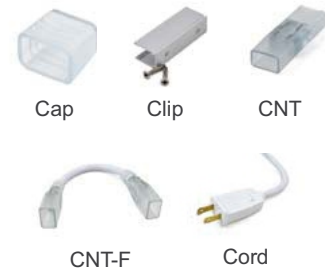

Neon LED Rope Lights illuminate and bring eyes to your business during the daytime and nighttime. They imitate the bright even glow of neon with LED technology for a more energy efficient lighting solution. Neon Rope Installed in

IP67 Silicone Sealed Strip Light

Product Specifications

- Sold in 5 meter (16.2 ft) rolls
- IP67 rated with silicone cover able to withstand submersion for up to 30 minutes no less than 1 meter deep
- Included adhesive backing for easy tape-like installation
- Can be cut every 2" or 3rd chip
- Tight LED pitch (space between chips) creates uniform lighting
- 1 year warranty



sku	color	lumens/ meter	chips/ meter	watt usage	input voltage	dimensions
SMD5050 - 20lm per chip - 17mm led pitch						
M-50-60-WW	Warm White 3000K	1200 lm	60	14.4w/m	12vdc	W:10mm H:2mm
M-50-60-W-UL	Cool White 6000K	1200 lm	60	14.4w/m	12vdc	W:10mm H:2mm
M-50-60-W	Cool White 6000K	1200 lm	60	14.4w/m	12vdc	W:10mm H:2mm
M-50-60-RGB-UL	RGB	1200 lm	60	14.4w/m	12vdc	W:10mm H:2mm
M-50-60-RGB	RGB	1200 lm	60	14.4w/m	12vdc	W:10mm H:2mm
M-50-60-R	Red	1200 lm	60	14.4w/m	12vdc	W:10mm H:2mm
M-50-60-G	Green	1200 lm	60	14.4w/m	12vdc	W:10mm H:2mm
M-50-60-BL	Blue	1200 lm	60	14.4w/m	12vdc	W:10mm H:2mm
SMD3528 - 8 lm per chip - 8mm led pitch						
M-35-60-Y	Yellow	480 lm	60	4.8w/m	12vdc	W:10mm H:2mm
M-35-60-WW	Warm White 3000K	480 lm	60	4.8w/m	12vdc	W:10mm H:2mm
M-35-60-W	Cool White 6000K	480 lm	60	4.8w/m	12vdc	W:10mm H:2mm
M-35-60-R	Red	480 lm	60	4.8w/m	12vdc	W:10mm H:2mm
M-35-60-G	Green	480 lm	60	4.8w/m	12vdc	W:10mm H:2mm
M-35-60-B	Blue	480 lm	60	4.8w/m	12vdc	W:10mm H:2mm
M-35-120-Y	Yellow	960 lm	120	9.6w/m	12vdc	W:10mm H:2mm
M-35-120-WW	Warm White 3000K	960 lm	120	9.6w/m	12vdc	W:10mm H:2mm
M-35-120-W	Cool White 6000K	960 lm	120	9.6w/m	12vdc	W:10mm H:2mm
M-35-120-R	Red	960 lm	120	9.6w/m	12vdc	W:10mm H:2mm
M-35-120-G	Green	960 lm	120	9.6w/m	12vdc	W:10mm H:2mm
M-35-120-B	Blue	960 lm	120	9.6w/m	12vdc	W:10mm H:2mm



Remove traditional fixtures in exchange for strip lighting

PF >90 CRI >80



IP67 rated strip lights come with tape backing. They are waterproof and simultaneously create a vibrant atmosphere for restaurants, bars, car accents and stores by giving lighting where no other fixture can reach.

IP68 Submersible LED Strip Light

Product Specifications

- Sold in 5 meter (16.2 ft) rolls
- IP68 rated with full 360° silicone cover around strip and connections can be submerged indefinitely
- Can be cut every 2" or 3rd chip
- Waterproof connector allows underwater connections
- Dimmable with a dimmer controller, RGB strip can be used with RGB controller to adjust between 16,777,216 colors
- Comes with 12 wall clips and mounting screws
- Tight LED pitch (space between chips) creates uniform lighting
- 1 year warranty



IP68 waterproof connector designed for underwater use

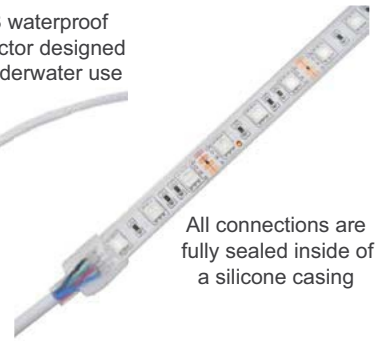

All connections are fully sealed inside of a silicone casing

sku	color	lumens/ meter	chips/ meter	watt usage	input voltage	dimensions
SMD5050 - 20lm per chip - 17mm led pitch						
M-50S-60-WW	Warm White 3000K	1200 lm	60	14.4w/m	12vdc	W:12mm H:4mm
M-50S-60-W	Cool White 6000K	1200 lm	60	14.4w/m	12vdc	W:12mm H:4mm
M-50S-60-RGB	RGB	1200 lm	60	14.4w/m	12vdc	W:12mm H:4mm
M-50S-60-R	Red	1200 lm	60	14.4w/m	12vdc	W:12mm H:4mm
M-50S-60-G	Green	1200 lm	60	14.4w/m	12vdc	W:12mm H:4mm
M-50S-60-BL	Blue	1200 lm	60	14.4w/m	12vdc	W:12mm H:4mm
SMD3528 - 8 lm per chip - 8mm led pitch						
M-35S-60-WW	Warm White 3000K	480 lm	60	4.8w/m	12vdc	W:10mm H:4mm
M-35S-60-R	Red	480 lm	60	4.8w/m	12vdc	W:10mm H:4mm
M-35S-60-G	Green	480 lm	60	4.8w/m	12vdc	W:10mm H:4mm
M-35S-60-BL	Blue	480 lm	60	4.8w/m	12vdc	W:10mm H:4mm
M-35S-120-Y	Yellow	960 lm	120	9.6w/m	12vdc	W:10mm H:4mm
M-35S-120-WW	Warm White 3000K	960 lm	120	9.6w/m	12vdc	W:10mm H:4mm
M-35S-120-W	Cool White 6000K	960 lm	120	9.6w/m	12vdc	W:10mm H:4mm
M-35S-120-R	Red	960 lm	120	9.6w/m	12vdc	W:10mm H:4mm
M-35S-120-G	Green	960 lm	120	9.6w/m	12vdc	W:10mm H:4mm
M-35S-120-BL	Blue	960 lm	120	9.6w/m	12vdc	W:10mm H:4mm
Chasing LED Strip - SMD5050 - 20 lm per chip						
M-54S-CH	RGB+Chasing	1200 lm	60	14.4w/m	12vdc	



IP68 lighting is ideal for pool edge lighting









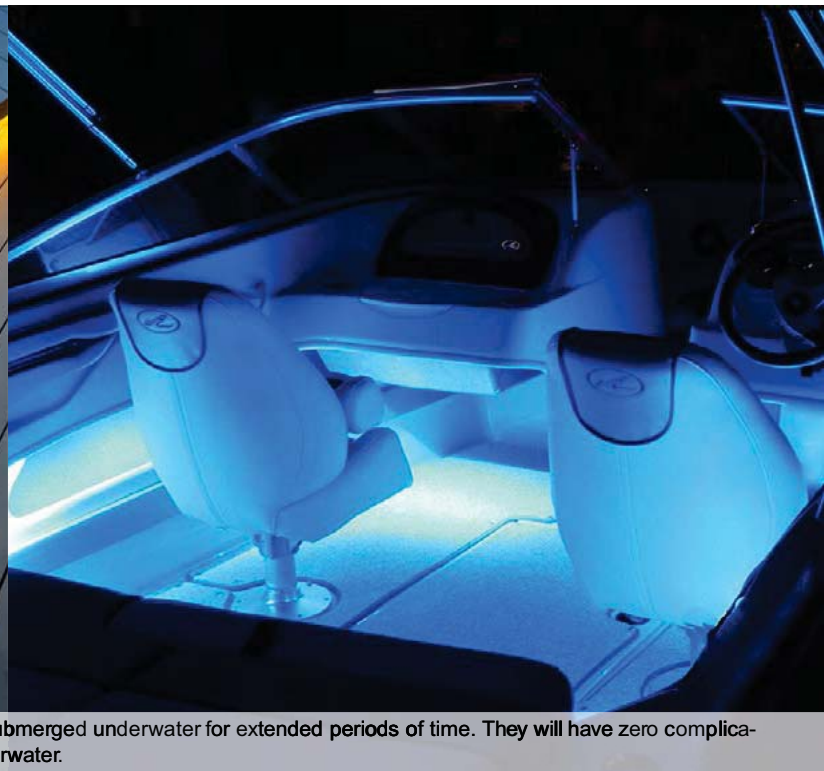
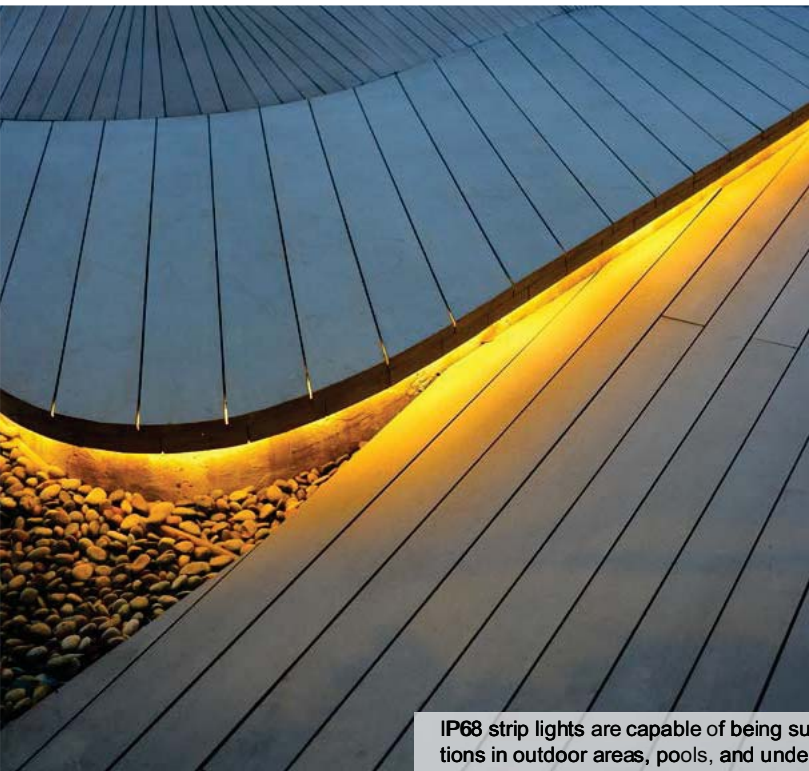

IP68 strip lights are capable of being submerged underwater for extended periods of time. They will have zero complications in outdoor areas, pools, and underwater.

5730 Series Ultra Bright LED Modules

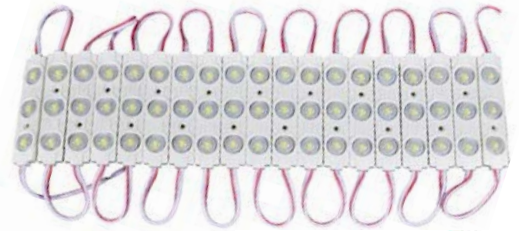

Product Specifications

- SMD5730 high output chips output 40lm per chip
- IP 65~67 rating allows for submersion up to 1m deep
- Ideal for signage, channel letters, landscape, patio, display, and showcase applications
- 12VDC input voltage
- One-piece PVC injected shell for high precision water-tight capability
- Sold in segments of 20 pcs (10 ft when stretched out)

sku	color	lumens/module	chips/module	watt usage	IP Rating	input voltage	dimensions L x W
SMD5730 - UL Listed - 5 year warranty							
7-57x3W-UL-L	Cool White 6500K	110 lm	3x SMD5730	1.32W	IP65	12VDC	3" x 0.6"
7-57x3W-UL-HM	Cool White 9000K	125 lm	3x SMD5730	1.2W	IP65	12VDC	3" x 0.6"
7-57x3R-UL-HM	Red	125 lm	3x SMD5730	0.72W	IP65	12VDC	3" x 0.6"
SMD5730 - 3 year warranty							
7-57x3W	Cool White 6500K	125 lm	3x SMD5730	0.84W	IP67	12VDC	2.5" x 0.6"
7-57x3W/AK	Cool White 6500K	110 lm	3x SMD5730	0.72W	IP67	12VDC	3" x 0.6"
7-57x3R/AK	Red	110 lm	3x SMD5730	0.72W	IP67	12VDC	3" x 0.6"
7-57x3G	Green	110 lm	3x SMD5730	0.72W	IP67	12VDC	3" x 0.6"
7-57x3BL	Blue	110 lm	3x SMD5730	0.72W	IP67	12VDC	3" x 0.6"
7-57x3Y	Yellow	110 lm	3x SMD5730	0.72W	IP67	12VDC	3" x 0.6"
7-56Cx3W/AK	Cool White 6500K	50 lm	3x SMD5630	0.72W	IP67	12VDC	3" x 0.6"



7-57x3W-UL-L



7-57x3W



7-57x3G



7-57x3R/AK



7-57x3W/AK



5050 Series LED Modules



Product Specifications

- SMD5050 chips output 22lm per chip
- IP 65~67 rating allows for submersion up to 1m deep
- Ideal for signage, channel letters, landscape, patio, display, and showcase applications
- 12VDC input voltage
- One-piece PVC injected shell for high precision water-tight capability
- Sold in segments of 20 pcs (10 ft when stretched out)

sku	color	lumens/module	chips/module	watt usage	IP Rating	input voltage	dimensions L x W
SMD5050 - UL Listed - 5 year warranty							
7-50x3B-UL	Blue	60 lm	3x SMD5050	0.72W	IP67	12VDC	3" x 0.6"
7-50x2W-UL-HM	Cool White 6500K	40 lm	2x SMD5050	0.5W	IP67	12VDC	1.75" x 0.4"
7-50x2W-UL	Cool White 6500K	40 lm	2x SMD5050	0.5W	IP67	12VDC	2.75" x 0.6"
7-50x2R-UL-HM	Red	40 lm	2x SMD5050	0.5W	IP67	12VDC	1.75" x 0.4"
7-50x2B-UL-HM	Blue	40 lm	2x SMD5050	0.5W	IP67	12VDC	1.75" x 0.4"
SMD5050 - 3 year warranty							
7-50x3RGB/AK	RGB	60 lm	3x SMD5050	0.72W	IP67	12VDC	2.25" x 0.75"
7-50x3B/AK	Blue	60 lm	1x SMD5050	0.72W	IP67	12VDC	3" x 0.6"



7-50x3RGB/AK



7-50x2B(UL)HM



7-50x2W(UL)HM



RSL Series LED Lightbox Modules



Product Specifications

- Designed for side lit slim light boxes
- 30°-65° beam angle - place several inches behind fabric/acrylic to create an even glow lighting for both sides
- Cool White 8000K CCT gives off a pure white giving extremely vivid colors to signs



sku	color	lumens/ fixture	chips/ module	watt usage	IP Rating	input voltage	beam angle	dimensions L x W
Rigid Strips - 3 year warranty								
7-RSL40"/12V/27W	Cool White 8000K	3240 lm	18x SMD3030	27W	IP65	12VDC	30°	40" x 1" x 5/8"
7-RSL20"/12V/13.5W	Cool White 8000K	1620 lm	9x SMD3030	13.5W	IP65	12VDC	30°	20" x 1" x 5/8"
Single Modules - 3 year warranty								
7-RSL-12V/1.5W	Cool White 8000K	180 lm	1x SMD3030	1.5W	IP65	12VDC	65°	1.75" x 1.25"



PF >90 CRI >80 IP67



LED Channel Letters are illuminated with modules placed on the inside. Different sizes are used for different brightness levels.



Slim side lit light boxes need to be illuminated from the sides. For that, you need a high-power strip with a tight beam angle to direct light forward. RSL Series.

Mini LED Modules



Product Specifications

- Designed for LED channel letters
- Wide beam angle ideal for inside channel letters, placement in center of lightbox facing outward, and even glow lighting

sku	color	lumens/ fixture	chips/ module	watt usage	IP Rating	input voltage	beam angle	dimensions L x W
7-28x1W-UL	Cool White 6500K	44 lm	1x SMD2835	0.4W	IP65	12VDC	170°	1.5" x 0.6"
7-30x1W-UL	Cool White 6500K	125 lm	1x SMD3030	1.32W	IP65	12VDC	160°	1.5" x 1"
7-28x2W	Cool White 6500K	40 lm	2x SMD2835	0.24W	IP65	12VDC	180°	1" x 0.2"
7-35x3W-UL	Cool White 6500K	18 lm	3x SMD3528	0.24W	IP65	12VDC	180°	3" x 0.5"



7-28x1W-UL



7-30x1W-UL



7-28x2W



PF >90 CRI >80 IP67

IP67 Silicone Sealed Power Supply

Product Specifications

- Full aluminum construction prevents rust
- Short circuit/overload/over voltage protection, withstands 300VAC surge input for 5 seconds

- UL1310 Class 2 power supply, passes LPS
- 100% full load burn-in test
- 1 year warranty

sku	supplies up to	input voltage	output voltage	output current
P-S5	5 watts	110 VAC	12 VDC	0.41A
P-S15	15 watts	110~250 VAC	12 VDC	1.25A
P-S35	35 watts	110~240 VAC	12 VDC	2.91A
P-S50	50 watts	110 VAC	12 VDC	4.17A
P-S60	60 watts	110 VAC	12 VDC	5.00A
P-S60-24	60 watts	110 VAC	24 VDC	2.50A
P-S80	80 watts	110 VAC	12 VDC	5.00A
P-S100	100 watts	110 VAC	12 VDC	8.33A
P-S100-24	100 watts	110 VAC	24 VDC	4.16A
P-S150	150 watts	110 VAC	12 VDC	12.50A
P-S150-24	150 watts	110 VAC	24 VDC	12.50A
P-S200	200 watts	110 VAC	12 VDC	16.60A
P-S200-24	200 watts	110 VAC	24 VDC	8.33A



UL Listed - Suitable for Wet Location				
P-S20-UL	20 watts	110 VAC	12 VDC	1.66A
P-S25-UL	25 watts	110 VAC	12 VDC	2.40A
P-S30-5-UL	30 watts	110 VAC	5 VDC	6.00A
P-S30-UL	30 watts	110 VAC	12 VDC	2.40A
P-S35-UL	35 watts	110 VAC	12 VDC	2.91A
P-S60-24-UL	60 watts	100-277 VAC	24 VDC	2.50A
P-S60-5-UL	60 watts	110 VAC	5 VDC	5.00A
P-S60-UL	60 watts	110 VAC	12 VDC	5.00A
P-S60-DIM-UL	60 watts	110 VAC	12 VDC	5.00A
P-SUL60-P	60 watts	110 VAC	12 VDC	5.00A
P-S100-24-UL	100 watts	110 VAC	24 VDC	4.16A
P-S100-UL	100 watts	110 VAC	12 VDC	8.33A
P-S120-UL	120 watts	110 VAC	12 VDC	10.00A
P-S150-UL	150 watts	110 VAC	12 VDC	12.50A
P-S200-24-UL	200 watts	110 VAC	24 VDC	8.33A
P-S200-UL	200 watts	110 VAC	12 VDC	16.70A

IP44 Rainproof Power Supply

Product Specifications

- Full aluminum construction with air vents facing downwards
- Resistant to rain when installed vertically against the wall
- 1 year warranty

sku	supplies up to	input voltage	output voltage	output current
P-FS50	50 watts	100-120 VAC	12 VDC	4.20A
P-FS100	100 watts	100-120 VAC	12 VDC	8.33A
P-FS150	150 watts	110-220 VAC	12 VDC	12.5A
P-FS200	200 watts	100-120 VAC	12 VDC	16.66A
P-FS250	250 watts	110-220 VAC	12 VDC	20.83A
P-FS250-24	250 watts	110-220 VAC	24 VDC	20.83A
P-FS360	360 watts	110-220 VAC	12 VDC	30.00A
P-FS400	400 watts	110-220 VAC	12 VDC	33.30A
P-FS400-24	400 watts	110-220 VAC	24 VDC	16.66A
P-FS500	500 watts	110-220 VAC	12 VDC	41.66A
P-FS500-24	500 watts	110-220 VAC	24 VDC	20.83A



LED Wall Washer

Product Specifications

- RGB or Cool White 6000K
- 85~277 VAC Input Voltage
- IP65 rated for waterproofing
- 30° beam angle floods the wall effectively
- 1 year warranty



Universal mounting brackets allow for mounting anywhere



The 1-WW36RGB can be adjusted using a remote control to switch among 16 different colors, 4 modes, brightness level, and on or off



Tight 30° beam angle with sealed waterproof lens

sku	color	wattage	lumens	dimensions
1-WW18W	Cool White 6000K	18	1920	20" x 2"x 2"
1-WW24W	Cool White 6000K	24	2560	40" x 2"x 2"
1-WW36W	Cool White 6000K	36	3840	40" x 2"x 2"
RGB Enabled				
1-WW12RGB	RGB - self changing	12	1920	20" x 2"x 2"
1-WW24RGB	RGB - self changing	24	2560	40" x 2"x 2"
1-WW36RGB	RGB remote controlled	36	3840	40" x 2"x 2"



PF >90

CRI >80



LED Wall Washers coat a wall with vivid colors as if painted throughout the night. Ideal for landmarks, accent lighting, business events, and more





Apply for wholesaler pricing on our website

ADDSOLARELECTRICAL LLC
ENERGY SOLUTION

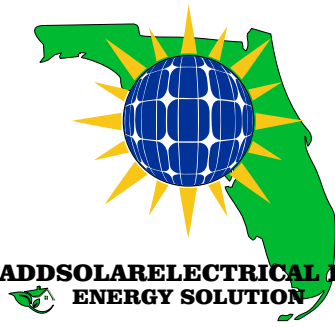

Same day local delivery or immediate pickup

Add Solar & Electrical LLC Authorized LED Lighting Distributor LS-1 Certified Lights Expert 786-312-2895

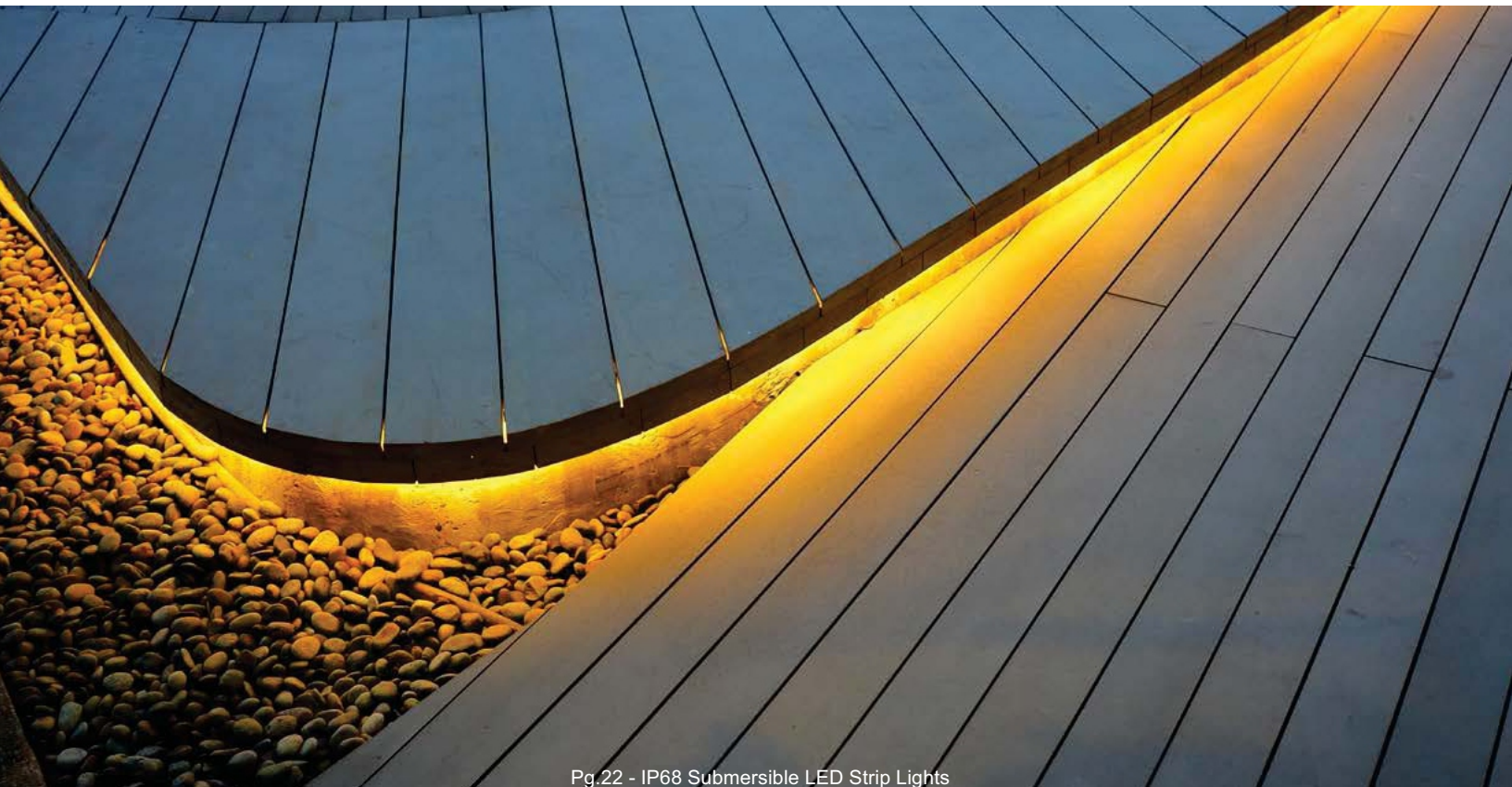

Pg.22 - IP68 Submersible LED Strip Lights

Page Index

LED Area & Roadway Lights	1-6	LED Wall Step Lights	17
LED Flood Lights	1-2, 7-9	LED Under Water Spot Lights	17
LED Light Poles	10	LED Security Lights	18
LED Wallpacks	11	LED Underground Lights	18
LED Canopy Lights	12	LED Flexible Rope/Neon Lights	19-20
LED Tube Lights	13	LED Strip Lights	21-22
LED Ground Lights	14-15	LED Outdoor Modules	23-24
LED Wall Lights	15-16	Outdoor Power Supplies	25
LED Motion Sensor/Solar Lights	16	LED Wall Washers	26