

{Table of Contents}

Tie Down Engineering8-27	AMERICAN FIBERGLASS66-68
Specialty Anchors..... 9-10	KINRO SHOWER & TUB69
Soil/Anchor Classification Chart 11	PHOENIX FAUCETS70-73
Stabilizer Plates..... 12	FAUCETS74-75
Straps & Hardware..... 13-15	FAUCET PARTS & ACCESSORIES76-77
Sidewall Brackets..... 16	SHOWER & TUB ACCESSORIES78-79
Electric Drive Machine & Soil Test Probe 17	JG SPEEDFIT80-81
ABS Foundation Pads 18	FLAIR-IT82-83
Vector Systems..... 19-20	ABS PIPE & FITTINGS84-85
Xi2 Ground and Foundation Systems 21-23	PVC/DWV PIPE & FITTINGS86-87
Finishing Products..... 24	PVC PIPE & FITTINGS88
Transportation & Towing Products..... 25	CPVC PIPE & FITTINGS.....89
Axel Components 26	PIPE CEMENT90-91
Wheel Components..... 27	TOILETS & TOILET PARTS92-93
SET-UP & TOWING ACCESSORIES28-29	SINKS & SINK PARTS.....94
SKIRTING & ACCESSORIES.....30-34	PLUMBING SUPPLIES.....95
Variform 30	ELECTRICAL & WIRING SUPPLIES.....96-99
Materials Calculation for Variform Calculation..... 31	Breakers, Breaker Boxes, Wiring..... 96
EverRock..... 32	Flex Conduit, Electrical Tape, Ground Rod, Conduit PVC & Fittings, Receptacles, Cords, Switch Plates..... 97
Accessories..... 33-34	Wall Plates, Receptacles, Light Shades, Light Fixtures.... 98
ELIXIR DOORS & ACCESSORIES35-48	Light Fixtures and Shade, Finial Cap, Switch Plate Covers, Porch Light Fixtures & Hardware..... 99
Diamond & Fan-Lite Combo Entry Doors (6000 Series)..... 35	HARDWARE & SEALANTS.....100-107
Blank Combo Door with Knocker Viewer (6000 Series)..... 36	Roof Coatings, Roofing Brushes..... 100-101
6-Panel Vinyl Steel Combo Entry Doors (9000 Series)..... 37	Screws, Lag Bolts, Nails..... 102
7000 Series Combo Entry Doors..... 37	Roof & Carpet Nails, Washers, Nashua & Fason Tape ... 103
Cottage & Fan-Lite Combo Entry Doors (9000 Series)..... 38	Flex-Mend, Bottom Board, Peel & Seal..... 104
3/4 Oval Combo Entry Doors (9000 Series)..... 39	Sta'-Put Spray, Pipe Insulation, Foam Sealants, KILZ, Storm Patch, Antifreeze 105
Full Oval Combo Doors (7000 Series)..... 40	BOSS Spray, WD-40, Kwik Seal, HVAC/R Sealant, Caulk, Liquid Nails, Caulk Gun..... 106
6-Panel Vinyl Steel Combo Entry Doors (7000 Series)..... 40	Clear Caulk, Utility Knife, Contractor Trash Bags, Hacksaw, Bits, Nutsetter, Cleaning Wipes..... 107
Diamond & Blank Outswing Doors (200 Series)..... 41	RANGE HOODS & VENTS108-109
Cottage Outswing Doors (200 Series) 42	SAFETY & APPLIANCE ACCESSORIES110-111
Fan Outswing Doors (200 Series) 42	THERMOSTATS.....112-113
Blank & Double Outswing Doors (200 Series) 43	WATER HEATERS & PARTS114
Fan & Cottage Steel Outswing Doors..... 44	DISPOSABLE AIR FILTERS.....115
Slider Outswing Doors (300 Series)..... 43	DUCTING ACCESSORIES116-117
6-Panel Steel Outswing Doors (300 Series)..... 43	PORTABLE STEPS & DIMPLEX118-119
3/4 Oval Steel Outswing Doors (300 Series)..... 45	
Storm Doors & Outswing French Doors..... 46	
Door Parts & Accessories..... 47-48	
INTERIOR DOORS & MOLDING.....49-51	
DOOR LOCKS & ACCESSORIES52-54	
KINRO WINDOWS55-60	
Horizontal Slider Window..... 55	
Sliding Glass Patio Doors 56	
Vinyl Windows..... 57	
Metal Windows..... 58-59	
Replacement Screens..... 60	
POCAHONTAS61-63	
Metal Windows..... 61-62	
Replacement Screens & Vinyl Windows 63	
WINDOW ACCESSORIES64-65	

Earth Anchors



Manufactured housing ground anchors listed on the next two pages are tested to HUD Regulation 3280 to withstand a working load of 3,150 lbs. and ultimate load of 4,725 lbs. in their tested soil class. All are listed and labeled with RADCO, a nationally recognized DAPIA.

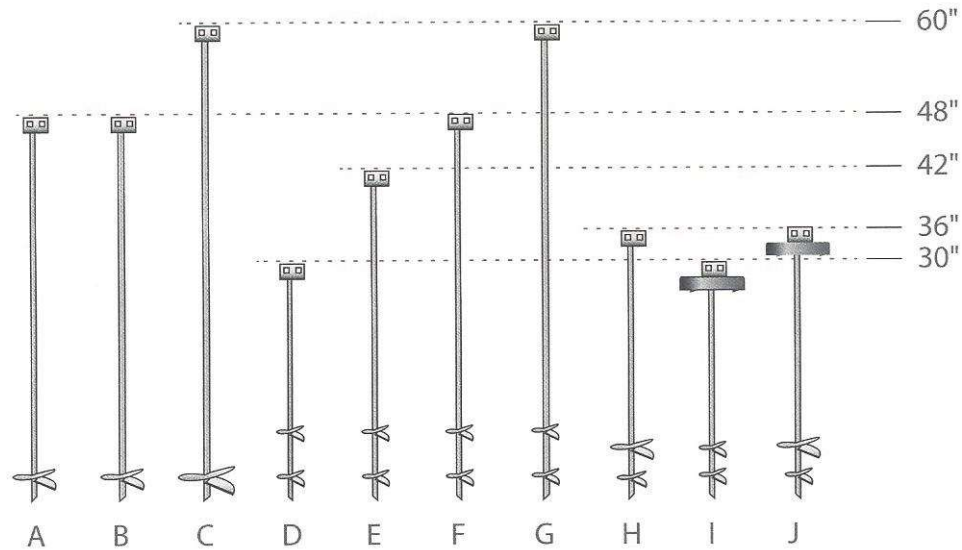

Iron Root Double Head Manufactured Home Earth Anchors (6 per bundle)

#	Description	Black Paint	Part #	Galvanized	Part #
A	Model MI2H5/8 with 5/8" rod, 48" long, 6" helix, Class 4A	# 59080	531-23*	# 59081	531-1075T
B	Model MI2H3/4 with 3/4" rod, 48" long, 6" helix, Class 4A	# 59085	531-59085*	# 59094	531-1075TA
C	Model M607 with 3/4" rod, 60" long, 7" helix, Class 4B	N/A	N/A	# 59099	531-1287T

Iron Root Double Head Double Helix Manufactured Home Earth Anchors

#	Description	Black Paint	Part #	Galvanized	Part #
D	Model MI225/8 with 5/8" rod, 30" long, 2-4" helix, Class 2	# 59090	531-210*	# 59078	Special Order
D	Model MI223/4 with 3/4" rod, 30" long, 2 - 4" helix, Class 2	# 59095	531-21	# 59079	531-59079
E	Model MI423/4 with 3/4" rod, 42" long, 2-4" helix Class 4A	# 59128	531-212	# 59128G	Special Order
F	Model MI483/4 with 3/4" rod, 48" long, 2-4" helix, Class 4A	# 59086	531-59086	# 59086G	Special Order
G	Model MI603/4 with 3/4" rod, 60" long, 2-4" helix, Class 2	# 59097	Special Order	# 59097G	Special Order
H	Model MI2H64 with 3/4" rod, 36" long, 4" & 6" helix, Class 4A	# 59250	531-1346	# 59250G	531-59250G*

Deep Set Anchor/Stabilizer (4 per bundle/160 per pallet)

#	Description	Black Paint	Part #	Galvanized	Part #
I	30" long with 3/4" rod and 2 - 4" helix, Class 3	# 59091	531-15	# 59091G	531-59091G*
J	36" long with 3/4" rod and 4" & 6" helix, Class 4A	# 59092	531-15A	# 59092G	531-59092G*

*Special Order at some locations

Specialty Anchors



Cross Drive Rock Anchor

Engineered for installation into solid rock within 1" from bottom of the anchor base. Exact alignment is achieved with the swivel tensioning head. 5 per box.

Model #MRA with 30" rods, for Soil Class 1

Black Paint # 59110	Part # 531-20
Head Only # 2MRAHD	Part # 531-20H
Rod Only # 59126	Part # 531-20R



Double Head Anchor with Expansion Bolt

This anchor is designed to be bolted to an expansion sleeve in an existing concrete slab.

Model # MICS2 (24 per box)

Black Paint # 59125	Part # 531-19
Galvanized # 59124	Part # 531-19A

Expansion Bolt Only (160 per box)

Model # 2M58SA	Part # 531-19B
----------------	----------------

J Rod Concrete Anchor

The J Rod Concrete Anchor is designed to be installed into a concrete slab at the time the concrete is being poured. 24 per box.



MIJ2 12" Anchor

Black Paint # 59120	Part # 531-25A
Galvanized # 59121	Part # 531-25B*

MIJ2 8" Anchor

Black Paint # 59123	531-59123*
Galvanized # 59123G	531-59123G*

MIJ2 12" with Swivel Head

Black Paint # 59109	531-25
---------------------	--------

MIJ2 8" with Swivel Head

Black Paint # 59147	531-59147
Galvanized # 59147G	531-59147G*

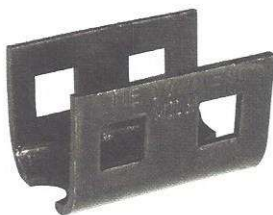

Double Tension Head

Featured on all tension head anchors. Built tough for maximum tensioning on either frame and/or roof ties. Strap bolts are securely locked every fourth of a turn with the square lock head.

Double Head Only (24 per box)

Black Paint #59103	Part # 531-19H
Galvanized #59104	Special Order

*Special Order at some locations

Specialty Anchors

X-Plate Anchor

Stabilized Cross Drive Anchor For difficult class 2 Soils. 2200 lb. working load at 50 degrees max angle. 4 per box.

Black Paint # 531-59118*

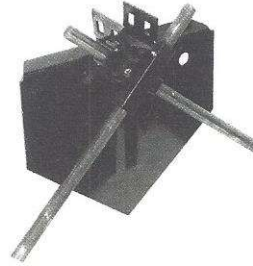

Asphalt Anchor

Black painted asphalt anchor must be installed with hammer drill. Used for horizontal anchorage at a maximum of 50 degrees, not for vertical anchorage.

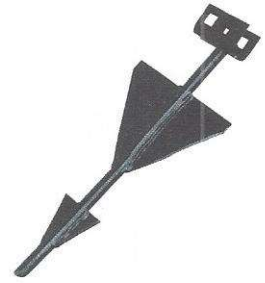

Model # 59367 Part # 531-59367*

Eye Anchors

#	Description		Black Paint	Part #	Galvanized	Part #
A	15" Long with 1/2" rod, 4" helix	12 per box	# 59050	531-59050	N/A	N/A
B	30" Long with 1/2" rod, 4" helix	12 per box	# 59055	531-20A	# 59057	Special Order
C	40" Long with 5/8" rod, 6" helix	4 per box	# 59060	531-59060	# 59061	531-59061*
D	48" Long with 5/8" rod, 6" helix	4 per box	# 59065	531-59065	# 59064	531-59064*

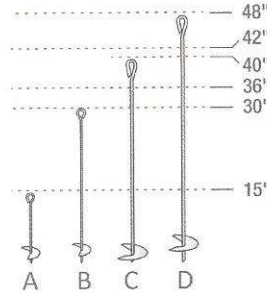

*Special Order at some locations



All Purpose 15" Anchor Kit

Eye Anchor Kits

All Purpose Anchor Kit

4 - 15" anchors, 8 - 1/8" galvanized clamps, 50' 1/8" galvanized aircraft cable
Model # 59070
Part # 531-59070

Storage Building Anchor Kit

4 - 30" anchors, 8 - 1/8" galvanized clamps, 60' 1/8" galvanized aircraft cable
Model # 59075
Part # 531-59075



Storage Building 30" Anchor Kit

30" Coral Anchor

Designed for use at a 60 degree angle (30 degrees from vertical) into the coral.
Not for vertical anchorage
Model # 59096
Part # 531-1390



Soil/Anchor Classification Chart

Soil Class & Test Value (in. lbs.)	Recommended Anchor / Stabilizers	Part Number	
		Black	Galvanized
1 N/A	30" Cross Drive RockAnchor	531-20	S/O* (#59110G)
	48" Cross Drive RockAnchor	S/O* (#59111)	
2 551 lbs. +	30" X 5/8" rod / 2 - 4" helix	531-210*	S/O* (#59078)
	30" X 3/4" rod / 2 - 4" helix	531-21	531-59079
	60" X 3/4" rod / 2 - 4" helix	S/O* (#59097)	S/O* (#59097G)
	All anchors above should use one of the following when subjected to lateral loads:		
	12" Stabilizer Plate	531-18	531-59292G*
Quik-Set Stabilization Plate	531-59291	S/O* (#59291G)	
	X-PlateAnchor with 2 - 23/32'Rods	S/O* (#59118)	
3 351 to 550 lbs.	48" X 5/8" rod / 1 - 6" helix	531-23*	531-1075T
	48" X 3/4" rod / 1 - 6" helix	531-59085*	531-1075TA
	36" X 3/4" rod / 1 - 6" helix & 1 - 4" helix	531-1346	531-59250G*
	All anchors above should use one of the following when subjected to lateral loads:		
	12" Stabilizer Plate	531-18	531-59292G*
Quik-Set Stabilization Plate	531-59291	S/O* (#59291G)	
	DeepsetAnchor 30" X 5/8" rod / 2 - 4" helix	531-15	531-59091G*
4a 276 to 350 lbs.	48" X 5/8" rod / 1 - 6" helix	531-23*	531-1075T*
	48" X 3/4" rod / 1 - 6" helix	531-59085*	531-1075TA*
	36" X 3/4" rod / 1 - 6" helix & 1 - 4" helix	531-1346	531-29250G*
	3/4" rod, 42" long 2 - 4" helix, Class 4A	531-212	S/O* (#59128G)
	3/4" rod, 48" long 2 - 4" helix, Class 4A	531-59086	S/O* (#59086G)
	All anchors above should use one of the following when subjected to lateral loads:		
	12" Stabilizer Plate	531-18	531-59292G*
	17 -1/2" Stabilizer Plate (Florida Only)	N/A	531-2202
Quik-Set Stabilization Plate	531-59291*	S/O* (#59291G)	
ABS Stabilization Plate (Florida Only)	531-2202A	N/A	
	DeepsetAnchor 36" X 3/4" rod / 4" & 6" helix	531-15A	531-59092G*
4b 175 to 275 lbs.	60" X 3/4" rod / 1 - 7" helix	N/A	531-1287T
	All anchors above should use one of the following when subjected to lateral loads:		
	17 -1/2" Stabilizer Plate	N/A	531-2202
ABS Stabilization Plate	531-2202A	N/A	

NOTE: Each State, County or Municipality may require a specific anchor from the groups shown for each soil classification. Check local and State regulations first.

*Special Order at some locations

Stabilizer Plates

Earth Anchor Stabilizer

Prevents anchor from slicing through soil laterally in the direction of the frame tie. 12" wide. 8 per box.

Black Paint # 59292 Part # 531-18
Galvanized # 59292G Part # 531-59292G*

XL Stabilizer Plate

This plate is required in Florida for installation in Class 4 soils. The plate measures 17.5" x 13.5". 8 per box.

Galvanized # 59286 Part # 531-2202

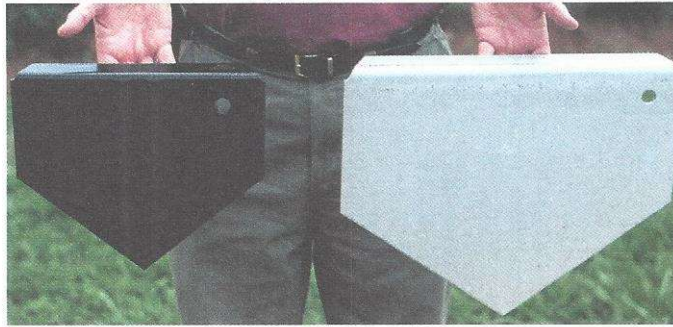

Anchor/Stabilizer Installation

1. Position anchor at a slight back angle (10°) so that when fully installed, the anchor head will be inside any skirting or side wall.
2. Install anchor to +/- 2/3 depth, then install stabilizer vertically, within 3"-4" of anchor shaft, parallel to wall of home.
3. Fully drive anchor, attach strap (see proper strap tensioning), and pretension strap to pull anchor rod against the stabilizer plate.

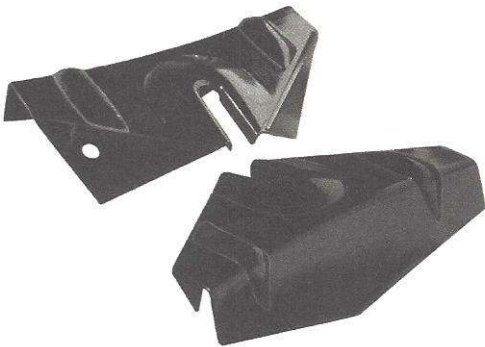
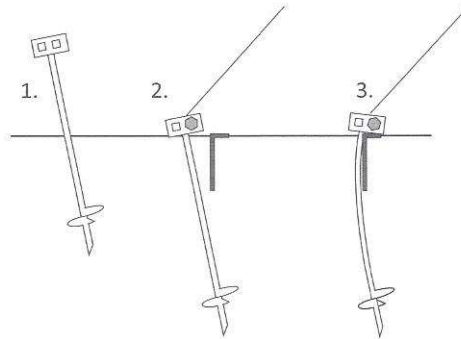

Quik-Set Stabilization Plate

- Sets Quickly
- Requires little or no hammering
- Quick-N-Easy installation, let the Drive Machine do the work
- Inclined steady rest engineered to allow ground anchor to be installed at a slight back angle (10-15 degrees)

Black Paint #59291 Part # 531-59291
Galvanized #59291G Special Order



ABS Stabilizer Plate

Designed for loose soil conditions. For Class 4 Soils. 10" x 24"

Model # 59293 Part # 531-2202A

Tie Down/ArborTie® Anchor Kit

ArborTie® is a revolutionary material for staking and guying trees. Specifically designed to replace traditional methods such as wire and hose, ArborTie® is safe, soft, easy to use and less expensive than traditional tree ties.

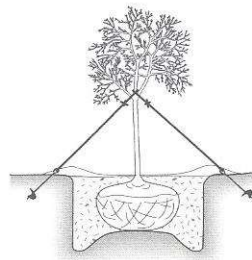

3-15" Eye Anchors with 30' of ArborTie®
Small Tree Anchor Kit

Model # 59451 Special Order

3-30" Eye Anchors with 30' of ArborTie®
Medium Tree Anchor Kit Part

Model # 59452 Special Order

Certified Galvanized Strapping

HUD Code 3280 and 3285(2) require 1-1/4" X .035" or larger steel strapping conforming to ASTM D3953-97, standard specifications for strapping, flat steel and seals. Type 1, Grade 1, Finish B, with a minimum total capacity of 4,725 lbs. and a working capacity of 3,150 lbs. marked every 5 ft. The straps must be provided with protections against weather deterioration and corrosion at least equivalent to that provided by a coating of zinc on steel of not less than .30 oz./ft. of surface coated. Slit or cut edges of coated strapping need not be zinc coated.

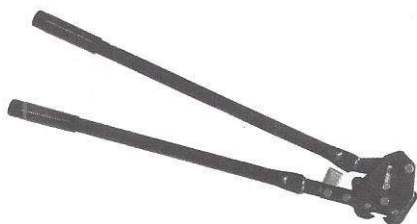

Crimping Tool

Tie Down crimp tools are designed for use with .035 thickness, 1-1/4" wide strap and steel crimp seals.

Model # 59180 Part # 532-2550



Double Slot Strap Buckle

High strength steel buckle with rust resistant hot dipped galvanized finish. Secures strap around mobile home frame. 200 per box.

Model # 59140 Part # 531-26



Swivel Head Bracket

For use with Beam Clamps, Longitudinal Clamps and Vector Foundation Systems.

Model # 59002 531-59002

Strap and Hardware



Galvanized	Model #	Part #	Length	Qty
G60	59150	Special Order	35'	12 per box
G60	59155	531-27	37'	12 per box
G60	59165	Special Order	60'	12 per box
G60	59170	531-28	600'	20 per pallet
G120	59218	531-2837	37'	12 per box
G120	59219	532-2860	600'	20 per pallet
G120	59633	531-59633	120'	

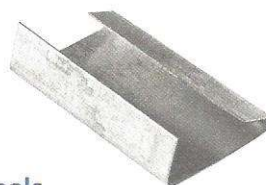

Crimping Seals

Semi-Closed style for ease of use and strong bonds. Fits 1-1/4" strapping. 1000 per box.

Model # 59175 Part # 531-11



Frame Tie with Hook

For fast and safe installation of frame ties, this heavy duty 1/4" steel hook locks securely onto frame. Certified Galvanized Steel Strapping conforms to NCS BCS A225.1 (ANSI A119.3) and HUD specifications.

Model #	Part #	Length	Qty
MHT6 59185	Special Order	6'	75 per box
MHT7 59190	Special Order	7'	50 per box
MHT8 59195	531-10	8'	50 per box
MHT10 59210	531-59210	10'	30 per box
MHT12 59211	531-59211	12'	30 per box
MHT14 59214	Special Order	14'	30 per box
MHT16 59196	531-10H	16'	30 per box
59215	531-12	Hook Only	200 per box

*Special Order at some locations

Strap and Hardware

Frame Tie with Buckle

For fast & easy installation of frame ties with buckle.



Slotted Bolt & Nut

Required for the tensioning of frame or sidewall with all tension head anchors. 400 per bucket.

Model #59135 Part # 531-22



Beam Clamps

For use with Universal & Standard Swivel Strap Connectors. 24 per box.

Model #	Part #	Length
59003	531-2803	3" Beam
59004	531-2801	4" Beam
59005	531-2802	DBL Beams



Gator Beam Clamps

For attaching strap to I-beam at each end of the home for longitudinal anchors. 4 per box.

	Model #	Part #
4 Bolt Gator Clamp for Zone I and II	58999	531-58999
8 Bolt Gator Clamp for Zone III and Florida	59011	531-59011

Model #	Part #	Length	Qty
MBU7 59141	Special Order	7'	50 per box
MBU8 59146	531-10A	8'	50 per box
MBU10 59138	531-59138	10'	30 per box
MBU12 59144	531-59144	12'	30 per box
MBU16 59234	Special Order	16'	25 per box

Swivel Adapter Head

Adapter converts existing eye anchors into tension head anchors. Includes two slotted bolts & nuts. 24 per box.

Black Paint # 59105 Special Order



Strap with 59002 Swivel Connectors

G-60 Strap/Connector Zone I & II
Longitudinal - Beam Clamp - Vector



Description	Model #	Part #
5' Strap w/Swivel Connector (50 per box)	59725	Special Order
6' Strap w/Swivel Connector (50 per box)	59726	Special Order
7' Strap w/Swivel Connector (50 per box)	59727	Special Order
8' Strap w/Swivel Connector (50 per box)	59728	531-59728
10' Strap w/Swivel Connector (30 per box)	59730	Special Order
12' Strap w/Swivel Connector (30 per box)	59732	531-59732
16' Strap w/Swivel Connector (25 per box)	59736	Special Order

G-120 Strap/Connectors

Zone III & Florida Longitudinal Beam Clamp - Vector

Description	Model #	Part #
7' Strap w/Swivel Connector (50 per box)	59209V	Special Order
8' Strap w/Swivel Connector (50 per box)	59213V	Special Order
10' Strap w/Swivel Connector (30 per box)	59217V	Special Order
12' Strap w/Swivel Connector (30 per box)	59223V	Special Order
16' Strap w/Swivel Connector (25 per box)	59231V	Special Order

Universal Swivel Strap Connector

One Strap . . . Four installation Options. Made with G-120 strap for Zones II & III installations

Universal Swivel Strap Connector with G120 Strap

Model #	Part #	Length	Qty
59207	531-2805	5'	50 per box
59208	531-2806	6'	50 per box
59209	531-2807	7'	50 per box
59213	531-2808	8'	50 per box
59217	531-2810	10'	30 per box
59223	531-59223	12'	30 per box
59231	531-2818	16'	25 per box
59242	531-59242	Universal Swivel Strap Connector	



Strap and Hardware

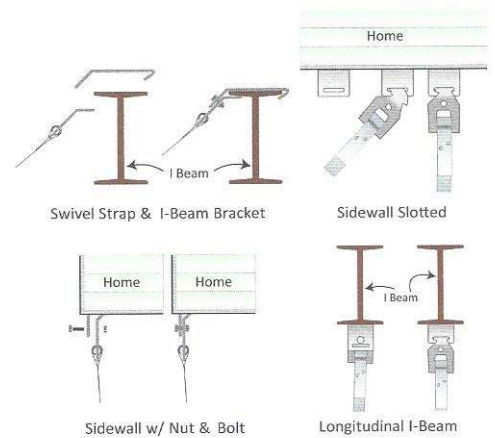

Hardware

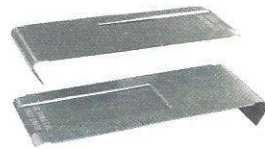

Strap Protectors

Attaches between strap and I-beam to prevent cutting or breaking of strap on sharp edges.
250 per box.

Bulk # 59232 Special Order
24 Pack # 59232P Special Order

Galvanized Roof Bracket

Designed to hold strap or cable ties away from the roof and sides of mobile homes.
24 per box.

Model # 59145 Part # 531-29



Jacking Plate

Jacking plate is used to add support to frame when adjusting trailer height with a jack. Required by many manufacturers when setting, to keep from bending the I-beam. Heavy gauge steel.

3-1/2" Wide

Model # 59000 Part # 531-59000

5" Wide

Model # 59001 Part # 531-59001



Angle Frame Bracket

For attaching longitudinal anchors to I-beam at each end of the home.
24 per box.

Model # 59009 Part # 531-59009*

Speed Wrench

Tie Down's SPEED WRENCH simplifies anchor installation with a design that allows for one handed operation for installing slotted bolts and tensioning strap. The SPEED WRENCH has a 15/16" (or 24 mm) impact socket on one side and a 15/16" "nut" on the other. Combine this with your own ratchet and 15/16" (or 24 mm) socket and you have the fastest way to tighten slotted bolts!



Part # 531-48900

Strap Installation



1. Place Speed Wrench over the bolt head. Insert the strap end into the slot in bolt until flush with opposite side of bolt.



2. Hold Speed Wrench in place, tighten bolt with socket wrench on outside of Speed Wrench (bolt head side).



3. Move socket to the opposite (nut) side. Hold Speed Wrench in place. Use socket wrench to tighten nut.

Sidewall Brackets for Modular & Manufactured Homes

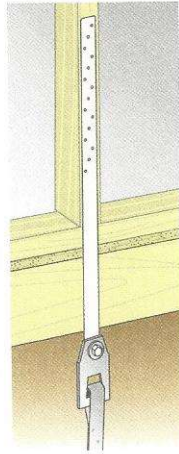
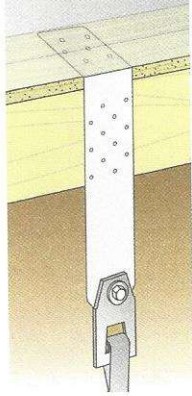

Sidewall Swivel Strap Assembly (12 per box)

Includes: Connector, Strap, Bolt, 2 Washers & Nylock Nut

1,717 lb. Capacity	Model # 59337A	531-59337A*
2,500 lb. Capacity	Model # 59338A	Special Order

Swivel Strap Connector (Only) (12 per box)

10 ga. Zinc Model # 59336 Special Order

Tie Straps (Only) (12 per box)

14 ga. Pre-galvanized	Model # 59337	Special Order
12 ga. Pre-galvanized	Model # 59338	531-59338*

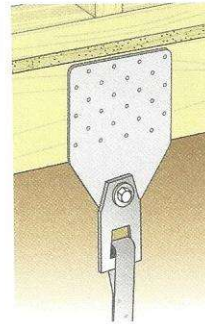

Swivel "L" Tie Plate Assembly (12 per box)

Includes: Connector, "L" Tie Plate, Bolt, 2 Washers and Nylock Nut

2,350 lb. capacity Model # 59339A Part # 531-59339A

Swivel Strap Connector (Only) (12 per box)

10 ga. Zinc Model # 59336 Special Order

Swivel "L" Tie Plate (Only) 13.3" x 3" x 3" (12 per box)

14 ga. Pre-galvanized Model # 59339 Special Order

Swivel Tie Plate Assembly (12 per box)

Includes: Connector, Tie Plate, Bolt, 2 Washers and Nylock Nut

2,000 lb. capacity	Model # 59342A	531-59342A*
3,150 lb. capacity	Model # 59340A	531-59340A

Swivel Strap Connector (Only) (12 per box)

10 ga. Zinc Model # 59336 Special Order

Tie Plates (Only) 6" x 8" (12 per box)

14 ga. Pre-galvanized	Model # 59342	531-59342*
12 ga. Pre-galvanized	Model # 59340	Special Order

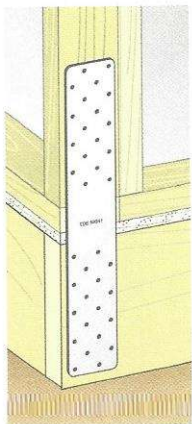

Tie Plate 3" x 16" (12 per box)

14 ga. Pre-galvanized
2,4000 lb. capacity
Model # 59341
Special Order



Marriage Wall Bracket

Required at column at marriage wall support.

Model # 59699

531-59699

*Special Order at some locations

Electric Drive Machine

Make quick work of earth anchor installation with the 1/2 HP, 20 RPM Electric Drive Machine from Tie Down Engineering. Adapter head fits all double head anchors and has a socket on the inside to fit the Soil Test Probe. Ground fault interrupter cord is standard on the EDM-20.

- 1/2 HP Motor - 20 RPM
- 20% More Torque
- Quieter, Smoother Operation
- Ground Fault Interrupter (GFI)
- Solid Metal Housing
- Tube & Stamped Steel Frame
- Forward & Reverse Switch
- 90 Day Limited Warranty

Anchor Adapter Head

Included with the EDM-20
Model # 59205
Part # 531-48011



Drive Machine Parts

Forward/Reverse Switch
Part # 531-1DMFR
On/Off Switch
Part # 531-1DMOF

Electric Drive Machine

Model EDM-20, 1/2 HP
Model # 59620
Part # 534-53



Eye Anchor Adapter Head

Optional
Model # 59206
Part # 531-59206*



Soil Test Probe Information

The Soil Test Probe is used to determine the soil conditions below the surface near the anchor's helix. Using the Soil Test Probe will ensure maximum anchor holding strength by indicating the proper anchor model for each soil condition. The Anchor Chart on page 5 and a test probe reading can be used to get a recommend anchor for every soil condition.

Instructions

1. Place probe tip into ground where you intend to place the anchor. Using a 15/16" (or 24 mm) hex socket with a ratchet or breaker bar, rotate the probe in a clockwise direction. (An electric drive machine with an adapter head may also be used)
2. Drive (rotate) the torque probe into the soil until reaching a depth equal to the length of the anchor being installed.
3. To determine the soil classification:
 - Place wrench adapter onto torque wrench.
 - Insert hex portion of wrench adapter onto the earth probe.
 - Support probe shaft with one hand, while rotating probe steadily with the wrench. (Do not exceed 600 in. lbs.)
 - Read the torque wrench while rotating probe clockwise.
 - Use the Anchor Chart on page 5 to cross reference probe readings.
4. If probe reading does not match the anchor for that depth, rotate probe to next anchor depth and check reading. Continue until reading on probe matches anchor length for depth of reading.
5. To remove probe, use wrench or electric drive machine in reverse (counter clockwise)

Model # 59200 Part # 534-07



The purpose of the Soil Test Probe Kit is to determine the soil conditions below the surfaces near the anchor's helix plate. This will provide maximum anchor holding strength by insuring use of proper anchors for each soil condition. Includes multi pocketed carrying case.



ABS Foundation Pads

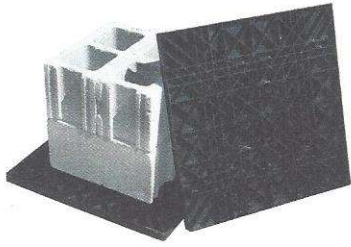

- Lighter than concrete, saves on labor.
- Larger pads to increase spacing, saving time and material.
- Made from recycled materials.
- Easily stackable for larger pad area and wider pier spacing.
- Multi stack for 5 sq. ft. & 6 sq. ft.
- Approved for use by HUD 3285.312(3)
- Listed and labeled by RADCO #1345

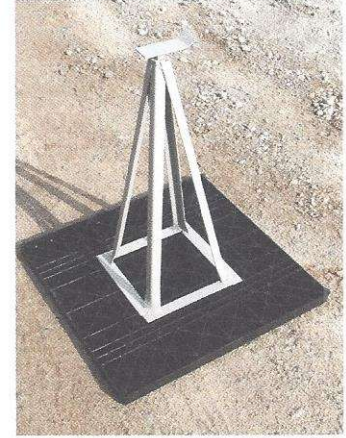

Single Pad Layout

Part #	Model #	ABS Pad Size	1000 lbs Soil	1500 lbs Soil	2000 lbs Soil	3000 lbs Soil
531-13T	59300	16" x 18" - 2 Sq. Ft. (288 Sq. In.)	2,000 lbs	3,000 lbs	4,000 lbs	6,000 lbs
531-14T	59301	16" x 22.5" - 2.5 Sq. Ft. (360 Sq. In.)	2,500 lbs	3,750 lbs	5,000 lbs	7,500 lbs
531-141T	59302	17" x 25" - 3 Sq. Ft. (432 Sq. In.)	3,000 lbs	4,500 lbs	6,000 lbs	N/A
531-143T	59303	24" x 24" - 4 Sq. Ft. (576 Sq. In.)	4,000 lbs	6,000 lbs	8,000 lbs	N/A

Multi-Pad Layout

Part #	Model #	ABS Pad Size	1000 lbs Soil	1500 lbs Soil
531-14T	59301 x3	32" x 22.5" - 5 Sq. Ft. (720 Sq. In.)	5,000 lbs	10,000 lbs*
531-141T	59302 x3	34.4" x 25.2" - 6 Sq. Ft. (864 Sq. In.)	6,000 lbs	12,000 lbs*

*Concrete Block rated @ 8,000 lbs. Double block any higher loads.

1. The 32 x 22.5 Pyramid Configuration uses 2-16 x 22.5 pads placed side by side with 1- 16 x 22.5 pad on top in the opposite direction.
2. The 34.4 x 25.4 Pyramid Configuration uses 2-17.2 x 25.2 pads placed side by side with 1-17.2 x 25.2 pad on top in the opposite direction.

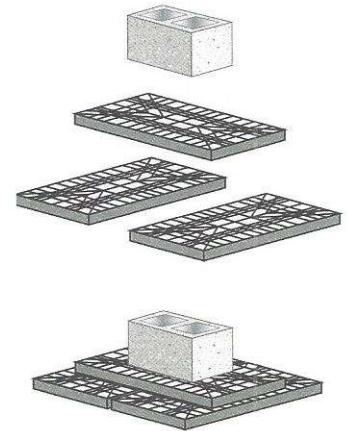

Steel Piers and Heads

Steel Support Piers are designed for use as a replacement for dry stacked blocks, piers available up to a maximum of 30 inches. Steel Support Piers are designed and tested to vertical loads for a support rating of 6,000 lbs. Piers can be used under factory built structures such as manufactured homes, mobile commercial units, classrooms, multiplexes, sheds and other similar structures. They can be used in all wind zone conditions, except "Exposure D" within 1500 ft. of the coastline. Support piers are designed for use with a variety of heads to prevent movement after attachment to the beam or screwed to the marriage line; check local codes and manufacturers requirements for proper installation regulations for beam and marriage line installation.



"L" Top Head
Part #531-MPH01

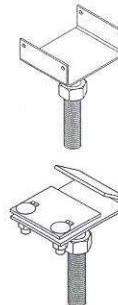

Saddle Top Pier Head
Part #531-MPH02



Flat Top Pier Head
Model #MPH04
Special Order

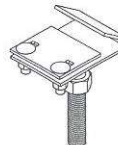

Beam Hook Top
Pier Head
Model #MPH06
Special Order

Steel Support Piers- 6,000 lb. Capacity

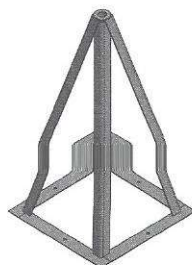

MH Support Pier

Size	Part #
8"	MPP8 - Special Order
10"	MPP10 - Special Order
12"	531-MPP12
14"	531-MPP14
16"	531-MPP16
18"	531-MPP18
20"	MPP20 - Special Order
22"	MPP22 - Special Order

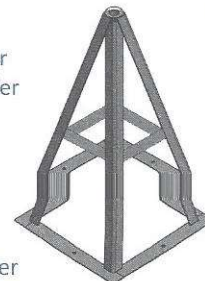

Braced MH Support Pier All Special Order

Size	Part #
24"	MPP24
26"	MPP26
28"	MPP28
30"	MPP30

Lateral Stabilization

Tie Down's Patented Vector Dynamics Foundation System Provides Windstorm & Seismic Protection For Manufactured Homes (Wind Zones I, II & III, Florida & Seismic Loads)

Vector Systems

Lateral Stabilization Block Pads

Model # 59018

Special Order

Kit includes: 2 pans, swivel straps, strap protectors, pan connectors, slotted bolts & hardware.

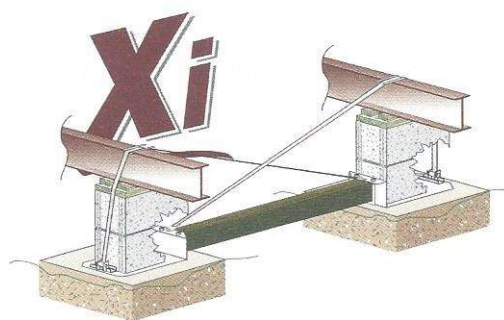
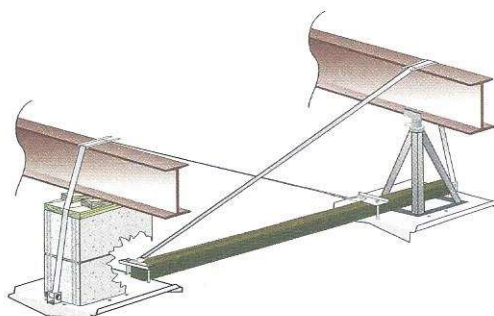

Lateral Stabilization

for Single Stack Concrete Blocks

Model # 59036

Part # 531-59036*

Kit includes: 2 concrete pans, swivel straps, strap protectors, concrete brackets, slotted bolts & hardware. Optional: Steel Compression Member

Lateral Stabilization for Double Stack Concrete Blocks

Model # 59049

Part # 531-59049*

Kit includes: 2 concrete pans, swivel straps, strap protectors, concrete brackets, slotted bolts & hardware. Optional: Steel Compression Member

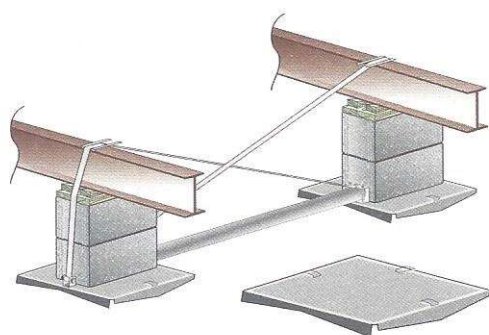
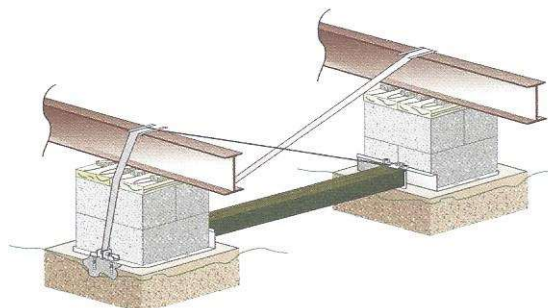

"Florida" Vector Lateral Hardware Kit

Model # 59024

Part # 531-59024*

Kit Includes: U-bolts, strap protectors, pan connectors, PVC adapter, nuts & bolts (swivel strap and slotted bolts not included).

3 Sq. Ft. Vector System Pad

Model # 59271

Part # 531-59271

Sold individually, 2 required for lateral, 1 for longitudinal systems.

*Special Order at some locations

Vector Systems

Longitudinal Stabilization

Tie Down's Patented Vector Dynamics Foundation System Provides Windstorm & Seismic Protection For Manufactured Homes (Wind Zones I, II & III, Florida & Seismic Loads)

Longitudinal Stabilization Hardware Kit

Model # 10733

Special Order

(for use with #59018 Vector System, single stack block sets only, longitudinal struts not included)

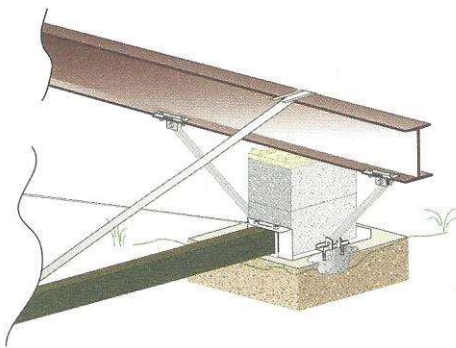
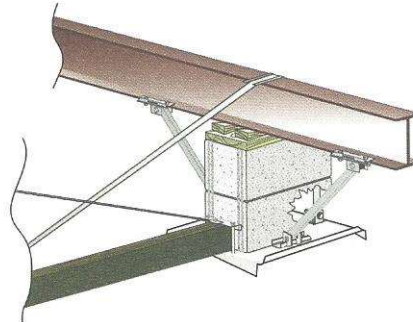

Longitudinal Stabilization Hardware Kit for Concrete

Model # 59023

Part # 531-59023*

Includes 2 beam clamps, tension brackets, nuts and bolts. (for use with #59036 & 59049, longitudinal struts not included)

3 Sq. Ft. Pad Vector Longitudinal System

Model # 59026

Part # 531-59026

Kit Includes: 2 beam clamps, 2 tension brackets, nuts & bolts. (for use with #59271, longitudinal struts not included)



Struts for Longitudinal Systems

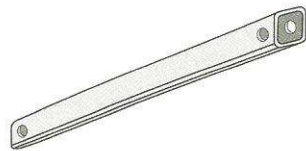

PVC Adapter Bracket

Model # 59281

Special Order

For use with Schedule 40 PVC

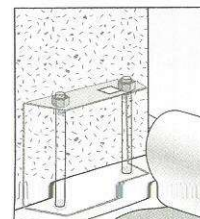

Part #	Length	Pier Height	Model #
531-59016	30"	Up to 2 Blocks	#59016
531-59012	39"	Up to 3 Blocks	#59012
531-59013	44"	Up to 4 Blocks	#59013
531-59014	53"	Up to 5 Blocks	#59014
531-59015	65"	Up to 6 Blocks	#59015

Xi2 Ground Foundation System



8.5" J-Bolt Part # 531-10638Z*

- Easiest system to install
- Stabilizer plates and diagonal frame ties are not required in most set-ups
- Longitudinal stabilization is easily added with Tie Down's LSD strut kit
- Heavy galvanized coating on bracket and struts
- For use in Wind Zones I, II & III, Florida & Seismic Loads

Xi2 Ground Lateral System

Includes: Strut, pad, j-bolt, with nut/washer, 4 self tapping screws, u-bolt with washers and nuts. Xi2 Can be used with blocks or steel peers.

Model # 59306

5' System: Part # 531-59306

Kit Includes:

- 1 - 531-59329-1 (Xi2 Hardware)
- 1 - 531-59330 (Xi2 5' Lateral Strut)
- 1 - 531-59305 (Xi2 Pad)

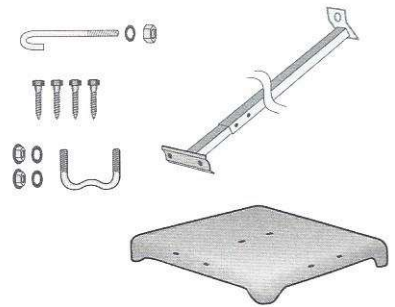
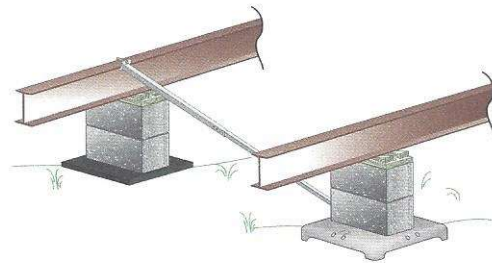

- * 5' Available (# 59330)
- * 6' Available (# 59349)
- * 7' Available (531-59346 -7' Lateral Strut)

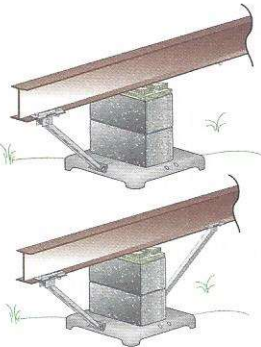

Xi2 Longitudinal Hardware Kit

Includes hardware for 2 struts: I-beam brackets, U-bolts, nuts, bolts and washers

Model # 59331

Part # 531-59331

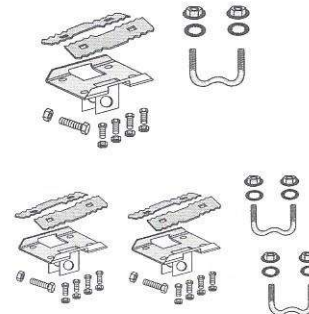

Longitudinal Struts for "Ground Systems"

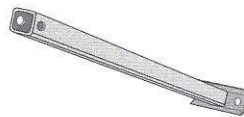

Part #	Length	Pier Height	Model #
531-59330-30	30"	up to 2 Blocks	59330-30
531-59330-39	39"	up to 3 Blocks	59330-39
531-59330-44	44"	up to 4 Blocks	59330-44
531-59330-53	53"	up to 5 Blocks	59330-53
531-59330-65	65"	up to 6 Blocks	59330-65

One House Requires	
Zone 1 Only	
Part Number	Description
2 - 531-59306	Ground Systems Kit
2 - Specific Length	(Use Strut Size Chart)
1 - 531-59331	Hardware Kit
Zones 2 and 3 Only	
Part Number	Description
2 - 531-59306	Ground Systems Kit
4 - Specific Length	(Use Strut Size Chart)
2 - 531-59331	Hardware Kit

*Special Order at some locations

Xi2 Concrete Foundation System

Xi2 Concrete Lateral Systems

Includes: Strut, Bracket, & Hardware.
Xi2 can be used with blocks or steel peers.

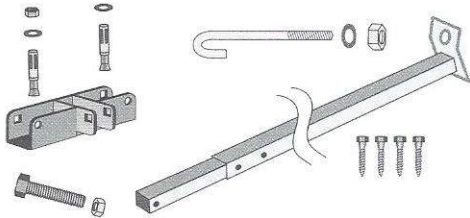
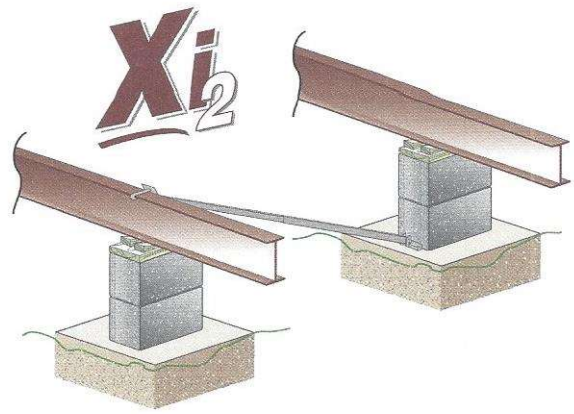

- 5' Concrete Lateral Strut Only - 531-48609
- 6' Concrete Lateral Strut Only - 531-48608
- * 7' Available (531-59347 -7' Lateral Strut)

"Dry Set" 5' Concrete System

Model # 59307

Part # 531-59307

Kit includes:

- 1 - 531-48609 (5' Strut) Bracket and Hardware
- 1 - 531-59327 (Xi2 Concrete Hardware Kit)

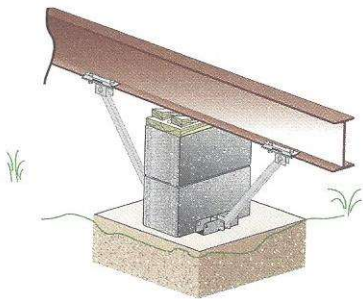

Xi2 Concrete Longitudinal Hardware Kit

Includes hardware for 2 struts:
I-beam bracket, nuts, bolts and washers

Model # 59263

Part # 531-59263

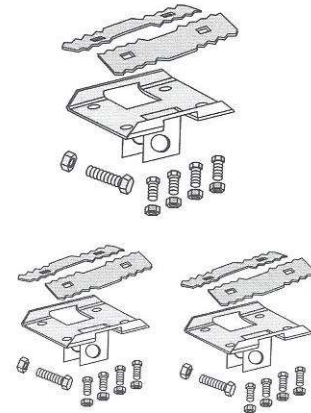

Struts for Longitudinal Systems

Part #	Length	Pier Height	Model #
531-59016	30"	Up to 2 Blocks	#59016
531-59012	39"	Up to 3 Blocks	#59012
531-59013	44"	Up to 4 Blocks	#59013
531-59014	53"	Up to 5 Blocks	#59014
531-59015	65"	Up to 6 Blocks	#59015

One House Requires Zone 1 Only	
Part Number	Description
2 - 531-59307	Ground Systems Kit
2 - Specific Length	(Use Strut Size Chart)
1 - 531-59263	Hardware Kit
Zones 2 and 3 Only	
Part Number	Description
2 - 531-59307	Ground Systems Kit
4 - Specific Length	(Use Strut Size Chart)
2 - 531-59263	Hardware Kit
2 - 531-10415	Concrete Bracket

Xi₂

Xi2 Steel Pier Ground System

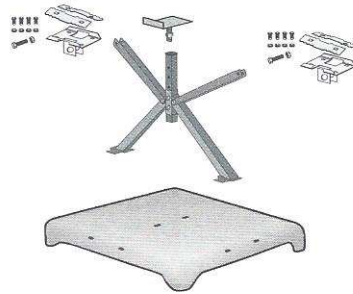

Foundation Base Pad 531-59326

Xi2 Steel Pier Longitudinal System

Includes: steel pier/longitudinal struts, foundation base pad & Hardware

- for 12" Height Model # 59321 Part # 531-48633
- for 25.5" Height Model # 59314 Part # 531-48624
- for 36" Height Model # 59317 Part # 531-48622

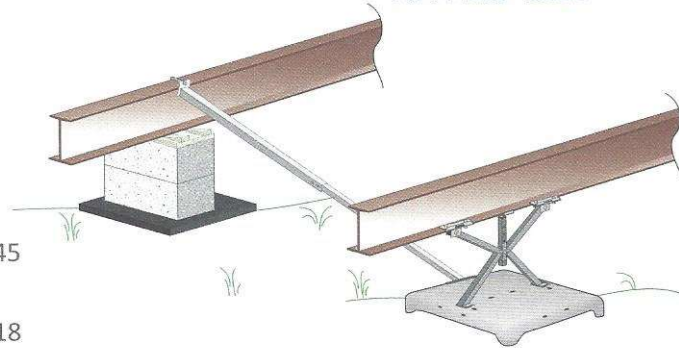

Lateral Stabilization Struts

Steel Piers can be combined with one of the following for lateral support:

- Xi2, Lateral Strut, 5' w/hardware Model # 59345 Part # 531-59315
- Xi2, Lateral Strut, 6' w/hardware Model # 59318 Part # 531-59318

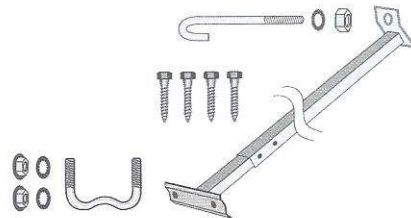

Hardware Kit (2 per box)
Part # 531-59313

Xi2 Asphalt System

Concrete Block Set

Includes: Asphalt Pad (Block), Brackets and Rods
Model # 59604 Part # 531-59604



**For:
IBC-IRC-HUD**

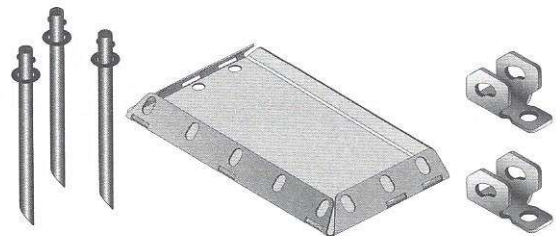

Steel Pier Set

Includes: Asphalt Pad (Steel Pier), Bracket and Rods
Model # 59616 Special Order



**For:
IBC-IRC-HUD**

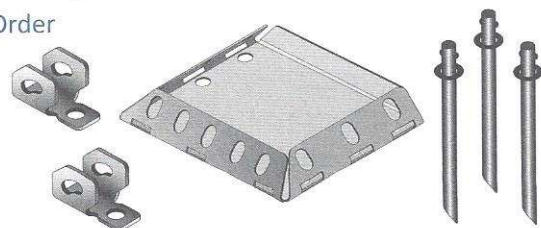

Xi2 Asphalt System: Part # 531-59604

Hardware Kit for Xi2 Asphalt System: Part # 531-59619

Finishing Products

Adjustable Outrigger/Diagonal Strut

Use under doors and windows instead of perimeter blocking. Allows for easy door adjustments. Easy to install, installation instructions included. Includes all hardware. 4 per bag.

- 24" for 14 ft. wide Model # 59363
Part # 531-59363
- 36" for 16 ft. wide Model # 59365
Part # 531-59365

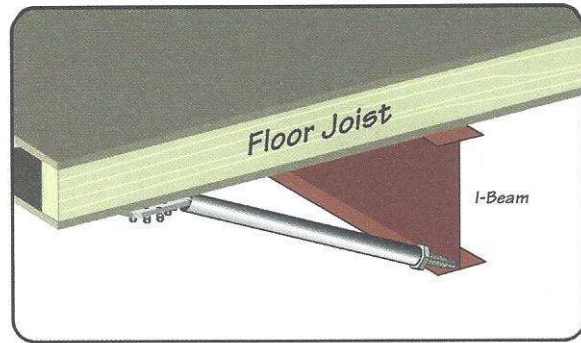

Racking Alignment Brackets

- Make alignment of problem roofs easier.
- Eliminate popped seams from lifting on corners of the home.
- Thick galvanized steel for years of service.
- One person operations saves time and money.

Model # 59366

Part # 531-59366

Latch Sav'r

Prevents damage to the latch area of most outswing doors and helps cover existing door damage. Simply remove door lock, lay plate on the door behind the lock, replace lock and tighten in place. 12 per box.

Stainless Steel Model # 59394

Part # 710-59394

White Powder Coat Model # 59398

Part # 710-59398

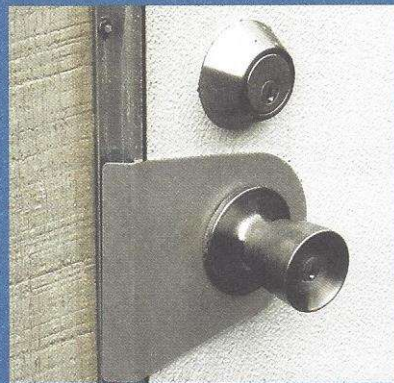

Skirt Hang'r

- Easily attaches to rim joist
- Pre-drilled and slotted for easy adjustment
- Galvanized to last a lifetime
- Mounts directly to the back rail or use the Skirt Hang'r for mounting support rails
- Meets HUD requirements 3285.504
- Stops vinyl to vinyl expansion and contraction problems
- Eliminates water between siding and trim wall cavities

Model # 43779 (50 per box)

Part # 531-02

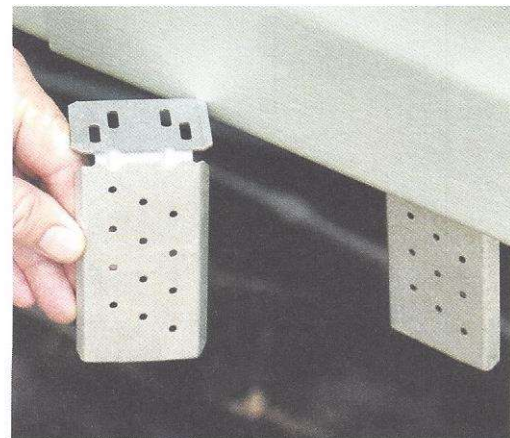

Front Spring Hangers

- Part # 531-59601K 8 Bolt Heavy Duty
- Part # 531-59600K 4 Bolt Light Duty

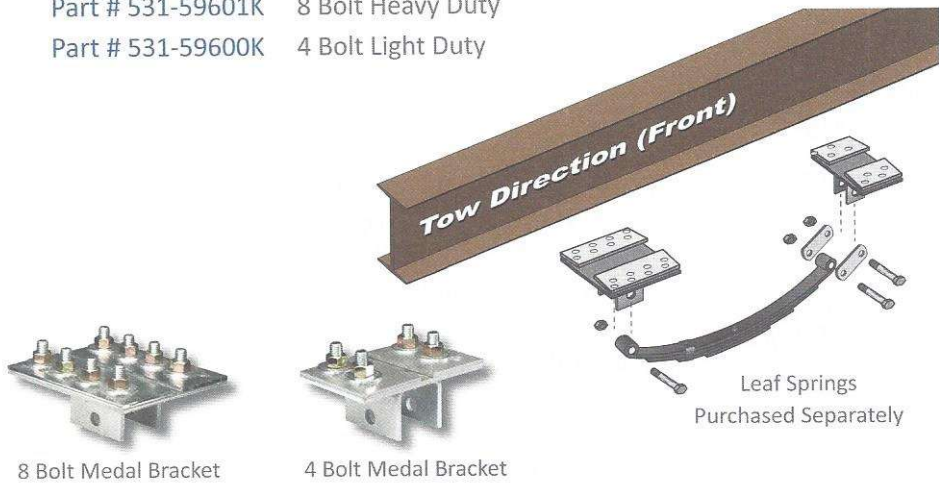

Emergency Spring Hanger Kit

For temporary attachment of spring hangers, allowing for additional axle installations when broken down in the field. 4 bolt and 8 bolt models designed for use on 3" or 4" beams, simply bolt to the I-beam and add an axle where needed.

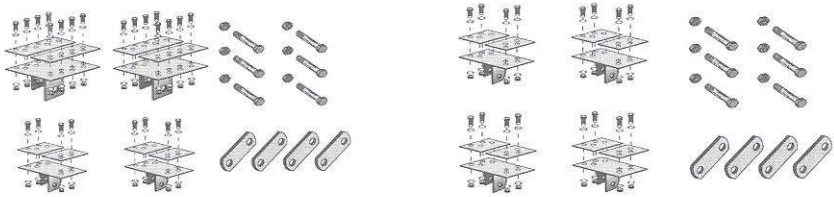

Axle Removal Skid



Used when removing axles after completion of setting unit on site. Simply unbolt axle and lay in skid pan with hub behind bracket, move to opposite side and after removing bolts, slide axle out from under home. Turns a rough job into a safe one person operation.
Model # 59399 Part # 531-59399

Axle Components

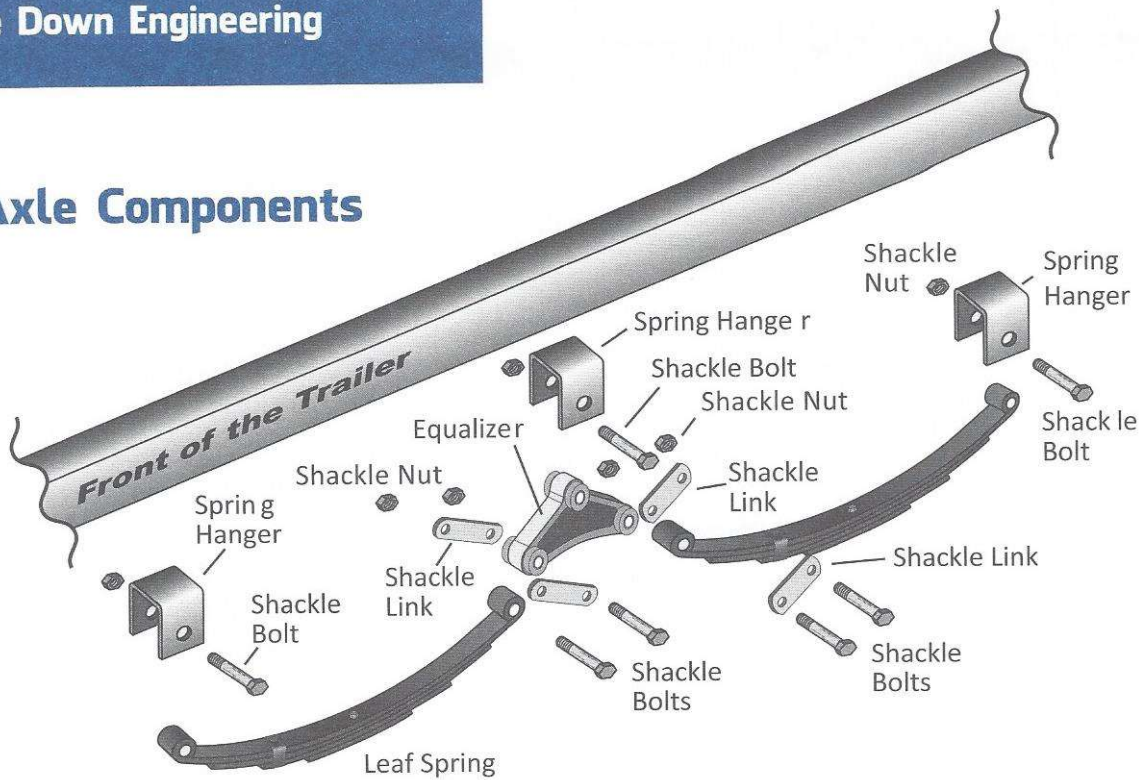

Product	Description	Part #	Model #
Double Eye, Four Leaf Spring	25-1/4" Long x 1-3/4" Wide 3,000# Capacity	531-13072	# 13072
Double Eye Cast Equalizers	EQ-104	Special Order	# 44018
	EQ-310	Special Order	# 44055
Spring Hanger	1.44" High x 1.75" Wide	Special Order	# 17013
	3.344" High x 2.0" Wide	531-44415	# 44415
Zinc Shackle Link	1.25"W x 20125" (hole to hole) X 3.75"L	531-44536	#44536
Shackle Bolt	9/16" x 3" Grade 5 Zinc Fluted	531-10830	#10830
Shackle Nut	1/2" Zinc	Special Order	#10645
	9/6" Zinc	Special Order	#10688

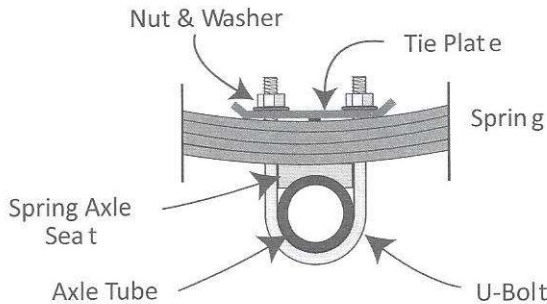

Axle Mounting Components

Product	Description	Part #	Model #
U-bolts	1/2" X 6.5" Long for 3" dia. Tube	Special Order	#10831
	1/2" x 7.12" Long for 3" dia. Tube	531-10832	#10832
Hex Head Nuts	1/2" Zinc	531-10643	#10643
Zinc Washers		531-10019	#10019
Spring Tie Plate	3" Axle Tie Plate	531-17114	#17114
Spring Axle Seat	3" Axle Seat	Special Order	#17121

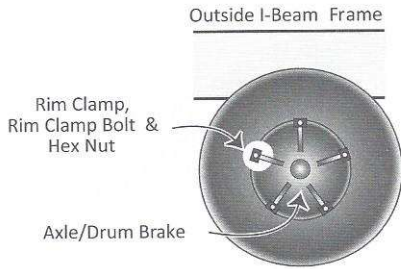

Wheel Components



Product	Description	Part #	Model#
Rim Clamp	1-1/4" Rim Clamp, Fits Most Hubs with Lugs or Studs	531-10875	#10875
Rim Clamp Bolts	1/2" - 13 X 1-7/8" Black	531-10873	#10873
	1/2" - 20 X 1-7/8" Black (While Supplies Last)	531-10874	#10874
	1/2" - X 2-1/4" Black	531-10876	#10876
Lug Stud	1/2" - 20 X 2" Zinc	531-11123	#11123
Lug Nut	1/2" - 20 Zinc	531-10641	#10641
Tapered Lug Bolt	1/2" - 20 X 1-5/8"	531-10965	#10965

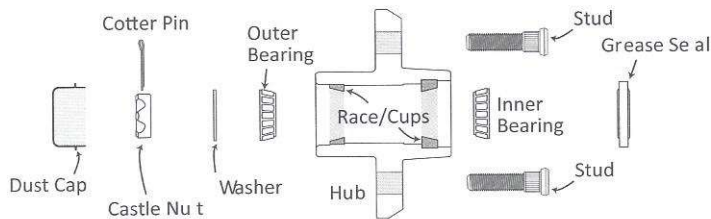

Hub Components



Product	Description	Part #	Model#
Dust/Grease Caps		531-46494	#46494
Castle Nut		Special Order	#10665
Spindle Washer		Special Order	#10520
Cotter Pin		Special Order	#10560
Bearings	Outer Bearings 1-1/4" (L67048)	531-11058	#11058
	Inner Bearing 1-3/8" (L68149)	531-11060	#11060
	Inner Bearing 1-3/7" (L22580)	Special Order	#11064
Race / Cups	For 1-1/4" Bearings (L67010)	531-11057	#11057
	For 1-3/8" Bearings (L68111)	531-11061	#11061
	For 1-3/4" Bearings (L25520)	Special Order	#11067
Grease Seal	2.52" OD—1.688 ID	531-11094	#11094

Set-Up & Towing Accessories

Pocket Penetrometer

Direct-reading scale in tons/square feet. Ground and polished stainless-steel loading piston. Calibrated spring and penetrometer body plated for rust-resistance and long life. Complete with convenient belt-loop case.

- Penetrometer Soil Tester
Part # 534-08*
- Foot Only for Penetrometer
Part # 534-08A*



Norco Hydraulic Bottle Jacks

For use in heavy duty trucks, farm equipment, building construction and mining equipment, mobile home set-up and oil field applications.

Description	Part #	Qty
12 Ton, Standard Lift: 9-7/16"	534-10	4 per box
12 Ton, Low Lift: 6-11/16"	534-11	4 per box
20 Ton, Lift: 10-13/16"	534-13	2 per box
Repair Kit - 12 Ton	534-16	
Repair Kit - 20 Ton	534-17	
<i>(Inc. Seals, Filler Plug, O-Rings and Chrome Checkball)</i>		
Oil Plug for Norco Jacks	534-09*	



Wedge Board

Wedge - Pressure Treated Pine Part # 533-32A (80/bag - 2400/pallet)

Wedge Block

1" x 8" x 16" - Treated Part # 533-301 (10/bundle - 600/pallet)

2" x 8" x 16" - Treated Part # 533-30A (5/bundle - 300/pallet)

Transit Wrap

Raven Industries is proud to announce the answer in your search for a super strong, wind beating enclosure wrap. Raven's "Transit-Wrap" is a specialty co-extruded product consisting of two layers of dense polyethylene for puncture resistance and linear low density polyethylene for tear resistance into one unique product. This product is available in two different thicknesses (3.25 mil (TW35) and 4.5 mil (TW50). 16 per pallet.

14" x 300' Roll (TW 35) White 3.25 Mil Part # 535-3101614

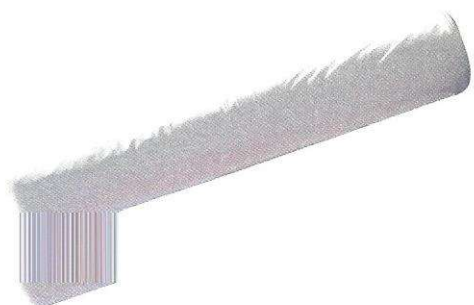

Close Off Tape

- 969-399 2" x 60' White
- 969-400 4" x 60' White



Vapor Barrier - Black (20 per pallet)

- 14' x 100' Roll, 6 mil
Part # 535-614B
- 16' x 100' Roll, 6 mil
Part # 535-616B
- 20' x 100' Roll, 6 mil
Part # 535-620B



Foam Sealer : 5.5' x 50' Roll (6 per bag)

Fills gaps between sections of home for less air infiltration.

- Easy to install - needs no special tools.
- Resists moisture penetration to interior of structure
- Helps to seal out insects
- Multi-purpose ridged

Part # 535-03

Center Seal : 500' Roll Part # 553-CS500



Model #	Description
535-3101614	Transit Wrap - 14 ft x 300 ft Roll
535-28	18 x 18 Tricot Flag, No Grommets
535-32	Plastic Flag Clips
535-AM28	Alturnamat - 2 ft x 8 ft - Black
535-AM48	Alturnamat - 4 ft x 8 ft - Black (Special Order)
535-37	Shock Cord
535-21	Wide Load Sign - 8 ft (While Supplies Last)
535-29	Flag on Staff
535-24	Wide Load Sign on one side / Oversize Load Sign on other side - with grommets (While Supplies Last)

Roof Roll Flashing - Galvanized and Aluminum

Item #	Description
593-129	10" x 50' Galvanized
593-131	12" x 50' Galvanized
593-130	10" x 50' Aluminum
593-132	12" x 50' Aluminum
593-136	12" x 70' Galvanized
593-136A	10" x 70' Galvanized
593-135	18" x 50' Galvanized



Alturnamat

Variform

ProGuard vinyl skirting provides the coverage you need to beautify your home. ProGuard vinyl skirting has an attractive wood grain finish and is available in a variety of colors. Easy to install. Vented panels have a center vent panel design. Use "vented" panels in areas that require ventilation.

FEATURES:

- Extra Wide, 16" panels mean fewer panels to cut and saves on installation time.
- Attractive rough-sawn texture.
- Easy to Install
- Virtually maintenance free
- Limited Lifetime Transferable Warranty



Available in 6 colors:

- Cream/Beige
- Clay
- Gray
- Pearl
- Tan
- White
- Century Brownstone

**CALL TODAY FOR COLOR SAMPLES!
CUSTOM INSTALLATION ALSO AVAILABLE**

	Cream/Beige	Clay	Gray	Pearl	Tan	White	Brown
Panels (12 panels/box)	572-300	572-100	572-400	572-700	572-500	572-200	572-900
Bottom Rail (28/box)	572-301	572-101	572-401	572-701	572-501	572-201	572-901
Top Front Rail (28/box)	572-302	572-102	572-402	572-702	572-502	572-202	572-902
Top Back Rail (28/box)	572-303	572-103	572-403	572-703	572-503	572-203	572-903
Trim Kit	572-304	572-104	572-404	572-704	572-504	572-204	572-904

*Trim Kit includes 14 of each rail plus hardware



Materials Calculations for Variform Vinyl Skirting

	12' x			14' x			16' x			24' x			28' x				
	50'	55'	60'	65'	70'	60'	65'	70'	80'	60'	65'	70'	60'	65'	70'		
Size of Home	120'	130'	140'	150'	160'	148'	158'	162'	182'	152'	162'	166'	188'	154'	174'	180'	
Perimeter (Linear Measurement)																	
Height of Skirting (Panel Cut Length)	<p align="center">Number of Panels Required</p> <p>*These calculations are only estimates. The home you are skirting may require a different number of panels than listed.</p>																
16"-18"	12	13	14	15	15	14	15	16	18	14	16	16	19	16	17	18	18
19"-20"	13	14	15	17	18	16	17	18	20	16	18	18	21	18	19	20	21
21"-24"	15	17	18	19	20	18	20	21	23	19	21	21	25	21	22	23	24
25"-28"	18	20	21	23	24	22	24	25	28	23	25	25	28	25	27	27	29
29"-36"	23	25	27	29	30	27	30	31	35	28	31	32	36	31	33	35	36
37"-48"	30	33	35	38	40	36	40	41	46	37	41	42	48	41	44	46	48
Rails (# of pcs)	11	12	13	13	14	11	14	14	16	13	14	16	18	15	16	16	17

Skirting & Accessories

EverRock

EverRock Features

- Won't Scratch or Dent
- Tough Vinyl Construction
- Seams are Hidden
- Corners are Easily Formed
- Flame Retardant

Available Sizes:

- 30" high. Covers 57" wide.
- 36" High. Covers 57" wide.
- 48" High. Covers 57" wide.

Other Uses

- Patios and Extensions
- Covering foundations and other cement work

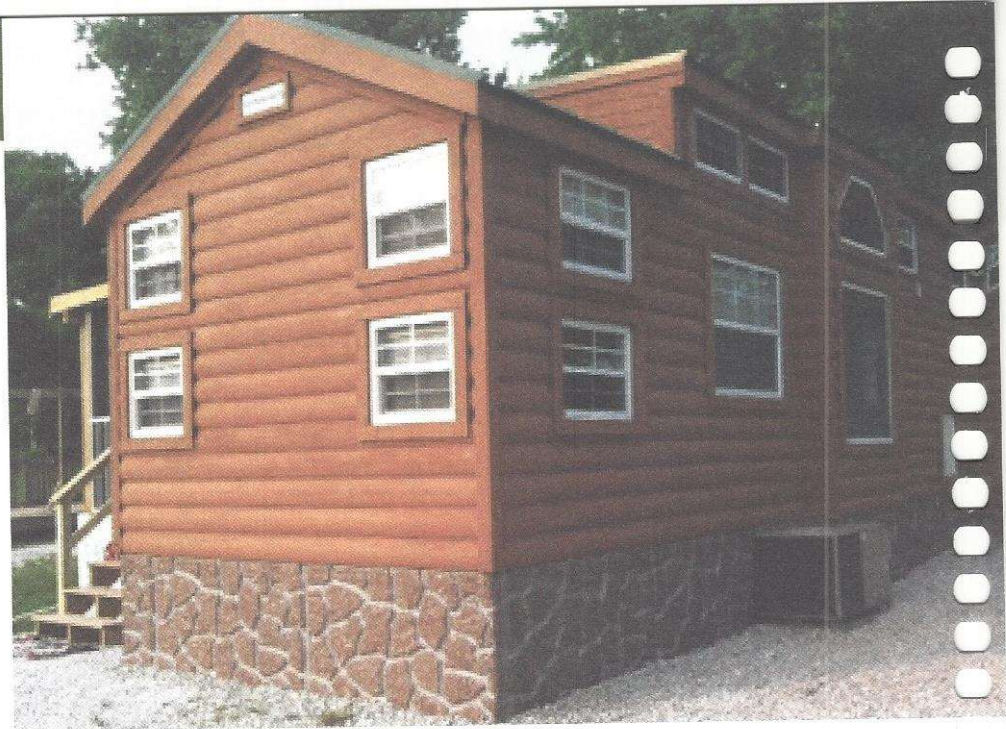

Part #	Description
573-930	30" x 5' Grey
573-931	36" x 5' Grey
573-932	48" x 5' Grey
573-933	30" x 5' Brown
573-934	36" x 5' Brown
573-935	48" x 5' Brown
573-936	30" x 5' Sandstone
573-937	36" x 5' Sandstone
573-938	48" x 5' Sandstone
573-939	30" x 5' Granite Grey
573-940	36" x 5' Granite Grey
573-941	48" x 5' Granite Grey
573-942	30" x 5' White
573-943	36" x 5' White
573-944	48" x 5' White
573-950	12' Black Bottom Rail
573-951	12' Sandstone Bottom Rail



Grey



Brown

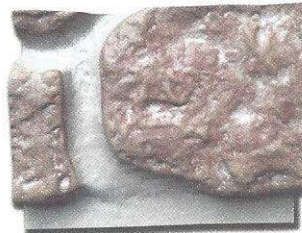

Sandstone



Granite Grey



White

Typical Home Size	12' x 60'	14' x 70'	16' x 80'	24' x 60'	24' x 70'
Linear Feet Less Hitch	136	160	184	160	180
Number of 5' Panels Needed	28	32	37	32	36



Sandstone Bottom Rail



Aluminum Siding

Part #	Description
576-800	4' x 8' Cream
576-802	4' x 8' White
576-803	4' x 8' Gray
576-804	36" x 96" Chalk White

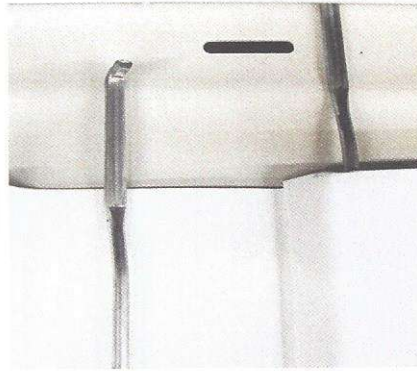

Wind Stay Rods - Skirting With Guards
 Adds additional blowout protection to skirting panels in high wind areas or high skirting installations.

Part #	Description
572-352*	12" Length
572-353	24" Length

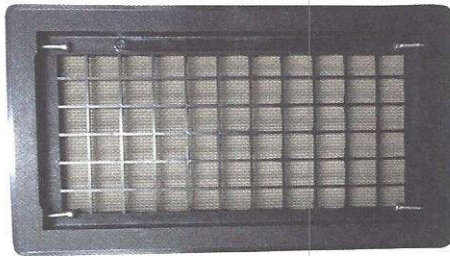

Vent

Part #	Description
573-912	Black Vent

Bottom Track - Metal

Part #	Description
575-712	Black - 12'
573-920	Sandstone - 10'

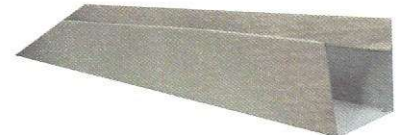

Foundation Vent Insert - EverRock

Vent automatically opens at 70 degrees and closes at 40 degrees.

Part #	Description
573-945	Sandstone, 10" x 17 1/2" Fits standard 8" x 16" vent opening

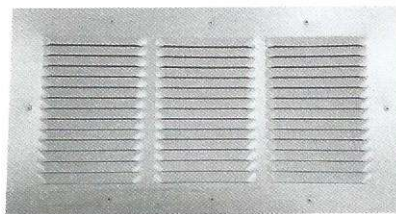

EZ Access® Crawl Space Door

For use with all skirting types and foundation siding.

Part #	Description
577-1802	EZ Access Crawl Space Door - 18" x 24", White Only. Comes with lock and key. <i>(Frame: 26 1/4" high x 34 5/8" wide)</i>

Door should not be installed near any existing/
 potential heat source or open flame.

Skirting & Accessories

Mini Gutter

Part #	Description
576-822	Cream
576-823	Brown
576-824	White



Metal J Channel

Part #	Description
575-711	3" x 144" White



Metal Bottom Starter

Part #	Description
575-715	4" x 12' White Bottom Starter

Metal Studs

575-35810	5/8" x 10' 25 Gauge
-----------	---------------------

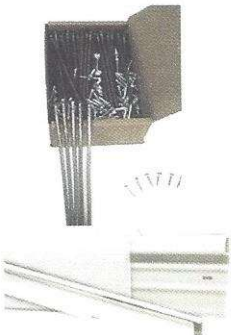

Hardware Kits for Vinyl Skirting

Part #	Description
572-800	100 Spikes/250 Screws



Spikes Only

Part #	Description
572-370	8" Ground Spikes 500 Per Carton

skylights

- Sun-Tek Dura Series Skylights are distinguished by their easy installation and their long-wearing durability.
- Dura Series are made with G.E Lexan® Resin.
- Dura Skylights are 30 times more impact resistant than acrylic skylights , 250 times more impact resistant than glass.
- The Polycarbonate is the same product used to produce airplane windows, auto bumpers and football helmets.
- Dura Skylights are UV stabilized for long lasting protection.
- Polycarbonate skylights resist temperature extremes from a frigid -60° below zero to an oven baking +250° degrees.
- Available in a bronze exterior with a clear or frosted interior finish, with your choice of single, double or triple domes.
- Each layer of air between domes enhances thermal protection Bronze and white metal curbs available for appropriate models.
- 20 Year "Corrosion Through" warranty on metal curb

Part #	Description
577-1430	16" x 32", Bronze
577-2230	24" x 32", Bronze
577-2246	24" x 48", Bronze



Diamond Combo Entry Door

Door Sizes	Standard Mill Storm	Standard White Storm
32 x 72 LH	711-3272L	721-3272L
32 x 72 RH	711-3272R	
32 x 74 LH	711-3274L	721-3274L*
32 x 74 RH	711-3274R	721-3274R*
32 x 76 LH	711-3276L	721-3276L
32 x 76 RH	711-3276R	721-3276R
32 x 78 LH	711-3278L	721-3278L*
32 x 78 RH	711-3278R*	721-3278R*
32 x 80 LH	711-3280L*	
32 x 80 RH	711-3280R*	
34 x 72 LH	711-3472L*	
34 x 72 RH	711-3472R*	
34 x 74 LH	711-3474L*	721-3474L*
34 x 74 RH	711-3474R*	721-3474R*
34 x 76 LH	711-3476L	721-3476L
34 x 76 RH	711-3476R	721-3476R
34 x 78 LH	711-3478L	721-3478L
34 x 78 RH	711-3478R	721-3478R
34 x 80 LH	711-3480L	721-3480L
34 x 80 RH	711-3480R	721-3480R
36 x 76 LH	711-3676L	721-3676L
36 x 76 RH	711-3676R	721-3676R
36 x 78 LH	711-3678L*	721-3678L*
36 x 78 RH	711-3678R*	721-3678R*
36 x 80 LH	711-3680L*	721-3680L
36 x 80 RH	711-3680R*	721-3680R
38 x 76 LH	711-3876L*	721-3876L*
38 x 76 RH	711-3876R*	721-3876R*
38 x 80 LH	711-3880L*	721-3880L
38 x 80 RH	711-3880R*	721-3880R
38 x 82 LH		721-3882L
38 x 82 RH		721-3882R*

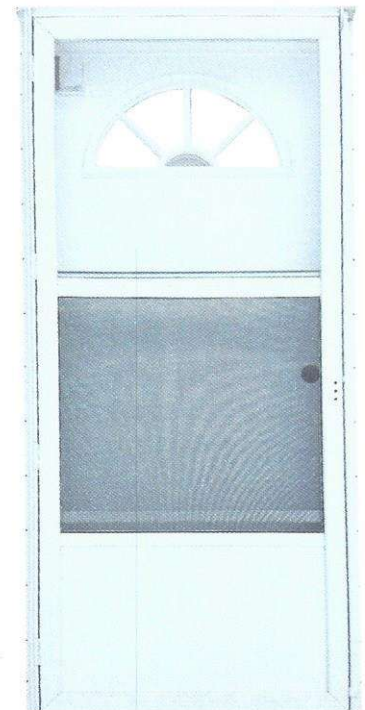
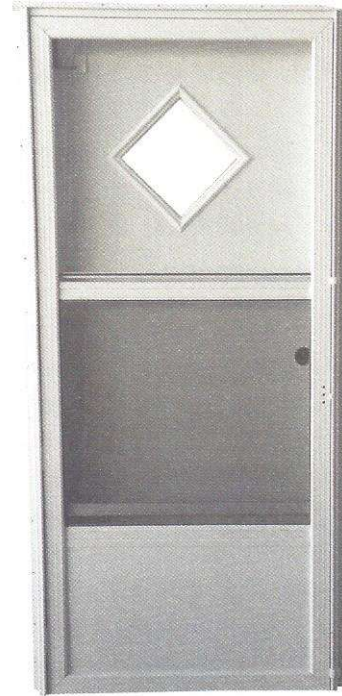

Fan-Lite Combo Entry Door

Door Sizes	Standard Mill Storm	Standard White Storm	White All Glass Storm
32 x 76 LH	713-3276L*		
32 x 76 RH	713-3276R*		
34 x 76 LH	713-3476L*	723-3476L	723-3476LAG*
34 x 76 RH	713-3476R*	723-3476R	723-3476RAG*

*Special Order and/or Special Order at some locations

Locks and Hardware sold separately.

Elixir Door Company Series 6000 Housetype Combination Doors are constructed from painted galvanized steel and attached to a high quality adjustable stop jamb. The weatherstripping on both the jamb and the folded edge steel door core create a double seal protecting against light, air, and water penetration. Other features include a highly efficient polyurethane foam insulation with high R-Values, and adjustable stop, a drive-in swivel lock bolt, and a sloped threshold. The storm door is 1-1/8" thick with a 1/8" tempered safety glass.

Blank Door with Knocker Viewer

Door Sizes	Standard White Storm
34 x 76 LH	727-3476L
34 x 76 RH	727-3476R

Elixir Door Company Series 6000 Housetype Combination Doors are constructed from painted galvanized steel and attached to a high quality adjustable stop jamb. The weatherstripping on both the jamb and the folded edge steel door core create a double seal protecting against light, air, and water penetration. Other features include a highly efficient polyurethane foam insulation with high R-Values, and adjustable stop, a drive-in swivel lock bolt, and a sloped threshold. The storm door is 1-1/8" thick with a 1/8" tempered safety glass.

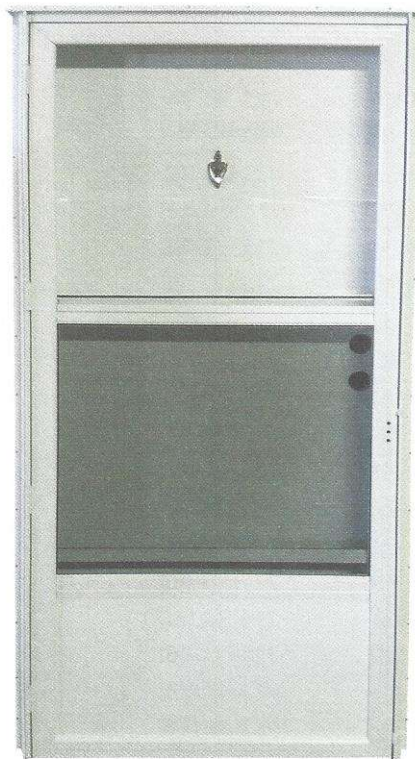

How to Effectively Measure Elixir 6000, 8000 & 9000 Series Doors

Call Size	Actual Pan Width Measurement	Actual Pan Length Measurement	Actual Width Measurement	Actual Lip Length Measurement	Actual Storm Core Width	Actual Storm Core Length
32" x 72"	29-7/8"	69-1/2"	31-1/8"	70-3/4"	30-1/16"	71
32" x 74"	29-7/8"	71-1/2"	31-1/8"	72-3/4"	30-1/16"	73
32" x 76"	29-7/8"	73-1/2"	31-1/8"	74-3/4"	30-1/16"	75
32" x 78"	29-7/8"	75-1/2"	31-1/8"	76-3/4"	30-1/16"	77
32" x 80"	29-7/8"	77-1/2"	31-1/8"	78-3/4"	30-1/16"	79
34" x 72"	31-7/8"	69-1/2"	33-1/8"	70-3/4"	32-1/16"	71
34" x 74"	31-7/8"	71-1/2"	33-1/8"	72-3/4"	32-1/16"	73
34" x 76"	31-7/8"	73-1/2"	33-1/8"	74-3/4"	32-1/16"	75
34" x 78"	31-7/8"	75-1/2"	33-1/8"	76-3/4"	32-1/16"	77
34" x 80"	31-7/8"	77-1/2"	33-1/8"	78-3/4"	32-1/16"	79
36" x 76"	33-7/8"	73-1/2"	35-1/8"	74-3/4"	34-1/16"	75
36" x 78"	33-7/8"	75-1/2"	35-1/8"	76-3/4"	34-1/16"	77
36" x 80"	33-7/8"	77-1/2"	35-1/8"	78-3/4"	34-1/16"	79
38" x 76"	35-1/2"	73-1/2"	36-3/4"	74-3/4"	35-1/8"	75
38" x 78"	35-1/2"	75-1/2"	36-3/4"	76-3/4"	35-1/8"	77
38" x 80"	35-1/2"	77-1/2"	36-3/4"	78-3/4"	35-1/8"	79
38" x 82"	35-1/2"	79-1/2"	36-3/4"	80-1/2"	35-1/8"	79

6-Panel Vinyl Steel Combination Entry Door

Door Sizes	Standard White Storm	All Glass White Storm
32 x 72 LH	737-3272L*	
32 x 72 RH	737-3272R*	
32 x 76 LR	737-3276L	
32 x 76 RH	737-3276R	
32 x 78 LH	737-3278L*	
32 x 78 RH	737-3278R*	
32 x 80 LH	737-3280L*	
32 x 80 RH	737-3280R*	
34 x 74 LH	737-3474L*	
34 x 74 RH	737-3474R*	
34 x 76 LH	737-3476L	757-3476L
34 x 76 RH	737-3476R	757-3476R
34 x 78 LH	737-3478L*	
34 x 78 RH	737-3478R*	
34 x 80 LH	737-3480L	757-3480L*
34 x 80 RH	737-3480R	757-3480R*
36 x 76 LH	737-3676L	757-3676L*
36 x 76 RH	737-3676R	757-3676R*
36 x 78 LH	737-3678L*	
36 x 78 RH	737-3678R*	
36 x 80LH	737-3680L	
36 x 80 RH	737-3680R	
38 x 76 LH	737-3876L	
38 x 76 RH	737-3876R	
38 x 78 LH	737-3878L*	
38 x 78 RH	737-3878R*	
38 x 80 LH	737-3880L	757-3880L*
38 x 80 RH	737-3880R	757-3880R*
38 x 82 LH	737-3882L	757-3882L*
38 x 82 RH	737-3882R	757-3882R*

Series 7000 Combination Entry Door

Door Sizes	Standard White Storm
34 x 76 LH	787-3476L*
34 x 76 RH	787-3476R*
34 x 78 LR	787-3478L*
34 x 78 RH	787-3478R*
34 x 80 LH	787-3480L*
34 x 80 RH	787-3480R*

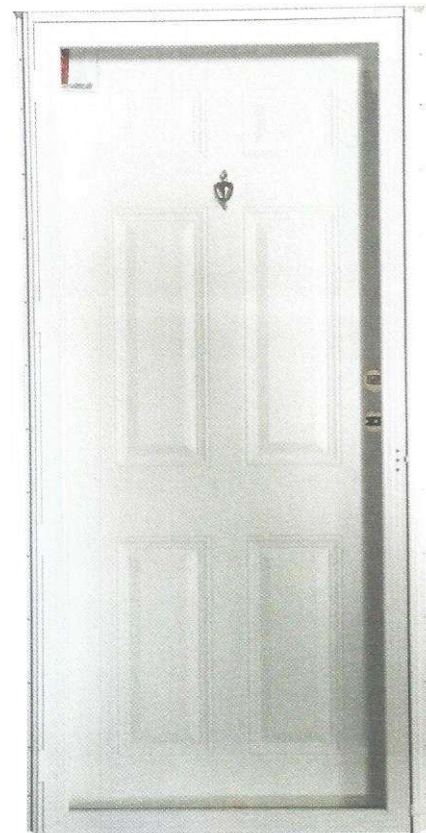

Series 9000 Combination Entry Door

*Special Order and/or Special Order at some locations
Locks and Hardware sold separately.

Series 9000 Cottage Combo Door

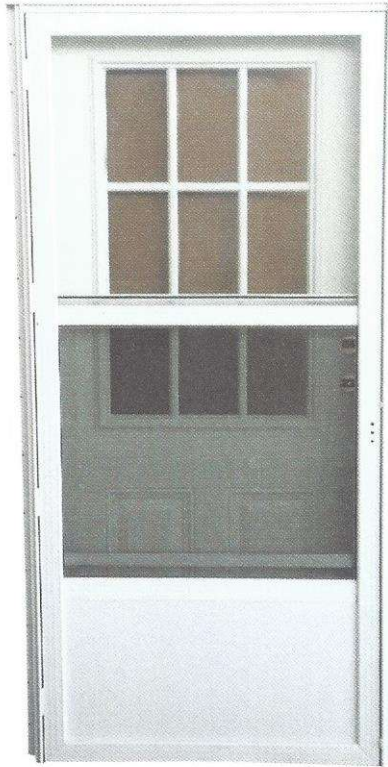

Door Sizes	Standard White Storm	All Glass White Storm
32 x 76 LH	732-3276L*	
32 x 76 RH	732-3276R*	
34 x 76 LH	732-3476L	732-3476LAG*
34 x 76 RH	732-3476R	732-3476RAG*
34 x 78 LR	732-3478L*	
34 x 78 RH	732-3478R*	
34 x 80 LH	732-3480L*	
34 x 80 RH	732-3480R*	
36 x 76 LH	732-3676L*	
36 x 76 RH	732-3676R*	
36 x 80 LH	732-3680L*	
36 x 80 RH	732-3680R*	
38 x 76 LH	732-3876L*	
38 x 76 RH	732-3876R*	

Door Sizes	Standard White Storm	All Glass White Storm
32 x 76 LH	733-3276L*	
32 x 76 RH	733-3276R*	
34 x 76 LH	733-3476L	733-3476LAG
34 x 76 RH	733-3476R	733-3476RAG*
34 x 78 LR	733-3478L*	
34 x 78 RH	733-3478R*	
34 x 80 LH	733-3480L	733-3480LAG*
34 x 80 RH	733-3480R	733-3480RAG*
36 x 76 LH	733-3676L*	733-3676LAG*
36 x 76 RH	733-3676R*	733-3676RAG*
36 x 78 LH	733-3678L*	
36 x 78 RH	733-3678R*	
38 x 76 LH	733-3876L*	
38 x 76 RH	733-3876R*	
36 x 80 LH	733-3680L*	
36 x 80 RH	733-3680R*	
38 x 80 LH	733-3880L*	733-3880LAG*
38 x 80 RH	733-3880R*	733-3880RAG*
38 x 82 LH	733-3882L*	
38 x 82 RH	733-3882R*	

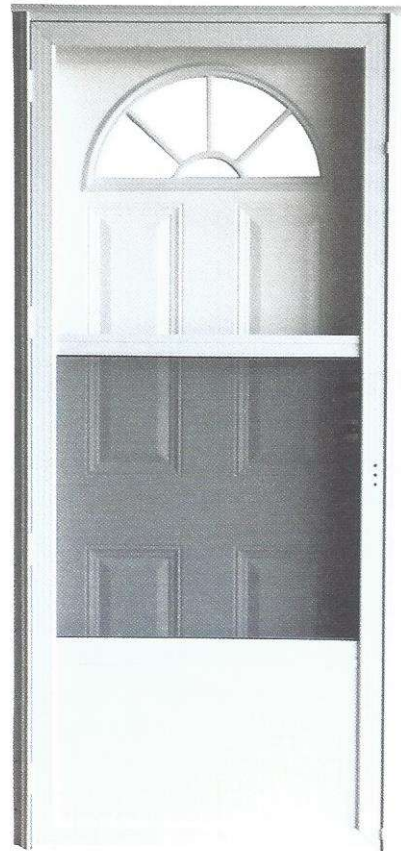

Series 9000 Fan-Lite Combination Entry Door

*Special Order and/or Special Order at some locations
Locks and Hardware sold separately.

How to Effectively Measure Elixir 1 3/4" 7000 SERIES

Call Size	Actual STR Core Width Measurement	Actual STR Core Length Measurement	Actual Storm Core Width	Actual Storm Core Length
34" x 76"	32-1/8"	73-1/2"	32-1/16"	75"
34" x 78"	32-1/8"	75-1/2"	32-1/16"	77"
34" x 80"	32-1/8"	77-1/2"	32-1/16"	79"
34" x 82"	32-1/8"	79-1/4"	32-1/16"	81"
38" x 76"	35-5/8"	73-1/2"	35-5/8"	75"
38" x 80"	35-5/8"	77-1/2"	35-5/8"	79"
38" x 82"	35-5/8"	79-1/4"	35-5/8"	81"

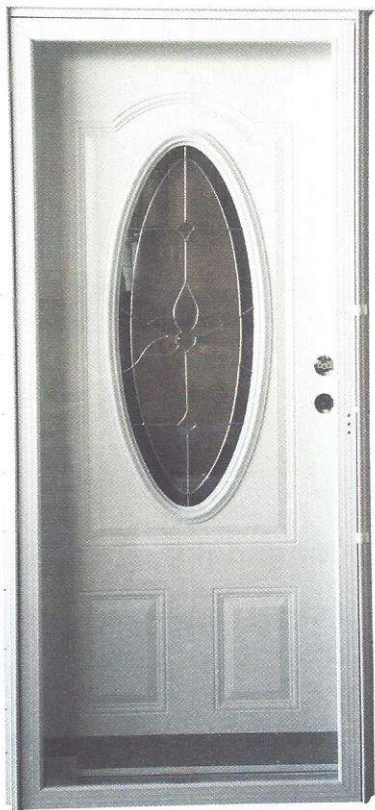

Door Sizes All Glass White Storm

34 x 76 LH	738-3476L
34 x 76 RH	738-3476R
34 x 78 LR	
34 x 78 RH	
34 x 80 LH	738-3480L
34 x 80 RH	738-3480R
36 x 76 LH	738-3676L*
36 x 76 RH	738-3676R*
36 x 80 LH	738-3680L*
36 x 80 RH	738-3680R*
38 x 76 LH	738-3876L*
38 x 76 RH	738-3876R*
38 x 80 LH	738-3880L*
38 x 80 RH	738-3880R*
38 x 82 LH	738-3882L*
38 x 82 RH	738-3882R*

Elixir Door Company Series 9000 Vinyl Steel Housetype doors are constructed from our thickest gauge of high quality vinyl laminated steel. Our high-quality adjustable stop wood jamb with an optional lifetime warranty weatherstripping. Series 9000 doors are equipped with a folded steel edge creating a double seal to protect against air, light, and water penetration. The Series 9000 features energy efficient polyurethane insulation, a drive-in swivel lock bolt, an optional deadbolt, and a 3-fin vinyl sweep. The storm door is 1-1/8" thick with 1/8" tempered safety glass. The decorative glass comes with a ten-year warranty.

*Special Order and/or Special Order at some locations
Locks and Hardware sold separately.

Series 7000 Full Oval Combo Door

Door Sizes	All Glass White Storm
34 x 76 LH	748-3476L
34 x 76 RH	748-3476R
36 x 76 LH	748-3676L*
36 x 76 RH	748-3676R*
36 x 80 LH	748-3680L*
36 x 80 RH	748-3680R*
38 x 80 LH	748-3880L*
38 x 80 RH	748-3880R*
38 x 82 LH	748-3882L*
38 x 82 RH	748-3882R*

- Vinyl Laminated Galvanized Steel
 - Our thickest gauge of long lasting steel
 - An upgrade from the Series 9000 Steel door
- Lifetime Warranty Weatherstripping
 - Protects against air, light, and water
- 1-3/4" Residential Door with Storm
- Polyurethane Foam Core
 - Highly Energy Efficient
- Quality Cellular PVC One Piece Residential type Jamb
- Entrance and Dead Bolt Swivel Bolts
 - Easy Lock Installation
- Six Fin Vinyl Sweep
- Storm Door with Built-in Drip Cap

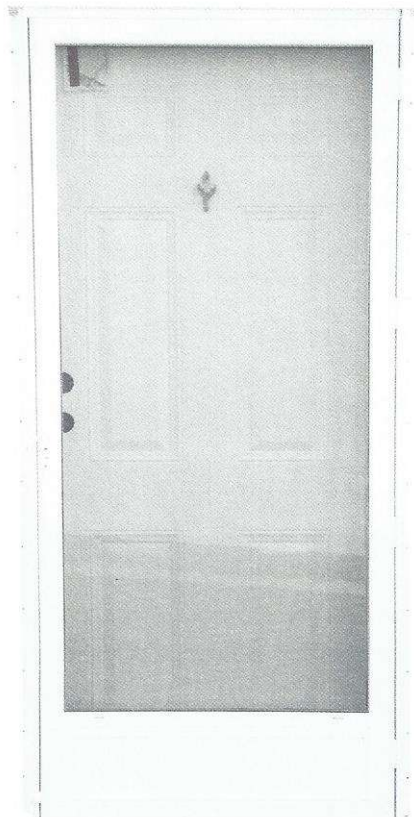

6-Panel Vinyl Steel Combination Entry Door

Door Sizes	Full View White Storm
34 x 76 LH	747-3476L
34 x 76 RH	747-3476R
34 x 78 LH	747-3478L*
34 x 78 RH	747-3478R*
34 x 80 LH	747-3480L*
34 x 80 RH	747-3480R*
38 x 82 LH	747-3882L*
38 x 82 RH	747-3882R*

Elixir Door Company Series STR 7000 Residential Combination 6-Panel doors are equivalent to typical doors found in site-built homes. Series STR 7000 doors are constructed from our thickest gauge of high quality vinyl laminated galvanized steel. The Series STR 7000 features energy efficient polyurethane insulation, a drive in swivel lock bolt, a dead bolt with a swivel lock bolt, a vinyl sweep, and an optional knocker-viewer. The storm door with a built-in drip cap has three options: conventional, all glass full-view, and full-view. The storm door is 1-1/8" thick with a 1/8" tempered safety glass.

*Special Order and/or Special Order at some locations
Locks and Hardware sold separately.

Diamond and Blank Outswing

Door Sizes	Diamond White/White/Mill	Blank White/White/White	Diamond with Deadbolt White/White/Mill	Diamond with Deadbolt White/White/White
30 x 72 LH	811-3072L	821-3072L*		
30 x 72 RH	811-3072R			
30 x 74 LH	811-3074L*			
30 x 74 RH	811-3074R*			
32 x 72 LH	811-3272L	821-3272L	811-3272LDB*	821-3272LDB*
32 x 72 RH	811-3272R	821-3272R*	811-3272RDB*	821-3272RDB*
32 x 74 LH	811-3274L		811-3274LDB*	
32 x 74 RH	811-3274R*			
32 x 76 LH	811-3276L	821-3276L	811-3276LDB*	821-3276LDB*
32 x 76 RH	811-3276R	821-3276R	811-3276RDB*	821-3276RDB
32 x 78 LH	811-3278L	821-3278L		
32 x 78 RH	811-3278R	821-3278R		
32 x 80 LH	811-3280L*			
32 x 80 RH	811-3280R*			
34 x 72 LH	811-3472L*			
34 x 72 RH	811-3472R*			
34 x 74 LH	811-3474L			
34 x 74 RH	811-3474R*			
34 x 76 LH	811-3476L	821-3476L	811-3476LDB*	821-3476LDB
34 x 76 RH	811-3476R	821-3476R	811-3476RDB*	821-3476RDB
34 x 78 LH	811-3478L			
34 x 78 RH	811-3478R			
34 x 80 LH	811-3480L	821-3480L		
34 x 80 RH	811-3480R	821-3480R		
36 x 74 LH	811-3674L*			
36 x 74 RH	811-3674R*			
36 x 76 LH	811-3676L	821-3676L		
36 x 76 RH	811-3676R	821-3676R		
36 x 78 LH	811-3678L*			
36 x 78 RH	811-3678R*			
36 x 80 LH	811-3680L	821-3680L		
36 x 80 RH	811-3680R	821-3680R		
38 x 76 LH	811-3876L*			
38 x 76 RH	811-3876R*			
38 x 80 LH	811-3880L*			
38 x 80 RH	811-3880R*			

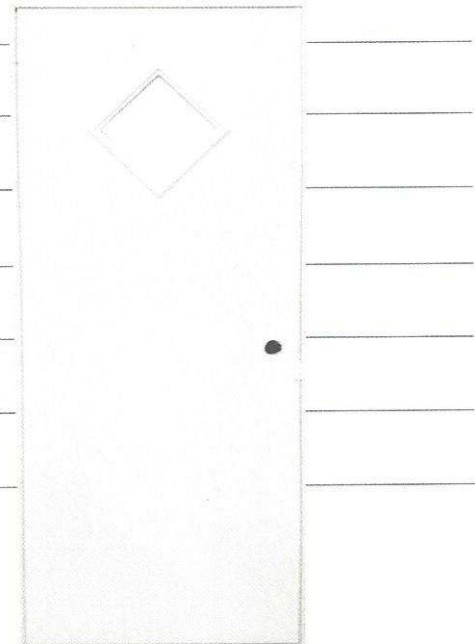

*Special Order and/or Special Order at some locations
Locks and Hardware sold separately.

Series 200 doors are constructed from painted galvanized steel and then attached to a heavy-duty aluminum frame ensuring stability as well as safety and security. The folded edge blocks air, light, and water. Other features include highly energy efficient polyurethane foam insulation with high R-Values, adjustable striker plates, and both the frame and the door are dead bolt prepped. In addition, the Series 200 features weatherstripping on the door frame and door core creating a double seal.

Cottage Outswing

Door Sizes	White/White/Mill	White/White/White	Cottage W/W/M with Deadbolt	Cottage W/W/W with Deadbolt
32 x 72 LH			812-3272LDB	822-3272LDB
32 x 72 RH			812-3272RDB	822-3272RDB
32 x 74 LH	812-3274L*			
32 x 74 RH	812-3274R*			
32 x 76 LH	812-3276L	822-3276L	812-3276LDB	822-3276LDB*
32 x 76 RH	812-3276R	822-3276R	812-3276RDB	822-3276RDB*
32 x 80 LH	812-3280L*			
32 x 80 RH	812-3280R*			
34 x 76 LH	812-3476L	822-3476L	812-3476LDB	822-3476LDB
34 x 76 RH	812-3476R	822-3476R	812-3476RDB	822-3476RDB
34 x 78 LH	812-3478L*			
34 x 78 RH	812-3478R*			
34 x 80 LH	812-3480L*	822-3480L		822-3480LDB*
34 x 80 RH	812-3480R*	822-3480R*		822-3480RDB*
36 x 76 LH	812-3676L*			
36 x 76 RH	812-3676R*			
36 x 80 LH	812-3680L			
36 x 80 RH	812-3680R			

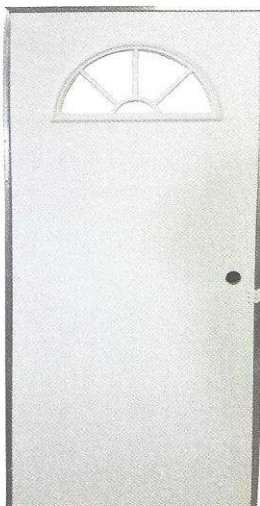

Fan Outswing

Door Sizes	White/White/Mill No Deadbolt	White/White/Mill with Deadbolt	White/White/White with Deadbolt
32 x 72 LH		813-3272LDB	823-3272LDB
32 x 72 RH		813-3272RDB	823-3272RDB
32 x 76 LH	813-3276L*	813-3276LDB*	823-3276LDB
32 x 76 RH	813-3276R*	813-3276RDB	823-3276RDB
34 x 76 LH	813-3476L	813-3476LDB*	823-3476LDB
34 x 76 RH	813-3476R	813-3476RDB*	823-3476RDB
34 x 78 LH	813-3478L*		
34 x 78 RH	813-3478R*		

*Special Order and/or Special Order at some locations
Locks and Hardware sold separately.

Blank Outswing

Door Sizes	White/White/Mill	White/Cream/Mill	White/White/White	With Dead Bolt
20 x 60	816-2060			
24 x 60	816-2460			
30 x 72	816-3072			
30 x 74	816-3074*			
30 x 76	816-3076*			
30 x 78	816-3078*			
32 x 72	816-3272		826-3272	816-3272DB
32 x 74	816-3274		826-3274*	816-3274DB*
32 x 76	816-3276		826-3276	816-3276DB*
32 x 78	816-3278		826-3278*	
32 x 80	816-3280*		826-3280*	
34 x 72	816-3472*			
34 x 74	816-3474*			
34 x 76	816-3476		826-3476	816-3476DB*
34 x 78	816-3478		826-3478	
34 x 80	816-3480		826-3480*	816-3480DB*
36 x 72	816-3672	816-3672C	826-3672*	
36 x 76	816-3676		826-3676*	
36 x 78	816-3678*			
36 x 80	816-3680		826-3680	
38 x 76	816-3876*			
38 x 80	816-3880*			
48 x 60	816-4860			
48 x 72	816-4872	816-4872C		
48 x 76	816-4876	816-4876C*		
48 x 80	816-4880	816-4880C*		

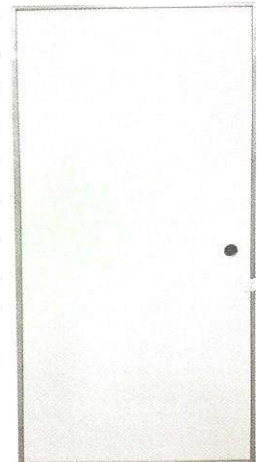

Double Outswing

Door Sizes	White/White/Mill	White/White/White
72 x 72	816-7272	826-7272*
72 x 76	816-7276	826-7276*
72 x 80	816-7280*	826-7280

How to Effectively Measure Elixir Regular Outswing Wide Doors 200 Series

Call Size	Actual Pan Width Measurement	Actual Pan Length Measurement	Actual Width Measurement	Actual Lip Length Measurement
42" x 72"	40-3/4"	70-3/4"	42"	72"
42" x 76"	40-3/4"	74-3/4"	42"	76"
42" x 78"	40-3/4"	76-3/4"	42"	78"
42" x 80"	40-3/4"	78-3/4"	42"	80"
46" x 72"	45-1/4"	70-3/4"	46-1/2"	72"
46" x 75"	45-1/4"	70-3/4"	46-1/2"	72"
46" x 76"	45-1/4"	74-3/4"	46-1/2"	76"
46" x 78"	45-1/4"	76-3/4"	46-1/2"	78"
48" x 72"	46-3/4"	70-3/4"	48"	72"
48" x 76"	46-3/4"	74-3/4"	48"	76"
48" x 78"	46-3/4"	76-3/4"	48"	78"
48" x 80"	46-3/4"	78-3/4"	48"	80"

How to Effectively Measure Elixir Regular Outswing Doors 200 and 400 Series

Call Size	Actual Pan Width Measurement	Actual Pan Length Measurement	Actual Width Measurement	Actual Lip Length Measurement
61" x 72"	59-3/4"	70-3/4"	61"	72"
61" x 75"	59-3/4"	73-3/4"	61"	75"
70½" x 75"	69-3/4"	73-3/4"	70-1/2"	75"
72" x 72"	70-3/4"	70-3/4"	72"	72"
72" x 76"	70-3/4"	74-3/4"	72"	76"
72" x 80"	70-3/4"	78-3/4"	72"	80"
73" x 72"	71-3/4"	70-3/4"	73"	82"
73" x 72"	71-3/4"	74-3/4"	73"	76"
73" x 72"	73-3/4"	78-3/4"	73"	80"

How to Effectively Measure Elixir Regular Outswing Doors 200, 300 and 400

Call Size	Actual Pan Width Measurement	Actual Pan Length Measurement	Actual Width Measurement	Actual Lip Length Measurement
32" x 72"	30-3/4"	70-3/4"	32"	72"
32" x 74"	30-3/4"	72-3/4"	32"	74"
32" x 76"	30-3/4"	74-3/4"	32"	76"
32" x 78"	30-3/4"	76-3/4"	32"	78"
32" x 80"	30-3/4"	78-3/4"	32"	80"
34" x 72"	32-3/4"	70-3/4"	34"	72"
34" x 74"	32-3/4"	72-3/4"	34"	74"
34" x 76"	32-3/4"	74-3/4"	34"	76"
34" x 78"	32-3/4"	76-3/4"	34"	78"
34" x 80"	32-3/4"	78-3/4"	34"	80"
36" x 72"	34-3/4"	70-3/4"	36"	72"
36" x 74"	34-3/4"	72-3/4"	36"	74"
36" x 76"	34-3/4"	74-3/4"	36"	76"
36" x 78"	34-3/4"	76-3/4"	36"	78"
36" x 80"	34-3/4"	78-3/4"	36"	80"

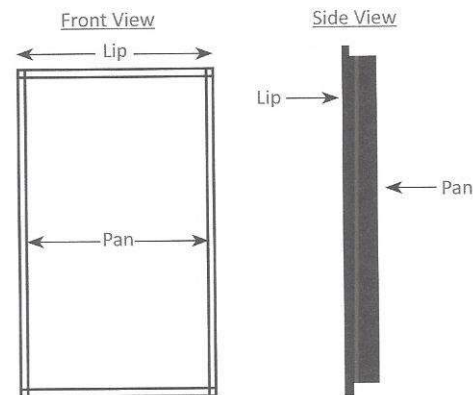

Note: For regular doors the lip will be on the outside of the home, and the pan will be inside the home (200, 300 & 400 series).

These doors will have aluminum frames. For Housetype doors the lip will be inside the home, and the pan will be outside the home.

The housetype door will have a storm door & the pan faces towards the storm door. These doors will have wood jambs.

Fan Steel Outswing

Door Sizes	White/White/White
32 x 76 LH	833-3276L*
32 x 76 RH	833-3276R*
34 x 76 LH	833-3476L
34 x 76 RH	833-3476R

Cottage Steel Outswing

Door Sizes	White/White/White
32 x 76 LH	832-3276L
32 x 76 RH	832-3276R
32 x 78 RH	832-3278L
32 x 78 RH	832-3278R
34 x 76 LH	832-3476L
34 x 76 RH	832-3476R
34 x 78 RH	832-3478L
34 x 78 RH	832-3478R*
34 x 80 LH	832-3480L*
34 x 80 RH	832-3480R*
36 x 76 LH	832-3676L*
36 x 76 RH	832-3676R*
36 x 80 LH	832-3680L

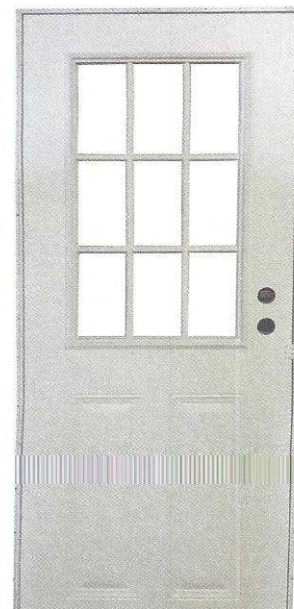

Slider Outswing

Door Sizes	White/White/Mill	White/White/White
30 x 72 LH	814-3072L*	
30 x 72 RH	814-3072R*	
32 x 72 LH	814-3272L	824-3272L*
32 x 72 RH	814-3272R*	
32 x 74 LH	814-3274L*	
32 x 74 RH	814-3274R*	
32 x 76 LH	814-3276L	824-3276L
32 x 76 RH	814-3276R	824-3276R
32 x 78 LH	814-3278L*	
32 x 78 RH	814-3278R*	
34 x 76 LH	814-3476L	824-3476L
34 x 76 RH	814-3476R	824-3476R
34 x 78 RH		824-3478L
34 x 78 LH		824-3478R
34 x 80 LH	814-3480L*	
34 x 80 RH	814-3480R*	
36 x 76 LH	814-3676L*	
36 x 76 RH	814-3676R	
36 x 80 LH	814-3680L*	824-3680L
36 x 80 RH	814-3680R*	824-3680R



6 Panel Steel Outswing

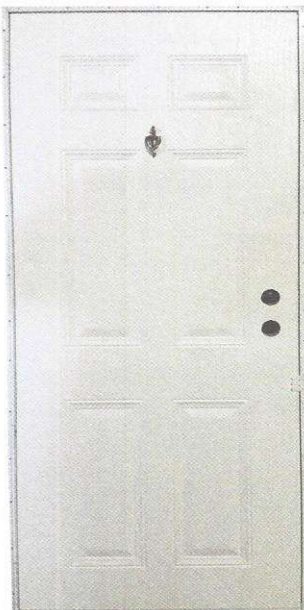

Door Sizes	White/White/White
32 x 72 LH	837-3272L*
32 x 72 RH	837-3272R*
32 x 74 LH	837-3274L*
32 x 74 RH	837-3274R*
32 x 76 LH	837-3276L
32 x 76 RH	837-3276R
32 x 80 LH	837-3280L*
32 x 80 RH	837-3280R*
34 x 76 LH	837-3476L
34 x 76 RH	837-3476R
34 x 78 LH	837-3478L
34 x 78 RH	837-3478R
34 x 80 LH	837-3480L
34 x 80 RH	837-3480R*
36 x 76 LH	837-3676L*
36 x 76 RH	837-3676R*
36 x 78 LH	837-3678L*
36 x 78 RH	837-3678R*
36 x 80 LH	837-3680L*
36 x 80 RH	837-3680R*

3/4 Oval Steel Outswing

Door Sizes	White/White/White
32 x 76 LH	837-3276LO
32 x 76 RH	837-3276RO
34 x 76 LH	837-3476LO
34 x 76 RH	837-3476RO
36 x 80 LH	837-3680LO
36 x 80 RH	837-3680RO

*Special Order and/or Special Order at some locations
Locks and Hardware sold separately.

Elixir Doors

Storm Doors ONLY

Door Sizes	Standard Mill Storm Door Only	Standard White Storm Door Only	Full View White Storm Door Only	All Glass White Storm Door Only
32 x 72 LH	611-3272L*	612-3272L*		
32 x 72 RH	611-3272R*	612-3272R*		
32 x 74 LH	611-3274L*	612-3274L*		
32 x 74 RH	611-3274R*	612-3274R*		
32 x 76 LH	611-3276L	612-3276L		
32 x 76 RH	611-3276R	612-3276R		
32 x 78 LH	611-3278L*	612-3278L*		
32 x 78 RH	611-3278R*	612-3278R*		
32 x 80 LH	611-3280L	612-3280L		
32 x 80 RH	611-3280R	612-3280R		
34 x 74 LH	611-3474L*			
34 x 74 RH	611-3474R*			
34 x 76 LH	611-3476L	612-3476L	622-3476L	623-3476L
34 x 76 RH	611-3476R	612-3476R	622-3476R	623-3476R
34 x 78 LH	611-3478L*	612-3478L*	622-3478L*	
34 x 78 RH	611-3478R*	612-3478R*	622-3478R*	
34 x 80 LH	611-3480L*	612-3480L	622-3480L*	623-3480L*
34 x 80 RH	611-3480R*	612-3480R	622-3480R*	623-3480R*
36 x 76 LH	611-3676L*	612-3676L		623-3676L*
36 x 76 RH	611-3676R	612-3676R		623-3676R*
36 x 78 LH		612-3678L*		
36 x 78 RH		612-3678R*		
36 x 80 LH		612-3680L		623-3680L
36 x 80 RH		612-3680R		623-3680R*
38 x 76 LH		612-3876L	622-3876L*	623-3876L*
38 x 76 RH		612-3876R	622-3876R*	623-3876R*
38 x 78 LH		612-3878L*		
38 x 78 RH		612-3878R*		
38 x 80 LH		612-3880L	622-3880L*	623-3880L*
38 x 80 RH		612-3880R	622-3880R*	623-3880R*
38 x 82 LH		612-3882L	622-3882L*	623-3882L*
38 x 82 RH		612-3882R	622-3882R*	623-3882R*

Double French Door (Out Swing Only)

Door Sizes	White/White/White	Description
72 x 76	825-7276L*	15 Lite, Steel, Left Hand,
72 x 76	825-7276LI	15 Lite, Steel, Left Hand, Insulated
72 x 76	825-7276R*	15 Lite, Steel, Right Hand
72 x 76	825-7276RI	15 Lite, Steel, Right Hand, Insulated
72 x 80	825-7280LI*	15 Lite, Steel, Left Hand, Insulated
72 x 80	825-7280RI*	15 Lite, Steel, Right Hand, Insulated



*Special Order and/or Special Order at some locations

Striker Plates

Part #	Description
670-122	Old Type Outswing Door Striker Plate
670-122HT	House Type Door Striker Plate
670-122MH	Mobile Home Door Outswing Striker Plate
670-124	Brass
670-124A	Satin Nickel



670-122



670-122MH



670-122HT

Entrance Drive-In

Part #	Description
710-108	Adjustable latch bolt only
710-108D	2-3/8" Drive-in Bolt/Backset



Entrance Deadbolt Drive-In Latch

Part #	Description
710-109D	2-3/8" Deadbolt
710-109B	2-3/4" Deadbolt



Sliding Glass Door Lock

Part #	Description
660-505	White
660-507	Black



Sliding Glass Door Rollers

Part #	Description
660-500	Rollers



Sliding Glass Screen Door Screen Rollers

Part #	Description
692-385	Screen Door Rollers



Door Hinges (Pair)

Part #	Description
670-123	Brass
670-123A	Satin Nickel
670-123P	Flag Hinge Non-Mortise w/wood screws
670-126	Hinges for 6 Panel Interior Doors - Brass
670-126A	Hinges for 6 Panel Interior Doors - Satin Nickel
670-126P	2 Hinges & Screws for 6 Panel Interior Doors



670-126A



670-123 & 123A

Door Parts & Accessories

Elixir Window Replacements

Fan-Lite

Part #	Description
680-208	Fan-Lite



10" x 10" Diamond Window

Part #	Description
710-120	Complete Frames & Glass-Brown
710-120W	Complete Frames & Glass-White

9-Lite Cottage

Part #	Description
680-209	20" x 36"

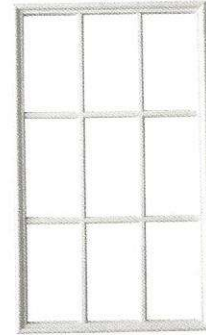

Slot Window

Part #	Description
710-114	4" x 24", Clear
710-117	4" x 24", Obscure*



680-119

Elixir Replacement Door Knocker

Part #	Description
710-122	Viewer/Knocker



Window Slider

Part #	Description
680-119	Mill 18 x 20
680-119W	White 18 x 20*
680-120	Mill 18 x 40*
680-120W	White 18 x 40*

Door Hinges

House Type Door Hinge

Part #	Description
670-129	Zinc Off Set - fits 6000 and 9000 series doors
710-22-0392	Zinc Off Set - fits 7000 series doors

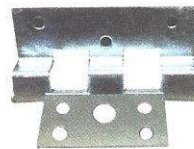

670-129



710-22-0392

Outswing Door Hinge

Part #	Description
670-131	Mill
670-132	White

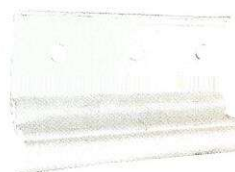

Storm Door Hinge

Part #	Description
670-128	White
670-128M	Zinc

Part #	Description
671-2478	24W x 78H; White Flush
671-2480	24W x 80H; White Flush
671-2678	26W x 78H; White Flush
671-2680	26W x 80H; White Flush
671-2878	28W x 78H; White Flush
671-2880	28W x 80H; White Flush
671-3078	30W x 78H; White Flush
671-3080	30W x 80H; White Flush
671-3278	32W x 78H; White Flush
671-3678	36W x 78H; White Flush
673-2478	24W x 78H; White-6 Panel
673-2480	24W x 80H; White-6 Panel
673-2878	28W x 78H; White 6-Panel
673-2880	28W x 80H; White-6 Panel
673-3078	30W x 78H; White-6 Panel
673-3080	30W x 80H; White-6 Panel
673-3278	32W x 78H; White-6 Panel
673-3678	36W x 78H; White-6 Panel
672-2080	20W x 80H; Oak-Flush
672-2478	24W x 78H; Oak-Flush
672-2480	24W x 80H; Oak-Flush
672-2678	26W x 78H; Oak-Flush
672-2680	26W x 80H; Oak-Flush
672-2878	28W x 78H; Oak-Flush
672-2880	28W x 80H; Oak-Flush
672-3078	30W x 78H; Oak-Flush
672-3080	30W x 80H; Oak-Flush
672-3278	32W x 78H; Oak-Flush
672-3678	36W x 78H; Oak-Flush

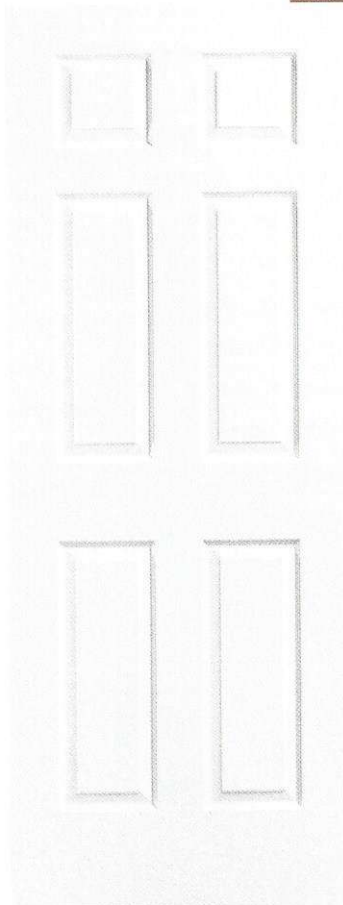
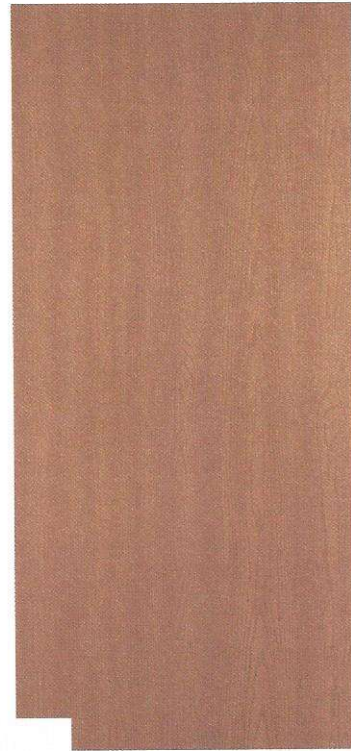

Molding

Item #	Description	Color	Carton Qty.
583-40	3/16" x 7/8" x 8' Batten Oak	Chesapeake Oak	300
583-40B	3/16" x 7/8" x 8' Batten Cherry	Velvet Cherry	300
583-40W	3/16" x 7/8" x 8' Batten White	White	300
583-41	3/16" x 1" x 8' Batten Oak	Chesapeake Oak	250
583-41B	3/16" x 1" x 8' Batten Cherry	Velvet Cherry	250
583-41W	3/16" x 1" x 8' Batten White	White	250
583-42	3/16" x 1.5" x 8' Batten Oak	Chesapeake Oak	175
583-42B	3/16" x 1.5" x 8' Batten Cherry	Velvet Cherry	175
583-42W	3/16" x 1.5" x 8' Batten White	White	175
583-422	3/16" x 2" x 8' Batten Oak	Chesapeake Oak	125
583-422B	3/16" x 2" x 8' Batten Cherry	Velvet Cherry	125
583-422W	3/16" x 2" x 8' Batten White	White	125
583-43	1/2" x 11/16" x 7' Light Shoe Molding - Oak	Chesapeake Oak	150
583-43B	1/2" x 11/16" x 7' Shoe Molding - Cherry	Velvet Cherry	150
583-43W	1/2" x 11/16" x 7' Shoe Molding - White	White	150
583-44	3/8" x 3/4" x 7' Door Stop Molding - Oak	Chesapeake Oak	150
583-44B	3/8" x 3/4" x 7' Door Stop Molding - Cherry	Velvet Cherry	150
583-44W	3/8" x 3/4" x 7' Door Stop Molding - White	White	150
583-45	7/32" x 1-9/16" x 7'1.5" x 7' Casing - Oak	Chesapeake Oak	110
583-45B	7/32" x 1-9/16" x 7'1.5" x 7' Casing - Cherry	Velvet Cherry	110
583-45W	7/32" x 1-9/16" x 7'1.5" x 7' Casing - White	White	110
583-46	1/2" x 2-1/4" x 7'2" Casing - Oak	Chesapeake Oak	50
583-46B	1/2" x 2-1/4" x 7'2" Casing - Cherry	Velvet Cherry	50
583-46W	1/2" x 2-1/4" x 7'2" Casing - White	White	50
583-47	1" x 1" x 8' Outside Corner - Oak	Chesapeake Oak	105
583-47B	1" x 1" x 8' Outside Corner - Cherry	Velvet Cherry	105
583-47W	1" x 1" x 8' Outside Corner - White	White	105
583-48	5/16" x 5/16" x 8' Inside Corner - Oak	Chesapeake Oak	195
583-48B	5/16" x 5/16" x 8' Inside Corner - Cherry	Velvet Cherry	195
583-48W	5/16" x 5/16" x 8' Inside Corner - White	White	195
583-49	3/8" x 2-3/4" x 10' Base - Oak	Chesapeake Oak	30
583-49B	3/8" x 2-3/4" x 10' Base - Cherry	Velvet Cherry	30
583-49W	3/8" x 2-3/4" x 10' Base - White	White	30



Item #	Description	Color	Carton Qty.
583-50	3/8" x 1-3/16" x 7' Door Stop - Oak	Chesapeake Oak	100
583-50B	3/8" x 1-3/16" x 7' Door Stop - Cherry	Velvet Cherry	100
583-50W	3/8" x 1-3/16" x 7' Door Stop - White	White	100
583-51	3/8" x 2-7/32" x 10' Chair Rail - Oak MFD	Chesapeake Oak	45
583-51B	3/8" x 2-7/32" x 10' Chair Rail - Cherry MFD	Velvet Cherry	45
583-51W	3/8" x 2-7/32" x 10' Chair Rail - White MFD	White	45
583-52	3/8" x 2" x 10' Casing - Oak	Chesapeake Oak	80
583-52B	3/8" x 2" x 10' Casing - Cherry	Velvet Cherry	80
583-52W	3/8" x 2" x 10' Casing - White	White	80
583-53	11/32" x 3" 1/2" x 10' Crown - Oak	Chesapeake Oak	50
583-53B	11/32" x 2-1/2" x 10' Crown - Cherry	Velvet Cherry	50
583-53W	11/32" x 2-1/2" x 10' Crown - White	White	50
583-54	3/8" x 1-3/4" x 10' Crown - Oak	Chesapeake Oak	80
583-54B	3/8" x 1-3/4" x 10' Crown - Cherry	Velvet Cherry	80
583-54W	3/8" x 1-3/4" x 10' Crown - White	White	80
583-56	1/2" x 3-1/4" x 7' Door Jamb - Oak	Chesapeake Oak	30
583-56B	1/2" x 3-1/4" x 7' Door Jamb - Cherry	Velvet Cherry	30
583-56W	1/2" x 3-1/4" x 7' Door Jamb - White	White	30
583-57	1/2" x 4-1/2" x 7' Door Jamb - Oak	Chesapeake Oak	20
583-57B	1/2" x 4-1/2" x 7' Door Jamb - Cherry	Velvet Cherry	20
583-57W	1/2" x 4-1/2" x 7' Door Jamb - White	White	20
583-58	1/2" x 6" x 7' Door Jamb - Oak	Chesapeake Oak	20
583-58B	1/2" x 6" x 7' Door Jamb - Cherry	Velvet Cherry	20
583-58W	1/2" x 6" x 7' Door Jamb - White	White	20



583-46W & 583-52W



583-56W



583-50W



583-53W



583-54W

Door Locks & Accessories

Master Key for Lockware 710-110



Entrance Lock Only (40 per box)

Part #	Description
710-106	Stainless Steel Adjustable
710-106B	Brass Adjustable
710-106D	Stainless without Bolt

Deadbolt Lock Only (40 per box)

Part #	Description
710-5176	Stainless Steel Adjustable
710-107B	Brass Adjustable



Entrance Lock & Deadbolt Set (20 per box)

Part #	Description
710-105	Stainless Steel Adjustable
710-105D	Stainless Steel without Bolts
710-105MK	Stainless Steel Both Locks Master Keyed Adjustable
710-105B	Brass Both Locks Master Keyed



Lever Combo Lock ADA Approved

Part #	Description
710-5178	Stainless Steel

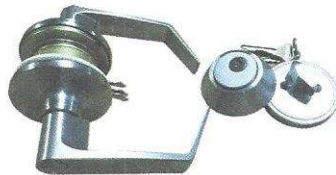

Interior Level Passage & Privacy Locks (3 per box)

Part #	Description
670-010	Lock Interior Brass Passage
670-011	Lock Interior Brass Privacy
670-012	Lock Interior Satin Nickel Passage
670-013	Lock Interior Satin Nickel Privacy



Polished Brass Passage & Privacy Lock –Interior

Polished brass with spherical knob, contemporary design, 2-3/8" round drive-in latch. (30 per box)

Part #	Description
670-114	Privacy Lockset, Brass
670-114A	Stainless Privacy
670-115	Passage Lockset, Brass
670-115A	Stainless Passage



J & D Lock Company Entry Door Locks (20 per box)

Part #	Description
710-092	Stainless Steel Entrance
710-092MK	Master Keyed
710-093	Polished Brass Entrance
710-094	Deadbolt, Stainless Steel
710-095	Deadbolt, Polished Brass
710-096	Combo, Stainless Steel
710-096MK	Master Keyed
710-099	Combo, Polished Brass
710-10020	Interior Keyed Privacy Lock

Pushbutton Latch (5 per box)

- Anti-lockout feature
- 1-3/4" mounting hold spacing
- Installs in three 1/4" holes
- Carded

For all out-swinging doors 7/8" to 1-1/4"
Converts to key locking set with key plug.

Part #	Description
710-131	Black
710-131W	White



Door Closer - Latch Kit (30 per box)

Smooth, silent regulated closing for storm and screen doors. Permanently sealed tube. Positive-latching mechanism. Shock absorber action.

Part #	Description
710-129	Black
710-129W	White

Latch Sav'r (12 per box)

Part #	Description
710-59394	Stainless Steel
710-59398	White



Theft Stopper (12 per box)

Part #	Description
710-TS1	Theft Stop



Spring Stop

Part #	Description
670-125	Door Spring Stop



Deluxe Door Sweep

Part #	Description
710-75	Deluxe Door Sweep

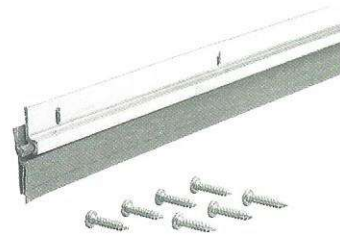

Chain Stop

Part #	Description
710-132	Anodized Storm Door Chain



Pneumatic Door Closer

Part #	Description
710-128B	Closer Only - black
710-128W	Closer Only - white



Self Adhesive Door Stop

Part #	Description
586-211	5"
586-210	3 1/4"



Door Locks & Accessories

PVC Foam Weather Strip

Part #	Description
710-60	1/4" x 3/8" x 17'
710-61	3/8" x 3/16" x 17'



Door Jamb Weather Strip

Part #	Description
710-65	36" x 84" Aluminum 3 Piece

Elixir Weather Strip

Part #	Description
710-66	Jamb Header 38"
710-67	Jamb, 82"



Elixir Threshold

Part #	Description
710-134A	32" - 34" Aluminum Threshold
710-5716	48" Aluminum Threshold
710-5721	72" Aluminum Threshold



3" x 3" Aluminum Threshold

Part #	Description
710-70	Low Profile
710-71	High Profile



Steel Drip Cap

Install over doors and windows to channel away rain and snow.

Part #	Description
710-134	Fits 30 - 32" Door (White Finish)
710-134-1	Fits 34" Door (White Finish)
710-134-2	Fits 36" Door (White Finish)
710-134-3	Fits 42" Door (White Finish)
710-133	Fits 48" Door (Mill Finish)
710-5821	Fits 72" Door (Mill Finish)



Kinro

- Large recessed mounting flange for behind-the-siding installation.
- Drop in glazing for easy maintenance and pane replacement.
- Interlocking meeting rails provide additional security and weatherproofing.
- Full pile weatherstripping at sash head and jambs for maximum weatherproofing.
- Spring loaded removable screens allow fast and easy cleaning of window and sill.
- Soft vinyl bulb gasket for additional weather seal.
- Sloped sill and large built-in weep holes for superior drainage.
- Jambs notched for multiple opening positions with spring loaded latches.
- Nylon glides enable easy window operation.

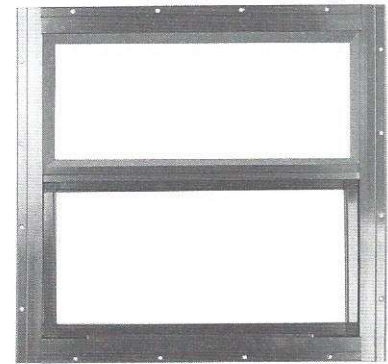

Part

681-3014H

682-3014H

Description

Horizontal Slider Window, Mill Finish With Screen

Horizontal Slider Window, White Finish



9750 Series Features:

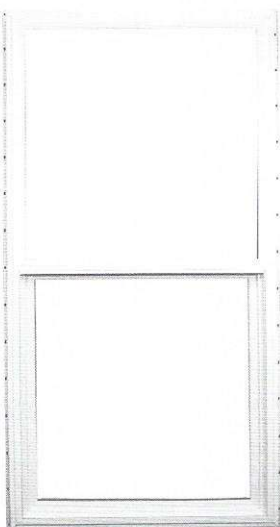

- Vinyl Construction provides high thermal performance. Frame and sash corners are welded for added strength and water tight corners.
- Frame designed with multiple hollow areas for maximum strength and energy efficient.
- Window sash can be removed for easy cleaning on any level of the home.
- Reinforcement bars in the meeting rails provide added strength.
- Positive integral lock at the meeting rail for increased home security and weather resistance.
- Dual weather seal to reduce drafts and enhance energy efficiency.
- Normal $\frac{3}{4}$ " insulating glass provides superior thermal performance.
- Integral "J" trim eliminates the need for additional exterior frame accessories and covers the raw edge of the siding for a clean appearance.
- Deep pocket still for added window strength and weather resistance.
- Integral lift rail for easy sash operation.
- Spiral balance system provides near effortless sash operation.

Sliding Glass Patio Doors

From Outside Right to Left Slide O X : From Outside Left to Right Slide X O

Part #	Description
661-501	72 x 76 White Double Insulated with Screen O X
661-501XO	72 x 76 White Double Insulated with Screen X O
661-501GBG	72 x 76 White Double Insulated with screen 15/15 Grids O X
661-501GBGXO	72 x 76 White Double Insulated with screen 15/15 Grids X O
661-501N	72 x 76 White Non-Insulated O X
661-501NXO	72 x 76 White Non-Insulated X O
661-501R*	72 x 76 White Non-Insulated O X Recessed Flange
661-501XOV*	72 x 76 White Insulated X O Vinyl
661-501GBGXOR*	72 x 76 White Insulated Recessed Flange 15/15 Grids X O
661-502*	72 x 76 Mill Finish Double Insulated w/screen O X
661-502XO*	72 x 76 Mill Finish Double Insulated w/screen X O
661-503*	72 x 80 White Double Insulated w/ screen O X
662-504WV	Screen Only, White for 501XOV
662-504B*	Screen Only, Bronze for 72 x 76
662-504W	Screen Only, White for 72 x 76
662-504M	Screen Only, Mill for 72 x 76
662-508W	Screen Only for 72 x 80 Door White

Call Size 72" x 76" (Actual Rough Opening 70 15/16" x 76.75")



Vinyl Windows

	Sizes (W x H)	With Grids	Obscure Glass w/Grids	No Grids	Obscure No Grids
4 grid	14 x 21	684-1421			684-1421ONG
	14 x 27	684-1427	684-1427OG	684-1427NG*	684-1427O
	14 x 40	684-1440	684-1440O	684-1440NG	684-1440OSB
	24 x 27	684-2427		684-2427NG	684-2427NO*
6 grid	24 x 40	684-2440*		684-2440NG	
	30 x 14			684-3014NG*	
	30 x 27	684-3027		684-3027NG	
	30 x 30	684-3030		684-3030NG*	
	30 x 32			684-3032NG	
	30 x 36	684-3036		684-3036NG	
	30 x 40	684-3040		684-3040NG	
	30 x 52			684-3052NG	
	30 x 53	684-3053		684-3053NG	
	30 x 54	684-3054		684-3054NG	
	30 x 58	684-3058*		684-3058NG*	
	30 x 60	684-3060		684-3060NG	
	30 x 66	684-3066		684-3066NG*	
	30 x 68	684-3068		684-3068NG*	
	36 x 8			684-3608	684-3608O
	36 x 27	684-3627*			
	36 x 36	684-3636*		684-3636NG	
	36 x 40	684-3640*		684-3640NG*	
	36 x 53	684-3653		684-3653NG*	
	36 x 54	684-3654		684-3654NG	
	36 x 60	684-3660		684-3660NG*	
	40 x 27	684-4027*		684-4027NG	
	40 x 40	684-4040*		684-4040NG*	
	40 x 53	684-4053			
	40 x 54	684-4054		684-4054NG	
	46 x 27	684-4627*		684-4627NG*	
46 x 30	684-4630*		684-4630NG*		
46 x 36	684-4636*		684-4636NG*		
46 x 40	684-4640		684-4640NG		
46 x 53	684-4653		684-4653NG		
46 x 54	684-4654		684-4654NG		
46 x 60	684-4660*		684-4660NG*		

*Special Order at some locations

**4/4 = 4 grid window

**6/6 = 6 grid window

Metal Windows

Sizes (W x H)	Vertical Slider Mill	Vertical Slider Mill Obscure	Vertical Slider Mill Recessed Flange	Self Storing Storm White
14 x 21	681-1421	681-1421OBS*	681-1421R*	
14 x 27	681-1427	681-1427OBS		683-1427
14 x 30	681-1430			683-1430
14 x 40	681-1440	681-1440OBS	681-1440R*	683-1440
14 x 53	681-1453			683-1453
14 x 54	681-1454			683-1454*
14 x 58	681-1458*			683-1458*
14 x 65	681-1465			
14 x 66	681-1466			
18 x 21	681-1821*			
18 x 27	681-1827	681-1827O*		683-1827*
22 x 27	681-2227*			
22 x 36	681-2236			
24 x 14	681-2414*			
24 x 21	681-2421*			
24 x 24	681-2424			683-2424
24 x 27	681-2427			683-2427
24 x 30	681-2430			
24 x 36	681-2436			
24 x 40	681-2440			683-2440
24 x 54	681-2454			683-2454*
24 x 58	681-2458*			683-2458*
30 x 21	681-3021	681-3021OBS*		683-3021*
30 x 27	681-3027		681-3027R	683-2027
30 x 30	681-3030			683-3030*
30 x 32	681-3032			683-3032*
30 x 36	681-3036			683-3036*
30 x 40	681-3040		681-3040RF*	683-3040
30 x 52	681-3052			683-3052
30 x 53	681-3053		681-3053R*	683-3053
30 x 54	681-3054		681-3054R	683-3054
30 x 58	681-3058			683-3058*
30 x 60	681-3060		681-3060R*	683-3060
30 x 66	681-3066		681-3066R*	683-3066
30 x 68	681-3068		681-3068R*	683-3068
36 x 27	681-3627			683-3627*
36 x 30	681-3630*			
36 x 36	681-3636			683-3636*
36 x 40	681-3640			683-3640*
36 x 52	681-3652			683-3652
36 x 53	681-3653		681-3653RF*	683-3653
36 x 54	681-3654		681-3654R*	683-3654
40 x 27	681-4027			683-4027*
40 x 30	681-4030			
40 x 40	681-4040			683-4040*
40 x 52	681-4052*			
40 x 53	681-4053		681-4053R*	683-4053
40 x 54	681-4054		681-4054R	683-4054
46 x 27	681-4627			683-4627*
46 x 40	681-4640			683-4640
46 x 53	681-4653			683-4653
46 x 54	681-4654		681-4654R	683-4654

Metal Windows

Sizes (W x H)	Vertical Slider White	Vertical Slider White Obscure	Vertical Slider White with Grids	Vertical Slider no grids White Recessed Flange	Vertical Slider with grids White Recessed Flange
14 x 21	682-1421*	682-1421O*		682-1421R*	
14 x 27	682-1427	682-1427O	682-1427G	682-1427R*	
14 x 40	682-1440*	682-1440OBS		682-1440R	682-1440GR*
14 x 54	682-1454*				
14 x 58	682-1458*				
22 x 27			682-2227G		
22 x 36			682-2236G		
24 x 24			682-2424G*		
24 x 27	682-2427		682-2427G*	682-2427RF	
24 x 30	682-2430*		682-2430G*		
24 x 36	682-2436		682-2436G*		
24 x 40	682-2440*				
24 x 54	682-2454*			682-2454R*	
24 x 58	682-2458*				
30 x 21	682-3021*				
30 x 27	682-3027		682-3027G*	682-3027R*	682-3027GR
30 x 30	682-3030*		682-3030G*		682-3030GR*
30 x 32	682-3032*				682-3032GR*
30 x 36	682-3036*	682-3036OBS*		682-3036R*	
30 x 40	682-3040		682-3040G*	682-3040R*	682-3040GR*
30 x 52	682-3052				
30 x 53	682-3053		682-3053G*	682-3053R	682-3053GRF
30 x 54	682-3054		682-3054G	682-3054RF	682-3054GR
30 x 58	682-3058			682-3058R*	
30 x 60	682-3060		682-3060G*	682-3060R*	682-3060GR*
30 x 66	682-3066*		682-3066G*	682-3066R*	682-3066GR*
30 x 68	682-3068*			682-3068RF*	682-3068GR*
36 x 21	682-3621*				
36 x 27	682-3627*				682-3627GR*
36 x 36	682-3636*		682-3636G*		
36 x 40	682-3640*			682-3640R*	
36 x 53	682-3653*			682-3653R*	682-3653GR*
36 x 54	682-3654		682-3654G*	682-3654R	682-3654GR*
40 x 27	682-4027*			682-4027R*	
40 x 40	682-4040*				
40 x 53			682-4053G*	682-4053R*	682-4053GR*
40 x 54	682-4054		682-4054G*	682-4054R*	682-4054GR*
46 x 27	682-4627*				682-4627GR*
46 x 40	682-4640		682-4640G*	682-4640R*	
46 x 53	682-4653*		682-4653G*	682-4653R*	682-4653GR*
46 x 54	682-4654		682-4654G*	682-4654R*	682-4654GR
Sizes (W x H)	Horizontal Mill Slider		Horizontal White Slider		
30 x 14	681-3014H		682-3014H		
40 x 26	681-4026HZ				
62 x 26	681-6226H				

*Special Order at some locations

Window Accessories

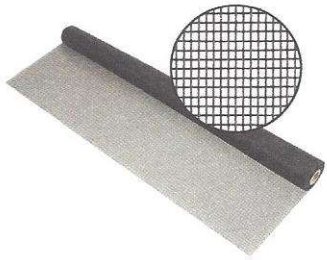

Screen Wire

Fiberglass screen. Won't dent, corrode, or stretch. 100' roll, Black in color.

Part #	Description
680-589	32" x 100 Ft. Roll
680-590	36" x 100 Ft. Roll
680-591	48" x 100 Ft. Roll

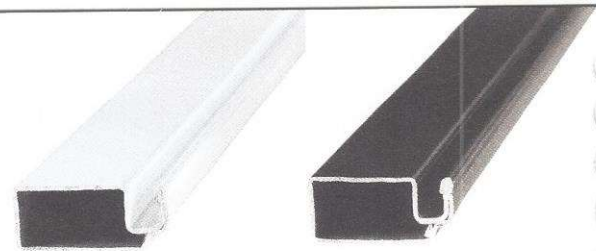

Frame Extrusions - without Spline

Aluminum framing in 12 feet 6 inches in length

Part #	Description
680-595	Mill Finish
680-595A	White
680-595B	Bronze Finish
680-597	Screen Spline Rubber



Retention Screen Springs

Holds window screen in window.

Part #	Description
680-599	Screen Springs



Corner Inserts

Plastic screen frame.

Part #	Description
680-596	Gray (for Mill)
680-596A	White
680-596B	Black

Screen Spline (Rubber)

Part #	Description
680-597	Screen Spline (Per Ft)



Butyl Tape

Part #	Description
710-194	1/8" x 1-1/2" x 30', Black
710-192	Tape Putty - 1.25" x 30' Elastic - Black (Case of 16)
710-2201	1/8" x 3/4" x 50', Black (10 Rolls per Case/Sold by Case)



Tacky Tape

Features a coated "quick-release" paper backing to allow faster installation. The very "tacky" nature of this butyl tape allows it to stay in place while you finish the job.

Part #	Description
710-195	1/8" x 3/4" x 30', 24 Per Carton

Latches For Self-Storing Storm Windows

Seals windows against drafts.

Part #	Description
680-500	Pair latches For SS Storm Window - Black* Fits 9750 Kinro Vinyl Series
680-501	Lock for 9750 Vinyl Window
680-503	Tilt Left Hand Latch for 9750 Vinyl Window
680-504	Tilt Right hand Latch For 9750 Vinyl Window



680-501



680-500

Glazing Channel

Used for replacing glass in sliding windows.

Part #	Description
680-594	12', White Vinyl
680-594A	Brown Vinyl - Bronze

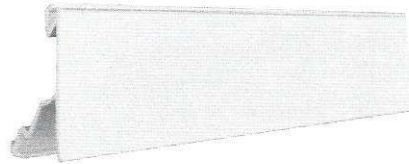

Caulk

Seam Sealer, Interior/Exterior, Silicone Type with solvent Rubber Base.

Part #	Description
581-150	Clear, Silicone
581-151	White, Silicone



Caulking Gun

For all Standard Size Caulk Cartridges.

Part #	Description
581-190	Caulking Gun

Screen Installation Tool

Use convex roller end of installation tool to roll screen wire into slot of aluminum frame. Use concave roller end to roll plastic spine into slot over screen wire to hold it tightly in place.

Part #	Description
680-598	1/16"



54" One Piece Surround

W 54" x D 27" x H 57"

*Use with 54" x 27" Fiberglass Shower Pan and 54" x 27" Fiberglass Tubs

Part #	Description
553-1507	White
553-1508	Bone
553-54WSP-01	2 pc Bone
553-54WSP-02	2 pc White

ABS 3 Piece Surround - Shower

W 54" x D 42" x H 67"

*Use with 54" x 42" Fiberglass Shower Pan

Part #	Description
553-1518	White
553-1519*	Bone

ABS 3 Piece Surround - Shower

W 32" x D 32" x H 67"

*Use with 32" x 32" Fiberglass or ABS Shower Pan

Part #	Description
553-1407	White
553-1408	Bone

ABS 3 Piece Surround - Shower

*Use with 60" x 30" Fiberglass or ABS Shower Pan

Part #	Description
553-P6030SK-02	60" x 30" White

3 Piece Surround - Tub

W 54" x D 27" x H 58"

*Use with 54" x 27" Fiberglass or ABS Standard Tub

Part #	Description
553-1401	White
553-1402	Bone

ABS Standard Tubs

Part #	Description
553-1546	54" x 27" Left Hand Drain, White
553-1547	54" x 27" Right Hand Drain, White
553-1550	54" x 27" Center Drain, White
553-1548	54" x 27" Left Hand Drain, Bone
553-1549	54" x 27" Right Hand Drain, Bone
553-1551	54" x 27" Center Drain, Bone
553-P6030BBX-02	60" x 30" Back Center Drain, White

54" Fiberglass Shower Pan

W 54" x D 27" x H 21"

Part #	Description
553-1503	White, Center Drain
553-1504	Bone, Center Drain



Fiberglass Shower Pan

W 54" x D 42"

Part #	Description
553-1516	White, Center Drain
553-1517	Bone, Center Drain

32" Fiberglass Shower Pan

Part #	Description
553-1501	White
553-1502	Bone

ABS Shower Pan

Part #	Description
553-1540	32" x 32" White
553-1541	32" x 32" Bone

Fiberglass Standard Tubs

Easy Installation, Large radius corners allow for greater protection from stress cracks.

Part #	Description
553-16	54" x 27" Left Hand Drain, Bone
553-17	54" x 27" Right Hand Drain, Bone
553-20	54" x 27" Left Hand Drain, White
553-21	54" x 27" Right Hand Drain, White
553-12	54" x 27" Center Drain, White
553-13	54" x 27" Center Drain, Bone
553-6030CD-02	60" x 30" Center Drain, White



3 Piece Surround - Tub

W 54" x D 42" x H 58"

*Use with 54" x 42" Fiberglass or

ABS Garden Tub

Part #	Description
553-1403	White
553-1404	Bone

3 Piece Surround - Tub

W 60" x D 42" x H 58"

*Use with 60" x 42" Fiberglass or

ABS Garden Tub

Part #	Description
553-1405	White
553-1406	Bone

3 Piece Surround - Tub

W 60" x D 48" x H 58"

*Use with 60" x 48" Fiberglass or

ABS Garden Tub

Part #	Description
553-1411	White
553-1412	Bone

Fiberglass Corner Tubs

Front Center Drain

Part #	Description
553-23	54" x 54" Bone
553-24	54" x 54" White
553-6060CA-02*	60" x 60" White
553-6060CA-01*	60" x 60" Bone

ABS Garden Tubs

Part #	Description
553-1544	54" x 42" White
553-1545	54" x 42" Bone
553-1542	60" x 42" White
553-1543	60" x 42" Bone

Fiberglass Garden Tubs

Skid Resistant Step Option

Part #	Description
553-14	54" x 42" White, with Step
553-19	54" x 42" Bone, with Step
553-22	60" x 42" Bone, No Step
553-22W	60" x 42" White, No Step
553-18	60" x 48" Bone, with Step
553-15	60" x 48" White, with Step

Island Tub

Part #	Description
553-4260AR	42" x 60" Bone; with Arm Rest
553-4260AR-02	42" x 60" White; with Arm Rest
553-4260BR-01	42" x 60" Bone; with Back Rest
553-4260BR-02	42" x 60" White; with Back Rest

Fiberglass Corner Tubs

Right Hand Drain

Part #	Description
553-5454CARS-01	54" x 54" Bone
553-5454CARS-02	54" x 54" White

Bone Garden Tub with Step

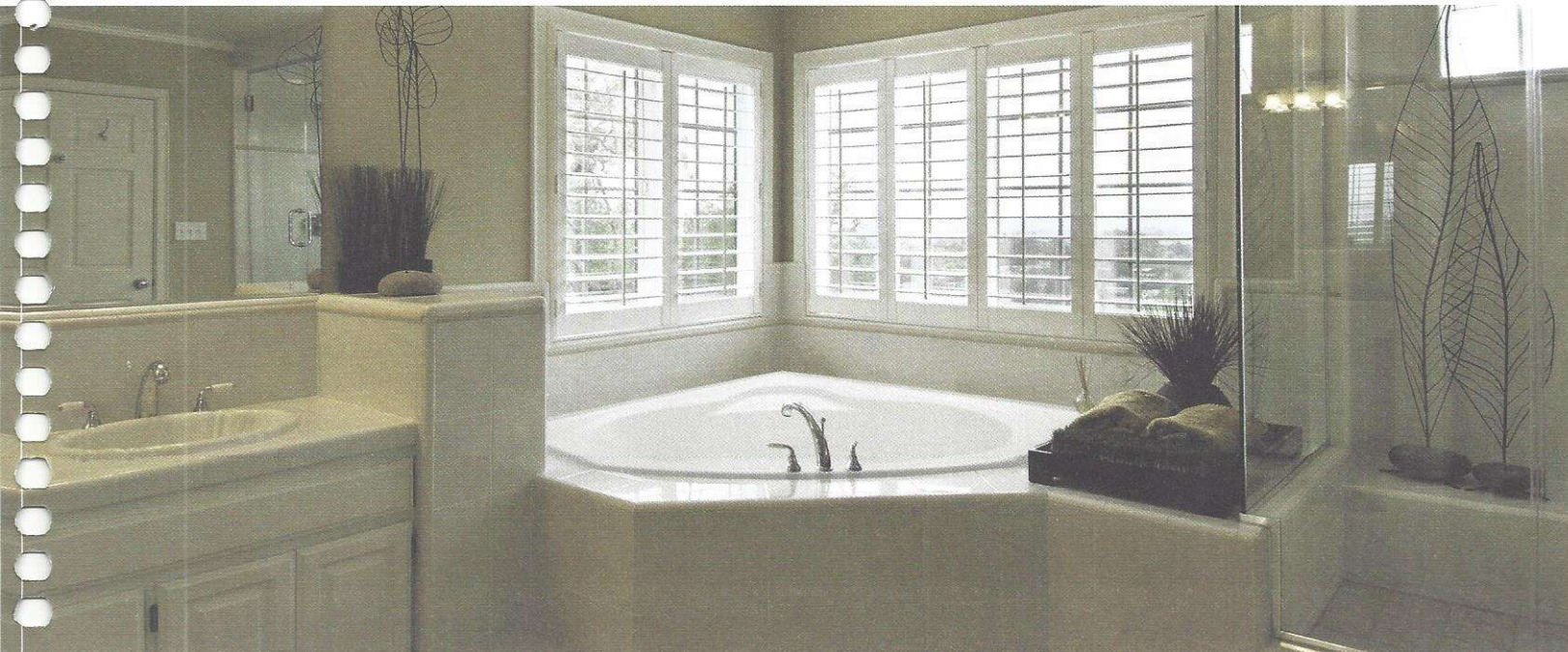

32" 2 Piece Shower Pan & Walls

32" Fiberglass, Rough Opening Size:

W 31 1/2" x D 31" x H 76"

USE 553-28 SHOWER DOOR

Part #	Description
553-1510	Bone
553-1511	White

36" 2 Piece Shower Pan & Walls

36" Fiberglass, Rough Opening Size:

W 36" x D 37" x H 76"

USE 553-30 SHOWER DOOR

Part #	Description
553-1512*	Bone
553-1513	White

48" 2 Piece Shower Pan & Walls with 2 seats

48" Fiberglass, Rough Opening Size:

W 48" x D 35 1/2" x H 76"

USE 553-37 SHOWER DOOR

Part #	Description
553-1514	Bone
553-1515	White

Shower Pan Shower Door - Single

Part #	Description
553-28	For 32" 2pc. Shower ONLY Cover 28" Opening, Door 25"

THIS DOOR WILL NOT FIT A 32" SHOWER PAN

553-30	For 36" 2pc. Shower ONLY Cover 32" Opening, Door 29".
--------	--

THIS DOOR WILL FIT A 32" SHOWER PAN WITH ABS SHOWER WALL

Shower Door - Fixed Panel

Part #	Description
553-37	To fit a 48" 2pc Shower. 12" Side Panel, 30" Pivot Door

Shower Door Sweep

Part #	Description
553-C171G	Small
553-C176G	Large



Tub Enclosure Shower Door

Part #	Description
553-31	54" - Satin Finish Door Size Each 27" x 54" To be used with 27 x 54 Tubs
553-32	60" Satin Finish To be used with 27 x 60 Tubs

Tub Enclosure Shower Door

Part #	Description
553-33	Door Size Each 27" x 66" Use with 27" x 54" Shower Pan and fiberglass surround
553-34	For 48" 2pc. Shower. Cover 44" Opening, Door
553-38	For 48" 2pc. Shower. Cover 50" Opening, Door



ABS Shower Bases

Part #	Description
553-1534	28" x 54" Right Drain, Bone
553-1533	28" x 54" Left Drain, Bone
553-1532	28" x 54" Right Drain, White
553-1531	28" x 54" Left Drain, White



Three Piece Shower Surround

Part #	Description
553-1536	28" D x 54" W x 68" H, Bone
553-1535	28" D x 54" W x 68" H, White

One Piece Shower Surround

Part #	Description
553-153	32" D x 32" W x 67" H, Bone
553-151	32" D x 32" W x 67" H, White

One Piece Tub Wall Kit

Part #	Description
553-147	1 Piece Bath Wall Kit; 40 x 54; White
553-148	1 Piece Bath Wall Kit; 40 x 54; Bone
553-156	1 Piece Bath Wall Kit; 27 x 54; White
553-157	1 Piece Bath Wall Kit; 27 x 54; Bone

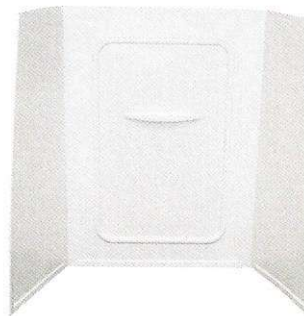

ABS Garden Tubs

Part #	Description
553-158	Bone; 40 x 54; Heavy Duty
553-159	White; 40 x 54; Heavy Duty



Phoenix Faucets

3/8" Tub/Shower Diverter

Faucet: Metal, lever handles, chrome finish, long spout, with riser nut, ABS shower head and bracket. For exposed shower.
Underbody: Brass Valve Type: Stem & Bonnet

Part # 555-02



Part # 555-06

4" Tub and Shower Diverter - Exposed, Brass



Part # 555-05

4" Tub and Shower Diverter - Concealed, Brass



8" 2 Valve Tub and Shower Brass Diverter

Part # 555-07



Part # 555-10

4" Concealed Shower Valve Faucet: Clear acrylic handles, chrome finish, with ABS shower head, arm, and flange, 2" shanks.



Part # 555-01

3-3/8" Tub/Shower Diverter Faucet: Metal, lever handles, chrome finish, long spout, with ABS shower head, arm, and flange. For concealed shower. Underbody: Brass, Valve Type: Stem & Body.



Part # 555-110

8" Concealed Shower Valve Faucet: Clear acrylic handles, chrome finish, with ABS shower head, arm, and flange, 2" shanks.



Part # 555-12P

8" Tub/Shower Concealed Diverter: Clear acrylic handles, chrome finish, with ABS shower head, arm, and flange, 2" shanks. Underbody: DuroPro™



Part # 555-12A

8" Tub Faucet without Shower Head

Adjustable 2 Valve Garden Tub Filler Faucet: Large clear acrylic handles, garden tub spout, chrome finish, adjustable to 24" centers. Underbody: Brass, Valve Type: Brass Stem & Bonnet (38-I)

Part # 555-111



Catalina By Phoenix Garden Tub Filler, Plastic Underbody, Plastic Stems. (R-38-I)

Part # 555-111C



Shower Head Kit

Part # 555-112



Faucet Spout for 2 Valve Diverter

Part # 555-108

Faucet Spout for 3 Valve Diverter

Part # 555-107



Part # 555-106

Faucet Spout



Part # 555-114

8" Ledge Garden Tub Filler - Brass Underbody (39-I)



Part # 555-115

8" Concealed Garden Tub Filler - Plastic Underbody



Part # 555-119

Replacement Garden Tub Spout



Part # 555-045

8" Shower Diverter 3-Valve: Brass Underbody, Brass Cartridge, Head, Arm & Flange

Phoenix Faucets

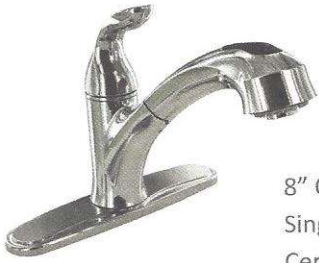

Part # 555-201

8" Chrome Kitchen Faucet:
Single Lever Hybrid Pull Out,
Ceramic Disc Cartridge



Part # 555-188C

8" High Rise Kitchen Faucet:
Chrome, Hi Arc Tubular Spout,
1/4 Turn Washerless Cartridge,
Clear Oval Handles



Part # 555-202

8" Brushed Nickel Kitchen Faucet:
Single Lever Hybrid Pull Out, Ceramic
Disc Cartridge



Part # 555-203

8" White Kitchen Faucet:
Single Lever Hybrid Pull Out,
Ceramic Disc Cartridge



Part # 555-204

8" Rubbed Bronze Kitchen Faucet:
Single Lever Hybrid Pull Out, Ceramic
Disc Cartridge



Part # 555-205

8" Chrome Kitchen Faucet:
Single Lever Hybrid, Ceramic
Disc Cartridge



Part # 555-206

8" Brushed Nickel Kitchen Faucet:
Single Lever Hybrid Pull Out, Ceramic
Disc Cartridge



Part # 555-209

8" Chrome Kitchen Faucet:
2 Handle Hybrid, 1/4 Turn
Washerless Cartridge, Lever
Handles



Part # 555-210

8" Brushed Nickel Kitchen Faucet:
2 Handle Hybrid, 1/4 Turn
Washerless Cartridge, Lever Handles



Part # 555-171

4" Lavatory Faucet:
Chrome, Plastic Cartridge



Part # 555-214

4" Brushed Nickel Lavatory Faucet:
Single Lever Hybrid, with Pop Up,
Ceramic Disc Cartridge



Part # 555-213

4" Chrome Lavatory Faucet:
Single Lever Hybrid, with Pop
Up, Ceramic Disc Cartridge



Part # 555-215

4" Rubbed Bronze Lavatory Faucet:
Single Lever Hybrid, with Pop Up,
Ceramic Disc Cartridge



Part # 555-217

4" Chrome Lavatory Faucet:
2 Handle Hybrid, Chrome, 1/4
Turn Washerless Cartridge, Lever
Handles



Part # 555-218

4" Brushed Nickel Lavatory Faucet:
2 Handle Hybrid, Chrome,
1/4 Turn Washerless Cartridge,
Lever Handles



Part # 555-185A

8" Decorative Kitchen
Ledge Spout



Part # 555-182

8" Chrome Two Handle
Kitchen Faucet

StoneCrest



Part # 555-012

- 4" Lavatory Faucet
- Acrylic Handles
- Quarter Turn Washerless Cartridge
- Chrome Finish

Part # 555-011



- 8" Shower Faucet without shower head
- Acrylic Handles
- Quarter Turn Washerless Cartridge
- Chrome Finish

Part # 555-019

Chrome Tea Pot Lever Handles

Part # 555-019BN

Brushed Nickel Tea Pot Lever Handles

Part # 555-019BRZ

Bronze Nickel Tea Pot Lever Handles



Part # 555-013

- 8" Kitchen Faucet
- Acrylic Handles
- Quarter Turn Washerless Cartridge w/o Side-Spray
- Chrome Finish



Part # 555-014

- 8" Kitchen Faucet
- Acrylic Handles
- Quarter Turn Washerless Cartridge with Side-Spray
- Chrome Finish



Part # 555-015

- 8" Tub/Shower Diverter
- Acrylic Handles
- Quarter Turn Washerless Cartridge without Shower Head Kit
- Chrome Finish

Part # 555-016



- 4" Shower Faucet
- Acrylic Handles
- Quarter Turn Washerless Cartridge without Shower Head Kit
- Chrome Finish

Part #
555-0901C
555-0901H

555-016 Replacement Handles

Part # 555-017



Garden Tub Filter,
Plastic Underbody with flex line

Part # 555-030



- 6" Pressure Balanced Tub/Shower Diverter with Shower Head
- Chrome Finish



Part # 555-020

- Chrome Finish

Part # 555-020BRZ

- Bronze Finish

8" Kitchen Faucet

- Tea-Pot Handles
- Quarter Turn Washerless Cartridge with Side-Spray



Part # 555-M7520CF-01

Dual Control 8" Metal High Rise Goose Neck Kitchen Faucet with Sprayer and Tea-Pot Style Handles

- Chrome Finish

Utopia

Part # 555-03

8" Diverter with Knob - Utopia 8" center distance backsets are offset.



Part # 555-263 Utopia Acrylic Faucet Handles

Part # 555-263A Large Utopia Acrylic Faucet Handles



Part # 555-261

Utopia Plastic Stem/Bonnet - Old Model



Part # 555-260

Utopia Plastic Stem/Bonnet - New Model

Empire Brass Company

Part # 555-12

8" Tub/Shower Exposed

Diverter: Clear acrylic handles, chrome finish, with ABS shower head, arm, and flange, 2" shanks. Underbody: Brass



Faucet Parts & Accessories



Part # 555-249

Replacement End Valve for Garden Tub Faucets



Part # 555-250

Replacement Tee for Garden Tub Faucets



Part # 555-251

For "Streamway", "Nibco" and Phoenix Faucets. Used in sink mount faucets and exposed wall mount tub/shower. Used on cold side only with lever handle. Sold as Pairs.



Part # 555-253

Washerless Cartridge (Plastic) For sink mount faucets and exposed tub/shower units. Used on hot & cold side with acrylic handles.



Part # 555-252

Washerless Cartridge Right Hand Only. For Streamway and Aquastream washerless cartridge. Used in sink mount faucets and exposed wall mount tub/shower. Used on hot and cold sides with acrylic handles.



Part # 555-261

Utopia old style replacement washerless stem and bonnet with valve stop for older Utopia models (Pair)



Part # 555-268

Large acrylic faucet handle for garden tub. 1 pair for Phoenix.



Part # 555-267H (hot)

Part # 555-267C (cold)

Fits exposed tub and shower faucets only

Part # 555-268HC

Small acrylic faucet handle for garden tub. 1 pair for Phoenix.



Part # 555-269

Metal Lever Handles (Pair)



Part # 555-248

Adjustable Garden Tub Replacement Hose



Part # 555-262 Diverter Repair kit

Part # 555-258 Diverter Knob



Part # 555-047

Phoenix 3 valve tub/shower diverters. Used in wall or deck thicknesses up to 7/8". Not interchangeable with 60-4D-0.



Part # 555-048

3 valve wall mount tub/shower diverters. Used for thick wall construction up to 2".



Part # 555-275

Concealed Fitting Seats. For faucets with brass underbodies. Fits the 2 valve and 3 valve tub/shower



Part # 555-276

Used in cast brass underbodies for concealed 3-3/8" shower valves.



Part # 555-274

Used in deck mount, 2 valve garden tub fillers



Part # 555-278

Brass - Used in cast brass underbodies for sink mount faucets and exposed tub/shower .



Part # 555-277

Nylon - Used in plastic underbodies. For sink mount faucets and exposed tub/ shower. 1/4" Hex



Part # 555-280

Flange for 600 & 700 Series



Part # 555-60

Nylon - Used in plastic underbodies. For sink mount faucets and exposed tub/ shower. 1/4" Hex

Toilet Connector

Part # 556-553

1/2" FIP x 1/2" FIP x 12" - Lead Free

PVC Lavatory Connector

Part # 556-558

1/2" FIP x 1/2" FIP x 20" - Lead Free

Part # 556-555

1/2" FIP x 1/2" FIP x 12" - Lead Free

Part # 556-561

1/2" FIP x 1/2" FIP x 60" - Lead Free



Part # 555-240

Catalina Replacement Valve



Part # 555-270

For sink mounted faucets and exposed tub/shower. Used on hot and cold side with lever handles. Sold as pairs.



Part # 555-270HC

For sink mounted faucets and exposed tub/shower. Used on hot and cold side with Acrylic handles. Sold as pairs.



Part # 555-269HC

For concealed wall mount tub/shower, deck mount garden tub and widespread lavatory. Used on hot and cold side with acrylic handles. On cold side only with lever handles. Sold as Pairs.

Shower & Tub Accessories

Tub Trim Ends & Corners

- 554-17 Bone Corners for Tub Trim
- 554-18 Bone Tub trim 12'
- 554-19 Bone Ends For Tub trim
- 554-21 White Tub Trim 12'
- 554-22 White Ends for Tub Trim
- 554-23 White Corner for Tub Trim



Fiberglass Repair Kits

- 553-10 Bone Repair Kit
- 553-11 White Repair Kit



Shower Door Roller

554-30



Hex Screw for 554-30

554-31



Rubber Sweep for Shower Door

(sold by foot)

553-C171G - Large

553-C176G - Small



Shower Head

554-114 3/8" FPT

Fits 3/8" Pipe Thread.

Shower head faucet replacement.

554-115 1/2" FPT

554-116 1.5 GPM 1/2" FPT

555-112 Shower Head Kit



555-112



555-114

Tub and Shower Molding

- 554-20 Lip Molding White 14'
- 554-34 Molding Tub Lip White 7'
- 554-35 Molding Tub Lip Bone 7'



PVC Tub Molding Kits

- 554-24 Bone 54"
- 554-25 White 54"
- 554-26 Bone 60"
- 554-27 White 60"



Rivets for Tub Wall Kits

- 554-01 White 25/box
- 554-02 Bone 25/box
- 554-1000-01 White 1000/box
- 554-1000-02 Bone 1000/box



Metal Tub Drains

- 554-128 Standard
- 554-129 Pop-Up



Shower Arm with Metal Flange

554-143



ABS P-Trap

- 544-292 1½"
- 544-293 2"



ABS Swivel Adapter

- 544-110 1½" Short Swivel Adapter
- 544-111 1½" Long Swivel Adapter
- 554-145 Washer for Swivel Adapter



Tub & Tile Caulk

Water-tight, flexible seal. Mold and Mildew resistant

- 581-157 Kwik Seal - Bone
- 581-166 Kwik Seal - White
- 581-158 Kwik Seal - Clear



Liquid Nails - Tub Surround

- 581-215 11 oz Tube



Adjustable Shower Rod

- 554-563 Rod With Adjustable Ends



Shower Drain

- 554-127M Metal 3 ½" x 1 ½" MPT



Tray Plug Adapter

- 544-290 1 ½" ABS SPG x FPT



Plumbing Access Panel

- 554-700 6" x 9" Panel
- 554-701 14" x 14" Panel

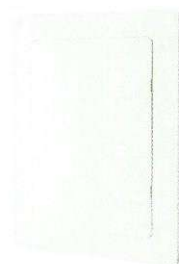

Rubber Stopper

- 554-130 1"
- 554-131 1 ¼"
- 554-132 1 ¾"





Adapter - Pex Fitting

NOTE: 3/8" & 1/2" Flair-It Fittings Fit Both Pex & Poly Pipe. Adapter must be use with 3/4" fittings when used on Poly Pipe.

Part # 545-6792

Swivel Elbows

Faucet to Flair-It (10 per Bag)

Part # 545-6807

Elbow Termination
1/2" Pex x 3/4" FPT Swivel



Part # 545-6816

Elbow Termination
1/2" Pex x 1/2" FPT Swivel



Elbows

with 2 Flair-It Connections (10 per Bag)

Part # 545-6800

1/2" Pex x 1/2" Pex

Part # 545-6806

3/4" Pex x 3/4" Pex

Part # 545-6815

3/8" Pex x 3/8" Pex

Male Elbows

(10 per Bag)

Part # 545-6809

MPT Elbow - 3/4" Pex x 3/4" MPT



Part # 545-6810

MPT Elbow - 1/2" Pex x 3/8" MPT



Female Elbows

(10 per Bag)

Part # 545-6813

FPT Elbow - 3/4" Pex x 1/2" FPT



Straight Swivel Coupling

(10 per Bag)

Part # 545-6873

1/2" Pex x 1/2" FPT Swivel

Part # 545-6874

3/8" Pex x 1/2" FPT Swivel



Male Adapters

(10 per Bag)

Part # 545-6842

1/2" Pex x 1/2" MPT

Part # 545-6872

3/4" Pex x 3/4" MPT BSP

Part # 545-6848

3/4" Pex x 3/4" MPT



Ballcock Swivel Adapters

Toilet to Flair-It Connection

(10 per Bag)

Part # 545-6865

1/2" Pex x 3/4" Swivel

Part # 545-6869

3/8" Pex x 3/4" Swivel



Washers

Part # 545-6435 1/2" - Fits 545-6873, 6874 & 6816

Part # 545-6482 Ballcock Washer - Fits 545-6865 & 6869

Couplings

Part # 545-6853
1/2" Pex x 3/8" Pex



Part # 545-6855
3/8" Pex x 3/8" Pex



Part # 545-6840
1/2" Pex x 1/2" Pex



Part # 545-6845
1/2" Pex x 3/4" Pex



Part # 545-6846
3/4" Pex x 3/4" Pex



Part # 545-6844
3/4" Pex x 3/4" Poly



Caps

Part # 545-6859 3/8" Cap
Part # 545-6869 1/2" Cap



Female Adapters (10 per Bag)

Part # 545-6841
1/2" Pex x 1/2" FPT



Part # 545-6847
3/4" Pex x 3/4" FPT



Part # 545-6849
3/4" Pex x 3/4" FPT Swivel



Part # 545-6856
1/2" Pex x 3/4" FPT Swivel



Part # 545-6858
1/2" Pex x 3/4" FPT



Part # 545-6866
1/2 Pex x 3/4 FGH Swivel
Garden Hose Adapter



Straight Stop Valves

In-Line Valve (10 per Bag)

Part # 545-6879

3/8" P Straight Valve - Poly/Pex

Part # 545-6880

1/2" Pex x 1/2" Pex - Straight Stop Valve



Ice Maker Valves (10 per Bag)

Part # 545-2834

Tee Valve with brass valve

1/2" Pex x 1/2" Pex x 1/8" FIP



Tee Connections (10 per Bag)

Part #	A	B	C
545-6820	1/2 Pex	x 1/2 Pex	x 1/2 Pex
545-6823	1/2 Pex	x 1/2 Pex	x 3/4 Pex
545-6824	3/4 Pex	x 1/2 Pex	x 1/2 Pex
545-6825	3/4 Pex	x 1/2 Pex	x 3/4 Pex
545-6826	3/4 Pex	x 3/4 Pex	x 1/2 Pex
545-6827	3/4 Pex	x 3/4 Pex	x 3/4 Pex
545-6831	3/8 Pex	x 3/8 Pex	x 3/8 Pex



Washing Machine Valve (10 per Bag)

Part # 545-6887

ABS Pipe & Fittings

ABS 45° Street Elbow

544-152	1½"
544-153	2"
544-154	3"



ABS 90° Street Elbow

544-142	1½"
544-143	2"
544-144	3"



ABS 22½° Elbow

544-132	1½"
544-133	2"
544-134	3"



ABS 45° Elbow

544-122	1½"
544-123	2"
544-124	3"



ABS 90° Elbow

544-106	1½"
544-107	2"
544-108	3"



ABS Wye

Thick Wall, heavy-duty black ABS foam-core pipe for rigid code requirements.

544-212	1½"
544-213	2"
544-214	3"



ABS Double Wye Combo

544-118	3"
---------	----



ABS Long-Turn Tee Wye

544-223	1½"
544-224	2"
544-225	3"
544-228	3" x 3" x 1½"
544-226	3" x 3" x 2"



ABS All Hub Sanitary Tee

544-182	1½"
544-183	2"
544-184	3"
544-192	3" x 3" x 2"
544-193	3" x 3" x 1½"
544-194	2" x 2" x 1½"



ABS Double 1/4 Bend

544-178	3"
---------	----



ABS Trap Adapter

- 544-316 1½" SPX x 1¼"
- 544-317 1½" SPX x 1½"



ABS P-Trap with Union Joint

- 544-292 1½"
- 544-293 2"



ABS 3" Closet Flange

- 544-324 SLIP x SLIP



ABS 3" Closet Flange (Male)

- 544-321 3", Male



ABS 3" Closet Flange (Female)

- 544-320 3", Female



Flexible Transition Coupling

- 544-300 1½" x 1½"
- 544-301 2" x 2"
- 544-302 3" x 3"
- 544-303 3" to 4"
- 544-310 4" x 4"



ABS Coupling

- 544-282 1½"
- 544-283 2"
- 544-284 3"



Flush Bushing

- 544-268 2" x 1½"
- 544-266 3" x 1½"
- 544-265 3" x 2"
- 544-262 4" x 3"



ABS Cleanout Adapter

- 544-242 1½"
- 544-243 2"
- 544-244 3"



ABS Cleanout Plug

- 544-252 1½"
- 544-253 2"
- 544-255 3"

Male Adapter

- 544-67 3"
- 544-66 2"
- 544-65 1½"



Female Adapter

- 544-68 3"
- 544-69 2"
- 544-70 1½"



ABS Foam Core Sewer Pipe

Thick Wall, heavy-duty black ABS foam-core pipe for rigid code requirements. (Per Foot)

- 544-337 3" Schedule 40
- 544-338 2" Schedule 40
- 544-339 1½" Schedule 40



ABS Mounting Accessories

- 540-101 100' Roll of Hanger Iron
- 540-104 10' Roll of Hanger Iron
- 540-107 100 pc. Pack Nut & Bolt
- 540-100 100' Roll of Plastic Hanger Strap



Toilets & Toilet Parts

Peerless Pottery John-in-a-Box Toilet Complete Replacement Toilet Kit

- 1.6 gpf/6 Lpf
- Round front, siphonic wash
- Water seal exceeds 2 1/8"
- New enlarged fully glazed trapway
- Water surface area 8 1/4" x 8 3/4"
- Wax ring included
- Closet Bolts included
- Toilet seat included
- Available in White and Bone



Toilet Seats

- | | |
|----------|------------------------------|
| 553-131 | Toilet Seat - Bone, Wood |
| 553-131P | Toilet Seat - Bone, Plastic |
| 553-133 | Toilet Seat - White, Wood |
| 553-133P | Toilet Seat - White, Plastic |

- | | |
|-----------|----------------------------------|
| 553-122 | Round Front - White |
| 553-123 | Round Front - Bone |
| 553-124 | Elongated Front - White |
| 553-122HC | Elongated Front Handicap - White |
| 553-125 | John in a Box - White |



Fill-Pro

Complete replacement for tank's ballcock, Fully adjustable. Fits all toilets

- | | |
|---------|----------------------|
| 554-312 | Replacement Ballcock |
|---------|----------------------|

Watersaver Flush Valve

Fits all tanks. Trouble free-only one moving part, nothing to break or wear out.

- | | |
|---------|----------------------|
| 554-320 | Straight Flush valve |
|---------|----------------------|



Adjustable Fill Valve with Flapper

Anti-Siphon Design, Adjustable from 9 1/2" to 13 1/2". Push Button Water Level Adjustment. Safety Ring Height Adjustment. Fast Fill Design, Refill Tube & Clip.

- | | |
|-----------|-------------------|
| 554-325SP | Anti-Siphon Valve |
|-----------|-------------------|

Toilet Flappers

- | | |
|---------|-------------------|
| 554-318 | Korky Flapper |
| 554-316 | Universal Flapper |



Fluidmaster - Flush Valve

Flush Valve, Fits Most including 1.6 Gallon models. Ends water waste and inlet leaks. Easy to Install. Includes Proven Bull's Eye Super Flapper.

- | | |
|---------|-------------|
| 554-324 | Flush Valve |
|---------|-------------|



Fluidmaster PerforMAX Toilet Fill Valve

The PerforMAX is the quietest and most powerful fill valve on the market. The PerforMAX works with all toilets.

- | | |
|---------|-------------------|
| 554-445 | Anti-Siphon Valve |
|---------|-------------------|



Fluidmaster - Anti Siphon

Anti-Siphon fill valve, Adjustable (9-14 inches). Meets all plumbing codes. Ends water waste and inlet leaks. Quieter operation.

- | | |
|---------|-------------------|
| 554-325 | Anti-Siphon Valve |
|---------|-------------------|

Wax Bowl Ring

For Floor Outlet Toilet Bowls

Fits 3" and 4" Waste Lines

554-330 Wax Bowl Ring

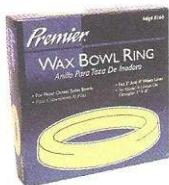

Wax Bowl Ring

This Wax Toilet Bowl Ring includes a plastic sleeve and is ideal for short horn bowls. Designed to fit 3" and 4" openings, it will provide a permanent waterproof seal against odors, gases and acids.

554-331 Wax Bowl Ring

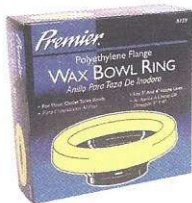

ABS Closet Flange

544-324 Slip 3" Closet Flange

544-321 Male 3" Closet Flange

544-320 Female 3" Closet Flange

Bolts Sets

554-336 Tank to Bowl Kit

554-337 Flange Set - Bowl to floor

554-338 Closet Bolts



Toilet Levers

554-306 Plastic Lever

554-305 Chrome Lever - Metal



Fluidmaster Better Than Wax Toilet Seal

Prevent leaks and water issues with the Fluidmaster Better Than Wax Toilet Gasket. This product fits any drain and any toilet. It comes with no wax and no mess. The drain gasket has a seal can be repositioned and plunging won't cause leaks. Each product contains no rust brass bolts and hardware. Soon, you will have a working toilet that causes no messes or spills upon flushing.

554-332 Toilet Seal



Tank to Bowl Gasket Kit

554-319 with bolts



Sinks & Sink Parts

Sink Strainers

- 554-124 Stainless Steel Strainer with Basket 4 1/2" x 1 1/2" MPT
- 554-123 All Plastic Strainer with Basket 4 1/2" x 1 1/2" MPT
- 554-126 Replacement Basket Only Fits 554-123
- 554-125 Replacement Basket Only Fits 554-124



ABS Check Vent

Designed to open and admit air into a sink drain line when there is negative pressure (suction) in the pipe, which allows the drain to flow freely without gurgling for air.



- 554-120 1 1/2"

Strainer Washer

- 554-148 3 1/2" x 1/2"



Continuous Waste Sink Drain

1 1/2" black plastic, Adjustable. With or without dishwasher tailpiece.

- 554-210 Without tailpiece
- 554-212 With tailpiece



PO Plug with Overflow

- 554-178 1 1/4" x 5"



ABS Trap Adapter

- 544-316 1 1/2" SPX x 1 1/4"
- 544-317 1 1/2" SPX x 1 1/2"



CO Plug

- 554-175 Chrome 1 1/4" x 5"
- 554-176 Bone 1 1/4" x 5"
- 554-177 White 1 1/4" x 5"



Plastic Lavatory Sinks

- 555-42 White Oval
- 555-43 Bone Oval
- 555-44 White Rectangle
- 555-45 Bone Rectangle

Part # 544-180

C.O Plus Brass Flange ABS Tailpiece



Part # 544-181

P.O Plus Brass Flange ABS Tailpiece



Stainless Steel Kitchen Sink

Stainless Steel, 4 Holes (for faucets with sprayer option)

- 555-51 33" x 19" x 6"
- 555-53 33" x 19" x 7"
- 555-54 33" x 19" x 8"



Lavatory Drop-In Bowl

Vitreous China Beverly, Center Drain

- 555-46 20" x 17" White Oval Bowl 4"
- 555-47 20" x 17" Bone Oval Bowl 4"
- 555-48 19" Round White 4"
- 555-49 19" Round Bone 4"



Sink Clips

Heavy gauge aluminum "G" clip and bolt for 1/2" thick countertops.

- 555-52 Sink G Clip - 10 Pack

Electrical & Wiring Supplies

Single Duplex Plate

- 527-525 White
- 527-526 White Jumbo
- 527-515 Ivory Jumbo
- 527-514 Ivory



Double Duplex Plate

- 527-527 White
- 527-528 Ivory

Self Contained Single In-Line Switch

- 527-487 White
- 527-480A White Snap Plate Cover
- *Must be used together



Self Contained Duplex In-Line Receptacle

- 527-488 White
- 527-490A White Snap Plate Cover
- *Must be used together



Square Glass Shade

- 528-43 12" Square Glass



Globe

- 528-23 Round White Glass Globe - 6 x 3-1/4
- 528-26 Clear Cut Glass
- 528-27 Clear Ribbed ball



528-23



528-26



528-27

Self Contained Duplex Receptacle

- 527-518 White
- 527-505 Ivory



Self Contained Single Rocker Switch

- 527-517 White
- 527-506 Ivory



Wall Plate

- 527-517A White
Use with 527-505 and 527-506
- 527-505A Ivory
Use with 527-518 and 527-517



Blank Wall Plate

- 527-544 White
- 527-534 Ivory



Plastic Dish Shade

- 528-45 12" Plastic Shade with use with 528-20



Two Bulb Ceiling Mount Light Fixture

- 528-20 Two Bulb Fixture



Fixtures

- 528-21 Gloss White Ceiling Fixture
- 528-48 8" with Globe
- 528-46 6" with Globe



528-48/46



528-21

Light (Fits 528-46 and 528-48)

- 528-49 5" Projection/8" Diameter
- 528-47 5" Projection/6" Diameter



3 1/4" Pull Chain Lamp Fixture

- 528-095 White



Fittings

- 528-38 G/Pac 2 Stud & 2 Caps
- 528-40 Q/Pac Thumb Screw 3 Steel



Plastic Finial Cap

- 528-57 White



Porch Light

- 528-54 Metal, Black, Wire In
- 528-54P Plastic, Black, Wire In
- 528-54WP Plastic, White, Wire In
- 528-55 Crystal Porch Globe
- 528-56 Hardware for 54P & 54WP

Single Switch with Duplex Plate

- 527-547 White
- 527-546 Ivory

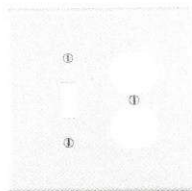

528-54WP & 528-55

528-54P



Hardware & Sealants

Premium Aluminum Roof Coating

This premium energy saving formula stays brighter longer. It will seal, protect, and reflect solar heat using a proven blend of selected waterproofing pigments. Forms an excellent adhesive bond with most substrates. Areas immediately under roof will remain approximately 15-20 degrees cooler in summer. In winter, heat is reflected back into the building, saving energy costs. Dries bright silver.

COVERAGE: Metal Surface: 70-100 square feet per gallon
Composition Surface: 40-60 square feet per gallon

591-413 1 gallon
591-414 5 gallon



Fibred Aluminum Roof Coating

A blend of select asphalts, aluminum pigments and fibers designed to reflect the sun's rays. Temperature directly under roof surface stays cooler in the summer and warmer in the winter. Dries silver. Uses on Mobile Homes, RV's, Commercial & Residential Buildings.

COVERAGE: Metal Surface: 70-100 square feet per gallon
Composition Surface: 40-60 square feet per gallon

591-415 5 gallon



Plastic Wet or Dry Roof Cement

Plastic Wet Surface Roof Cement bonds rapidly to wet, moist and cold surfaces. This specially treated asphalt cement is excellent for all roof repair work on both wet or dry surfaces.

591-416 1 gallon

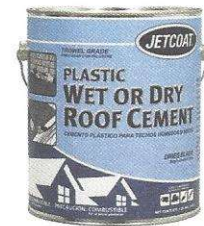

WET-R-DRI Roof Cement

All-Weather roof cement is ideal for the repair of cracks, seams and holes in roofing material. This cement is conveniently formulated for year-round use. It also works great in new construction and in setting flashings, drip edges and roofing material edges. Use in wet and dry conditions to seal and stop leaks around flashings, skylights, vent pipes, chimneys and valleys. Covers approx 12 sq. ft. per gal.

591-444 1 gallon
591-445 10 oz Tube

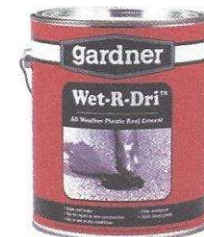

Roof-Tec Acrylic White Elastomeric Roof Coating

Anvil's ROOF-TEC Acrylic Elastomeric Roof Coating is an acrylic latex roof coating formulated to provide superior bridging of the coating over seams and small separations. ROOF-TEC Acrylic exceeds performance of similar coatings of this type for adhesion and longevity. Its brilliant white finish not only beautifies, it reflects up to 90% of the sun's rays lowering heat buildup and reducing air conditioning costs. Stays brighter longer since it contains a fungicide to resist mildew growth on the product film. Do not use on flat roofs. Roofs must have adequate pitch to allow water to run off.

591-426 White Roof-Tec Acrylic White - 5 gallon

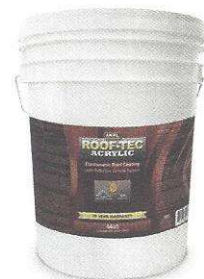

All Weather Black Roof Cement

All-Weather Roof Cement is a black asphalt product ideal for sealing, filling and patching cracks and breaks in roofing surfaces, firewalls, chimneys, gutters, flashing, etc., particularly where emergency repairs of wet surfaces must be done. Use this product to repair shingle tabs, flashings, roof seams and gable joints. It can also be used to stop leaks around vent pipes and is suitable for sealing metal building seams, foundations, masonry steps and for repointing chimneys. Cannot be painted.

591-446 10 oz Tube



Roof-Tec Ultra Premium Elastomeric Roof Coating

Anvil's ROOF-TEC Acrylic Elastomeric Roof Coating is an acrylic latex roof coating formulated to provide superior bridging of the coating over seams and small separations. ROOF-TEC Acrylic exceeds performance of similar coatings of this type for adhesion and longevity. Its brilliant white finish not only beautifies, it reflects up to 90% of the sun's rays lowering heat buildup and reducing air conditioning costs. Stays brighter longer since it contains a fungicide to resist mildew growth on the product film. Do not use on flat roofs. Roofs must have adequate pitch to allow water to run off.

591-400 Roof-Tec Ultra Premium - 5 gallon

591-451 Roof-Tec Ultra Premium - 1 gallon



Roof-Tec Caulk & Sealant Textured Knife/Trowel Grade

Anvil 1214 Elastomeric, Textured Knife / Trowel Grade Caulk & Sealant is a heavy bodied, flexible, elastomeric caulk and sealant for filling and patching cracks and voids on vertical masonry, stucco, and concrete block. Anvil #1214 Elastomeric, Textured, Knife/Trowel Grade Caulk & Sealant provides excellent adhesion, long life, and is resistant to failure by expansion, contraction, or other joint movement. Fast drying and may be painted with latex or oil base paints. For use on interior or exterior surfaces.

591-454 Roof-Tec Caulk & Sealant - 1 gallon



Roof-Tec Caulk & Sealant Smooth Brush Grade

Anvil 1220 Elastomeric Smooth Brush on Grade SeamSeal is a heavy bodied, flexible, elastomeric patching material for filling and patching cracks joints and seams on; masonry, stucco, concrete block, brick, stone, marble, wood, metal and glass prior to applying finish. Anvil #1220 Elastomeric, Smooth, Brush on Grade SeamSeal provides excellent adhesion, long life, and is resistant to failure by expansion, contraction, or other joint movement. Fast drying and may be painted with latex or oil base paints. For use on interior or exterior surfaces.

591-456 Roof-Tec Caulk & Sealant - 1 quart

591-457 Roof-Tec Caulk & Sealant - 1 gallon



Roof-Tec Seam Sealing Membrane

Anvil 9414 Polyester Membrane is supplied in 100 foot rolls in widths of 4" and is designed to be used as a reinforcing material when sealing seams on roofs, flashing and around protrusions when using Anvil caulking products. 9414 Polyester Membrane is more flexible than fiberglass mesh and produces a strong, resilient joint and bonding system.

591-458 Glass Fabric Membrane - White 4" x 100' Roll



Paint Brush

694-984 2"

694-985 3"



Roofing Brushes

592-409

Brush 7" Roof Coat with 48" Poly Handle Attached

592-406

7" Tampico Roof Coating Brush - use with 592-407

592-407

60" Taper Tip Push Broom Handle - use with 592-406

592-401

8" Brush - use with 592-402

592-402

Wooden Broom Handle - use with 592-401



Hardware & Sealants

Hex Head Zinc Plated Steel Screws

582-020	#8 x 2"	3500 qnty
582-022	#8 x 1 1/4"	8000 qnty
582-025	#8 x 3/4"	9600 qnty
582-026	#8 x 1"	7500 qnty
582-027	#8 x 1 1/2"	6500 qnty

(50 pack)

582-022B	#8 x 1 1/4"
582-024B*	#8 x 1/2"
582-025B	#8 x 3/4"
582-026B	#8 x 1"
582-027B	#8 x 1 1/2"

(500 pack)

582-022A	#8 x 1 1/4"
582-025A	#8 x 3/4"
582-026A	#8 x 1"
582-027A	#8 x 1 1/2"



Hex Head Colored Steel Screws

582-031	#8 x 1" Black	7500 qnty
582-032	#8 x 1" White	7500 qnty
582-034	#8 x 1 1/2" White	6500 qnty
582-037	#8 x 1 1/4" White	8000 qnty
582-021	#8 x 1" Tan	7500 qnty

(50 pack)

582-031B	#8 x 1" Black
582-032B	#8 x 1" White
582-033B	#8 x 1 1/4" White

(500 pack)

582-030A*	#8 x 1" Brown
582-031A	#8 x 1" Black
582-032A	#8 x 1" White
582-034A	#8 x 1 1/2" White - per lb
582-021A	#8 x 1" Tan



Screws - Square Drive Plain Finish

582-040	1" Square Head	10000 qnty
582-041	2" Square Head	4500 qnty
582-042	3" Square Head	2000 qnty



Cabinet Square Drive

582-121	1 1/2" Square Head	6000 qnty
582-122	2" Square Head	3500 qnty
582-123	2 1/2" Square Head	3000 qnty
582-124	3" Square Head	2000 qnty



Multi-Purpose Phillips Head Screw (250 pack)

582-044	#6 x 1 1/4"
---------	-------------



Lag Bolts (sold individually)

Used when setting up multi-section homes.

582-111	3/8" x 6" Hex Lag Bolt
582-113	3/8" x 5" Hex Lag Bolt
582-110A	3/8" x 4" Hex Lag Bolt

Lag Bolts by Case (300 qnty)

582-107	3/8" x 7" Hex Lag Bolt
---------	------------------------

Paneling Nails

Slim pin nails in five colors to match most popular panel colors. All nails are annularly threaded for maximum holding power and covered with three coats of special baked enamel. Packed 6 ounces per plastic box.

584-006	1" Nails, White
584-004	1" Nails, Brown
584-007	1 5/8" Nails, White
584-005	1 5/8" Nails, Brown
584-002	1" Oak
584-008	1" Cherry
584-009	1 5/8" Cherry



Lag Bolts with Washers

582-114	3/8" x 5"	25 qnty
582-115	3/8" x 6"	25 qnty
582-116	3/8" x 7"	25 qnty
582-117	3/8" x 8"	50 qnty



Some photos shown may not reflect exact size and finish of actual part

Hardware & Sealants

Flex-Mend

FLEX-MEND™, is a mending product that matches the appearance and texture of bottom closure materials used by most manufacturers in the mobile home industry today. FLEX-MEND is a woven polyethylene film currently meeting all requirements for use as bottom board by the mobile home industry. It has been solid-coated with specially formulated high-tech adhesive, and has an easily removed paper release liner. It goes on like a band-aid. FLEX-MEND™ is now available in 28" wide x 100' rolls (233 sq. ft.) or in convenient tape form 4" x 100'.

- 564-04 4" x 100' Roll
- 564-02 28" x 25' Roll

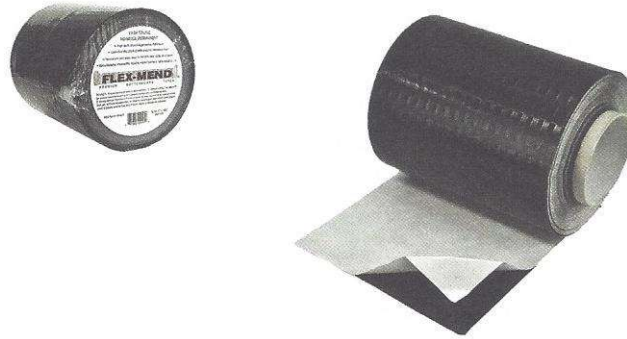

Black Bottom Board

- 564-05 28" x 100' Roll - Bottom Board
- 564-06 48" x 600' Roll
- 564-09 36" x 500' Roll Bottom Board
- 564-11 14' 4" x 70' Bottom Board Boxed
- 564-12 14' 4" x 80' Bottom Board Boxed
- 564-13 16' 4" x 80' Bottom Board Boxed

Flex Patch

- 564-10 4" x 165' Roll



Duct Tape

- 969-398B Black
- 969-398S Silver



Peel and Seal Aluminum

Peel & Seal® is the original, self-stick roll roofing specifically designed for low slope residential and commercial applications. Composed of an exclusive formula (consisting of laminated aluminized foil, high-density polymer films and a thick layer of rubberized asphalt), Peel & Seal® provides a long lasting, durable, maintenance-free roofing surface. From dormers, residential sunroom additions, "open" porches, and mobile home roofs, to industrial and agricultural buildings where low slope roofs are common place, Peel & Seal® is an excellent solution for these applications. The self-adhering, weatherproof, reflective surface not only forms a highly effective barrier to the elements, but also limits solar heating to help keep the temperature of building interiors significantly cooler.

Peel & Seal® is compatible with EPDM roofing systems by utilizing WeatherBond™ Multi-Purpose primer prior to installation.

Applying Peel & Seal® is easy. No tar, torches, mops, glues, tapes, or fasteners are required... a utility knife and hand roller are the only tools needed. Following preparation of the surface, simply peel off the release liner, unroll Peel & Seal® to the proper length.

Peel & Seal® – the original, maintenance-free, energy efficient, economical, self-sealing roll roofing you can count on for any low slope/ low pitch application...and warranted by MFM for 10 full years!

- 591-500 3" x 33.5' Roll
- 591-501 6" x 33.5' Roll
- 591-502 12" x 33.5' Roll
- 591-503 18" x 33.5' Roll
- 591-504 36" x 33.5' Roll
- 591-510* Peel and Seal Primer - 1 Gallon



Range Hoods & Vents



522-24W



522-30W



522-30B



522-30AN



522-30S

Range Hoods

Item #	Description
522-24W*	24" White Hood with Fan & Lights
522-30AN	30" Almond Hood with Light, Duct Free
522-30WN	30" White Hood, Non-Ducted
522-30A	30" Almond Power Horiz. Hood
522-30B	30" Black Ducted Range Hood
522-30S	30" Stainless Steel Ducted Range Hood
522-30W	30" White Ducted Range Hood
522-42W	42" White Ducted Range Hood
522-42A	42" Almond Ducted Range Hood
522-42B	42" Black Convertible Range Hood
522-42S	42" Stainless Steel Convertible Hood

Range Hood Parts

Item #	Description
522-33	Galvanized Vent Hood Transition, 3 1/4" x 10" x 5" dia for Kitchen Exhaust Fan (Round to Rectangular)
522-34	5" Damper for 5" Hood
961-7X5R	Galvanized Round In increaser with Collars, 5" dia to 7" dia



522-33



961-7X5R



522-34

Range Hood Vents

Item #	Description
522-25	4" Louvered Exterior Sidewall Vent - Plastic
522-24	4" Non-Louvered Exterior Wall Vent - Plastic
522-20	4" Louvered Vent for Vinyl Lap



522-25



522-24



522-20

Ceiling Exhaust Fan

Item #	Description
522-46	50 CFM Broan Ceiling Exhaust Fan, White Grill
522-46A	White Replacement Exhaust Fan Grill: 9" x 9-1/4" For use with Broan 50 CFM Exhaust Fan item # 522-46 (Model #688)
522-47	70 CFM Broan Ceiling Exhaust Fan with Light, White Grill Ideal for bathrooms up to 65 sq. ft. Compatible with 4 in. ducts.



522-47



522-46

Ceiling Exhaust Fan & Grille

Item #	Description
522-23	Ceiling Exhaust Fan 50CFM Motor
522-23A	Replacement Grille Only (fits 522-23 & 522-26)
522-26	7" Diameter
522-30	Ceiling Exhaust Fan with Light

522-30



522-26

522-23



Sidewall Vents

Item #	Description
522-27C	4" Fan Kit-Complete
522-42	Inside Replacement Grille, White
522-44	Screws (2) for 522-42



522-27C

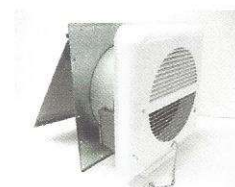

522-27C & 522-42

Range Hood Replacement Pushbutton Switch

for Side Wall Exhaust Fan 522-39



6" Fan Blade

522-32



Rocker Light Switch 522-37

for Range Hoods



Replacement Washable Filters

for Range Hoods

522-40 8 3/4" x 10 1/2"
522-40A 8" x 8"



Range Hood Motor

522-28

115 Volt Exhaust Fan Motor

522-29

Broan Replacement Fan Motor Assembly



Plastic Sloped Roof Cap*

3" Diameter

522-19



Roof Vent

522-85163



Metal Roof Vent Cap 593-111

Plumbing Stacks, made of galvanized metal

Standard Roof Cap

522-21

Standard 7.25" Flat

522-22

Standard 7.25" Sloped



522-21



522-22



Plastic Plumbing Vent

593-110

2-3/8" Diameter vent will accommodate 1" to 2" plumbing vent stacks. May also be used as an attic vent. Made of hi-impact UV stabilized polyolefin.

Roof Roll Flashing - Galvanized and Aluminum

Item #	Description
593-129	10" x 50' Galvanized
593-131	12" x 50' Galvanized
593-130	10" x 50' Aluminum
593-132	12" x 50' Aluminum
593-136	12" x 70' Galvanized
593-136A	10" x 70' Galvanized
593-135	18" x 50' Galvanized



Water Heaters & Parts

T & P valve factory installed, Glasslined tank, Triple tested tanks, Anode rod (protects against tank erosion), Energy efficient foam insulation, One year limited warranty, UL listed - all models comply with specifications outlined in UL174.

6-Year Limited Tank/Parts Warranty, 1-Year Limited Warranty Labor*

*For complete information, consult written warranty.

Part #	Size	# of Elements	Volts	Height	Diameter
551-9425	19 gallon	1 (1500 W)	120	24-3/4" short	18"
551-9415	28 gallon	2 (4500/4500 W)	240	30" short	22"
551-9424	30 gallon	2 (3500/3500 W)	240	32" short	25"
551-9417	30 gallon	2 (3000/3000 W)	120	45" tall	18"
551-2312	30 Gallon Side Mount	2 (4500/4500 W)	240	46.75" Tall	19"
551-2412	40 Gallon Side Mount	2 (4500/4500 W)	240	50" Tall	22"
551-2506	50 Gallon Top Mount	2 (4500/4500 W)	240	49.25" Tall	23"
551-3800	38 Gallon	2 (4500/4500 W)	240	33.5" Tall	24"



Hot Water Heater Door

551-2000 White Mill Frame
- Rough Opening 23" x 60"



552-338



552-339

Hot Water Heater Supply Lines

556-B1H12 12" Supply Line
556-B1H18 18" Supply Line
556-B1H24 24" Supply Line

T & P Valves

Automatic resetting pressure-temperature, Relief valve with test lever and extension t-stat, "White Coat" special protective coating, AGA certified.



552-336 3/4" (short neck)
552-335 2" (long neck)

Universal Replacement Thermostats

552-338 Lower Thermostat - 1 Pole (for DE units)
552-339 Water Heater Reset Limit - 2 Pole
552-340 Hi-Limit Upper T-stat for SE units
552-342 Hi-Limit T-stat for DE units

Drip Pan

552-353 24" Styrene Pans



Water Heater Element Wrench

552-348



Dry Coil

552-300 120V, 1500W



Screw-in Immersions

552-316 120V, 1500W
552-318 120V, 2000W
552-322 240V, 3500W
552-324 240V, 4500W



Uni-Flange Element

552-308 120V, 1500W
552-310 120V, 2000W
552-315 240V, 4500W
(Compatible with tanks at least 13 in. in diameter)



Floor Registers

563-57	4 x 8; White
563-58	4 x 10; White
563-59	4 x 8; White, Rolled face
563-60	4 x 10; White, Rolled face
563-62	4 x 8; Brown
563-63	4 x 10; Brown
563-64	4 x 12; Brown
563-68	4 x 8; Brown, Rolled face
563-69	4 x 10; Brown, Rolled face
563-75	18" White Baseboard Diffuser



Brown Floor Register



White Floor Register

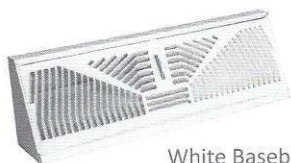

White Baseboard Diffuser

Draw Bands Plastic Tie

969-T36	36" Black Plastic Tie for Duct
969-T36W	36" White Plastic Tie for Duct
969-T48	48" White Plastic Tie for Duct
969-T11	11" Black Plastic Tie for Duct (100/pack)
969-T8	8" Black Plastic Tie for Duct (100/pack)



Flex Duct Strapping

969-14932	1-3/4" x 300" Roll (Black)
969-16095	1-3/4" x 300" Roll (Silver)



Pads for A/C

941-24x24x3	24" x 24" x 3"
941-24x36x2	24" x 36" x 2"
941-30x30x3	30" x 30" x 3"
941-32x32x2	32" x 32" x 2"
941-32x32x3	32" x 32" x 3"



941-36x36x3	36" x 36" x 3"
941-38x48x3	38" x 38" x 3"
941-38x70x3	38" x 70" x 3"
941-50x55x3	50" x 55" x 3"
941-50x60x3	50" x 60" x 3"

Floor Register Collars

Use this convenient product to create a ductwork transition to the Metaline register or grille or to extend the collar of the device.

563-65	4" x 8" x 6"
563-66	4" x 10" x 6"



Face Plates

563-49	4 x 8 White Face Plate
563-50	4 x 10 White Face Plate
563-55	4 x 8 Brown Face Plate
563-56	4 x 10 Brown Face Plate



Portable Steps

Ott Steps Pictured



Ott Wood/Metal Portable Steps

571-20222	2 High Double Top with Rail
571-20330	Step 3 High Double Top with Rail
571-20333	Step 3 High Single Top
571-20444	Step 4 High Single Top (No Rail)
571-20445	Step 4 High Double Top with Rail
571-20446	5 High Double Top with Rail
571-20447	6 High Double Top with Rail
571-20610	Step 5 High Single Top
571-30910	Handrail 3 High (Fits 20333)
571-30911	Handrail 4 High Single Top
571-30913	Handrail 5 High (Fits 20610)
571-30930	Rail For 571-20330/3 High Dt
571-30940	Handrail For Step 4-High Double Top (Fits 20445)
571-30950	Handrail 5 High Double Top (Fits 571-20446)

*Portable Steps not stocked in all locations.

Gene's Wood/Metal Portable Steps

571-243610	3 High Step 24T X 36W X 10P
571-303610	4 High Step 30T X 36W X 10P
571-363610	5 High Step 36T X 36W X 10P
571-3HR	Handrail 3 Step
571-4HR	Handrail 4 Step
571-5HR	Handrail 5 Step



{Wall Mount}



IgniteXL Linear Electric Fireplace

Item #	Product
253-XLF50	50" IgniteXL Linear Electric Fireplace
253-XLFTRIM50	Black metal trim, compatible with XLF50

IgniteXL Features:

ComfortSaver™ Heating System

- Safe ceramic heat, plus 11% energy savings, warms up to 1,000 sq. ft.

Media Accent Colors

- Choose from a variety of brilliant color themes or cycle through a range of colors

Mood-maker Remote

- Customize the light color and intensity for a fireplace