



CLOTHING STYLE MANUAL

condensed

V1801C

TAILORING GRADES

1 MAYFAIR

- Full made to measure
- 70% hand sewn benchmade
- Full canvas
- Most options available

2 BUCKINGHAM

- Full made to measure
- Machine sewn with hand finishing
- Full canvas
- Full options available

3 WINDSOR

- Full made to measure
- Machine sewn with hand finishing
- Half canvas
- Full options available

4 TUSCANY

- Full made to measure
- Unstructured
- Micro thin or no shoulder padding
- Piped seams
- Limited lining options
- Front darts available

5 SORRENTO

- Alpha sizing
- Unstructured
- No shoulder padding
- Piped seams
- Sleeve lining only
- Limited options
- Restricted to select stretch fabric collections

JACKET MODELS // SINGLE BREASTED

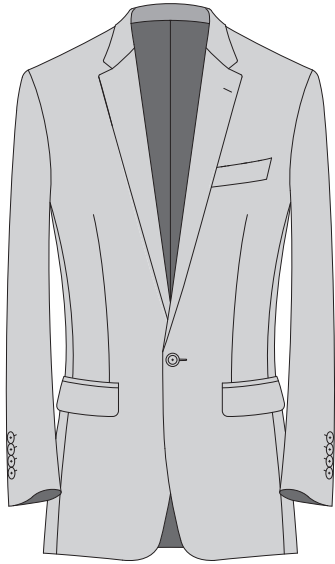

C102

UPDATED ONE BUTTON

C101

CLASSIC ONE BUTTON

Lowers stance $\frac{3}{8}$ "

C103

UPDATED ONE BUTTON

Raises stance $\frac{3}{8}$ "

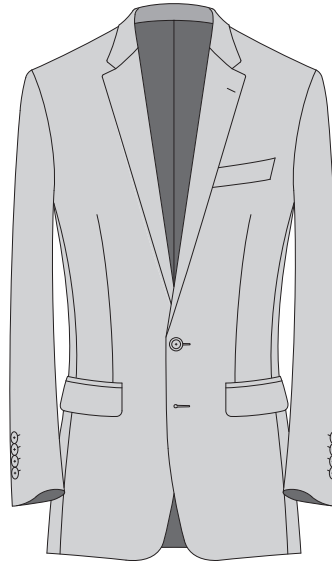

C202

UPDATED TWO BUTTON

C201

CLASSIC TWO BUTTON

Lowers stance $\frac{3}{8}$ "

C203

UPDATED TWO BUTTON

Raises stance $\frac{3}{8}$ "

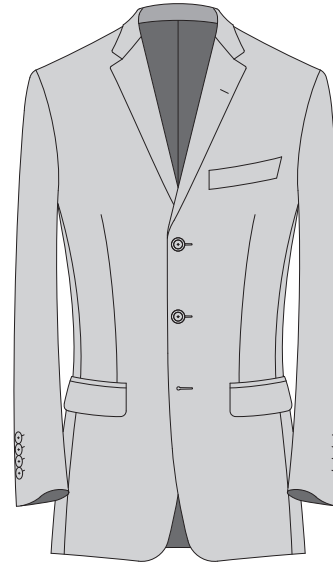

C303

UPDATED THREE BUTTON

C301

CLASSIC THREE BUTTON

Lowers stance $\frac{3}{8}$ "

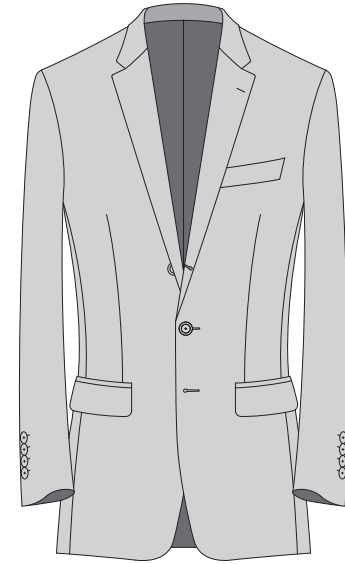

C302

UPDATED THREE BUTTON

Top button/button hole in jacket roll

JACKET MODELS // DOUBLE BREASTED

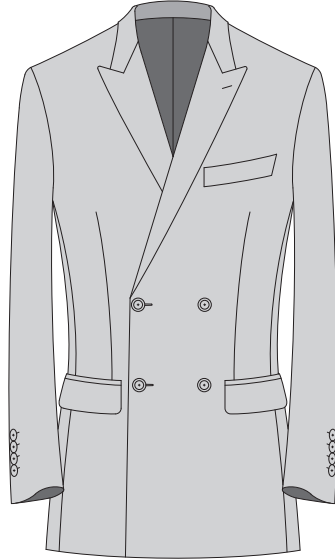

DB4x2
CLASSIC FOUR BUTTON
Two buttons to button

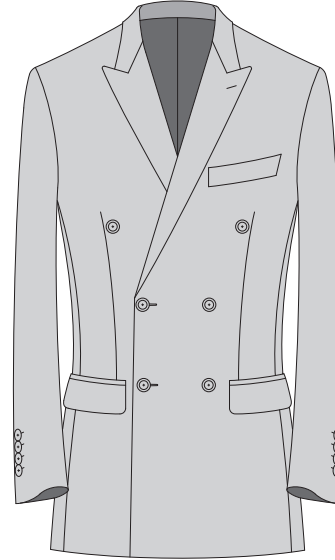

DB6x2
CLASSIC SIX BUTTON
Two buttons to button

DB4x1
CLASSIC FOUR BUTTON
One button to button

DB6x1
CLASSIC SIX BUTTON
One button to button

EXTERIOR JACKET OPTIONS // LAPELS & COLLARS + SHOULDER STYLES

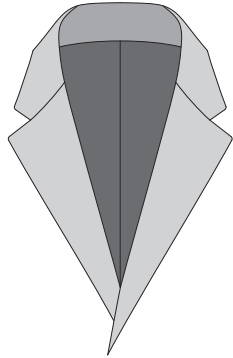

NOTCH

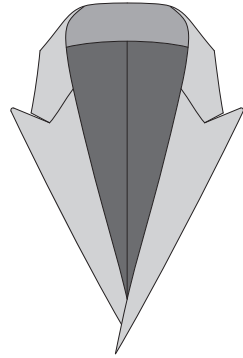

PEAK

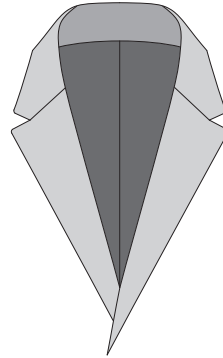

SEMI-NOTCH

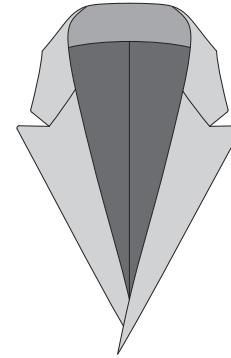

SEMI-PEAK

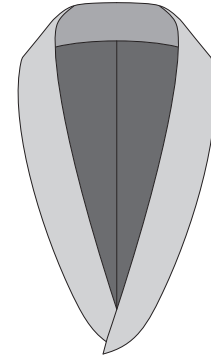

SHAWL

Lapel widths (1/8" increments): 2" minimum - 4 1/2" maximum

Lapel widths: 2 1/2" or 3"

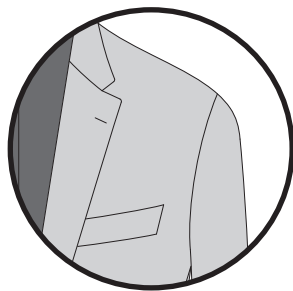

ULTRA SOFT

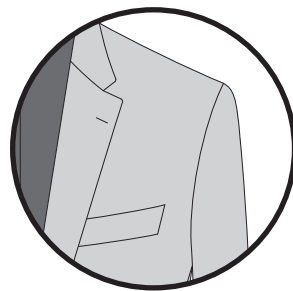

NATURAL

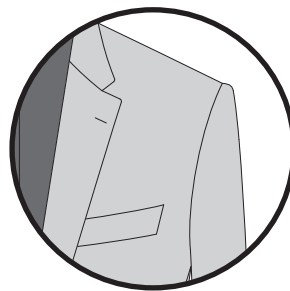

CAPPED

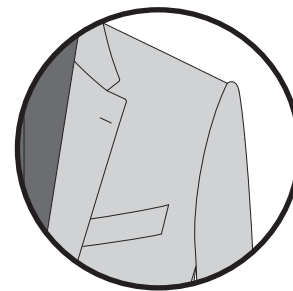

ROPED

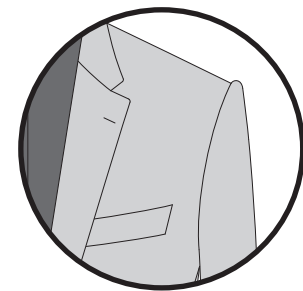

HEAVY ROPED

EXTERIOR JACKET OPTIONS // HAND-SEWN MILANESE LAPEL BUTTONHOLE

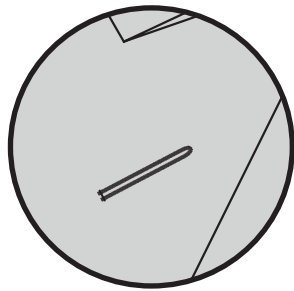

ML01

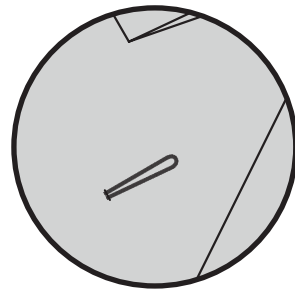

ML02

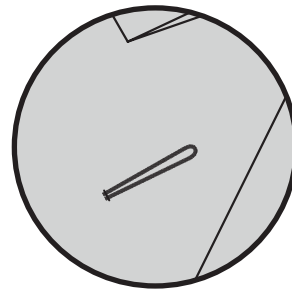

ML03

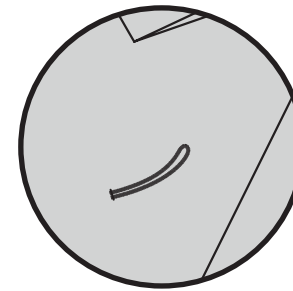

ML04

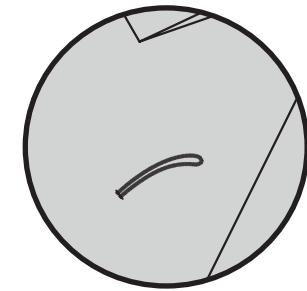

ML05

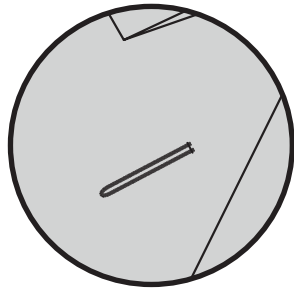

ML06

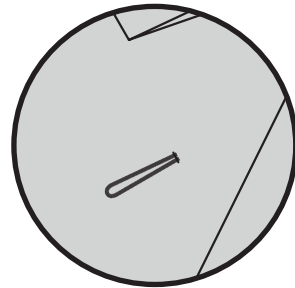

ML07

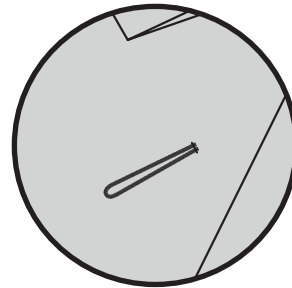

ML08

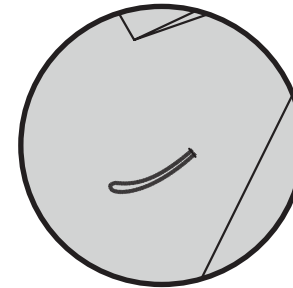

ML09

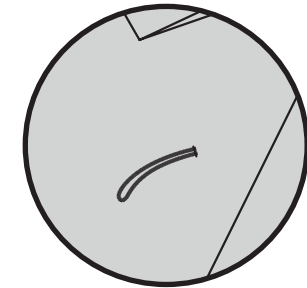

ML10

Select up to 3 thread colors

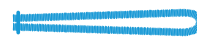

1



2



3

EXTERIOR JACKET OPTIONS // VENT STYLES + BREAST POCKET

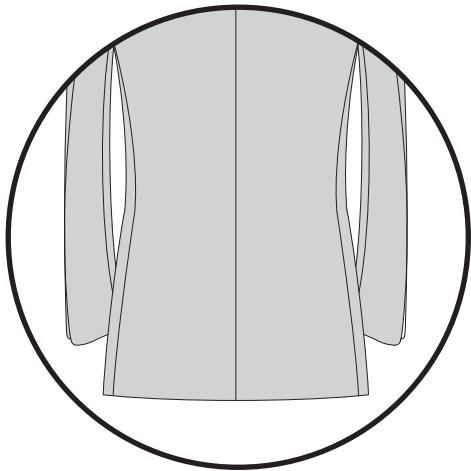

NONE

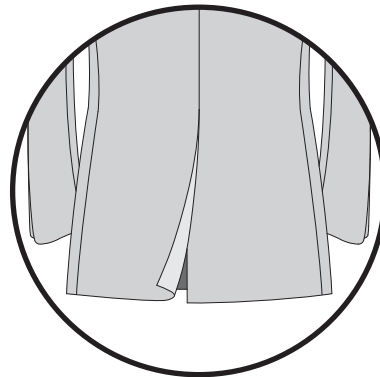

CENTER

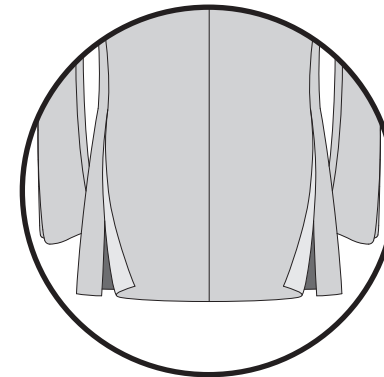

SIDE - DOUBLE

Vent length adjustments: +/- 3/4", +/- 1 1/2"



WELT

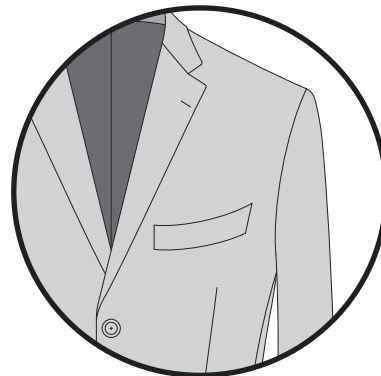

CURVED WELT - SQUARE CORNERS

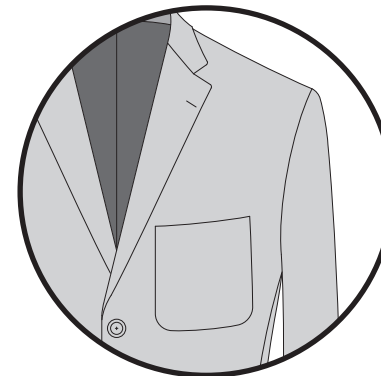

PATCH

EXTERIOR JACKET OPTIONS // LOWER POCKETS + TICKET POCKETS

LOWER POCKETS

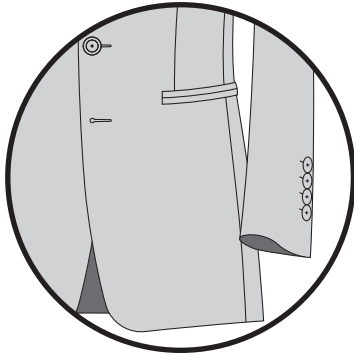

DOUBLE BESOM

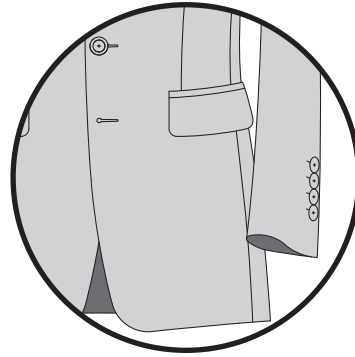

**DOUBLE BESOM
WITH FLAP**

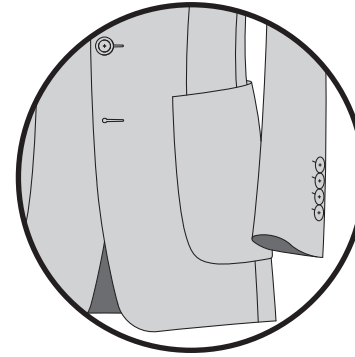

PATCH

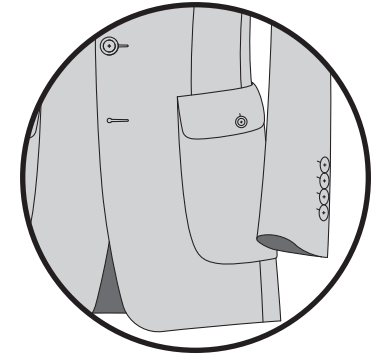

**PATCH WITH FLAP
AND BUTTON**

TICKET POCKETS

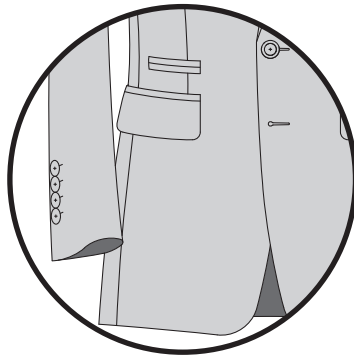

DOUBLE BESOM

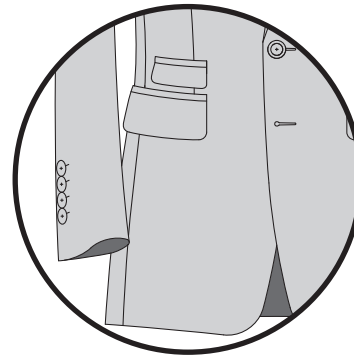

**DOUBLE BESOM
WITH FLAP
(STANDARD)**

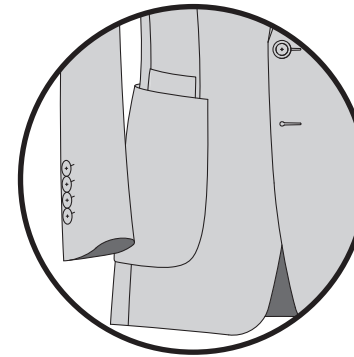

**PATCH - HALF HIDDEN
IN LOWER POCKET**

EXTERIOR JACKET OPTIONS // POCKET ANGLES + STITCHING

STRAIGHT - 90°

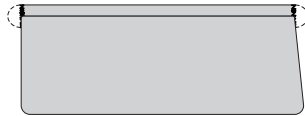

SLANTED - 13°

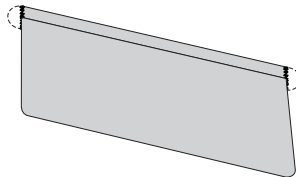

SLANTED - 20°

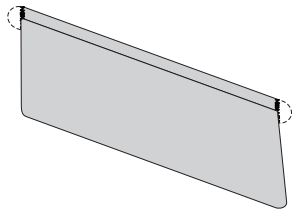

SLANTED - 33°

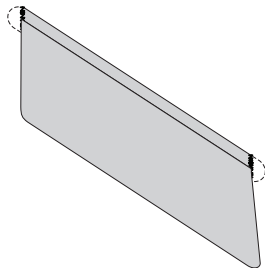

Slanted Pocket: 13° is standard if slanted is selected.
Image represents the left jacket pocket

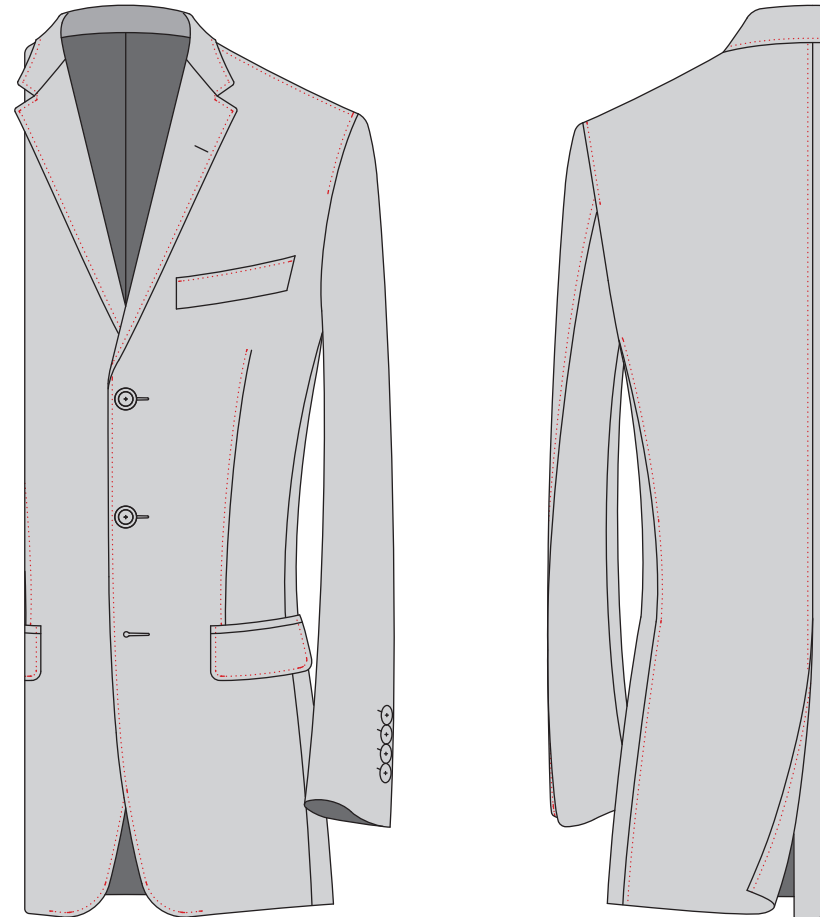

PIC STITCHING

Available Options: Collar/Lapels/Front, Pocket Flap, Exterior Breast Pocket, Shoulder, Dart, Armhole Front, Armhole Back, Vent, Sleeve Vent, Center Back, Side Back, Sleeve Back.

EXTERIOR JACKET OPTIONS // SLEEVE BUTTONHOLES + BUTTONHOLE SPACING

SLEEVE BUTTONHOLES

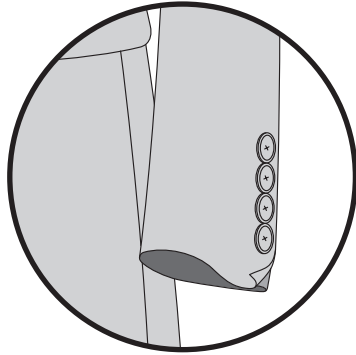

NONE

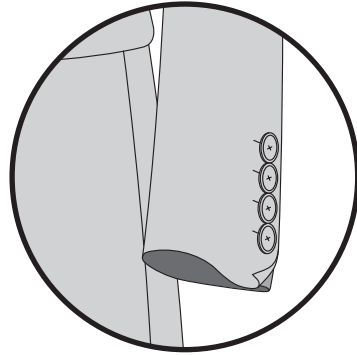

IMITATION

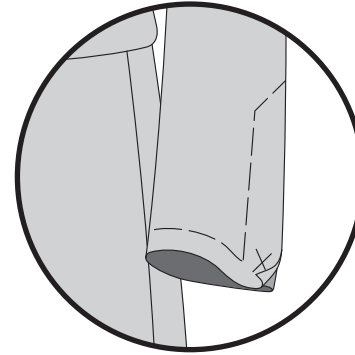

PREPARED FOR FUNCTIONAL

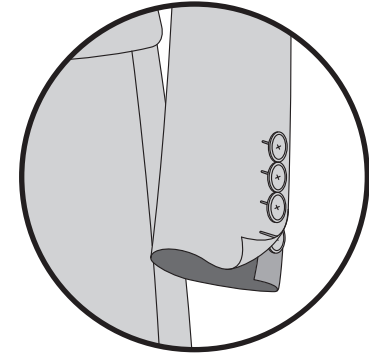

FUNCTIONAL

45° Buttonhole Stitching is available on Imitation and Functional Buttonholes.

BUTTONHOLE SPACING

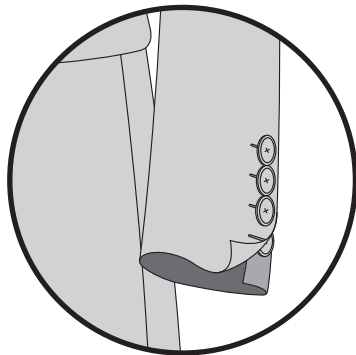

**KISSING
(TOUCHING)**

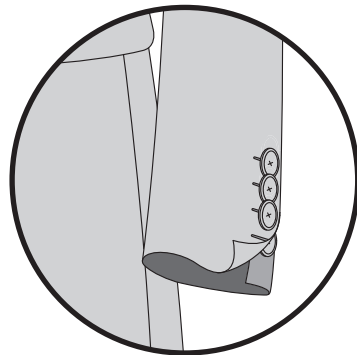

**STACKED
(OVERLAPPING)**

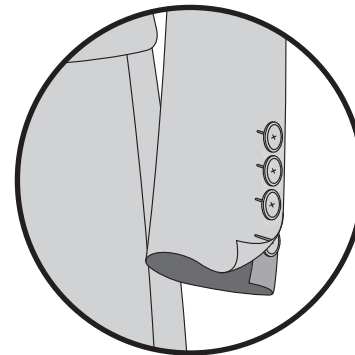

SPACED 1/8"

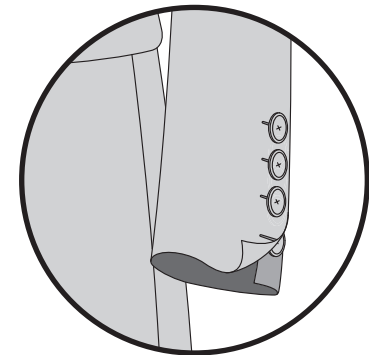

SPACED 1/4"

INTERIOR JACKET OPTIONS // BREAST POCKETS + ADDITIONAL POCKETS

BREAST POCKETS

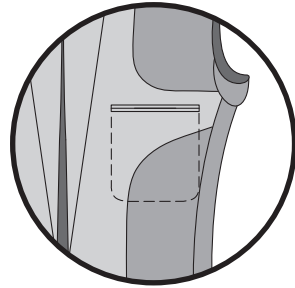
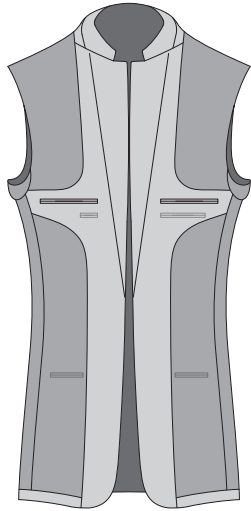

DOUBLE BESOM

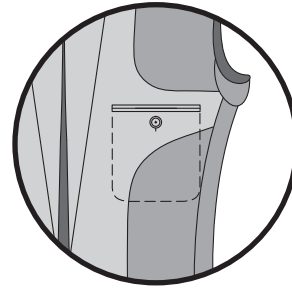

**DOUBLE BESOM WITH
BUTTON THROUGH**

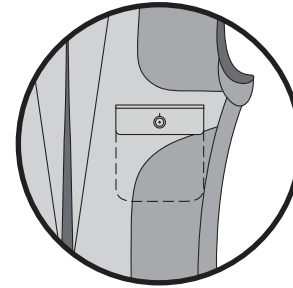

**DOUBLE BESOM WITH
FLAP AND BUTTON**

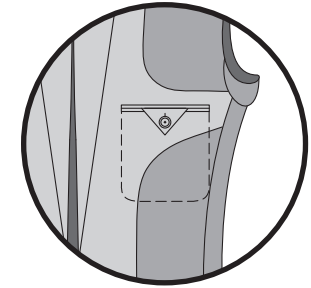

**DOUBLE BESOM WITH
TRIANGLE FLAP
AND BUTTON**

ADDITIONAL POCKETS

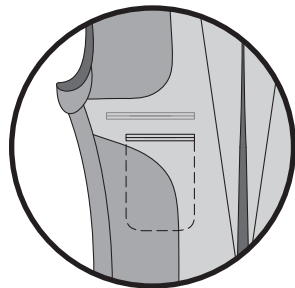

CELL PHONE

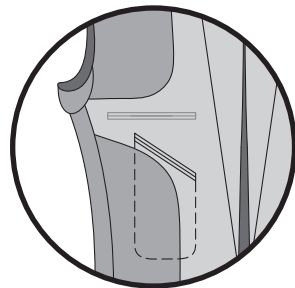

**SLANTED
CELL PHONE**

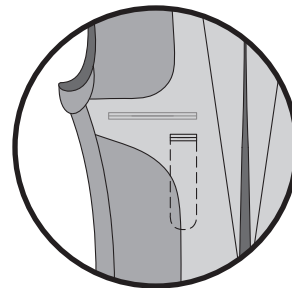

PEN / PENCIL

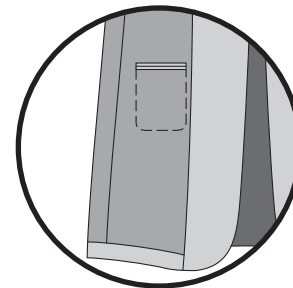

**LOWER CARD
DOUBLE BESOM**

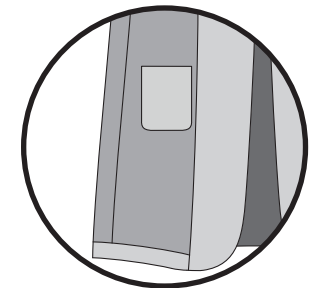

**LOWER CARD
PATCH**

Available for Left, Right or Both

Available for Left or Right

INTERIOR OPTIONS // LINING PLACEMENT + INTERIOR SHAPE

LINING PLACEMENT

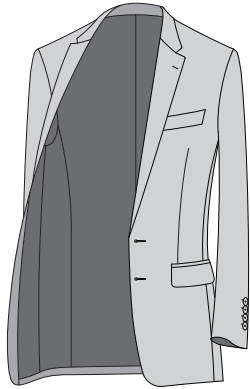

FULL

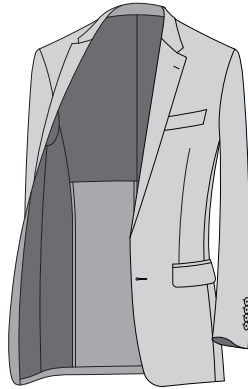

**1/2 LINED BACK
FLAT**

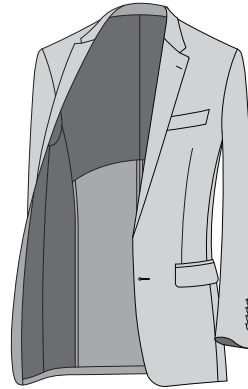

**1/2 LINED BACK
ARCHED**

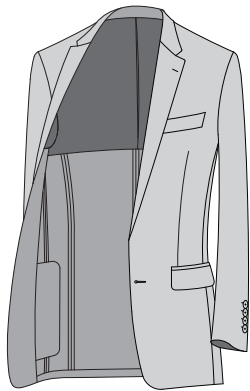

**1/3 LINED BACK
FLAT***

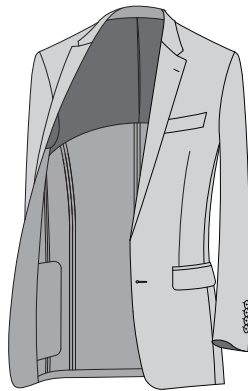

**1/3 LINED BACK
ARCHED***

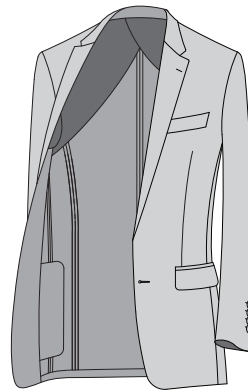

1/4 LINED BACK*

* 1/3 and 1/4 Lined options ONLY available for C205 (Tuscany Tailoring Grade)

INTERIOR SHAPE

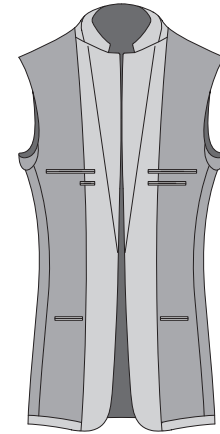

CLASSIC PARALLEL

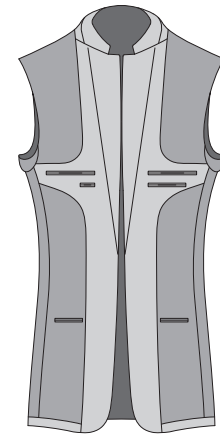

**CURVED FRENCH FACING
ONE PIECE**

TROUSER MODELS // FLAT FRONT + PLEATED

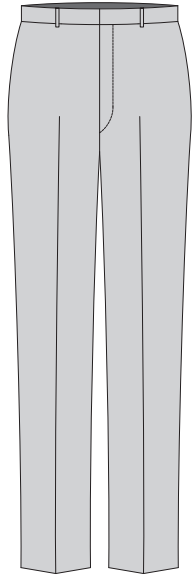

MODERN FLAT FRONT

No darts at waistband

T-OSF

UPDATED FLAT FRONT

Seam forward, standard double back dart

T-OT

UPDATED FLAT FRONT

Trim

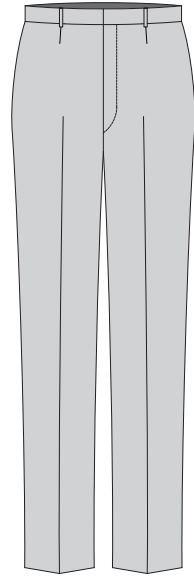

UPDATED FLAT FRONT

Single darts at waistband

T-0D2

UPDATED FLAT FRONT

Twin darts at waistband

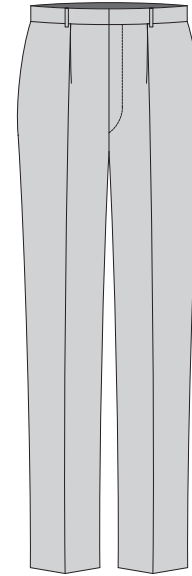

SINGLE PLEAT

Single forward pleat

T-1R

UPDATED SINGLE PLEAT

Single reverse pleat

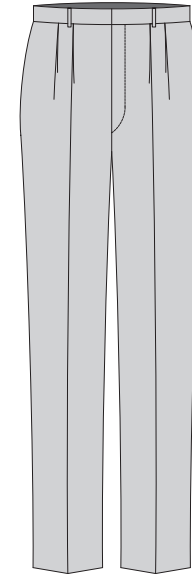

DOUBLE PLEAT

Double forward pleat

T-2R

UPDATED DOUBLE PLEAT

Double reverse pleat

EXTERIOR TROUSER OPTIONS // WAISTBAND EXTENSIONS + TREATMENTS

WAISTBAND EXTENSIONS

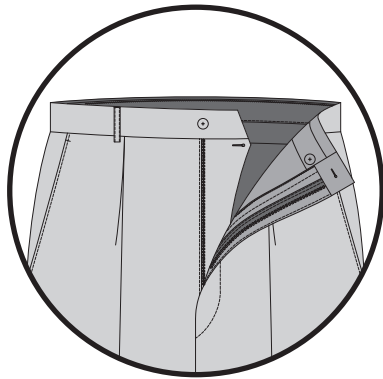

SQUARE BUTTON THROUGH

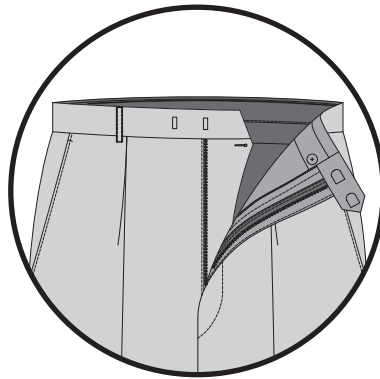

**2" POINT EXTENSION
DOUBLE HOOK AND BAR**

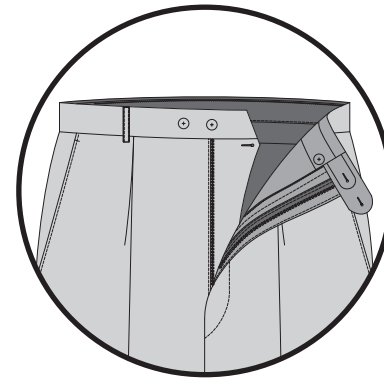

**2" ROUND EXTENSION TABS
WITH DOUBLE BUTTON**

Available Options: None, 2", 2 1/2", 3" (in Double Button, Double Hook and Bar, Combination)

TREATMENTS

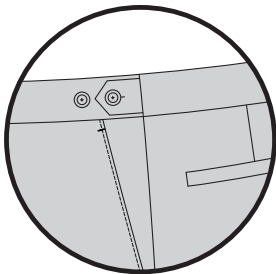

**POINT SIDE TABS
AND BUTTONS**

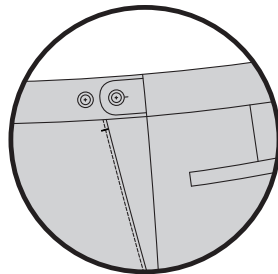

**ROUND SIDE TABS
AND BUTTONS**

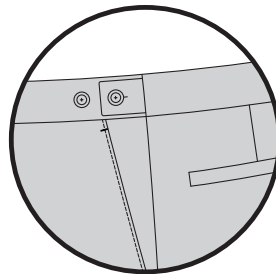

**SQUARE SIDE TABS
AND BUTTONS**

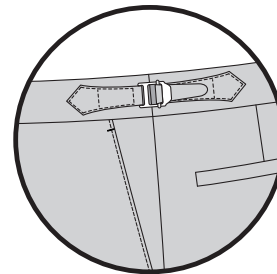

**BUCKLE SIDE
TABS***

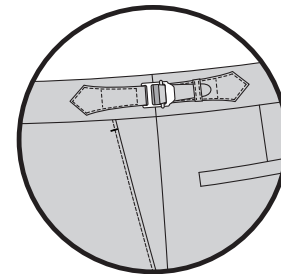

**BUCKLE SIDE TABS
WITH KEEPERS***

Waistband Treatments are ONLY available when the following Interior Waistband Styles are selected: Waistband Without Curtain or Snugtex

* Buckle available in Nickel or Coffee Bronze

EXTERIOR TROUSER OPTIONS // BELT LOOPS + BELT LOOP CONSTRUCTION

BELT LOOPS

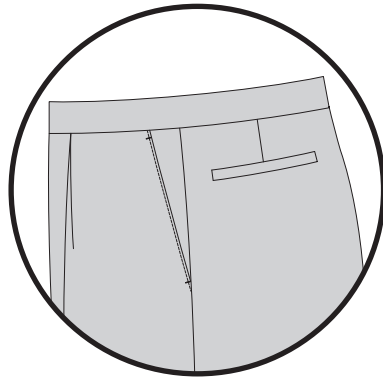

NONE

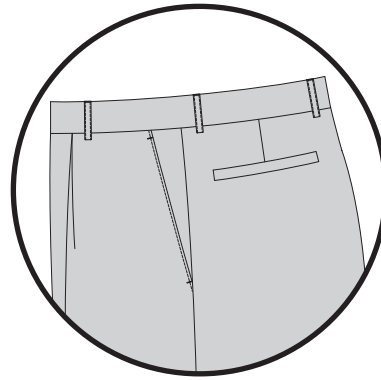

3/8" LOOPS

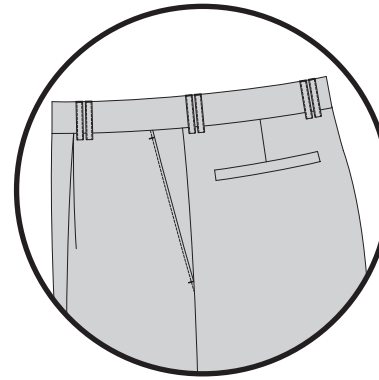

3/8" DOUBLE LOOPS

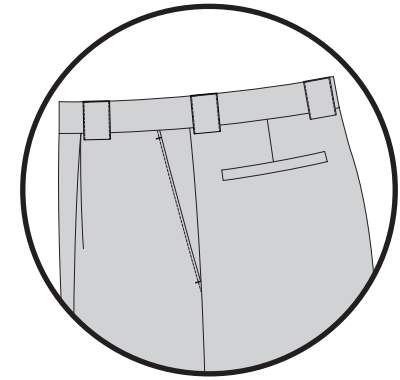

1" LOOPS

BELT LOOP CONSTRUCTION

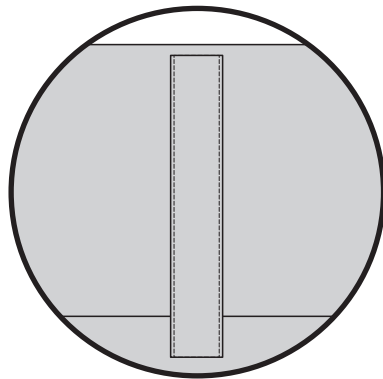

GROWN ON LOOPS

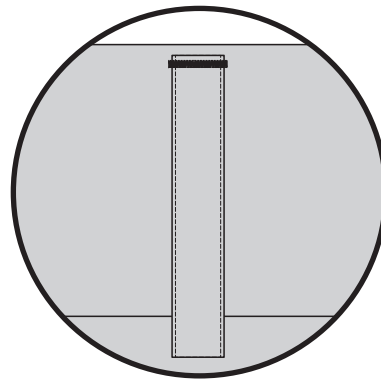

**GROWN ON LOOPS
TOP STITCH**

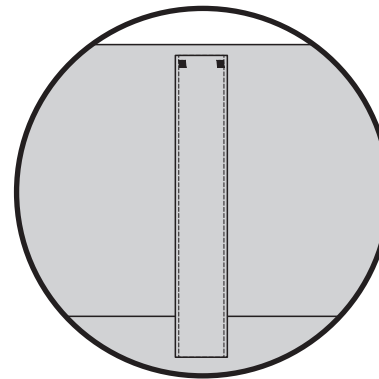

**GROWN ON LOOPS
TACKED**

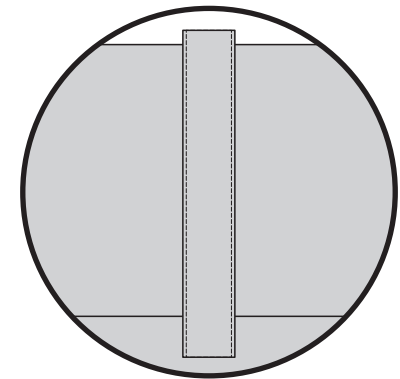

**SEWN IN LOOPS
(SEWN INTO INTERIOR WAISTBAND)**

EXTERIOR TROUSER OPTIONS // FRONT POCKETS + BACK POCKETS

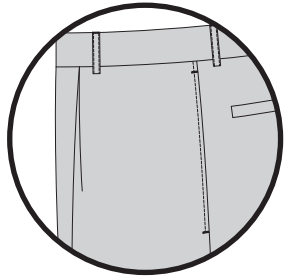

SIDE SEAM

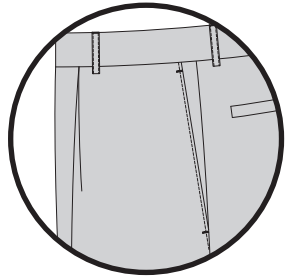

EIGHTH TOP

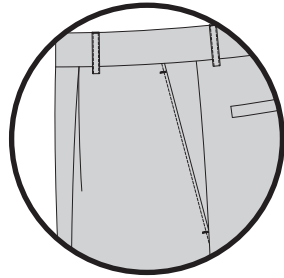

QUARTER TOP

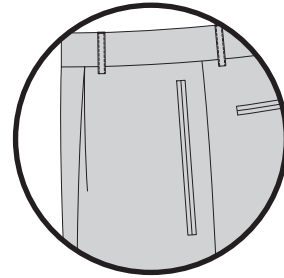

**OFFSET
DOUBLE BESOM**

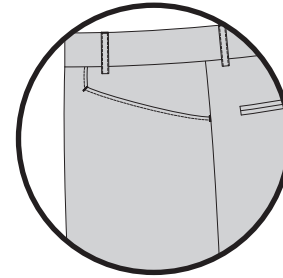

WESTERN

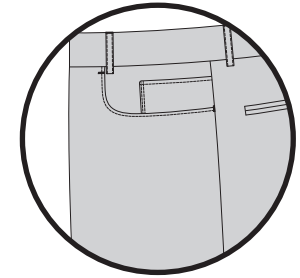

**JEAN WITH
FIFTH POCKET**

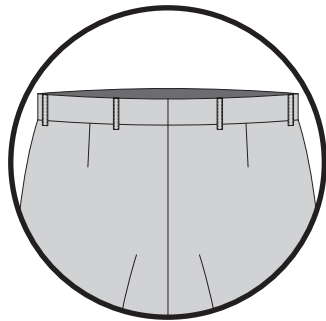

NONE

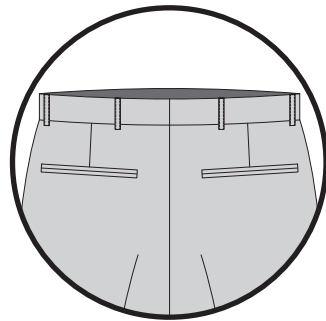

DOUBLE BESOM

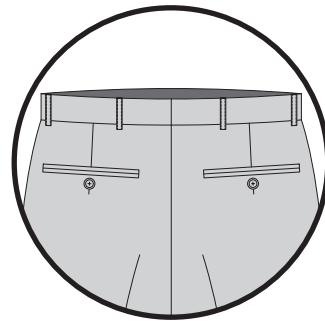

**DOUBLE BESOM WITH
BUTTON THROUGH**

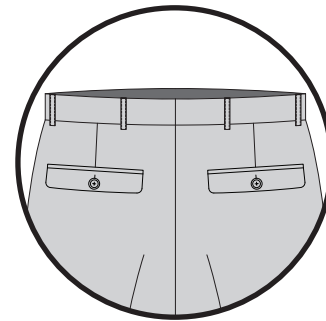

**DOUBLE BESOM WITH
FLAP AND BUTTON**

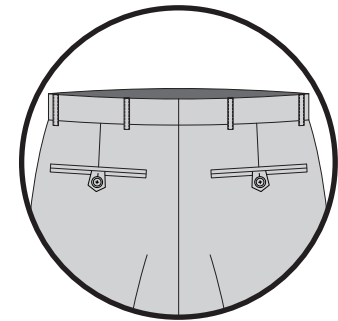

**DOUBLE BESOM WITH
POINT TAB AND BUTTON**

All Back Pocket Options are available for Left, Right or Both sides

EXTERIOR TROUSER OPTIONS // HEM

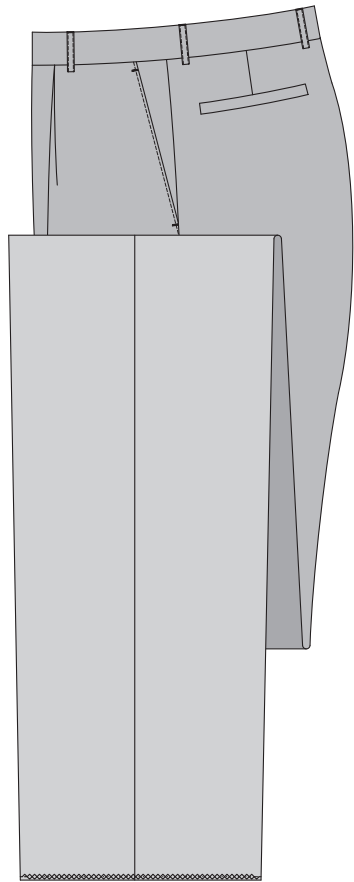

**UNFINISHED BOTTOMS
(5" ADDED TO OUTSEAM)**

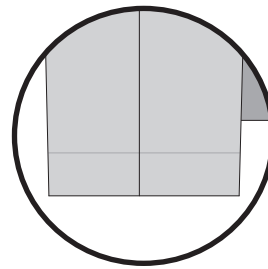

2" PLAIN BLIND HEM

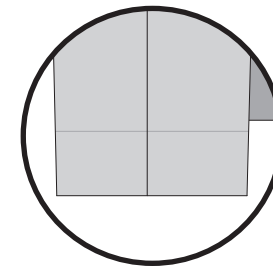

3" PLAIN BLIND HEM

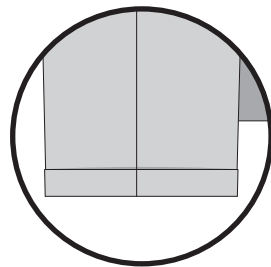

CUFFS 1 1/4"

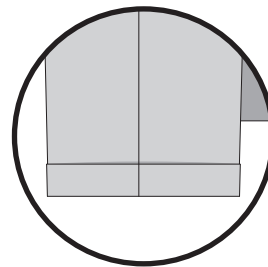

CUFFS 1 1/2"

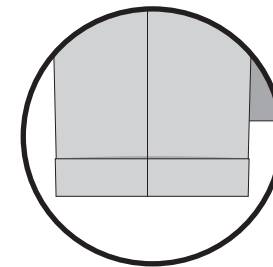

CUFFS 1 3/4"

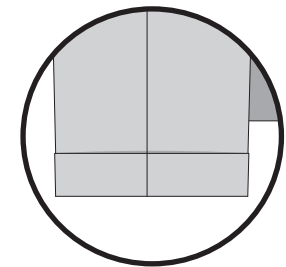

CUFFS 2"

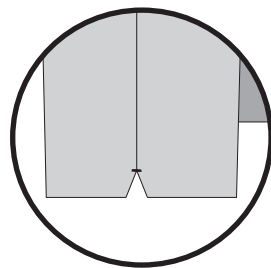

**SMALL TOUR NOTCH
1 1/4" x 1"**

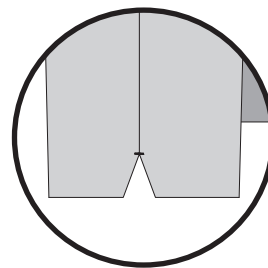

**LARGE TOUR NOTCH
2" x 1 1/2"**

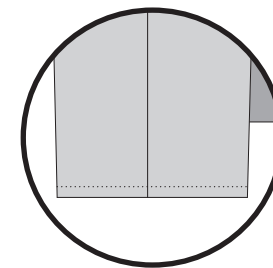

**1/2" PIC STITCH HEM
ROLLED**

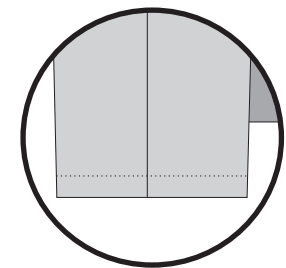

**1" PIC STITCH HEM
ROLLED**

INTERIOR TROUSER OPTIONS // WAISTBAND STYLES + LINING PLACEMENT

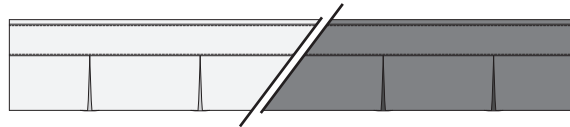

WAISTBAND WITH PLEATED CURTAIN

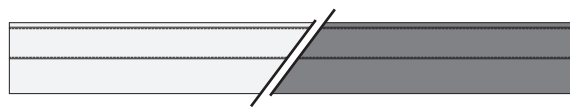

WAISTBAND WITHOUT CURTAIN

Available in Ivory or Black

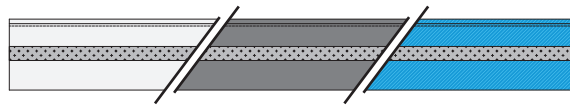

SNUGTEX WAISTBAND

Available in Ivory, Black, Fancy or Premium Fancy



CASUAL SPORT WAISTBAND

Exterior Fabric Only

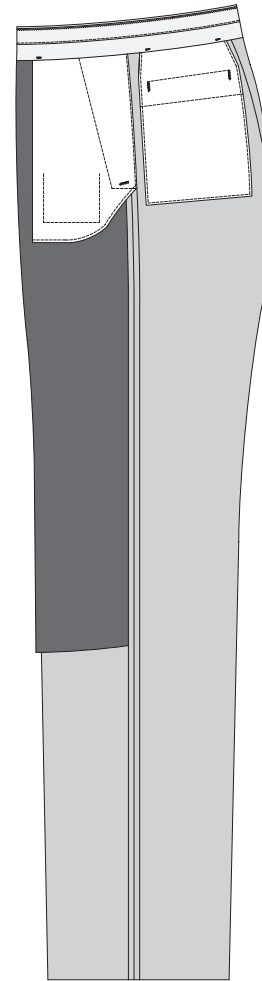

4" BELOW KNEE

Front Only

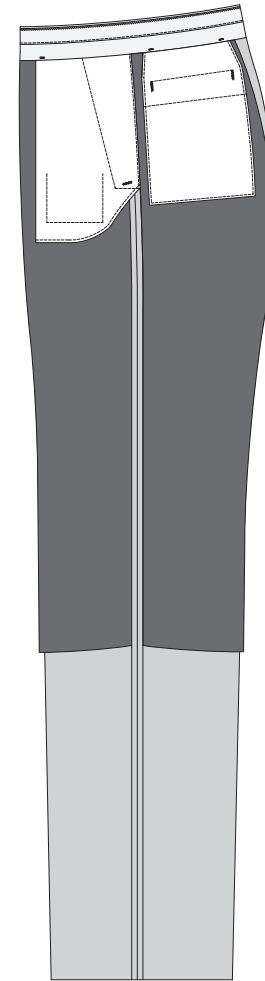

4" BELOW KNEE

Front and Back

VEST MODELS // SINGLE BREASTED + DOUBLE BREASTED

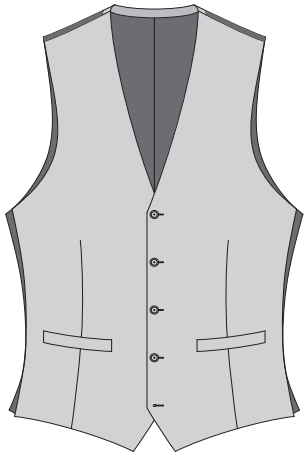

V-1
TRADITIONAL FIVE BUTTON

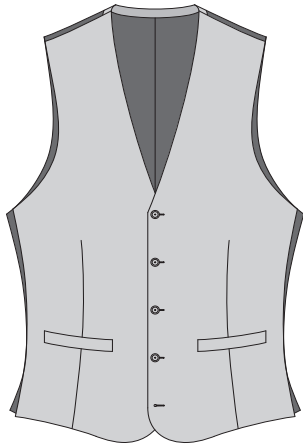

V-2
STANDARD FIVE BUTTON
Square bottom

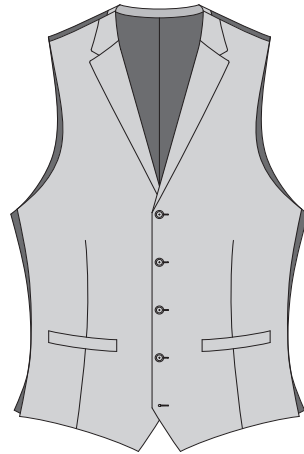

V-3
UPDATED FIVE BUTTON
Notch lapel

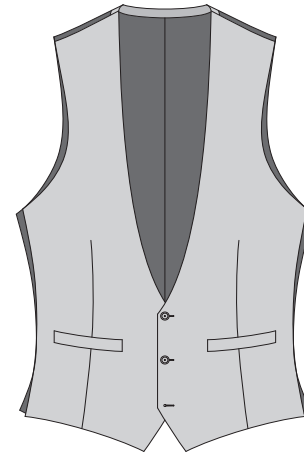

V-8
STANDARD THREE BUTTON

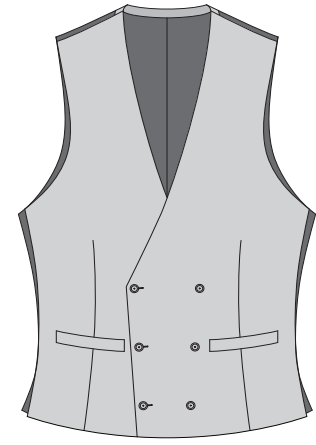

V-DB6x3
DOUBLE BREASTED SIX BUTTON
Three buttons to button

EXTERIOR VEST OPTIONS // BREAST POCKET + LOWER POCKETS + BACK STRAP

BREAST POCKET

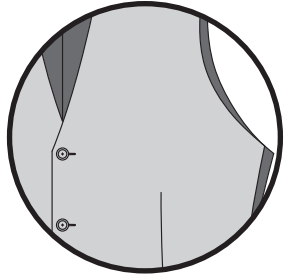

NONE

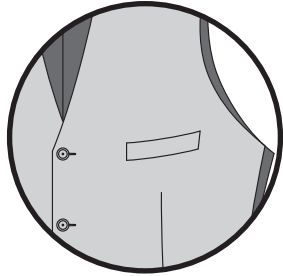

WELT

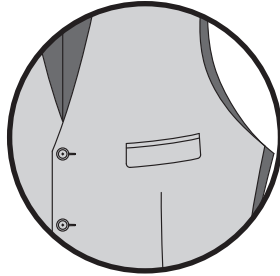

DOUBLE BESOM
WITH FLAP

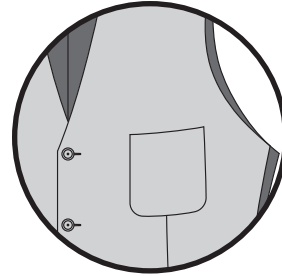

PATCH

BACK STRAP

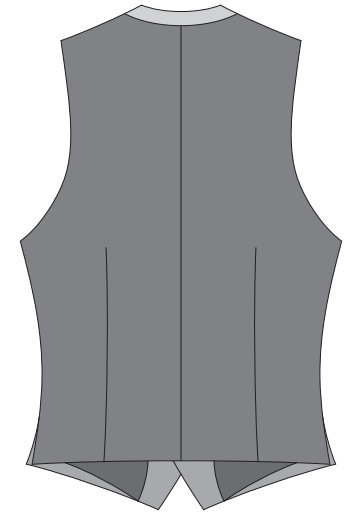

NO BACK STRAP

LOWER POCKETS

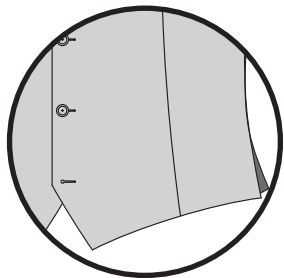

NONE

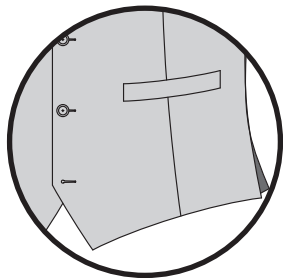

WELT

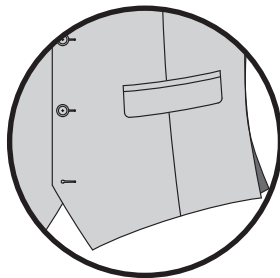

DOUBLE BESOM
WITH FLAP

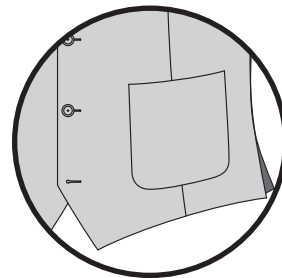

PATCH

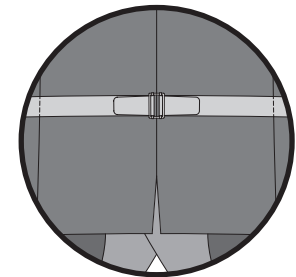

WITH BACK STRAP

Available Strap Fabric Options: Shell Fabric, Specify Lining, Match Lining, Specify Premium Lining, Specify Bemberg Lining

FORMAL TREATMENT // JACKET OPTIONS + LAPELS & COLLARS

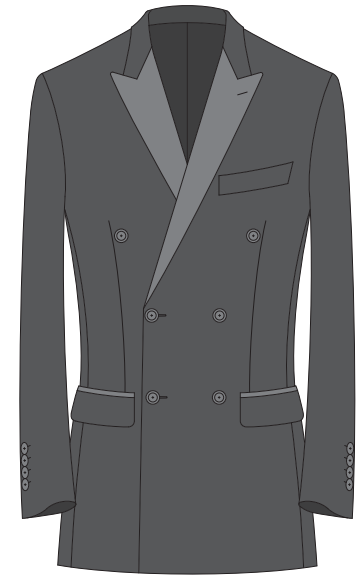
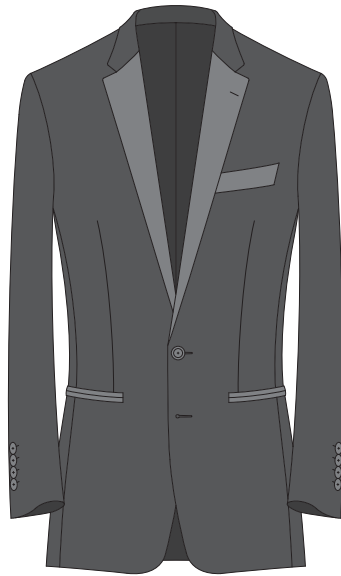
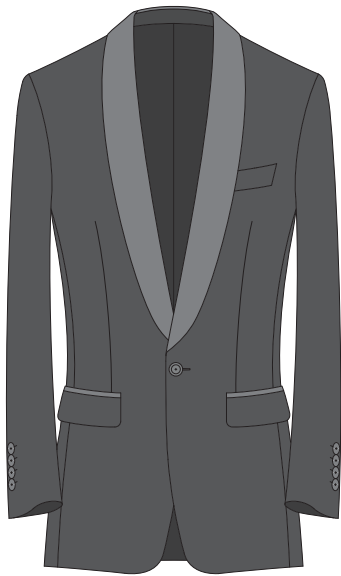

Available Treatment Options: Lapel, Collar, Breast Welt, Lower Pocket Cording

(Jacket Models: C101, C102, C103, C201, C202, C203, C301, C302, C303, DB4x2, DB6x2)

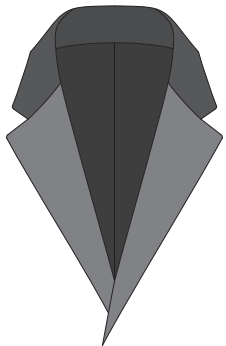

NOTCH

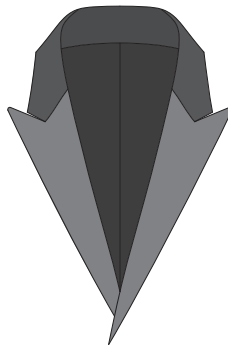

PEAK

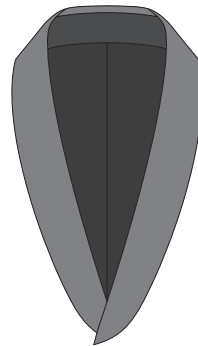

SHAWL*

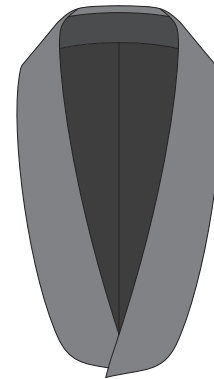

FASHION SHAWL*

* Shawl Lapel not available on Double Breasted Jacket Models. Fashion Shawl Lapel is only available with Jacket Model C102-FS

FORMAL TREATMENT // TROUSER OPTIONS + VEST OPTIONS

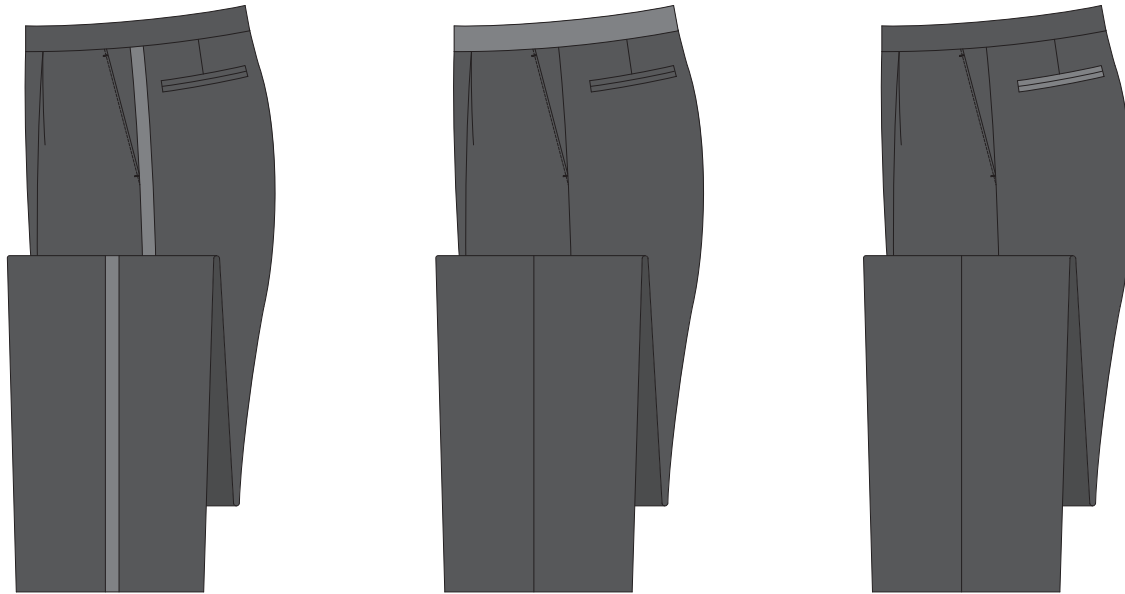

Available Treatment Options: Single Braid, Waistband, Back Pocket Cording (Available on all Trousers Models)



Available Treatment Options: Lapel, Collar, Breast Welt, Lower Pocket Cording (Available on all Vest Models)

ADDITIONAL STYLING

JACKET

- Available Construction Types: Structured (English Feel) and Soft (Italian Feel)
- Collar Tabs / Throat Latches
- Elbow Patches: Rectangular or Oval (Oval Recommended)
- Seam Construction: Lap Seams available
- Pocket Edge Stitching (Interior Only): Bar Tack and D Stitch

TROUSER

- Pleat Tackdown Length: None - 1 ½" (in ¼" increments)
- Pleat Depth: 1", 1 ¼", 1 ½" or 1 ¾" (1" is standard)
- Heel Guard / Laundry Marker
- Suspender Buttons
- Griplets
- Zippers - Metal or Nylon

! THIS IS A CONDENSED VERSION OF THE CLOTHING STYLE MANUAL. MORE OPTIONS ARE AVAILABLE WHEN ENTERING ORDERS IN WORKFLO.