



STANLEY®



SECURITY CATALOG 2021

Your world. Truly secure.

ONE DAY WITH STANLEY LOCKS

BIKE LOCK

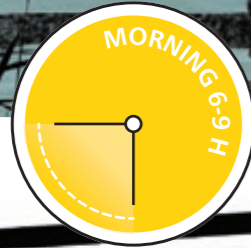

INDOOR COMBINATION LOCK



INDOOR COMBINATION LOCK



LOVE LOCK



SINGLES & FAMILIES USES STANLEY® LOCKS

SINGLES & FAMILIES USES STANLEY® LOCKS



LUGGAGE TSA LOCKS



CARABINER LOCK



SOLID BRASS ARMORED



FAMILY BIKE LOCK

STANLEY®

ONE MAN, ONE VISION, 170 YEARS OF SUCCESS

In 1843, Frederick T. Stanley founded "The Stanley Works" – a small company that manufactured hinges, bolts and other door hardware in New Britain, Connecticut. His vision was to offer products that would become the first choice among professionals around the world.

Thanks to the increasing demand for his high-quality products, Mr. Stanley began exporting in the 1870s. Soon his rapidly growing business established its first production facilities outside the U.S. By 1920, STANLEY® brand hardware was preferred, and could be found on every continent.

Today STANLEY® is one of the world's most recognized and trusted brand names for hardware products. Providing outstanding quality and maximum security, STANLEY® has gained an excellent reputation as an expert for padlocks. You can count on STANLEY® as a strong retail partner just as you can count on its successful products presented in the following.



THREE PADLOCK RANGES AND BIKE LOCKS OFFERED BY STANLEY®

RELIABLE PADLOCKS FOR EVERY DAY-USE

INDOOR OUTDOOR ALL-WEATHER

- ✓ meet all demands of the mass market and drive your sales and profit
- ✓ cover all relevant price points
- ✓ always providing the security and quality of a branded product

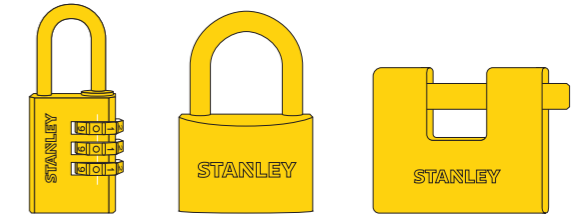

A MUST-HAVE PRODUCT FOR TRAVELERS

- ✓ drive additional sales
- ✓ available in different types
- ✓ various attractive colors and finishes



TSA: the international standard for Travel Security. Travel Sentry Approved (TSA) locks can be opened and re-locked with a special key by international security administration at every airport.



SPECIAL LOCKS

- ✓ offer special promotional padlocks
- ✓ drive additional sales
- ✓ Love Lock for emotional moments
- ✓ Carabiner Lock incl. 180cm leash in 2 different styles

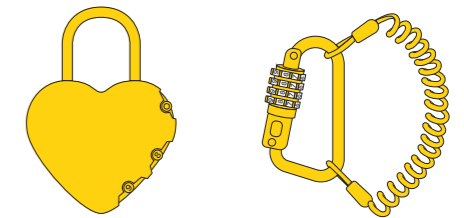

BIKE LOCKS FOR MOBILE SAFETY

HIGH MEDIUM STANDARD

- ✓ wide range of convenient & reliable Bike Locks
- ✓ U-Shape, Cable Key, Cable Combination & Reflective
- ✓ solutions for quick stop or an all-day lock-up

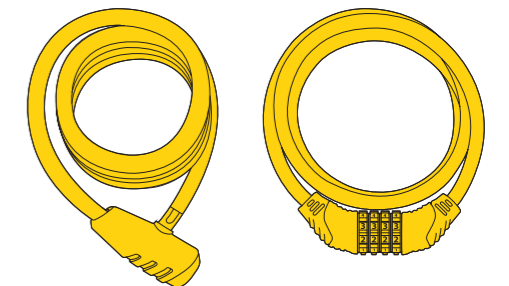

COLOR CONCEPT

✓ For different application areas ✓ Better orientation ✓ Quick purchase decision



**ALL-WEATHER
PADLOCKS**

The Stanley® All Weather Padlocks with the blue label offer additional protection against corrosion near coastal environments by using exterior chrome plating. Perfect for use with boats and boat trailers.



**OUTDOOR
PADLOCKS**

The Stanley® Outdoor Brass Padlocks are the all-around padlocks for nearly every outdoor use: constructed with brass pins, stainless steel springs and a double locking hardened steel shackle, these padlocks are perfect for securing fences, sheds, containers or chains.



**SPECIAL
PADLOCKS**

Stanley® offers a variety of specialty locks like a Love Lock to show your love in a unique way or a Carabiner Lock with a leash to secure your belongings while you are on the go.



**HIGH SECURITY
BIKE LOCKS**

Stanley® High Security Bike Locks are ideal for all-day & overnight lock-ups in suburban and metropolitan areas when locking valuable bikes and scooters.



**INDOOR
PADLOCKS**

The green-labeled Stanley® Indoor Combination Padlocks are made with a high quality solid brass cage and wheels designed to provide basic protection for indoor applications like lockers or tool boxes.



**TRAVEL
PADLOCKS**

The Stanley® TSA Padlocks are the perfect companion for travelers around the world. Travel Sentry Approved (TSA) padlocks can be opened and re-locked with a special key by the international security administration at every airport worldwide without destruction, and can even show you if your luggage was screened. They are available in different colors, surfaces, and shapes to personalize your baggage.



**MEDIUM SECURITY
BIKE LOCKS**

Medium Security Bike Locks with a flexible steel cable are made for locking bikes in suburban and public areas for a few hours or all-day long. Available in combination and keyed versions.



**STANDARD SECURITY
BIKE LOCKS**

Standard Security Bike Locks are ideal for quick stops and hourly lock-ups. Available in combination and keyed versions.

WARRANTY EXTENSION

! WARRANTY EXTENSION
with registration on www.safeguard-locks.com

- ✓ Increase awareness on products
- ✓ Increase awareness for webpage
- ✓ Give consumer a truly secure feeling in quality and customer service
- ✓ Make them feel that they are in „good hands“



Standard warranty period

Warranty extension

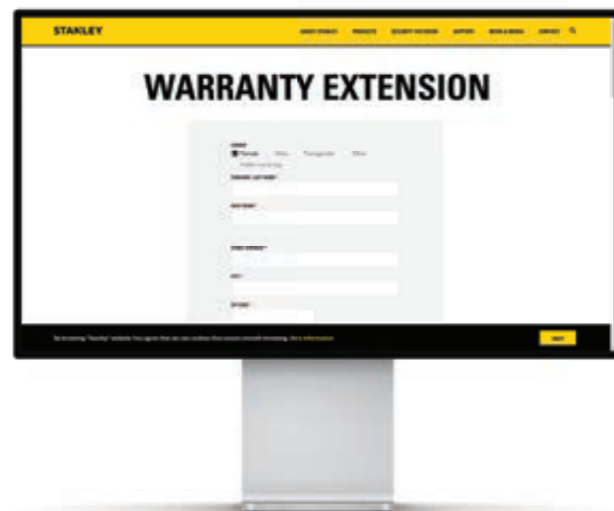

RATING PRINCIPLE

	Standard Security					Medium Security					High Security				
	1	2	3	4	5	6	7	8	9	10	11	12	13	14	15
CORROSION LEVEL	DRY (< 12 hours)					WET (48 hours)					EXTREME (96 hours)				
APPLICATION LEVEL	Quick stop / Couple of hour lock-up					All day lock-up					Overnight lock-up				
LOCK-UP AREAS	Rural					Suburban					Metropolitan				
SHACKLE / CABLE DIAM.	8mm					10mm, 12mm, 13mm					14mm, 15mm				
COMFORT FEATURES	Traditional look / Includes bike holders					Vynil covered shackle/ cable, includes holders					Cylinder dust covers, includes holders				
DESIGN FEATURES	Easy to mount					Attractive packaging/product design					High security cylinders				

11	S755-201	8	S755-202	8	S755-204	5	S741-153	5	S741-157
U-Shape Lock		Key Cable		Comb. Cable		Key Cable		Key Cable	
Ø14 mm		Ø12 mm Length: 1800mm		Ø12 mm Length: 1800mm		Ø10 mm Length: 1800mm		Ø10 mm Length: 1800mm	

POS SUPPORT – FOR DRIVING YOUR SALES

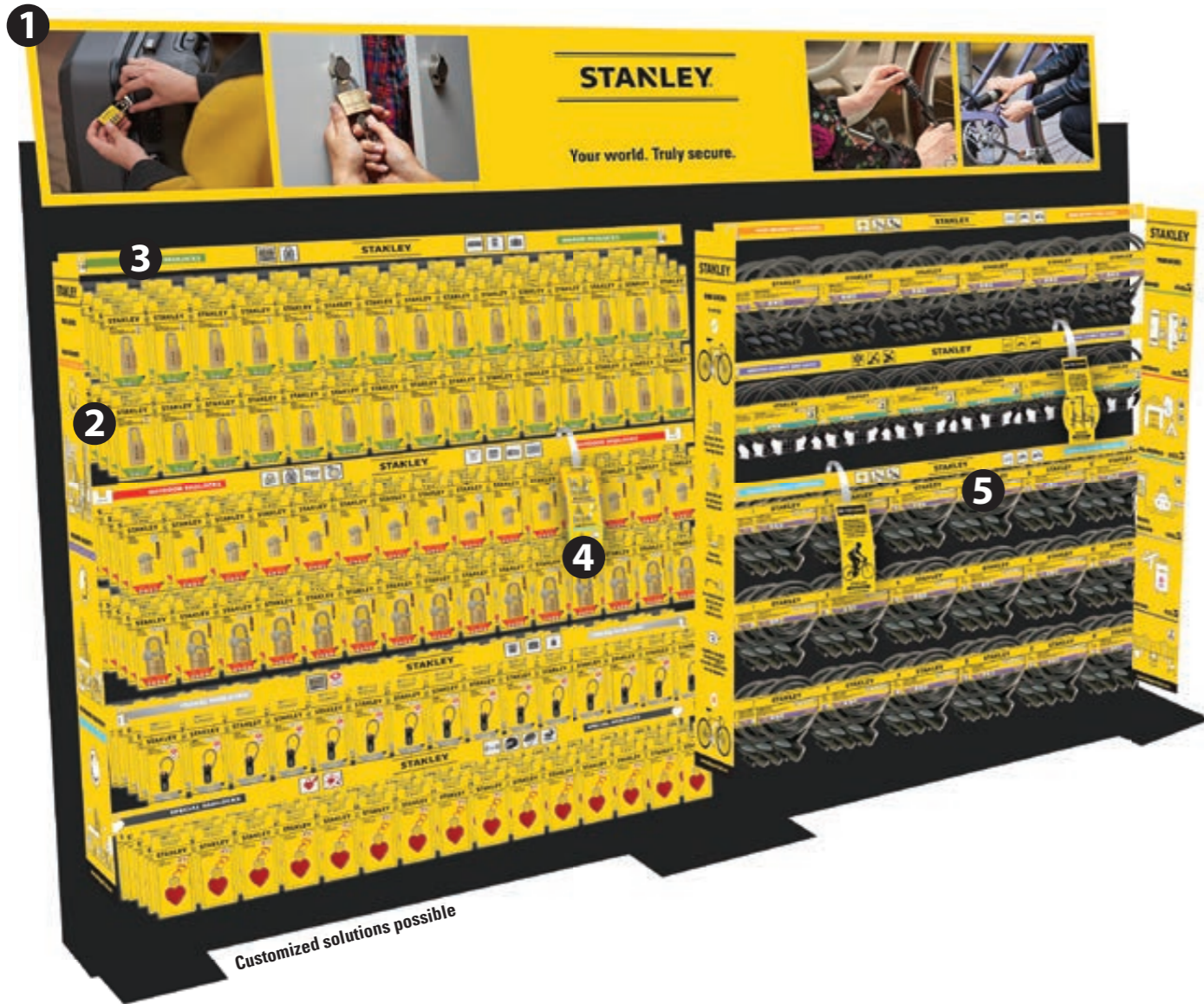

1

3

2

4

5

Customized solutions possible

1 HEADER



Dimensions: 1330 x 600 mm
4/4 coloured Dispersion varnish

2 SHELF STOPPERS

Dimensions: 140 x 850 mm
Coated paper 350g/qm
4/4 coloured, dispersion varnish

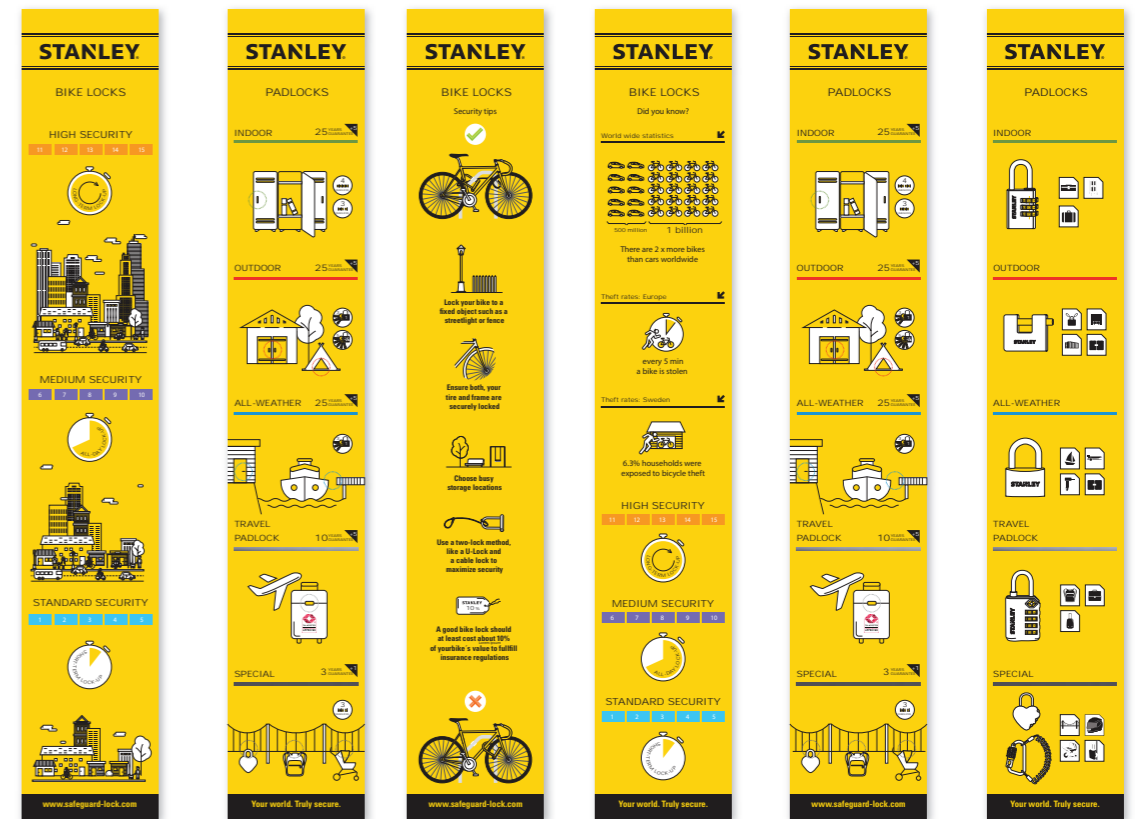

3 SHELF RAILS

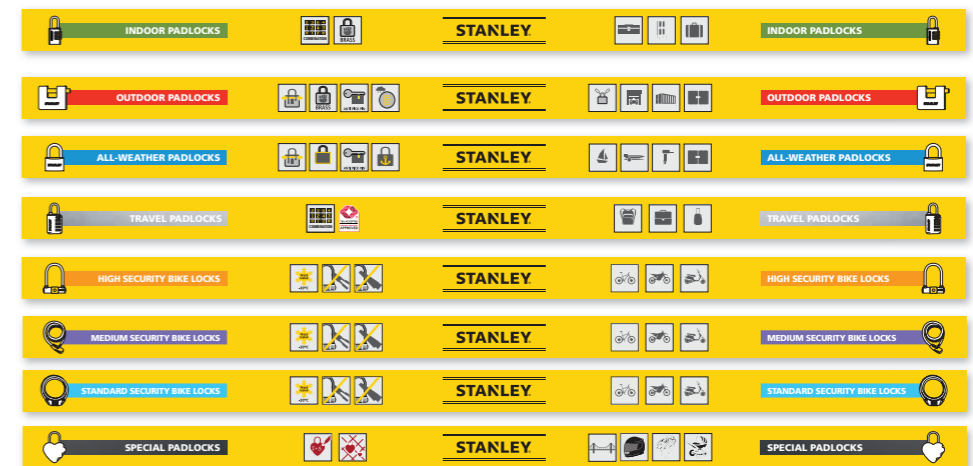

4 WOBBLERS



5 BROCHURE

STANLEY.

PADLOCKS



SOLID BRASS CHROME PLATED

ALL-WEATHER

+5
25
*25 years guarantee
25 años de garantía
Garantie 25 ans.



The STANLEY® Marine Padlocks offer additional protection against corrosion near coastal environments. Utilizing the same features found on our Brass Padlocks, the Marine line of padlocks features an exterior chrome plating that makes them an ideal choice for securing property in outdoor applications. Available in standard or long shackle.

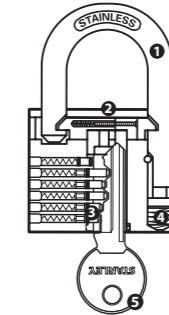

Standard Shackle Padlock

- ❶ Double Locking Hardened Steel Shackle.
- ❷ Solid Brass Body.
- ❸ Anti-Pick Pin.
- ❹ Stainless Steel Springs.
- ❺ 3 Keys.

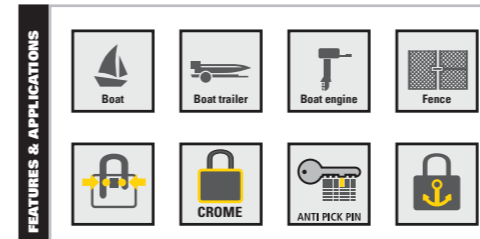

Standard shackle	Long shackle
Chrome Plated 30mm std. shackle	Chrome Plated 30mm long shackle
Chrome Plated 40mm std. shackle	Chrome Plated 40mm long shackle
Chrome Plated 50mm std. shackle	Chrome Plated 50mm long shackle

For more details please see page 24

SOLID BRASS ARMORED PADLOCKS

OUTDOOR

+5
25
*25 years guarantee
25 años de garantía
Garantie 25 ans.



The Stanley® Armored Padlock with a hardened steel case provides a high level of security for both professional and daily use. These padlocks utilize a hardened steel transverse bar that rotates to prevent saw attacks. To protect against drill attacks on the keyway, the cylinder employs an anti-drill plate. These features deliver the security that many other padlocks fail to provide which often results in property loss or damage.

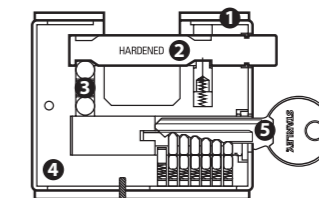

Armored Padlock

- ❶ Steel Hardened Case.
- ❷ Hardened Steel Transverse Bar.
- ❸ Ball-Bearing Locking System.
- ❹ Solid Brass Body.
- ❺ 3 Keys.

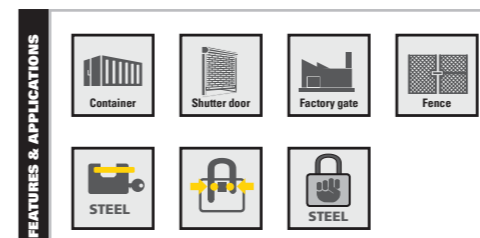

Solid Brass Armored Padlocks
Solid Brass Armored 60mm
Solid Brass Armored 80mm
Solid Brass Armored 90mm

For more details please see page 25

PRODUCTS

SOLID BRASS BAYONETTE PADLOCKS

OUTDOOR

+5
25
*25 years guarantee
25 años de garantía
Garantie 25 ans



The Stanley® Bayonette Padlock is a great choice for both professional and daily use security needs. The bayonette design is ideal for rolling shutter doors or truck doors and prevents against bolt cutter attacks. These Solid Brass Padlocks utilize a hardened-steel transverse bar that rotates to prevent saw attacks. In addition, the brass pins in the keyway and stainless steel springs deliver the long term performance you expect from the Stanley® brand.

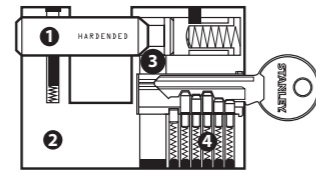

Bayonette Padlock

- 1 Hardened Steel Transverse Bar.
- 2 Solid Brass Body.
- 3 Ball-Bearing Locking System.
- 4 Stainless Steel Springs.

Solid Brass Bayonette Padlocks

- Solid Brass Bayonette 50mm
- Solid Brass Bayonette 70mm
- Solid Brass Bayonette 90mm

For more details please see page 25

FEATURES & APPLICATIONS

- Container
- Shutter door
- Factory gate
- Truck
- STEEL
- BRASS

SOLID BRASS PADLOCKS

OUTDOOR

+5
25
*25 years guarantee
25 años de garantía
Garantie 25 ans



The line of Stanley® standard Shackle Brass Padlocks are suited for both indoor or outdoor use. Constructed with brass pins, stainless steel springs and a double locking hardened steel shackle, these locks deliver strength, security and peace of mind for residential and commercial applications.

Standard Shackle

- Solid Brass 20mm std. Shackle
- Solid Brass 25mm std. Shackle
- Solid Brass 30mm std. Shackle
- Solid Brass 40mm std. Shackle
- Solid Brass 50mm std. Shackle
- Solid Brass 60mm std. Shackle
- Solid Brass 70mm std. Shackle
- 2 Solid Brass 30mm std. Shackle
- 2 Solid Brass 40mm std. Shackle
- 2 Solid Brass 50mm std. Shackle
- 4 Solid Brass 40mm std. Shackle
- 4 Solid Brass 50mm std. Shackle

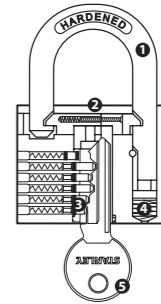

Standard Shackle Padlock

- 1 Double Locking Hardened Steel Shackle.
- 2 Solid Brass Body.
- 3 Anti-Pick Pins.
- 4 Stainless Steel Springs.
- 5 3 keys for single blister
5 keys for keyed alike multiblisters

Long Shackle

- Solid Brass 20mm long Shackle
- Solid Brass 25mm long Shackle
- Solid Brass 30mm long Shackle
- Solid Brass 40mm long Shackle
- Solid Brass 50mm long Shackle

For more details please see page 26-27

FEATURES & APPLICATIONS

- Truck
- Barn
- Garden
- Chain
- BRASS
- ANTI-PICK PIN

BARREL BRASS PADLOCKS

OUTDOOR

+5
25
*25 years guarantee
25 años de garantía
Garantie 25 ans



The Stanley® line of Barrel Padlocks offers you the protection required at the job site. The special design and construction allows for double the strength and security against crowbar attacks. Ideal for cargo trucks, vans, chains and hasps. The oversized shackle allows more strength against saw attacks.

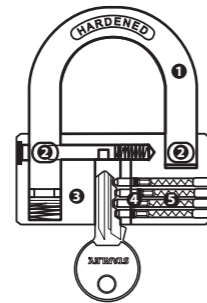

Barrel Brass Padlock

- 1 Double Locking Hardened Steel Shackle.
- 2 Double Locking Lever.
- 3 Extra Wide And Extra Strong Solid Brass Body.
- 4 Anti-Pick Pins.
- 5 Stainless Steel Springs.

High SECURITY Barrel Brass Padlocks

- Barrel Brass 30mm
- Barrel Brass 70mm
- Barrel Brass 40mm
- Barrel Brass 80mm
- Barrel Brass 50mm

For more details please see page 28

FEATURES & APPLICATIONS

- Chain
- Rabbit hutch
- Garden
- Garden box
- BRASS
- ANTI-PICK PIN

BRASS COMBINATION PADLOCKS

INDOOR

+5
25
*25 years guarantee
25 años de garantía
Garantie 25 ans



Stanley® Combination Padlocks are made with a high quality solid brass case and wheels designed to provide basic protection for indoor applications. Combination Brass Padlocks are superior for light duty usage such as securing luggage or storage lockers. They are available in both three and four number combinations.

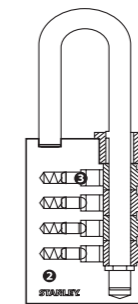

Combination Padlock

- 1 Easy To Reset Combination.
Up To 9999 Unique Combinations.
- 2 Solid Brass Body.
- 3 Brass Pins.

Combination Brass Padlock

- Brass Combination 3 Digit 20mm
- Brass Combination 4 Digit 30mm
- Brass Combination 3 Digit 30mm
- Brass Combination 4 Digit 40mm

For more details please see page 29

FEATURES & APPLICATIONS

- Toolbox
- Locker
- Money box
- COMBINATION
- BRASS

PRODUCTS

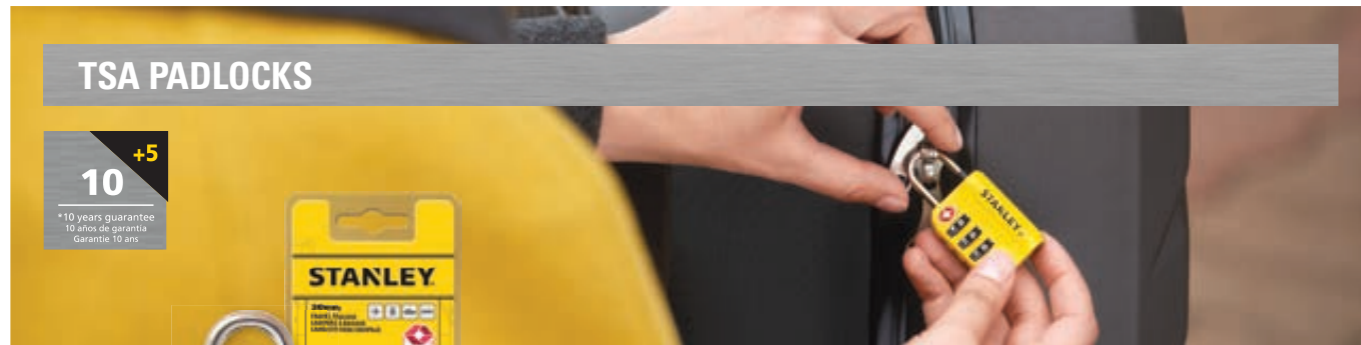

TSA PADLOCKS

10
+5

*10 years guarantee
10 años de garantía
Garantie 10 ans



TSA Padlocks are a must-have product for travelers. Locking your luggage with a TSA approved padlock helps to protect your possessions from theft, tampering and misuse by smugglers. Travel Sentry Approved (TSA) padlocks can be opened and re-locked with a special key by the international security administration at every airport worldwide. Available in various attractive colors and finishes.

FEATURES & APPLICATIONS



3 Digit green TSA Padlock

3 Digit green 30mm Zinc

Combo 2 keyed alike TSA Padlocks

Combo 2 keyed alike black/yellow 20mm Zinc

3 Digit TSA Padlocks with Indicator

3 Digit black 30mm Zinc Security Indicator

3 Digit red 30mm Zinc Security Indicator

3 Digit yellow 30mm Zinc Security Indicator

4 Digit TSA Padlocks

4 Digit black 30mm Zinc

4 Digit red 30mm Zinc

4 Digit yellow 30mm Zinc

3 Digit TSA Padlocks with flexible vinyl-coated Steel Cable

3 Digit black 20mm Zinc Vinyl Steel Cable

3 Digit yellow 20mm Zinc Vinyl Steel Cable

For more details please see page 30-31



TSA SPECIAL PADLOCK: SOCCER

10
+5

*10 years guarantee
10 años de garantía
Garantie 10 ans



Attractive football design. Travel Sentry Approved (TSA) lock: can be opened and re-locked with a special key by international security administration at every airport. Ideal for football excited people and countries. Perfect as a promotion for special football events like European Championship.

FEATURES & APPLICATIONS



For more details please see page 31



TSA SPECIAL PADLOCK: WHITEBOARD

10
+5

*10 years guarantee
10 años de garantía
Garantie 10 ans



TSA approved padlocks are a must-have product for travelers. Locking your luggage with a TSA approved luggage lock helps to protect your possessions from theft, tampering and misuse by smugglers. Travel Sentry Approved padlocks can be opened and re-locked with a special key by the international security administration at every airport worldwide. This 3 Digit TSA approved Combination Padlock allows you to personalize your padlock with a marker for easy identification while securing your luggage.

FEATURES & APPLICATIONS



3 Digit TSA approved Whiteboard

3 Digit 30mm TSA approved Whiteboard

For more details please see page 31

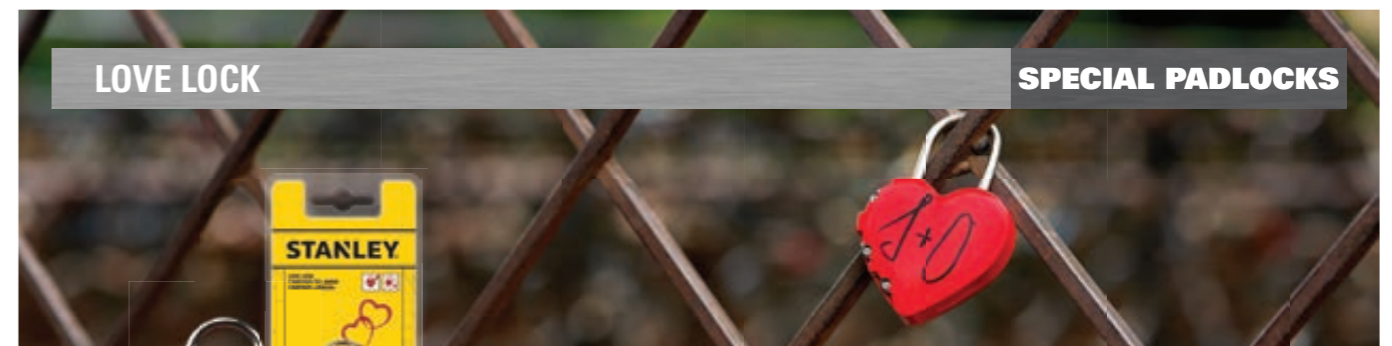

LOVE LOCK

SPECIAL PADLOCKS



Jump on the international trend and place a heart shaped padlock at your favorite travel destination / location / place / spot. Heart shaped padlock as a symbol for your everlasting love and friendship. Perfect as a special gift for your sweetheart, family members, friends and other lovely people. Convenient for special occasions like Valentine's Day, Mother's Day, wedding, birthday, etc. Inscribe easily your personal initials with a permanent pen.

FEATURES & APPLICATIONS



For more details please see page 34

CABLE KEY REFLECTIVE BIKE LOCK

MEDIUM

3⁺¹
*3 years guarantee
3 años de garantía
Garantie 3 ans

Stanley® Reflective Cable Locks is ideal for all-day lock-ups of your bike or e-bike in metropolitan areas. The reflective coating adds additional safety when riding and makes it easier to locate your bike when it is locked up at night.

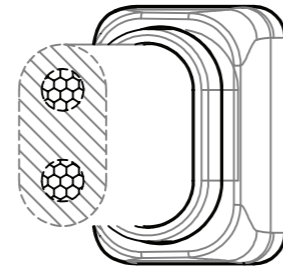

12mm Double-Wired Flat

- ❶ Dual wire flat cable with double strength.
- ❷ Special carbon textured lock housing.

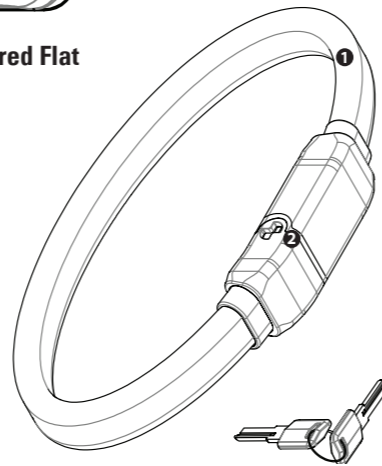

FEATURES & APPLICATIONS



Cable Key Reflective Bike Locks

Key Cable Reflective Lock ø 12x1200 mm

Key Cable Reflective Lock ø 12x2400 mm

For more details please see page 33

4 DIGIT CARABINER LOCK

SPECIAL PADLOCKS

INCL. 180 CM REMOVABLE AND FLEXIBLE LEASH

3⁺¹
*3 years guarantee
3 años de garantía
Garantie 3 ans



The Stanley® 4 Digit Carabiner Lock available in black and silver, including a 180cm flexible and removable leash, can be used to help prevent casual theft of your valuables while on quick stops (e.g. your helmet, bag, handbag, baby buggy, or your jacket.) 4 Digits allow you to set up to 9999 unique and individual code variations to secure your belongings.

FEATURES & APPLICATIONS



Carabiner Locks

Carabiner Lock 4 Digit 85mm silver

Carabiner Lock 4 Digit 85mm black

For more details please see page 34

STANLEY

BIKE LOCKS



KEY CABLE BIKE LOCK

MEDIUM SECURITY

3⁺¹
*3 years guarantee
3 años de garantía
Garantie 3 ans



The Stanley® Cable Lock with its flexible vinyl coated galvanized steel cable and its high security wafer cylinder provides the best operability when a flexible, light cable is needed. The cable locks come with a high quality metallic lock body with reinforced ABS housing for added strength and durability.

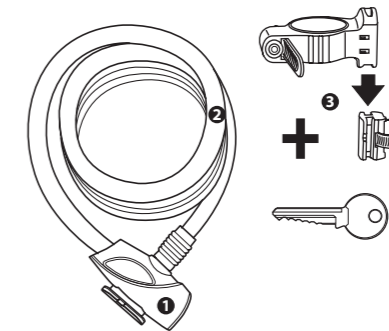

High Security Wafer Cylinder Bike Lock

- 1 High Quality Metallic Lock Body With Reinforced ABS Housing For Added Strength And Durability.
- 2 Flexible Vinyl Coated Galvanized Steel Cable For Strength, Flexibility And Rust Resistance.
- 3 Includes Holder That Mounts Almost Anywhere. 3 Keys.

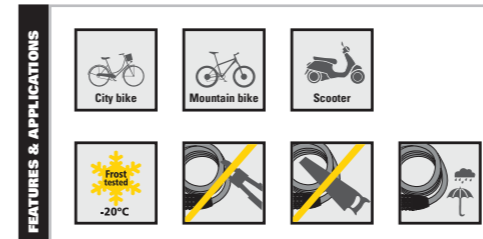

Cable Key Bike Locks

- Cable Key Bike Lock 90cm ø12mm
- Cable Key Bike Lock 180cm ø12mm

For more details please see page 32

HIGH SECURITY U-SHAPE LOCK

HIGH SECURITY

5⁺¹
*5 years guarantee
5 años de garantía
Garantie 5 ans



The Stanley® U-Shape Lock offers you the protection you require when you want to lock your bike. The double deadbolt locking mechanism, the anti-drill disc cylinder, the frost tested and hardened steel shackle underline the high security performance. The U-Shape Lock is due to its security features ideal for high valuable bikes and scooters.

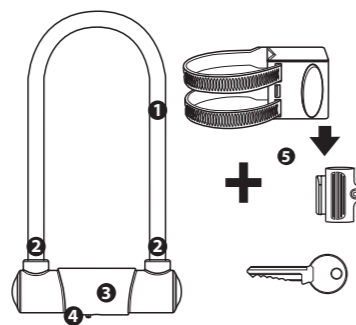

High Security U-Shape Lock

- 1 14mm Hardened Steel Shackle With Anti-Scratch Liner That Resists Bolt Cutters.
- 2 Double Deadbolt Locking Mechanism That Resists Pry Attacks.
- 3 High Security Anti-Drill Disc Cylinder.
- 4 ABS Housing Design With Special Rotating Dust Cover To Prevent Dirt And Water From Accessing The Mechanism.
- 5 Includes Holder That Mounts Almost Anywhere. 3 Keys.

High SECURITY U-Shape Lock

U-Shape 25cm ø14mm

For more details please see page 32

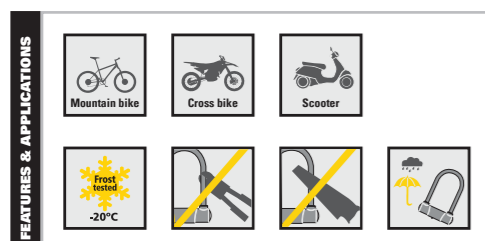

COMBINATION CABLE BIKE LOCK

MEDIUM SECURITY

3⁺¹
*3 years guarantee
3 años de garantía
Garantie 3 ans



The Stanley® Cable Combination Lock with its flexible vinyl coated galvanized steel cable provides the best operability when a flexible, light cable is needed. With its 4 digits resettable combinations it is the best solution for people who do not want to carry a key.

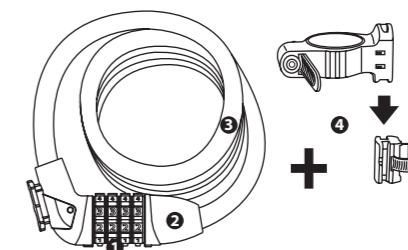

4-Digit Resettable Combination Bike Lock

- 1 Set Your Own Combination, No Key Needed.
- 2 High Quality Metallic Lock Body With ABS Housing.
- 3 Flexible Vinyl Coated Galvanized Steel Cable For Strength, Flexibility And Rust Resistance.
- 4 Includes Holder That Mounts Almost Anywhere.

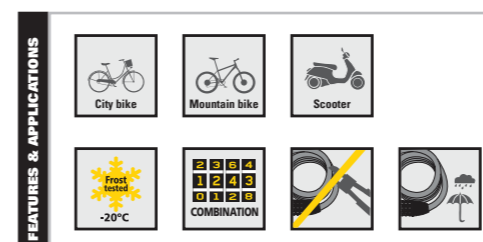

4-Digit Resettable Combination Bike Locks

- Cable Combination Bike Lock 90cm ø12mm
- Cable Combination Bike Lock 180cm ø12mm

For more details please see page 32

PRODUCTS

KEY CABLE FAMILY LOCKS

MEDIUM SECURITY

3⁺¹
*3 years guarantee
3 años de garantía
Garantie 3 ans



Stanley® Cable Locks offer great protection for securing multiple bikes. These locks are ideal to secure bicycles in rural or suburban areas.

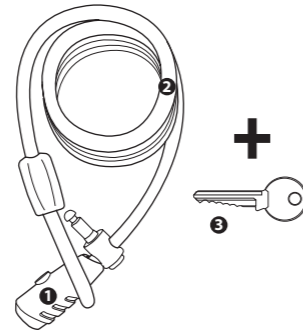

Cable Key Family Lock

- ❶ Strong Zinc Alloy Lock Body With Reinforced ABS Housing.
- ❷ Flexible Vinyl Coated Steel Cable.
- ❸ 3 Keys.

Cable Key Family Lock	
Medium	Cable Key Family Lock 240cm ø12mm
Standard	Cable Key Family Lock 240cm ø10mm

For more details please see page 33

FEATURES & APPLICATIONS

- City bike
- Mountain bike
- BMX
- Frost tested -20°C
- Not for use on motorcycles
- Not for use on scooters
- Not for use on bicycles with fenders

KEY CABLE REFLECTIVE LOCK

MEDIUM SECURITY

3⁺¹
*3 years guarantee
3 años de garantía
Garantie 3 ans



Stanley® Cable Locks offer great protection for all-day lock-ups. These locks are ideal to use in metropolitan areas during the day or night.

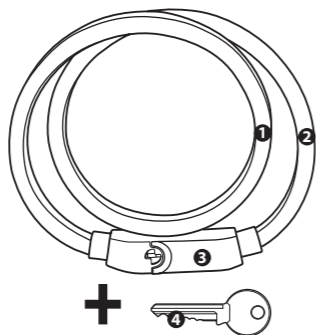

Cable Key Reflective Lock

- ❶ Strong Zinc Alloy Lock Body With Reinforced ABS Housing.
- ❷ 12mm Double-Wired Flat Cable Design For Added Strength.
- ❸ Reflective Cable For Added Safety During Night Rides.
- ❹ 3 Keys.

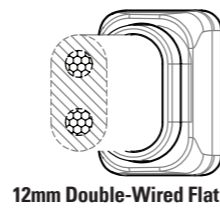

Cable Key Reflective Lock	
	Cable Key Reflective Lock 120cm ø12mm

For more details please see page 33

FEATURES & APPLICATIONS

- City bike
- Mountain bike
- Scooter
- Frost tested -20°C
- Not for use on motorcycles
- Not for use on bicycles with fenders
- Not for use on bicycles with fenders

KEY CABLE BIKE LOCKS

STANDARD SECURITY

3⁺¹
*3 years guarantee
3 años de garantía
Garantie 3 ans



Stanley® Cable Locks are ideal for securing bikes, tool boxes, ladders, and small equipment for short-term lockup in rural areas and suburban areas.

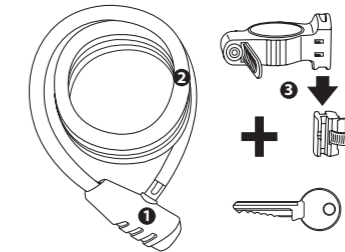

Cable Key Bike Lock

- ❶ Strong Zinc Alloy Lock Body With Reinforced ABS Housing.
- ❷ Flexible Vinyl Coated Steel Cable.
- ❸ Includes Holder That Mounts Almost Anywhere. 3 Keys.

Cable Key Bike Locks	
	Cable Key Bike Lock 180cm ø10mm
	Cable Key Bike Lock 90cm ø10mm

For more details please see page 33

FEATURES & APPLICATIONS

- City bike
- Mountain bike
- BMX
- Frost tested -20°C
- Not for use on motorcycles
- Not for use on bicycles with fenders
- Not for use on bicycles with fenders

COMBINATION CABLE BIKE LOCKS

STANDARD SECURITY

3⁺¹
*3 years guarantee
3 años de garantía
Garantie 3 ans



Stanley® Cable Locks are ideal for securing bikes, tool boxes, ladders, and small equipment for short-term lockup in rural areas and suburban areas.

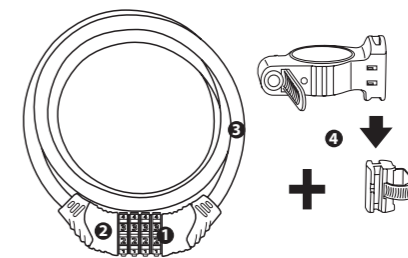

Cable Combination Bike Lock

- ❶ Set Your Own Combination, No Key Needed.
- ❷ Strong Zinc Alloy Lock Body With Reinforced ABS Housing.
- ❸ Flexible Vinyl Coated Steel Cable.
- ❹ Includes Holder That Mounts Almost Anywhere.

Cable Combination Bike Locks	
	Cable Combination Bike Lock 180cm ø10mm
	Cable Combination Bike Lock 90cm ø10mm

For more details please see page 33

FEATURES & APPLICATIONS

- City bike
- Mountain bike
- BMX
- Frost tested -20°C
- Not for use on motorcycles
- Not for use on bicycles with fenders
- Not for use on bicycles with fenders

ASSORTMENT OVERVIEW

CHROME PLATED, STEEL



ALL-WEATHER

Product	Solid Brass Chrome Plated 30mm Std. Shackle	Solid Brass Chrome Plated 40mm Std. Shackle	Solid Brass Chrome Plated 50mm Std. Shackle	Solid Brass Chrome Plated 30mm Long Shackle	Solid Brass Chrome Plated 40mm Long Shackle	Solid Brass Chrome Plated 50mm Long Shackle
VKB-No.	81050 371 401	81051 371 401	81052 371 401	81060 371 401	81061 371 401	81062 371 401
S-No.	S742-011	S742-012	S742-013	S742-015	S742-016	S742-017
Consumer unit	1	1	1	1	1	1
Padlock	Width (mm)	30	40	50	30	40
	Height (mm) total	49	62,4	78	79,1	104
	Depth (mm)	12,8	14	16,6	12,7	14
	Weight (g)	76	134	247	83	155
Blister	Width (mm)	97	97	97	97	147
	Height (mm)	192	192	192	192	192
	Depth (mm)	20	22	25	20	22
	Weight (g)	96	158	277	105	178
Units Innercarton	6	6	6	6	6	6
Units Mastercarton	18	18	18	18	18	18
Keys	3	3	3	3	3	3
Additional Key Information	KeyType: Universal	KeyType: Universal	KeyType: Universal	KeyType: Universal	KeyType: Universal	KeyType: Universal
Body	Solid Brass	Solid Brass	Solid Brass	Solid Brass	Solid Brass	Solid Brass
Shackle	Stainless Steel	Stainless Steel	Stainless Steel	Stainless Steel	Stainless Steel	Stainless Steel
Guarantee	25 + 5 Years	25 + 5 Years	25 + 5 Years	25 + 5 Years	25 + 5 Years	25 + 5 Years
Details	Page 13	Page 13	Page 13	Page 13	Page 13	Page 13
EAN						

ARMORED & BAYONETTE BRASS PADLOCKS



OUTDOOR

Product	Solid Brass Armored 60mm	Solid Brass Armored 80mm	Solid Brass Armored 90mm	Solid Brass Bayonette 50mm	Solid Brass Bayonette 70mm	Solid Brass Bayonette 90mm
VKB-No.	81080 372 401	81081 372 401	81082 372 401	81090 371 401	81091 371 401	81092 371 401
S-No.	S742-022	S742-023	S742-024	S742-025	S742-026	S742-027
Consumer unit	1	1	1	1	1	1
Padlock	Width (mm)	60	80	90	50	70
	Height (mm) total	54,5	68,9	76	38	48
	Depth (mm)	25	29	30	15	17
	Weight (g)	437	796	1.001	181	375
Blister	Width (mm)	147	147	147	97	147
	Height (mm)	192	192	192	192	192
	Depth (mm)	30	37	35	21,5	23
	Weight (g)	486	834	1.059	216	446
Units Innercarton	6	6	6	6	6	6
Units Mastercarton	18	18	18	18	18	18
Keys	3	3	3	3	3	3
Additional Key Information	KeyType: Universal	KeyType: Universal	KeyType: Universal	KeyType: Universal	KeyType: Universal	KeyType: Universal
Body	Solid Brass	Solid Brass	Solid Brass	Solid Brass	Solid Brass	Solid Brass
Shackle	Hardened Steel	Hardened Steel	Hardened Steel	Hardened Steel	Hardened Steel	Hardened Steel
Guarantee	25 + 5 Years	25 + 5 Years	25 + 5 Years	25 + 5 Years	25 + 5 Years	25 + 5 Years
Details	Page 13	Page 13	Page 13	Page 14	Page 14	Page 14
EAN						

ASSORTMENT OVERVIEW

BRASS PADLOCKS



OUTDOOR

Product	Solid Brass 20mm Std. Shackle	Solid Brass 25mm Std. Shackle	Solid Brass 30mm Std. Shackle	Solid Brass 40mm Std. Shackle	Solid Brass 50mm Std. Shackle	Solid Brass 60mm Std. Shackle	Solid Brass 70mm Std. Shackle	2 Solid Brass 30mm Std. Shackle	
VKB-No.	81100 371 401	81101 371 401	81102 371 401	81103 371 401	81104 371 401	81105 371 401	81106 371 401	81102 371 402	
S-No.	S742-028	S742-029	S742-030	S742-031	S742-032	S742-033	S742-034	S742-035	
Consumer unit	1	1	1	1	1	1	1	2	
Padlock	Width (mm)	20	25	30	40	50	60	70	30
	Height (mm) total	35,5	43,5	49,5	62,3	77,7	88,8	101	49,5
	Depth (mm)	10	11,4	12,7	14,3	16,5	18	19,3	12,7
	Weight (g)	28,8	46,5	74,2	132	244	350	519	74,2
Blister	Width (mm)	97	97	97	97	97	147	147	147
	Height (mm)	192	192	192	192	192	192	192	192
	Depth (mm)	22	18	21	23	25	27	25	22
	Weight (g)	57	74	110	170	286	422	585	194
Units Inncarton	6	6	6	6	6	6	6	6	
Units Mastercarton	18	18	18	18	18	18	18	18	
Keys	3	3	3	3	3	3	3	5	
Additional Key Information	KeyType: Universal	KeyType: Universal	KeyType: Universal	KeyType: Universal	KeyType: Universal	KeyType: Universal	KeyType: Universal	KeyType: Universal, keyed alike	
Body	Solid Brass	Solid Brass	Solid Brass	Solid Brass	Solid Brass	Solid Brass	Solid Brass	Solid Brass	
Shackle	Hardened Steel	Hardened Steel	Hardened Steel	Hardened Steel	Hardened Steel	Hardened Steel	Hardened Steel	Hardened Steel	
Guarantee	25 + 5 Years	25 + 5 Years	25 + 5 Years	25 + 5 Years	25 + 5 Years	25 + 5 Years	25 + 5 Years	25 + 5 Years	
Details	Page 15	Page 15	Page 15	Page 15	Page 15	Page 15	Page 15	Page 15	
EAN									

BRASS PADLOCKS



OUTDOOR

Product	2 Solid Brass 40mm Std. Shackle	2 Solid Brass 50mm Std. Shackle	4 Solid Brass 40mm Std. Shackle	4 Solid Brass 50mm Std. Shackle	Solid Brass 20mm long Shackle	Solid Brass 25mm long Shackle	Solid Brass 30mm long Shackle	Solid Brass 40mm long Shackle	Solid Brass 50mm long Shackle	
VKB-No.	81103 371 402	81104 371 402	81103 371 404	81104 371 404	81110 371 401	81111 371 401	81112 371 401	81113 371 401	81114 371 401	
S-No.	S742-036	S742-037	S742-038	S742-039	S742-040	S742-041	S742-042	S742-043	S742-044	
Consumer unit	2	2	4	4	1	1	1	1	1	
Padlock	Width (mm)	40	50	40	50	20	25	30	40	50
	Height (mm) total	62,3	77,7	62,3	77,7	47,2	55,6	66	81,1	124,7
	Depth (mm)	14,3	16,5	14,3	16,5	10,4	11,4	12,7	14,3	17,2
	Weight (g)	132	244	132	244	30	49,5	78,1	142,2	277
Blister	Width (mm)	147	147	147	147	97	97	97	97	147
	Height (mm)	192	192	267	267	192	192	192	192	192
	Depth (mm)	25	26	24	28	21	21	22	23	24
	Weight (g)	336	557	590	1.063	51	80	114	181	349
Units Inncarton	6	6	6	6	6	6	6	6	6	
Units Mastercarton	18	18	18	18	18	18	18	18	18	
Keys	5	5	5	5	3	3	3	3	3	
Additional Key Information	KeyType: Universal, keyed alike	KeyType: Universal, keyed alike	KeyType: Universal, keyed alike	KeyType: Universal, keyed alike	KeyType: Universal	KeyType: Universal	KeyType: Universal	KeyType: Universal	KeyType: Universal	
Body	Solid Brass	Solid Brass	Solid Brass	Solid Brass	Solid Brass	Solid Brass	Solid Brass	Solid Brass	Solid Brass	
Shackle	Hardened Steel	Hardened Steel	Hardened Steel	Hardened Steel	Hardened Steel	Hardened Steel	Hardened Steel	Hardened Steel	Hardened Steel	
Guarantee	25 + 5 Years	25 + 5 Years	25 + 5 Years	25 + 5 Years	25 + 5 Years	25 + 5 Years	25 + 5 Years	25 + 5 Years	25 + 5 Years	
Details	Page 15	Page 15	Page 15	Page 15	Page 15	Page 15	Page 15	Page 15	Page 15	
EAN										

ASSORTMENT OVERVIEW

BARREL BRASS PADLOCKS



OUTDOOR

Product	Barrel Brass 30mm	Barrel Brass 40mm	Barrel Brass 50mm	Barrel Brass 70mm	Barrel Brass 80mm	
VKB-No.	81120 371 401	81121 371 401	81122 371 401	81123 371 401	81124 371 401	
S-No.	S742-045	S742-046	S742-047	S742-048	S742-049	
Consumer unit	1	1	1	1	1	
Padlock	Width (mm)	30	40	50	70	80
	Height (mm) total	35,5	51,9	60,6	78,2	89,9
	Depth (mm)	16,5	21,7	23,6	33,5	30,8
	Weight (g)	59,1	142	213	479	676
Blister	Width (mm)	97	97	97	147	147
	Height (mm)	192	192	192	192	192
	Depth (mm)	22	25	29	32	36
	Weight (g)	87	177	242	527	731
Units Inncarton	6	6	6	6	6	
Units Mastercarton	18	18	18	18	18	
Keys	3	3	3	3	3	
Additional Key Information	KeyType: Universal	KeyType: Universal	KeyType: Universal	KeyType: Universal	KeyType: Universal	
Body	Solid Brass	Solid Brass	Solid Brass	Solid Brass	Solid Brass	
Shackle	Hardened Steel	Hardened Steel	Hardened Steel	Hardened Steel	Hardened Steel	
Guarantee	25 + 5 Years	25 + 5 Years	25 + 5 Years	25 + 5 Years	25 + 5 Years	
Details	Page 14	Page 14	Page 14	Page 14	Page 14	
EAN						

COMBINATION BRASS PADLOCKS



INDOOR

Product	Brass Combination 3 Digit 20mm	Brass Combination 3 Digit 30mm	Brass Combination 4 Digit 30mm	Brass Combination 4 Digit 40mm	
VKB-No.	81130 371 401	81131 371 401	81132 371 401	81133 371 401	
S-No.	S742-050	S742-051	S742-052	S742-053	
Consumer unit	1	1	1	1	
Padlock	Width (mm)	20	30	30	40
	Height (mm) total	54,8	73,4	86,1	86,7
	Depth (mm)	13,5	15,9	15,8	15,8
	Weight (g)	47,8	118,7	177	212
Blister	Width (mm)	97	97	97	97
	Height (mm)	192	192	192	192
	Depth (mm)	18	20	20	22
	Weight (g)	53	124	182	211
Units Inncarton	6	6	6	6	
Units Mastercarton	18	18	18	18	
Keys	-	-	-	-	
Additional Key Information	-	-	-	-	
Body	Solid Brass	Solid Brass	Solid Brass	Solid Brass	
Shackle	Hardened Steel	Hardened Steel	Hardened Steel	Hardened Steel	
Guarantee	25 + 5 Years	25 + 5 Years	25 + 5 Years	25 + 5 Years	
Details	Page 15	Page 15	Page 15	Page 15	
EAN					

ASSORTMENT OVERVIEW

TSA PADLOCKS



TRAVEL PADLOCKS

Product	3 Digit black 30mm Zinc Security Indicator	3 Digit red 30mm Zinc Security Indicator	3 Digit yellow 30mm Zinc Security Indicator	4 Digit black 30mm Zinc	4 Digit red 30mm Zinc	4 Digit yellow 30mm Zinc
VKB-No.	81140 393 401	81141 393 401	81142 393 401	81150 393 401	81151 393 401	81152 393 401
S-No.	S742-054	S742-055	S742-056	S742-057	S742-058	S742-059
Consumer unit	1	1	1	1	1	1
Padlock	Width (mm)	30	30	30	30	30
	Height (mm) total	60,4	60,4	60,4	65,5	65,5
	Depth (mm)	14,1	14,1	14,1	15	15
	Weight (g)	64,7	64,7	64,7	58,7	58,7
Blister	Width (mm)	97	97	97	97	97
	Height (mm)	192	192	192	192	192
	Depth (mm)	20	20	20	22	22
	Weight (g)	87	87	87	81	81
Units Innercarton	6	6	6	6	6	6
Units Mastercarton	36	36	36	36	36	36
Keys	-	-	-	-	-	-
Additional Key Information	-	-	-	-	-	-
Body	Zinc	Zinc	Zinc	Zinc	Zinc	Zinc
Shackle	Steel	Steel	Steel	Steel	Steel	Steel
Guarantee	10 + 5Years	10 + 5Years	10 + 5Years	10 + 5Years	10 + 5Years	10 + 5Years
Details	Page 16	Page 16	Page 16	Page 16	Page 16	Page 16
EAN						

TSA PADLOCKS



TRAVEL PADLOCKS

Product	3 Digit black 20mm Zinc Vinyl Steel Cable	3 Digit yellow 20mm Zinc Vinyl Steel Cable	Combo 2 Keyed Alike, Black/Yellow 20mm Zinc	3 Digit white 30mm Zinc	Keyed Soccer Shaped 30 mm
VKB-No.	81160 393 401	81161 393 401	81181 393 401	81144 393 401	81201 373 401
S-No.	S742-060	S742-061	S742-064	S741-165	S742-067
Consumer unit	1	1	1	1	1
Padlock	Width (mm)	20	20	30	30
	Height (mm) total	83,2	83,2	59,5	45,6
	Depth (mm)	19,2	19,2	14,3	12,15
	Weight (g)	46,4	46,4	94	22,5
Blister	Width (mm)	97	97	97	97
	Height (mm)	192	192	192	192
	Depth (mm)	24	24	21	20
	Weight (g)	70	70	95	45
Units Innercarton	6	6	6	6	5
Units Mastercarton	36	36	36	36	30
Keys	-	-	2	-	2
Additional Key Information	-	-	No Key Copy possible	-	No Key Copy possible
Body	Zinc	Zinc	Zinc	Zinc	Zinc
Shackle	Plastic Coated + Wire	Plastic Coated + Wire	Steel	Steel	Steel
Guarantee	10 + 5Years	10 + 5Years	10 + 5Years	10 + 5Years	10 + 5Years
Details	Page 16	Page 16	Page 16	Page 17	Page 16
EAN					

ASSORTMENT OVERVIEW

BIKE LOCKS



HIGH

MEDIUM

Product	U-Shape Bike Lock ø 14x247	Key Cable Bike Lock ø 12x1800	Key Cable Bike Lock ø 12x900	Combination Cable Bike Lock ø 12x1800	Combination Cable Bike Lock ø 12x900	
VKB-No.	81301 385 111	81310 385 111	81311 385 111	81320 385 111	81321 385 111	
S-No.	S755-201	S755-202	S755-203	S755-204	S755-205	
Consumer unit	1	1	1	1	1	
Padlock	Width (mm)	167	130	175	130	175
	Height (mm) total	247	180	225	180	225
	Depth (mm)	55	65	37	65	37
	Weight (g) *incl. holder	1066	550	339	618	415
	Blister	Width (mm)	167	130	175	130
Height (mm)		247	180	225	180	225
Depth (mm)		55	65	37	65	37
Weight (g)		1.118	602	391	658	455
Units Innercarton	4	4	4	4	4	
Units Mastercarton	8	8	8	8	8	
Keys	3	3	3	-	-	
Additional Key Information	-	-	-	-	-	
Body	-	Strong Zinc Alloy Lock Body with ABS Housing	Strong Zinc Alloy Lock Body with ABS Housing	Strong Zinc Alloy Lock Body with ABS Housing	Strong Zinc Alloy Lock Body with ABS Housing	
Shackle	Hardened Steel	-	-	-	-	
Guarantee	5 + 1Years	3 + 1Years	3 + 1Years	3 + 1Years	3 + 1Years	
Details	Page 20	Page 21	Page 21	Page 21	Page 21	
EAN						

BIKE LOCKS



MEDIUM

STANDARD

Key Cable Reflective Lock ø 12x1200	Key Cable Family Lock ø 12x2400	Key Cable Family Lock ø 10x2400	Key Cable Bike Lock ø 10x900	Key Cable Bike Lock ø 10x1800	Combination Cable Bike Lock ø 10x900	Combination Cable Bike Lock ø 10x1800
81316 385 111	81315 385 111	81314 385 111	81313 385 111	81312 385 111	81323 385 111	81322 385 111
S741-161	S741-163	S741-159	S741-155	S741-157	S741-151	S741-153
1	1	1	1	1	1	1
176	160	130	177	131	177	150
197	345	255	209	160	167	128
55	50	48	38	63	40	63
740	777	477	214	343	199	314
176	160	130	177	131	177	150
197	345	255	209	160	167	128
55	50	48	38	63	40	63
770	804	509	236	358	217	330
4	4	4	4	4	4	4
8	8	8	8	8	8	8
3	3	3	3	3	-	-
-	-	-	-	-	-	-
Strong Zinc Alloy Lock Body with ABS Housing	Strong Zinc Alloy Lock Body with ABS Housing	Strong Zinc Alloy Lock Body with ABS Housing	Strong Zinc Alloy Lock Body with ABS Housing	Strong Zinc Alloy Lock Body with ABS Housing	Strong Zinc Alloy Lock Body with ABS Housing	Strong Zinc Alloy Lock Body with ABS Housing
-	-	-	-	-	-	-
3 + 1Years	3 + 1Years	3 + 1Years	3 + 1Years	3 + 1Years	3 + 1Years	3 + 1Years
Page 22	Page 22	Page 22	Page 23	Page 23	Page 23	Page 23

ASSORTMENT OVERVIEW

SPECIAL LOCKS



SPECIAL LOCKS

Product	3 Digit Love Lock	4 Digit Carabiner Lock, silver	4 Digit Carabiner Lock, black
VKB-No.	81200 373 401	81204 396 401	81203 396 401
S-No.	S742-065	S744-031	S744-030
Consumer unit	1	1	1
Padlock	Width (mm)	30	87
	Height (mm) total	64,3	52,5
	Depth (mm)	9,9	3,8
	Weight (g)	55,2	83
	Width (mm)	97	97
Blister	Height (mm)	192	192
	Depth (mm)	17	29
	Weight (g)	80	107
	Units Innercarton	6	6
Units Mastercarton	36	18	
Keys	-	-	
Additional Key Information	-	-	
Body	Zinc	Zinc	
Shackle	Steel	Steel	
Guarantee	-	3+1Years	
Details	Page 17	Page 19	
EAN			

OUR PADLOCK FEATURES

STANLEY® PADLOCKS

	Solid Brass Chrome Plated						
	Solid Brass Armored						
	Solid Brass Bayonette						
	Solid Brass						
	Barrel Brass						
	Brass Combination						

STANLEY® TSA

	TSA Padlock							
--	-------------	--	--	--	--	--	--	--

TSA: the international standard for Travel Security
 TSA Approved locks: can be opened and re-locked with a special key by international security administration at every airport

OUR BIKE LOCK FEATURES

	High Security U-Shape Lock						
	Key Cable Bike Lock						
	Combination Cable Bike Lock						
	Key Cable Family Lock						
	Key Cable Reflective Lock						
	Key Cable Bike Lock						
	Combination Cable Bike Lock						
	Key Cable Family Lock						

GOOD TO KNOW



DOUBLE LOCKING SHACKLE

Internal locking mechanism engages both side of shackle providing higher security compared to single locking mechanism.



CHROME PLATED

This padlock has an outer layer of chrome which increases the hardness of the padlock and provides higher corrosion resistance for salty or caustic environments.



DUAL BALL BEARING

Stainless Steel ball-bearing mechanism which holds the shackle firmly in place and adds maximum protection against pry attacks.



ANTI PICK PIN

The anti pick pin has a special mushroom shape which makes it harder to pick and prevents the cylinder from being operated without a key.



SOLID BRASS BODY

The brass body provides protection for the internal mechanism of the lock. Brass is also a metal alloy with high corrosion resistance.



NO KEY REMOVAL

Key can be removed in closed position. Prevents accidentally locking the key inside or losing keys.



SHROUDED BODY

The padlock shackle is covered providing maximum protection against cutting and pry attacks. It prevents the use of traditional bolt cutters.



PROTECTION AGAINST DRILLING ATTACKS

A special disc rotates when the padlock cylinder is attacked by a drill. The drill turns loose and cannot penetrate the cylinder.



FROST TESTED

Frost tested Bike Locks are tested to 20 degrees celsius to ensure that the products can withstand extreme temperatures.



CUT RESISTANCE

Cable / shackle with good cut resistance.



SAWING RESISTANCE

Cable / shackle with good saw resistance.

WEBPAGE WITH PRODUCT FINDER



HOW TO CHOOSE A PADLOCK?

Use our padlock finder to find the right padlock for your application.

Just enter whether you prefer a padlock with a key or a combination padlock and what you want to secure with it. For example, do you want to secure your bag when travelling? Then a TSA Padlock is the right one for you. Or do you need a padlock for your chain? Then a Barrel Brass Padlock is the one you should use.

The padlock finder will provide you with padlock options according to your needs – even for bike locks.

PADLOCKS CERTIFICATION

Stanley key operated padlocks are internally tested and measured against the standards of several different certification institutions, including the Australian Standard (AS), American Standard for Testing and Materials (ASTM), and British Standard European Norm (BS EN) testing standards. Our goal is to be transparent with all of our quality and security claims, helping you choose the right products for all of your security needs



Intertek Certification

Our key operated padlocks are also tested by an independent third party lab, Intertek, an industry leader in assurance, testing, inspection and certification services, under the Australian Standard. The Intertek certification grades drive the security level claims on our packaging, and the testing certificates are available on www.safeguard-lock.com



SBSC Certification

SBSC is an accredited Swedish certification institute that certifies products in the fields of fire protection and crime prevention. Their unique expertise contributes to maintaining a high level of quality in the products that they test and certify. These tests cover durability, corrosion resistance and security features, and products that receive this certification will include the SBSC logo on the packaging.

KEYED ALIKE

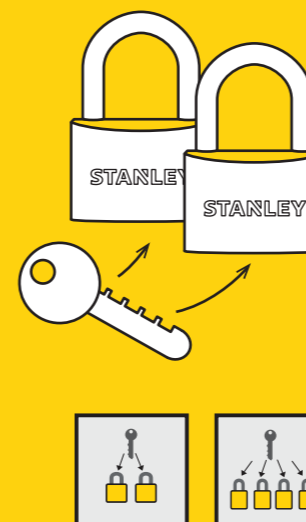

Keyed alike = one key fits all!

All multipacks are „keyed alike“ – this means that you can open all padlocks in the packaging with the same key. All multipacks come with 5 keys.

FAQS: 5 QUESTIONS TO FIND THE RIGHT PADLOCK

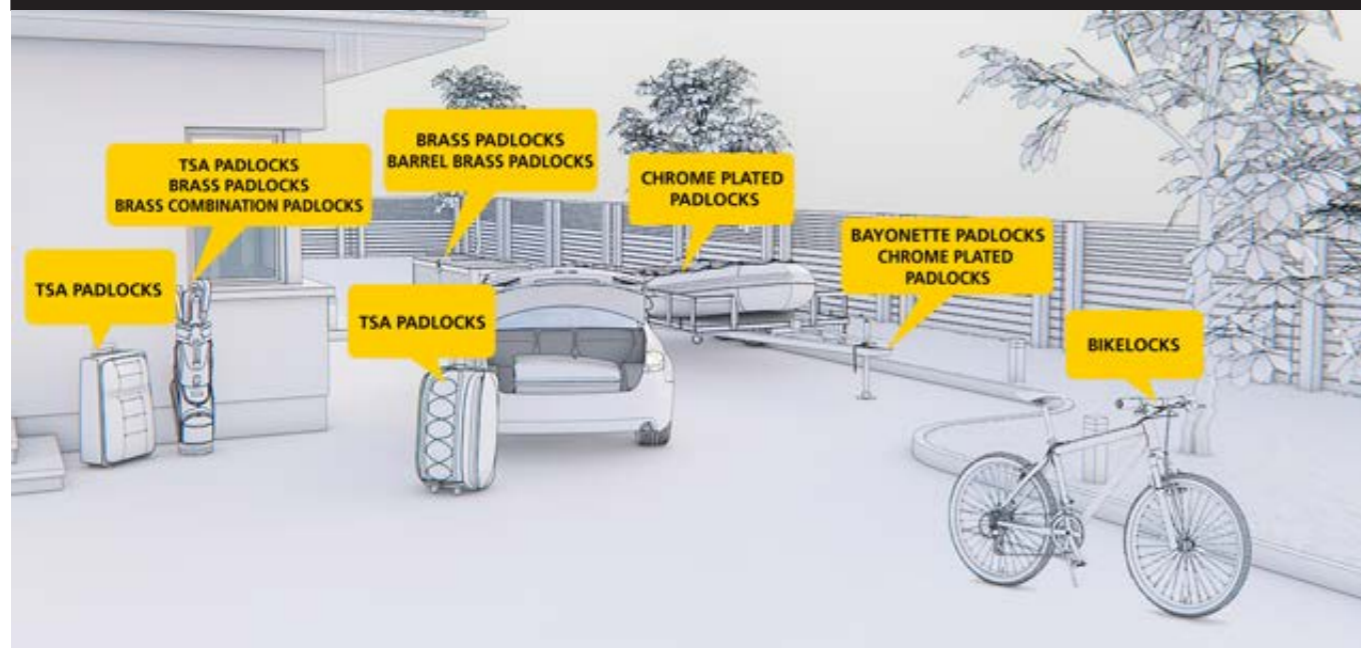

1 WHICH ITEM DO YOU WANT TO SECURE AND HOW VALUABLE IS IT?

- If the item is not so valuable you can use a padlock with a lower security level.
- If the item is valuable you should buy a padlock with a higher security level.

2 FOR WHICH APPLICATION DO YOU NEED THE PADLOCK?

- Define the usage of your padlock – indoor, outdoor or travel-high security or low security.
- Check if the padlock chosen matches the required performance of the padlock.
- Please notice that size alone is not the only indicator to choose the right padlock, it needs to have the right security level to match its purpose.
- Check to make sure the shackle will fit into the item you would like to secure.

3 ARE THERE SPECIAL REQUIREMENTS CONCERNING THE LOCK SYSTEM/ MECHANISM?

- If you need more padlocks that can be locked and unlocked with a single key, you should use „Keyed Alike“ padlocks.
- If many people would like to share one padlock, you can use a combination padlock. The advantage is that you do not need many keys for lots of people. Please notice that combination padlocks are suitable for applications with a lower security level.

4 WHAT IS THE RIGHT PADLOCK AND SHACKLE SIZE?

- The padlock should be the appropriate size for the required usage.
- Check additional padlock features like shackle size, diameter & material, body material & finish and to match the surrounding components and area.
- Short or long shackle size? The shackle size depends on the usage of the padlock. To pass through hasps and fittings with a long distance, a long shackle is required.
- Additionally the diameter and material of the shackle are further points to take into consideration for better security. Please pay attention to the shackle diameter and that it fits into the desired hole for locking.

5 WHAT TYPE OF BODY SHOULD I CHOOSE?

- The purpose of the padlock body is to protect the lock system against attacks.
- The main body types are Solid Brass, Laminated Steel and Armored Encased Brass.
- Solid Brass: Brass is a softer material that is easy for manufacturers to machine resulting in lower prices for customers, but brass padlocks are more susceptible to drill attacks than padlocks made of harder materials. Brass Padlocks typically have sharp corners which can scratch some surfaces.
- Laminated Steel: The body of this type is designed from separate thin steel plates which are riveted together. Low production costs enable low prices for customers.
- Armored Encased Brass: The brass body is encased in hardened steel for better protection against drilling attacks and to achieve a higher security level.

FAQS: PADLOCKS



KEY PADLOCKS

WHAT CAN I DO IF I HAVE LOST ALL KEYS FOR MY PADLOCK?

If you have lost all keys for your padlock it is not possible to make key copies to unlock the padlock.

ARE KEY COPIES POSSIBLE?

Yes. You can generate copies of your existing key in locksmith or security shops.

IS THERE A POSSIBILITY TO GET AN ADDITIONAL NEW PADLOCK THAT WORKS WITH MY ALREADY EXISTING KEY?

No. If you want to operate more padlocks with a single key, please purchase multiple pack „Keyed Alike“ padlocks.

IS THERE AN OPTION TO HAVE PADLOCKS THAT ARE OPERABLE WITH A SINGLE KEY?

Yes. Please purchase multiple pack „Keyed Alike“ padlocks that can be locked and unlocked with a single key.

WHAT DOES „KEYED ALIKE“ MEAN?

„Keyed Alike“ means that you can lock and unlock several padlocks with a single key.

COMBINATION PADLOCKS

ARE COMBINATION PADLOCKS SAFER THAN KEY PADLOCKS?

No. For a higher security you should use a key padlock, because the lock mechanism is stronger.

TRAVEL PADLOCKS



WHICH PADLOCK SHOULD I USE FOR TRAVELING?

For traveling you should use a TSA (Travel Sentry Approved) padlock. If you use a padlock that is not Travel Sentry Approved, you are taking a chance that the airport security will destroy the lock during their security check.

WHAT IS THE MEANING OF TSA?

TSA (Travel Sentry Approved) is the international standard for Travel Security. TSA (Travel Sentry

Approved) padlocks can be opened and re-locked with a special key by international security administration at every airport.

IS THERE A CHANCE THAT „NON AIRPORT SECURITY PEOPLE“ CAN GET THE „GENERAL KEY“ FOR TSA LOCKS?

No. Only airport security people have access to the general key to open and re-lock the TSA (Travel Sentry Approved) padlocks.

101 Facts | Bike locks

No **47**



Every **5 minutes** a bike is stolen in Europe.

<http://www.welovecycling.com/wide/2015/11/25/european-bike-thefting-champions-tips-in-number/>

101 Facts | Padlocks

Questions to find the right padlock

No **25**



What type of body should I choose?
The purpose of the padlock body is to protect the lock system against attacks. The main body types are Solid Brass, Laminated Steel, and Armored Encased Brass.
Solid Brass: Brass is a soft metal that is easy for producers to machine, thereby giving it a lower price for customers. But these padlocks are susceptible to drill attacks and usually have sharp corners which can scratch surfaces and objects they touch.
Laminated Steel: The body of this type is designed from separate thin steel plates which are riveted together. Low production costs enable low prices for the customers.
Armored Encased Brass: The brass body is encased in hardened steel for better protection against drilling attacks, thereby giving it a higher security level.

<http://www.safeguard-locks.com/en/service.aspx>

101 Facts | Bike locks

The number of cars and Bikes in Germany

No **60**

45,1 MLN

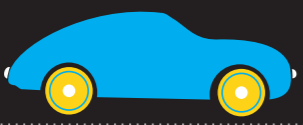

72 MLN



[http://www.vf.de/press/pressemitteilungen/detail/news/fahradwirtschaft-auf-den-ueberholkurs?tx_news_pi1\[controller\]=News&tx_news_pi1\[action\]=detail&tx_news_pi1\[controller\]=News&tx_news_pi1\[action\]=detail](http://www.vf.de/press/pressemitteilungen/detail/news/fahradwirtschaft-auf-den-ueberholkurs?tx_news_pi1[controller]=News&tx_news_pi1[action]=detail&tx_news_pi1[controller]=News&tx_news_pi1[action]=detail&tx_news_pi1[controller]=News&tx_news_pi1[action]=detail)
<http://de.statista.com/statistik/daten/tabelle/54198/umfrage/fahradbesitz-in-deutschland/>

101 Facts | Bike locks

Security tips

No **68**

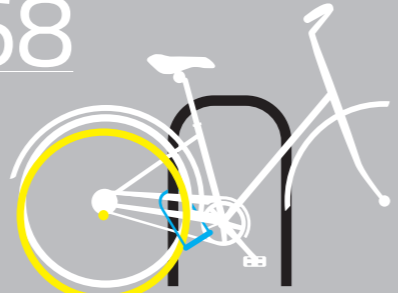

When securing your bike for longer periods of time, use the quick release function to remove the front tire and lock it together with the frame and the back tire, securing both to a fixed object such as street light or secure fence.

<http://www.safeguard-locks.com/en/security-moments/Bike%20locks.aspx>

101 Facts | Fun facts

Love locks

No **6**



Love Locks symbolize everlasting love and are attached to bridges, fences, gates, etc. The key is thrown into the river as a romantic gesture.

<http://www.historykeys.com/padlocks-history/history-of-love-padlocks/>

101 Facts | Bike locks

DID YOU KNOW...

Your Insurance will **not pay** for your loss if you did not secure your bike, home, or fence with a lock, or if the lock was too weak for the value of the possessions.

For example: A bike lock should cost about 10% of the value of your bike

So if your bike is about \$1 000, the lock should be around \$100

<http://die-hausratversicherung.eu/de/stahl-rauf/>
<http://www.fahradchloe-tests.com/>

REMEMBER!



WHILE IT'S NOT ALWAYS AN INDICATOR ON QUALITY, IN THE SECURITY WORLD, YOU GET WHAT YOU PAY FOR. A CHEAP LOCK WILL OFFER LITTLE RESISTANCE TO A THIEF.

THERE IS NO LOCK THAT CANNOT BE BROKEN. THE ONLY THING YOU CAN BUY IS THE TIME THAT IS NEEDED TO BREAK THE LOCK.



VIDEOS: STANLEY IN MOTION



LOYALTY 10 STANLEY S.W.

Check the instructions. It shows how to join two bolts to make your bike practically theft proof.

That was 5.5% more than in 2013!

BRAND STRENGTHENING – HISTORY VIDEO

- Supports Sales argumentation
- Shows Stanley as an expert & experienced brand
- Build up trust in brand
- Trend for innovations
- Sponsorships Stanley
- Implemented on Stanley webpage in English

GENERAL TSA APPROVED PADLOCKS VIDEO

- Supports Sales argumentation
- Helps consumer to find right TSA approved padlock
- Interesting Facts about travel security, travel suggestions and Stanley TSA approved padlocks
- Implemented on Stanley webpage in English

HOW TO USE VIDEO FOR EVERY BIKE LOCK

- Supports Sales argumentation
- Helps consumer to find right TSA approved padlock
- Interesting Facts about travel security, travel suggestions and Stanley TSA approved padlocks
- Implemented on Stanley webpage in English

PADLOCK CARE AND MAINTENANCE



Normally padlocks & bike locks need minimal care. For combination padlocks and bike locks there is no special maintenance required. To care for outdoor padlocks and key operated bike locks, lubricate the cylinder once or twice a year.

BIKE LOCK SECURITY TIPS

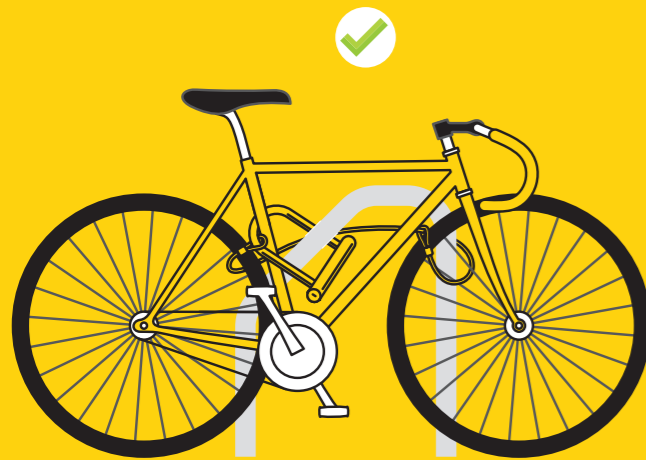

LOCK YOUR BIKE TO A FIXED OBJECT such as streetlight or secure fence. To make sure the lock is secured properly, pull your bike away from the lock to create a small amount of pressure.

THE BIKE LOCK SHOULD NOT TOUCH THE GROUND, so thieves cannot benefit from creating leverage to break the lock.

CHOOSE BUSY STORAGE LOCATIONS with high visibility, where thieves are less likely to operate.

ENSURE BOTH YOUR TIRE AND FRAME are securely locked.



IT IS BEST TO USE A TWO-LOCK METHOD, such as a U-Lock & Cable Lock, to maximize security when locking your bike.

WHEN SECURING YOUR BIKE FOR LONGER PERIODS OF TIME, use the quick release function to remove the front tire, and lock it together with the frame and the back tyre to a secure fixed object such as street light or secure fence.

THE LATEST TRICK OF THIEVES is to fill the keyhole of your Bike Lock with super glue, so you can't open it but they can come back later to steal your bike. So when locking your Bike Lock, make sure to fix it with the keyhole faced down.

HIGH SALES IN EVERY SEASON

Our recommendation: **STANLEY® calendar 2021.**
For covering all sales opportunities.

START INTO THE YEAR



JANUARY - MARCH

- CW 01 🏋️ New Years Resolutions at the Gym
- CW 02
- CW 03
- CW 04
- CW 05
- CW 06 💕 Valentines Day
- CW 07
- CW 08
- CW 09
- CW 10
- CW 11
- CW 12
- CW 13
- CW 14

FOR TRAVELLING AND OUTDOOR



JULY - SEPTEMBER

- CW 28
- CW 29
- CW 30
- CW 31
- CW 32
- CW 33
- CW 34
- CW 35 🌴 Holiday & Outdoor Season
- CW 36
- CW 37
- CW 38
- CW 39
- CW 40

BIKE & BOAT SEASON



APRIL - JUNE

- CW 15 🚲 Bike Season Start
- CW 16
- CW 17
- CW 18
- CW 19
- CW 20
- CW 21
- CW 22
- CW 23
- CW 24
- CW 25
- CW 26 🚤 Boat Season
- CW 27

MAKE SURE YOUR VALUABLES ARE WINTERPROOF



OCTOBER - DECEMBER

- CW 41 🗝️ Standard Padlocks
- CW 42
- CW 43
- CW 44
- CW 45
- CW 46
- CW 47
- CW 48
- CW 49
- CW 50
- CW 51
- CW 52

STANLEY®

"Stanley and the Stanley Logo are trademarks of Stanley Black & Decker, Inc. or an affiliate thereof and are used under license"

©2021 CJP Marketing Pte Ltd.

<http://www.safeguard-locks.com>

EU, MEA: CJP Europe B.V., Kingsfordweg 151, 1043 GR Amsterdam, www.safeguard-locks.com, contact@cjpl.com

Asia: CJP Marketing Pte Ltd, 2 Gambas crescent #09-14, Nordcom II, Singapore 757044, www.cjpl.com, contact@cjpl.com