

ALL METAL STAMPING, INC.

411 WEST SPRUCE, P.O. BOX 485, ABBOTSFORD, WI. 54405
PHONE: 715-223-6324 FAX: 715-223-3352
EMAIL: AllMetal@AllMetalStamping.com

Machining Templates for Edge & Astragal Sets

Included is a new set of Machining Templates dated 8/15/03 for our Edge & Astragal Sets, T-Astragals, Lock and Hinge Edge Protectors and Dutch Door Edge & Astragal Sets. Please destroy all old versions and use these new templates ONLY. Keep this set as your originals and make copies as needed.

The new templates combine several different Edge & Astragal Sets onto one template. There are now only five (5) template sets which make up the twelve (12) standard Edge & Astragal Sets we manufacture. Each set has two (2) templates, a LH/RHR template and a RH/LHR template. The following steps can be used to select and complete the correct template.

1. Determine if your pair of doors are Parallel Beveled. Most Double Egress openings use Parallel Beveled doors. If this is not the case go to ITEM #2. If this is true:
Determine whether the Lock or Strike is on the leaf with the Astragal Lip. If the Strike is on the Astragal Leaf select the templates for the #209/#225 Set otherwise select the templates for the #209A/#225A Set which have the Lock on the Astragal Leaf. Proceed to ITEM #4.
2. If your opening does NOT require the use of an Astragal Lip select the template set for the Styles #208/#223/#224 and proceed to ITEM #4, otherwise go to ITEM #3.
3. If the Astragal Lip should be located on the hinge side of the doors.
Select the template set for the Styles #211/#217A/#218/#226.
otherwise
You require the template set for the Styles #207/#212/#217/#219.
Proceed to ITEM #4.
4. At this point you now have only two (2) templates to choose from, either the LH/RHR template or the RH/LHR template. To determine the correct handing study the overhead door swing views on each template and circle the correct door movement. You have now selected the correct template.
5. If you are familiar with our Style numbers, check the box at the top of the form for the set you require. We included a chart on Page 4 showing the various Styles, refer to this Chart to help you select the correct Style number. If you are still not sure which is the correct Style number each template has Check Boxes next to each leaf for indicating if that leaf is square rather than Beveled. From this information we can determine the correct Style number.

6. Each template now has two (2) Strikes and two (2) Locks for your convenience. The top Strike and Lock should ONLY be used if you have two Strikes and Locks. Check the boxes for the correct Lock and Strike Punchouts or check the template box and provide a detail sheet with your Order. Complete the dimensions for the Strike and Lock in the boxes provided. Remember these dimensions are from the top of the door down to the Center Line of the Punchout. Please double check the offset between the Strike and Lock. That is the most common error we find on templates.
7. If you require Flushbolts select the correct Flushbolt from the Table or check the Other Box and provide a detail sheet with your Order. Complete the boxes for the Top and Bottom flushbolts as needed. If your flushbolt has a 12", 24", etc. rod we need the dimension from the bottom or top of the channel to the Center Line of the punchout. For any other flushbolt we need the dimension from the bottom or top of the channel to the end of the punchout.

EXAMPLE: An Automatic Flushbolt that has a 1" x 9" plate will usually have a dimension from the top or bottom of the channel to the end of the punchout of 9". That is the dimension we require. Sometimes this dimension will vary dependent on the placement of the flushbolt in the door or if it is a retrofit application. A Manual Flushbolt that has a 1" x 6-3/4" plate and a 12" rod will usually have a dimension of 12" from the top or bottom of the channel to the Center Line of the punchout. In this case we are looking for the 12" dimension.

Record the dimension in each box that applies. Next, put an arrow point at the Center Line or at the end of the punchout to indicate that your dimension is from the top or bottom of the channel to that point.

8. Make sure you complete the OVERALL LENGTH box.

9. **OTHER SELECTIONS:**

FINISH: Beige Powder Paint is our standard finish. We also offer a Gray and Dark Bronze Powder Paint as standard finishes. You can also request a Special Color. Special Colors are either powder paint or air dried lacquer dependent on color. You must provide a Color Chip with your Order when requesting a Special Color. If you check the veneer box you must indicate the species and slice in the space provided. Please be advised that we are limited to the species and slice our supplier can provide. If you select NO PAINT you must select Galvanized or Stainless Steel material. We will not be responsible for Cold Roll Steel Channels with No Paint.

DOOR SIZE: At the top of the Dimension area you can mark the Door Size. If NOT marked we assume the Door to be 1-3/4". Be sure you know your actual door thickness. Many doors are sold as 1-3/4" Doors but will actually measure 1-13/16" or more. Our channels are designed to fit very tightly so they do not rattle as the years pass. Our channels will not fit a door that measures over 1-3/4". If you suspect your doors may be heavy have the channels manufactured for 1-13/16" or more. The cost is nominal when compared to replacing them in the field.

SPECIAL MATERIAL: We have provided an area to specify if the channel set is to be made of Special Material. If you require special material mark the correct material selection and include the Gage of the edge material required. 20 Gage is standard for channels, however 18 Gage and 16 Gage material is available. Astragals are 16 Gage unless you request a special gage.

LEAD LINED ASTRAGALS: Where applicable we have included a section for Lead Lined Astragals. If you are ordering a Lead Lined Astragal check the box, give us the desired lip width. If not specified the lip width will be 1-3/4". Also you can choose between 1/16" or 1/8" lead. If not specified 1/16" lead is standard.

NOTCHED ASTRAGAL LIPS: On sets where the lock is located on the channel with the Astragal Lip we have included a Check Box for you to indicate you want the Astragal Lip notched so the Strike Lip on the opposite door can pass through without interference. This is an option, standard practice is to cut the strike lip off. The size and placement of the notch is determined by the size and CL of the Strike Lip. If you are ordering a complete set we know the size and placement from the Strike detail. In this case if you want the Astragal lip notched you only need to check the box provided. If you are only ordering the Astragal leaf ONLY then we need to know the size of the Strike Lip (3-3/8", 1-1/2", etc.) and the CL of the Strike. In this case check the box for NOTCHED LIP and provide the Strike Lip Length in the space provided and put the CL dimension for the Strike in the Strike CL Box.

Please NOTE:

A Lead Lined
Astragal flange
cannot be notched.

OTHER TEMPLATES: We have included templates for Ordering T-Astragals, Lock and Hinge Edge Protectors in either full "U" channels or in "L" channels. We also included some special templates for Spring Bolts and Panic Hardware Devices. Included also are templates for Edge and Astragal Sets for Dutch Doors.

10. Complete the information section of the form and submit it with your purchase order and any other detail sheets. Please do not send us a Purchase Order for machined Edge and Astragals without a completed Machining Template. We cannot process your Order until we receive the completed template.

We hope this information will be helpful. If you have any questions or require assistance in completing these forms please call and ask for Customer Service.

Thank You for your business.

UL LISTED EDGE & ASTRAGAL SETS

EDGE & ASTRAGAL SETS ARE LISTED TO 90 MIN. UL.
 DOUBLE EDGE SETS ARE LISTED TO 90 MIN. UL.
 Listed under both Negative & Positive Pressure Standards.
 UL Listed in Steel and Stainless Steel.
 UL Listed with Veneer Wrapping - Negative & Positive Pressure.

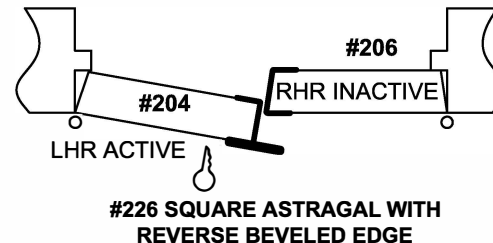
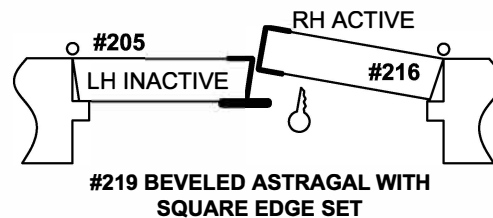
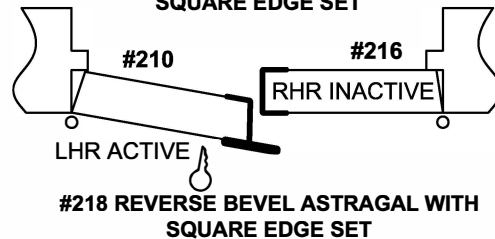
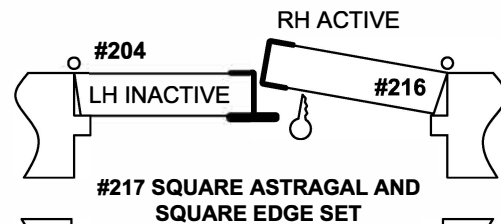
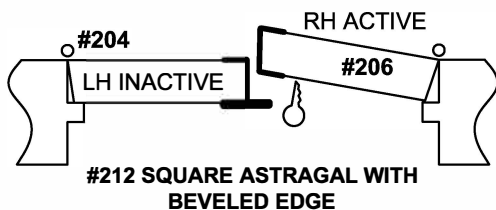
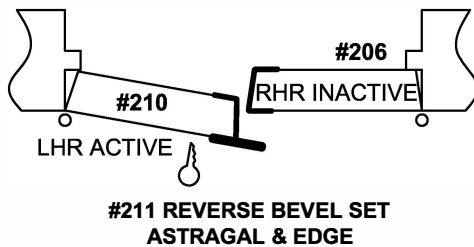
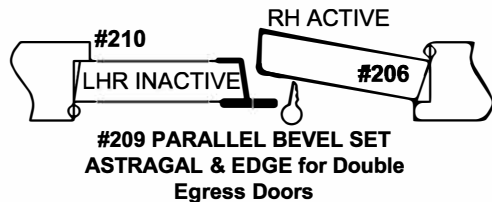
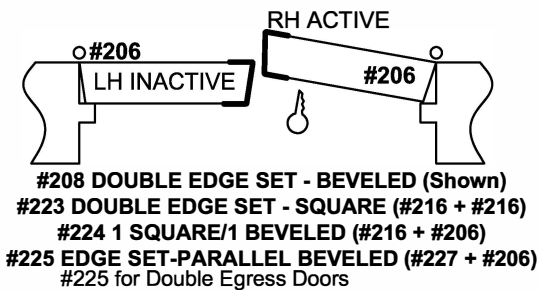
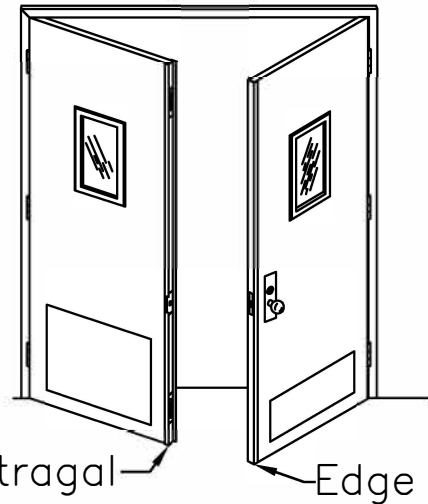

OTHER ITEMS

- * LEAD LINED ASTRAGALS.
- * DUTCH DOOR and TRANSOM CHANNELS. #222
- * DUTCH DOOR SHELVES.
- * "T", "Z", and FLAT ASTRAGALS.
- * HINGE EDGE and LOCK EDGE PROTECTORS.
- * ALUMINUM DOOR FLASHINGS.

- * Standard finish is beige powder paint.
- * All bevels are $\frac{1}{8}$ " in 2".
- * Punched and coined for #8 X $\frac{3}{4}$ " Phillips Flat Head Screws (included).
- * Hole Centers 12" or less, $3\frac{1}{2}$ " Max. from ends and machined openings.
- * AMS Machining Templates must be completed for each machined item (forms available on website).
- * All items available in Stainless Steel.

ALL METAL STAMPING, INC.

715-223-6324

411 W. Spruce Street, P.O. Box 485

FAX: 715-223-3352

Abbotsford, WI. 54405-0485

EDGE & ASTRAGAL SPECIFICATIONS

Standard Edges are 20 GA. (.035) CRS

Astragal Flanges are 16 GA. (.062) CRS

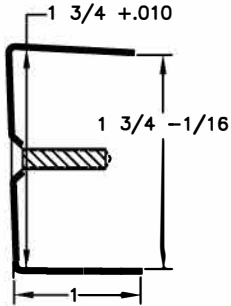

#206 Beveled Edge (shown)

#216 Square Edge (No Bevel)

#227 Beveled Edge Machined w/Strike open to low side of bevel.

#231 "L" Shaped Lock Edge Protector - Beveled

#233 "L" Shaped Lock Edge Protector - Square

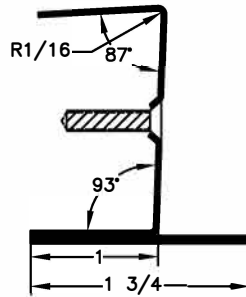

#205 Std. Beveled Astragal

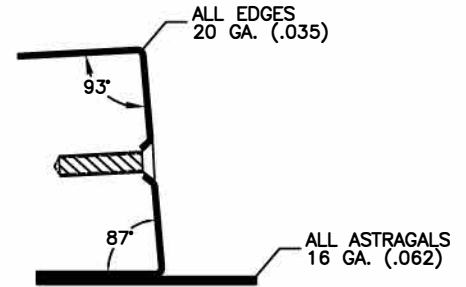

#210 Reverse Beveled Astragal
#204 Square Astragal (No Bevel)

"T", "Z" & Flat Astragals No Fire Ratings

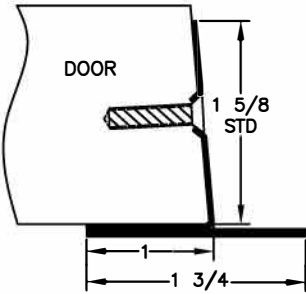

18 GA. (.048) CRS Edge/16 GA. (.062) Astragal

#229 "T" Astragal - Reverse Bevel (shown)

#213 "T" Astragal - Beveled

#214 "T" Astragal - Square

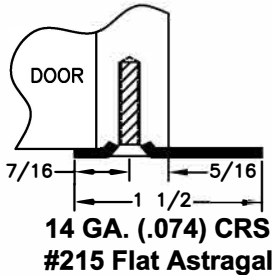

14 GA. (.074) CRS
#215 Flat Astragal

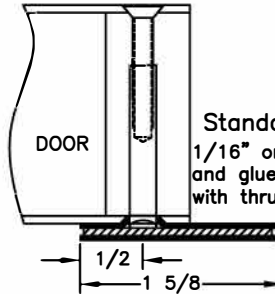

18 GA. (.048) CRS Std.

#236 Lead Lined
Flat Astragal
(No Fire Ratings)

Lead Lined Astragals

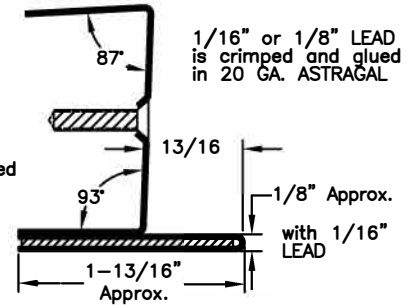

Lead Lined Astragal #205L Std. Bevel (shown)

Lead Lined Astragal #204L Square (No Bevel)

Lead Lined Astragal #210L Reverse Bevel UL

Listed to 60 Minutes

Listings apply to Astragal & Edge Sets ONLY

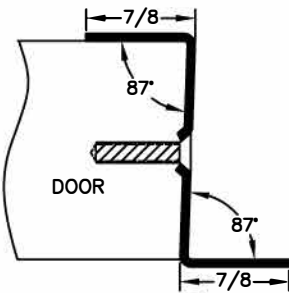

16 GA. (.062) CRS Standard

#238 "Z" Astragal - Beveled (shown)

#239 "Z" Astragal - Reverse Bevel

#237 "Z" Astragal - Square

Punchouts For
4 1/2" or 5" Hinge
Standard

Hinge Edge Protectors

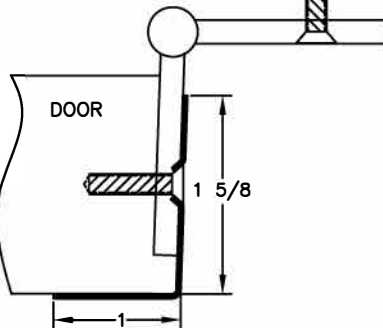

#232 "L" Shaped - Beveled

#235 "L" Shaped - Square

Available in:
20 GA. CRS Painted
20 GA. or 18 GA. SS

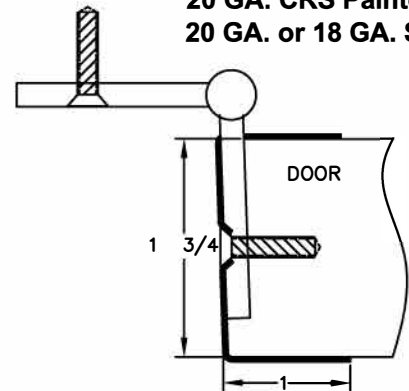

#230 "U" Shaped - Beveled

#234 "U" Shaped - Square

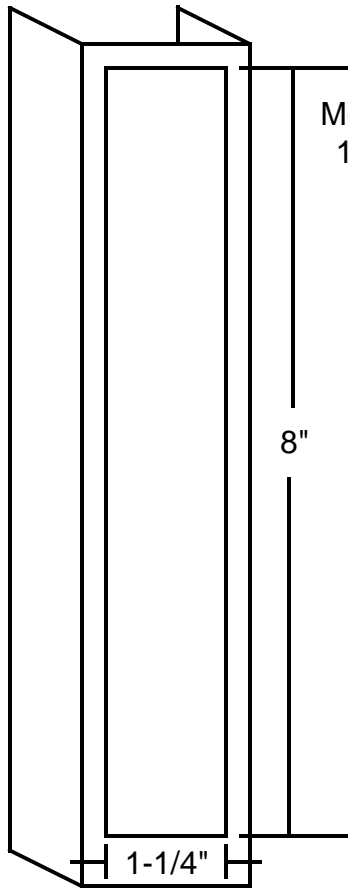

Mortise Lock
1-1/4" X 8"

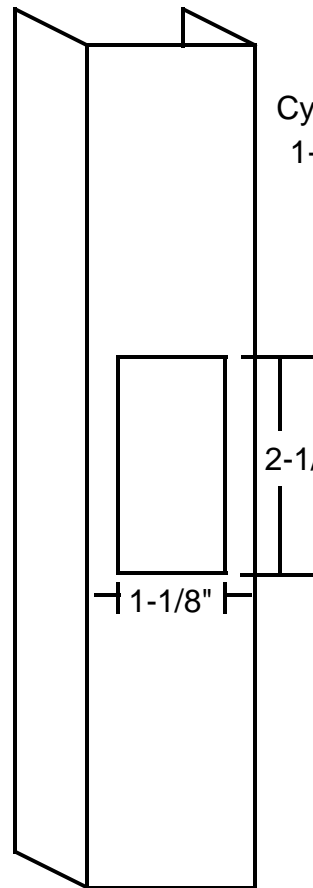

Cylindrical Lock
1-1/8" X 2-1/4"

Standard Locks

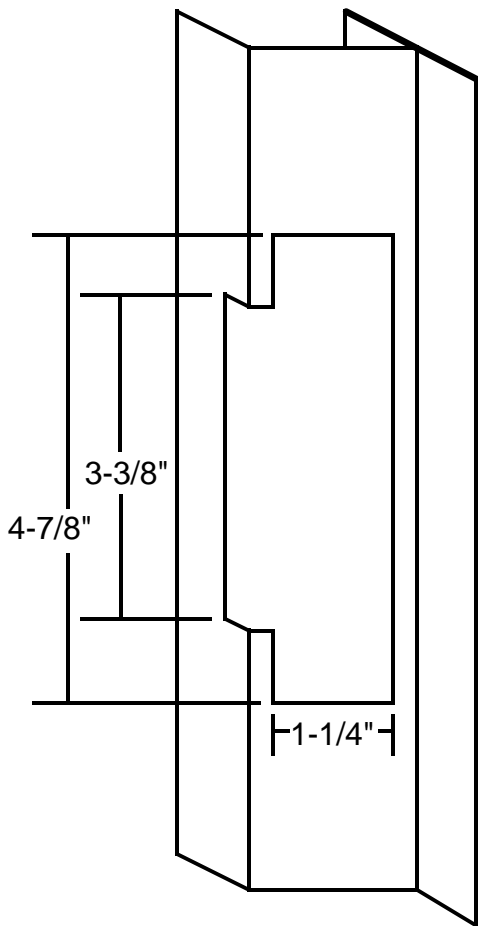

ASA Strike
4-7/8" X 1-1/4"
w/ 3-3/8" Lip

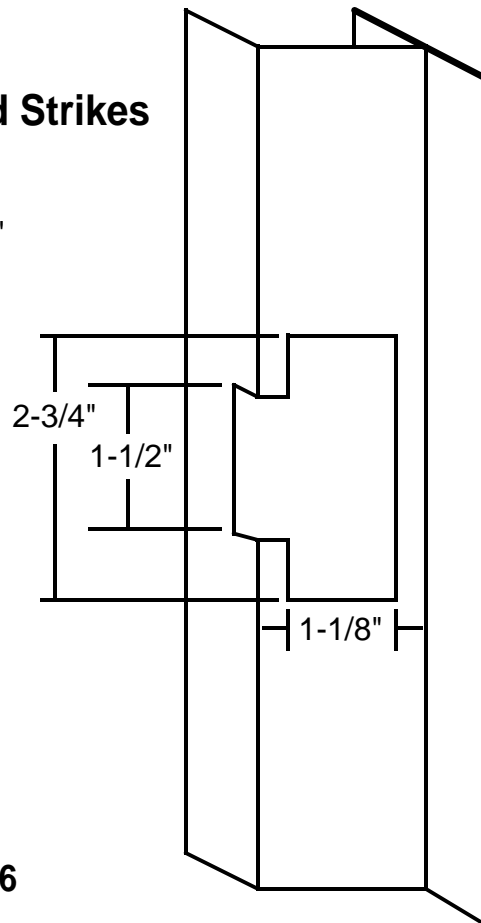

T-Strike
2-3/4" X 1-1/8"
w/ 1-1/2" Lip

Standard Strikes

STANDARD FLUSHBOLTS

ALL METAL STAMPING, INC.
 411 W. SPRUCE ST.
 ABBOTSFORD, WI. 54405

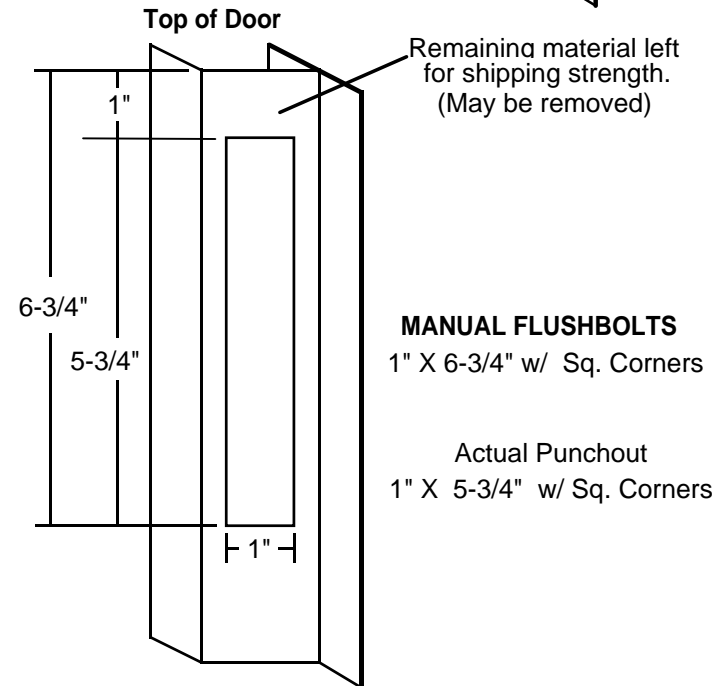
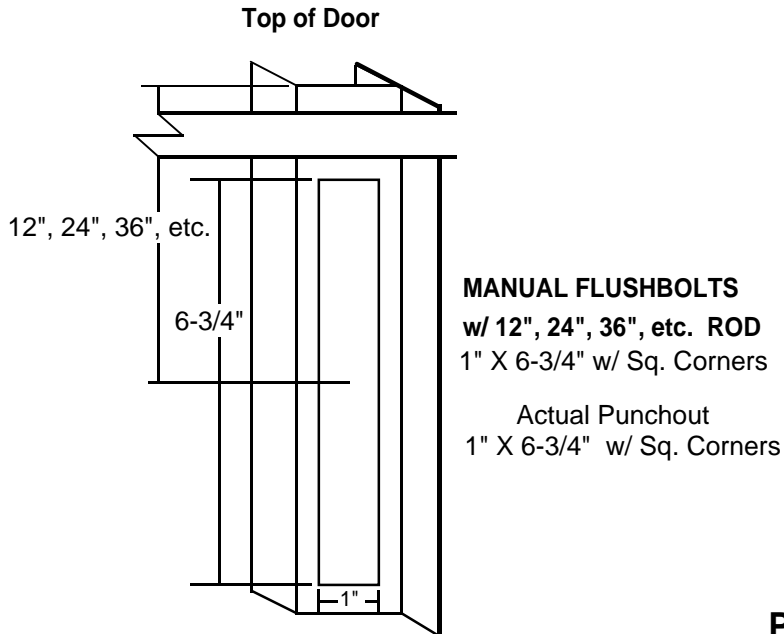
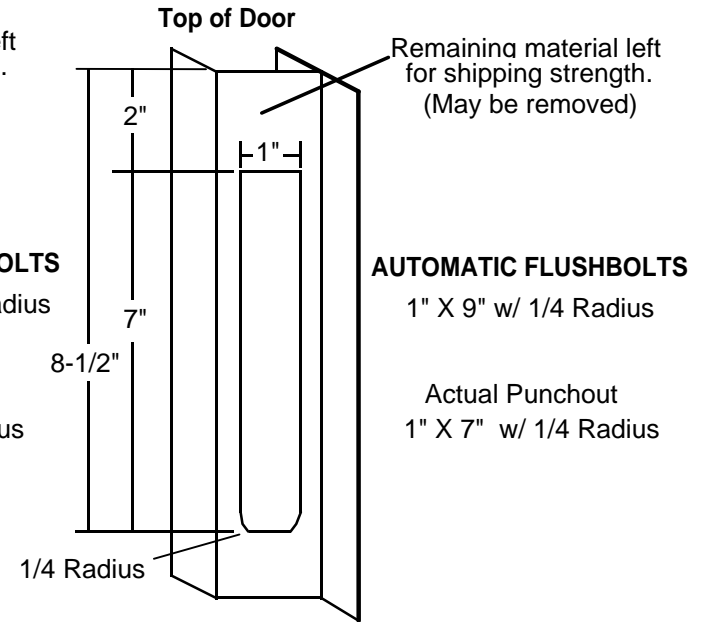
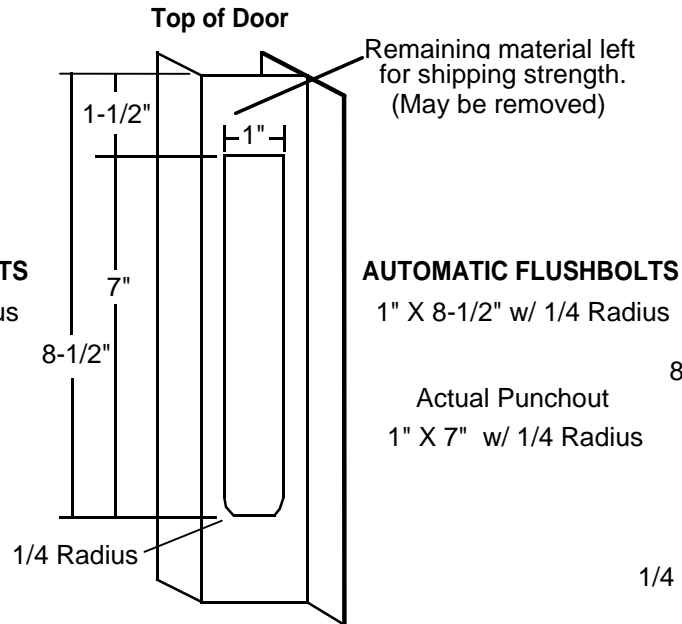
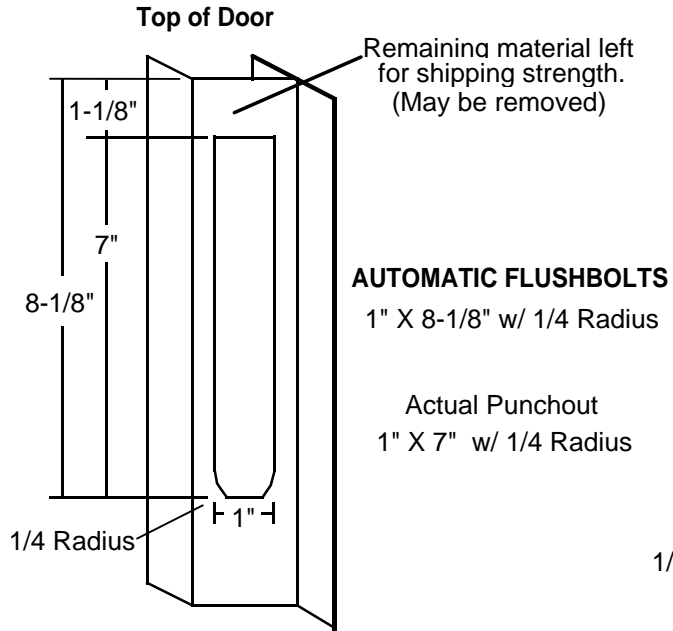



Please Check One: 207 212 217 219 LH/RHR ACTIVE

CUSTOMER: _____ DOOR #: _____

P.O.: _____ DATE: _____

M.O.: _____

ACCESSORY ITEM #: _____ DOOR ITEM: _____

NO. of SETS REQ.: _____ DATE REQ.: _____ DRAWN BY: _____ DATE: _____

STD. BEIGE SPECIAL COLOR: _____ NO PAINT VENEER: _____

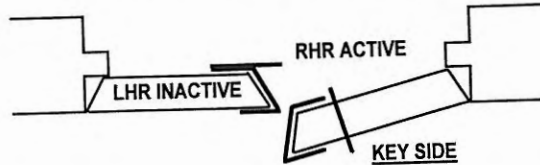

LEAD LINED ASTRAGAL
 LIP WIDTH: _____
 1/16" LEAD 1/8" LEAD

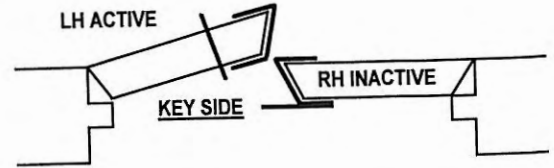

ALL DIMENSIONS ARE FROM TOP OF DOOR.

INACTIVE DOOR

ACTIVE DOOR

DOOR: 1-3/4" 1-13/16" OTHER: _____
 SQUARE <-----Mark for Square Channel-----> SQUARE

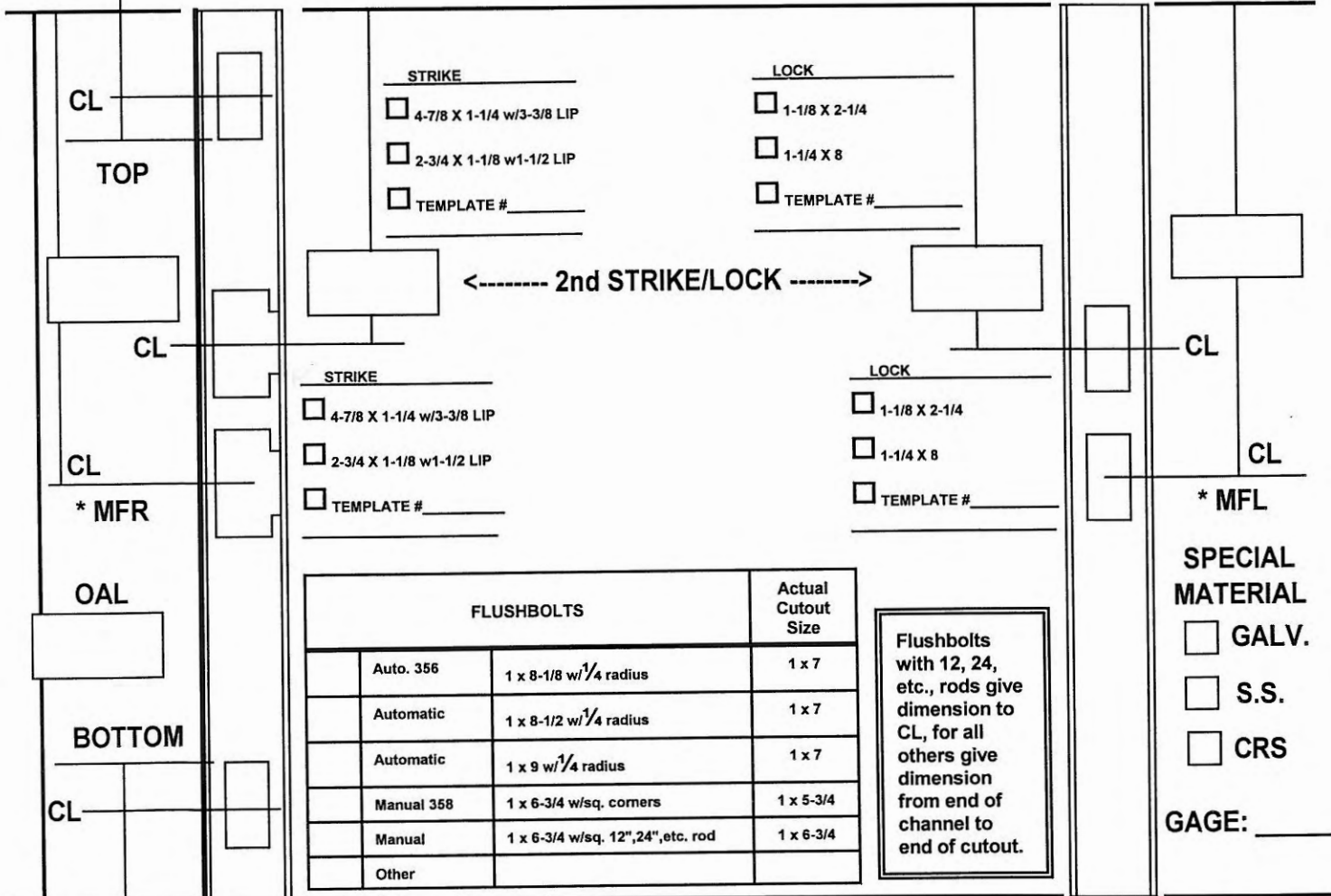

(* This Information is for MACHINING REFERENCE ONLY

Please Check One: 207 212 217 219 RH/LHR ACTIVE

CUSTOMER: _____ DOOR #: _____

P.O.: _____ DATE: _____

M.O.: _____

ACCESSORY ITEM #: _____ DOOR ITEM: _____

NO. of SETS REQ.: _____ DATE REQ.: _____ DRAWN BY: _____ DATE: _____

STD. BEIGE SPECIAL COLOR: _____ NO PAINT VENEER: _____

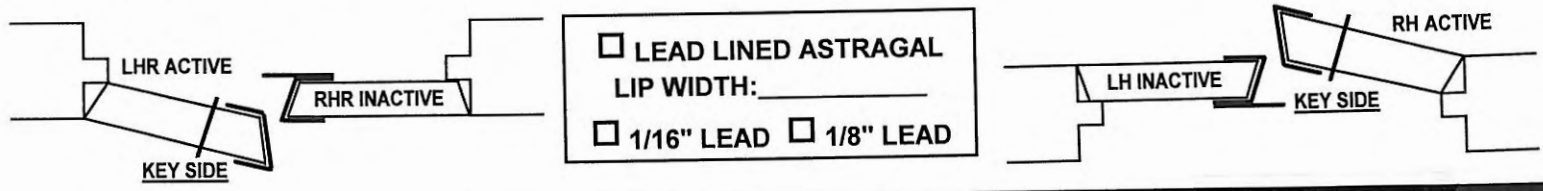

ALL DIMENSIONS ARE FROM TOP OF DOOR.

INACTIVE DOOR

ACTIVE DOOR

DOOR: 1-3/4" 1-13/16" OTHER: _____

SQUARE <-----Mark for Square Channel-----> SQUARE

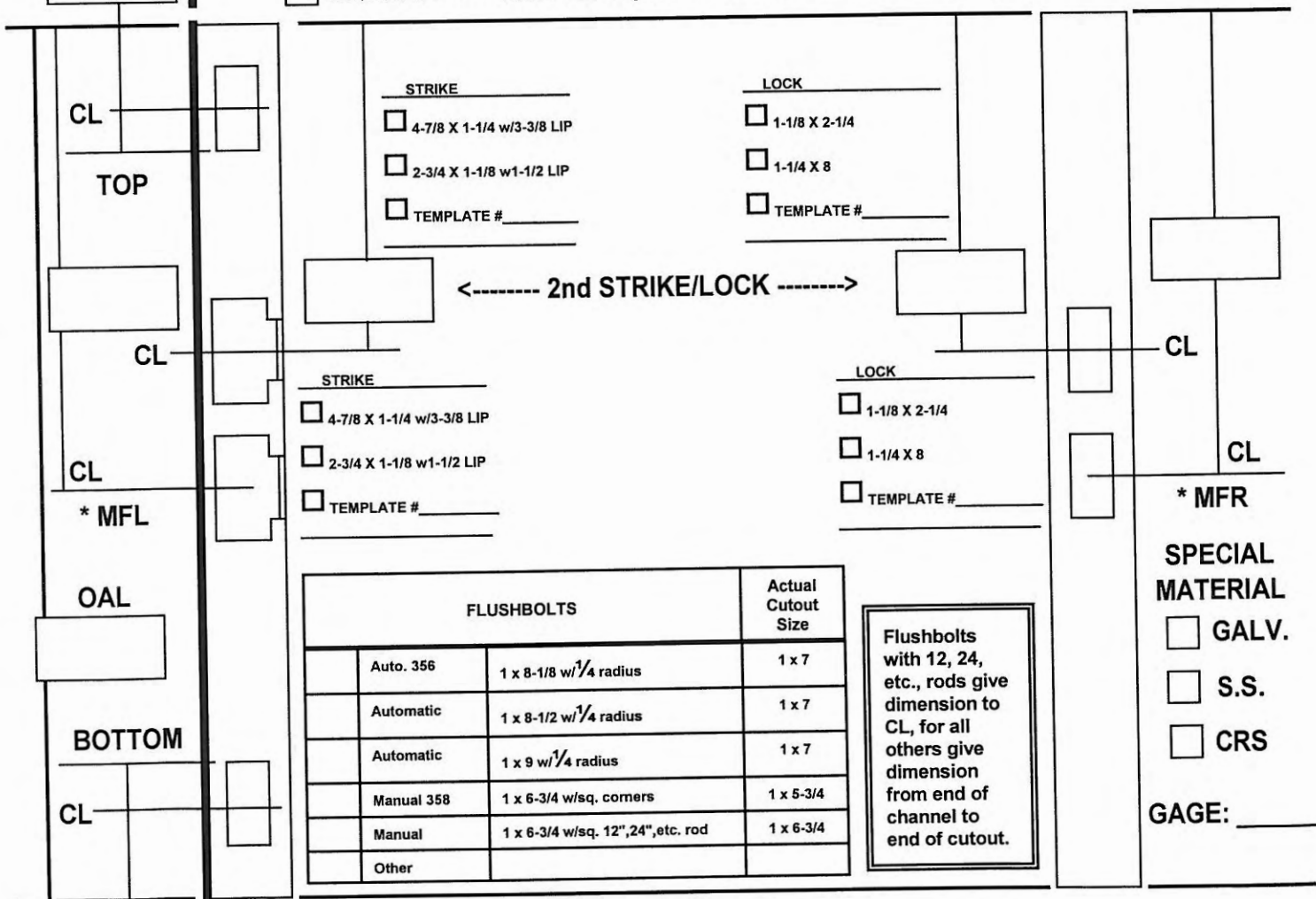

(* This Information is for MACHINING REFERENCE ONLY

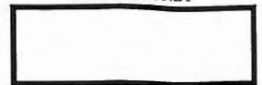

Please Check One: 208 223 224 LH/RHR ACTIVE

CUSTOMER: _____ DOOR #: _____

P.O.: _____ DATE: _____

M.O.: _____

ACCESSORY ITEM #: _____ DOOR ITEM: _____

NO. of SETS REQ.: _____ DATE REQ.: _____ DRAWN BY: _____ DATE: _____

STD. BEIGE SPECIAL COLOR: _____ NO PAINT VENEER: _____

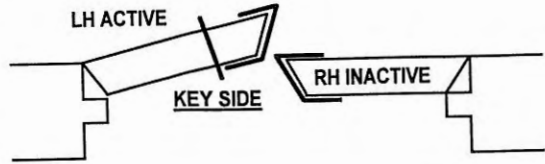
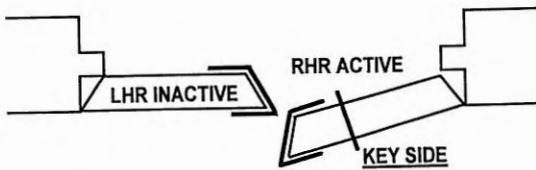

ALL DIMENSIONS ARE FROM TOP OF DOOR.

INACTIVE DOOR

ACTIVE DOOR

DOOR: 1-3/4" 1-13/16" OTHER: _____
 SQUARE <-----Mark for Square Channel-----> SQUARE

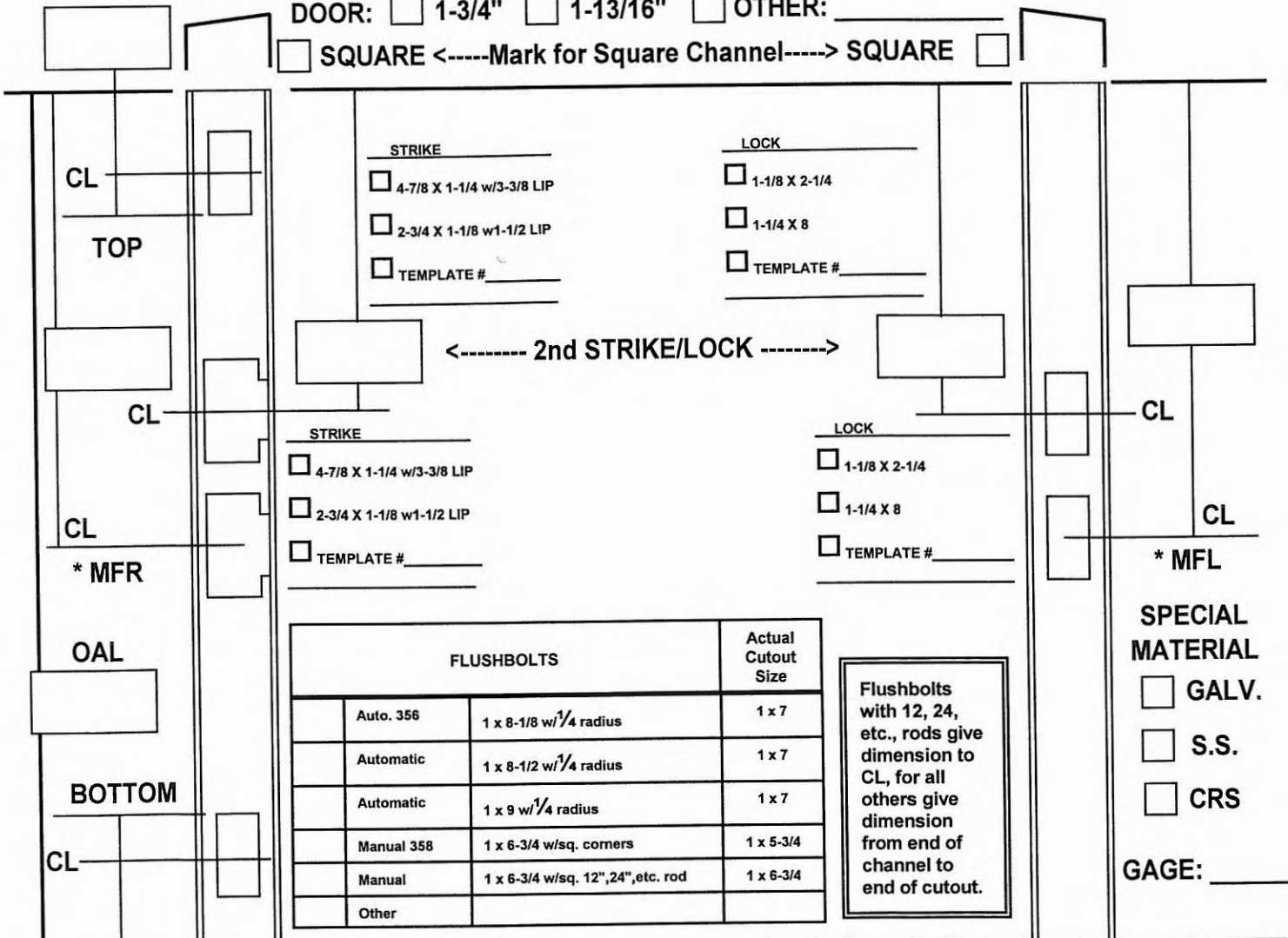

- STRIKE**
- 4-7/8 X 1-1/4 w/3-3/8 LIP
 - 2-3/4 X 1-1/8 w/1-1/2 LIP
 - TEMPLATE # _____

- LOCK**
- 1-1/8 X 2-1/4
 - 1-1/4 X 8
 - TEMPLATE # _____

<----- 2nd STRIKE/LOCK ----->

- STRIKE**
- 4-7/8 X 1-1/4 w/3-3/8 LIP
 - 2-3/4 X 1-1/8 w/1-1/2 LIP
 - TEMPLATE # _____

- LOCK**
- 1-1/8 X 2-1/4
 - 1-1/4 X 8
 - TEMPLATE # _____

FLUSHBOLTS		Actual Cutout Size
Auto. 356	1 x 8-1/8 w/1/4 radius	1 x 7
Automatic	1 x 8-1/2 w/1/4 radius	1 x 7
Automatic	1 x 9 w/1/4 radius	1 x 7
Manual 358	1 x 6-3/4 w/sq. corners	1 x 5-3/4
Manual	1 x 6-3/4 w/sq. 12", 24", etc. rod	1 x 6-3/4
Other		

Flushbolts with 12, 24, etc., rods give dimension to CL, for all others give dimension from end of channel to end of cutout.

- SPECIAL MATERIAL**
- GALV.
 - S.S.
 - CRS

GAGE: _____

(* This Information is for MACHINING REFERENCE ONLY

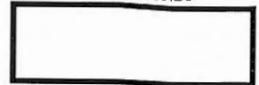

Please Check One: 208 223 224 RH/LHR ACTIVE

CUSTOMER: _____ DOOR #: _____

P.O.: _____ DATE: _____

M.O.: _____

ACCESSORY ITEM #: _____ DOOR ITEM: _____

NO. of SETS REQ.: _____ DATE REQ.: _____ DRAWN BY: _____ DATE: _____

STD. BEIGE SPECIAL COLOR: _____ NO PAINT VENEER: _____

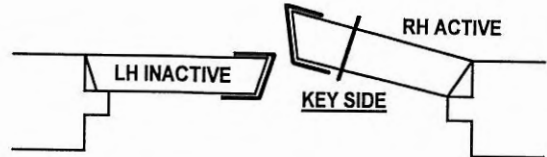
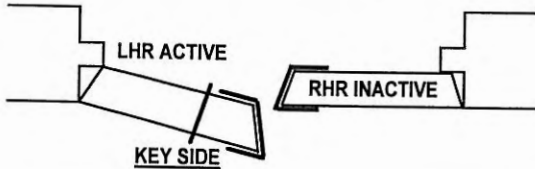

ALL DIMENSIONS ARE FROM TOP OF DOOR.

INACTIVE DOOR

ACTIVE DOOR

DOOR: 1-3/4" 1-13/16" OTHER: _____

SQUARE <-----Mark for Square Channel-----> SQUARE

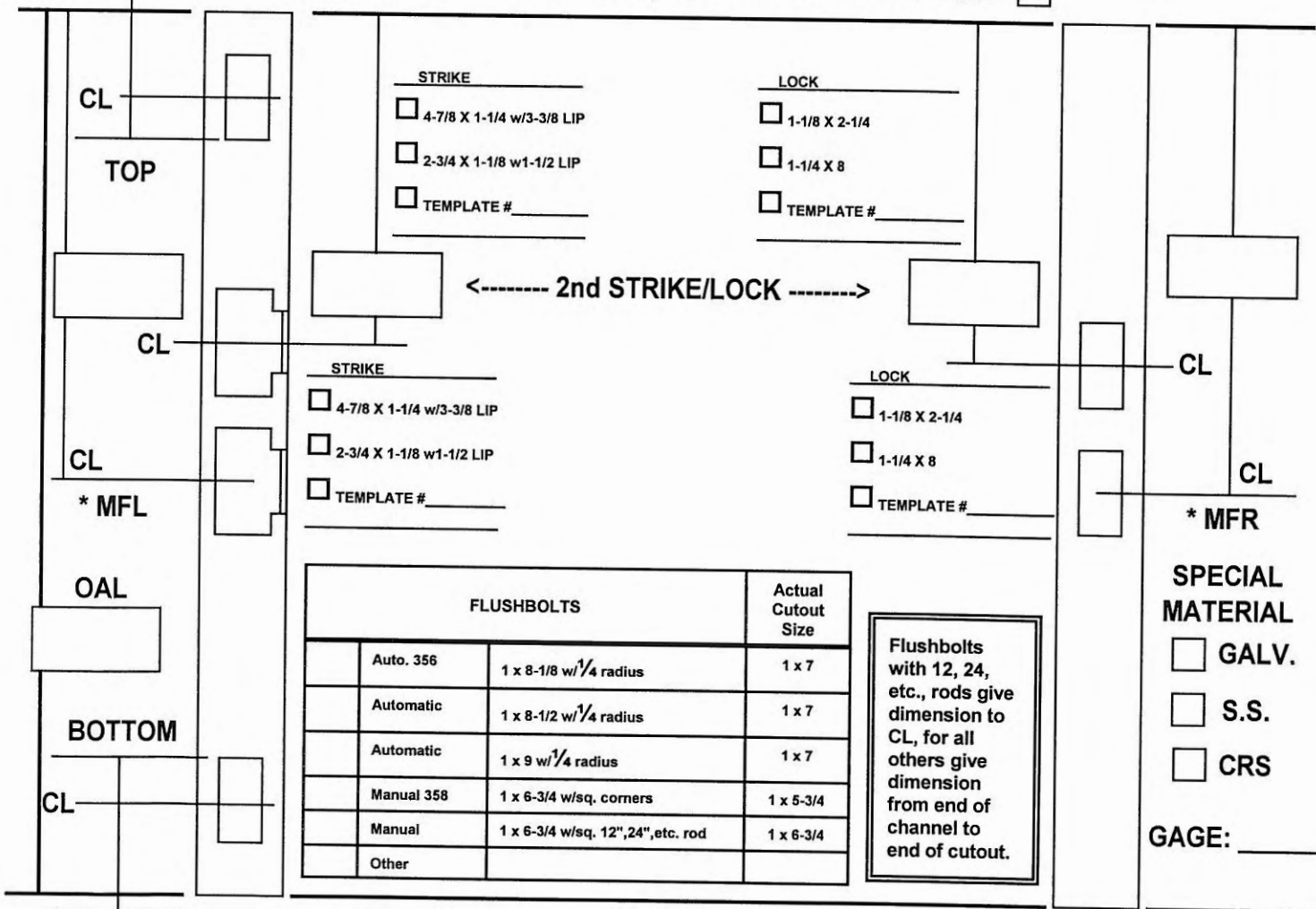

(* This Information is for MACHINING REFERENCE ONLY



Please Check One: 208 223 224 LH/RHR ACTIVE LBR

CUSTOMER: _____ DOOR #: _____

P.O.: _____ DATE: _____

M.O.: _____

ACCESSORY ITEM #: _____ DOOR ITEM: _____

NO. of SETS REQ.: _____ DATE REQ.: _____ DRAWN BY: _____ DATE: _____

STD. BEIGE SPECIAL COLOR: _____ NO PAINT VENEER: _____

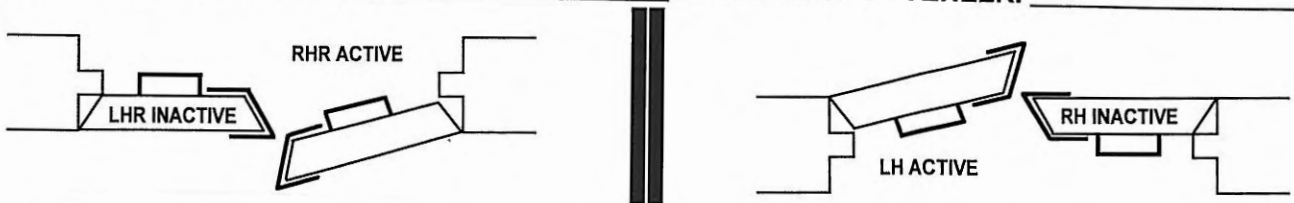

INACTIVE DOOR

ACTIVE DOOR

DOOR: 1-3/4" 1-13/16" OTHER: _____
 SQUARE <-----Mark for Square Channel-----> SQUARE

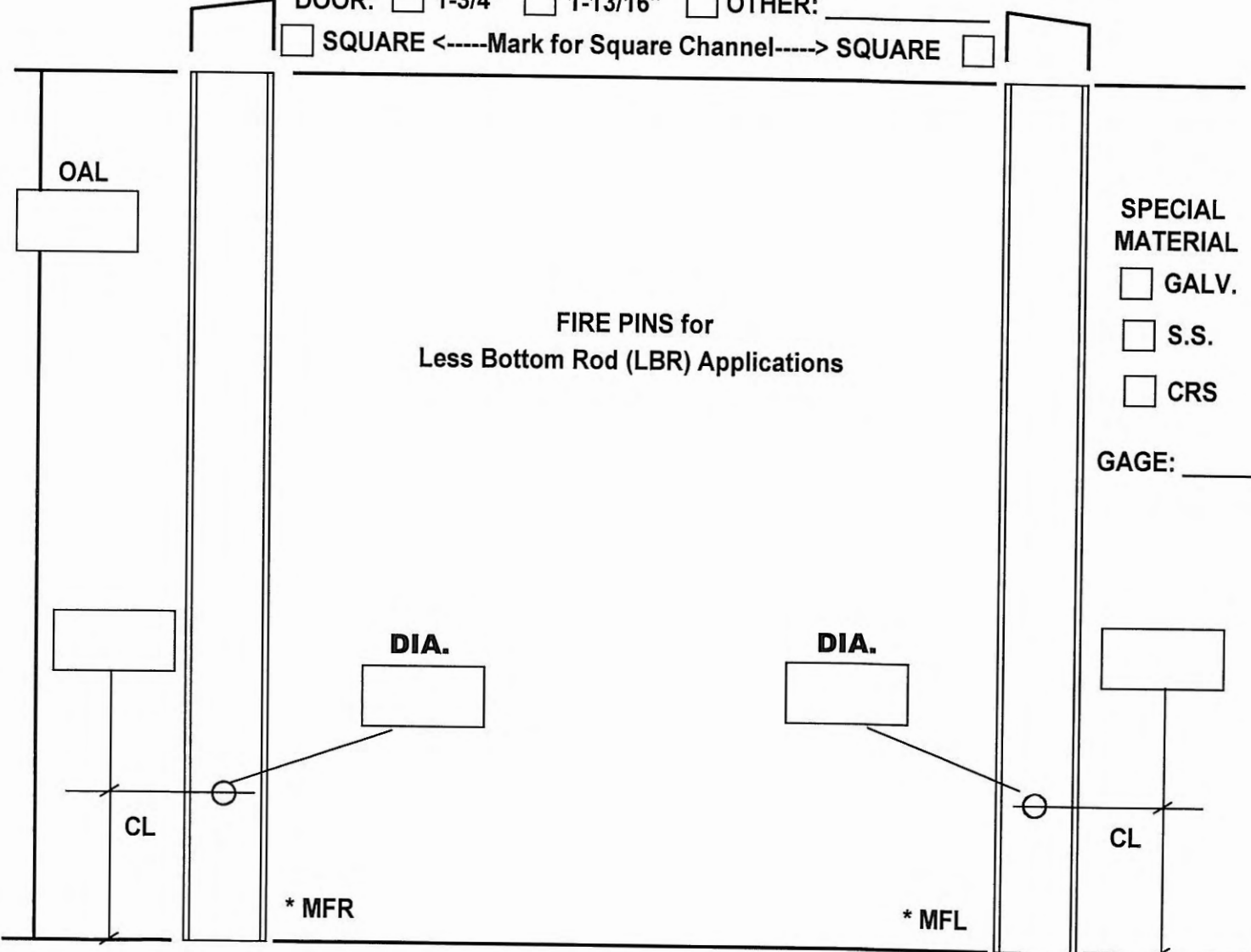

FIRE PINS for
Less Bottom Rod (LBR) Applications

SPECIAL MATERIAL

- GALV.
- S.S.
- CRS

GAGE: _____

(*) This Information is for MACHINING REFERENCE ONLY



Please Check One: 208 223 224 RH/LHR ACTIVE LBR

CUSTOMER: _____

DOOR #: _____

P.O.: _____ DATE: _____

M.O.: _____

ACCESSORY ITEM #: _____ DOOR ITEM: _____

NO. of SETS REQ.: _____ DATE REQ.: _____ DRAWN BY: _____ DATE: _____

STD. BEIGE SPECIAL COLOR: _____ NO PAINT VENEER: _____

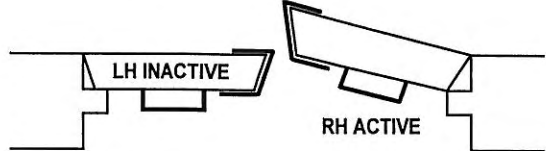
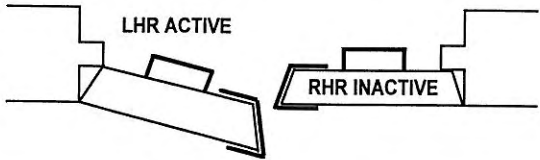

INACTIVE DOOR

ACTIVE DOOR

DOOR: 1-3/4" 1-13/16" OTHER: _____

SQUARE <-----Mark for Square Channel-----> SQUARE

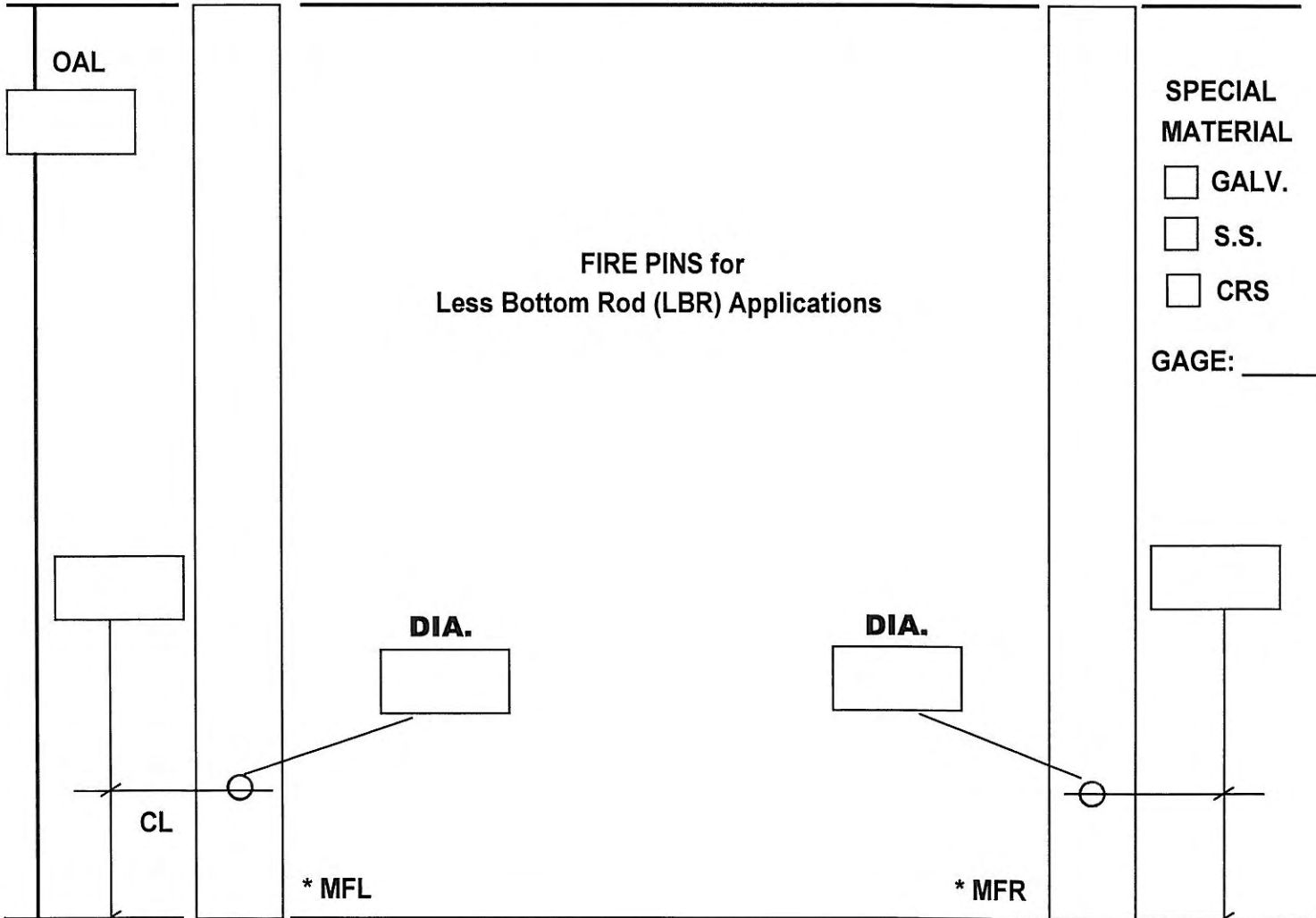

SPECIAL MATERIAL

- GALV.
- S.S.
- CRS

GAGE: _____

(*) This Information is for MACHINING REFERENCE ONLY



Please Check One: 208 223 224 LH/RHR ACTIVE LBR

CUSTOMER: _____ DOOR #: _____

P.O.: _____ DATE: _____

M.O.: _____

ACCESSORY ITEM #: _____ DOOR ITEM: _____

NO. of SETS REQ.: _____ DATE REQ.: _____ DRAWN BY: _____ DATE: _____

STD. BEIGE SPECIAL COLOR: _____ NO PAINT VENEER: _____



INACTIVE DOOR

ACTIVE DOOR

DOOR: 1-3/4" 1-13/16" OTHER: _____

SQUARE ←—Mark for Square Channel—→ SQUARE

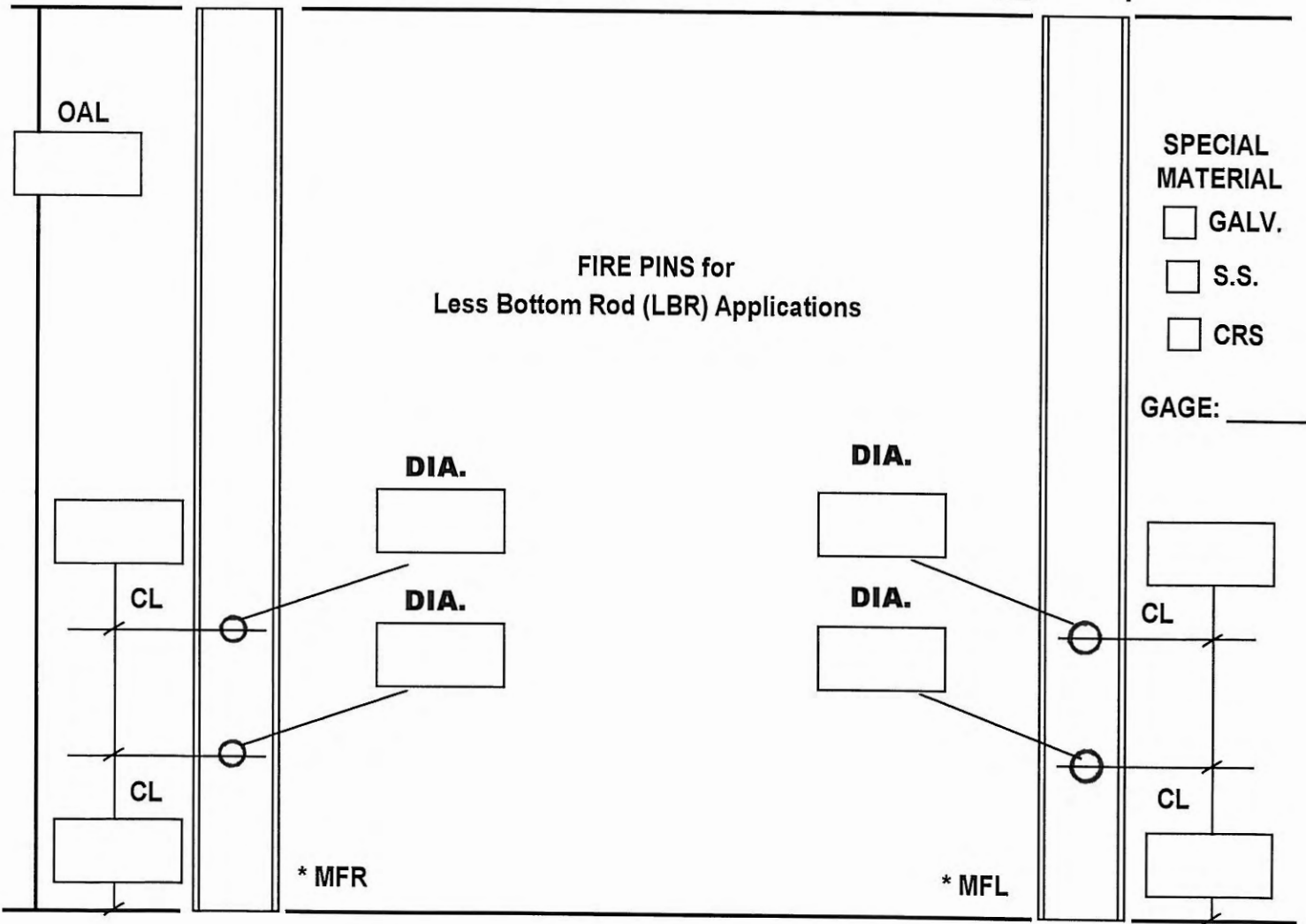

(*) This Information is for MACHINING REFERENCE ONLY

Please Check One: 208 223 224 RH/LHR ACTIVE LBR

CUSTOMER: _____ DOOR #: _____

P.O.: _____ DATE: _____

M.O.: _____

ACCESSORY ITEM #: _____ DOOR ITEM: _____

NO. of SETS REQ.: _____ DATE REQ.: _____ DRAWN BY: _____ DATE: _____

STD. BEIGE SPECIAL COLOR: _____ NO PAINT VENEER: _____

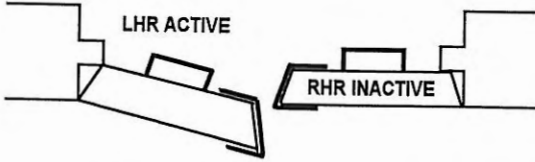

INACTIVE DOOR

ACTIVE DOOR

DOOR: 1-3/4" 1-13/16" OTHER: _____
 SQUARE ←—Mark for Square Channel—→ SQUARE

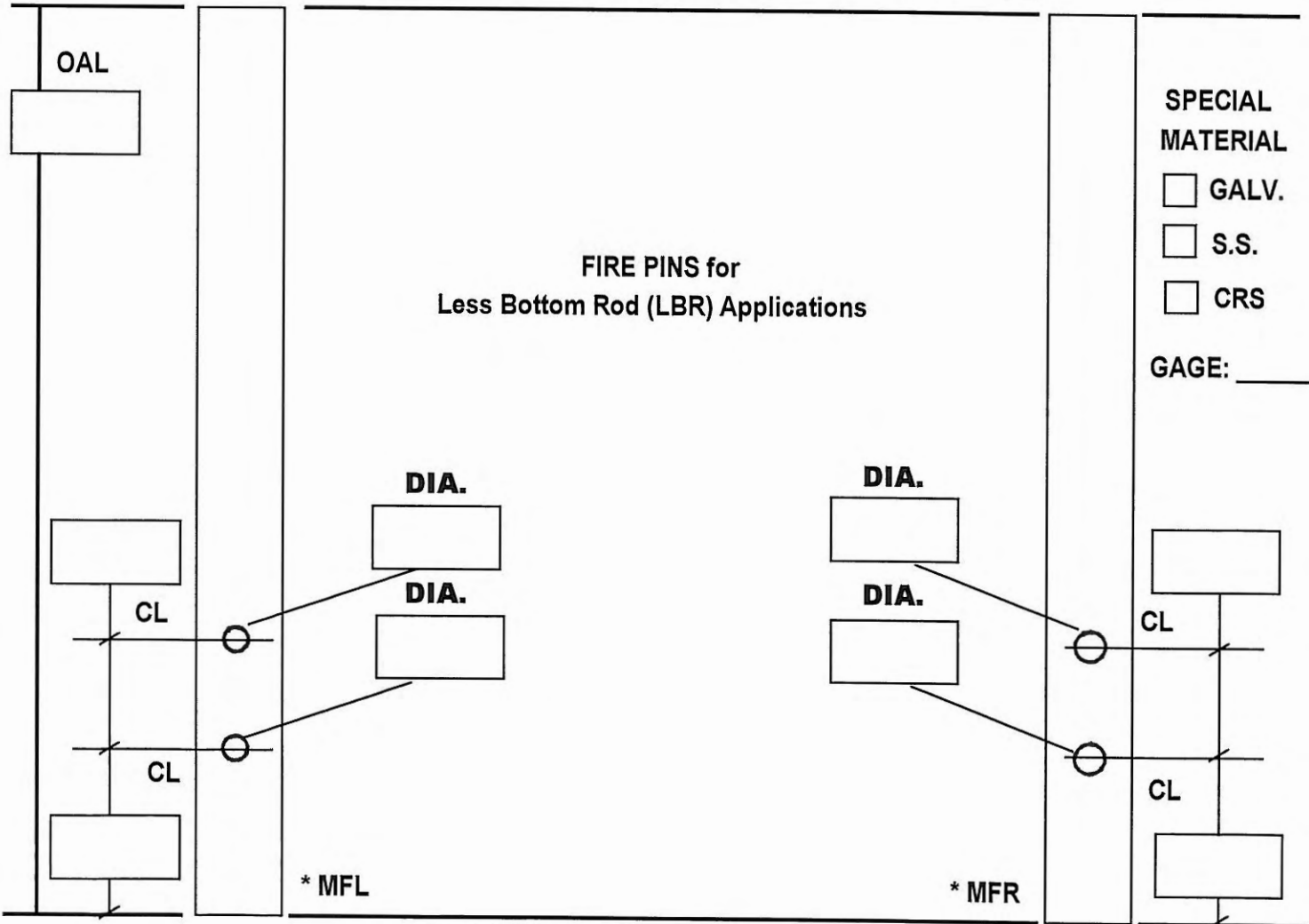

FIRE PINS for
Less Bottom Rod (LBR) Applications

- SPECIAL MATERIAL**
- GALV.
 - S.S.
 - CRS

GAGE: _____

(*) This Information is for MACHINING REFERENCE ONLY

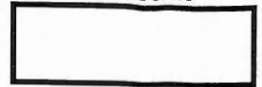

Please Check One: 208 223 224 LH/RHR ACTIVE for SARGENT PP & PR 8700

CUSTOMER: _____ DOOR #: _____

P.O.: _____ DATE: _____

M.O.: _____

ACCESSORY ITEM #: _____ DOOR ITEM: _____

NO. of SETS REQ.: _____ DATE REQ.: _____ DRAWN BY: _____ DATE: _____

STD. BEIGE SPECIAL COLOR: _____ NO PAINT VENEER: _____

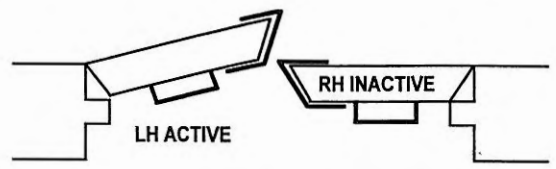
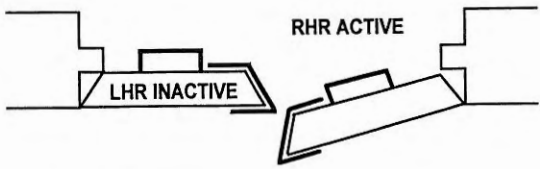

ALL DIMENSIONS ARE FROM TOP OF DOOR.

INACTIVE DOOR

ACTIVE DOOR

DOOR: 1-3/4" 1-13/16" OTHER: _____
 SQUARE <--- Mark for Square Channel ---> SQUARE

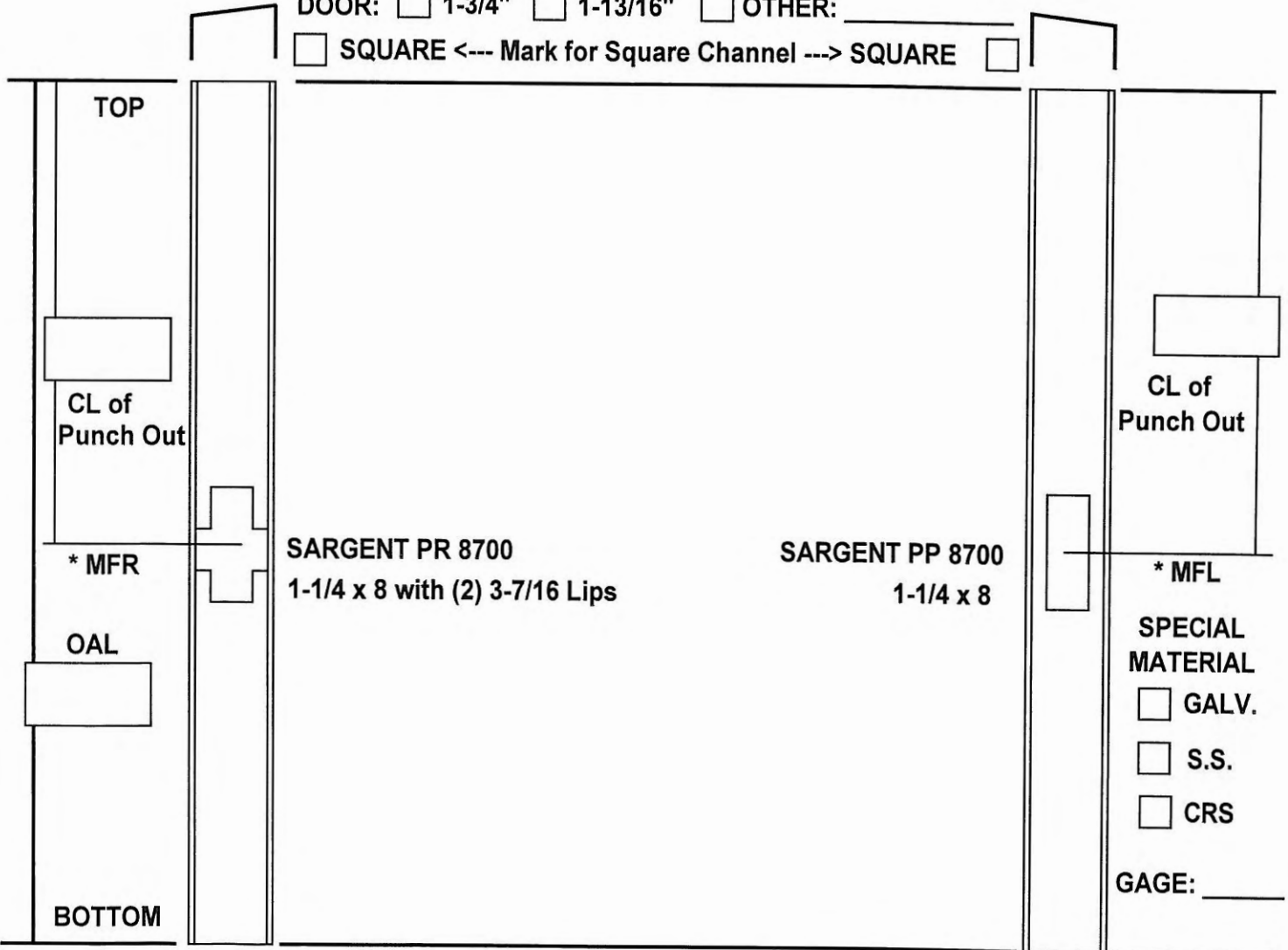

(*) This Information is for MACHINING REFERENCE ONLY



Please Check One: 208 223 224 RH/LHR ACTIVE for SARGENT PP & PR 8700

CUSTOMER: _____ DOOR #: _____

P.O.: _____ DATE: _____

M.O.: _____

ACCESSORY ITEM #: _____ DOOR ITEM: _____

NO. of SETS REQ.: _____ DATE REQ.: _____ DRAWN BY: _____ DATE: _____

STD. BEIGE SPECIAL COLOR: _____ NO PAINT VENEER: _____

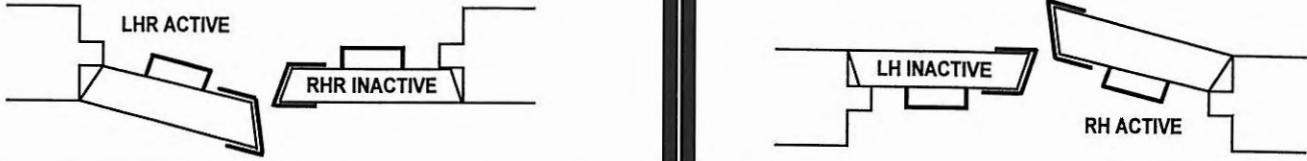

ALL DIMENSIONS ARE FROM TOP OF DOOR.

INACTIVE DOOR

ACTIVE DOOR

DOOR: 1-3/4" 1-13/16" OTHER: _____
 SQUARE <--- Mark for Square Channel ---> SQUARE

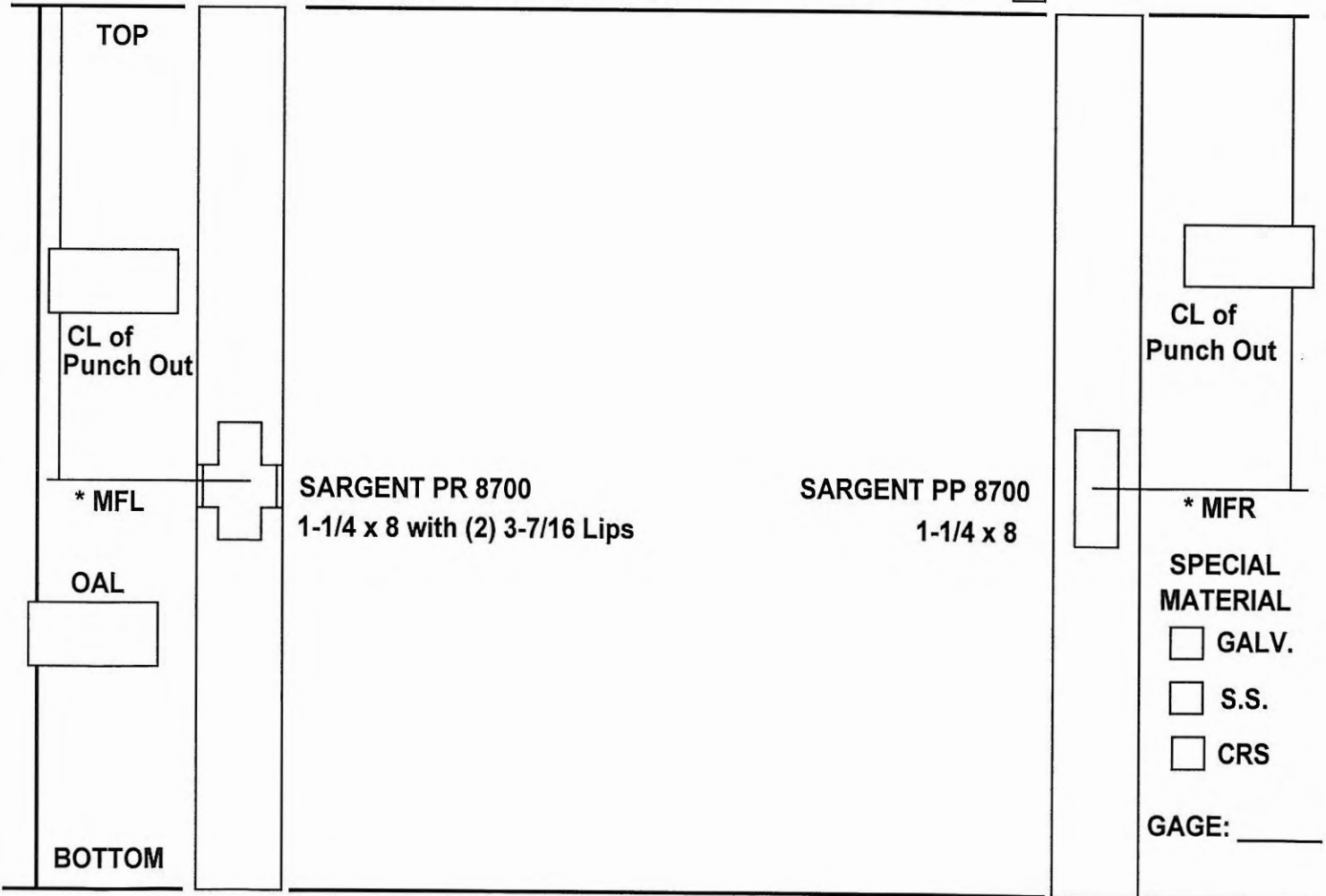

(*) This Information is for MACHINING REFERENCE ONLY

8/15/03 **ALL METAL STAMPING, INC., ABBOTSFORD, WI. 54405**
715-223-6324 PARALLEL BEVEL SET FAX: 715-223-3352
225 LH/RHR ACTIVE for SARGENT PP & PR 8700
DOUBLE EGRESS SET

AMS USE ONLY



CUSTOMER: _____ DOOR #: _____

P.O.: _____ DATE: _____

M.O.: _____

ACCESSORY ITEM #: _____ DOOR ITEM: _____

NO. of SETS REQ.: _____ DATE REQ.: _____ DRAWN BY: _____ DATE: _____

STD. BEIGE SPECIAL COLOR: _____ NO PAINT VENEER: _____

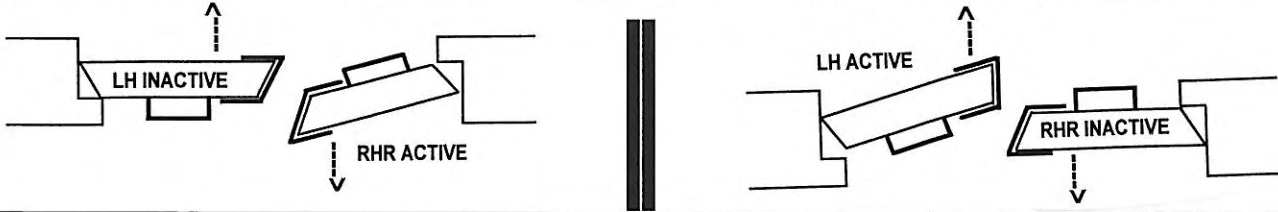

ALL DIMENSIONS ARE FROM TOP OF DOOR.

INACTIVE DOOR

ACTIVE DOOR

DOOR: 1-3/4" 1-13/16" OTHER: _____

SQUARE <--- Mark for Square Channel ---> SQUARE

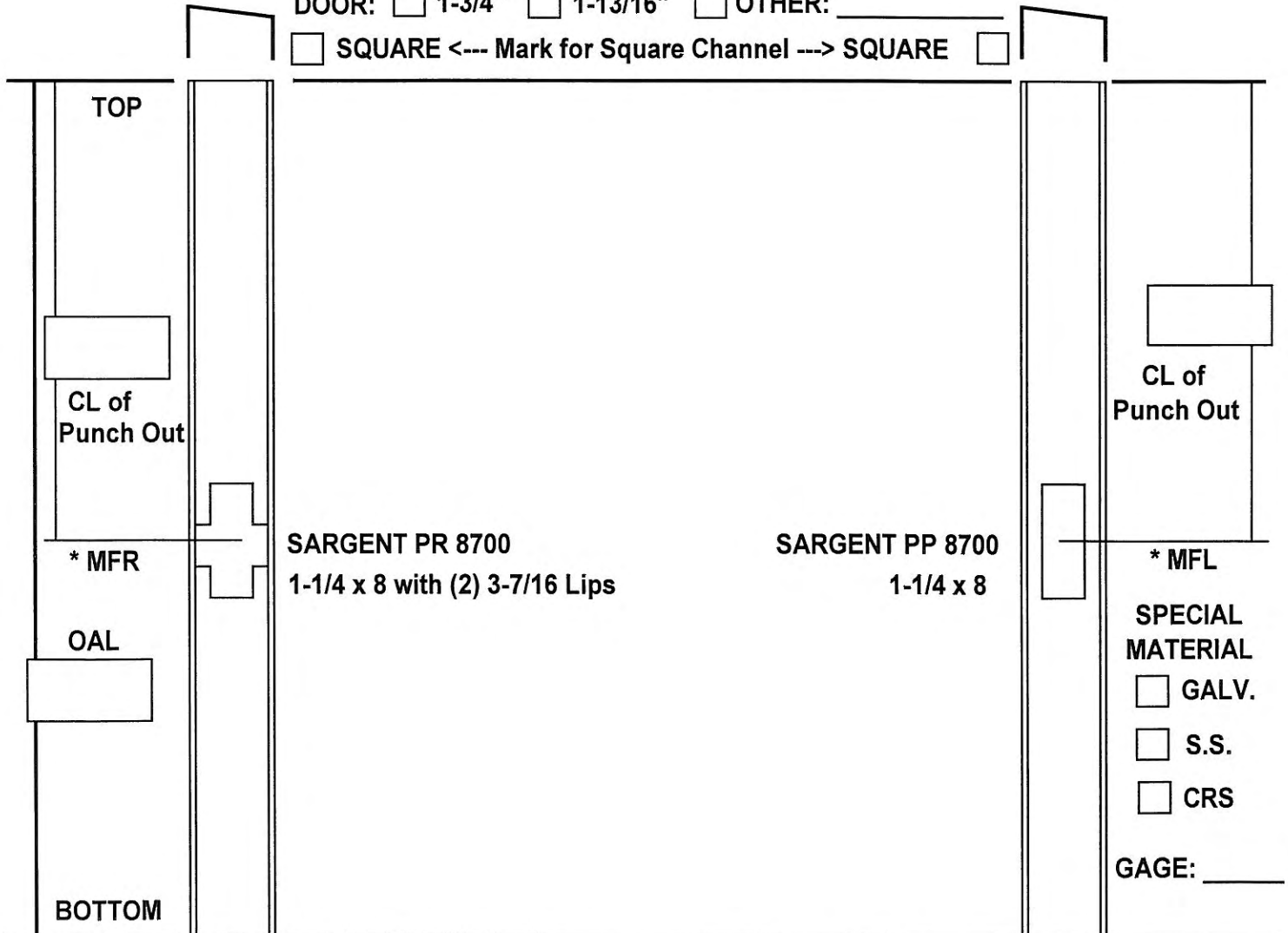

(*) This Information is for MACHINING REFERENCE ONLY

8/15/03 ALL METAL STAMPING, INC., ABBOTSFORD, WI. 54405
 715-223-6324 PARALLEL BEVEL SET FAX: 715-223-3352
 225 RH/LHR ACTIVE for SARGENT PP & PR 8700
DOUBLE EGRESS SET

AMS USE ONLY



CUSTOMER: _____ DOOR #: _____

P.O.: _____ DATE: _____

M.O.: _____

ACCESSORY ITEM #: _____ DOOR ITEM: _____

NO. of SETS REQ.: _____ DATE REQ.: _____ DRAWN BY: _____ DATE: _____

STD. BEIGE SPECIAL COLOR: _____ NO PAINT VENEER: _____

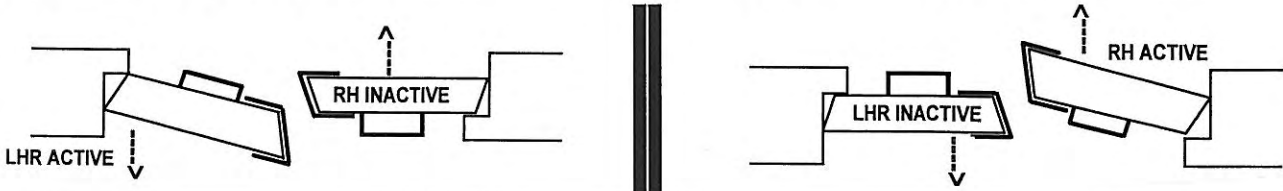

ALL DIMENSIONS ARE FROM TOP OF DOOR.

INACTIVE DOOR

ACTIVE DOOR

DOOR: 1-3/4" 1-13/16" OTHER: _____
 SQUARE <--- Mark for Square Channel ---> SQUARE

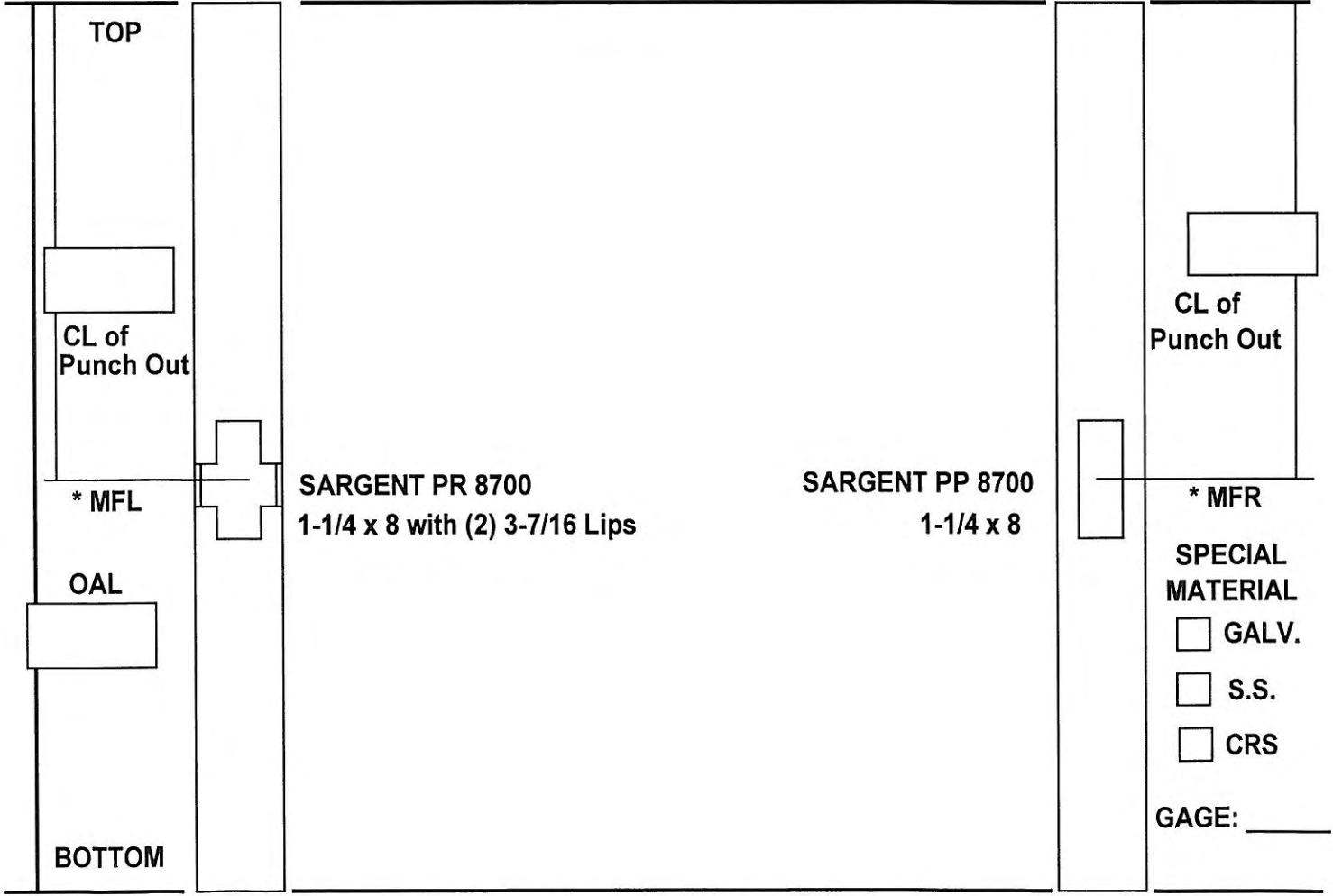

(* This Information is for MACHINING REFERENCE ONLY



Please Check One: 209 w/ASTRAGAL 225 DOUBLE EDGE LH/RHR ACTIVE

CUSTOMER: _____ DOOR #: _____

P.O.: _____ DATE: _____

M.O.: _____

ACCESSORY ITEM #: _____ DOOR ITEM: _____

NO. of SETS REQ.: _____ DATE REQ.: _____ DRAWN BY: _____ DATE: _____

STD. BEIGE SPECIAL COLOR: _____ NO PAINT VENEER: _____

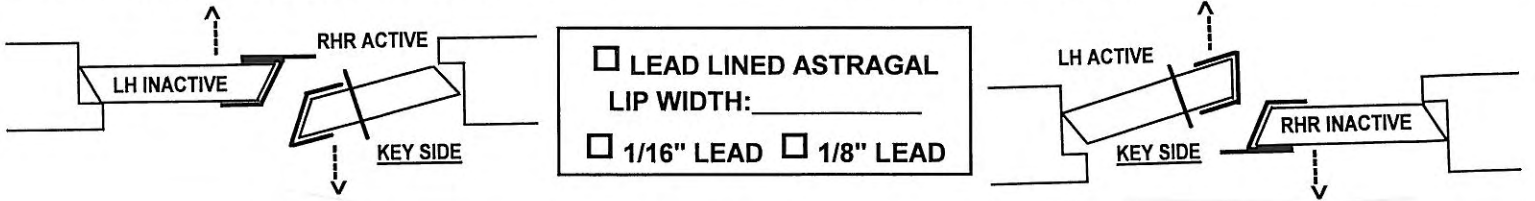

ALL DIMENSIONS ARE FROM TOP OF DOOR.

INACTIVE DOOR

ACTIVE DOOR

DOOR: 1-3/4" 1-13/16" OTHER: _____

<-----Mark for NO ASTRAGAL LIP

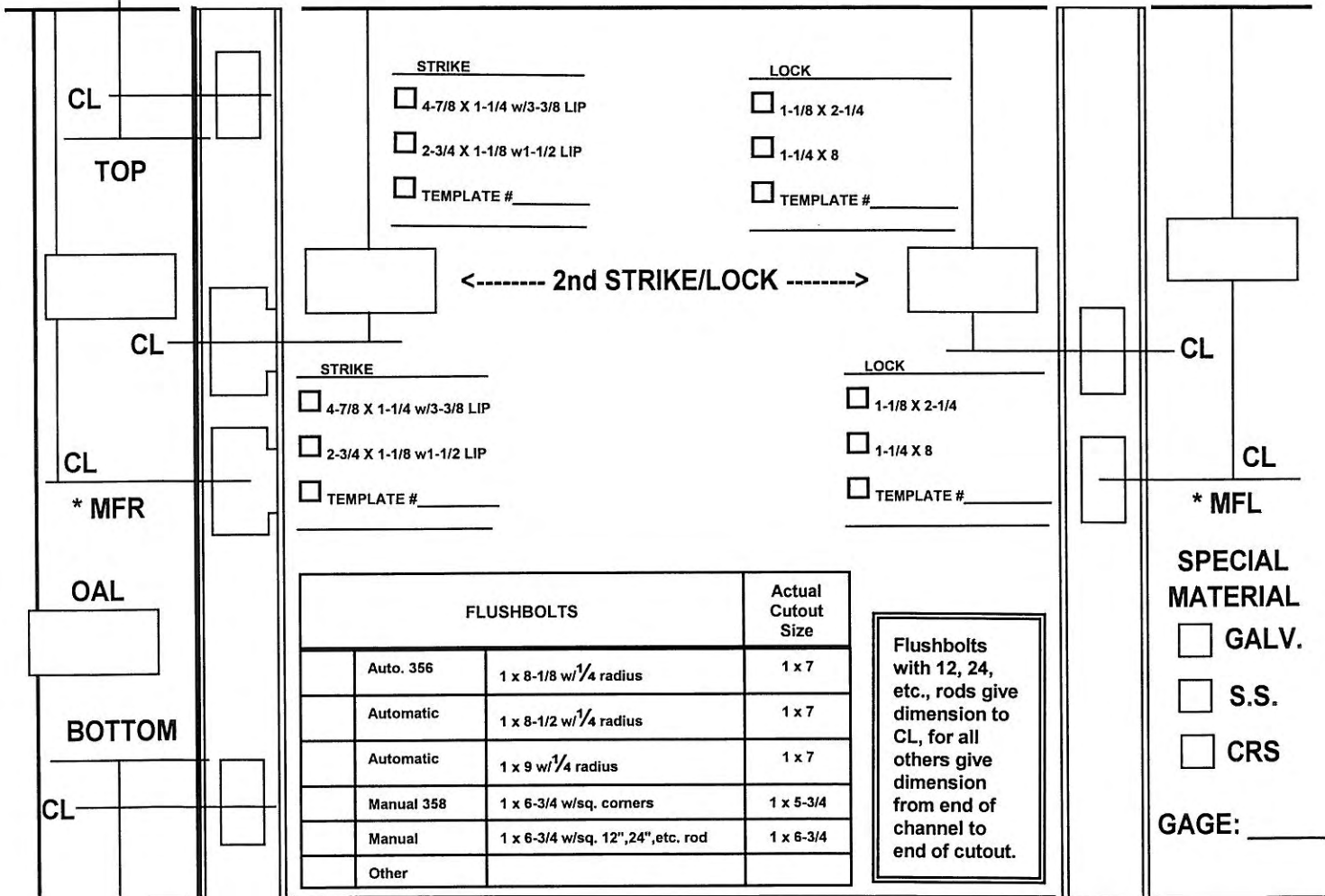

(*) This Information is for MACHINING REFERENCE ONLY

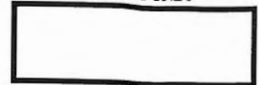

Please Check One: 209 w/ASTRAGAL 225 DOUBLE EDGE RH/LHR ACTIVE
 CUSTOMER: _____ DOOR #: _____

P.O.: _____ DATE: _____

M.O.: _____

ACCESSORY ITEM #: _____ DOOR ITEM: _____

NO. of SETS REQ.: _____ DATE REQ.: _____ DRAWN BY: _____ DATE: _____

STD. BEIGE SPECIAL COLOR: _____ NO PAINT VENEER: _____

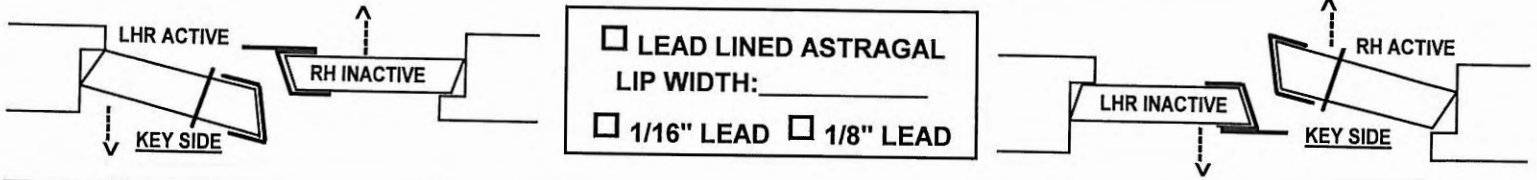

ALL DIMENSIONS ARE FROM TOP OF DOOR.

INACTIVE DOOR

ACTIVE DOOR

DOOR: 1-3/4" 1-13/16" OTHER: _____
 <-----Mark for NO ASTRAGAL LIP

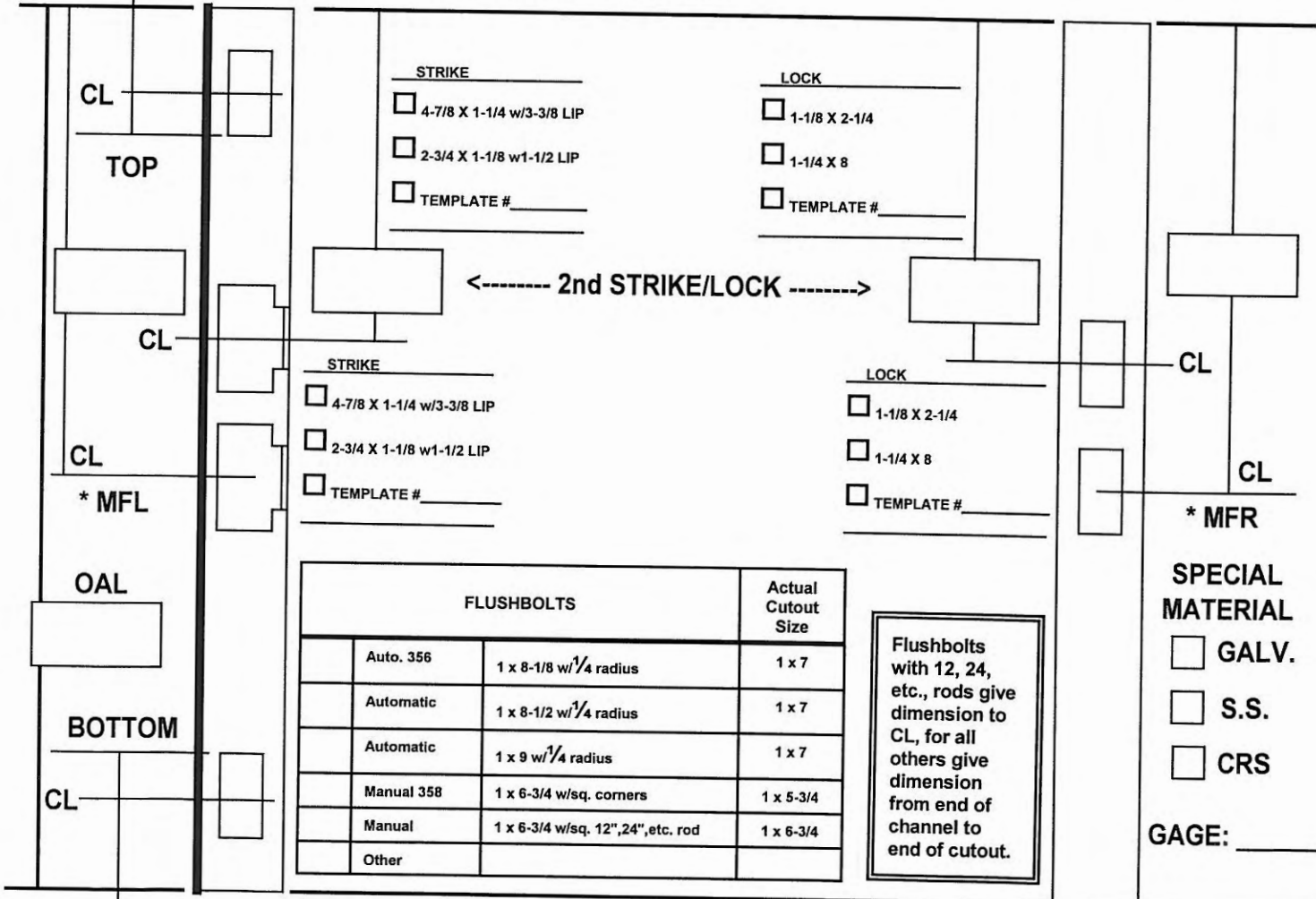

(* This Information is for MACHINING REFERENCE ONLY



Please Check One: 209 w/ASTRAGAL 225 DOUBLE EDGE LH/RHR ACTIVE
Less Bottom Rod (LBR)

CUSTOMER: _____ DOOR #: _____

P.O.: _____ DATE: _____

M.O.: _____

ACCESSORY ITEM #: _____ DOOR ITEM: _____

NO. of SETS REQ.: _____ DATE REQ.: _____ DRAWN BY: _____ DATE: _____

STD. BEIGE SPECIAL COLOR: _____ NO PAINT VENEER: _____

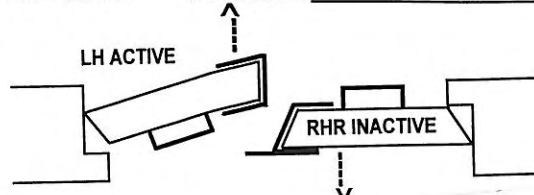
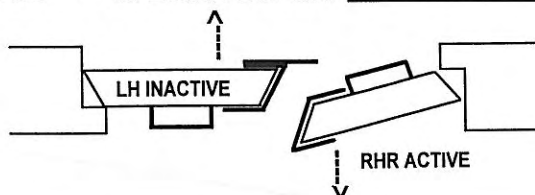

INACTIVE DOOR

ACTIVE DOOR

DOOR: 1-3/4" 1-13/16" OTHER: _____

<-----Mark for NO ASTRAGAL LIP

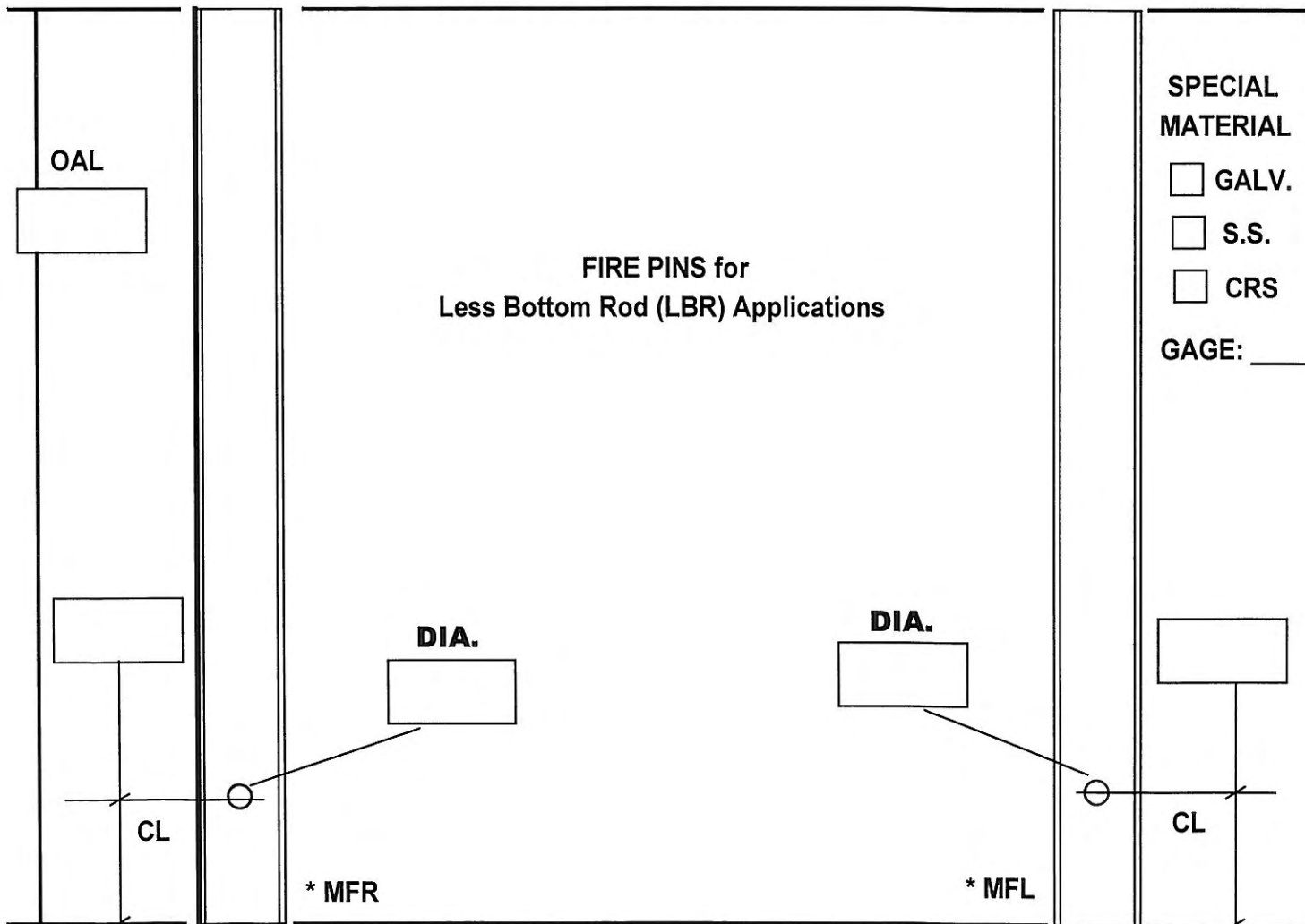

(* This Information is for MACHINING REFERENCE ONLY

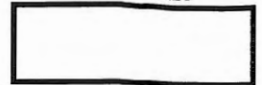

Please Check One: 209 w/ASTRAGAL 225 DOUBLE EDGE RH/LHR ACTIVE
Less Bottom Rod (LBR)

CUSTOMER: _____ DOOR #: _____

P.O.: _____ DATE: _____

M.O.: _____

ACCESSORY ITEM #: _____ DOOR ITEM: _____

NO. of SETS REQ.: _____ DATE REQ.: _____ DRAWN BY: _____ DATE: _____

STD. BEIGE SPECIAL COLOR: _____ NO PAINT VENEER: _____

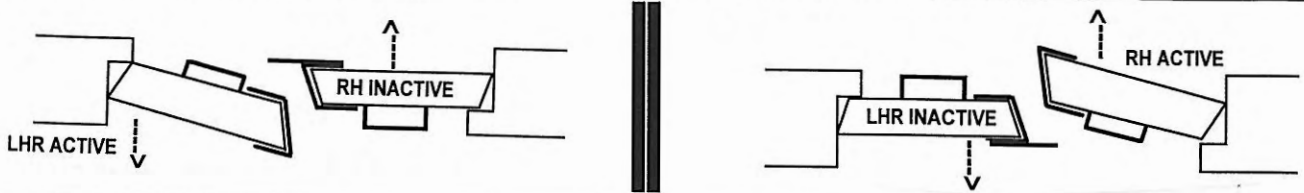

INACTIVE DOOR

ACTIVE DOOR

DOOR: 1-3/4" 1-13/16" OTHER: _____

<-----Mark for NO ASTRAGAL LIP

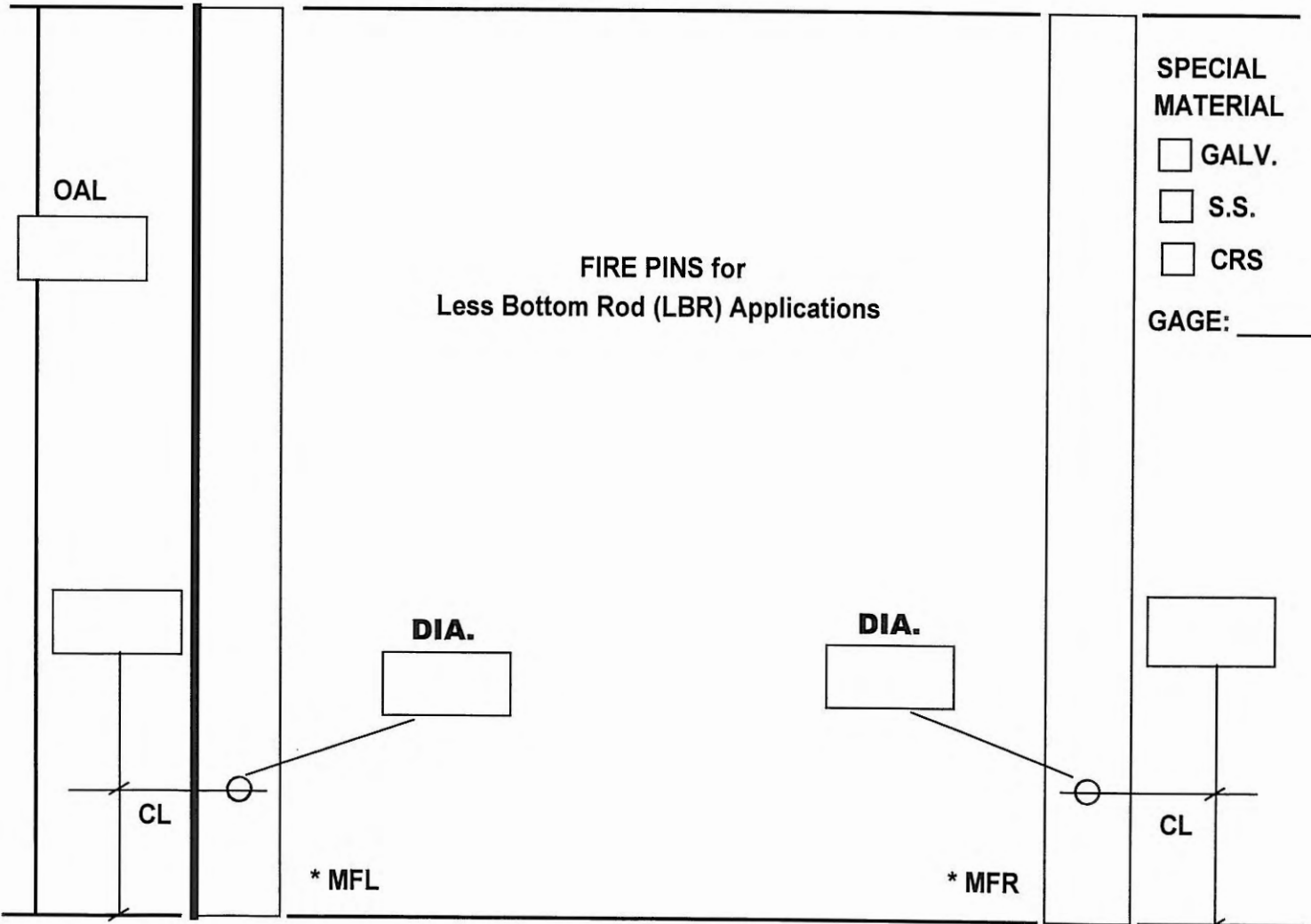

(*) This Information is for MACHINING REFERENCE ONLY



Check One: 209A w/ASTRAGAL 225A DOUBLE EDGE LH/RHR ACTIVE
 CUSTOMER: _____ DOOR #: _____

P.O.: _____ DATE: _____

M.O.: _____

ACCESSORY ITEM #: _____ DOOR ITEM: _____

NO. of SETS REQ.: _____ DATE REQ.: _____ DRAWN BY: _____ DATE: _____

STD. BEIGE SPECIAL COLOR: _____ NO PAINT VENEER: _____

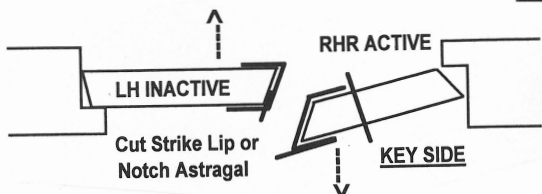

Lead Lined Astragal flange cannot be notched.
 LEAD LINED ASTRAGAL
 LIP WIDTH: _____
 1/16" LEAD 1/8" LEAD

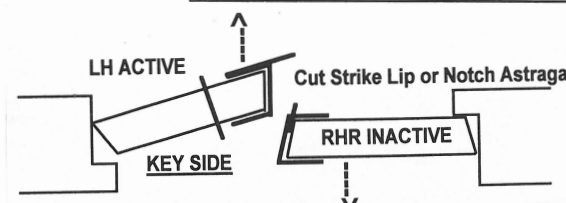

ALL DIMENSIONS ARE FROM TOP OF DOOR.

ACTIVE DOOR

INACTIVE DOOR

DOOR: 1-3/4" 1-13/16" OTHER: _____

<-----Mark for NO ASTRAGAL LIP

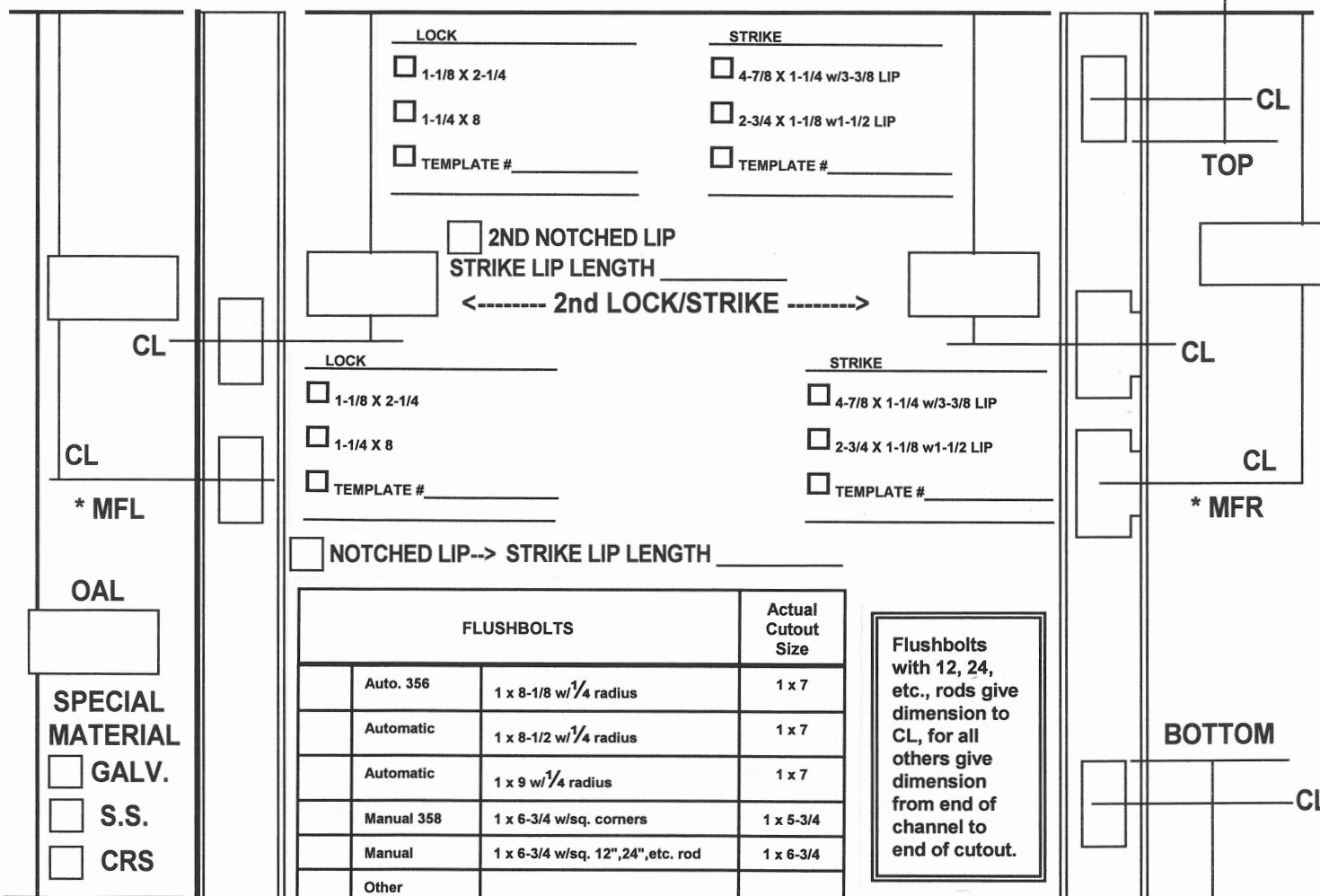

SPECIAL MATERIAL

- GALV.
- S.S.
- CRS

GAGE: _____

(*) This Information is for MACHINING REFERENCE ONLY

2/21/12 ALL METAL STAMPING, INC., ABBOTSFORD, WI. 54405
 715-223-6324 PARALLEL BEVEL SET FAX: 715-223-3352

AMS USE ONLY



Check One: 209A w/ASTRAGAL 225A DOUBLE EDGE RH/LHR ACTIVE
 CUSTOMER: _____ DOOR #: _____

P.O.: _____ DATE: _____

M.O.: _____

ACCESSORY ITEM #: _____ DOOR ITEM: _____

NO. of SETS REQ.: _____ DATE REQ.: _____ DRAWN BY: _____ DATE: _____

STD. BEIGE SPECIAL COLOR: _____ NO PAINT VENEER: _____

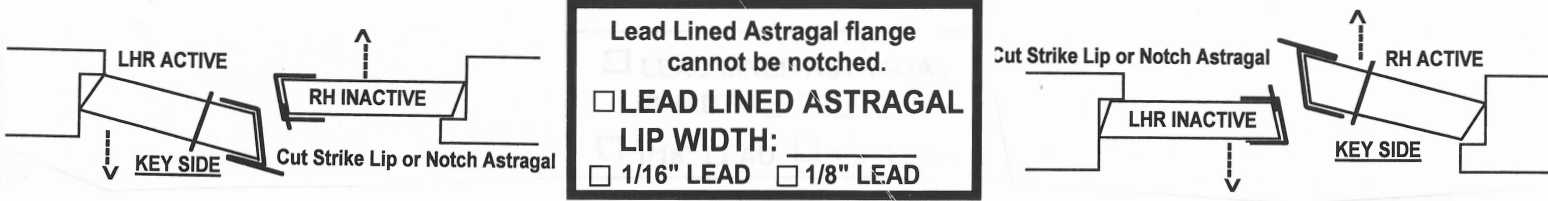

Lead Lined Astragal flange cannot be notched.
 LEAD LINED ASTRAGAL
 LIP WIDTH: _____
 1/16" LEAD 1/8" LEAD

ALL DIMENSIONS ARE FROM TOP OF DOOR.

ACTIVE DOOR

INACTIVE DOOR

DOOR: 1-3/4" 1-13/16" OTHER: _____
 <-----Mark for NO ASTRAGAL LIP

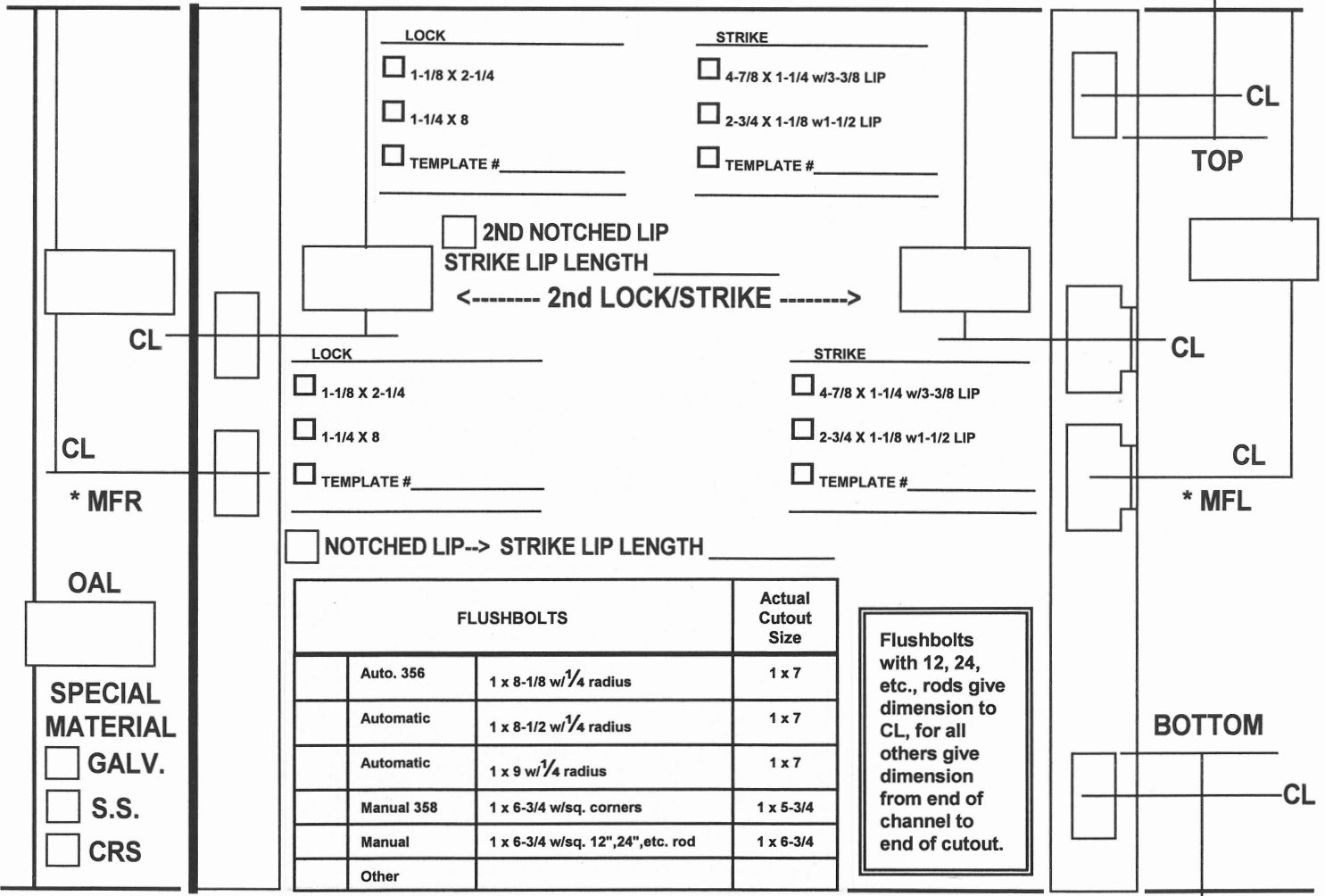

LOCK 1-1/8 X 2-1/4 1-1/4 X 8 TEMPLATE # _____
 STRIKE 4-7/8 X 1-1/4 w/3-3/8 LIP 2-3/4 X 1-1/8 w/1-1/2 LIP TEMPLATE # _____

2ND NOTCHED LIP
 STRIKE LIP LENGTH _____
 <----- 2nd LOCK/STRIKE ----->

LOCK 1-1/8 X 2-1/4 1-1/4 X 8 TEMPLATE # _____
 STRIKE 4-7/8 X 1-1/4 w/3-3/8 LIP 2-3/4 X 1-1/8 w/1-1/2 LIP TEMPLATE # _____

NOTCHED LIP--> STRIKE LIP LENGTH _____

FLUSHBOLTS			Actual Cutout Size
Auto. 356	1 x 8-1/8 w/1/4 radius		1 x 7
Automatic	1 x 8-1/2 w/1/4 radius		1 x 7
Automatic	1 x 9 w/1/4 radius		1 x 7
Manual 358	1 x 6-3/4 w/sq. corners		1 x 5-3/4
Manual	1 x 6-3/4 w/sq. 12", 24", etc. rod		1 x 6-3/4
Other			

Flushbolts with 12, 24, etc., rods give dimension to CL, for all others give dimension from end of channel to end of cutout.

SPECIAL MATERIAL
 GALV.
 S.S.
 CRS

GAGE: _____

(*) This Information is for MACHINING REFERENCE ONLY

2/21/12

ALL METAL STAMPING, INC., ABBOTSFORD, WI. 54405

715-223-6324

FAX: 715-223-3352

AMS USE ONLY

Please Check One: 211 217A 218 226 LH/RHR ACTIVE

CUSTOMER: _____

DOOR #: _____

P.O.: _____ DATE: _____

M.O.: _____

ACCESSORY ITEM #: _____ DOOR ITEM: _____

NO. of SETS REQ.: _____ DATE REQ.: _____ DRAWN BY: _____ DATE: _____

STD. BEIGE SPECIAL COLOR: _____ NO PAINT VENEER: _____

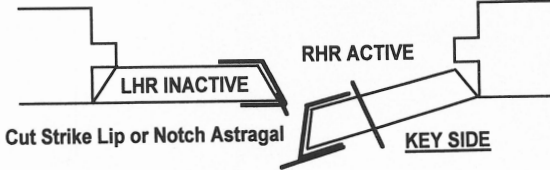

Lead Lined Astragal flange cannot be notched.

LEAD LINED ASTRAGAL LIP WIDTH: _____

1/16" LEAD 1/8" LEAD

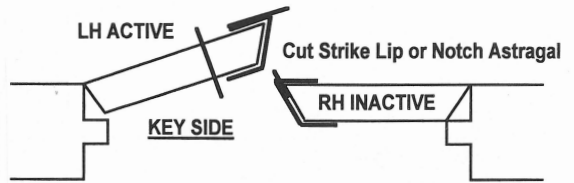

ALL DIMENSIONS ARE FROM TOP OF DOOR.

ACTIVE DOOR

INACTIVE DOOR

DOOR: 1-3/4" 1-13/16" OTHER: _____

SQUARE <-----Mark for Square Channel-----> SQUARE

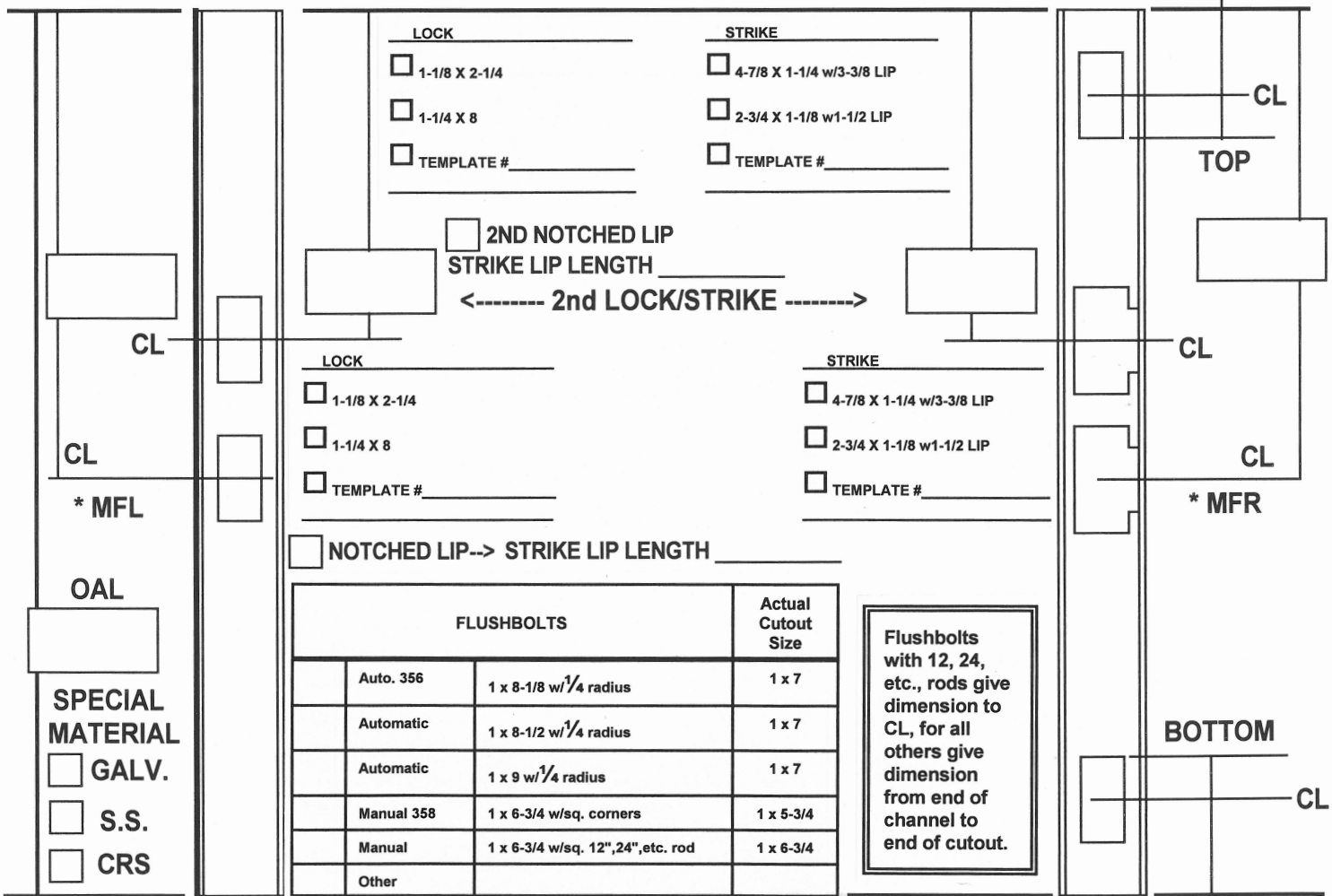

SPECIAL MATERIAL

GALV.

S.S.

CRS

GAGE: _____

(*) This Information is for MACHINING REFERENCE ONLY

2/21/12

ALL METAL STAMPING, INC., ABBOTSFORD, WI. 54405

715-223-6324

FAX: 715-223-3352

AMS USE ONLY

Please Check One: 211 217A 218 226 RH/LHR ACTIVE

CUSTOMER: _____

DOOR #: _____

P.O.: _____ DATE: _____

M.O.: _____

ACCESSORY ITEM #: _____ DOOR ITEM: _____

NO. of SETS REQ.: _____ DATE REQ.: _____ DRAWN BY: _____ DATE: _____

STD. BEIGE SPECIAL COLOR: _____ NO PAINT VENEER: _____

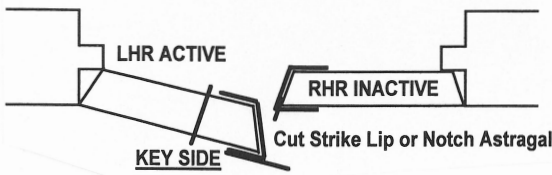

Lead Lined Astragal flange cannot be notched.

LEAD LINED ASTRAGAL
LIP WIDTH: _____
 1/16" LEAD 1/8" LEAD

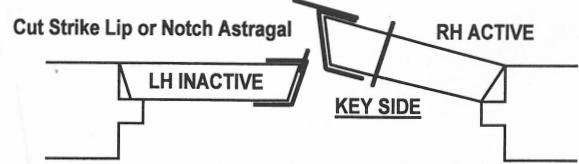

ALL DIMENSIONS ARE FROM TOP OF DOOR.

ACTIVE DOOR

INACTIVE DOOR

DOOR: 1-3/4" 1-13/16" OTHER: _____

SQUARE <-----Mark for Square Channel-----> SQUARE

CL CL * MFR OAL SPECIAL MATERIAL <input type="checkbox"/> GALV. <input type="checkbox"/> S.S. <input type="checkbox"/> CRS	LOCK <input type="checkbox"/> 1-1/8 X 2-1/4 <input type="checkbox"/> 1-1/4 X 8 <input type="checkbox"/> TEMPLATE # _____	STRIKE <input type="checkbox"/> 4-7/8 X 1-1/4 w/3-3/8 LIP <input type="checkbox"/> 2-3/4 X 1-1/8 w1-1/2 LIP <input type="checkbox"/> TEMPLATE # _____	CL TOP CL CL * MFL BOTTOM CL																					
	<input type="checkbox"/> 2ND NOTCHED LIP STRIKE LIP LENGTH _____ <----- 2nd LOCK/STRIKE ----->	STRIKE <input type="checkbox"/> 4-7/8 X 1-1/4 w/3-3/8 LIP <input type="checkbox"/> 2-3/4 X 1-1/8 w1-1/2 LIP <input type="checkbox"/> TEMPLATE # _____																						
	LOCK <input type="checkbox"/> 1-1/8 X 2-1/4 <input type="checkbox"/> 1-1/4 X 8 <input type="checkbox"/> TEMPLATE # _____	STRIKE <input type="checkbox"/> 4-7/8 X 1-1/4 w/3-3/8 LIP <input type="checkbox"/> 2-3/4 X 1-1/8 w1-1/2 LIP <input type="checkbox"/> TEMPLATE # _____																						
	<input type="checkbox"/> NOTCHED LIP--> STRIKE LIP LENGTH _____																							
	<table border="1"> <thead> <tr> <th colspan="2">FLUSHBOLTS</th> <th>Actual Cutout Size</th> </tr> </thead> <tbody> <tr> <td>Auto. 356</td> <td>1 x 8-1/8 w/1/4 radius</td> <td>1 x 7</td> </tr> <tr> <td>Automatic</td> <td>1 x 8-1/2 w/1/4 radius</td> <td>1 x 7</td> </tr> <tr> <td>Automatic</td> <td>1 x 9 w/1/4 radius</td> <td>1 x 7</td> </tr> <tr> <td>Manual 358</td> <td>1 x 6-3/4 w/sq. corners</td> <td>1 x 5-3/4</td> </tr> <tr> <td>Manual</td> <td>1 x 6-3/4 w/sq. 12", 24", etc. rod</td> <td>1 x 6-3/4</td> </tr> <tr> <td>Other</td> <td></td> <td></td> </tr> </tbody> </table>		FLUSHBOLTS		Actual Cutout Size	Auto. 356	1 x 8-1/8 w/1/4 radius	1 x 7	Automatic	1 x 8-1/2 w/1/4 radius	1 x 7	Automatic	1 x 9 w/1/4 radius	1 x 7	Manual 358	1 x 6-3/4 w/sq. corners	1 x 5-3/4	Manual	1 x 6-3/4 w/sq. 12", 24", etc. rod	1 x 6-3/4	Other			<div style="border: 1px solid black; padding: 5px;"> Flushbolts with 12, 24, etc., rods give dimension to CL, for all others give dimension from end of channel to end of cutout. </div>
FLUSHBOLTS		Actual Cutout Size																						
Auto. 356	1 x 8-1/8 w/1/4 radius	1 x 7																						
Automatic	1 x 8-1/2 w/1/4 radius	1 x 7																						
Automatic	1 x 9 w/1/4 radius	1 x 7																						
Manual 358	1 x 6-3/4 w/sq. corners	1 x 5-3/4																						
Manual	1 x 6-3/4 w/sq. 12", 24", etc. rod	1 x 6-3/4																						
Other																								

GAGE: _____

(*) This Information is for MACHINING REFERENCE ONLY



Please Check One: 213 STANDARD BEVEL 214 SQUARE LH/RHR ACTIVE

CUSTOMER: _____

DOOR #: _____

P.O.: _____ DATE: _____

M.O.: _____

ACCESSORY ITEM #: _____ DOOR ITEM: _____

NO. of PCS. REQ.: _____ DATE REQ.: _____ DRAWN BY: _____ DATE: _____

STD. BEIGE SPECIAL COLOR: _____ NO PAINT VENEER: _____

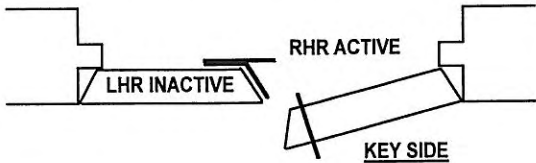

LEAD LINED ASTRAGAL
LIP WIDTH: _____
 1/16" LEAD 1/8" LEAD

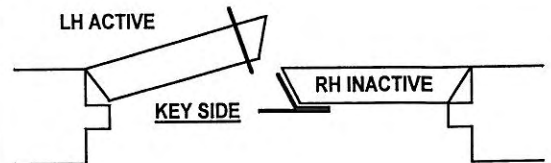

ALL DIMENSIONS ARE FROM TOP OF DOOR.

INACTIVE DOOR

SQUARE <-----Mark for Square Channel #214

STILE WIDTH _____ 1-5/8" Standard

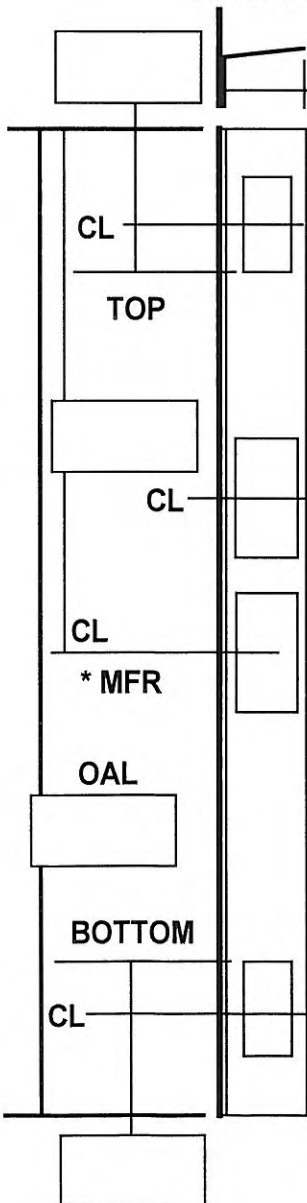

STRIKE
 4-7/8 X 1-1/4 w/NO LIP
 2-3/4 X 1-1/8 w/NO LIP
 TEMPLATE # _____

NO LIP FOR SHIPPING STRENGTH

SPECIAL MATERIAL
 GALV.
 S.S.
 CRS



STRIKE
 4-7/8 X 1-1/4 w/NO LIP
 2-3/4 X 1-1/8 w/NO LIP
 TEMPLATE # _____

NO LIP FOR SHIPPING STRENGTH

GAGE: _____

Flushbolts with 12, 24, etc., rods give dimension to CL, for all others give dimension from end of channel to end of cutout.

FLUSHBOLTS		Actual Cutout Size
Auto. 356	1 x 8-1/8 w/1/4 radius	1 x 7
Automatic	1 x 8-1/2 w/1/4 radius	1 x 7
Automatic	1 x 9 w/1/4 radius	1 x 7
Manual 358	1 x 6-3/4 w/sq. corners	1 x 6-3/4
Manual	1 x 6-3/4 w/sq. 12",24",etc. rod	1 x 6-3/4
Other		

(* This Information is for MACHINING REFERENCE ONLY

9/28/04

ALL METAL STAMPING, INC., ABBOTSFORD, WI. 54405

AMS USE ONLY

715-223-6324

"T" ASTRAGAL

FAX: 715-223-3352



Please Check One: 213 STANDARD BEVEL 214 SQUARE RH/LHR ACTIVE

CUSTOMER: _____ DOOR #: _____

P.O.: _____ DATE: _____

M.O.: _____

ACCESSORY ITEM #: _____ DOOR ITEM: _____

NO. of PCS. REQ.: _____ DATE REQ.: _____ DRAWN BY: _____ DATE: _____

STD. BEIGE SPECIAL COLOR: _____ NO PAINT VENEER: _____

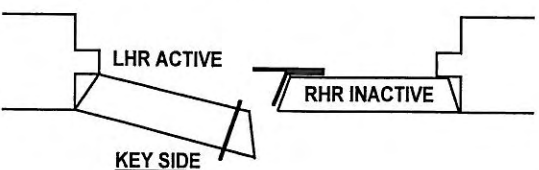

LEAD LINED ASTRAGAL
LIP WIDTH: _____
 1/16" LEAD 1/8" LEAD

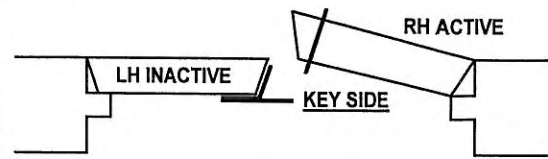

ALL DIMENSIONS ARE FROM TOP OF DOOR.

INACTIVE DOOR

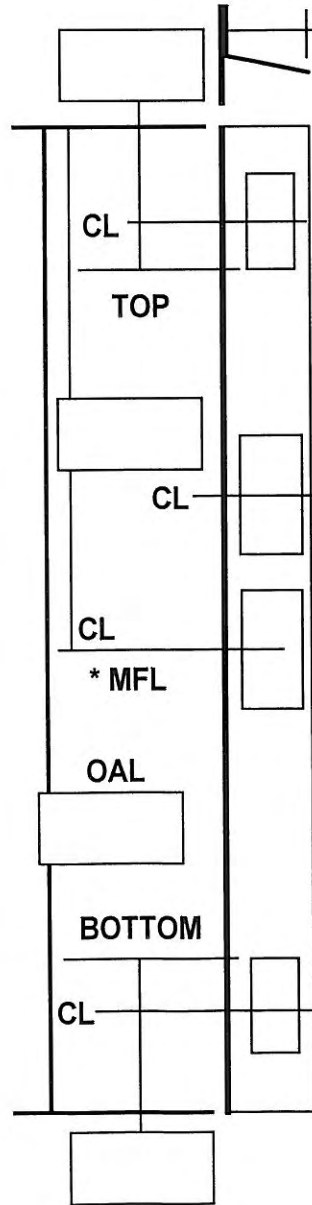

STILE WIDTH _____ 1-5/8" Standard
 SQUARE <-----Mark for Square Channel #214

STRIKE
 4-7/8 X 1-1/4 w/NO LIP
 2-3/4 X 1-1/8 w/NO LIP
 TEMPLATE # _____

NO LIP FOR SHIPPING STRENGTH

SPECIAL MATERIAL
 GALV.
 S.S.
 CRS

<----- 2nd STRIKE

STRIKE
 4-7/8 X 1-1/4 w/NO LIP
 2-3/4 X 1-1/8 w/NO LIP
 TEMPLATE # _____

GAGE: _____

Flushbolts with 12, 24, etc., rods give dimension to CL, for all others give dimension from end of channel to end of cutout.

FLUSHBOLTS			Actual Cutout Size
Auto. 356	1 x 8-1/8 w/1/4 radius		1 x 7
Automatic	1 x 8-1/2 w/1/4 radius		1 x 7
Automatic	1 x 9 w/1/4 radius		1 x 7
Manual 358	1 x 6-3/4 w/sq. corners		1 x 5-3/4
Manual	1 x 6-3/4 w/sq. 12", 24", etc. rod		1 x 6-3/4
Other			

(* This Information is for MACHINING REFERENCE ONLY



Please Check One: 229 REVERSE BEVEL 214 SQUARE LH/RHR ACTIVE
 CUSTOMER: _____ DOOR #: _____

P.O.: _____ DATE: _____

M.O.: _____

ACCESSORY ITEM #: _____ DOOR ITEM: _____

NO. of PCS. REQ.: _____ DATE REQ.: _____ DRAWN BY: _____ DATE: _____

STD. BEIGE SPECIAL COLOR: _____ NO PAINT VENEER: _____

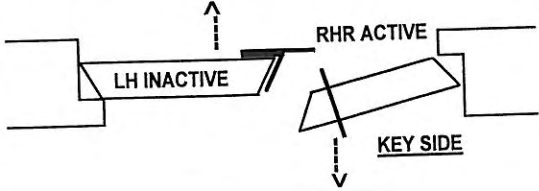

LEAD LINED ASTRAGAL
 LIP WIDTH: _____
 1/16" LEAD 1/8" LEAD

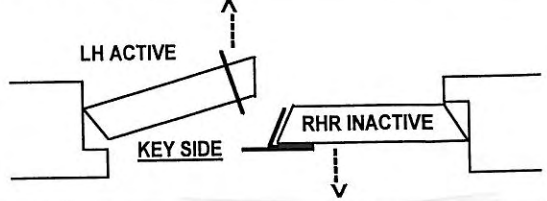

ALL DIMENSIONS ARE FROM TOP OF DOOR.

INACTIVE DOOR

SQUARE <-----Mark for Square Channel #214

STILE WIDTH _____ 1-5/8" Standard

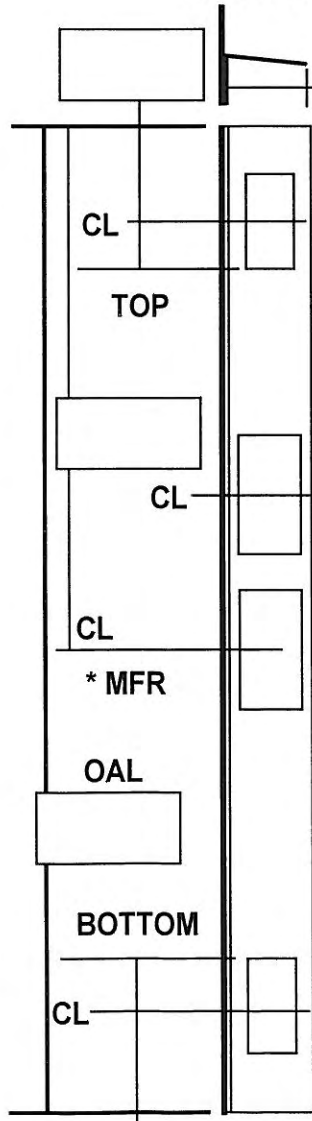

STRIKE
 4-7/8 X 1-1/4 w/NO LIP
 2-3/4 X 1-1/8 w/NO LIP
 TEMPLATE # _____

NO LIP FOR
 SHIPPING
 STRENGTH

SPECIAL MATERIAL
 GALV.
 S.S.
 CRS

<----- 2nd STRIKE

STRIKE
 4-7/8 X 1-1/4 w/NO LIP
 2-3/4 X 1-1/8 w/NO LIP
 TEMPLATE # _____

NO LIP FOR
 SHIPPING
 STRENGTH

GAGE: _____

Flushbolts with 12, 24, etc., rods give dimension to CL, for all others give dimension from end of channel to end of cutout.

FLUSHBOLTS		Actual Cutout Size
Auto. 356	1 x 8-1/8 w/1/4 radius	1 x 7
Automatic	1 x 8-1/2 w/1/4 radius	1 x 7
Automatic	1 x 9 w/1/4 radius	1 x 7
Manual 358	1 x 6-3/4 w/sq. corners	1 x 5-3/4
Manual	1 x 6-3/4 w/sq. 12", 24", etc. rod	1 x 6-3/4
Other		

(*) This Information is for MACHINING REFERENCE ONLY

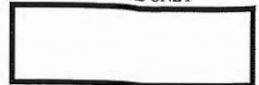

Please Check One: 229 REVERSE BEVEL 214 SQUARE RH/LHR ACTIVE
 CUSTOMER: _____ DOOR #: _____

P.O.: _____ DATE: _____

M.O.: _____

ACCESSORY ITEM #: _____ DOOR ITEM: _____

NO. of PCS. REQ.: _____ DATE REQ.: _____ DRAWN BY: _____ DATE: _____

STD. BEIGE SPECIAL COLOR: _____ NO PAINT VENEER: _____

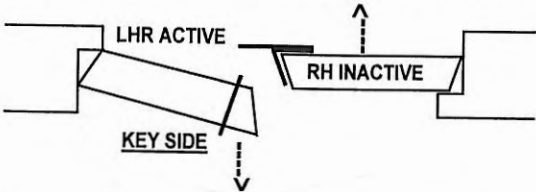

LEAD LINED ASTRAGAL
 LIP WIDTH: _____
 1/16" LEAD 1/8" LEAD

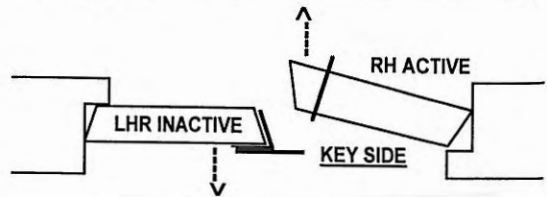

ALL DIMENSIONS ARE FROM TOP OF DOOR.

INACTIVE DOOR

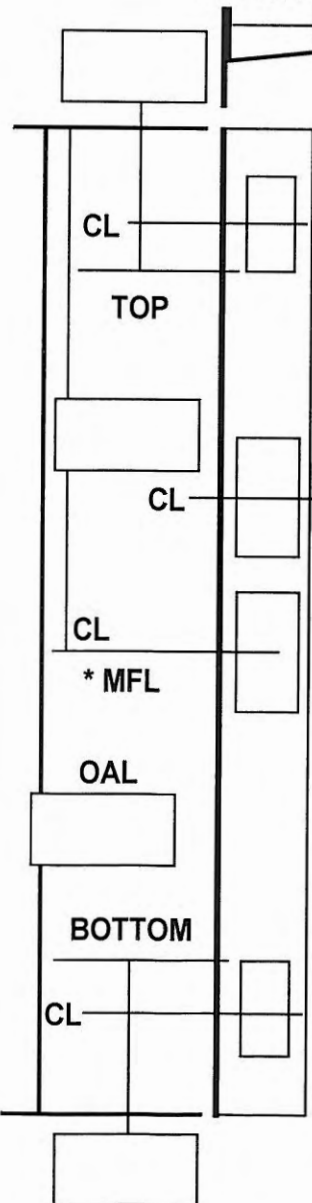

STILE WIDTH _____ 1-5/8" Standard

SQUARE <-----Mark for Square Channel #214

STRIKE

- 4-7/8 X 1-1/4 w/NO LIP NO LIP FOR SHIPPING
- 2-3/4 X 1-1/8 w/NO LIP STRENGTH
- TEMPLATE # _____

SPECIAL MATERIAL

- GALV.
- S.S.
- CRS

<----- 2nd STRIKE

GAGE: _____

STRIKE

- 4-7/8 X 1-1/4 w/NO LIP NO LIP FOR SHIPPING
- 2-3/4 X 1-1/8 w/NO LIP STRENGTH
- TEMPLATE # _____

Flushbolts with 12, 24, etc., rods give dimension to CL, for all others give dimension from end of channel to end of cutout.

FLUSHBOLTS			Actual Cutout Size
Auto. 356	1 x 8-1/8 w/1/4 radius		1 x 7
Automatic	1 x 8-1/2 w/1/4 radius		1 x 7
Automatic	1 x 9 w/1/4 radius		1 x 7
Manual 358	1 x 6-3/4 w/sq. corners		1 x 5-3/4
Manual	1 x 6-3/4 w/sq. 12", 24", etc. rod		1 x 6-3/4
Other			

(* This Information is for MACHINING REFERENCE ONLY

2/21/12

ALL METAL STAMPING, INC., ABBOTSFORD, WI. 54405
715-223-6324 "T" ASTRAGAL FAX: 715-223-3352

AMS USE ONLY



Please Check One: 229A REVERSE BEVEL 214A SQUARE LH/RHR ACTIVE

CUSTOMER: _____ DOOR #: _____

P.O.: _____ DATE: _____

M.O.: _____

ACCESSORY ITEM #: _____ DOOR ITEM: _____

NO. of PCS. REQ.: _____ DATE REQ.: _____ DRAWN BY: _____ DATE: _____

STD. BEIGE SPECIAL COLOR: _____ NO PAINT VENEER: _____

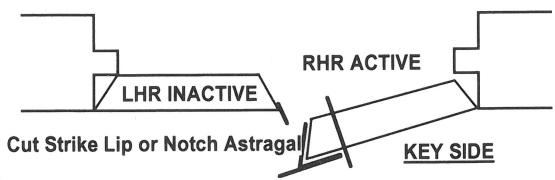

Lead Lined Astragal flange cannot be notched.
 LEAD LINED ASTRAGAL
LIP WIDTH: _____
 1/16" LEAD 1/8" LEAD

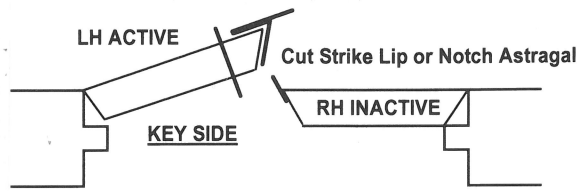

ALL DIMENSIONS ARE FROM TOP OF DOOR.

ACTIVE DOOR

SQUARE <-----Mark for Square Channel #214A

STILE WIDTH _____ 1-5/8" Standard

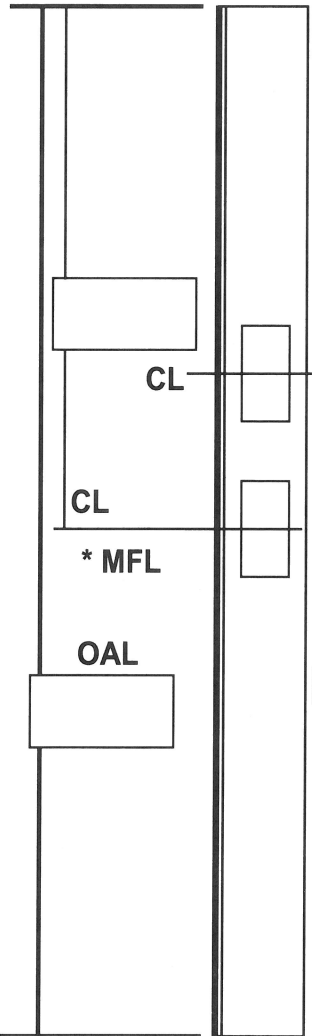

Lock

1-1/8 X 2-1/4

1-1/4 X 8

TEMPLATE # _____

2ND NOTCHED LIP

STRIKE LIP LENGTH _____

CL of Strike _____

2nd LOCK

Lock

1-1/8 X 2-1/4

1-1/4 X 8

TEMPLATE # _____

NOTCHED LIP--> STRIKE LIP LENGTH _____

CL of the STRIKE to locate LIP location _____

SPECIAL MATERIAL

GALV.

S.S.

CRS

GAGE: _____

(*) This Information is for MACHINING REFERENCE ONLY

2/21/12

ALL METAL STAMPING, INC., ABBOTSFORD, WI. 54405
715-223-6324 "T" ASTRAGAL FAX: 715-223-3352

AMS USE ONLY



Please Check One: 229A REVERSE BEVEL 214A SQUARE RH/LHR ACTIVE

CUSTOMER: _____ DOOR #: _____

P.O.: _____ DATE: _____

M.O.: _____

ACCESSORY ITEM #: _____ DOOR ITEM: _____

NO. of PCS. REQ.: _____ DATE REQ.: _____ DRAWN BY: _____ DATE: _____

STD. BEIGE SPECIAL COLOR: _____ NO PAINT VENEER: _____

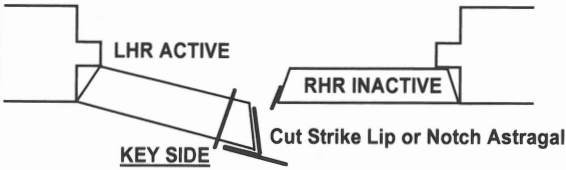

Lead Lined Astragal flange cannot be notched.
 LEAD LINED ASTRAGAL
LIP WIDTH: _____
 1/16" LEAD 1/8" LEAD

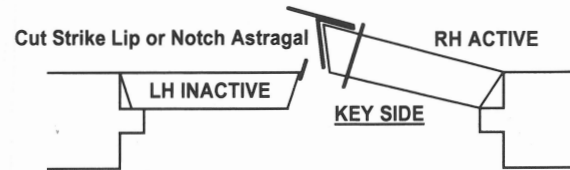

ALL DIMENSIONS ARE FROM TOP OF DOOR.

ACTIVE DOOR

STILE WIDTH _____ 1-5/8" Standard
 SQUARE <-----Mark for Square Channel #214A

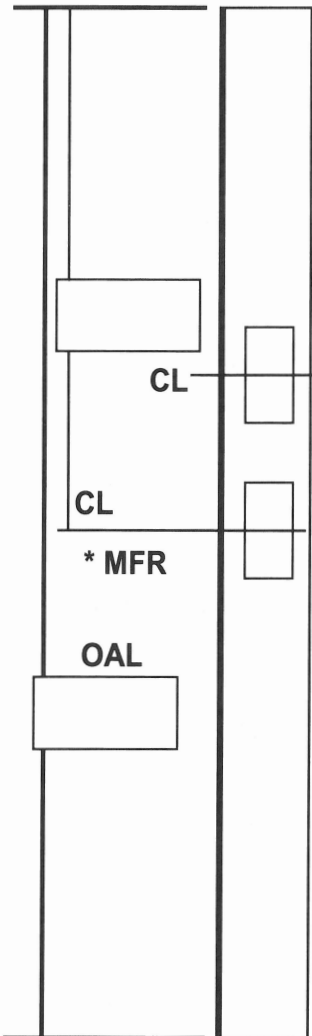

Lock _____
 1-1/8 X 2-1/4
 1-1/4 X 8
 TEMPLATE # _____

2ND NOTCHED LIP
STRIKE LIP LENGTH _____
CL of Strike _____
2nd LOCK

Lock _____
 1-1/8 X 2-1/4
 1-1/4 X 8
 TEMPLATE # _____

NOTCHED LIP--> STRIKE LIP LENGTH _____
CL of the STRIKE to locate LIP location _____

SPECIAL MATERIAL
 GALV.
 S.S.
 CRS

GAGE: _____

(*) This Information is for MACHINING REFERENCE ONLY

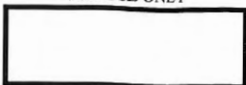

Please Check One: 237 SQUARE 238 STD. BEVEL LH/RHR ACTIVE

CUSTOMER: _____ DOOR #: _____

P.O.: _____ DATE: _____

M.O.: _____

ACCESSORY ITEM #: _____ DOOR ITEM: _____

NO. of SETS REQ.: _____ DATE REQ.: _____ DRAWN BY: _____ DATE: _____

STD. BEIGE SPECIAL COLOR: _____ NO PAINT VENEER: _____



ALL DIMENSIONS ARE FROM TOP OF DOOR.

INACTIVE DOOR

<- Astragal Lip

DOOR: 1-3/4" 1-13/16" OTHER: _____

SQUARE <-----Mark for Square Channel #237

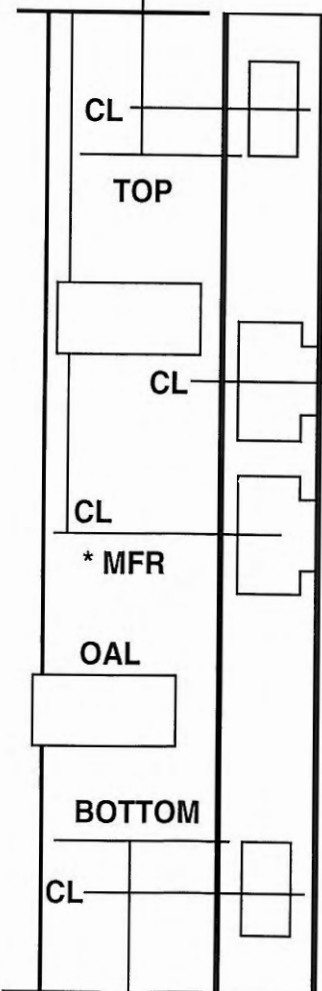

STRIKE _____
 4-7/8 X 1-1/4 w/3-3/8 LIP
 2-3/4 X 1-1/8 w1-1/2 LIP
 TEMPLATE # _____

<----- 2nd STRIKE

STRIKE _____
 4-7/8 X 1-1/4 w/3-3/8 LIP
 2-3/4 X 1-1/8 w1-1/2 LIP
 TEMPLATE # _____

SPECIAL MATERIAL
 GALV.
 S.S.
 CRS

GAGE: _____

Flushbolts with 12, 24, etc., rods give dimension to CL, for all others give dimension from end of channel to end of cutout.

FLUSHBOLTS		Actual Cutout Size
Auto. 356	1 x 8-1/8 w/1/4 radius	1 x 7
Automatic	1 x 8-1/2 w/1/4 radius	1 x 7
Automatic	1 x 9 w/1/4 radius	1 x 7
Manual 358	1 x 6-3/4 w/sq. corners	1 x 5-3/4
Manual	1 x 6-3/4 w/sq. 12", 24", etc. rod	1 x 6-3/4
Other		

(*) This Information is for MACHINING REFERENCE ONLY

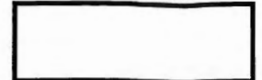

Please Check One: 237 SQUARE 238 STD. BEVEL RH/LHR ACTIVE

CUSTOMER: _____ DOOR #: _____

P.O.: _____ DATE: _____

M.O.: _____

ACCESSORY ITEM #: _____ DOOR ITEM: _____

NO. of SETS REQ.: _____ DATE REQ.: _____ DRAWN BY: _____ DATE: _____

STD. BEIGE SPECIAL COLOR: _____ NO PAINT VENEER: _____

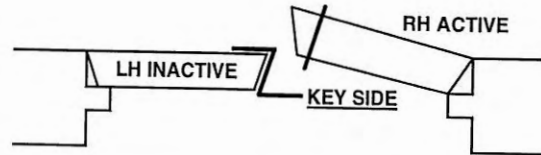
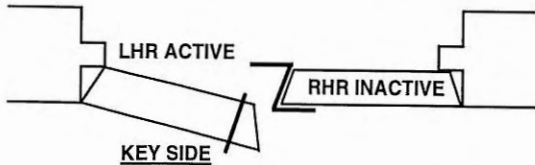

ALL DIMENSIONS ARE FROM TOP OF DOOR.

INACTIVE DOOR

DOOR: 1-3/4" 1-13/16" OTHER: _____
 <-- Astragal Lip SQUARE <-----Mark for Square Channel #237

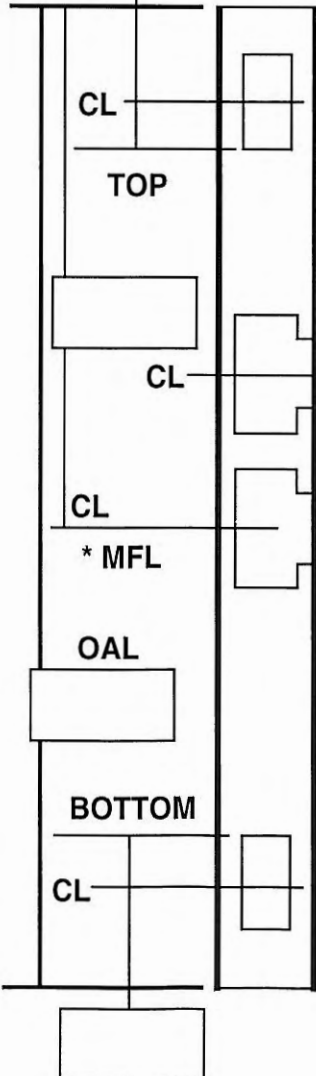

STRIKE
 4-7/8 X 1-1/4 w/3-3/8 LIP
 2-3/4 X 1-1/8 w1-1/2 LIP
 TEMPLATE # _____

<----- 2nd STRIKE

STRIKE
 4-7/8 X 1-1/4 w/3-3/8 LIP
 2-3/4 X 1-1/8 w1-1/2 LIP
 TEMPLATE # _____

SPECIAL MATERIAL
 GALV.
 S.S.
 CRS

GAGE: _____

Flushbolts with 12, 24, etc., rods give dimension to CL, for all others give dimension from end of channel to end of cutout.

FLUSHBOLTS		Actual Cutout Size
Auto. 356	1 x 8-1/8 w/¼ radius	1 x 7
Automatic	1 x 8-1/2 w/¼ radius	1 x 7
Automatic	1 x 9 w/¼ radius	1 x 7
Manual 358	1 x 6-3/4 w/sq. corners	1 x 5-3/4
Manual	1 x 6-3/4 w/sq. 12",24",etc. rod	1 x 6-3/4
Other		

(* This Information is for MACHINING REFERENCE ONLY

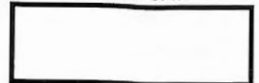

Please Check One: 237 SQUARE 239 REVERSE BEVEL LH/RHR ACTIVE

CUSTOMER: _____ DOOR #: _____

P.O.: _____ DATE: _____

M.O.: _____

ACCESSORY ITEM #: _____ DOOR ITEM: _____

NO. of SETS REQ.: _____ DATE REQ.: _____ DRAWN BY: _____ DATE: _____

STD. BEIGE SPECIAL COLOR: _____ NO PAINT VENEER: _____

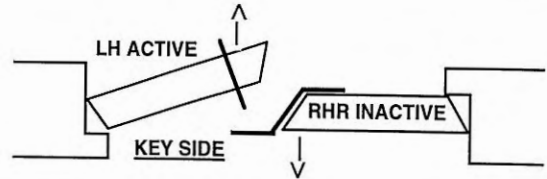
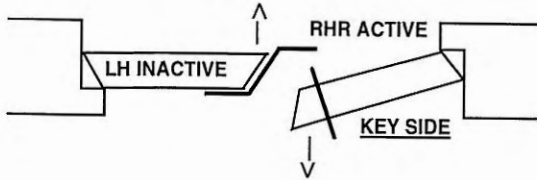

ALL DIMENSIONS ARE FROM TOP OF DOOR.

INACTIVE DOOR

<-Astragal Lip

DOOR: 1-3/4" 1-13/16" OTHER: _____

SQUARE <-----Mark for Square Channel #237

STRIKE

- 4-7/8 X 1-1/4 w/3-3/8 LIP
- 2-3/4 X 1-1/8 w1-1/2 LIP
- TEMPLATE # _____

<----- 2nd STRIKE

STRIKE

- 4-7/8 X 1-1/4 w/3-3/8 LIP
- 2-3/4 X 1-1/8 w1-1/2 LIP
- TEMPLATE # _____

SPECIAL MATERIAL

- GALV.
- S.S.
- CRS

GAGE: _____

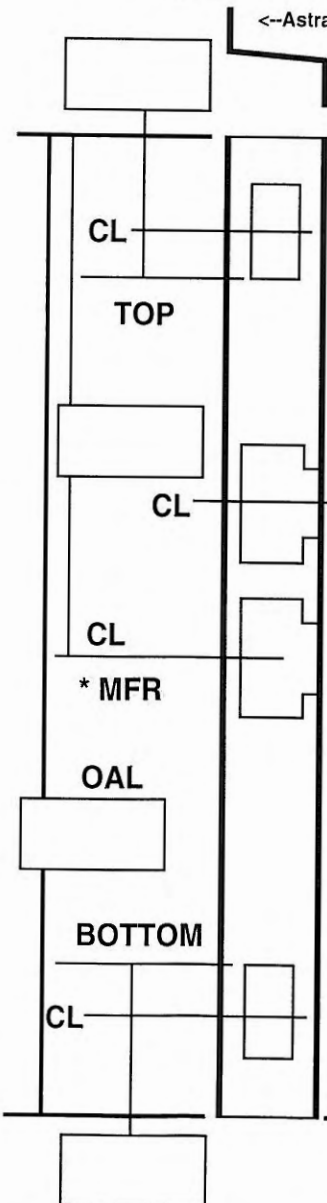

Flushbolts with 12, 24, etc., rods give dimension to CL, for all others give dimension from end of channel to end of cutout.

FLUSHBOLTS		Actual Cutout Size
Auto. 356	1 x 8-1/8 w/1/4 radius	1 x 7
Automatic	1 x 8-1/2 w/1/4 radius	1 x 7
Automatic	1 x 9 w/1/4 radius	1 x 7
Manual 358	1 x 6-3/4 w/sq. corners	1 x 5-3/4
Manual	1 x 6-3/4 w/sq. 12", 24", etc. rod	1 x 6-3/4
Other		

(* This Information is for MACHINING REFERENCE ONLY

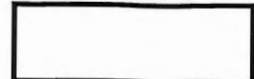

Please Check One: 237 SQUARE 239 REVERSE BEVEL RH/LHR ACTIVE

CUSTOMER: _____ DOOR #: _____

P.O.: _____ DATE: _____

M.O.: _____

ACCESSORY ITEM #: _____ DOOR ITEM: _____

NO. of SETS REQ.: _____ DATE REQ.: _____ DRAWN BY: _____ DATE: _____

STD. BEIGE SPECIAL COLOR: _____ NO PAINT VENEER: _____

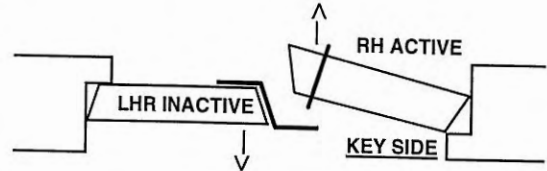
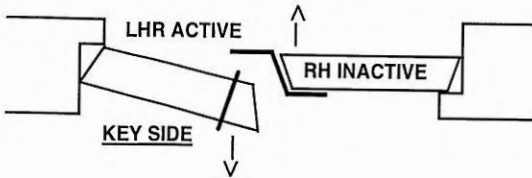

ALL DIMENSIONS ARE FROM TOP OF DOOR.

INACTIVE DOOR

DOOR: 1-3/4" 1-13/16" OTHER: _____

<-- Astragal Lip

SQUARE <-----Mark for Square Channel #237

STRIKE

4-7/8 X 1-1/4 w/3-3/8 LIP

2-3/4 X 1-1/8 w/1-1/2 LIP

TEMPLATE # _____

<----- 2nd STRIKE

STRIKE

4-7/8 X 1-1/4 w/3-3/8 LIP

2-3/4 X 1-1/8 w/1-1/2 LIP

TEMPLATE # _____

SPECIAL MATERIAL

GALV.

S.S.

CRS

GAGE: _____

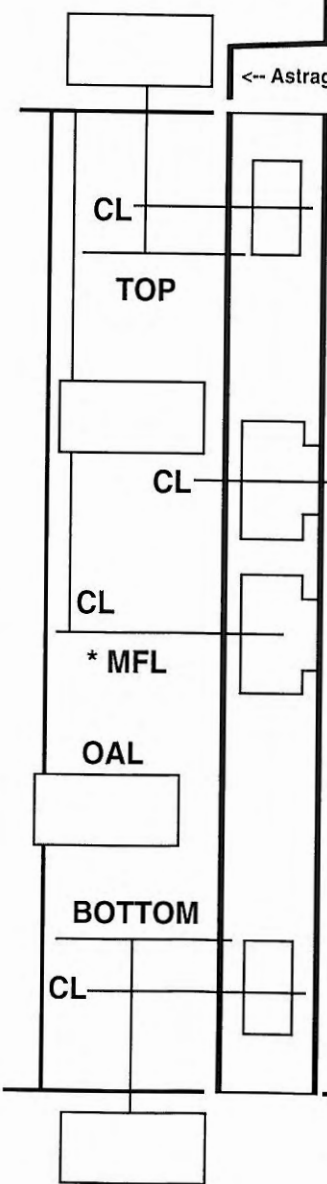

Flushbolts with 12, 24, etc., rods give dimension to CL, for all others give dimension from end of channel to end of cutout.

FLUSHBOLTS		Actual Cutout Size
Auto. 356	1 x 8-1/8 w/1/4 radius	1 x 7
Automatic	1 x 8-1/2 w/1/4 radius	1 x 7
Automatic	1 x 9 w/1/4 radius	1 x 7
Manual 358	1 x 6-3/4 w/sq. corners	1 x 5-3/4
Manual	1 x 6-3/4 w/sq. 12", 24", etc. rod	1 x 6-3/4
Other		

(*) This Information is for MACHINING REFERENCE ONLY

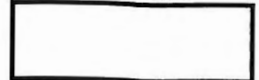

Please Check One: 237A SQUARE 239A REVERSE BEVEL LH/RHR ACTIVE

CUSTOMER: _____ DOOR #: _____

P.O.: _____ DATE: _____

M.O.: _____

ACCESSORY ITEM #: _____ DOOR ITEM: _____

NO. of SETS REQ.: _____ DATE REQ.: _____ DRAWN BY: _____ DATE: _____

STD. BEIGE SPECIAL COLOR: _____ NO PAINT VENEER: _____



ALL DIMENSIONS ARE FROM TOP OF DOOR.

ACTIVE DOOR

Astragal Lip-> DOOR: 1-3/4" 1-13/16" OTHER: _____
 SQUARE <-----Mark for Square Channel #237A

- LOCK _____
 1-1/8 X 2-1/4
 1-1/4 X 8
 TEMPLATE # _____

2ND NOTCHED LIP
 STRIKE LIP LENGTH _____
 <----- 2nd LOCK

- LOCK _____
 1-1/8 X 2-1/4
 1-1/4 X 8
 TEMPLATE # _____

NOTCHED LIP--> STRIKE LIP LENGTH _____

- SPECIAL MATERIAL**
 GALV.
 S.S.
 CRS

GAGE: _____

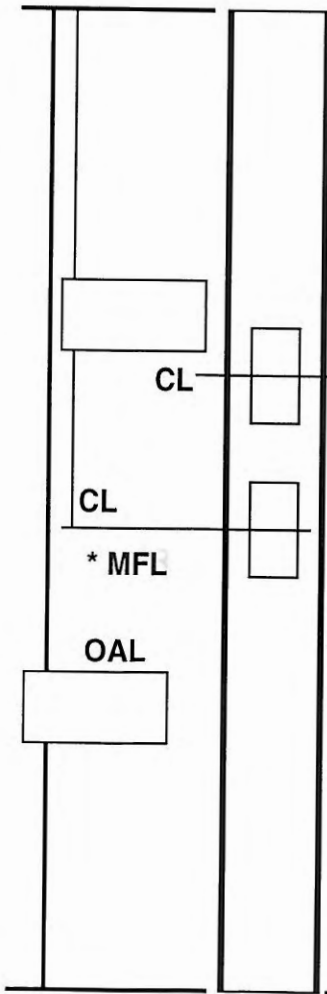

(*) This Information is for MACHINING REFERENCE ONLY



Please Check One: 237A SQUARE 239A REVERSE BEVEL RH/LHR ACTIVE

CUSTOMER: _____ DOOR #: _____

P.O.: _____ DATE: _____

M.O.: _____

ACCESSORY ITEM #: _____ DOOR ITEM: _____

NO. of SETS REQ.: _____ DATE REQ.: _____ DRAWN BY: _____ DATE: _____

STD. BEIGE SPECIAL COLOR: _____ NO PAINT VENEER: _____

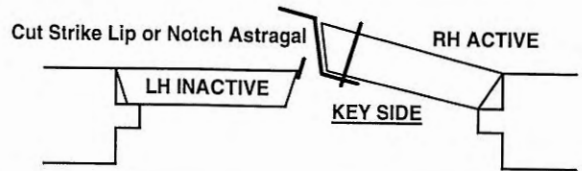
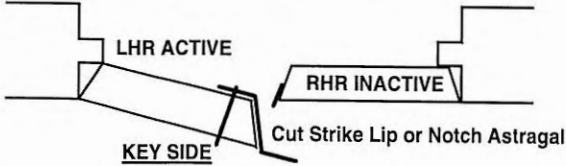

ALL DIMENSIONS ARE FROM TOP OF DOOR.

ACTIVE DOOR

DOOR: 1-3/4" 1-13/16" OTHER: _____

<-- Astragal Lip SQUARE <-----Mark for Square Channel #237A

LOCK _____

1-1/8 X 2-1/4

1-1/4 X 8

TEMPLATE # _____

2ND NOTCHED LIP
 STRIKE LIP LENGTH _____
 <----- 2nd LOCK

LOCK _____

1-1/8 X 2-1/4

1-1/4 X 8

TEMPLATE # _____

NOTCHED LIP--> STRIKE LIP LENGTH _____

SPECIAL MATERIAL

GALV.

S.S.

CRS

GAGE: _____

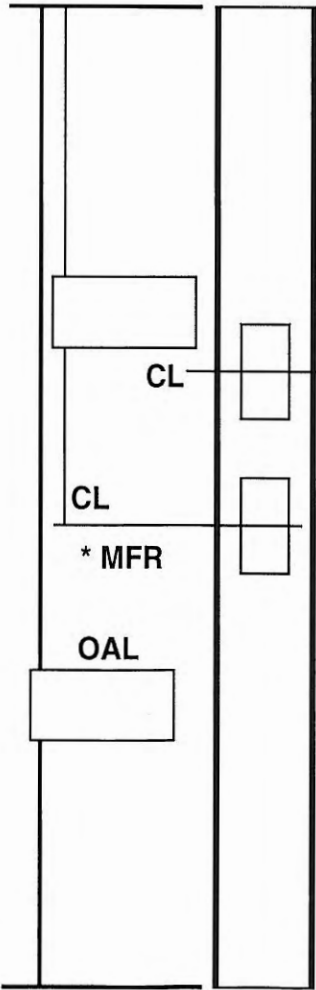

(* This Information is for MACHINING REFERENCE ONLY

8/15/03

ALL METAL STAMPING, INC., ABBOTSFORD, WI. 54405
715-223-6324

FAX: 715-223-3352

Please Check One: 206 216 LOCK EDGE PROTECTORS

CUSTOMER: _____ DOOR #: _____

P.O.: _____ DATE: _____

M.O.: _____

ACCESSORY ITEM #: _____ DOOR ITEM: _____

DATE REQ.: _____ DRAWN BY: _____ DATE: _____

STD. BEIGE SPECIAL COLOR: _____ NO PAINT VENEER: _____

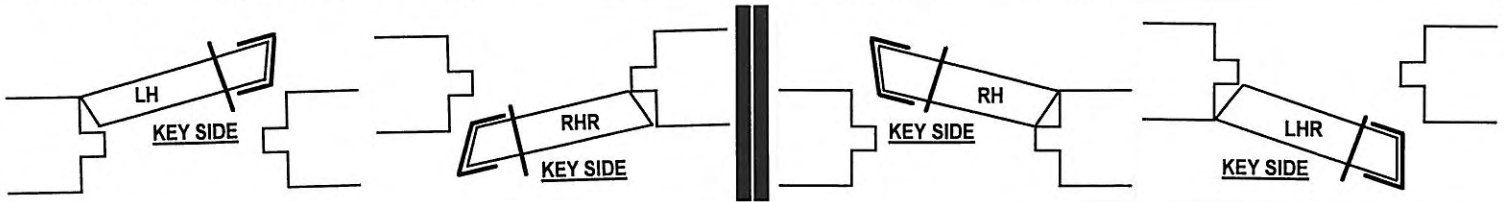

LH/RHR TOP VIEW

For SINGLE SWING DOORS ONLY

RH/LHR TOP VIEW

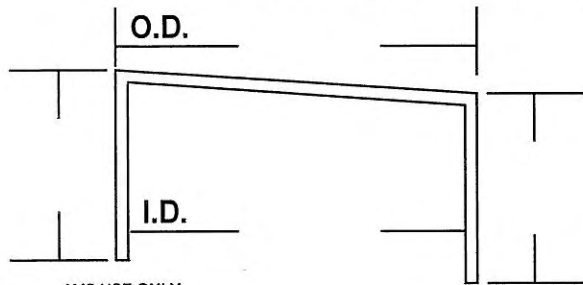

SPECIAL MATERIAL

S.S

GALV.

CRS

20 GA. (.035) STANDARD

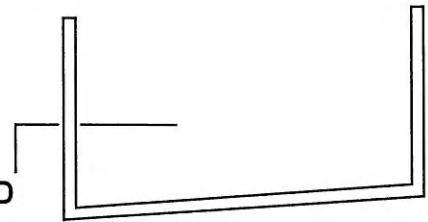

AMS USE ONLY

AMS USE ONLY

GAGE: _____

Mark for SQUARE Channel #216

PCS. REQ. LH

PCS. REQ. RH

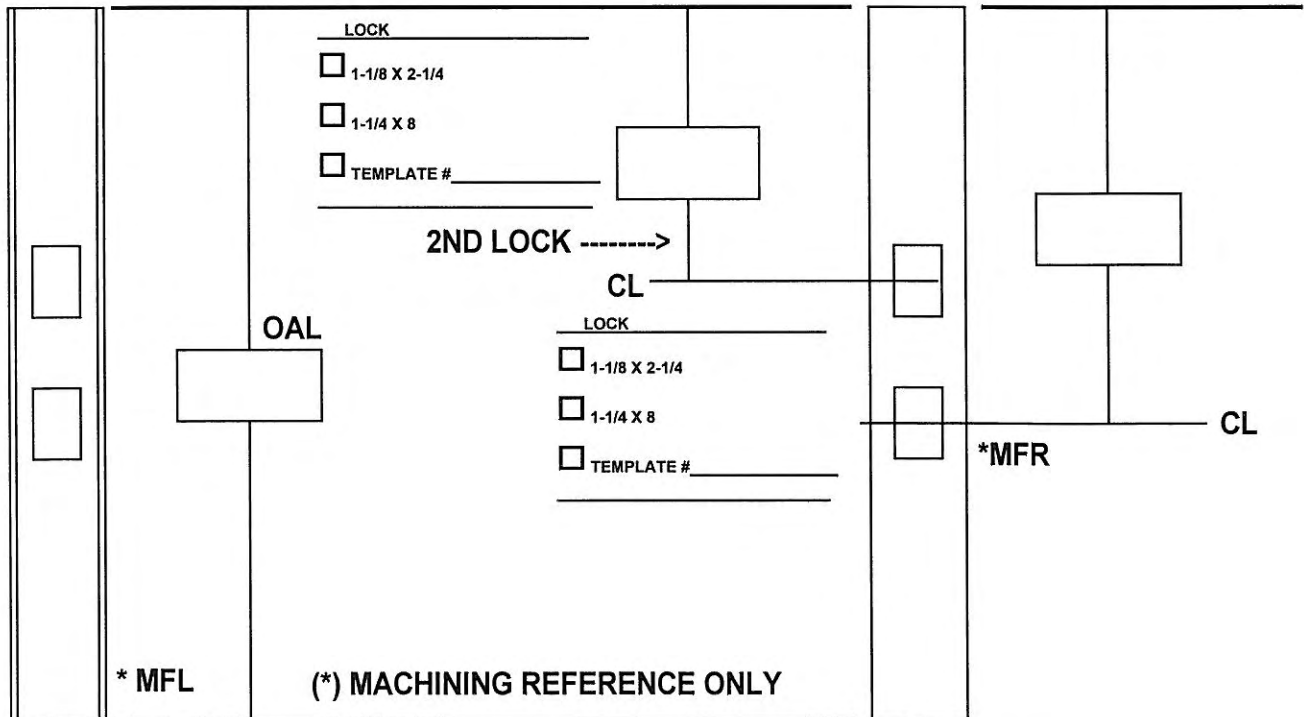

8/15/03

ALL METAL STAMPING, INC., ABBOTSFORD, WI. 54405
715-223-6324 FAX: 715-223-3352

Please Check One: 231 233 "L" LOCK EDGE PROTECTORS

CUSTOMER: _____ DOOR #: _____

P.O.: _____ DATE: _____

M.O.: _____

ACCESSORY ITEM #: _____ DOOR ITEM: _____

DATE REQ.: _____ DRAWN BY: _____ DATE: _____

STD. BEIGE SPECIAL COLOR: _____ NO PAINT VENEER: _____

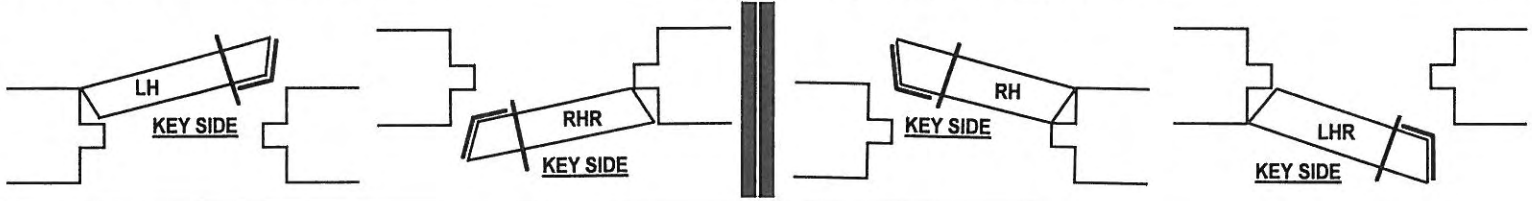

LH/RHR TOP VIEW

For SINGLE SWING DOORS ONLY

RH/LHR TOP VIEW

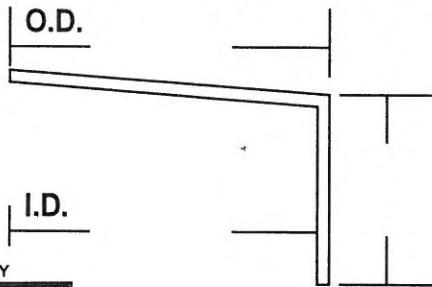

- SPECIAL MATERIAL
- S.S
 - GALV.
 - CRS

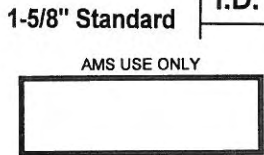
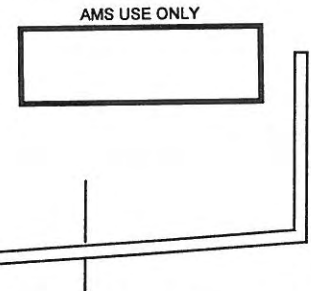

GAGE: _____

20 GA. (.035) STANDARD

Mark for SQUARE Channel #233

PCS. REQ. LH

PCS. REQ. RH

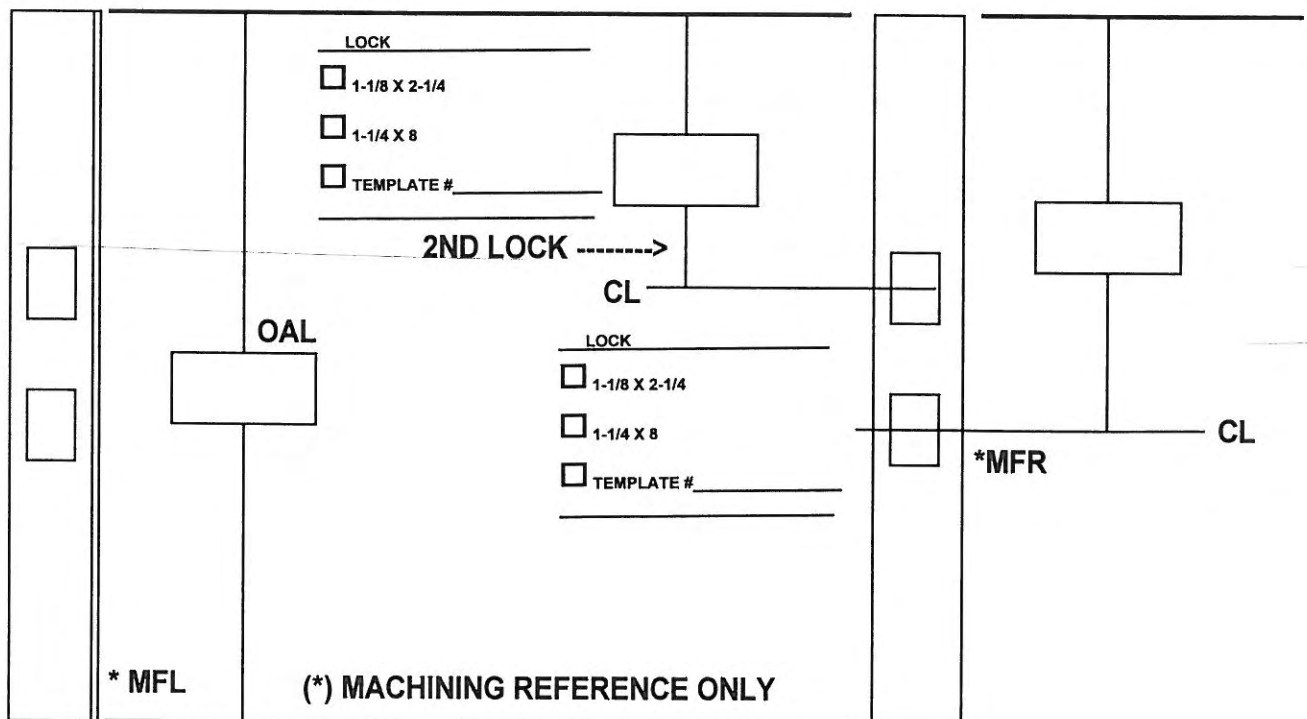

8/15/03

ALL METAL STAMPING, INC., ABBOTSFORD, WI. 54405

715-223-6324

FAX: 715-223-3352

Please Check One: 230 234 "U" HINGE EDGE PROTECTORS

CUSTOMER: _____

DOOR #: _____

P.O.: _____ DATE: _____

M.O.: _____

ACCESSORY ITEM #: _____ DOOR ITEM: _____

DATE REQ.: _____ DRAWN BY: _____ DATE: _____

STD. BEIGE SPECIAL COLOR: _____ NO PAINT VENEER: _____

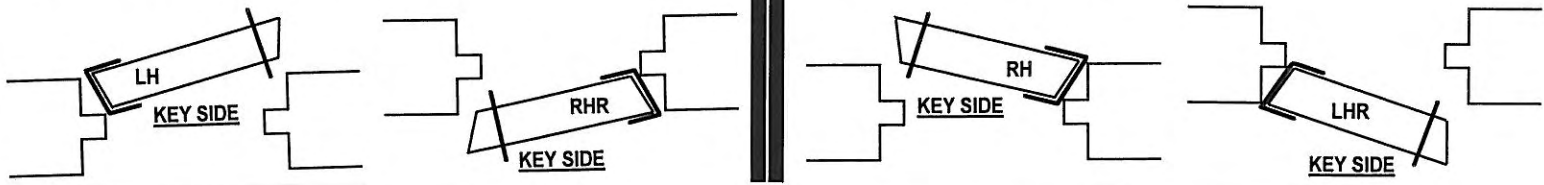

LH/RHR TOP VIEW

ALL DIMENSIONS ARE FROM TOP OF DOOR

RH/LHR TOP VIEW

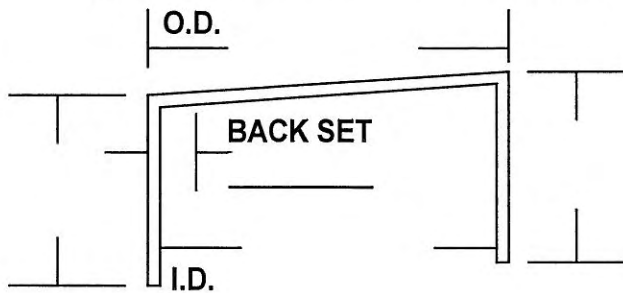

SPECIAL MATERIAL

S.S

GALV.

CRS

20 GA. (.035) STANDARD

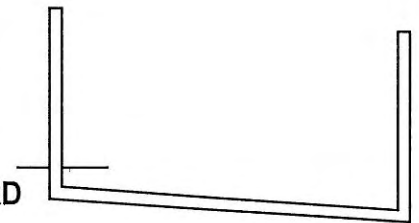

AMS USE ONLY

AMS USE ONLY box

GAGE: _____

AMS USE ONLY

AMS USE ONLY box

Mark for SQUARE Channel #234

PCS. REQ. LH

PCS. REQ. RH

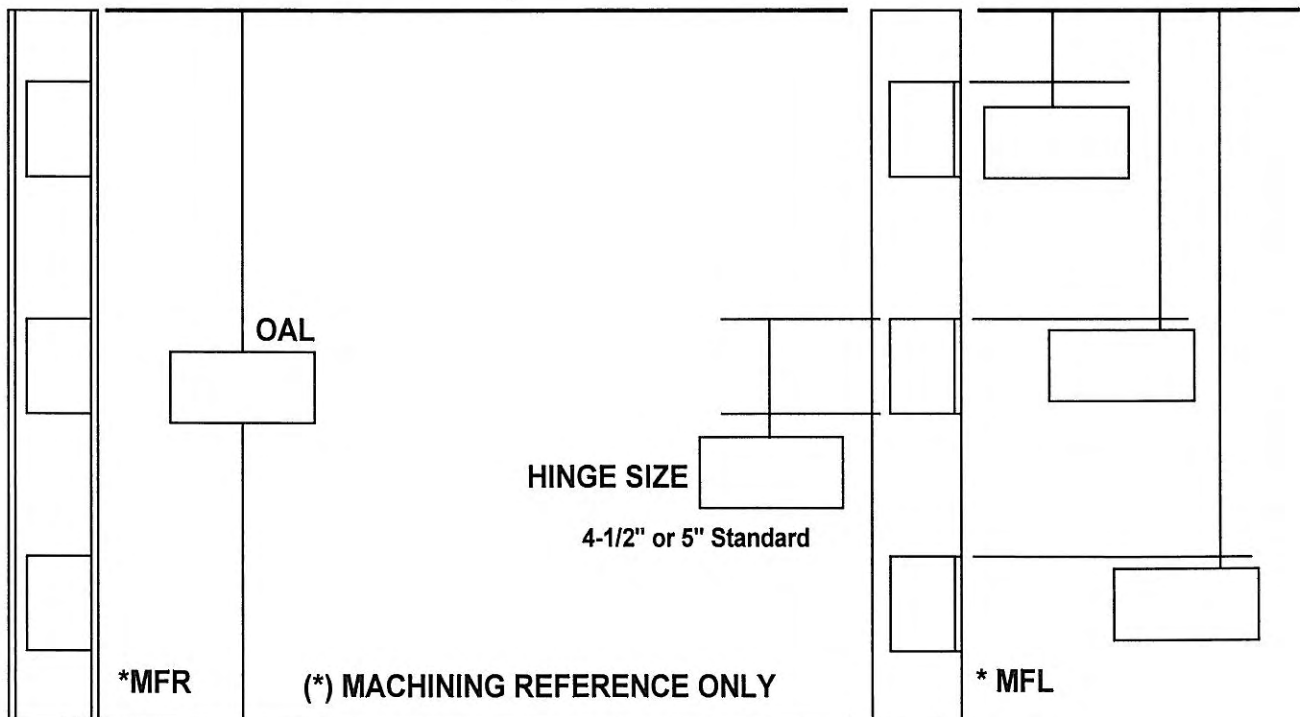

*MFR

(*) MACHINING REFERENCE ONLY

* MFL

8/15/03

ALL METAL STAMPING, INC., ABBOTSFORD, WI. 54405

715-223-6324

FAX: 715-223-3352

Please Check One: 232 235 "L" HINGE EDGE PROTECTORS

CUSTOMER: _____

DOOR #: _____

P.O.: _____ DATE: _____

M.O.: _____

ACCESSORY ITEM #: _____ DOOR ITEM: _____

DATE REQ.: _____ DRAWN BY: _____ DATE: _____

STD. BEIGE SPECIAL COLOR: _____ NO PAINT VENEER: _____

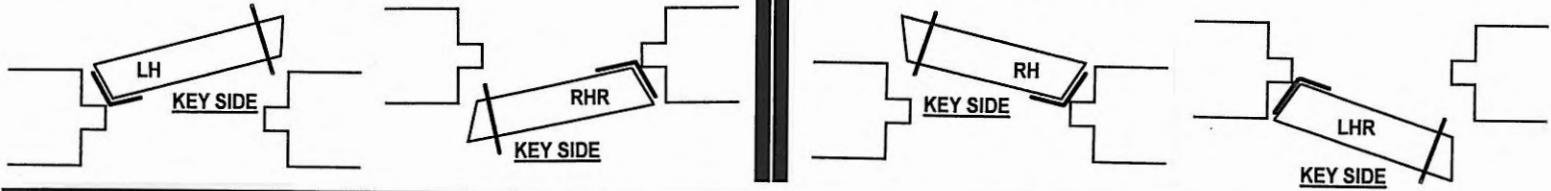

LH/RHR TOP VIEW

ALL DIMENSIONS ARE FROM TOP OF DOOR

RH/LHR TOP VIEW

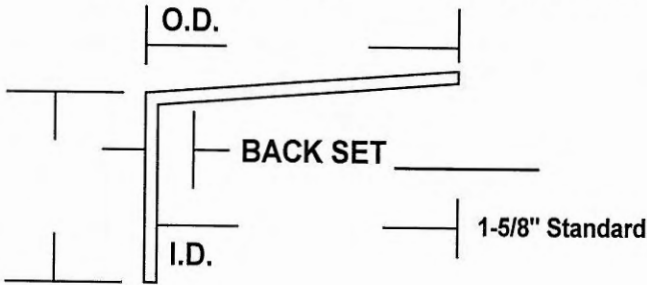

- SPECIAL MATERIAL
- S.S
 - GALV.
 - CRS

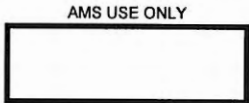
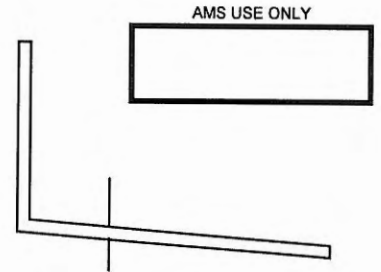

GAGE: _____

20 GA. (.035) STANDARD

Mark for SQUARE Channel #235

_____ PCS. REQ. LH

_____ PCS. REQ. RH

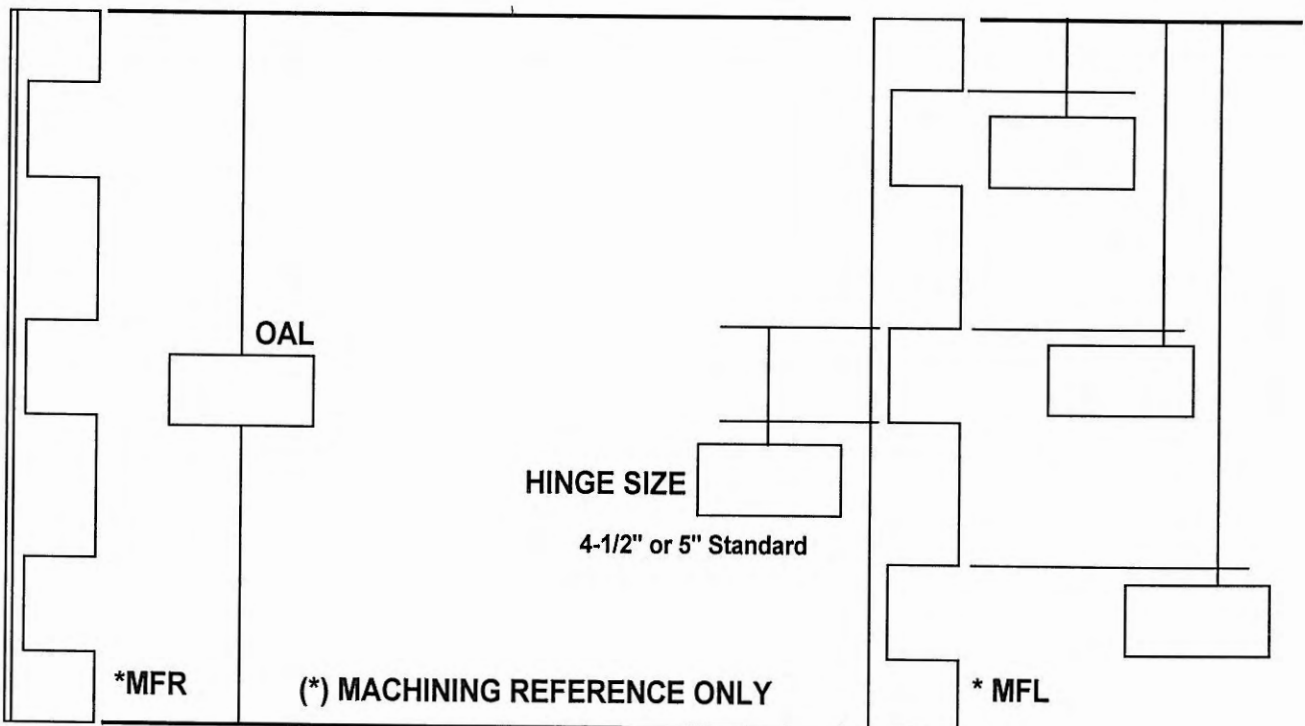

#250 DOOR EDGE w/5" LEGS - LH/RHR ACTIVE

CUSTOMER: _____

DOOR #: _____

P.O.: _____ DATE: _____

M.O.: _____

ACCESSORY ITEM #: _____ DOOR ITEM: _____

NO. of SETS REQ.: _____ DATE REQ.: _____ DRAWN BY: _____ DATE: _____

STD. BEIGE SPECIAL COLOR: _____ NO PAINT VENEER: _____

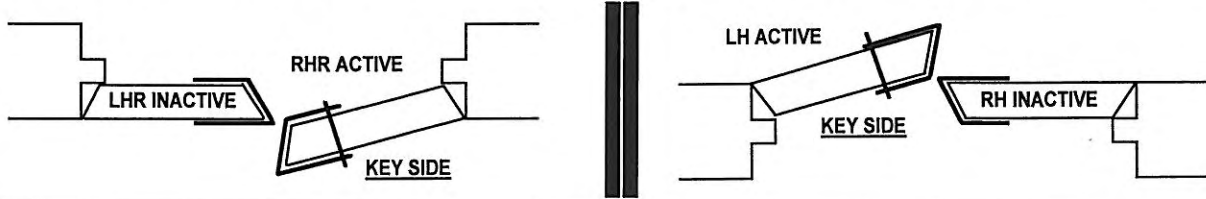

SQUARE ←----- MARK FOR SQUARE CHANNEL -----> SQUARE

DOOR SIZE:

- 1-3/4"
- 1-13/16"
- 2-1/4"
- _____
OTHER

LOCK

- 1-1/8 X 2-1/4
- 1-1/4 X 8
- TEMPLATE # _____

STRIKE

- 4-7/8 X 1-1/4 w/3-3/8 LIP
- 2-3/4 X 1-1/8 w/1-1/2 LIP
- TEMPLATE # _____

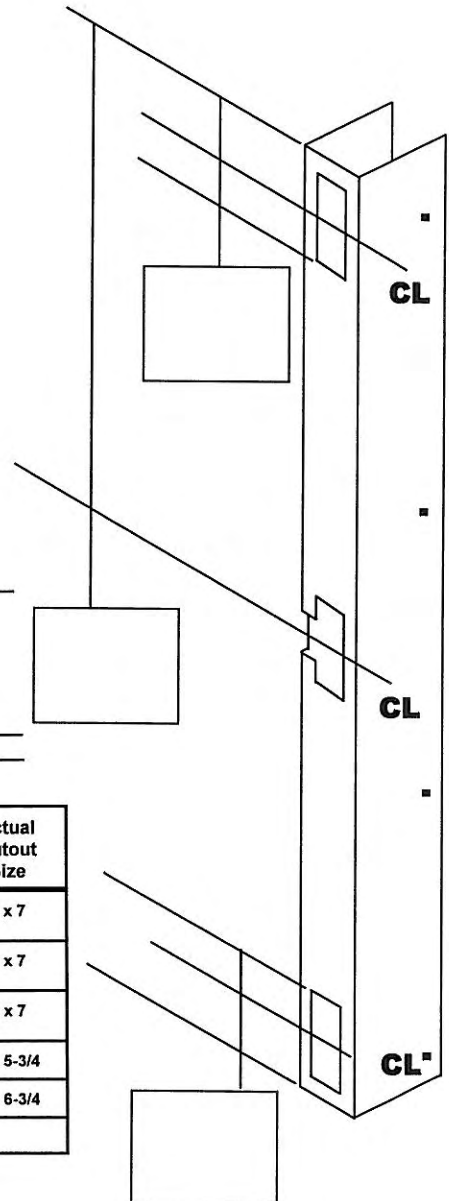
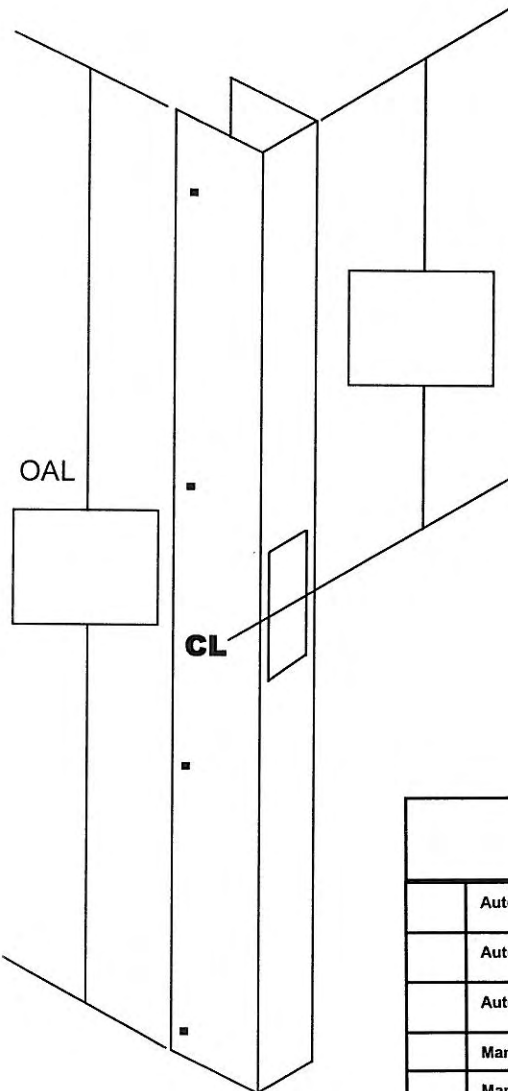

FLUSHBOLTS			Actual Cutout Size
Auto. 356	1 x 8-1/8 w/1/4 radius		1 x 7
Automatic	1 x 8-1/2 w/1/4 radius		1 x 7
Automatic	1 x 9 w/1/4 radius		1 x 7
Manual 358	1 x 6-3/4 w/sq. corners		1 x 5-3/4
Manual	1 x 6-3/4 w/sq. 12",24",etc. rod		1 x 6-3/4
Other			



#250 DOOR EDGE w/5" LEGS - RH/LHR ACTIVE

CUSTOMER: _____

DOOR #: _____

P.O.: _____ DATE: _____

M.O.: _____

ACCESSORY ITEM #: _____ DOOR ITEM: _____

NO. of SETS REQ.: _____ DATE REQ.: _____ DRAWN BY: _____ DATE: _____

STD. BEIGE SPECIAL COLOR: _____ NO PAINT VENEER: _____

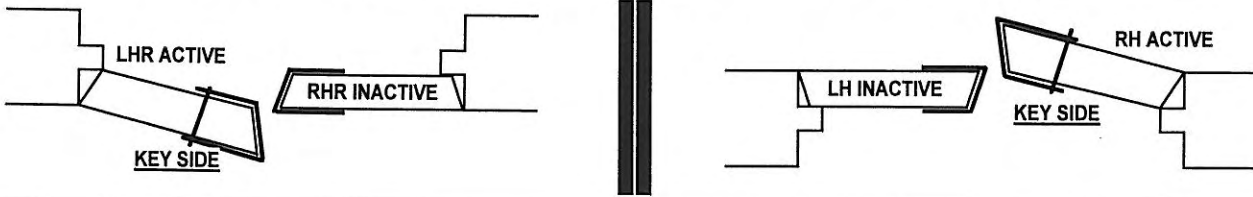

SQUARE ←----- MARK FOR SQUARE CHANNEL -----> SQUARE

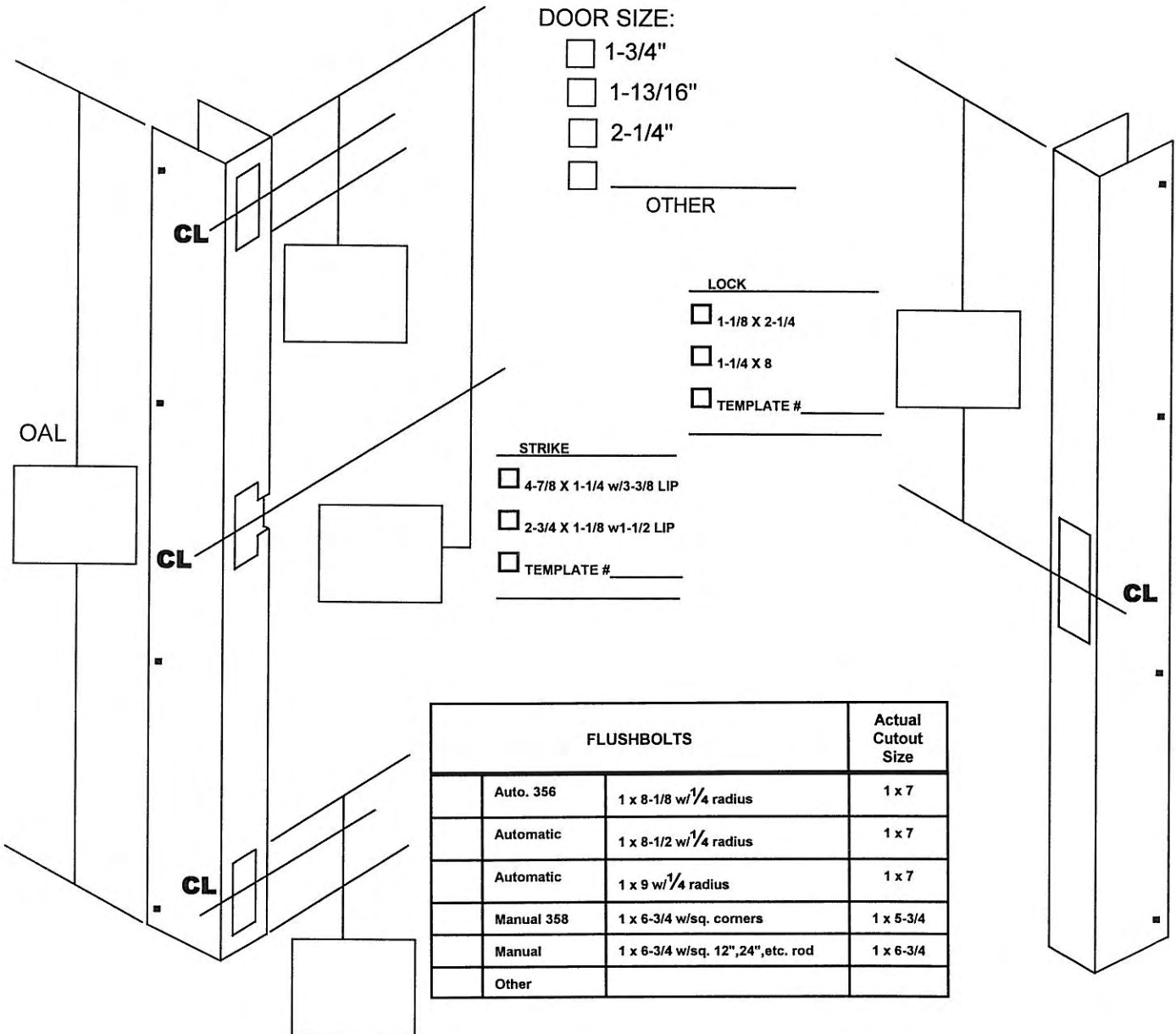



ALL METAL STAMPING, INC.

411 WEST SPRUCE, P.O. BOX 485, ABBOTSFORD, WI. 54405
PHONE: 715-223-6324 FAX: 715-223-3352
EMAIL: AllMetal@AllMetalStamping.com

Machining Templates for Style #222 Dutch Door Edge & Astragal Sets

There are four (4) Machining Templates for Dutch Door Edge & Astragal Sets, two (2) for LH/RHR doors and two (2) for RH/LHR doors. The difference in the two (2) LH/RHR and the two (2) RH/LHR is determined by whether the Strike or Lock is on the Astragal Edge. When completing the templates all measurements should be taken from the lock edge side of the door.

The following steps should be used to select the correct template from the four.

1. Determine whether the door is LH/RHR or RH/LHR. This will eliminate two (2) of the templates.
2. Determine whether the Strike or Lock will be on the Astragal Edge. This will eliminate one of the templates leaving the correct template by elimination.
3. Determine whether the Astragal Edge will be installed on the top or bottom leaf of the Dutch Door. Both views are shown on the template.
4. Check the box for the correct Lock and Strike Punchouts or check the template box and provide a detail sheet.
5. Complete all dimensions from the Lock Edge of the door to the center line of the lock and strike punchouts desired. Remember to include the overall length and the number of sets required.
6. Complete the information section of the form and submit it with your order.

If you require assistance in completing these electronic forms please call and ask for Customer Service at your convenience.

Thank You for your business.



CUSTOMER: _____ DOOR #: _____

P.O.: _____ DATE: _____

M.O.: _____

ACCESSORY ITEM #: _____ DOOR ITEM: _____

NO. of SETS REQ.: _____ DATE REQ.: _____ DRAWN BY: _____ DATE: _____

STD. BEIGE SPECIAL COLOR: _____ NO PAINT VENEER: _____

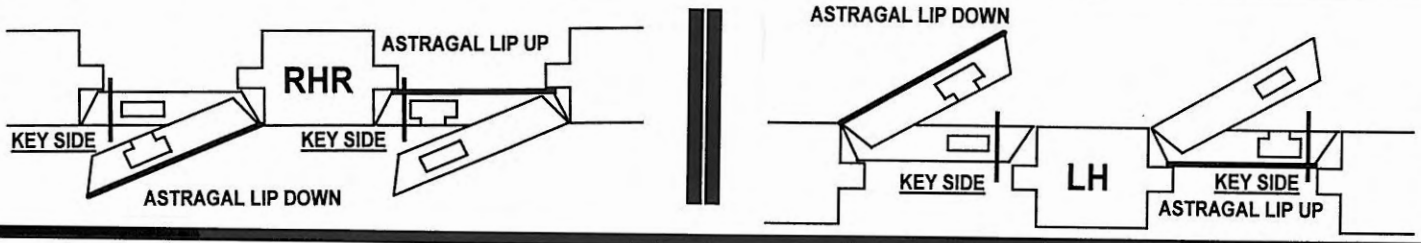

ALL DIMENSIONS ARE FROM LOCK EDGE OF DOOR.

ASTRAGAL

EDGE

DOOR: 1-3/4" 1-13/16" OTHER: _____

#204

DUTCH DOOR TEMPLATE

#216

SPECIAL MATERIAL

- GALV.
- S.S.
- CRS

GAGE: _____

STRIKE

- 4-7/8 X 1-1/4 w/3-3/8 LIP
- 2-3/4 X 1-1/8 w/1-1/2 LIP
- TEMPLATE # _____

LOCK

- 1-1/8 X 2-1/4
- 1-1/4 X 8
- TEMPLATE # _____

OAL

CL

CL

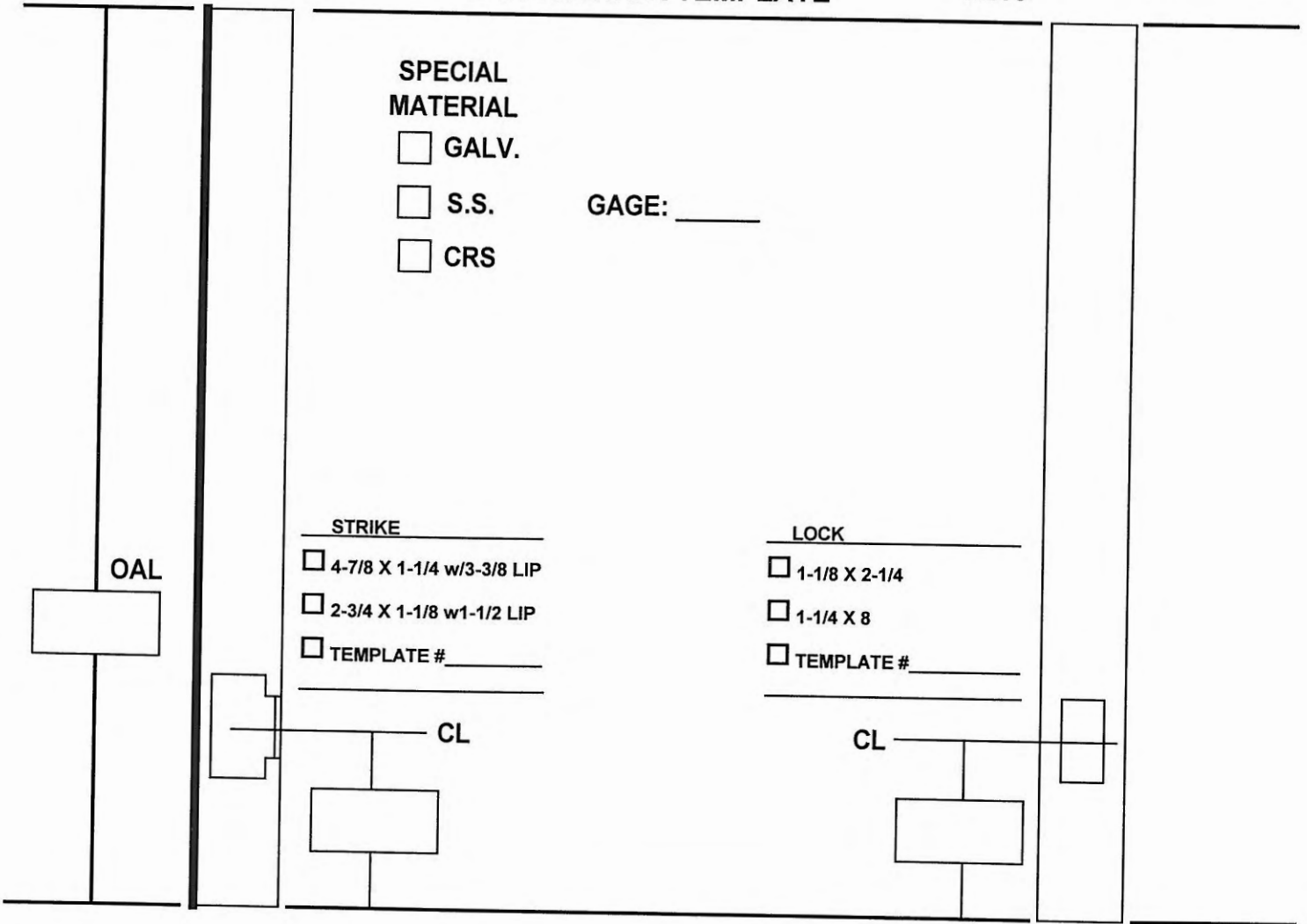



CUSTOMER: _____ DOOR #: _____

P.O.: _____ DATE: _____

M.O.: _____

ACCESSORY ITEM #: _____ DOOR ITEM: _____

NO. of SETS REQ.: _____ DATE REQ.: _____ DRAWN BY: _____ DATE: _____

STD. BEIGE SPECIAL COLOR: _____ NO PAINT VENEER: _____

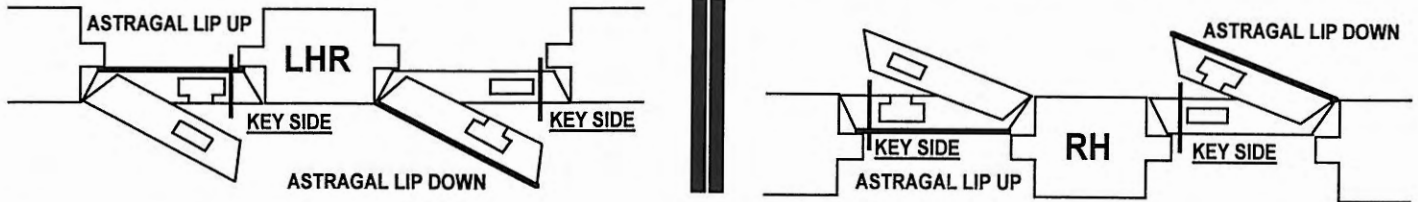

ALL DIMENSIONS ARE FROM LOCK EDGE OF DOOR.

ASTRAGAL

EDGE

DOOR: 1-3/4" 1-13/16" OTHER: _____

#204

DUTCH DOOR TEMPLATE

#216

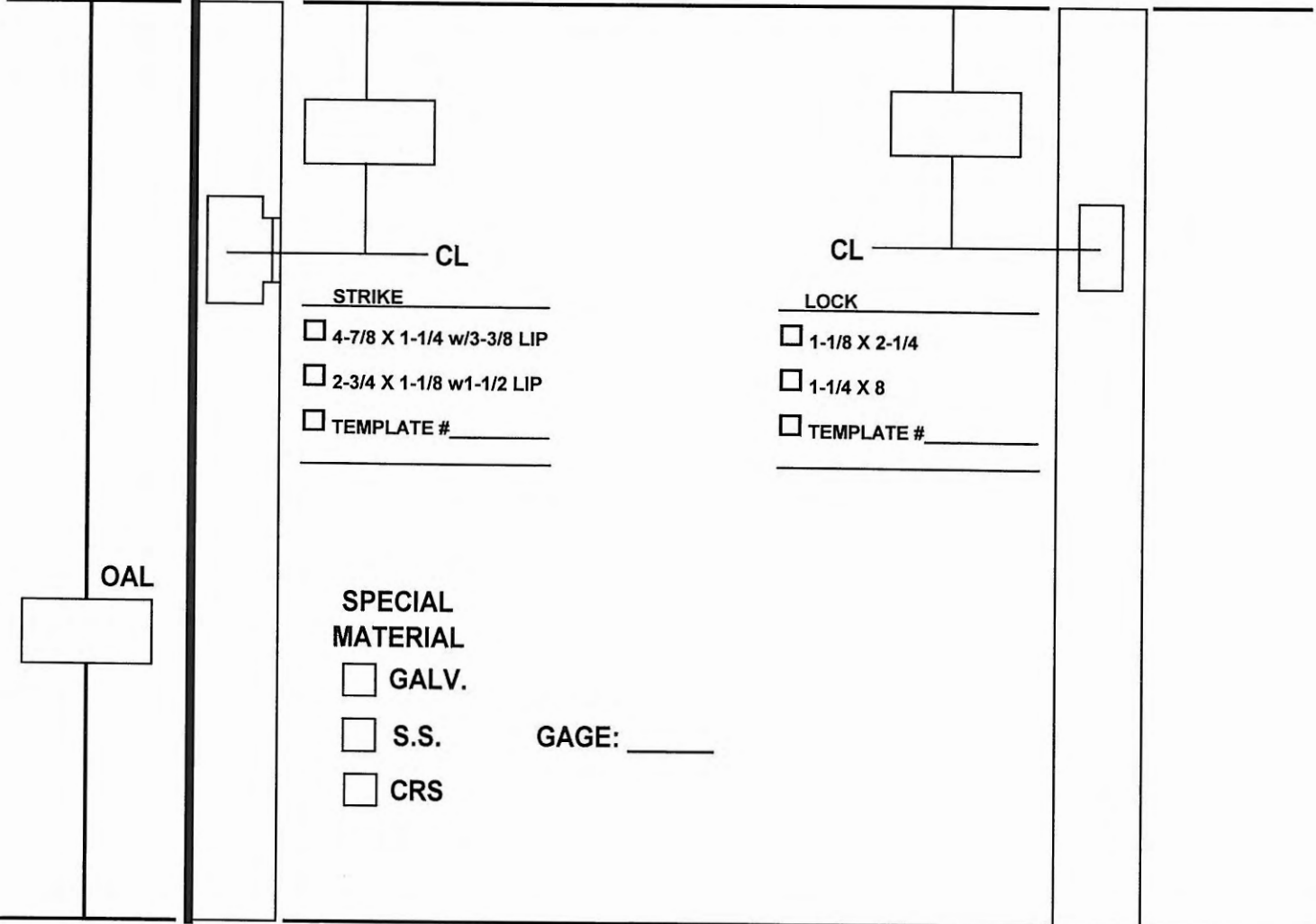



CUSTOMER: _____ DOOR #: _____

P.O.: _____ DATE: _____

M.O.: _____

ACCESSORY ITEM #: _____ DOOR ITEM: _____

NO. of SETS REQ.: _____ DATE REQ.: _____ DRAWN BY: _____ DATE: _____

STD. BEIGE SPECIAL COLOR: _____ NO PAINT VENEER: _____

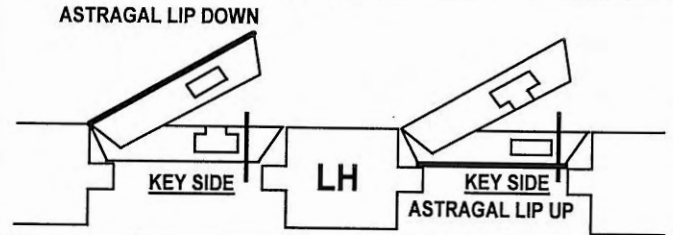
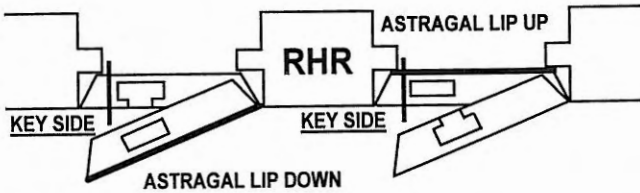

ALL DIMENSIONS ARE FROM LOCK EDGE OF DOOR.

ASTRAGAL

EDGE

DOOR: 1-3/4" 1-13/16" OTHER: _____

#204 DUTCH DOOR TEMPLATE #216

SPECIAL MATERIAL

- GALV.
- S.S.
- CRS

GAGE: _____

LOCK

- 1-1/8 X 2-1/4
- 1-1/4 X 8
- TEMPLATE # _____

STRIKE

- 4-7/8 X 1-1/4 w/3-3/8 LIP
- 2-3/4 X 1-1/8 w1-1/2 LIP
- TEMPLATE # _____

OAL

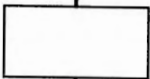

CL

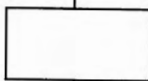
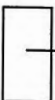

CL

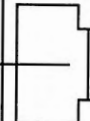
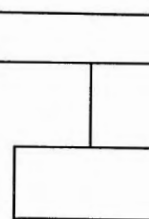



CUSTOMER: _____ DOOR #: _____

P.O.: _____ DATE: _____

M.O.: _____

ACCESSORY ITEM #: _____ DOOR ITEM: _____

NO. of SETS REQ.: _____ DATE REQ.: _____ DRAWN BY: _____ DATE: _____

STD. BEIGE SPECIAL COLOR: _____ NO PAINT VENEER: _____

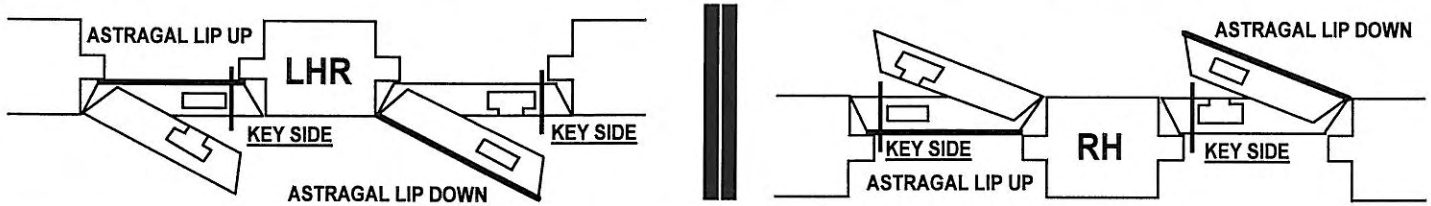

ALL DIMENSIONS ARE FROM LOCK EDGE OF DOOR.

ASTRAGAL

EDGE

DOOR: 1-3/4" 1-13/16" OTHER: _____

#204

DUTCH DOOR TEMPLATE

#216

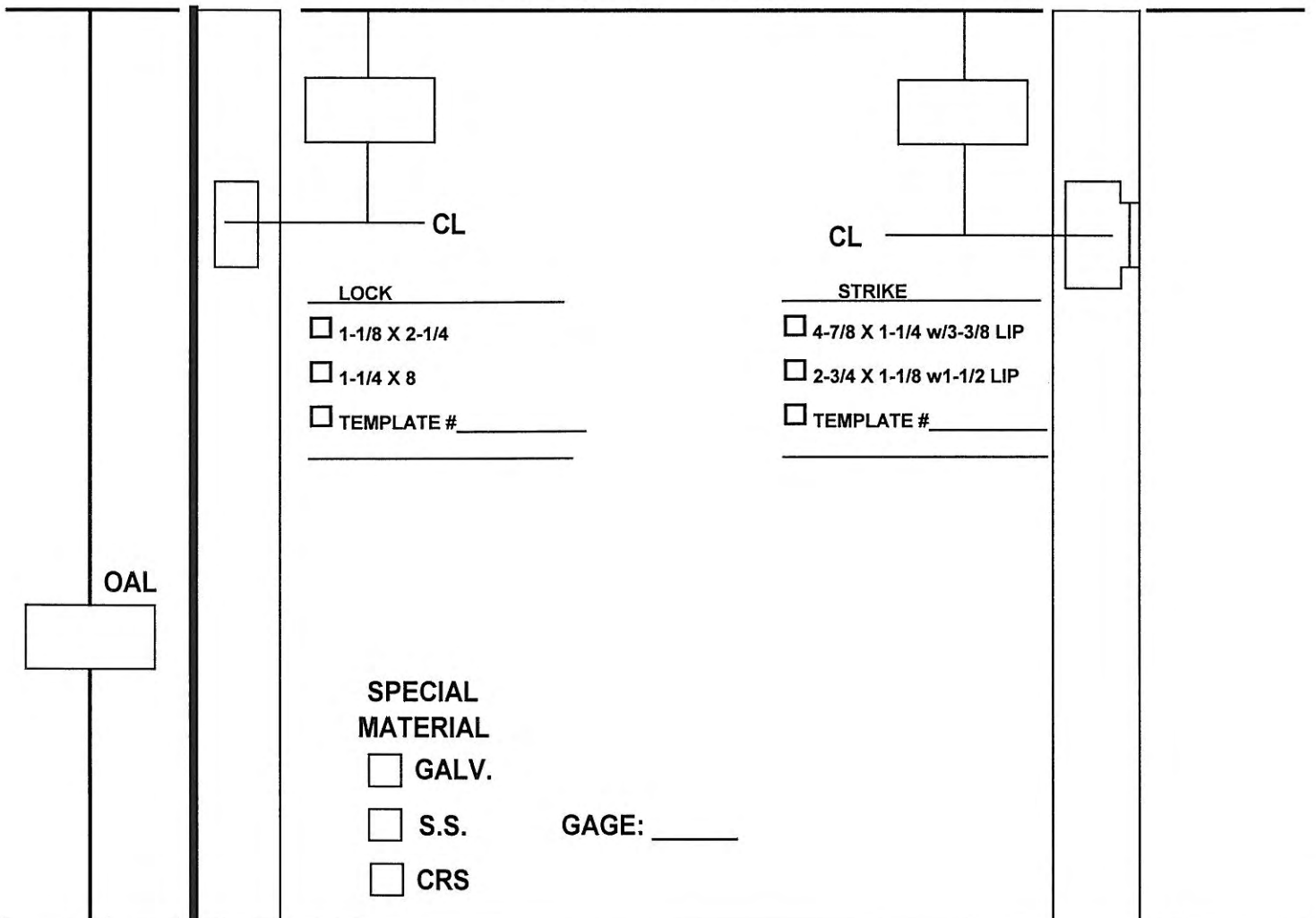

- LOCK
- 1-1/8 X 2-1/4
 - 1-1/4 X 8
 - TEMPLATE # _____

- STRIKE
- 4-7/8 X 1-1/4 w/3-3/8 LIP
 - 2-3/4 X 1-1/8 w1-1/2 LIP
 - TEMPLATE # _____

SPECIAL MATERIAL

- GALV.
- S.S.
- CRS

GAGE: _____