



SPECIFICATIONS

Projected, Casement, Fixed and Pivot windows shall be Marlin Series 7505 as manufactured by Marlin windows, and shall conform to AAMA/NWDA -101-I.S.2-97 HC65 (HC45 for Pivot). Series 7505 shall have a n AAMA 1503 CRF factor of not less than 56 and and NFRC 500 CR of not less than 33.

MATERIALS

All frame and sash members shall be aluminum extrusions of 6063-T5 alloy & temper with a minimum wall thickness of .094". Frame and sash members shall have a rigid polyurethane "thermal-barrier" as an integral part of the extrusion which eliminates all direct contact between interior and exterior aluminum sections. Glazing stops to be extruded aluminum with a minimum wall thickness of .050".

FINISH

Standard architectural Class II anodic color conforming to Aluminum Association AA-M12-C22-A34 for dark bronze or AA-M12-C22-A31 for clear anodize. (Architectural Class I anodic finishes and organic coatings available - specify).

CONSTRUCTION

Frame members shall be 2 1/4" or 3 3/8" in depth. Frame and vent corners shall be fabricated to form tight mitered joints. All intermediate frame members shall be coped to form tight butt joints where joined to perimeter members. All joinery fastened securely with stainless steel self-tapping screws and sealed to prevent moisture and air infiltration. Extruded aluminum glass stops shall be fabricated to form tight butt-joints. **Maximum vent 66" x 36"**

PROJECTED HARDWARE

Projected shall be balanced with two heavy duty four bar friction hinges. Hinges shall be of stainless steel, and include a positive stop and an adjustable friction shoe. Locking hardware shall consist of cam handle locks and surface strikes. Handle, base & strike housing shall be cast white bronze with burnished finish. Roto operators and underscreen bar operators are available (specify).

CASEMENT HARDWARE

Casement windows shall be supported by exposed hinges manufactured from cast bronze alloy and secured with concealed fasteners, or by heavy duty 4 bar concealed friction hinges (specify). Roto type operation with locking handles and concealed strikes shall be standard with exposed hinges. Other variations of hardware and finish available - consult factory.

PIVOT HARDWARE

Pivot vents shall rotate 180 degrees on cast white bronze pivots. Locking hardware shall consist of a project out handle one side and a project in handle the other side. Removable key custodial locks and limit devices are available options (specify).

WEATHERSTRIPPING

A compression seal shall run continuously around entire perimeter of ventilator and frame opening of ventilator to form a double seal.

GLAZING

Marlin Series 7505 windows shall accept glazing materials with nominal thickness of 1" and 1 $\frac{1}{2}$ ".

OPTIONAL SCREEN

Screen frames shall be fabricated from roll-form aluminum, finish to match window. Screen cloth to be 18 x 16 fiberglass mesh held in the aluminum screen frame with a tight fitting continuous vinyl spline.

INSTALLATION

Windows shall be installed straight, plumb, and level without twisting and securely anchored in place. Openings shall be properly prepared to provide sufficient space at jambs, head and sill to compensate for normal construction movement without affecting intended use.

PROTECTION AND CLEANING

The General Contractor shall provide adequate protection of the aluminum and glass surfaces from damage by grinding compound, lime, acids, cement or other contaminants. The General Contractor shall be responsible for final cleaning.



1/4 SCALE

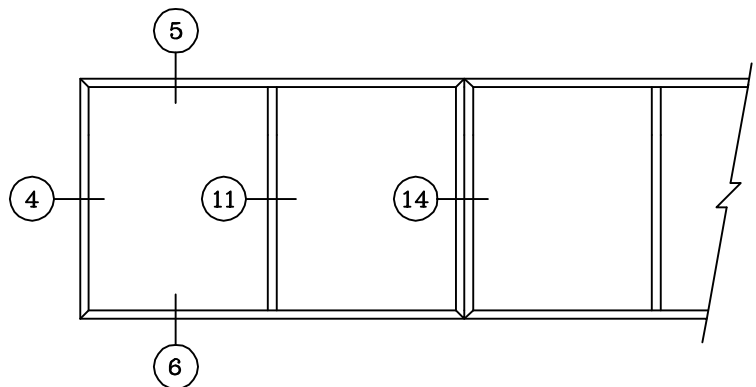
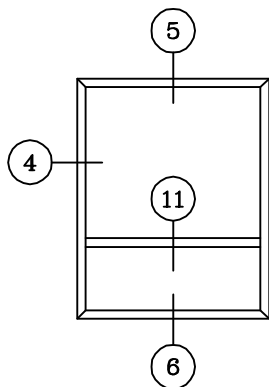
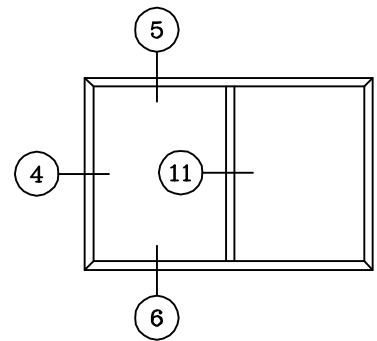
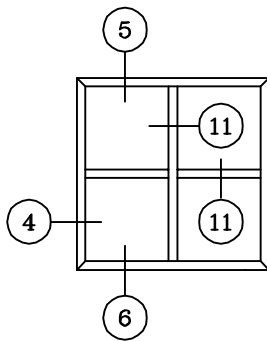
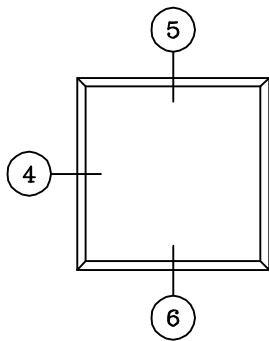
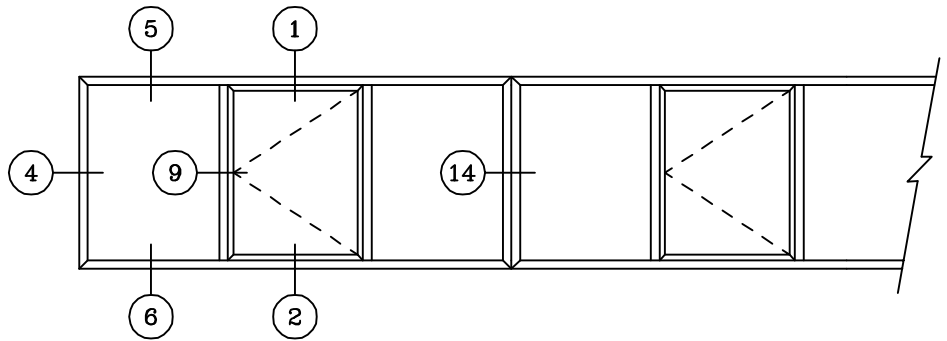
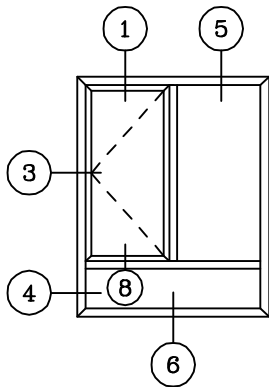
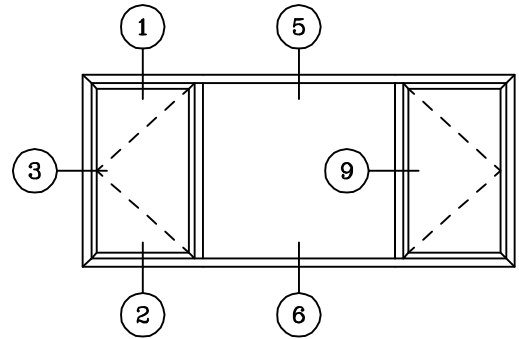
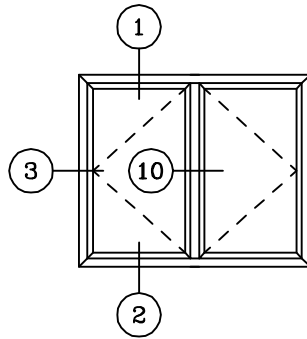
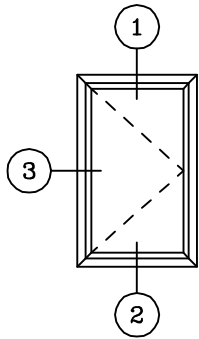



1/4 SCALE

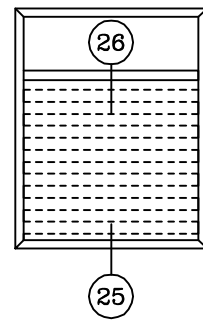
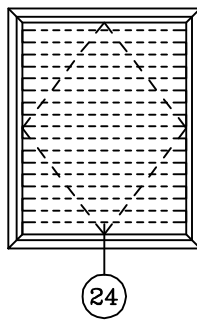
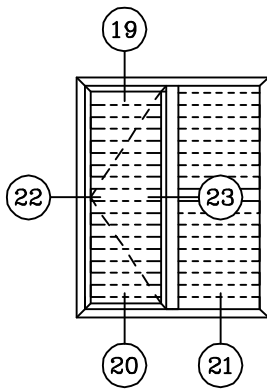
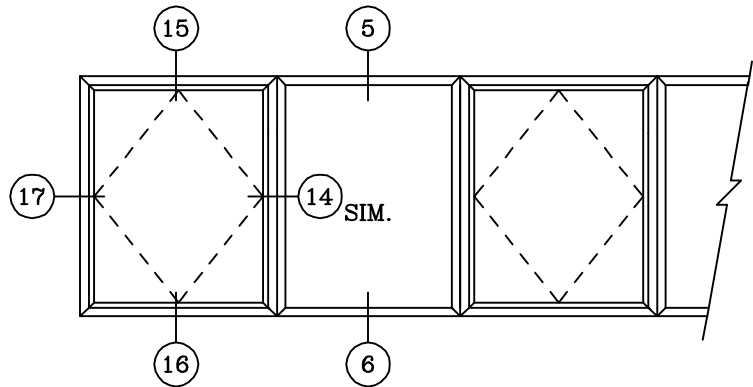
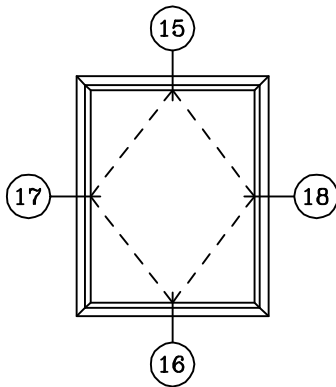
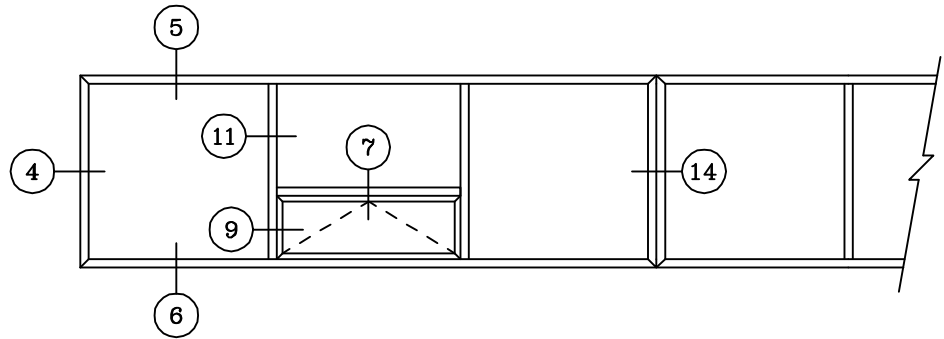
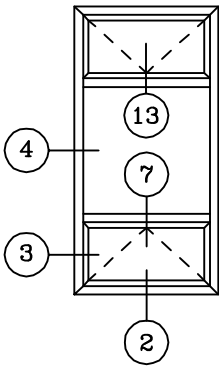
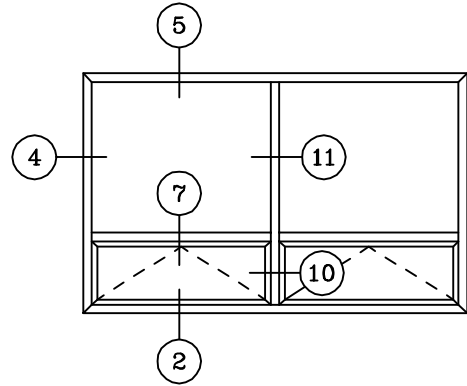
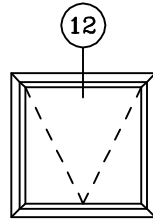
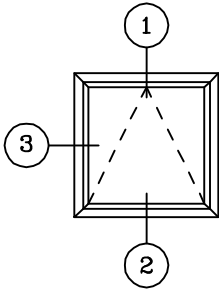



HEAD COMPENSATING CHANNEL

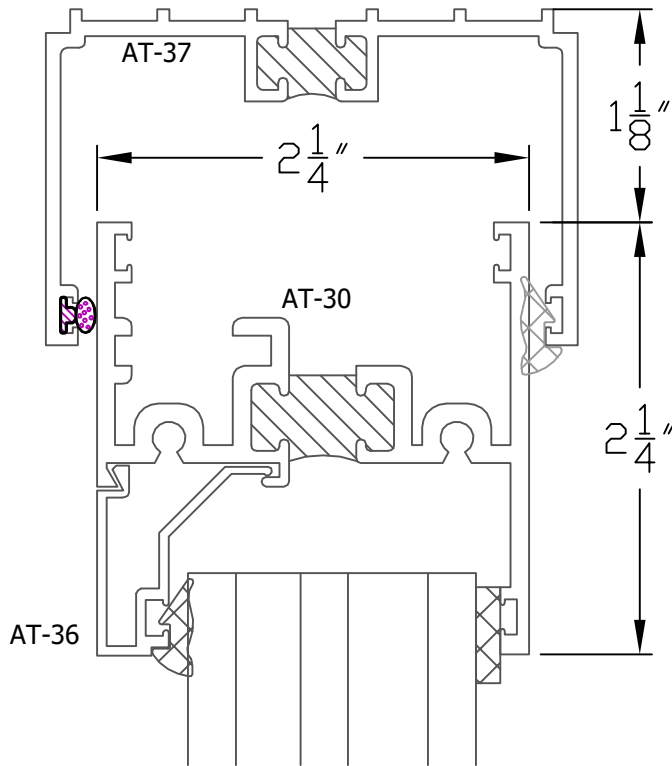

1 1/2" TRIPLE
GLAZING STOP

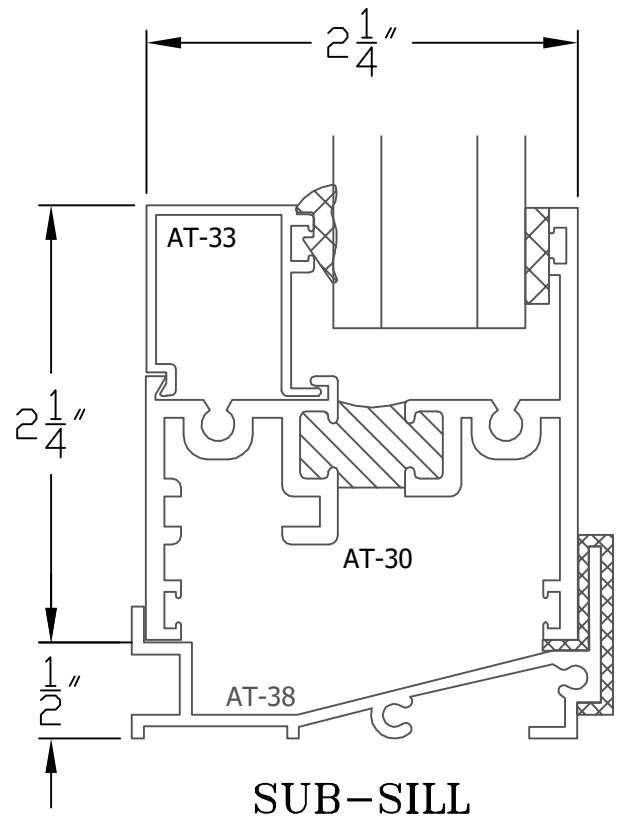

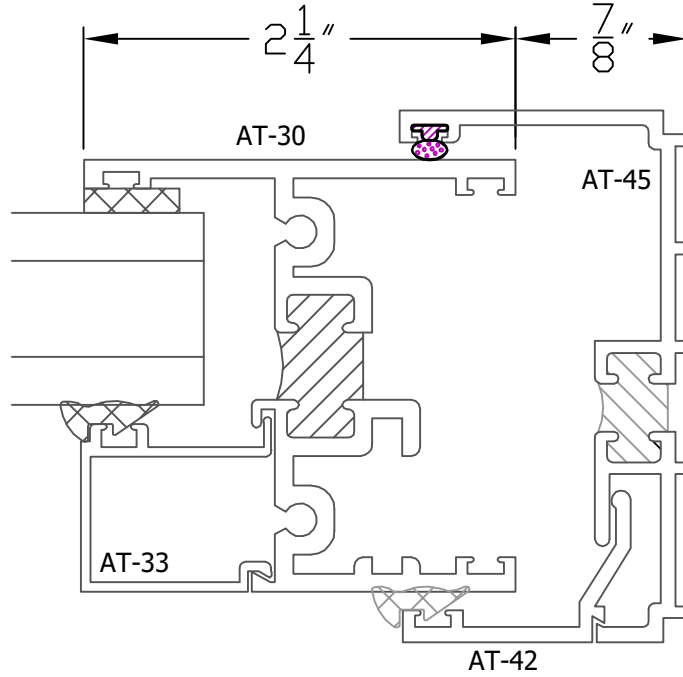

JAMB COMP.
CHANNEL

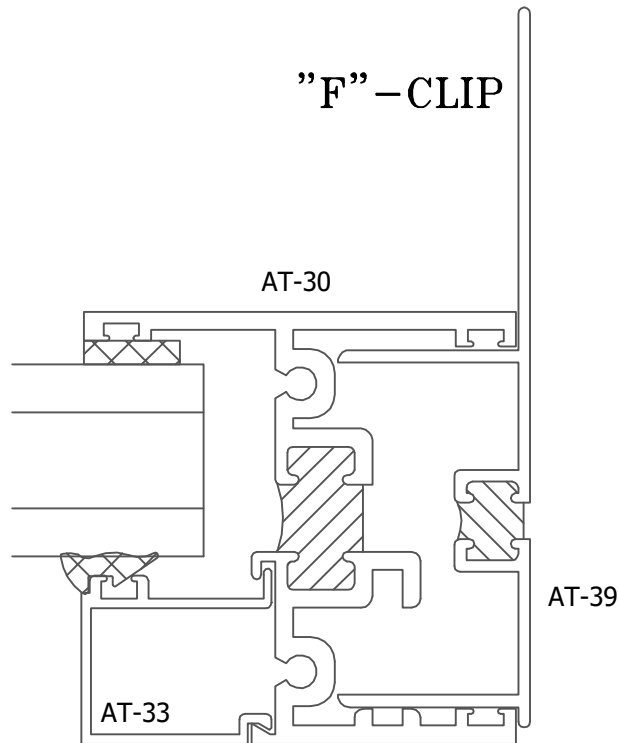



TRIPLE GLAZE OPTION

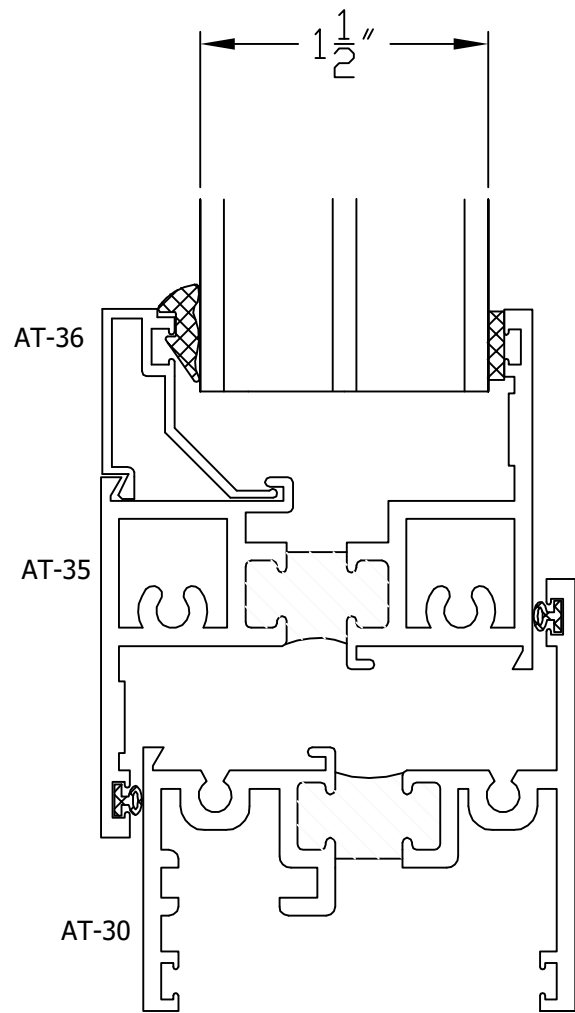
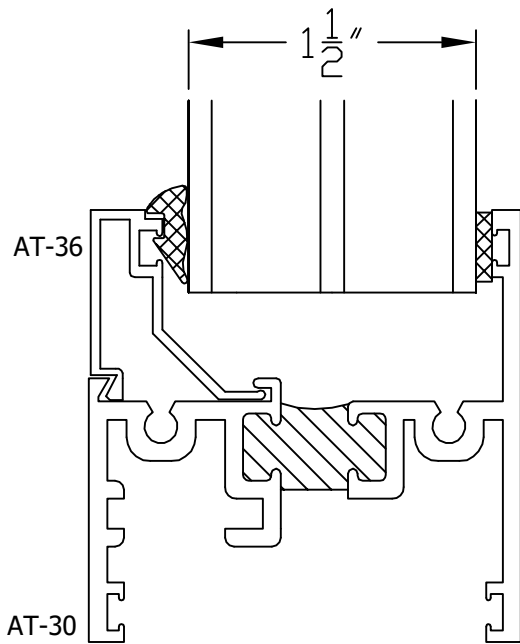
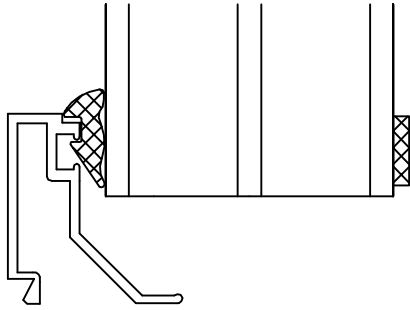

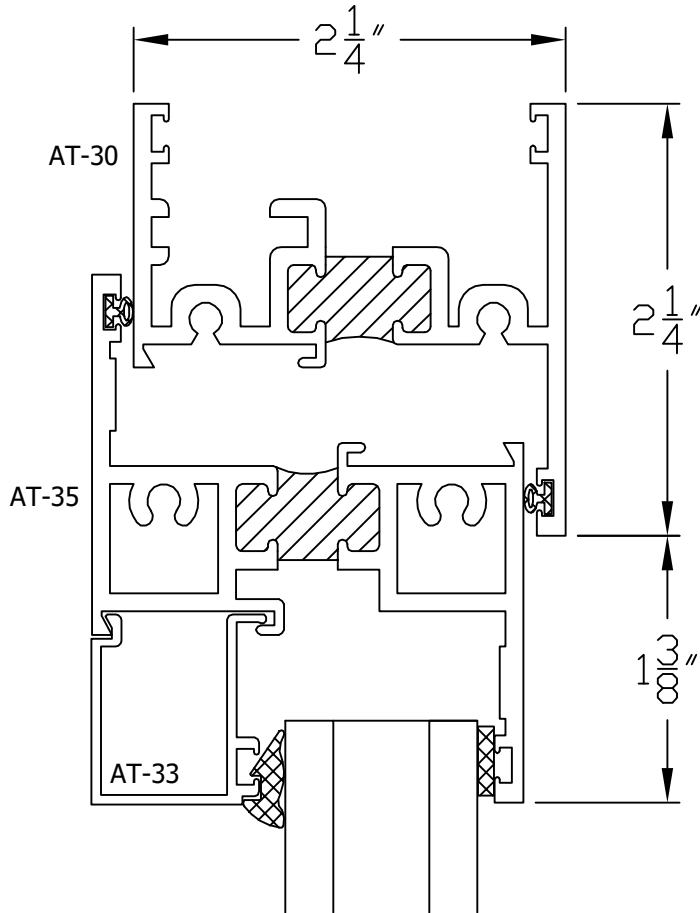

1 HEAD @ VENT

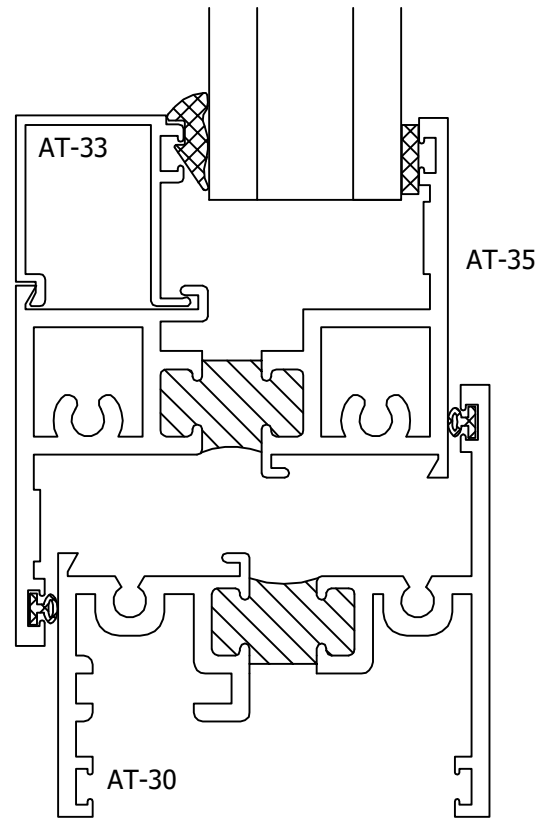

2 SILL @ VENT

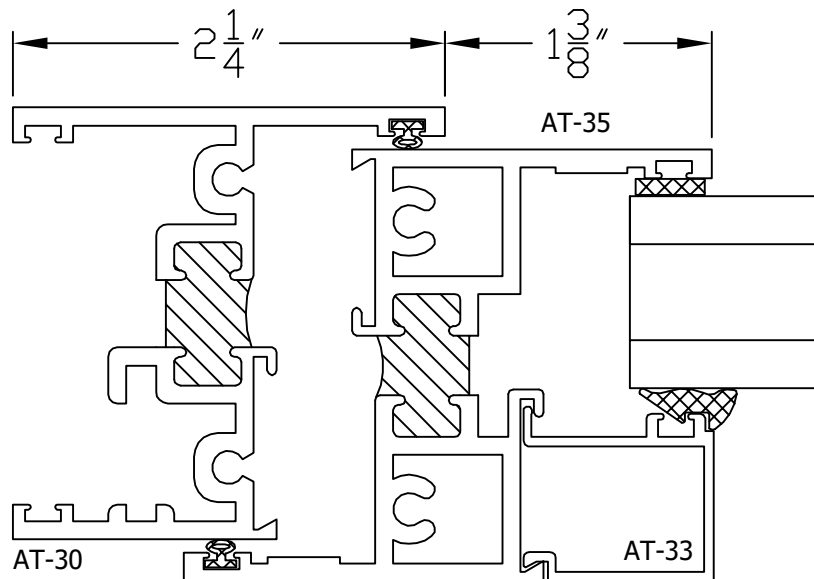

3 JAMB @ VENT

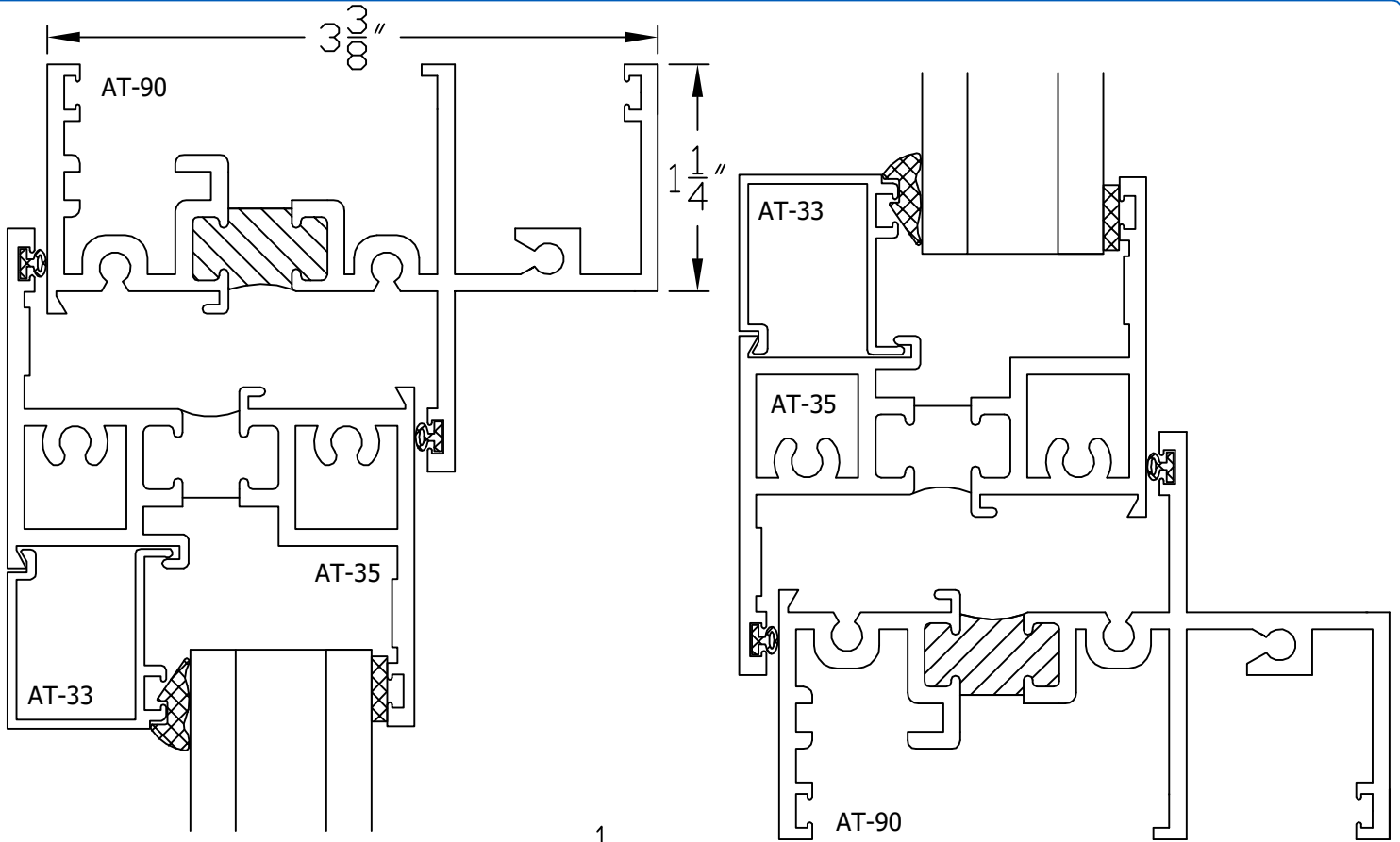

1 HEAD @ VENT

2 SILL @ VENT

3 JAMB @ VENT

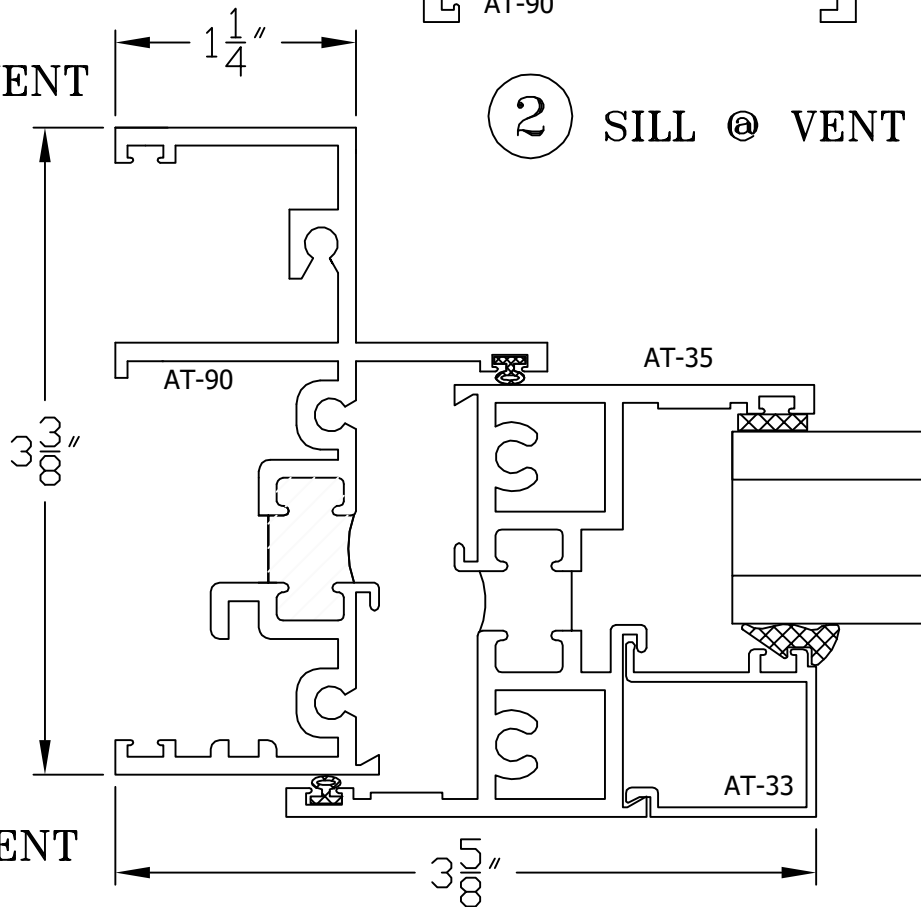

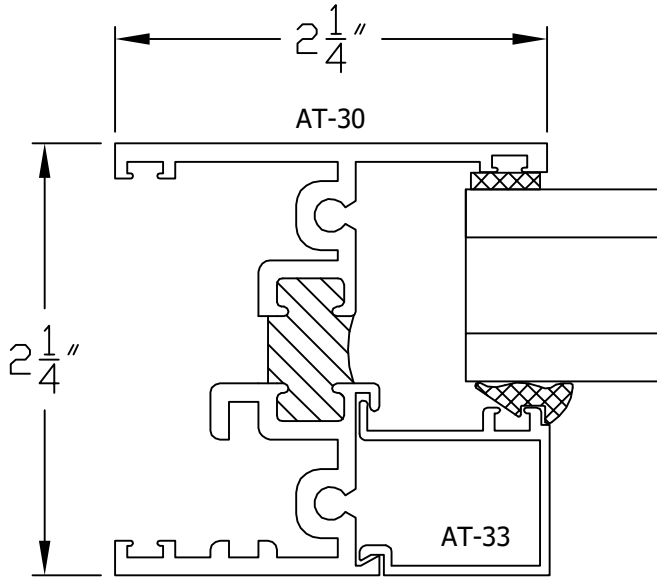

④ JAMB @ FIXED

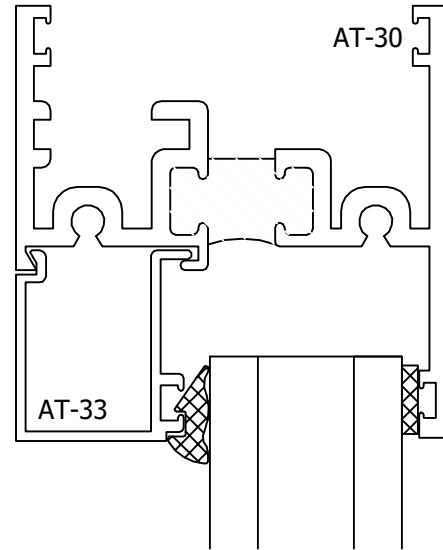

⑤ HEAD @ FIXED

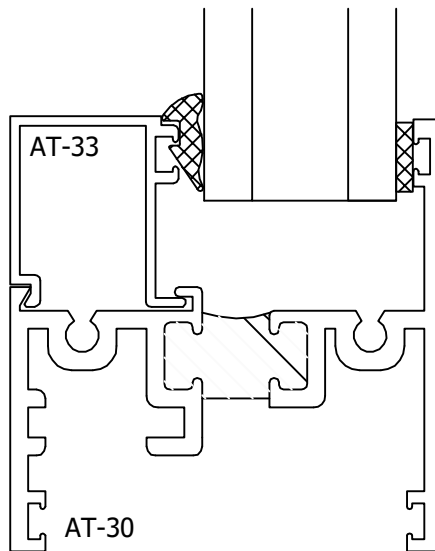

⑥ SILL @ FIXED

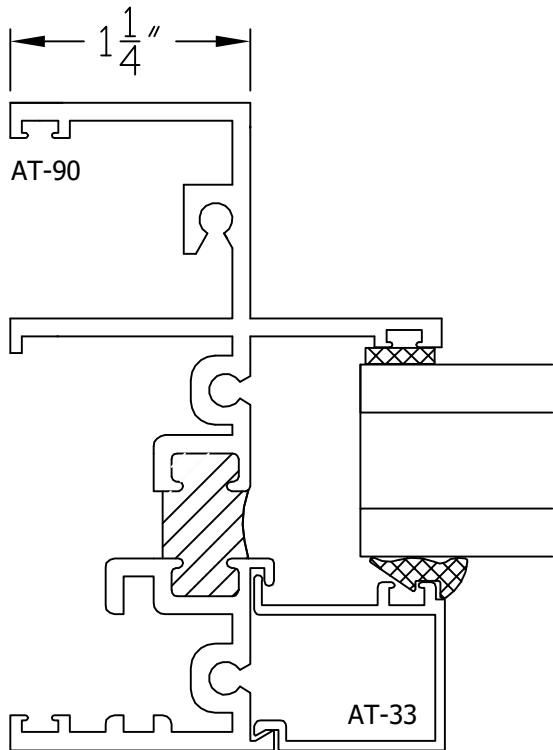

④ JAMB @ FIXED

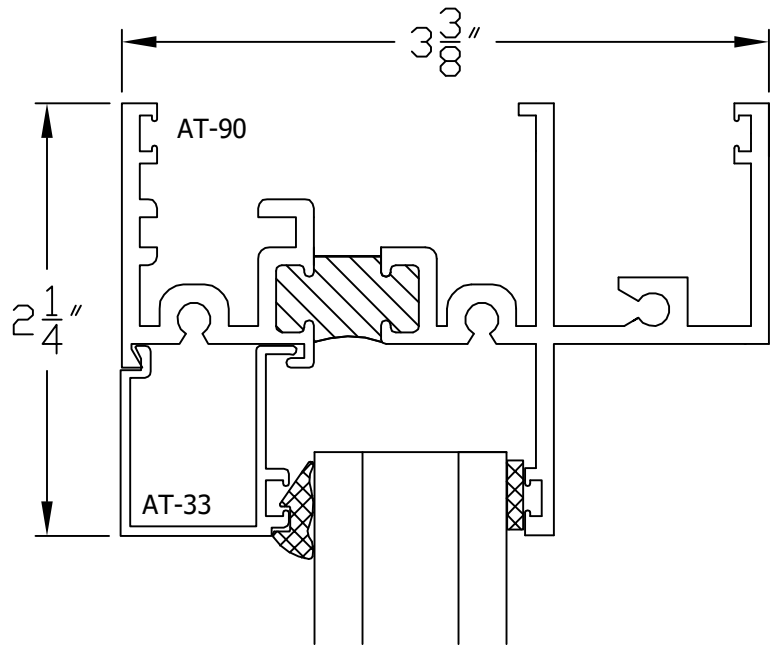

⑤ HEAD @ FIXED

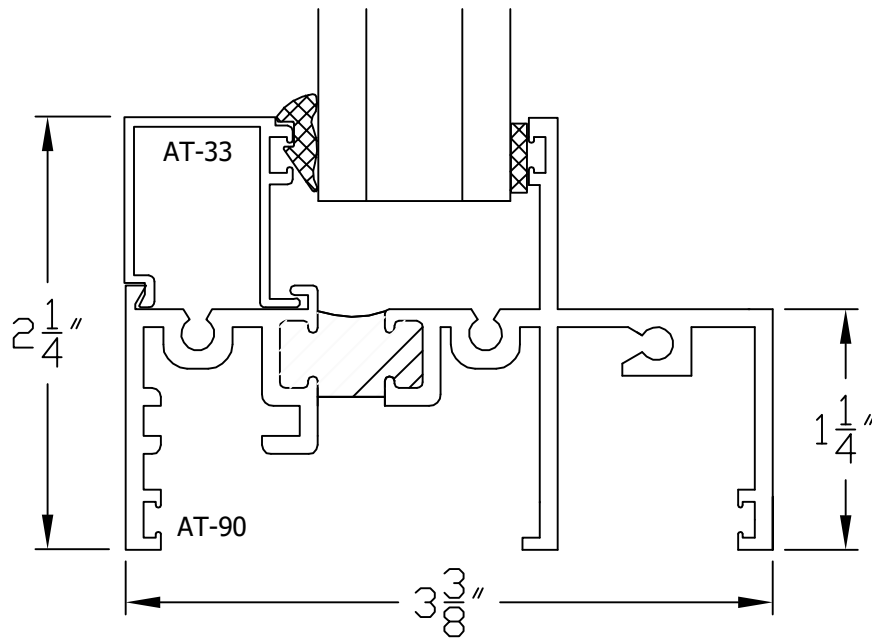

⑥ SILL @ FIXED

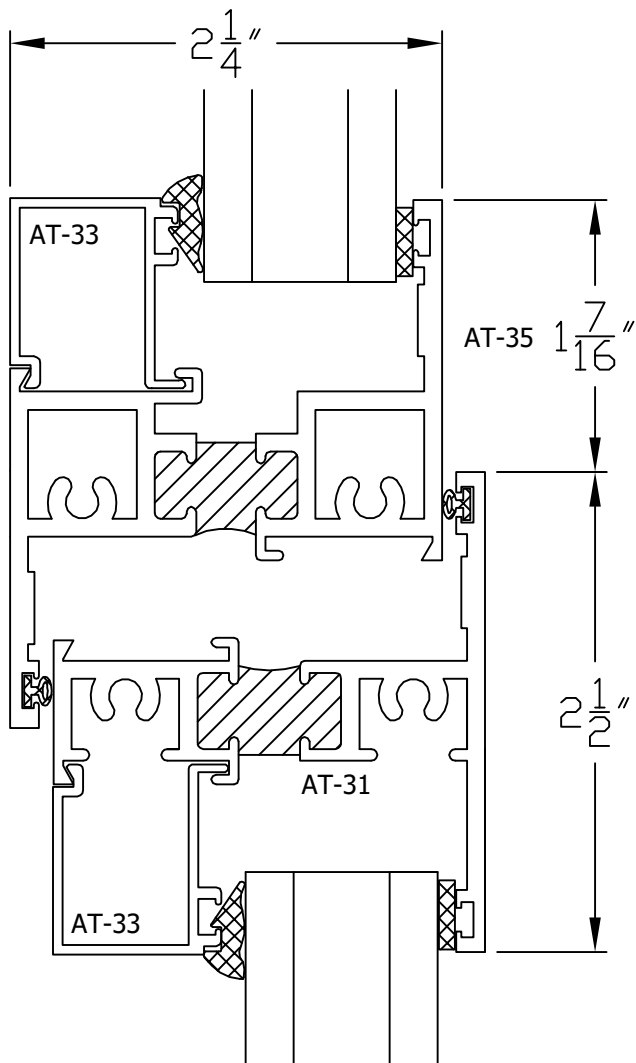

8 VENT ABOVE FIXED

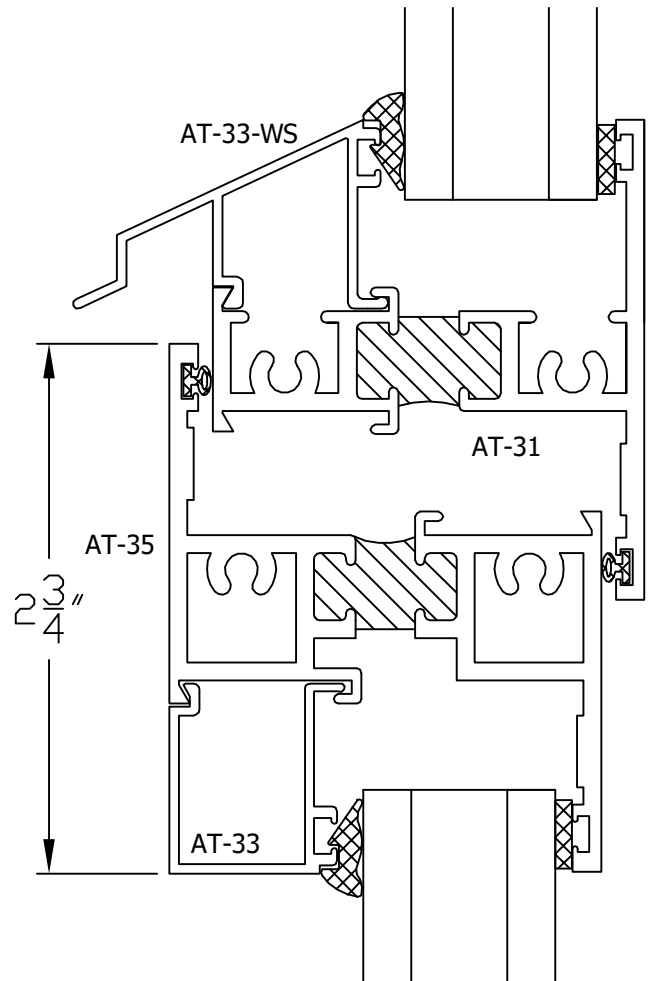

7 VENT BELOW FIXED

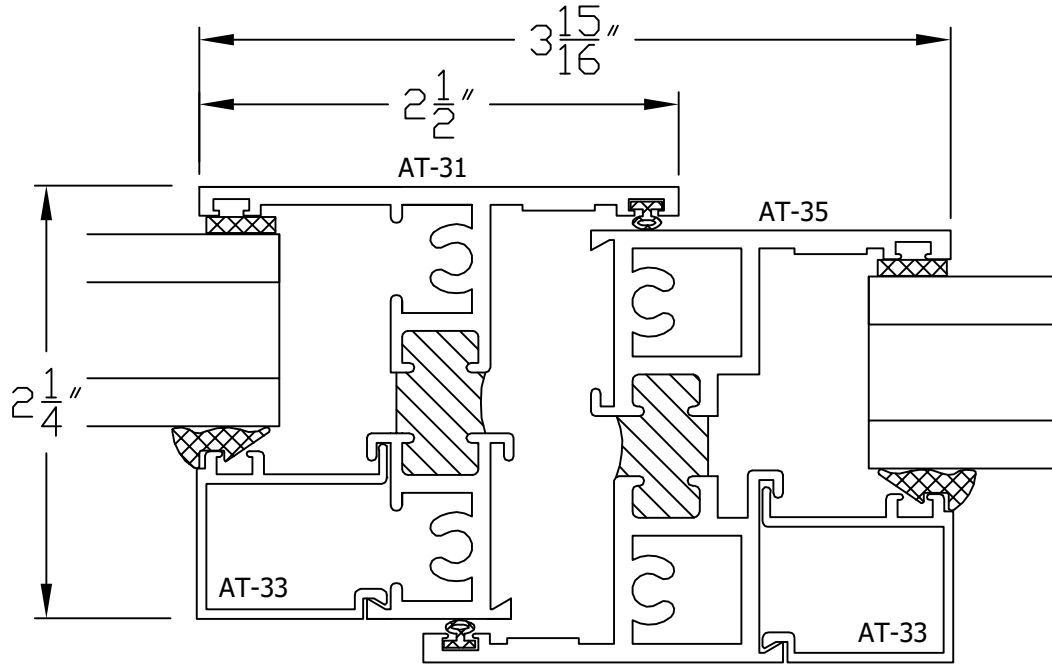

9 VENT @ RIGHT OF FIXED

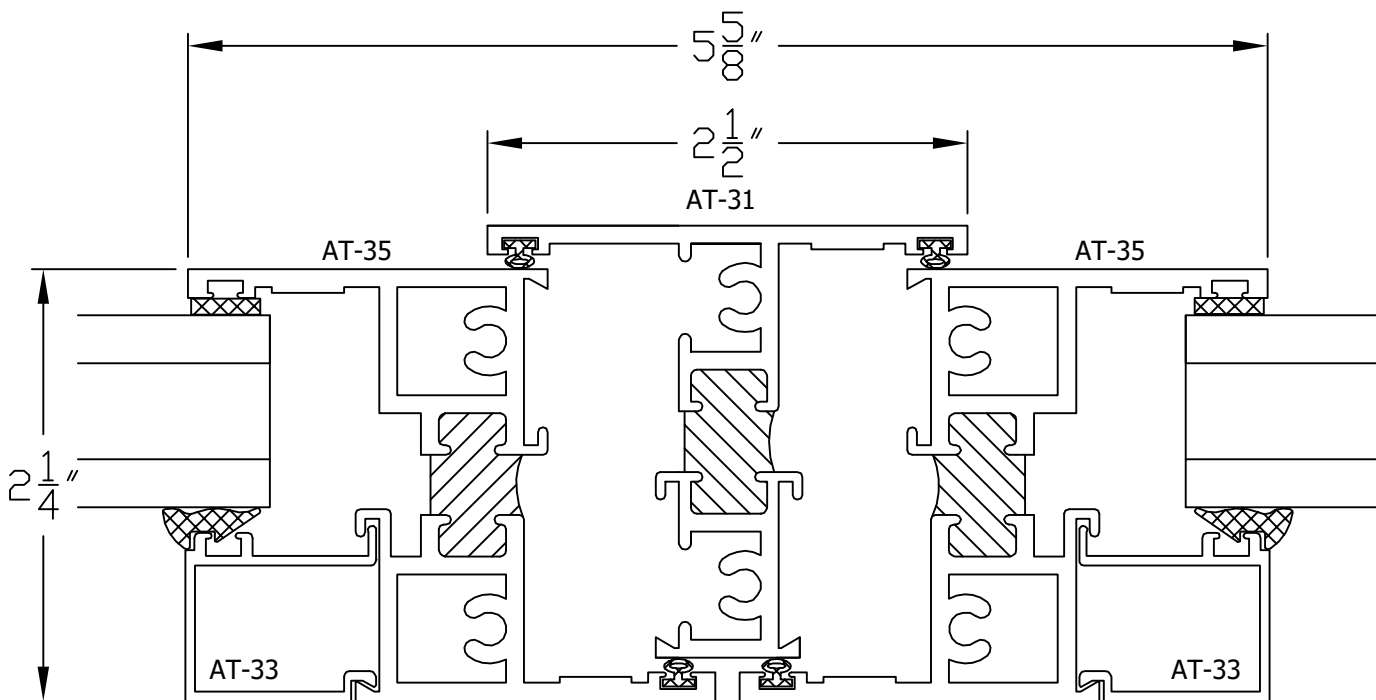

10 DOUBLE VENT

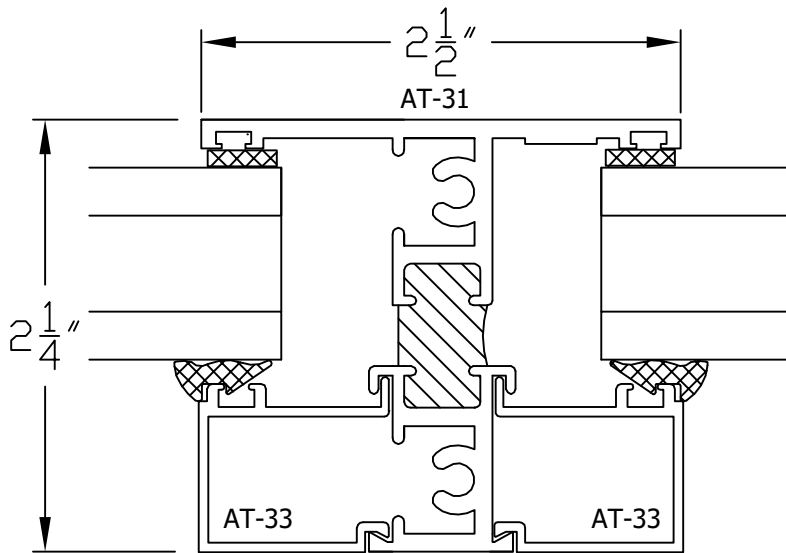

11 TYPICAL MULLION

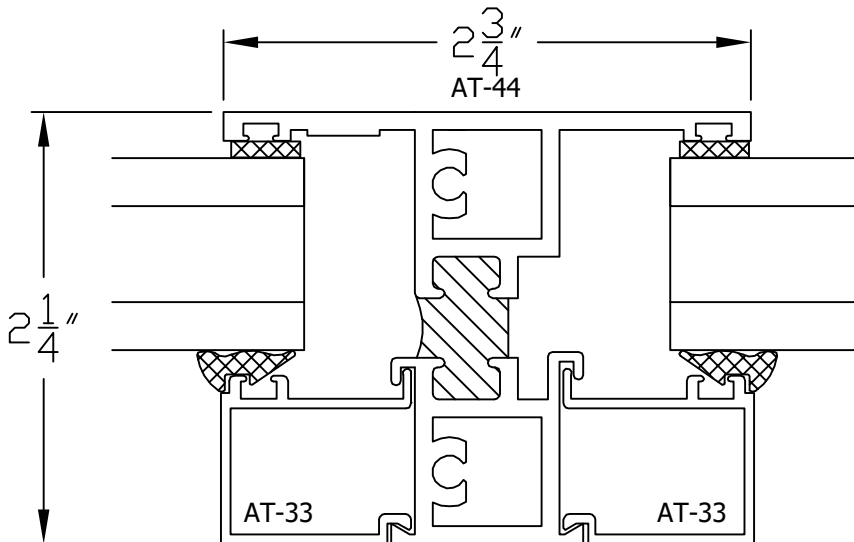

11A HEAVY MULLION

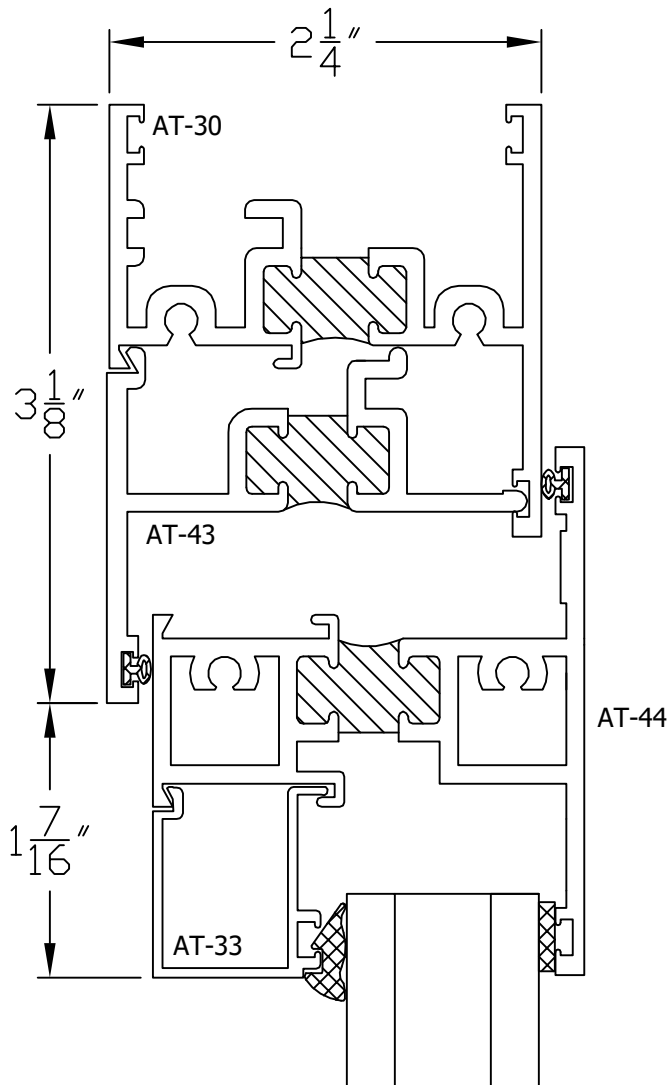

12 HEAD @
PROJECT IN VENT

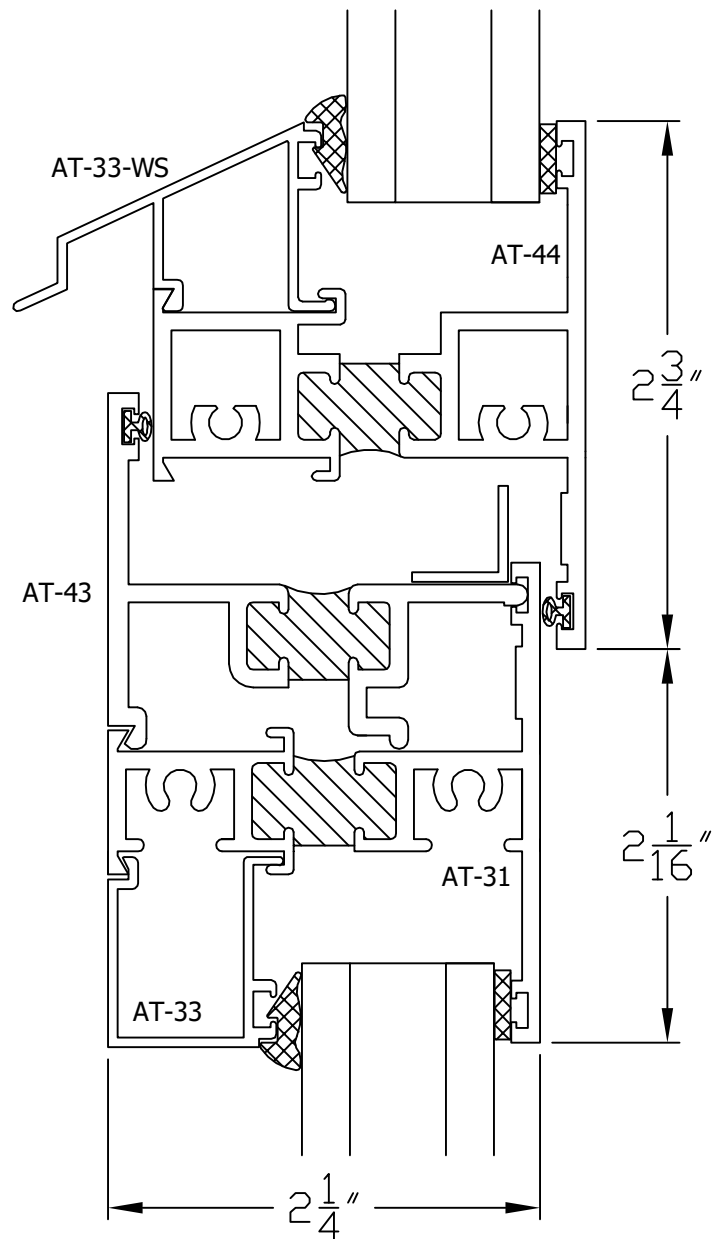

13 VENT ABOVE FIXED
PROJECT IN VENT

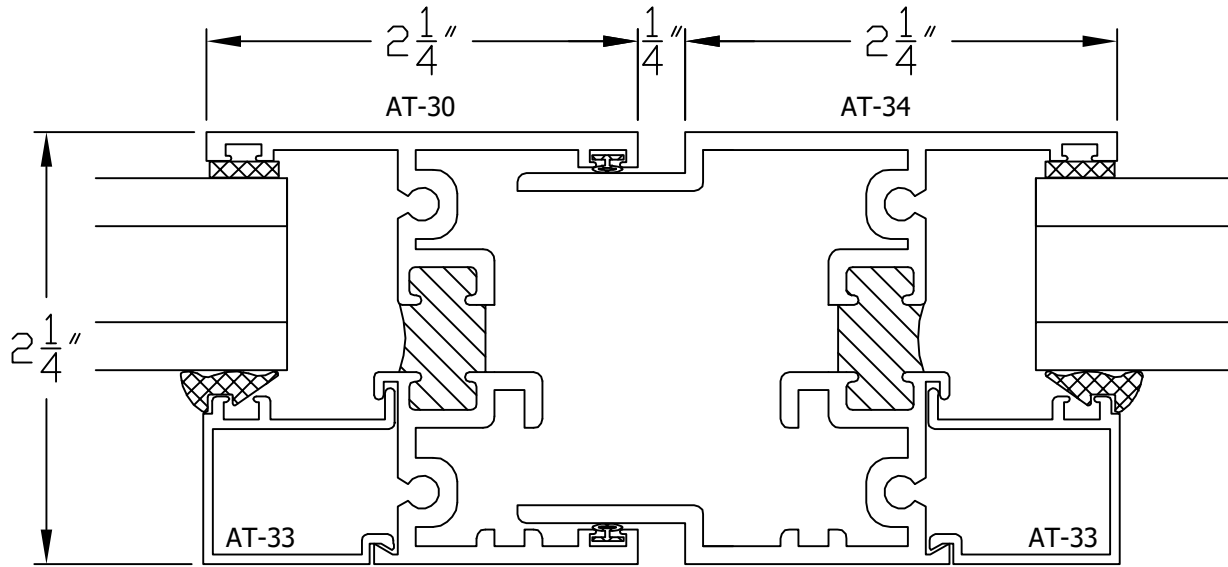

14 STACKING JAMB
MALE-FEMALE EXPANSION

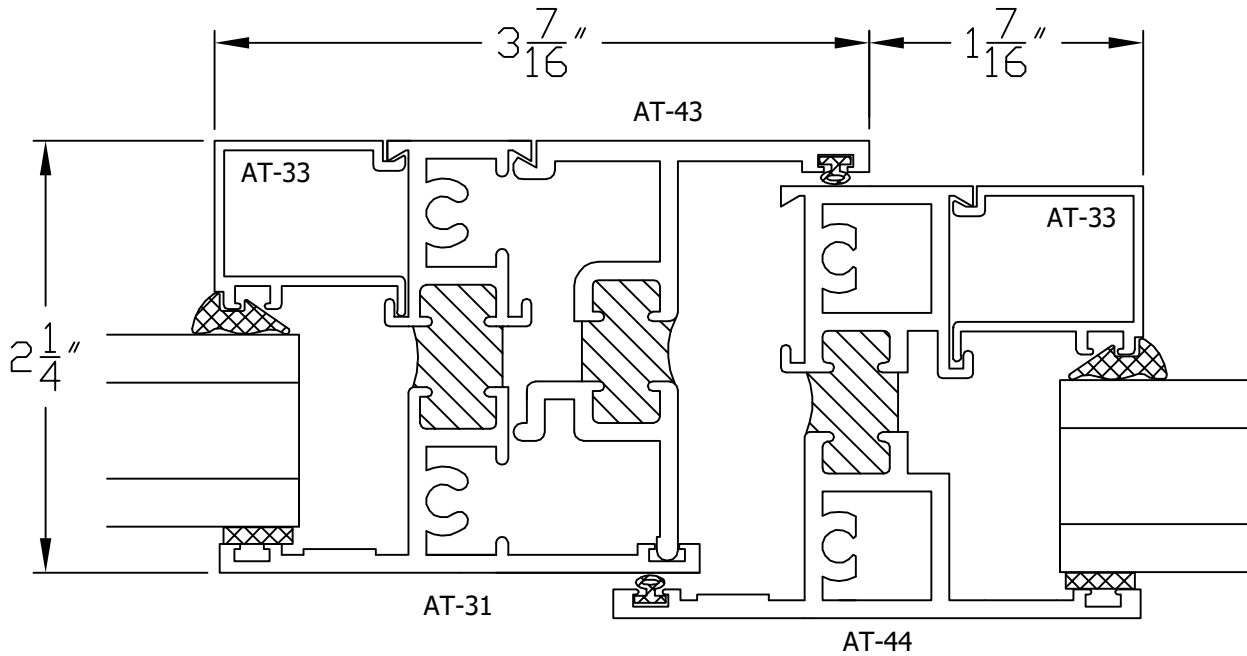

INSIDE GLAZING ADAPTOR
@OUTSWINGING VENTS

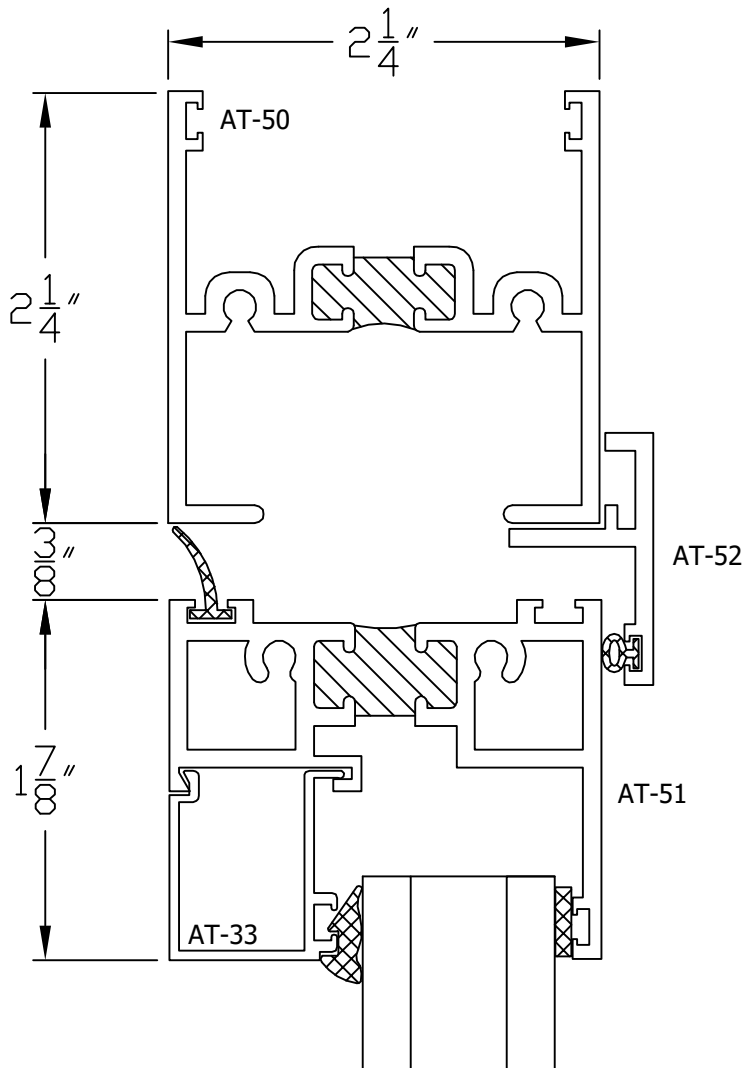

15 HEAD @ PIVOT POINT

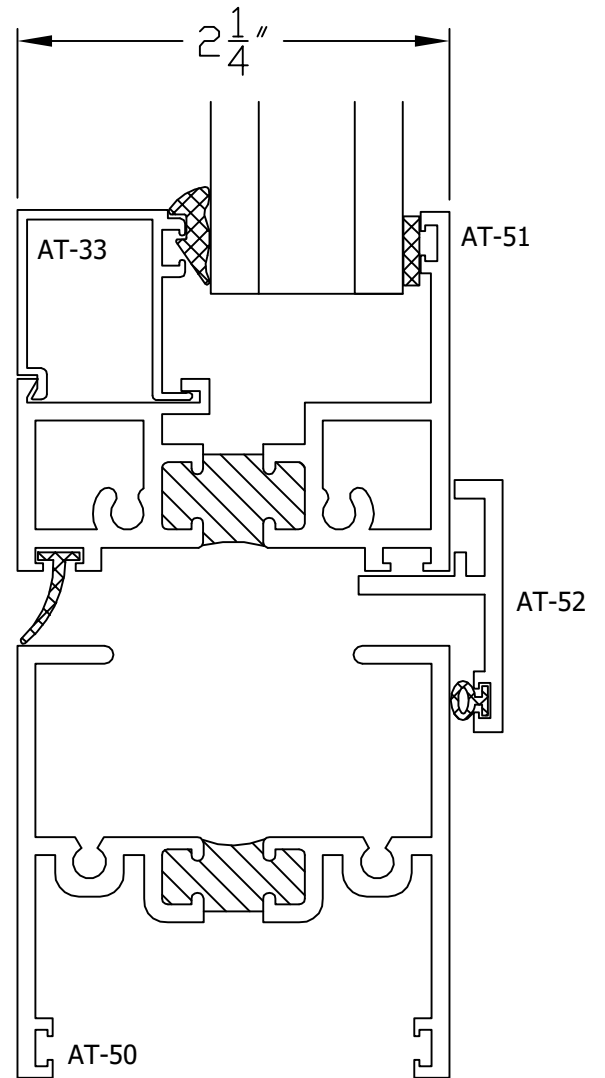

16 SILL @ PIVOT POINT

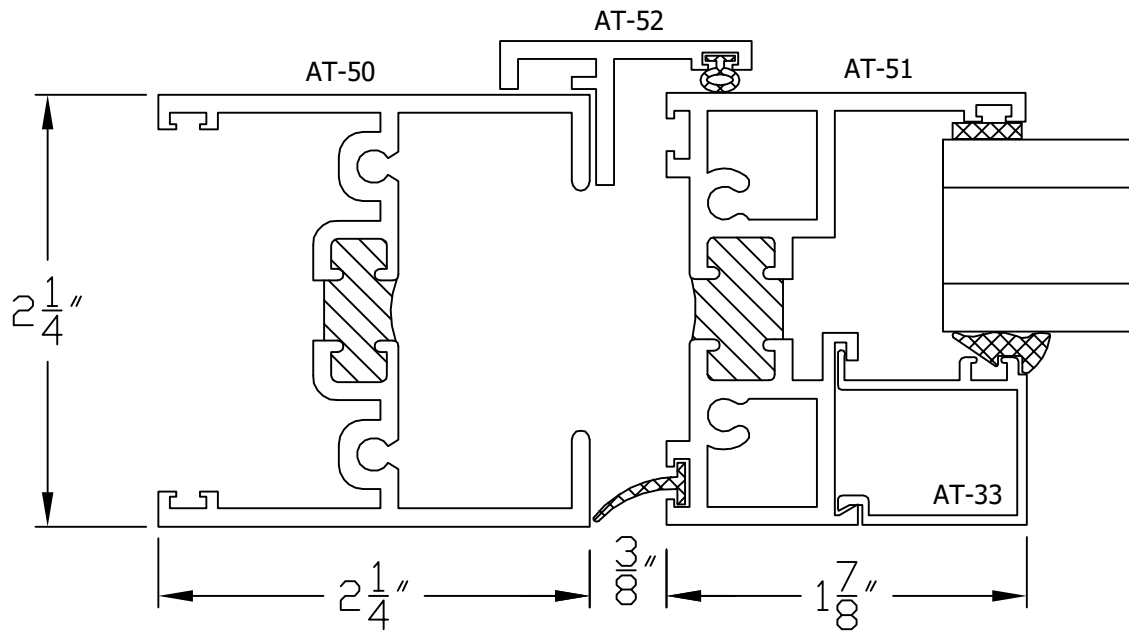

17 LEFT JAMB @ PIVOT VENT

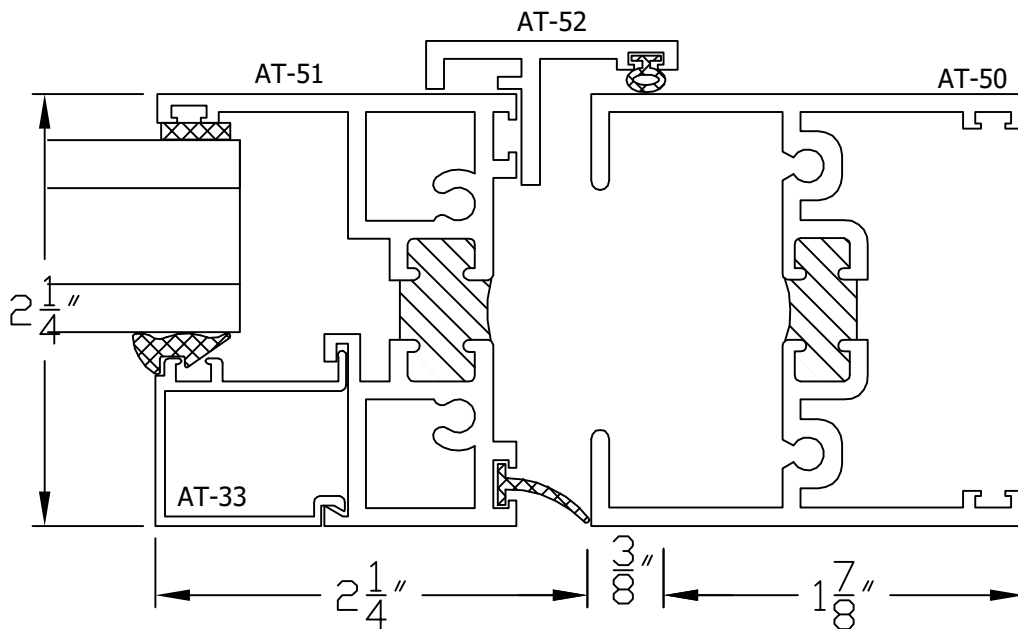

18 RIGHT JAMB @ PIVOT VENT

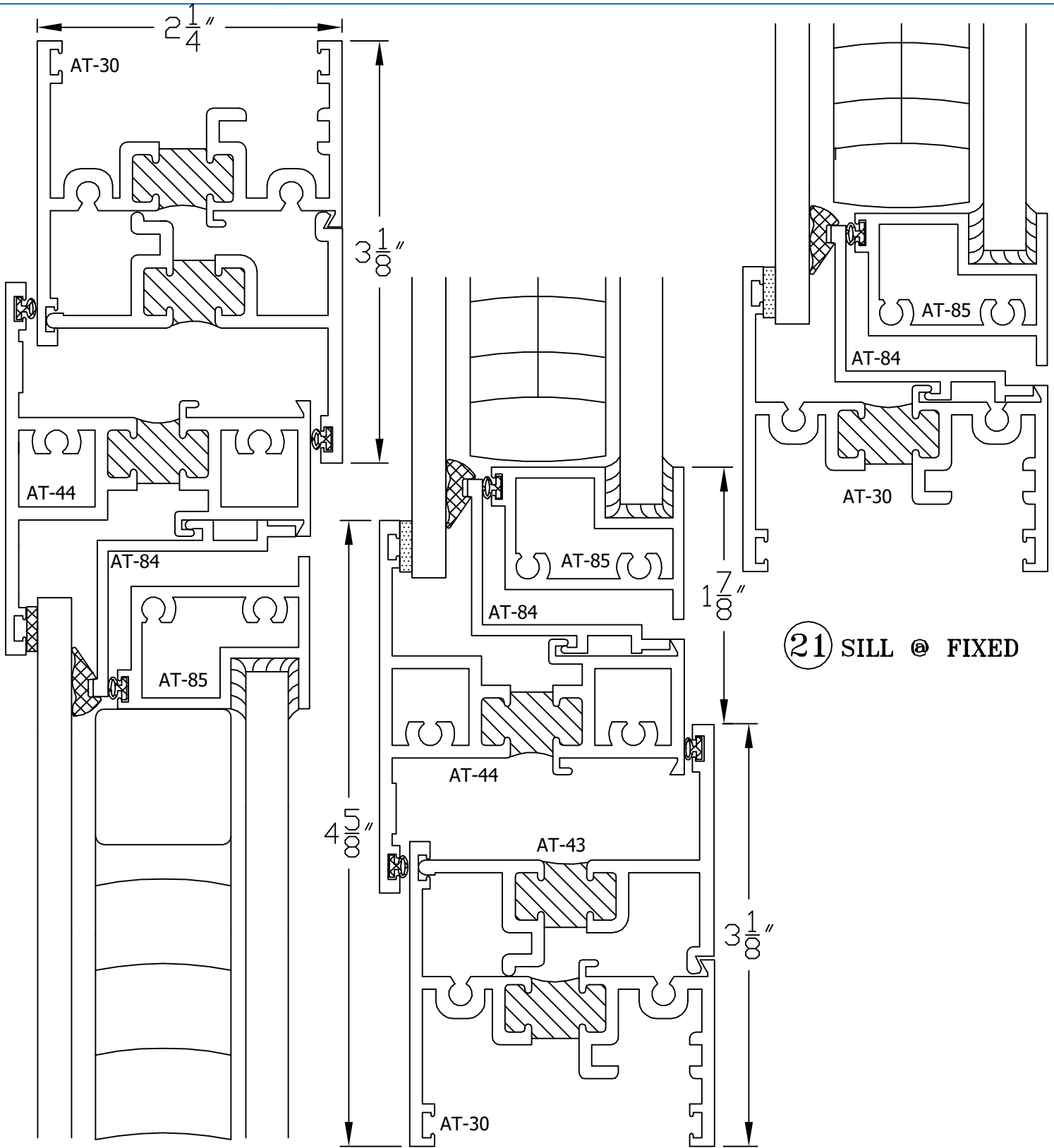

①9 HEAD @ PROJECT
OUT VENT

②0 SILL @ VENT

②1 SILL @ FIXED

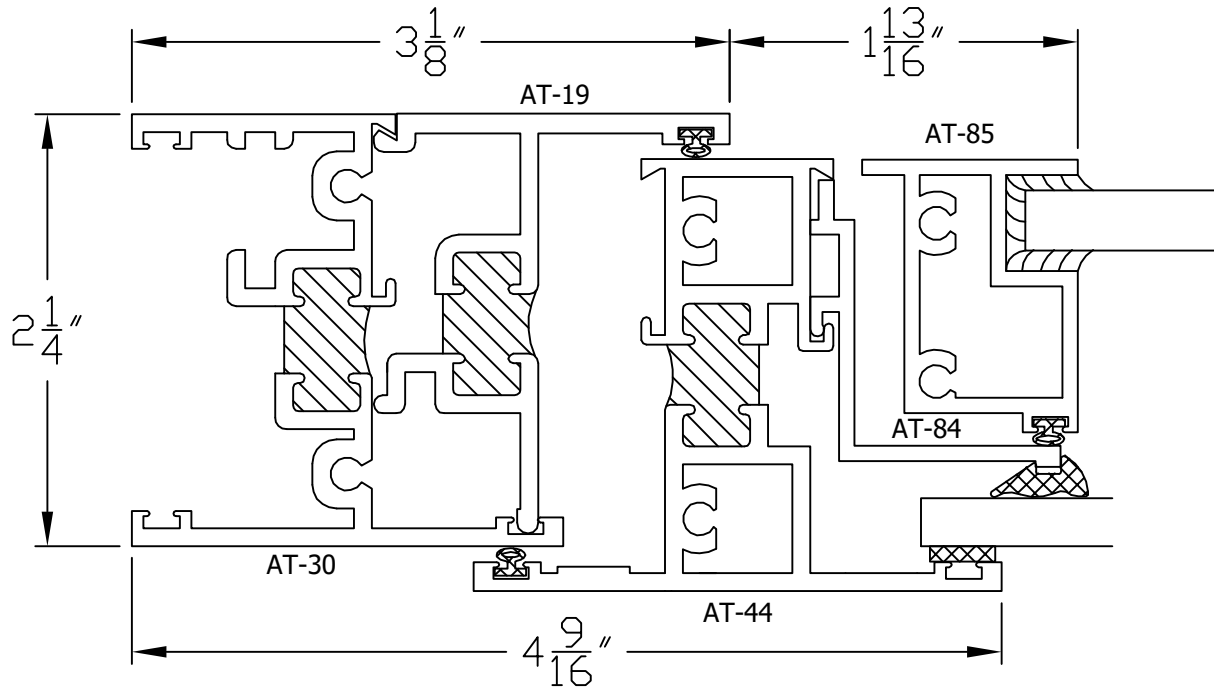

22 JAMB @
PROJECT OUT VENT

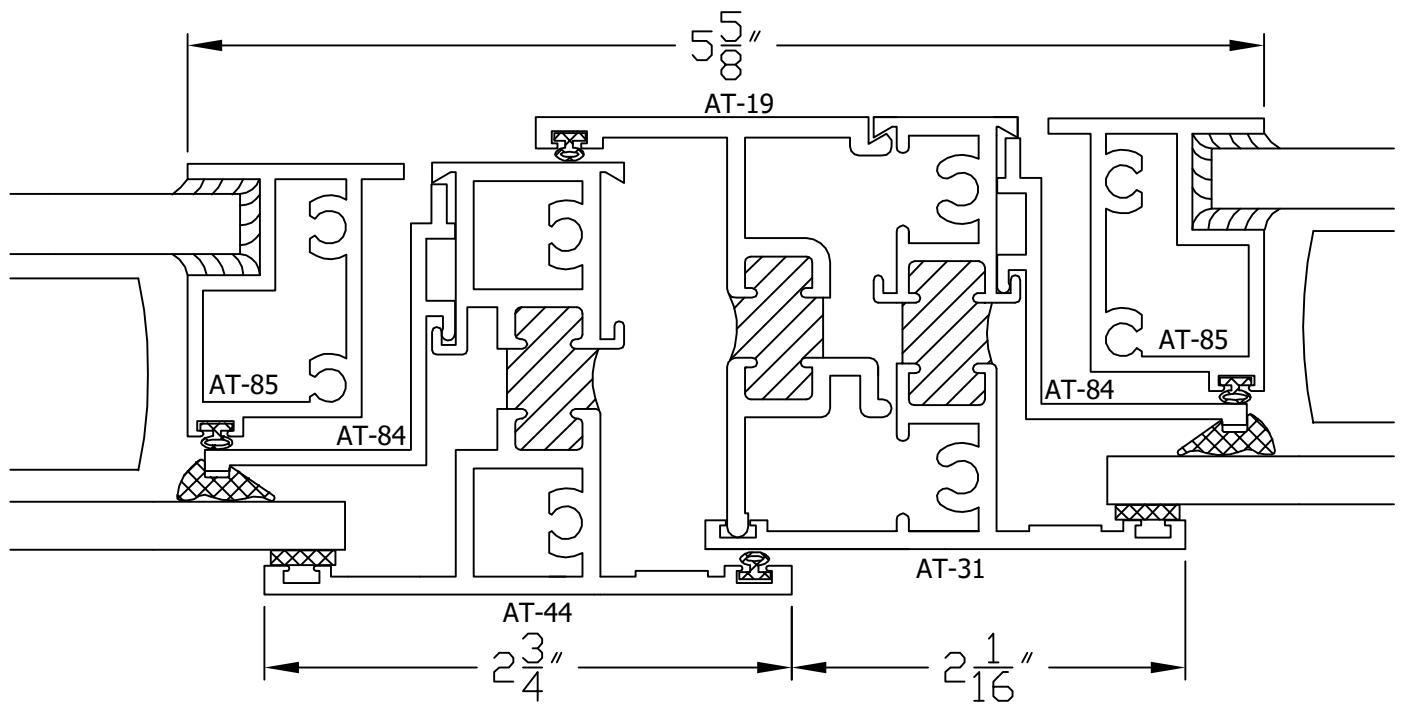

23 VENT @ LEFT OF FIXED

