

PRODUCT CATALOG

2020 - 2021

**FOLDERS
FASTENERS
ARCHIVAL
STORAGE
SYSTEMS**



the folder factory



goto label

**COLOUR
CODED
LABELS
COMMERCIAL
LABELS
MEDICAL
LABELS**

Folder Division

209 Salisbury Road
Moncton, NB
E1E 1A6
Tel: 506.859.8219
Toll Free: 800.265.5852
Fax: 506.859.8019

folderfactory.ca

3075 – 14TH Avenue
Suite 209
Markham, ON
L3R 0G9
Ph: 905-940-2311
Fax: 905-940-1970

Label Division

1 - 521 Golspie Street
Winnipeg, MB
R2K 2T8
Tel: 204.697.8246
Toll Free: 800.661.5557
Fax: 204.632.4605

gotolabel.ca



Available Colours

- PINK
- RED
- TAN
- PURPLE
- YELLOW
- BROWN
- ORANGE
- GREEN
- TURQUOISE



COLOURED PAPER FOLDERS

- 11 PT (143#)
- 7/8" NOTCHED, R.E.T.
- 12 1/4" X 9 1/2"
- Sold in cartons of 500
45 lbs per carton
- STOCK ITEMS

ALL WEIGHTS

	COLOUR	WHITE / MANILA
SFI Chain of Custody Certified	Yes Bv-SFICOC-209908B	Yes Bv-SFICOC-209908B
PEFC Chain of Custody Certified	Yes	Yes
Acid-Free	Yes	Yes
Archival Quality	Yes	Yes
LOC Certified	No	No
PAT Compliant	No	Yes
Alkaline Reserve Available	>3%	>3%
Lignin Content	Virtually Lignin Free	Virtually Lignin Free
Recycle Content	10%	10%
100% Recyclable	Yes	Yes
Made from 100% Renewable Resource	Yes	Yes
Elemental Chlorine Free	Yes	Yes

File Quest

Finding the Right Solutions

FILE QUEST COLOURED PAPER FOLDERS

FULL BODY LAMINATE

PARTIAL LAMINATE

FO-1-MY0	SALMON	FO-1-MY0 'P'
FO-1-MY1	RED	FO-1-MY1 'P'
FO-1-22	LT ORANGE	FO-1-22 'P'
FO-1-32	DK ORANGE	FO-1-32 'P'
FO-1-42	LT GREEN	FO-1-42 'P'
FO-1-52	DK GREEN	FO-1-52 'P'
FO-1-62	BLUE	FO-1-62 'P'
FO-1-MY7	PURPLE	FO-1-MY7 'P'
FO-1-82	MAUVE	FO-1-82 'P'
FO-1-92	BROWN	FO-1-92 'P'
FO-1-Y2	YELLOW	FO-1-Y2 'P'
FO-4-02	CLEAR	FO-4-02 'P'
FO-1-02	DK SALMON	FO-1-02 'P'
FO-1 12	FUSCHIA	FO-1 12 'P'
FO-1-72	DK PURPLE	FO-1-72 'P'

- 15 PT (200#)
- 7/8" FULL SHELF
- REINFORCED END TAB
- LAMINATE WRAPS AROUND END TAB
- AVAILABLE IN FULL OR PARTIAL LAMINATE



FILE QUEST COLOURED PAPER FOLDERS

- 15 PT (185#)
- 7/8" FULL SHELF
- REINFORCED END TAB
- FULLY LAMINATED
- STOCK ITEM
- CARTON 300pc, 45lbs



FO-1-RED
FO-1-BLUE

FO-1-GREEN
FO-1-YELLOW

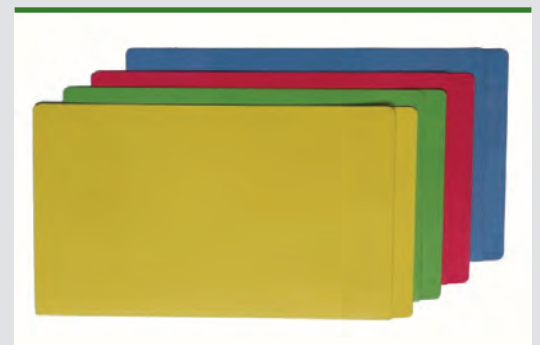

STANDARD SIDE TAB FILE FOLDERS

- Made from pearl white or Manila paper stock
- 100% acid free, archival quality, virtually lignin free
- 100% recyclable, 10% post-consumer recycled content
- Stock Itemsn (non-stock exceptions ‘*’)

Letter: 12 1/4" x 9 1/2" • Metric: 13" x 9 1/2" • Legal: 15 1/4" x 9 1/2"

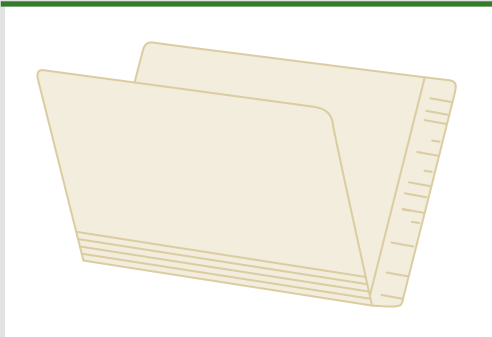

7/8" FULL SHELF, Reinforced End Tab

		QUANTITY / CARTON	WEIGHT / CARTON
FQ118	Letter Size, White, 11 pt, (143#)	100 / 500	45 lbs
FQ218	Letter Size, White, 14 pt, (180#)	100 / 400	45 lbs
FQ158	Metric Size, White, 11 pt, (143#)	100 / 500	48 lbs
FQ258	Metric Size, White, 14 pt, (180#)	100 / 400	47 lbs
FQ128	Legal Size, White, 11 pt, (143#)	100 / 500	54 lbs
FQ228	Legal Size, White, 14 pt, (180#)	100 / 400	54 lbs

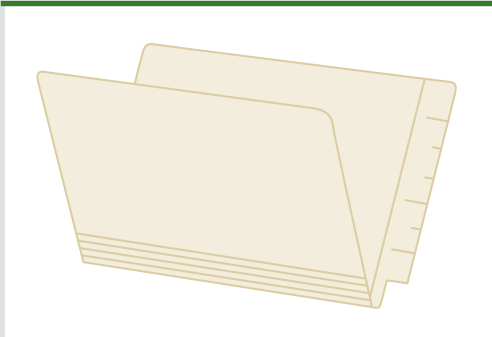

7/8" NOTCHED, Reinforced End Tab

		QUANTITY / CARTON	WEIGHT / CARTON
FQ117	Letter Size, White, 11 pt, (143#) *	100 / 500	45 lbs
FQ217	Letter Size, White, 14 pt, (180#)	100 / 400	45 lbs
FQ157	Metric Size, White, 11 pt, (143#) *	100 / 500	48 lbs
FQ257	Metric Size, White, 14 pt, (180#)	100 / 400	47 lbs
FQ127	Legal Size, White, 11 pt, (143#) *	100 / 500	54 lbs
FQ227	Legal Size, White, 14 pt, (180#)	100 / 400	54 lbs

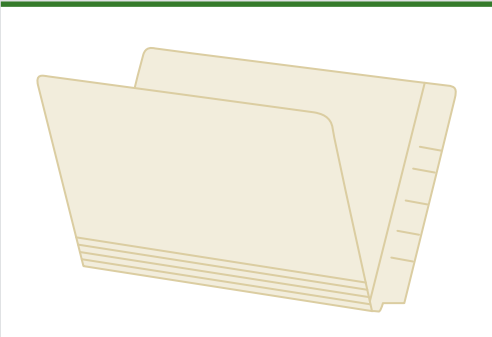

7/8" NOTCHED, Reinforced End Tab

		QUANTITY / CARTON	WEIGHT / CARTON
FQ1103	Letter Size, Manila, 11 pt, (143#)	100 / 500	45 lbs
FQ1123	Letter Size, Manila, 14 pt, (180#)	100 / 400	45 lbs
FQ1121	Metric Size, Manila, 11 pt, (143#)	100 / 500	48 lbs
FQ2702	Metric Size, Manila, 14 pt, (180#)	100 / 400	47 lbs
FQ1105	Legal Size, Manila, 11 pt, (143#)	100 / 500	54 lbs
FQ1127	Legal Size, Manila, 14 pt, (180#)	100 / 400	54 lbs

STANDARD TOP TAB FILE FOLDERS

- Stock Items
- Made from pearl white or Manila paper stock
- 100% acid free, archival quality, virtually lignin free
- 100% recyclable, 10% post-consumer recycled content

Letter: 12 1/4" x 9 1/2" • Metric: 13" x 9 1/2" • Legal: 15 1/4" x 9 1/2"



SINGLE PLY, REINFORCED TOP TAB

		QUANTITY / CARTON	WEIGHT / CARTON
A60DD	Manila, Legal size, 11 pt, (143#) 14 3/4 x 9 3/4" (8 1/2" front)	100 / 500	52 lbs
A50DD	Manila, Letter size, 11 pt, (143#) 11 3/4 x 9 3/4" (8 1/2" front)	100 / 500	43 lbs

SINGLE PLY, TOP TAB

4988/	Manila, Legal size, 14 pt, (180#)	100 / 500	56 lbs
56760	14 3/4 x 9 5/8" (8 3/4" front)		

COLOURED PAPER FOLDERS

- 15 PT (185#)
- 7/8" NOTCHED, R.E.T.
- 15 1/4" X 9 1/2"
- Sold in cartons of 400
52 lbs per carton
- STOCK ITEM



Available Colours
 LT GREEN
 RED
 PINK
 BLUE
 ORANGE
 LAVENDER
 YELLOW
 BROWN
 GOLDEN ROD
 GREY
 DK GREEN
 TURQUOISE



PRESSED BOARD FOLDERS

These tough, heavyweight folders resist wear and tear, making them perfect for bulky, heavily used files.

- Durable 28pt Pressed Board with sturdy Tyvek® gusset.
- Choose either End Tab or Top Tab.
- End Tab allows for the application of colour-coded adhesive labels for easy retrieval.
- Available sizes include **Letter**, **Legal** or **Custom dimensions**.



Available Colours: Dark Green, Turquoise, Light Green, Yellow, Blue, Red & White.

Pressed Board is your best choice for much-handled files. Tyvek® accordian-pleat gussets expand to hold 1, 2 or 3" material thickness



Add pockets, dividers or heatseal fasteners.



Sturdy dividers and fasteners allow subdivisions within a folder. Spring Arch fasteners are both durable and efficient, allowing easy acces.

Pages may be removal or added without disturbing existing pages.



POCKETS, POUCHES & JACKETS

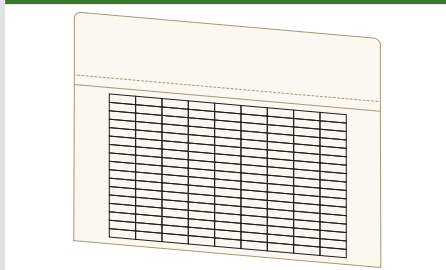

911 Pocket *

12 x 9 1/4" Back, 6 1/8" Front
White 11pt (143#), **Plain** or **Printed**
Scoreline at 6 1/2" for flap

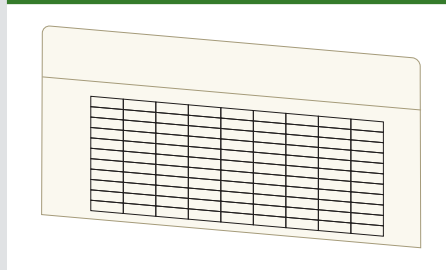

712 Pocket

12 x 6" Back, 4 3/8" Front
White 11pt (143#), **Plain** or **Printed**

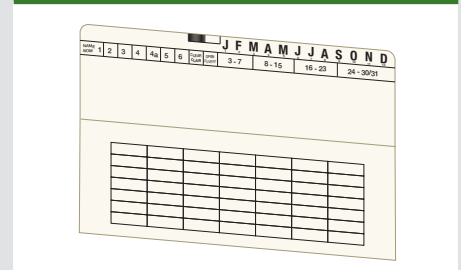

845 Pouch

8 3/4 x 6" Back, 3 1/4" Front
White 11pt (143#) or **Printed**



8321 Pocket

9 1/4 x 6 3/4" Back, 6 1/4" Front
White or **Manila** 11pt (143#)

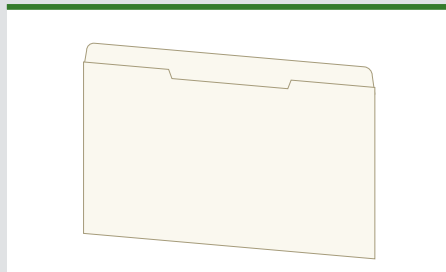

97904 Pouch

9 1/4 x 6" Back, 5 1/2" Front
Kraft 9pt (110#)



485 Pocket

12 1/8 x 6" Back, 5 1/2" Front **OR**
12 1/16 x 6" Back, 5 1/2" Front
White 11pt (143#)

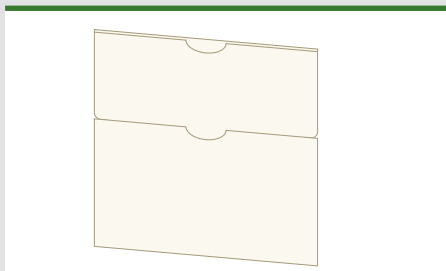

Double Dental Pocket

8 3/4 x 8 1/2" Bottom Pocket
White or **Manila** 11pt (143#)



1168 – 11pt & 14pt *

12 x 9 1/2" **Manila** 11pt (143#)
12 x 9 1/2" **Manila** 14pt (180#)



X-Ray Jacket – Manila *

XR-11, 11pt (143#)	XR-11, 14pt (180#)
Carton 100pc	Carton 100pc
21 lbs	25 lbs

*** NON-STOCK ITEM**

POCKET FOLDERS, DIVIDERS & POLY POUCHES

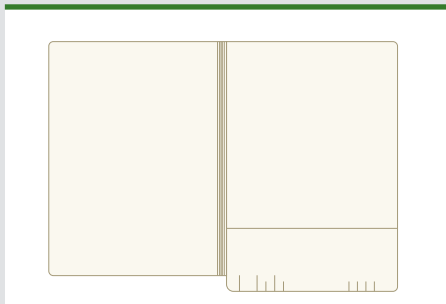

3833 SBS

WHITE 14pt (#180), CLAY COATED
 SIZE 13 x 9 1/2"
 END TAB 7/8"
 INTEGRATED POCKET, 3 1/2 X 9 1/2"
 CARTON, 250 pcs., 32lbs.

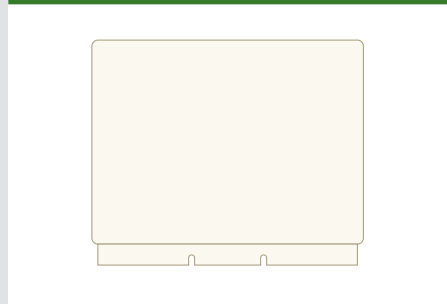

26330 SBS

WHITE 14pt (#180), CLAY COATED
 SIZE 12 1/16 x 9"
 SELF ADHESIVE 15/16" glue tab
 PACKAGE, 100 pcs., 5lbs.
 May be factory installed.

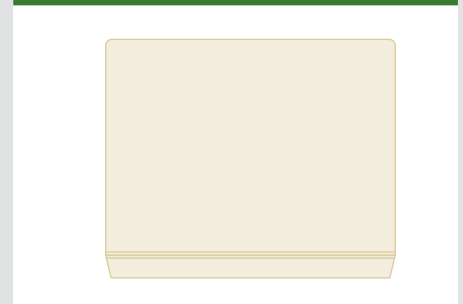

26330 DIVIDER

WHITE or MANILA 11pt (#143)
 SIZE 11 5/8 x 8 1/2"
 SELF ADHESIVE 7/8" glue tab
 PACKAGE, 100 pcs., 4lbs.
 May be factory installed.

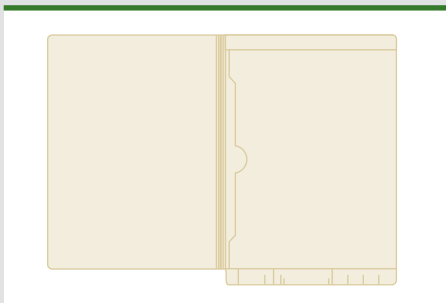

MPF-10

MANILA 14pt (#180)
 SIZE 12 1/4 x 9 1/2"
 END TAB 3/4"
 INTEGRATED POCKET, 9 1/4 X 12 1/4"
 CARTON, 250 pcs., 45lbs.

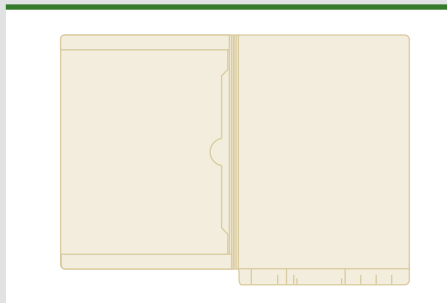

MPF-A10

MANILA 14pt (#180)
 SIZE 12 1/4 x 9 1/2"
 END TAB 3/4"
 INTEGRATED POCKET, 9 1/4 X 12 1/4"
 CARTON, 250 pcs., 45lbs.

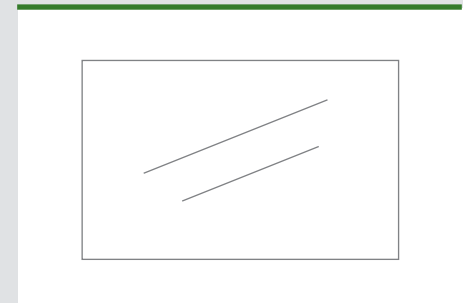

Polyethylene Pockets

97911	2 1/2 x 3 1/4"
97915	3 3/4 x 5"
DD-9060	4 1/2 x 6"
97917	5 1/2 x 8 3/4"

*opening edge

DENTAL POCKETS & POUCHES

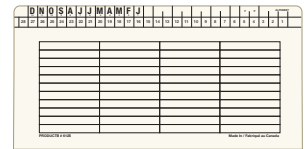
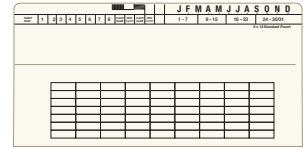
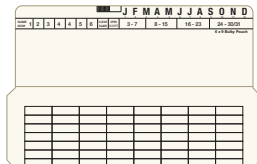
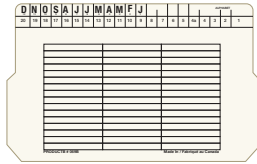
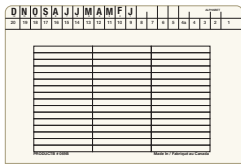
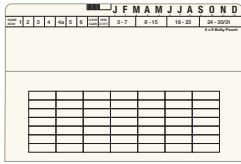

FF-069s – 6 x 9" Standard

SBS 14pt (180#), Clay-coated

FF-845 – 6 x 9" Bulky

SBS 14pt (180#), Clay-coated

FF-612s – 6 x 12" Standard

SBS 14pt (180#), Clay-coated

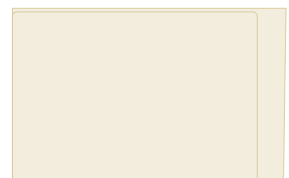
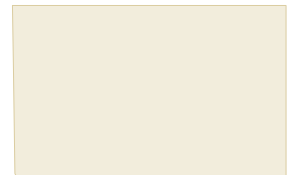
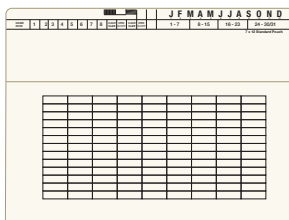
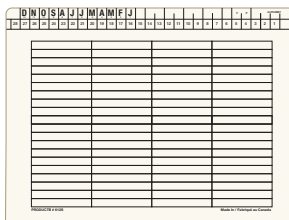
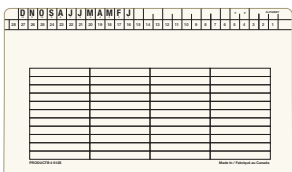
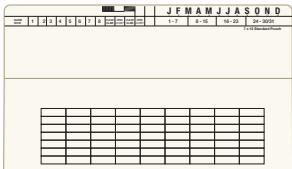

FF-712s – 7 x 12" Standard

SBS 14pt (180#), Clay-coated

FF-912s – 9 x 12" Standard

SBS 14pt (180#), Clay-coated

FF-PP943 – 6 x 9 1/2" Manila

SBS 14pt (180#), Clay-coated

POLY POCKETS & FASTENERS

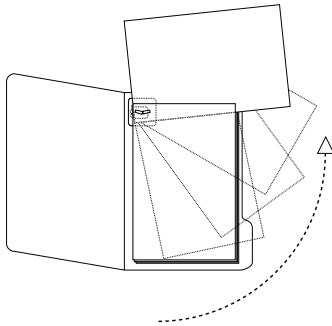

The Fabrene Tip Back Patch allows you to punch records with a single hole in the top left corner, enabling the user to swing pages out of the way and reveal more of the record without damage. These patches are perfect for law firms.

Brass fasteners sold separately.

Fabrene Tip Back Patches



Turn any folder, even hanging folders, into a 2" capacity binder. Makes copying and reading contents easy by permitting folder to open flat. Remove and replace documents anywhere within the file without removing other pages. Compressor holds paper securely in binder when not in use. Adhesive back. Can be installed in any folder.

Copy Clip

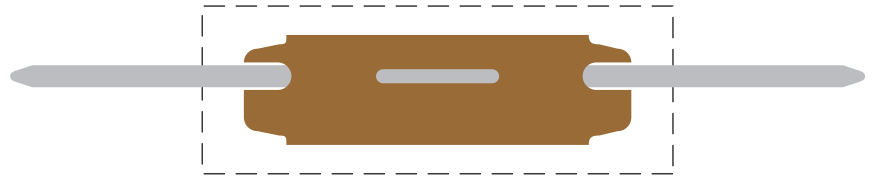

DD-5325 Fasteners

2" Bonded fasteners • 2 3/4" Centres • 4 1/2" backing • Enameled metal

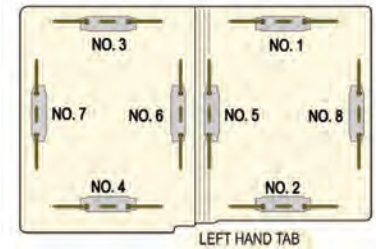
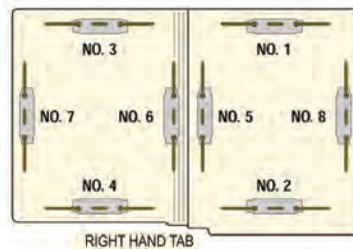

Fastener Placement Options

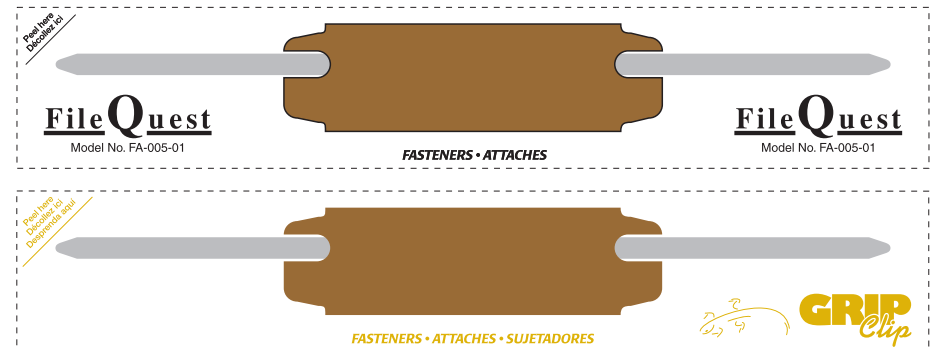

Self-adhesive Fasteners

1 1/2" x 8 1/2" adhesive band allows for easy centering without a guide.

GRIP-CLIP – Paper Backing

FA-005-01 – Vinyl Backing

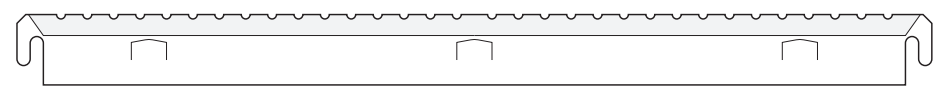

Plastic File Hangers

B1-100 – 9" Hanger • B2-100 – 12" Hanger
Packs of 100