

# BOSS

FUNCTION  
MANAGEMENT  
SYSTEM





# BOSS

FUNCTION  
MANAGEMENT  
SYSTEM



 **FUNCTIONSMITH, INC.**  
MANILA • GUANGZHOU

**Have a look and style.** The attractive appearance can always catch people's eyes at a glance. The romantic blue brings a refreshing feeling, as if you are in a wide ocean, feeling the extension of the space. The delicate touch of the table top has a wood grain texture, and every touch you can feel the relationship with nature. The intimacy of picking up.

**MFC** :EZ-W04  
EZ-W10

**MFC sheet** :EZ-W04 gray shadow oak,  
EZ-W10 polar lights blue

**Boss**

Executive Desk System



**MODERN AND**  
**FASHIONABLE COLORS**



**Side door of auxiliary cabinet:** The side door of the auxiliary cabinet can be opened to facilitate the placement of the host and plug-in cables. The partition in the middle increases the availability and can store packages.

**Carbon black aluminum alloy edge banding:** The noble and low-key cold feeling, the hand feels smooth, and the edge sealing process is meticulous. It creates a noble atmosphere in a low-key manner.

**Press the lifting socket:** When you don't need to use the socket, you can press it down, so that the entire desktop will be flatter and more beautiful. Raise it when you use it, and there will be no trouble of messy wiring like ordinary power strips.



Boss

Executive Desk System





## CALM AND STEADY EXTRAORDINARY



**Sub-cabinet function:** The auxiliary cabinet drawer is equipped with a mechanical code lock, which is locked with four digits. When the code is forgotten, it can be opened with a matched key and the code can be reset. With a cooling fan, it effectively helps the host cool down.

**MFC sheet:** EZ-W06 imprint hill walnut, EZ-W11 gray of drift sand formation.

**MFC:** EZ-W06  
EZ-W11

Boss

Executive Desk System



FUNCTIONSMITH, INC.

MANILA • GUANGZHOU







**FUNCTIONSMITH, INC.**

MANILA • GUANGZHOU



MFC sheet: EZ-W08 Snowflake white

MFC :EZ-W08-W08



## EDGE BANDING



**Alumina material edge banding:** It is the most simple decoration as well as edge banding. When the light shines through, the reflective characteristics of aluminum will make the entire desk more dazzling. The refreshing touch makes every contact feel fresh and pleasant. The aluminum edge sealing is like an indispensable seasoning in delicious dishes, adding the finishing touch.

**Oxidized aluminum alloy joint:** The joint position is round and smooth, and you will not feel pain because of the sharp corner of the table if you accidentally hit it.



FUNCTIONSMITH, INC.

MANILA • GUANGZHOU



## LIGHT STRIP CLOSE-UP

MFC sheet EZ-W08 snowflake white

**Close-up of the light strip:** After adding the light strip, it will be more stylish. The warm yellow light shines on the cabinet, and the warm atmosphere will be more prominent. The addition of aluminum edge-sealing makes the whole cabinet present a sense of exquisiteness, echoing the warm yellow light strip, with a layer of warm light glowing slightly. Extremely elegant.

# NATURAL WARMTH DELICATE TOUCH



**There is beauty and style:** modern and stylish minimalist design, natural lit wood grain texture. The warm wood tone harmonizes with the pure white, forming a gentle and hearty style. The warm sun shines in in the afternoon, and the warm temperament is fully displayed. The addition of the oxidized aluminum alloy edge will make the whole body more clear, warm and cold, and fresher.

MFC sheet E2-W08 snowflake white E2-W10 european maple

MFC E2-W08 E2-W10



# SIDE CABINET



**MFC:**EZ-W08, EZ-W13

**MFC sheet:**EZ-W08 snowflake white,EZ-W13 european maple

**There is beauty and style:**There are high and low, light and heavy. Responding to each other and balancing each other, this kind of side cabinet collocation will not grab the focus of the space, but will add a wonderful sense of hierarchy to the space. The warm tones also add a pleasant brushstroke to the overall space. The wood grain is natural and fresh. It seems to be in the middle of nature, warm and comfortable.

**Storage space:**Large storage space and multi-layer separation can classify documents well. Documents or objects that need to be protected can be placed in an encrypted cabinet for protection. Equipped with a new type of code lock, the four-character lock is more secure, even if the code is lost, it can be opened with a matching key and reset. Safe and convenient.

**BSED-01**

(W\*D\*H)  
2800 X 2000 X 750  
3000 X 2000 X 750

Main table: (2600-2800) X 1000 X 750  
Auxiliary Cabinet: 2000 X 600 X 625



This model uses EZ-W04 Grey Shadow Oak and EZ-W10 Aurora Blue

This model uses EZ-W04 gray shadow oak and EZ-W10 polar lights blue

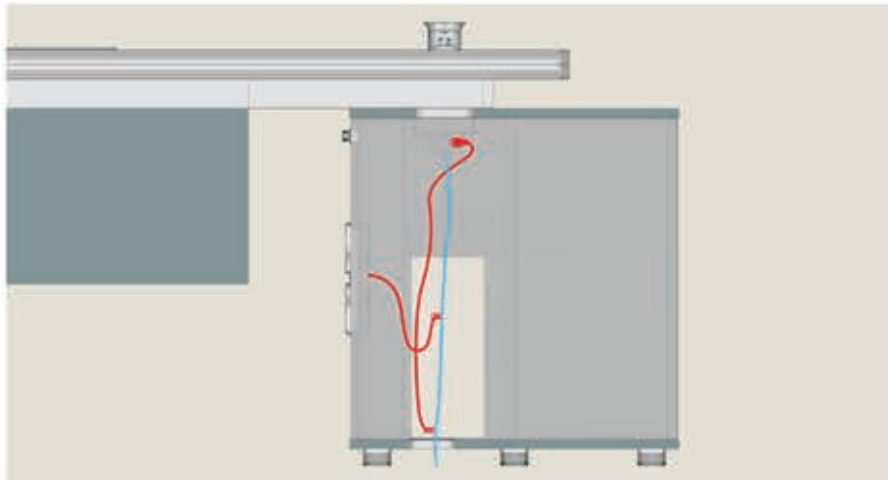
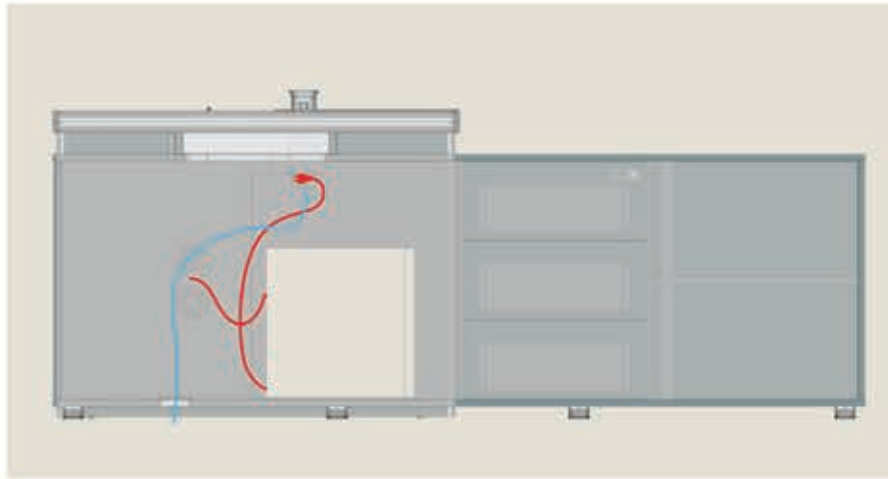

Auxiliary cabinet wiring diagram  
(The desk line is the same)



Top view



Rear view



Front view

**BSED-02**

(W\*D\*H)  
2400 X 2000 X 750  
2600 X 2000 X 750

Main table: (2200-2400) X 1000 X 750  
Auxiliary Cabinet: 2000 X 600 X 625



This model adopts EZ-W06 printed hickory and EZ-W11 Quicksand Grey

This model uses EZ-W06 imprint hill walnut and EZ-W11 gray of drift sand formation



Top view



Front view



Rear view

**BSED-03**

(W\*D\*H)  
2000 X 1800 X 750  
2200 X 1800 X 750

Main table: (1800-2000) X 900 X 750  
Auxiliary Cabinet: 1800 X 600 X 625



This model adopts EZ-W08 Snowflakes

This model uses EZ-W08 snowflake white



Top view



Front view



Rear view



# BOSS

## PRODUCT MAP Executive Desk

### BSED-04

(W\*D\*H)

1600 X 800 X 750

1800 X 800 X 750



This model uses EZ-W13  
european maple.

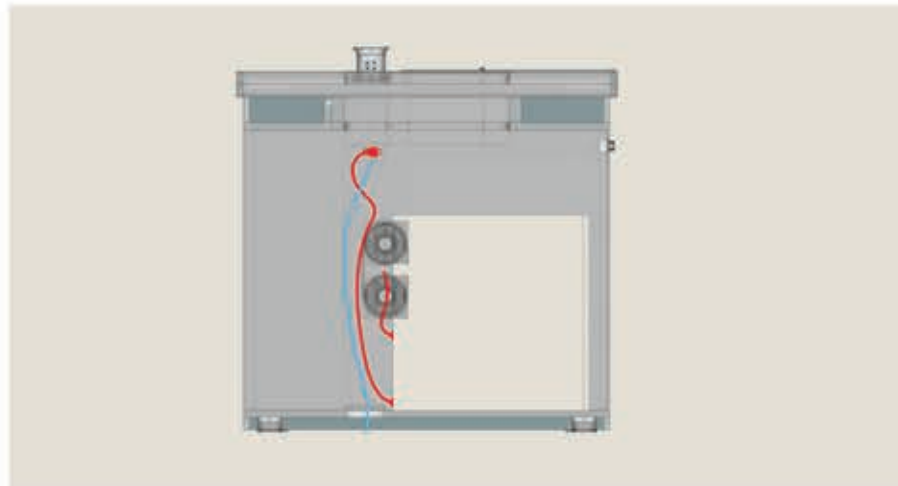
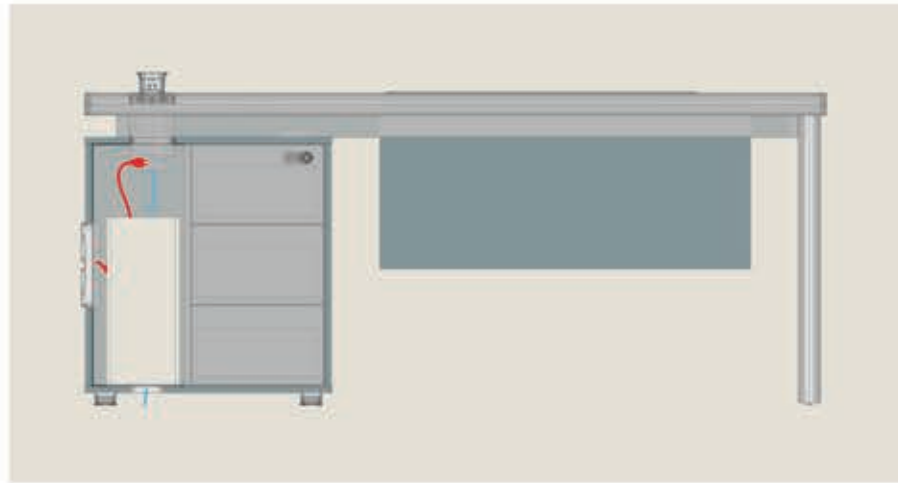

Auxiliary cabinet wiring diagram



Top view



Front view



Rear view



## PRODUCT MAP FILE CABINET

G-BSFC-01

(W\*D\*H)  
3250 X 400 X 2000  
3850 X 400 X 2000



This model uses EZ-W04 gray shadow oak and EZ-W10 polar lights blue



Top view



Side view



Front view

The new coded lock is adopted, and there are hangers in the cabinet, multi-storage, clear classification, and the configuration of the light belt is more beautiful.

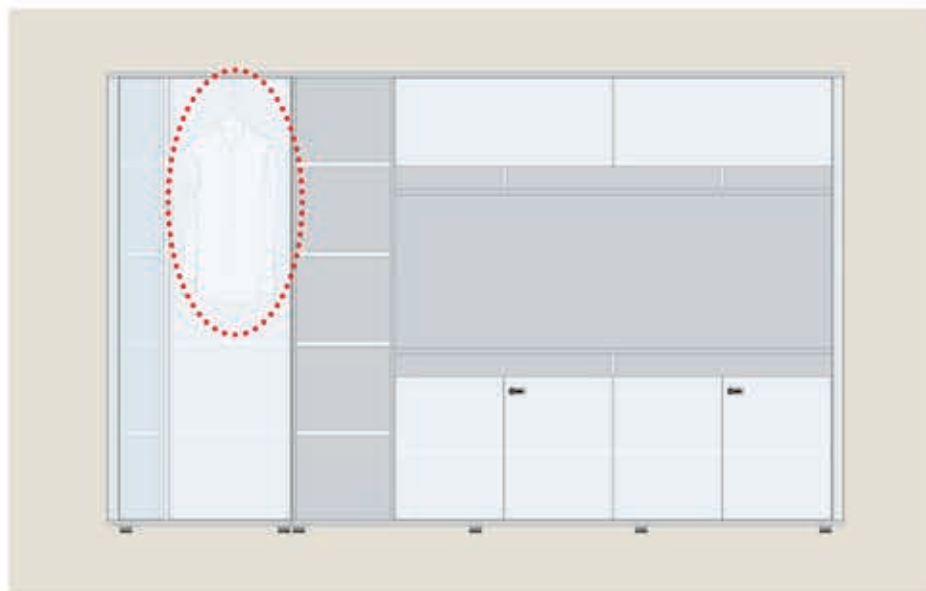

G-BSFC-02

(W\*D\*H)  
2850 X 400 X 2000  
3250 X 400 X 2000



This model uses EZ-W06 imprint hill walnut and EZ-W11 gray of drift sand formation



Top view



Side view

The new coded lock is adopted, and there are hangers in the cabinet, multi-storage, clear classification, and the configuration of the light belt is more beautiful. The open areas are well-arranged, giving the display platform a sense of design and hierarchy.



Front view

**G-BSFC-03**

(W\*D\*H)  
2400 X 400 X 2000  
2800 X 400 X 2000



This model uses EZ-W08  
snowflake white



Top view



Side view



Front view

There will be more open areas  
and more display space. The  
new code lock is also adopted.

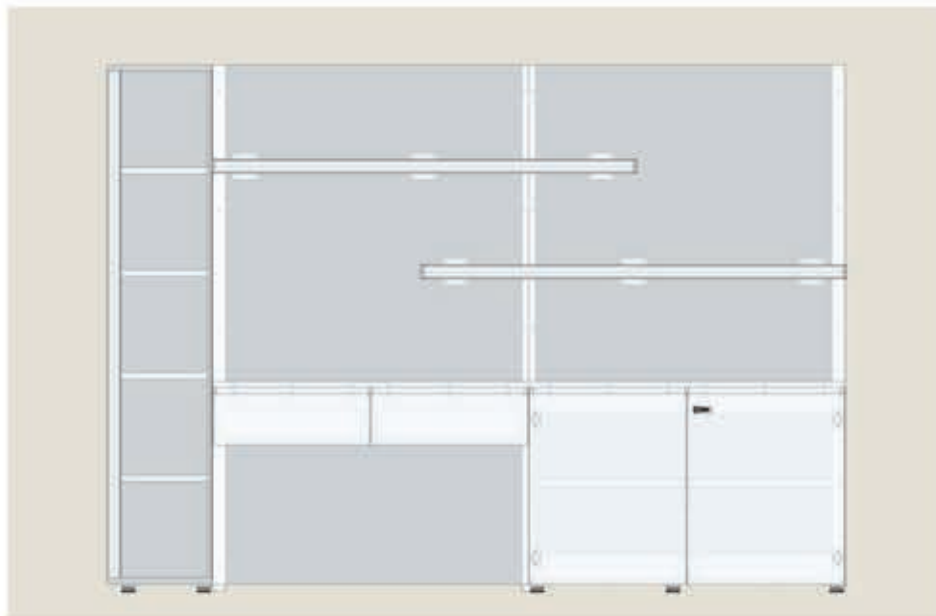

**A-BSFC-04**

(W\*D\*H)  
2400 X 400 X 950  
3000 X 400 X 950



This model uses EZ-W13  
european maple



Top view



Side view

The storage space of  
A-BSFC-04 is closed and  
protected by two password  
locks. The open area of  
the countertop can be  
decorated with accessories  
to show the charm of  
personal taste.

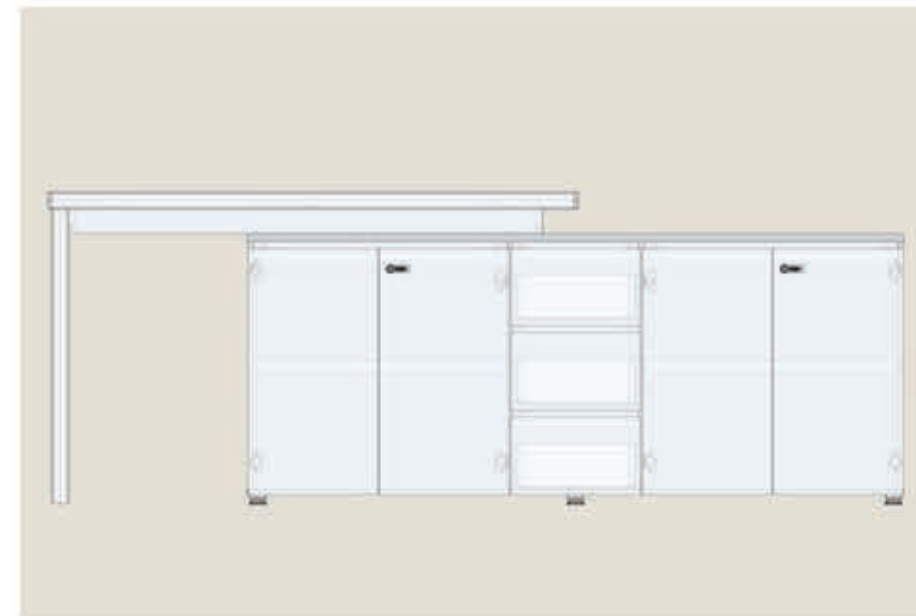

Front view



# BOSS

## PRODUCT MAP Tea table

### BSTT-01/BSTT-02

(W\*D\*H)  
 1400 X 600 X 450  
 600 X 600 X 450

This model uses EZ-W08  
 snowflake white,EZ-W10 polar  
 lights blue,EZ-W17 yashi white  
 stone patten.



BSTT-01



BSTT-02

Boss

Executive Desk System



FUNCTIONSMITH, INC.  
MANILA • GUANGZHOU





# FASHION SPLICING ENHANCED LAYERING



**During the meeting:**the desktop is spacious, and the conversation is more relaxed in an instant. The color is distinct, the modern fashion is strong, and the sense of hierarchy is strengthened. There is ample space for knees under the table, which avoids the embarrassment between the legs and focuses more on the meeting. The socket adopts a pressing lifting socket, which avoids the trouble of finding a power source when electricity is needed, and is neat and clean and more professional. Press the lifting socket for wireless charging, which is smarter and more convenient.

**MFC sheet**EZ-W04 ray shadow oak;  
EZ-W10 Polar lights blue



**During the meeting:** the pure white conference table will be more simple overall. There is no other extra color to add, but it will be more capable and crisp. Simplicity can better reflect its sophistication, and existence is decoration. While having a pleasant meeting, it can also be pleasing to the eyes. In addition, pressing the lifting socket is also an important reason for improving the aesthetics. It avoids the clutter of using power strips, and can be wirelessly charged, which is smarter and more convenient.

MFC sheet E2-W08 snowflake white



FUNCTIONSMITH, INC.

MANILA • GUANGZHOU



# PURE WHITE TABLE TOP ALUMINUM EDGE BANDING

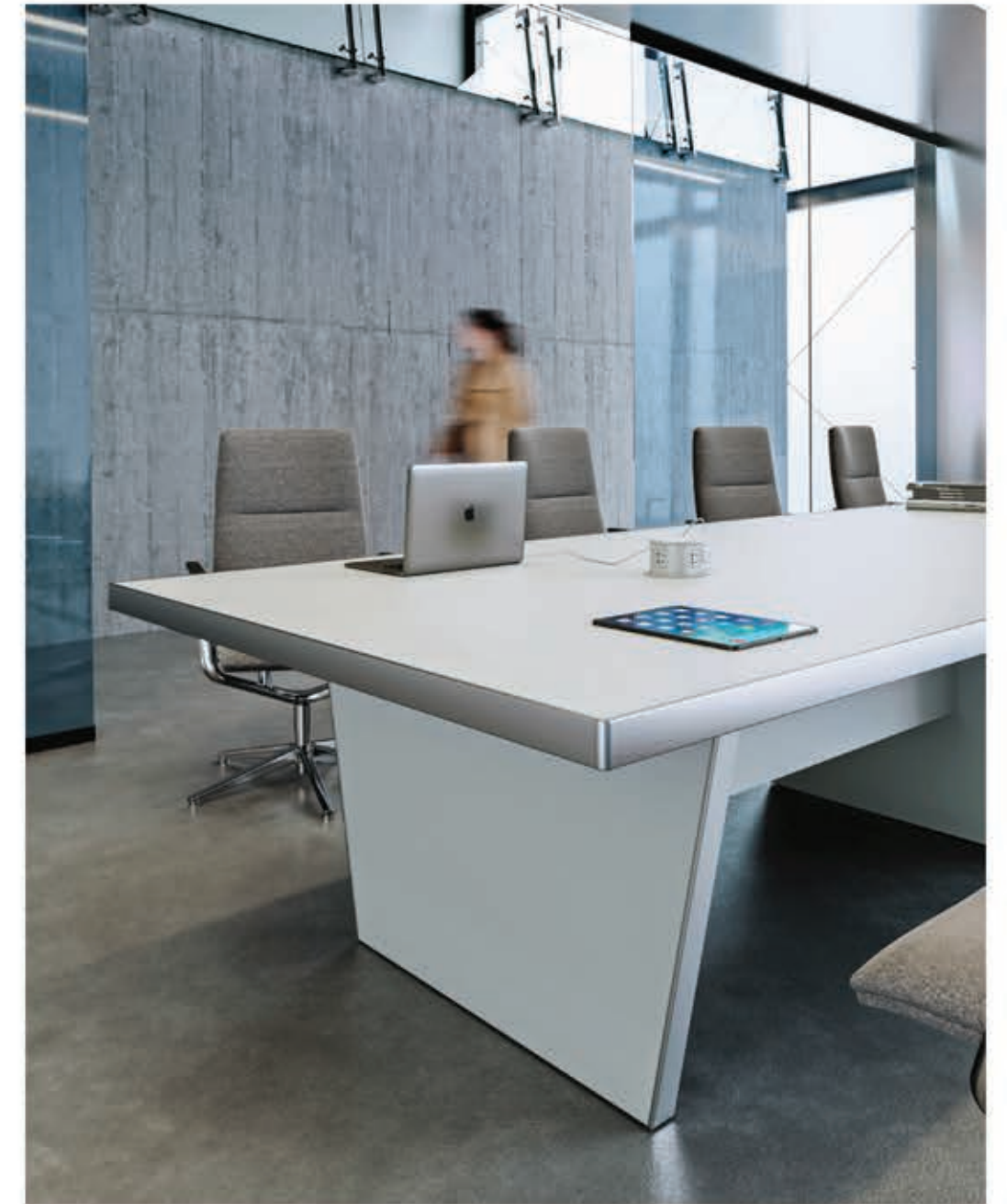





FUNCTIONSMITH, INC.

MANILA • GUANGZHOU



MFC sheet: EZ-W13 european maple  
MFC 板材: EZ-W13 欧洲枫木



# BOSS

## PRODUCT MAP Conference table

### BSCT-01

(W\*D\*H)  
1800 X 900 X 750  
2000 X 1000 X 750  
2200 X 1200 X 750  
2400 X 1200 X 750



This model uses EZ-W13  
european maple

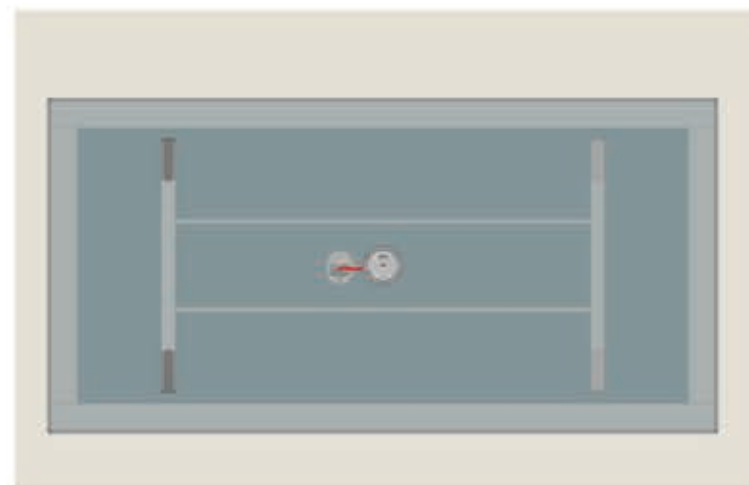

Top view / 俯视图

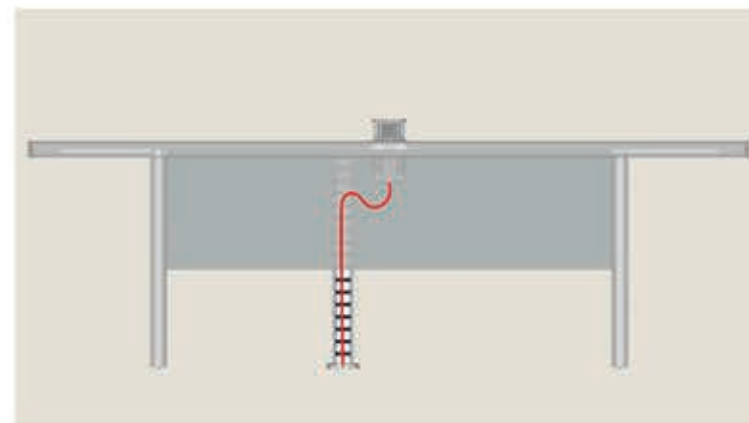

Front view / 前视图

会议桌走线示意图  
Conference table wiring diagram

**BSCT-02**

(W\*D\*H)  
3000 X 1200 X 750  
3200 X 1200 X 750  
3600 X 1200 X 750



This model uses EZ-W08 snowflake white

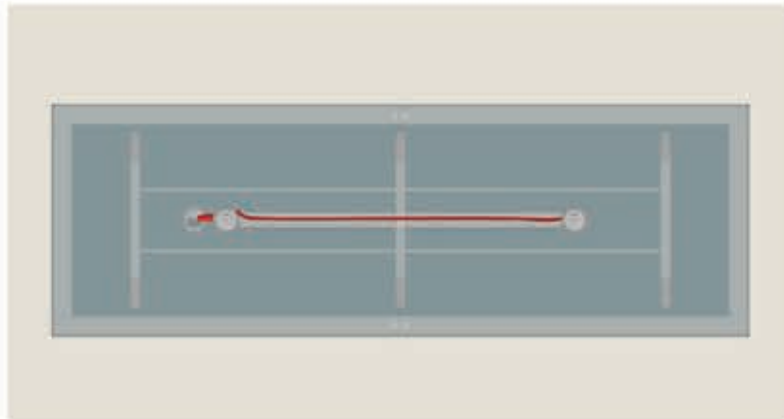

Top view

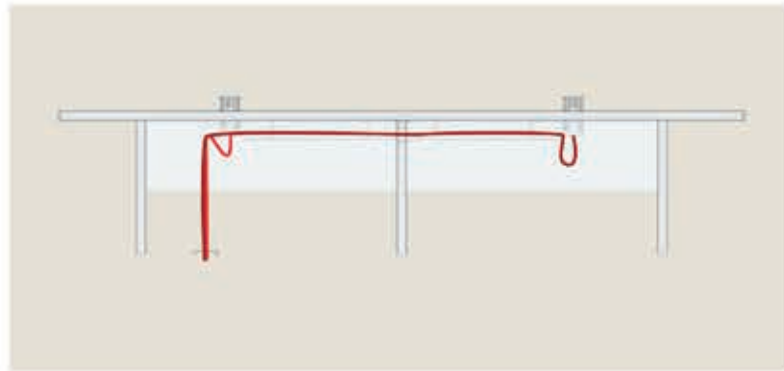

Front view

Conference table wiring diagram

**BSCT-03**

(W\*D\*H)  
4000 X 1500 X 750  
4200 X 1500 X 750  
4600 X 1500 X 750  
5200 X 1500 X 750



This model uses EZ-W04 gray shadow oak and EZ-W10 polar lights blue

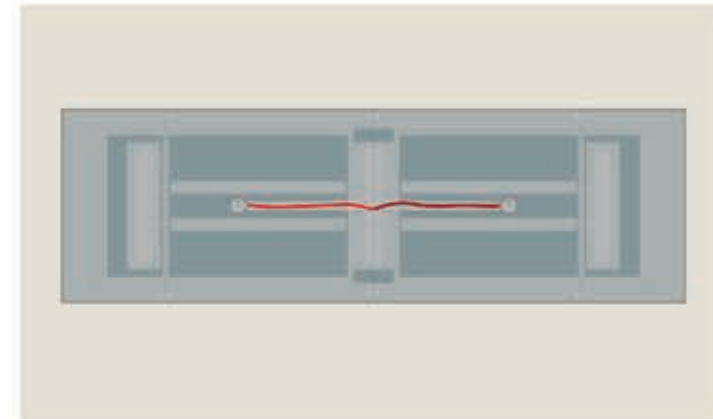

Top view

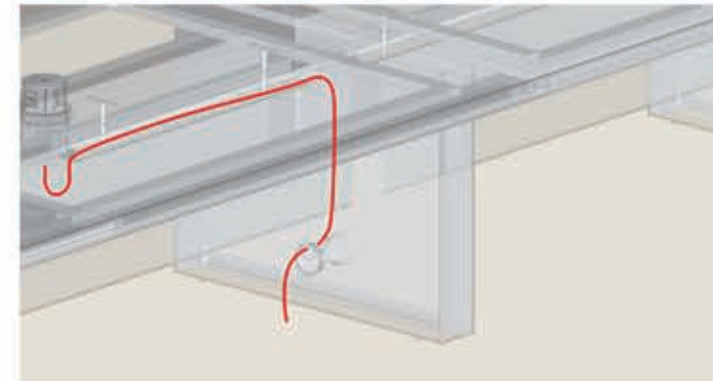

Front view

Conference table wiring diagram

# BOSS

## MFC SHEET



**EZ-W01**  
*Plain and elegance elm*



**EZ-W02**  
*Daystart lake oak*



**EZ-W03**  
*Boundary oak*



**EZ-W04**  
*Gray shadow oak*



**EZ-W05**  
*Desert oak*



**EZ-W06**  
*Imprint hill walnut*



**EZ-W07**  
*Lingering charm stone gray*



**EZ-W08**  
*Snowflake white*



**EZ-W09**  
*Bamboo cyan*



**EZ-W10**  
*Polar lights blue*



**EZ-W11**  
*Gray of drift sand formation*



**EZ-W12**  
*Ancient city wall gray*



**EZ-W13**  
*European Maple*



**EZ-W14**  
*American fir*



**EZ-W15**  
*Canadian maple*



**EZ-W16**  
*White oak*



**EZ-W17**  
*Yoshi white stone pattern*



**EZ-W18**  
*Black jade and black stone pattern*

## ALUMINUM EDGE BANDING COLOR



*Alumina material edge banding  
(joint is aluminum alloy)*



*Carbon black aluminum edge banding  
(joint is aluminum alloy)*



**FUNCTIONSMITH, INC.**  
MANILA • GUANGZHOU

# BOSS