

# **PILOT'S OPERATING HANDBOOK AND FAA APPROVED AIRPLANE FLIGHT MANUAL**

## **PIPER PA-30 TWIN COMANCHE**

3600 POUNDS GROSS WEIGHT

1963 THROUGH 1969 (NORMALLY ASPIRATED MODEL ONLY)

APPLICABLE TO AIRPLANES WITH SERIAL NUMBERS:  
30-1 THROUGH 30-2000

## **SECOND ISSUE**

Copyright © 1993 & 1996 Douglas L. Killough. All Rights Reserved.  
Composed and Printed in the United States of America.

Published By: Aircraft Publications  
Austin, Texas

# PILOT'S OPERATING HANDBOOK AND FAA APPROVED AIRPLANE FLIGHT MANUAL

PIPER PA-30 TWIN COMANCHE

3600 POUNDS GROSS WEIGHT

1963 THROUGH 1969 (NORMALLY ASPIRATED MODEL ONLY)

APPLICABLE TO AIRPLANES WITH SERIAL NUMBERS:  
30-1 THROUGH 30-2000

THIS DOCUMENT IS COMPOSED OF A COMPILATION OF INFORMATION INCLUDING INFORMATION PROVIDED BY THE AIRCRAFT MANUFACTURER AND CONSTITUTES THE PILOT'S OPERATING HANDBOOK AND FAA APPROVED AIRPLANE FLIGHT MANUAL. ONLY SECTION 2 (LIMITATIONS) WITHIN THIS HANDBOOK IS FAA APPROVED.

This Handbook is modeled on GAMA Specification No. 1, *Specification for Pilot's Operating Handbook*, issued February 15, 1975, and revised September 1, 1984.

The airplane is FAA approved in the Normal category based on CAR Part 3.

THIS DOCUMENT OR PIPER REPORT 1269 OR 1515 MUST BE CARRIED IN THE AIRPLANE AT ALL TIMES AND MUST BE ACCESSIBLE TO THE PILOT DURING FLIGHT.

Approved by the Federal Aviation Administration

By:



Mark R. Schilling, Manager  
Special Certification Office  
Federal Aviation Administration  
Fort Worth, Texas 76193-0190

Date: December 15, 1993

### AIRPLANE FLIGHT MANUAL LOG OF REVISIONS

This Log of Revisions page is used to maintain a listing of all revised pages in Section 2, which is the FAA Approved Airplane Flight Manual.

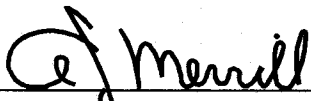
Revision Number	Pages Revised	Description of Revision	FAA Approval Signature & Date
<u>Rev. 1</u>	<u>2-1</u>	<u>Revised Table of Contents</u>	
	<u>2-2</u>	<u>Revised IAS-CAS</u>	
	<u>2-3</u>	<u>Added Airspeed Note CAS</u>	
	<u>2-5</u>	<u>Added PAC Drawings</u>	
	<u>2-6</u>	<u>Revised Other and Placards</u>	
	<u>2-7</u>	<u>Revised Placards</u>	
	<u>2-8</u>	<u>Added Procedures</u>	
	<u>2-9</u>	<u>Added Procedures</u>	
	<u>2-10</u>	<u>Added Procedures</u>	
	<u>2-11</u>	<u>Added Procedures</u>	 A. J. Merrill, Manager Special Certification Office Federal Aviation Administration Fort Worth, Texas 76193-0190 Date: December 31, 1996



# PILOT'S OPERATING HANDBOOK AND FAA APPROVED AIRPLANE FLIGHT MANUAL

PIPER PA-30 \* 3600 LBS GROSS WEIGHT

## Table of Contents

PREAMBLE .....	SECTION 0
GENERAL .....	SECTION 1
LIMITATIONS .....	SECTION 2
EMERGENCY PROCEDURES .....	SECTION 3
NORMAL PROCEDURES .....	SECTION 4
PERFORMANCE .....	SECTION 5
WEIGHT AND BALANCE .....	SECTION 6
SYSTEMS DESCRIPTION .....	SECTION 7
MAINTENANCE .....	SECTION 8
SUPPLEMENTS .....	SECTION 9
SAFETY INFORMATION .....	SECTION 10

## INTRODUCTION

This Pilot's Operating Handbook may be used as the FAA approved Airplane Flight Manual only if kept current. When this Handbook is used for airplane operational purposes, it is the responsibility of the owner/pilot to maintain it in a current status and to ensure that all pertinent data (including weight and balance and required supplements) are recorded in this Handbook.

## APPLICABILITY

Application of the information contained in this Handbook is limited to the specific group of Piper PA-30 airplanes as designated on the title page of this Handbook.

## NOTICE TO ALL PILOTS

This Handbook is intended to be used as a guide for the pilot in the operation of the airplane. It is not meant to be a substitute for adequate and competent flight instruction.

Information contained herein is designed to provide the pilot with a general knowledge of the airplane, and specific suggested Normal and Emergency Operating Procedures. It is intended to promote safety and is presented to enable the pilot to form, in advance, a plan of action for coping with the most probable situations that could occur in the operation of the airplane.

Assurance that the aircraft is maintained in an airworthy condition is the responsibility of the owner. The pilot-in-command is responsible for determining that the aircraft is safe for flight.

## SCOPE

This Handbook is divided into 10 numbered sections. Each section can be equipped with a tab divider for easier access to information that may be required in flight. With few exceptions, information presented herein does not consider any modifications that may have been made to the original aircraft.

Section 1 is information of **General** interest. The information presented is an overview of basic physical data, and performance specifications. Included also is an extensive glossary to clarify specific terms, some of which have conflicting usage or definitions that are different from contemporary usage. A table of conversion factors is included to address international usage and distribution.

Section 2 is operating **Limitations**. This section of the Handbook includes material required to be furnished to the pilot by Federal Aviation Regulations. Section 2 is the FAA approved part of this Handbook, and constitutes the Airplane Flight Manual. The pilot is by law responsible for remaining within the operating limitations as directed by instrument markings and placards located in the airplane and outlined in this section.

Section 3 is **Emergency Procedures**. This section can be equipped with a red tab divider for instant identification. The procedures are suggested as a course of action for coping with the particular condition described, but are not intended to be a substitute for sound judgment and common sense. It is recommended that the pilot review standard emergency procedures periodically with a Certified Flight Instructor to remain proficient in them.

Section 4 is **Normal Procedures**. This section can be equipped with a blue tab divider for instant identification. The procedures are intended as a source of reference and review, and to provide information on procedures that are not the same for all PA-30 aircraft. All of the procedures necessary for operation, as determined by the design features of the airplane, are presented.



# PILOT'S OPERATING HANDBOOK AND FAA APPROVED AIRPLANE FLIGHT MANUAL

PIPER PA-30 \* 3600 LBS GROSS WEIGHT

## Table of Contents

PREAMBLE .....	SECTION 0
GENERAL .....	SECTION 1
LIMITATIONS .....	SECTION 2
EMERGENCY PROCEDURES .....	SECTION 3
NORMAL PROCEDURES .....	SECTION 4
PERFORMANCE .....	SECTION 5
WEIGHT AND BALANCE .....	SECTION 6
SYSTEMS DESCRIPTION .....	SECTION 7
MAINTENANCE .....	SECTION 8
SUPPLEMENTS .....	SECTION 9
SAFETY INFORMATION .....	SECTION 10



## INTRODUCTION

This Pilot's Operating Handbook may be used as the FAA approved Airplane Flight Manual only if kept current. When this Handbook is used for airplane operational purposes, it is the responsibility of the owner/pilot to maintain it in a current status and to ensure that all pertinent data (including weight and balance and required supplements) are recorded in this Handbook.

## APPLICABILITY

Application of the information contained in this Handbook is limited to the specific group of Piper PA-30 airplanes as designated on the title page of this Handbook.

## NOTICE TO ALL PILOTS

This Handbook is intended to be used as a guide for the pilot in the operation of the airplane. It is not meant to be a substitute for adequate and competent flight instruction.

Information contained herein is designed to provide the pilot with a general knowledge of the airplane, and specific suggested Normal and Emergency Operating Procedures. It is intended to promote safety and is presented to enable the pilot to form, in advance, a plan of action for coping with the most probable situations that could occur in the operation of the airplane.

Assurance that the aircraft is maintained in an airworthy condition is the responsibility of the owner. The pilot-in-command is responsible for determining that the aircraft is safe for flight.

## SCOPE

This Handbook is divided into 10 numbered sections. Each section can be equipped with a tab divider for easier access to information that may be required in flight. With few exceptions, information presented herein does not consider any modifications that may have been made to the original aircraft.

Section 1 is information of **General** interest. The information presented is an overview of basic physical data, and performance specifications. Included also is an extensive glossary to clarify specific terms, some of which have conflicting usage or definitions that are different from contemporary usage. A table of conversion factors is included to address international usage and distribution.

Section 2 is operating **Limitations**. This section of the Handbook includes material required to be furnished to the pilot by Federal Aviation Regulations. Section 2 is the FAA approved part of this Handbook, and constitutes the Airplane Flight Manual. The pilot is by law responsible for remaining within the operating limitations as directed by instrument markings and placards located in the airplane and outlined in this section.

Section 3 is **Emergency Procedures**. This section can be equipped with a red tab divider for instant identification. The procedures are suggested as a course of action for coping with the particular condition described, but are not intended to be a substitute for sound judgment and common sense. It is recommended that the pilot review standard emergency procedures periodically with a Certified Flight Instructor to remain proficient in them.

Section 4 is **Normal Procedures**. This section can be equipped with a blue tab divider for instant identification. The procedures are intended as a source of reference and review, and to provide information on procedures that are not the same for all PA-30 aircraft. All of the procedures necessary for operation, as determined by the design features of the airplane, are presented.

Section 5 is airplane **Performance**. The information presented in this section is based on measured flight test data provided by Piper Aircraft. The data is presented in tabular and/or graphical form to illustrate the effect of different variables. A flight planning example is given which utilizes this data.

Section 6 is **Weight and Balance**. A procedure for calculating the weight and moment as well as a list of all equipment is provided. The aircraft owner can obtain the aid of an A&P mechanic to fill in this section with proper data. The pilot must ensure that the airplane is loaded within the approved weight and balance envelope before takeoff.

Section 7 is **Systems Description**. This section provides a text type description of the operation of the airplane's controls and its systems. Some equipment described within this part is optional.

Section 8 is **Maintenance** information. Recommended procedures for routine care and servicing of the aircraft are outlined in this section.

Section 9 is **Supplemental** information. This section covers miscellaneous information and optional equipment installed on the aircraft.

Section 10 is **Safety Information**. This section covers general information related to the safe and efficient operation of any aircraft.

### REVISIONS

Immediately following the title page of this Handbook are the "Log of Revisions" pages. When a revision to any information in this Handbook is made by the publisher, a new Log of Revisions will be issued. All revisions must be retained in the Handbook to provide a current record until a reissue is made. Revisions to Section 2 will be FAA approved prior to issue.

### ACKNOWLEDGMENTS

I would like to express my gratitude to the many contributors to this Handbook for their advice, criticism and encouragement. I particularly want to recognize former ICS President Bill Creech, and ICS Technical Director Maurice Taylor, for without their leadership this Handbook would never have become a reality. I also want to acknowledge the International Comanche Society for their support. Keep the Spirit!

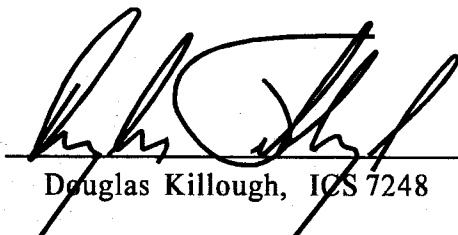

Douglas Killough, ICS 7248

### REFERENCES

PA-30 & Multi-Engine Flying - Fuchs	Advanced Pilot's Flight Manual - Kershner
Jane's Aerospace Dictionary - Gunston	Piper Twin Comanche Owner's Handbook
Piper Report 1284 - British Airplane Flight Manual	Aerodynamics For Naval Aviators - Hurt
Piper Report 1000 - Substantiation of Model PA-24	Piper Twin Comanche Service Manual
Piper Report 1269 or 1515 - PA-30 Airplane Flight Manual	Hartzell Propeller Owner's Manual
Lycoming Operator's Manual - IO-320 Series Aircraft Engines	Aircraft Specification No. A1EA
Airplane Performance Stability and Control - Perkins and Hage	Lycoming Flyer Key Reprints
Flight Training Handbook - US Department of Transportation	

### PILOT'S OPERATING HANDBOOKS AVAILABLE FOR THE COMANCHE

This Handbook is one of **sixteen** modern format, GAMA style, manuals available for the Piper Comanche and Twin Comanche. The table below is provided to allow the owner to identify by year, model and serial number which Handbook is appropriate for each version of the airplane.

This Handbook is applicable **ONLY** to aircraft shown in bold type.

**Singles:**

Manual Number	Model	Gross Weight	Year(s) Mfg.	Flight Manual Report Number	SN Begin	SN End
01.)	180	2550	1957-64	1047	24-1	3687
02.)	250	2800	1958-60	997	103	2298
03.)	250	2900	1961	1127	2299	2843
04.)	250	2900	1962-64	1179	2844	3687
05.)	250	2900	1962-64	1220 (FI)	2844	3687
06.)	260	2900	1965	1334	4000	4299
07.)	260	2900	1965	1333 (Carb)	4000	4299
08.)	260B	3100	1966-68	1359	4300	4803
09.)	260B	3100	1966-68	1358 (Carb)	4300	4803
10.)	260C	3200	1969-72	1545	4804	5028
11.)	260T	3200	1970-72	1640 (Turbo)	4901	5028
12.)	400	3600	1964-65	1295	26-3	148

**Twins:**

Manual Number	Model	Gross Weight	Year(s) Mfg.	Flight Manual Report Number	SN Begin	SN End
<b>13.)</b>	<b>PA30</b>	<b>3600</b>	<b>1963-68</b>	<b>1269</b>	<b>30-2</b>	<b>1744</b>
			<b>1969</b>	<b>1515</b>	<b>1745</b>	<b>2000</b>
14.)	PA30T	3725	1964-68	1269 (Turbo)	143	1744
			1969	1515 (Turbo)	1745	2000
15.)	PA39	3600	1970-72	1605	39-1	155
16.)	PA39T	3725	1970-72	1605 (Turbo)	1	155

Published By:  
Aircraft Publications  
Austin, Texas

The superior pilot uses his superior judgment to avoid those situations which require the use of his superior skill.

Frank Borman

Commander: Gemini 7; Apollo 8  
President: Eastern Airlines

## SECTION 1 - GENERAL

PA-30 \* 3600 LBS GROSS WEIGHT

### Table of Contents

Figure 1-01 Three View Drawing .....	1-2
Airframe .....	1-3
Engines .....	1-3
Propellers .....	1-3
Airframe Dimensions .....	1-3
Cabin and Entry Dimensions .....	1-4
Wing Classification and Specific Loadings .....	1-4
Weights .....	1-4
Capacities .....	1-4
Fuel and Oil Consumption .....	1-5
Performance .....	1-5
Operating Speeds .....	1-5
Endurance/Range 54 Gallons .....	1-5
Endurance/Range 84 Gallons .....	1-5
Endurance/Range 114 Gallons .....	1-5
Rate of Climb .....	1-6
Climb Gradient .....	1-6
Stall Speeds .....	1-6
Short Field Performance .....	1-6
Accelerate-Stop Distance .....	1-6
Service Ceiling .....	1-6
Absolute Ceiling .....	1-6
Symbols, Abbreviations and Terminology .....	1-7
Alert Notations .....	1-7
Glossary .....	1-7
V Speeds .....	1-15
Conversion Factors .....	1-18

# THREE VIEW - TWIN COMANCHE PA-30

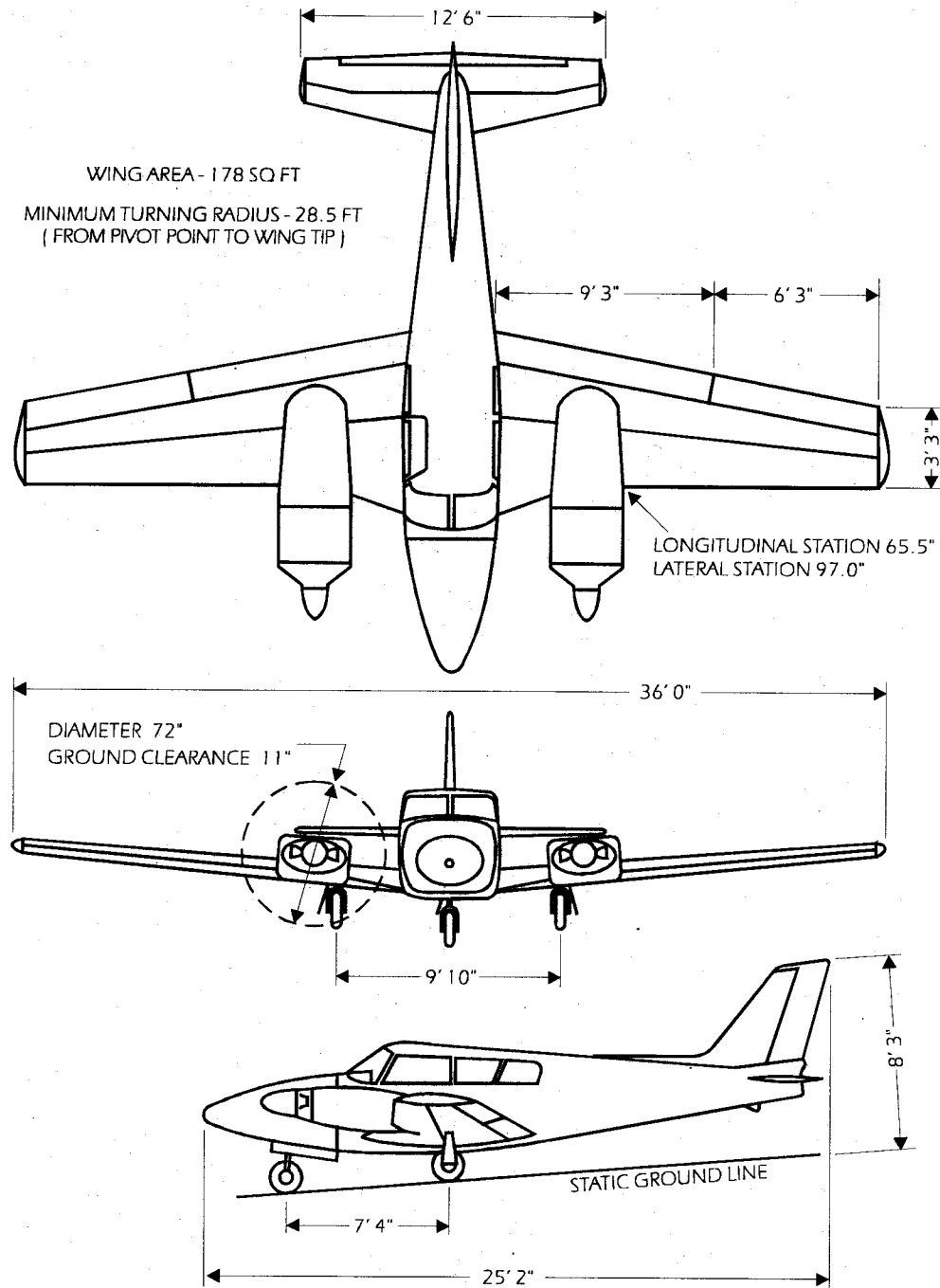

FIGURE 1-01

# THREE VIEW - TWIN COMANCHE PA-30

(Normally Aspirated Model Equipped With Tip Tanks -- 3725 Lbs Gross Weight)

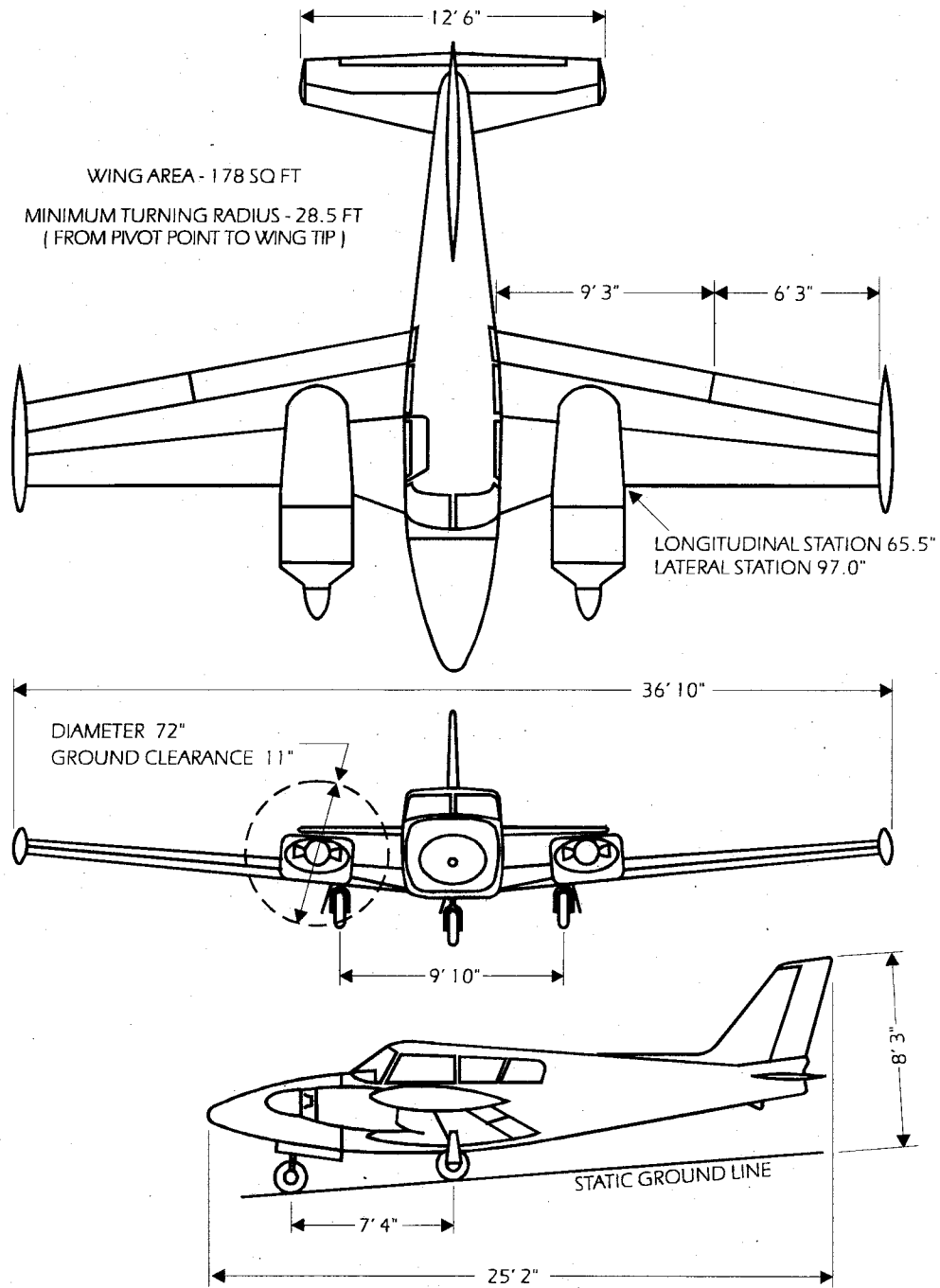

FIGURE 1-01

## GENERAL

PA-30 \* 3600 LBS GROSS WEIGHT

### AIRFRAME

Manufacturer ..... Piper  
Type Designation ..... Twin Comanche PA-30  
Construction ..... Semi-Monocoque  
Serial Number ..... \_\_\_\_\_  
Registration Number ..... \_\_\_\_\_  
Year Model ..... \_\_\_\_\_

### ENGINES

Manufacturer ..... Lycoming  
Serial Number (Left) ..... \_\_\_\_\_  
Serial Number (Right) ..... \_\_\_\_\_  
Model ..... IO-320-B  
Type ..... Four-Cylinder / Horizontally Opposed  
Ratings (bhp @ rpm) ..... 160/2700  
Bore ..... 5.125 in  
Stroke ..... 3.875 in  
Displacement ..... 319.8 cu in  
Compression Ratio ..... 8.5 to 1  
TBO ..... 2,000 hr  
Fuel Injector Manufacturer ..... Bendix  
Model ..... RSA 5AD1

### PROPELLERS

Manufacturer ..... Hartzell  
Serial Number (Left) ..... \_\_\_\_\_  
Serial Number (Right) ..... \_\_\_\_\_  
Hub Model ..... HC-E2YL-2  
Blade Model ..... 7663-4  
Number of Blades ..... 2  
Governor ..... Hartzell F-6-3  
Type ..... Constant-Speed / Hydraulically Actuated / Full Feathering  
Diameter ..... 72 in  
Pitch (30 in Station) ..... 12.0 to 78.0 Degrees

### AIRFRAME DIMENSIONS

Length ..... 25.2 ft  
Height ..... 8.2 ft  
Wing Span ..... 36.0 ft  
Wheel Base ..... 7.3 ft  
Wheel Tread ..... 9.8 ft



### CABIN AND ENTRY DIMENSIONS

Cabin Length .....	9.0 ft
Cabin Height .....	47 in
Cabin Width .....	45 in
Cabin Entry Height .....	32 in
Cabin Entry Width .....	34 in
Baggage Compartment Entry Height and Width (A Model) .....	20 x 20 in
Baggage Compartment Entry Height and Width (B & C Models) .....	19 x 21 in
Baggage Compartment Volume .....	20 cu ft

### WING CLASSIFICATION AND SPECIFIC LOADINGS

Wing Type .....	Laminar Flow
NACA Designation .....	64 <sub>2</sub> A215
Wing Dihedral .....	5 Degrees (Zero Twist)
Wing Aspect Ratio .....	7.3
Wing Area .....	178 sq ft
Wing Loading .....	20.2 lb/sq ft
Power Loading .....	11.3 lb/bhp

### WEIGHTS

Maximum Takeoff Weight .....	3,600 lb
Maximum Landing Weight .....	3,600 lb
Standard Empty Weight .....	2,207 lb
Maximum Useful Load .....	1,393 lb
Maximum Useful Load - With Basic Fuel and Oil (60 US gal) .....	1,033 lb
Maximum Useful Load - With Internal Reserve Fuel (30 US gal) .....	853 lb
Gross Weight (With Tip Tanks Installed) .....	3,725 lb
Maximum Useful Load - With Tip Tank Reserve Fuel (30 US gal) .....	798 lb

### CAPACITIES

Seats .....	4 (Optional 6 Beginning With SN 30-902)
Baggage Capacity .....	200 lb (250 lb Beginning With SN 30-902)
Basic Fuel Capacity .....	60 US gal - 54 Usable
Internal Reserve Fuel Capacity .....	30 US gal - 30 Usable
Tip Reserve Fuel Capacity (If Installed) .....	30 US gal - 30 Usable
Fuel Grade .....	91/96 - 100 LL (blue) Aviation Gasoline
Oil Capacity (Each Engine) .....	8 US qts
Normal Quantity .....	6-7 US qts
Minimum Safe Quantity .....	2 US qts
Oil Grade .....	MIL-L-22851C
Tire Pressure (lbs psi) .....	Nose 42 - Mains 42

## FUEL AND OIL CONSUMPTION

Fuel Flow @ 75% Power .....	17.2 gph/103.2 pph
Fuel Flow @ 65% Power .....	15.2 gph/ 91.2 pph
Fuel Flow @ 55% Power .....	13.4 gph/ 80.4 pph
Fuel Flow @ 45% Power .....	11.2 gph/ 67.2 pph
Oil Consumption (Typical) .....	0.40 to 0.50 US qts/hr

## PERFORMANCE

### 1.) Operating Speeds:

Maximum Speed .....	205 mph 178 kt
Cruise @ 75% Power @ 8,000 ft .....	194 mph 169 kt
Cruise @ 65% Power @ 12,000 ft .....	186 mph 162 kt
Cruise @ 55% Power @ 16,000 ft .....	172 mph 149 kt
Cruise @ 45% Power @ 16,000 ft .....	150 mph 130 kt

### 2.) Endurance/Range 54 Gallons:

At 75% Power .....	2.9 hr	-----	489 nm	563 sm	906 km
At 65% Power .....	3.3 hr	-----	534 nm	614 sm	988 km
At 55% Power .....	3.8 hr	-----	568 nm	654 sm	1,052 km
At 45% Power .....	4.5 hr	-----	587 nm	675 sm	1,086 km

### 3.) Endurance/Range 84 Gallons:

At 75% Power .....	4.6 hr	----	775 nm	892 sm	1,435 km
At 65% Power .....	5.2 hr	----	840 nm	967 sm	1,556 km
At 55% Power .....	5.9 hr	----	882 nm	1,015 sm	1,633 km
At 45% Power .....	7.0 hr	----	912 nm	1,050 sm	1,689 km

### 4.) Endurance/Range 114 Gallons: (With Tip Tanks Installed)

At 75% Power .....	6.2 hr	-	1,045 nm	1,203 sm	1,936 km
At 65% Power .....	7.0 hr	-	1,131 nm	1,302 sm	2,095 km
At 55% Power .....	8.0 hr	-	1,196 nm	1,376 sm	2,214 km
At 45% Power .....	9.5 hr	-	1,238 nm	1,425 sm	2,293 km

**\*\* NOTE \*\***

Range and endurance figures include an allowance for fuel used during start, taxi, takeoff, climb, and descent plus 45 minutes reserve fuel at a reduced power setting to obtain maximum range (V<sub>IMR</sub>) or maximum endurance (V<sub>IMD</sub>) as applicable. Mixture setting is best economy cruise.

## PERFORMANCE (Cont.)

### 5.) Rate of Climb:

Multi-Engine at 3,600 lbs Gross Weight .....	1,460 ft/min
Multi-Engine at 2,800 lbs Gross Weight .....	2,050 ft/min
Single-Engine at 3,600 lbs Gross Weight .....	260 ft/min

### 6.) Climb Gradient:

Multi-Engine at 3,600 lbs Gross Weight .....	903 ft/nm
Multi-Engine at 2,800 lbs Gross Weight .....	1,268 ft/nm
Single-Engine at 3,600 lbs Gross Weight .....	171 ft/nm

### 7.) Stall Speeds:

Full Flaps and Gear Extended .....	69 mph 60 kt
Clean .....	76 mph 66 kt

### 8.) Short Field Performance:

Takeoff Distance, Ground Run (15 Degrees of Flap) .....	1,250 ft
Total Over a 50 ft Obstacle .....	2,160 ft
Landing Distance, Ground Roll (Full Flaps) .....	700 ft
Total Over a 50 ft Obstacle .....	2,100 ft

### 9.) Accelerate-Stop Distance:

15 Degrees of Flap ( $V_{MCA} = 90$ mph) .....	3,000 ft
--	----------

### 10.) Service Ceiling:

Multi-Engine at 3,600 lbs Gross Weight .....	18,600 ft
Multi-Engine at 2,800 lbs Gross Weight .....	20,600 ft
Single-Engine at 3,600 lbs Gross Weight .....	5,800 ft

### 11.) Absolute Ceiling:

Multi-Engine at 3,600 lbs Gross Weight .....	20,000 ft
Multi-Engine at 2,800 lbs Gross Weight .....	22,000 ft
Single-Engine at 3,600 lbs Gross Weight .....	7,100 ft

#### \*\* NOTE \*\*

The maximum approved altitude for the normally aspirated Twin Comanche is FL 200.

Unless otherwise specified, all performance figures are based on standard day, standard atmosphere, gross weight, sea level, no wind conditions.

## SYMBOLS, ABBREVIATIONS AND TERMINOLOGY

### 1.) Alert Notations:

- \*\* NOTE \*\*** An operating procedure or practice which it is essential to emphasize.
- \*\* CAUTION \*\*** An operating procedure or practice which if not strictly observed will result in damage to equipment.
- \*\* WARNING \*\*** An operating procedure or practice which if not carefully followed will result in personal injury or loss of life.

### 2.) Glossary:

The following is an alphabetical listing of terminology used in this Handbook and other Piper literature for the Comanche. It includes precise definitions of terms used in: meteorology, engine and power plant operation, weight and balance computations, aircraft performance and flight planning, and terms of general aviation usage.

**Absolute Altitude** The actual height of an aircraft above the surface of the ground, as read by a radar altimeter.

**Absolute Ceiling** The highest altitude an aircraft can obtain.  $V_X$  and  $V_Y$  meet at the absolute ceiling, and any airspeed above or below this speed will result in a loss of altitude.

**Accelerate-Go Distance** The distance required to accelerate a multi-engine aircraft to a specified speed and, assuming engine failure at the instant that speed is attained, feather the propeller on the inoperative engine and continue the takeoff to a height of 50 feet AGL.

**Accelerate-Stop Distance** The distance required to accelerate an aircraft to lift-off velocity and, assuming engine failure at the instant that speed is attained, to bring the aircraft to a complete stop in the shortest possible distance on the runway.

**AD** Airworthiness Directive - A notice issued by the FAA for the purpose of amending the certification of an aircraft.

**A&P Mechanic** Airframe and Powerplant Mechanic - An aircraft mechanic who is certified by the FAA to perform certain maintenance and inspections.

**Arm** The horizontal distance from the reference datum to the center of gravity of an item.

**Basic Empty Weight** The standard empty weight of the aircraft plus the weight of unusable fuel and all optional equipment that is installed on the aircraft. Original Piper documentation included engine oil in this figure in the twin, but not the single-engine, Comanche.

**Best Glide (Endurance)** The engine-out airspeed which results in the greatest time aloft in a glide.

## SYMBOLS, ABBREVIATIONS AND TERMINOLOGY (Cont.)

- Best Glide (Optimum)** The engine-out airspeed which results in the best glide ratio.
- BHP** Brake Horsepower - The power developed at the propeller shaft of the engine measured in customary US units.
- BMEP** Brake Mean Effective Pressure - The average pressure inside the cylinder of a reciprocating engine during the power stroke, measured in the customary units of pounds per square inch. Used as an index for a majority of items of engine output, efficiency and operating limitations.
- Bootstrap System** A dynamic feedback system whereby an increase in the input power causes an increase in the system output, which is returned to the input, which again affects the output, etc. A bootstrap system is inherently unstable and requires slow and smooth control operation.
- CAS** Calibrated Airspeed - The indicated airspeed of an aircraft corrected for position and instrument error.
- C.G.** Center of Gravity - The point at which an aircraft would balance if suspended. Also, the point at which the longitudinal, lateral and vertical axes all converge, and through which the resultant force of gravity acts. Its distance from the reference datum is found by dividing the total moment by the total weight of the aircraft.
- C.G. Arm** Center of Gravity Arm - The arm obtained by adding the aircraft's individual moments and dividing by the total weight.
- C.G. Limits** Center of Gravity Limits - The extreme center of gravity locations within which the aircraft must be operated at a given weight.
- CHT** Cylinder Head Temperature - Temperature of an engine measured by a thermocouple device installed at the cylinder head to determine engine cooling.
- CID** Cubic Inch Displacement - The volume of the cylinders of an internal combustion engine, measured in customary US units. Equal to the area of the bore multiplied by the stroke times the number of cylinders.
- Climb Gradient** The ratio of change in altitude during a portion of a climb to the horizontal distance traversed in a given time interval. Climb Gradient is measured in feet per nautical mile and equal to the rate of climb in feet per minute, times 60, divided by ground speed in knots.
- Compressor** A centrifugal air pump connected directly to the turbine, the purpose of which is to increase the density of air to the induction system.
- Critical Altitude** The maximum altitude at which a normally aspirated engine can produce a given horsepower, or a turbocharged engine can produce sea level power.

## SYMBOLS, ABBREVIATIONS AND TERMINOLOGY (Cont.)

**Crosswind Component** The wind component measured in knots at 90 degrees to the longitudinal axis of the runway.

**Deck Pressure** The induction system pressure measured downstream of the turbo-compressor and upstream of the engine throttle valve.

**Demonstrated Crosswind Velocity** The velocity of the crosswind component for which adequate control of the aircraft during takeoff and landing has actually been demonstrated. FAA Regulation requires this value to be equal to 30 percent of  $V_{S0}$ . The value shown is not considered to be limiting.

**Density Altitude** Pressure altitude corrected for non-standard temperature variations.

**DMCR** Designated Manufacturer's Certification Representative - An individual working for a manufacturer who has been authorized by the FAA to inspect and certify the item produced by the manufacturer as meeting all federal requirements.

**DOA** Delegation Option Authorization - A document issued by the FAA authorizing an aircraft manufacturer to conduct its own aircraft type certification.

**EGT** Exhaust Gas Temperature - Temperature measured in the exhaust manifold and used to determine air-fuel ratio.

**ELT** Emergency Locator Transmitter - A self-contained radio transmitter that is automatically activated by the force of an impact between 5 and 7 gs. When activated it emits an omnidirectional signal on the international distress frequencies of 121.5 and 243.0 MHz. Its purpose is to aid in the location of a downed aircraft.

**Empty Weight As Weighed** The actual weight of an aircraft taken from scale readings, less the weight of any tare. This figure includes unusable fuel, oil and any other fluids for normal operation. Original Piper documentation didn't necessarily include all of these items, and in such cases, these items are added mathematically in weight and balance computations.

**FAA** Federal Aviation Administration - An agency of the Department of Transportation responsible for maintaining safe and efficient use of the nation's airspace by both military and civil aviators, for fostering civil aeronautics and air commerce, and for supporting national defense. The FAA was formed from the Civil Aeronautics Authority (CAA) in 1958.

**FAI** Federation Aeronautique Internationale - An organization of eighty nations with headquarters in Paris, France. Founded in 1905, it is the sole international authority responsible for sanctioning all world class aviation and space records.

**FCC** Federal Communications Commission - A governmental board of seven members appointed by the President under authority of the Communications Act of 1934. The FCC has the responsibility of regulating the nation's communications and licensing of radio transmitters operated within the United States.

## SYMBOLS, ABBREVIATIONS AND TERMINOLOGY (Cont.)

**FL** Flight Level - A level of constant atmospheric pressure related to a reference datum of 29.92 inches of mercury. Each level is stated in three digits that represent hundreds of feet. Flight levels are used in the high altitude route system.

**Full Cantilever Wing** A wing that requires no external bracing. All of the load of the structure is carried by internal spars, ribs and stringers.

**G** A unit of force of linear, angular and centrifugal acceleration (or deceleration) measured relative to the force of gravity. One g at sea level is equal to acceleration at the rate of 32.174 feet per second squared, or 9.807 meters per second squared.

**GADO** General Aviation District Office - An FAA field office serving a designated geographical area and staffed with flight standards personnel who have the responsibility of serving the aviation industry and the general public on all matters relating to the certification and operation of general aviation aircraft.

**GAMA** General Aviation Manufacturers Association - National trade organization representing manufacturers of aircraft, engines, avionics and related equipment. Responsible for establishing specifications for aircraft safety and pilot education.

**Glide Ratio** The ratio of the forward distance an aircraft travels to the vertical distance it descends when it is operating without power.

**GPH** Gallons Per Hour - The amount of fuel (in US gallons) consumed by the aircraft's engine each hour.

**Gross Weight** The maximum allowable weight for an aircraft. Also used to refer to the total of the basic empty weight plus the weight of fuel, oil and payload when the total of these is less than the maximum allowable gross weight.

**Ground Boosting** Use of a turbocharger to boost the horsepower of a reciprocating engine beyond the sea level rating.

**GS** Ground Speed - The speed of an aircraft relative to the ground and equal to true airspeed in no wind.

**GUMP** Acronym for: **G**as, **U**ndercarriage, **M**ixture, **P**ropeller(s). Used as a memory aid on landing a retractable gear airplane.

**IA Mechanic** Inspection Authorized Mechanic - A rating issued by the FAA to A&P mechanics that allows them to perform Annual and Progressive Inspections. This rating also gives them the authority to return an aircraft to service after an inspection or a major repair.

**IAS** Indicated Airspeed - The uncorrected airspeed of an aircraft as shown directly on the airspeed indicator.

## SYMBOLS, ABBREVIATIONS AND TERMINOLOGY (Cont.)

- ICAO** International Civil Aviation Organization - An agency of the United Nations with headquarters in Montreal, Quebec, Canada. Formed in 1947 with the objective of developing principals and techniques of international air navigation and the establishment of standards for international civil air transport.
- ICS** **International Comanche Society - An organization formed in 1972 as a nonprofit corporation by pilots and others interested in Piper Comanche airplanes to exchange experiences and foster safe and economical flying.**
- IFR** Instrument Flight Rules - Rules governing the procedures for conducting an instrument flight plan under instrument meteorological conditions.
- IMC** Instrument Meteorological Conditions - Meteorological conditions expressed in terms of visibility, distance from clouds, and ceilings less than the minima for VFR flight.
- Indicated Altitude** The uncorrected altitude read directly from the altimeter after it is set to the current local barometric pressure.
- Intercooler** A Radiator used to extract heat from the air discharged from the compressor of a turbocharger before it enters the fuel metering system of a reciprocating engine.
- ISA** International Standard Atmosphere - Reference: Standard Atmosphere. Equal to 15 degrees Celsius (59 degrees Fahrenheit) at sea level pressure of 29.92 inches Hg (1013.2 millibars) and decreases at a lapse rate of approximately 2 degrees Celsius (5 degrees Fahrenheit) for each 1000 foot increase in altitude.
- Laminar Flow Airfoil** A type of airfoil design that is shaped so that its thickest section is further aft than a standard airfoil. Air passes over the forward portion of the wing in a smooth boundary layer. The purpose of this design is to reduce drag by delaying the onset of turbulence for as long as possible. Laminar flow airfoils are used on various high-performance airplanes.
- Licensed Empty Weight** Obsolete term used prior to 1976 to indicate that the airplane was painted and ready for delivery. This figure typically included hydraulic fluid and unusable fuel, but no engine oil.
- Manifold Pressure** The induction system pressure measured downstream from the engine throttle valve. (See: MAP)
- MAP** Manifold Air Pressure - Reference: Manifold Pressure (MP) the air pressure within the induction system of the engine. Used as an indirect means to determine power developed by the engine, and traditionally measured in inches of mercury.
- Maximum Landing Weight** The maximum weight approved for the aircraft for the landing touchdown.



## SYMBOLS, ABBREVIATIONS AND TERMINOLOGY (Cont.)

**Maximum Ramp Weight** Maximum weight approved for ground maneuvering. It includes the weight of fuel used for start, taxi and run-up.

**Maximum Takeoff Weight** The maximum weight approved for the aircraft to begin its takeoff run.

**MCP** Maximum Continuous Power - Maximum power that can be developed by the engine without any limitation of time. (See: METO Power and Takeoff Power)

**Mercurial Barometer** A device used to determine atmospheric pressure by balancing air pressure against the weight of a column of mercury in an evacuated glass tube. The device is read in inches or centimeters of mercury.

**METO Power** Maximum Except Take-Off Power - Highest available (reciprocating engine) power other than the takeoff rating.

**Moment** The product of the weight of an item multiplied by its arm.

**Monocoque** A metal structure in which the outer skin carries a major part of the stresses to which the body is subjected. In a Semi-Monocoque structure, the outer skin is supported by a sub-structure of formers and stringers.

**MSL** Mean Sea Level - The average height of the surface of the sea for all stages of tide.

**NAA** National Aeronautic Association - The national aero club of the United States. A nonprofit organization that is the official US representative and largest member of the FAI. Located in Arlington, Virginia, the NAA was founded in 1905 for the purpose of advancing the art, sport and science of aviation through competition.

**NACA** National Advisory Committee on Aeronautics - Formed by an Act of Congress in 1915 for the purpose of establishing standards for the United States in aviation. The NACA was re-named the National Aeronautics and Space Administration (NASA) in 1958.

**OAT** Outside Air Temperature - Is the free-air static temperature obtained from an in-flight temperature indicator.

**Overboost** An increase in manifold pressure beyond the certified operating limits of the engine. Overboosting beyond specified limits will result in a mandatory engine overhaul.

**Overshoot** A condition caused by rapid throttle movement resulting in momentary high manifold pressure due to inertia of the turbocharger. Any overshoot beyond 29.5 inches Hg may be disregarded if it does not exceed two inches Hg for more than three seconds duration.

## SYMBOLS, ABBREVIATIONS AND TERMINOLOGY (Cont.)

**Payload** The total weight of occupants, cargo and baggage, but not oil or fuel. Also, that part of the useful load from which revenue is derived.

**PMA** Parts Manufacturer Approval - An authorization issued by the FAA to allow modification or manufacture of a replacement part for sale for installation on a Type Certified product.

**PPH** Pounds Per Hour - The amount of fuel (in pounds avdp) consumed by the aircraft's engine each hour.

**Pressure Altitude** The altitude read from an altimeter when the instrument's barometric scale is set to 29.92 inches of mercury, and corrected for instrument and position error.

**Reference Datum** An imaginary vertical plane from which all horizontal distances are measured for balance purposes. Also called Balance Station Zero.

**RPM** Revolutions Per Minute - Engine speed measured in complete cycles of the engine crankshaft.

**SAE Rating** Standard rating for lubricating oils established by the Society of Automotive Engineers and based on Saybolt viscosity.

**Service Ceiling** The highest altitude an aircraft can obtain and still be able to climb at a rate of 100 feet per minute. In the case of a twin-engine aircraft operating on a single engine, the figure is 50 feet per minute. This rate of climb is considered to be the lowest value practical for operation.

**Standard Empty Weight** The weight of a standard production model aircraft as provided by the manufacturer. This figure includes engine oil, unusable fuel and all other fluids for normal operation although original Piper documentation did not always include these items.

**Station** A location along the aircraft fuselage given in terms of distance from the reference datum.

**Station Pressure** Actual atmospheric pressure as measured at field elevation.

**STC** Supplemental Type Certificate - An authorization issued by the FAA for a major alteration to an aircraft, engine or propeller that has been built under an Approved Type Certificate.

**Supercharge** The mechanical increase of air pressure (density) above ambient conditions.

**Takeoff Power** The maximum brake horsepower that is developed under standard sea level conditions and under maximum conditions of crankshaft rotational speed and engine manifold pressure approved for normal takeoff. In many cases Takeoff Power is limited to a given period of time (typically five minutes for a piston engine) shown in the engine specification.

## SYMBOLS, ABBREVIATIONS AND TERMINOLOGY (Cont.)

- Tare** The weight of chocks, blocks, stands, etc. used when weighing an aircraft. Tare is deducted from the scale reading to obtain the actual (net) aircraft weight.
- TAS** True Airspeed - The speed of an aircraft relative to undisturbed air which is the CAS corrected for altitude, temperature and compressibility.
- TBO** Time Between Overhauls - An interval recommended by the manufacturer for re-building the engine. If the aircraft is operated commercially, this time interval is mandatory.
- TBS** Turbo Supercharger - More commonly referred to as "turbocharger". An exhaust gas driven air compressor that is used to increase the power of a reciprocating engine or to assist in maintaining power at high altitudes.
- TIT** Turbine Inlet Temperature - Temperature of the engine's exhaust gas as it enters the turbine. Used to measure critical operation of the engine. TIT is considered to be the best parameter for engine control and monitoring, although EGT is more common.
- True Altitude** The height of the aircraft above sea level when the altimeter's barometric scale is set to the local altimeter setting and corrected for a nonstandard temperature lapse rate. True altitude, pressure altitude and density altitude are all equal at standard atmosphere.
- TSO** Technical Standard Order - A set of specifications issued by the FAA outlining environmental and performance capabilities for various types of equipment used in an aircraft. A partial list of TSOed equipment includes: radios, instrumentation, tires, wheels, brakes, seat belts and hoses.
- Turbine** The exhaust driven end of the turbocharger unit.
- Turbo-Normalizing** The use of a turbocharger to regain up to, but not more than, sea level power, and to regain the power loss caused by decreased air pressure at high altitudes.
- Unusable Fuel** The quantity of fuel that can not be safely used in critical flight attitudes. Also, any residual fuel that will not flow through the aircraft's fuel system. Unusable Fuel is not available for flight planning purposes. Fuel designated as unusable in the single-engine and twin Comanche is available, but only in level flight.
- Useful Load** The difference between takeoff weight, or ramp weight as applicable, and basic empty weight. Useful Load, as it is used in this Handbook, consists of the pilot, passengers, baggage and usable fuel. In original Piper documentation, this figure may or may not include engine oil.
- VFR** Visual Flight Rules - Rules that govern the procedures for conducting flight under visual meteorological conditions. VFR weather minima are outlined in Federal Aviation Regulations under Part 91 and Part 135.

### SYMBOLS, ABBREVIATIONS AND TERMINOLOGY (Cont.)

**VMC** Visual Meteorological Conditions - Meteorological conditions expressed in terms of visibility, distance from clouds, and ceilings equal to or greater than specified minima.

**Wastegate** A controllable butterfly valve in the exhaust system used to direct exhaust gasses to adjust the speed of the turbocharger and thereby determine manifold pressure of the engine.

#### 3.) V Speeds:

**V<sub>A</sub>** Design Maneuvering Speed, and Turbulent Air Penetration Speed - The maximum airspeed at which application of full available aerodynamic control will not over-stress the aircraft. Equal to the square root of the limit load factor times  $V_{S1}$ .

**V<sub>APP</sub>** Final Approach To Landing Speed - The airspeed recommended for touchdown. Typically equal to 1.3 times  $V_{S0}$ .

**V<sub>B</sub>** Design Speed For Maximum Gust Intensity - Maximum airspeed at which a specified gust (e.g. plus or minus 30 feet per second) can be withstood without airframe damage.

**V<sub>C</sub>** Design Cruising Speed - Speed used to establish structural strength.

**V<sub>D</sub>** Demonstrated Diving Speed - The highest airspeed which was actually demonstrated during certification tests of the aircraft. Equal to 1.4 times  $V_C$ .

**V<sub>FE</sub>** Maximum Flap Extension Speed - The highest airspeed permissible with the wing flaps in a prescribed (extended) position. (Top of white arc.)

**V<sub>H</sub>** Maximum Operating Speed - The highest airspeed obtainable with maximum continuous power in level flight.

**V<sub>IMD</sub>** Minimum Drag Speed and Maximum Endurance Speed - The airspeed that results in the greatest time aloft.

**V<sub>IMR</sub>** Maximum Range Speed - The airspeed that results in the least amount of fuel consumed for distance traveled.

**V<sub>LE</sub>** Landing-Gear Extended Speed - The highest airspeed at which the aircraft can be operated with the landing gear extended.

**V<sub>LO</sub>** Landing-Gear Operation Speed - The highest airspeed at which the landing gear can be extended or retracted.

**V<sub>LOF</sub>** Lift-Off Speed - The speed at which a plane becomes airborne.

## SYMBOLS, ABBREVIATIONS AND TERMINOLOGY (Cont.)

- V<sub>MC</sub>** Single-Engine Minimum Control Speed - Obsolete term more precisely defined by the following three entries:
- V<sub>MCA</sub>** Single-Engine Minimum Control Speed (Airborne) - Minimum flight speed determined by FAA regulations at which a multi-engine airplane is directionally controllable with the critical engine inoperative. Conditions include: propeller windmilling on the inoperative engine, takeoff power on the operative engine, a five-degree bank toward the operative engine, most rearward C.G., landing gear retracted and flaps in takeoff position. (Red radial line.)
- V<sub>MCG</sub>** Single-Engine Minimum Control Speed (Ground) - Minimum speed at which a multi-engine airplane can maintain directional control on the ground during the takeoff run after failure of the critical engine. Conditions include: application of less than 70 kilograms (155 pounds) pedal force without going off the runway (preferably while holding centerline) with a 7+ knot crosswind component and a wet surface.
- V<sub>MCL</sub>** Single-Engine Minimum Control Speed (Landing) - Minimum speed at which a multi-engine airplane can maintain directional control in the landing configuration after failure of the critical engine.
- V<sub>NE</sub>** Never Exceed Speed - The airspeed limit that may not be exceeded at any time. Equal to  $V_D$  minus 10 percent. (Top of yellow arc, and redline.)
- V<sub>NO</sub>** Normal Operating Speed, and Maximum Structural Cruising Speed - The level flight speed of an aircraft at its optimum altitude with the engine operating at no more than 75 percent of its rated horsepower. This airspeed should not be exceeded except in smooth air. (Top of green arc, and bottom of yellow arc.)
- V<sub>P</sub>** Obsolete term for Maneuvering Speed. This term is now used as designation for propwash velocity.
- V<sub>R</sub>** Rotation Speed - The speed at which the maneuver to increase the wing angle-of-attack is performed in order to accomplish lift-off attitude.
- V<sub>REF</sub>** Reference Speed - Any referenced airspeed.
- V<sub>S0</sub>** Stall Speed With Full Flaps and Gear Extended - Minimum steady flight speed at which the aircraft is controllable in a landing configuration. (Bottom of white arc.)
- V<sub>S1</sub>** Stall Speed With Flaps and Gear Retracted - Minimum steady flight speed at which the aircraft is controllable. (Bottom of green arc.)

### SYMBOLS, ABBREVIATIONS AND TERMINOLOGY (Cont.)

- V<sub>SSE</sub>** Minimum Safe Single-Engine Speed - Minimum speed, selected by the airplane manufacturer, for intentionally shutting down an engine of a multi-engine airplane in flight for the purpose of pilot training. Intentional failing of an engine below this speed, or below a safe altitude AGL, is not recommended.
- V<sub>X</sub>** Best Angle-of-Climb Speed - The airspeed which results in the greatest gain in altitude in a given horizontal distance traversed.
- V<sub>XSE</sub>** Best Single-Engine Angle-of-Climb Speed - The airspeed which results in the greatest gain in altitude in a given horizontal distance traversed when operating a multi-engine airplane on one engine.
- V<sub>Y</sub>** Best Rate-of-Climb Speed - The airspeed which results in the greatest gain in altitude in a given period of time.
- V<sub>YSE</sub>** Best Single-Engine Rate-of-Climb Speed - The airspeed which results in the greatest gain in altitude in a given period of time when operating a multi-engine airplane on one engine. (Blue radial line.)

**CONVERSION FACTORS FOR WEIGHTS, MEASURES AND PHYSICAL CONSTANTS**

**LINEAR MEASURE**

US Customary Unit	US Equivalents	Metric Equivalents
1 inch (in)	0.0833 ft	2.54 cm
1 foot (ft)	12 in	30.48 cm
1 yard (yd)	3 ft	0.9144 m
1 rod (rd)	5.5 yd 16.5 ft	5.029 m
1 statute mile (sm)	5,280 ft 1,760 yd 320 rd	1.6093 km 0.8690 nm

**AREA**

US Customary Unit	US Equivalents	Metric Equivalents
1 square inch (sq in)	0.0069 sq ft	6.4516 sq cm
1 square foot (sq ft)	144 sq in	929.03 sq cm
1 square yard (sq yd)	9 sq ft	0.8361 sq m
1 acre (ac)	4,840 sq yd	4,047 sq m
1 square mile (sq mi)	640 ac	2.590 sq km

**VOLUME**

US Customary Unit	US Equivalents	Metric Equivalents
1 cubic inch (cu in)	0.00058 cu ft 0.0173 US qt	16.387 cu cm 0.0164 L
1 cubic foot (cu ft)	1,728 cu in 7.481 US gal	0.0283 cu m 28.3161 L
1 cubic yard (cu yd)	27 cu ft 201.974 US gal	0.7646 cu m 764.5337 L

**CAPACITY**

US Customary Unit (Liquid Measure)	US Equivalents	Metric Equivalents
1 fl ounce (US fl oz)	0.0078 US gal 1.805 cu in	29.573 mL 29.57 cu cm
1 pint (US pt)	16 US fl oz 28.875 cu in	0.473 L 473.175 cu cm
1 quart (US qt)	2 US pt 57.75 cu in	0.9463 L 946.35 cu cm
1 gallon (US gal)	4 US qt 231 cu in	3.7853 L 3785.4 cu cm 0.8327 Imp gal

**STANDARD-TO-METRIC CONVERSION FACTORS (Cont.)**

**CAPACITY**

US Customary Unit (Dry Measure)	US Equivalents	Metric Equivalents
1 pint (dry pt)	33.6 cu in	0.551 L
1 quart (dry qt)	67.2 cu in	1.101 L
1 gallon (dry gal)	0.1556 cu ft	4.405 L
1 peck (US pk)	8 dry qt	8.810 L
1 bushel (US bu)	4 dry pk	35.238 L

**VOLUME OR CAPACITY**

British Imperial Unit (Liquid & Dry)	US Customary Equivalents	Metric Equivalents
1 fl ounce (Imp fl oz)	0.961 US fl oz	28.412 mL
1 pint (Imp pt)	1.032 US dry pt 1.201 US pt 34.678 cu in	568.26 mL
1 quart (Imp qt)	1.032 US dry qt 1.201 US qt 69.354 cu in	1.136 L
1 gallon (Imp gal)	1.201 US gal 277.420 cu in	4.546 L
1 peck (Imp pk)	554.84 cu in	0.009 cu m
1 bushel (Imp bu)	1.032 US bu	0.036 cu m

**WEIGHT**

US Customary Unit (Avoirdupois)	US Equivalents	Metric Equivalents
1 grain (gr)	0.0023 oz (avdp)	64.7989 mg
1 dram (dr)	0.0625 oz (avdp)	1.772 g 27.34 gr
1 ounce (oz)	16 dr	28.3495 g 437.5 gr
1 pound (lb)	16 oz (avdp) 256 dr	453.5924 g 0.4536 kg 7,000 gr
1 slug (mass)	32.174 lb	14.594 kg
1 ton (short)	2,000 lb 0.8929 long ton	0.9072 metric ton
1 ton (long)	2,240 lb 1.12 short ton	1.016 metric ton



**STANDARD-TO-METRIC CONVERSION FACTORS (Cont.)**

**PHYSICAL CONSTANTS**

US Customary Unit	US Equivalents	Metric Equivalents
1 atmosphere (atm)	29.92 in Hg 14.6960 lb/sq in	760 mm Hg 1.0133 bars 101.325 kPa 1.033 kg/sq cm
1 inch mercury (in Hg) (@ zero degree C)	0.0334 atm 0.4912 lb/sq in	25.4 mm/Hg 345.3 kg/sq m 33.8639 mb 3.386 kPa
1 horsepower (hp)	550 ft-lb/sec	76.04 m-kg/sec 1.014 metric hp
1 foot per minute (ft/min.)	0.0167 ft/sec 0.0114 mph	0.0051 m/sec 0.3048 m/min 0.0183 km/hr
1 mile per hour (mph)	1.467 ft/sec 88 ft/min	0.447 m/sec 1.609 km/hr 0.8689 kt
1 degree (arc)	0.0028 rev	0.0175 rad
1 revolution (rev)	360 degrees	6.2832 rad (2 pi)
1 rev per minute (rpm)	6 degrees/sec	0.1047 rad/sec
1 inch pound (in-lb)	0.0833 ft-lb	0.0115 m-kg 0.113 N-m
1 foot pound (ft-lb)	12 in-lb	0.1383 m-kg 1.356 N-m
1 pound per sq in (lb/psi)	0.0681 atm 2.036 in Hg 144 lb/sq ft	0.0689 bar 5.1715 cm Hg 703.1 kg/sq m 6.895 kPa
1 pound per sq ft (lb/sq ft)	0.1414 in Hg	4.8824 kg/sq m 0.391 mm Hg 0.0479 kPa

**TEMPERATURE**

To convert degrees Fahrenheit to degrees Celsius, subtract 32, multiply by 5, and divide by 9. To convert degrees Celsius to degrees Fahrenheit, multiply by 9, divide by 5, and add 32.

To obtain degrees Kelvin, add 273.5 to degrees Celsius.

**NAUTICAL (International)**

Nautical Unit	US Equivalents	Metric Equivalents
1 nautical mile (nm)	6076.1 ft	1.852 km 1.151 sm
1 knot (kt)	1.688 ft/sec 101.2686 ft/min 1.1508 sm/hr	0.5144 m/sec 30.87 m/min 1.852 km/hr

## METRIC-TO-STANDARD CONVERSION FACTORS

### LINEAR MEASURE

Metric Unit (SI)	Metric Equivalents	US Customary Unit
1 millimeter (mm)	0.001 m	0.0394 in
1 centimeter (cm)	0.01 m	0.3937 in
1 meter (m)	10 mm	0.0328 ft
	1000 mm	39.37 in
	100 cm	3.2808 ft
1 kilometer (km)	0.001 km	1.0936 yd
	1,000 m	3,280.84 ft
		0.6214 sm
		0.5400 nm

### AREA

Metric Unit (SI)	Metric Equivalents	US Customary Unit
1 sq centimeter (sq cm)	0.0001 sq m	0.1150 sq in
1 sq meter (sq m)	10,000 sq cm	1,550 sq in
		10.7639 sq ft
		1.1960 sq yd
1 hectare (ha)	10,000 sq m	2.471 ac
1 sq kilometer (sq km)	100 ha	0.3861 sq mi

### VOLUME

Metric Unit (SI)	Metric Equivalents	US Customary Unit
1 cu centimeter (cu cm)	0.001 L	0.0610 cu in
1 cu decimeter (cu dm)	1 Liter	0.0338 US fl oz
		61.02 cu in
		1.056 US qt
1 cu meter (cu m)	1,000 L	61,024 cu in
		35.3147 cu ft
		1.308 cu yd
		264.1720 US gal

### CAPACITY

Metric Unit (SI)	Metric Equivalents	US Customary Unit
1 milliliter (mL)	0.001 L	0.3381 US fl oz
1 centiliter (cL)	0.01 L	3.3814 US fl oz
1 Liter (L)	1,000 cu cm	33.814 US fl oz
		1.0567 US qt
		0.2642 US gal
		0.22 Imp gal
		61.02 cu in

One Liter equals the volume  
of 1 kilogram of water at  
4 degrees C and 760 mm Hg.

**METRIC-TO-STANDARD CONVERSION FACTORS (Cont.)**

**WEIGHT**

Metric Unit (SI)	Metric Equivalents	US Customary Unit
1 milligram (mg)	0.001 g	0.0154 gr
1 centigram (cg)	0.01 g	0.1543 gr
1 gram (g)	0.001 kg	15.4324 gr 0.03527 oz (avdp) 0.0022 lb
1 kilogram (kg)	1,000 g	35.2740 oz (avdp) 2.2046 lb
1 ton (metric)	1,000 kg	2,204.6 lb 1.1023 short ton 0.9842 long ton

**PHYSICAL CONSTANTS**

Metric Unit (SI)	Metric Equivalents	US Customary Unit
1 millibar (mb)	1,000 dynes/sq cm 0.750 mm Hg	0.0295 in Hg 2.089 lb/sq ft
1 bar (bar)	760 mm Hg 100 kPa	0.9869 atm 14.5038 lb/sq in
1 mm mercury (mm Hg) (@ zero degree C)	0.1 cm Hg 1.3332 mb 0.1333 kPa	0.0013 atm 0.0394 in Hg 0.0193 lb/sq in
1 cm mercury (cm Hg) (@ zero degree C)	10 mm Hg 135.95 kg/sq m 1.333 kPa	0.0132 atm 0.3937 in Hg 0.1934 lb/sq in
1 horsepower (metric hp)	75 m-kg/sec	0.9863 standard hp
1 meter per second (m/sec)	100 cm/sec 3.6 km/hr	3.2808 ft/sec 2.237 mph 1.944 kt
1 meter per minute (m/min)	0.06 km/hr	3.2808 ft/min
1 kilometer per hour (km/hr)	0.2778 m/sec 16.67 m/min	0.9113 ft/sec 54.68 ft/min 0.6214 mph 0.5400 kt
1 radian (rad)	3,438 min	57.2958 deg (arc) 0.1592 rev
1 rad per second (rad/sec)	57.2958 deg/sec	0.1592 rev/sec 9.549 rpm
1 kiloPascal (kPa)	1 Newton/sq m	0.145 lb/sq in
1 meter kilogram (m-kg)	1,000 m-g 9.807 N-m	86.798 in-lb 7.233 ft-lb
1 Newton meter (N-m)	0.1020 m-kg	8.851 in-lb 0.7376 ft-lb
1 kg per sq meter (kg/sq m)	1,000 g/sq m	0.0029 in Hg 0.2048 lb/sq ft

## SECTION 2 - LIMITATIONS

PA-30 \* 3600 LBS GROSS WEIGHT

1963 THROUGH 1969 (NORMALLY ASPIRATED MODEL ONLY)

APPLICABLE TO AIRPLANES WITH SERIAL NUMBERS:  
30-1 THROUGH 30-2000

### Table of Contents

Introduction .....	2-2
Airspeed Limitations .....	2-2
Power Plant Instrument Markings .....	2-3
Tachometer .....	2-3
Oil Temperature .....	2-3
Oil Pressure .....	2-3
Fuel Flow .....	2-3
Cylinder Head Temperature .....	2-3
Instrument Vacuum .....	2-3
Airspeed Indicator Markings .....	2-3
Power Plant Limitations .....	2-4
Engine Operating Limits .....	2-4
Propeller Limitations .....	2-4
Weight Limits .....	2-4
Center of Gravity Limits .....	2-4
Structural Load Factors .....	2-5
Operational Limits .....	2-5
Fuel Limitations .....	2-5
Wing Flap Limitations .....	2-5
Other Limitations .....	2-6
Placards .....	2-6
Procedures .....	2-8
Fuel System .....	2-8
Propeller Feathering Procedure .....	2-9
Propeller Unfeathering Procedure .....	2-9
Emergency Extension of Landing Gear .....	2-9
Circuit Breakers .....	2-10
Stopping Engines .....	2-10
Warning .....	2-10
Alternator System .....	2-11

## LIMITATIONS

PA-30 \* 3600 LBS GROSS WEIGHT

### INTRODUCTION

The limitations included in this section are approved by the Federal Aviation Administration. The Twin Comanche is certified under FAA Type Certificate No. A1EA, approved February 05, 1963.

### AIRSPEED LIMITATIONS

$V_A$  - Design Maneuvering Speed / Turbulent Air Penetration Speed

At 3,600 lbs Gross Weight .....	CAS 162 mph	141 kt
	IAS 162 mph	141 kt
At 2,450 lbs Gross Weight .....	CAS 135 mph	117 kt
	IAS 134 mph	116 kt

**\*\* NOTE \*\*** Do not make full or abrupt control movements above  $V_A$ .

$V_{FE}$ - Flap Extension Speed .....	CAS 125 mph	108 kt
	IAS 124 mph	107 kt

**\*\* NOTE \*\*** Do not extend flaps or operate with flaps extended above  $V_{FE}$ .

$V_{LE}$ - Landing-Gear Extended Speed .....	CAS 150 mph	130 kt
	IAS 149 mph	129 kt

**\*\* NOTE \*\*** Do not exceed  $V_{LE}$  with the landing gear extended.

$V_{LO}$ - Landing-Gear Operation Speed .....	CAS 150 mph	130 kt
	IAS 149 mph	129 kt

**\*\* NOTE \*\*** Do not extend or retract the landing gear above  $V_{LO}$ .

$V_{MCA}$ - Single Engine Minimum Control Speed .....	CAS 90 mph	78 kt
	IAS 88 mph	76 kt

**\*\* NOTE \*\*** Minimum speed for directional controllability after sudden loss of an engine.

$V_{NE}$ - Never Exceed Speed .....	CAS 230 mph	200 kt
	IAS 234 mph	203 kt

**\*\* NOTE \*\*** Do not exceed  $V_{NE}$  in any operation.

$V_{NO}$ - Normal Operating Speed / Maximum Structural Cruising Speed ..	CAS 194 mph	169 kt
	IAS 197 mph	171 kt

**\*\* NOTE \*\*** Do not exceed  $V_{NO}$  except in smooth air and then only with caution.

$V_{S0}$ - Stall Speed (Power Off - Full Flaps and Gear Extended) .....	CAS 69 mph	60 kt
	IAS 69 mph	60 kt

$V_{S1}$ - Stall Speed (Power Off - Clean) .....	CAS 76 mph	66 kt
	IAS 74 mph	64 kt

## POWER PLANT INSTRUMENT MARKINGS

### 1.) Tachometer:

Green Arc (Normal Operating Range) ..... 500 to 2700 rpm  
Red Line (Maximum Continuous) ..... 2700 rpm

### 2.) Oil Temperature:

Green Arc (Normal Operating Range) ..... 120-245 Degrees Fahrenheit  
Yellow Arc (Caution Range) ..... 60-120 Degrees Fahrenheit  
Red Line (Maximum Temperature) ..... 245 Degrees Fahrenheit

### 3.) Oil Pressure:

Green Arc (Normal Operating Range) ..... 60-90 psi  
Yellow Arc (Caution Range) ..... 25-60 and 90-100 psi  
Red Line (Minimum psi) ..... 25 psi  
Red Line (Maximum psi) ..... 100 psi

### 4.) Fuel Flow:

Green Arc (Normal Operating Range) ..... Zero to 16.0 gph  
Red Line (Maximum Pressure at Sea Level) ..... 16.0 gph (7.0 psi)

### 5.) Cylinder Head Temperature:

Green Arc (Normal Operating Range) ..... 200-500 Degrees Fahrenheit  
Red Line (Minimum Temperature) ..... 200 Degrees Fahrenheit  
Red Line (Maximum Temperature) ..... 500 Degrees Fahrenheit

### 6.) Instrument Vacuum:

Green Arc (Normal Operating Range) ..... 4.8 to 5.1 in Hg  
Red Line (Minimum Suction) ..... 4.8 in Hg  
Red Line (Maximum Suction) ..... 5.1 in Hg

## AIRSPEED INDICATOR MARKINGS

**\*\* NOTE \*\*** The airspeed indicator color markings are in CAS values.

Red Line (Never Exceed Speed) ..... 230 mph 200 kt  
Yellow Arc (Caution Range) ..... 194-230 mph 169-200 kt  
Green Arc (Normal Operating Range) ..... 76-194 mph 66-169 kt  
White Arc (Flaps Down) ..... 69-125 mph 60-108 kt  
Red Radial Line ( $V_{MCA}$  - Single Engine) ..... 90 mph 78 kt  
Blue Radial Line ( $V_Y$  - Single Engine) ..... 105 mph 91 kt

### POWER PLANT LIMITATIONS

#### 1.) Engine Operating Limits:

Two Lycoming Model: IO-320-B1A

Takeoff Power and MCP ..... 2700 rpm/160 bhp

#### 2.) Propeller Limitations:

Two Hartzell Hub Model: HC-E2YL-2  
Blade Model: 7663-4

Diameter ..... Maximum 72 in \* Minimum 70 in  
Pitch (30 in Station) ..... Low 12.0 Degrees \* Feathered 78.0 Degrees

### WEIGHT LIMITS

Maximum Takeoff Weight ..... 3,600 lb  
Maximum Landing Weight ..... 3,600 lb  
Maximum Baggage Weight (SN 30-1 Through 30-901 Except 30-853) ..... 200 lb  
Maximum Baggage Weight (SN 30-853 and 30-902 Through 30-2000) ..... 250 lb

### CENTER OF GRAVITY LIMITS

Weight Pounds	Arm Forward Limit Inches Aft of Datum	Arm Rearward Limit Inches Aft of Datum
3,600	86.5	92.0
3,200	83.0	92.0
2,450 or Less	81.0	92.0

**\*\* NOTE \*\***

Straight line variation exists between the points given.

Datum is located 79 inches ahead of the wing leading edge. It is measured longitudinally from station 65.5 and laterally from spanwise station 97.0 (First leading skin lap outboard of engine nacelle).

### STRUCTURAL LOAD FACTORS

Positive ..... Normal Category + 3.80 g  
Negative ..... Normal Category - 1.52 g

**\*\* NOTE \*\*** No inverted maneuvers are approved

### OPERATIONAL LIMITS

The airplane is approved for the following operations when equipped in accordance with FAR Part 91 or FAR Part 135.

- 1.) VFR day and night
- 2.) IFR day and night

**\*\* WARNING \*\***

Flight into known icing conditions is prohibited unless the following equipment is installed and working in accordance with applicable Piper drawings and FAA regulations

- 1.) Pneumatic Wing and Empennage Boots - STC No. SA233EA
- 2.) Alcohol Propeller Anti-Icing Kit - STC No. SA184EA
- 3.) Heated Windshield Panel - PAC Drawing 25221 or 26711
- 4.) Heated Pitot Head - PAC Drawing 21301 or 26732
- 5.) Piper Antennas - PAC Drawing 25043

### FUEL LIMITATIONS

Main (Inboard) Tanks:

Basic Fuel Capacity (Two Cells, 30 US gal ea.) ..... 60 US gal - 54 Usable

**\*\* NOTE \*\***

The unusable fuel in this aircraft has been determined to be 3 gallons in each inboard tank in critical flight attitudes.

Auxiliary (Outboard) Tanks:

Reserve Fuel Capacity (Two Cells, 15 US gal ea.) ..... 30 US gal - 30 Usable

Auxiliary (Tip) Tanks:

Reserve Fuel Capacity (Two Cells, 15 US gal ea.) ..... 30 US gal - 30 Usable

**\*\* NOTE \*\*** Minimum fuel grade is (blue) 91/96 octane (100 LL) aviation fuel.

### WING FLAP LIMITATIONS

Takeoff ..... Zero to 15 Degrees  
 Landing ..... Zero to 27 Degrees

The flaps are electrically operated and the deflection is displayed on the flap position indicator. Takeoff range is indicated by the White Arc on the flap indicator.



### OTHER LIMITATIONS

- 1.) Loss of altitude in a power off stall with landing gear and wing flaps retracted is 280 ft.
- 2.) When performing power on stalls, do not exceed 2100 rpm.
- 3.) Landing Gear Down Light: The green gear down light on the instrument panel indicates the landing gear is down and locked. When the instrument panel lights are turned on the intensity if the gear indicator lights is reduced. The green light may be invisible with instrument lights on during daylight.
- 4.) Cowl flaps are provided to allow manual control of engine temperatures. The cowl flaps should be open during ground operations and during climbs. In no case should the cylinder head temperatures be allowed to exceed 500 Degrees Fahrenheit and/or the oil temperatures be allowed to exceed 245 Degrees Fahrenheit.

### PLACARDS

#### 1.) On Instrument Panel in Full View of the Pilot:

THIS AIRPLANE MUST BE OPERATED AS A NORMAL CATEGORY AIRPLANE IN COMPLIANCE WITH THE AIRPLANE FLIGHT MANUAL. ACROBATIC MANEUVERS (INCLUDING SPINS) PROHIBITED.

MINIMUM SINGLE ENGINE CONTROL SPEED	90 MPH CAS
MANEUVERING SPEED	162 MPH CAS
MAXIMUM GEAR DOWN SPEED	150 MPH CAS

#### 2.) On Landing Gear Operating Motor Access Door:

EMERGENCY GEAR EXTENSION.  
REMOVE COVER.  
EXTENSION INSTRUCTIONS  
ON REVERSE SIDE.

#### 3.) On the Instrument Panel:

STALL WARNING  
The stall warning system is inoperative  
when the master switch is off.

WARNING - UNCOORDINATED MANEUVERS, INCLUDING SIDE SLIPS OF 30 SECONDS OR MORE, FOR ANY REASON, AND FAST TAXI TURNS JUST PRIOR TO TAKEOFF CAN CAUSE LOSS OF POWER IF FUEL TANKS IN USE ARE LESS THAN 1/4 FULL.

**PLACARDS (Cont.)**

**4.) On Circuit Breaker Access Door:**

CIRCUIT BREAKER ACCESS DOOR

**5.) On Baggage Compartment Door: (SN 30-1 Through 30-901 Except 30-853)**

MAXIMUM BAGGAGE 200 POUNDS

**6.) On Baggage Compartment Door: (SN 30-853 and 30-902 Through 30-2000)**

EMERGENCY EXIT  
HOLD KNOB UP  
TURN LATCH CLOCKWISE

**7.) On Right Rear Window Molding in Baggage Area: (SN 30-853 and 30-902 Through 30-2000)**

MAXIMUM BAGGAGE AND/OR PASSENGER WEIGHT  
250 LBS IN BAGGAGE AREA INCLUDING SEATS  
SEE WEIGHT AND BALANCE

**8.) At the Fuel Strainer Compartment:**

FUEL STRAINERS DRAIN ONLY TANK INDICATED BY  
FUEL SELECTOR. ALLOW SUFFICIENT DRAIN TIME.

## PROCEDURES

All of the following procedures were supplied by Piper Aircraft to comply with the requirements of Part 3 of the Civil Aviation Regulations effective May 15, 1956, as amended.

### A.) Fuel System:

#### 1.) Normal Operation

##### a.) Takeoff and Landing

- 1.) Fuel valves "ON" main tanks.
- 2.) Electric fuel pumps "ON".

##### b.) Cruising

- 1.) Fuel valves "ON" main or auxiliary tanks.
- 2.) Electric fuel pumps "OFF".

#### 2.) Emergency Operation -- Single Engine

A crossfeed is provided to increase the range during single engine emergency operating conditions. Fuel system operation is as follows:

##### a.) Cruising

- 1.) When using fuel from tanks from the same side as the operating engine the following will apply:
  - a.) Fuel valve "ON" (main or auxiliary) on Operating engine side.
  - b.) Fuel valve "OFF" on Inoperative engine side.
  - c.) Electric fuel pumps "OFF" (except in case of engine driven pump failure, electric fuel pump on operating engine side must be used).
- 2.) When using fuel from tanks on the opposite side of the operating engine the following will apply:
  - a.) Fuel valve "ON" (main or auxiliary) on Inoperative engine side.
  - b.) Electric fuel pumps "OFF" (except in case of engine driven pump failure, electric fuel pump on operating engine side must be used).
  - c.) "CROSSFEED ON" on Operating engine side.

Warning: DO NOT ATTEMPT TO PUT BOTH FUEL SELECTOR VALVES ON CROSSFEED.

##### b.) Landing

- 1.) Fuel valve "ON" main tank on Operating engine side.
- 2.) Fuel valve "OFF" on Inoperative engine side.
- 3.) Electric fuel pump "ON" on Operating engine side.

## PROCEDURES (Cont.)

### B.) Propeller Feathering Procedure:

- 1.) "Open Throttle" on Operating Engine to maintain altitude and airspeed above 97 MPH.
- 2.) "Close Throttle" on Inoperative Engine.
- 3.) Pull mixture control on Inoperative engine to "Idle Cut-Off".
- 4.) Pull prop control in Inoperative engine to "Feather" position.
- 5.) Ignition switches "OFF" on Inoperative engine.
- 6.) Electric fuel pumps "OFF".
- 7.) Main fuel valve on inoperative engine "OFF".  
See Fuel System Emergency Operation. (A.2.)  
See A.2. for fuel scheduling.

### C.) Propeller Unfeathering Procedure:

- 1.) Turn fuel valve "ON" on inoperative engine side.
- 2.) Turn electric fuel pump "OFF".
- 3.) "OPEN" throttle 1/4 inch.
- 4.) Advance propeller to "HIGH RPM".
- 5.) Advance mixture to "FULL RICH".
- 6.) Turn ignition switches "ON".
- 7.) Engage starter and hold until engine is started.
- 8.) Reduce propeller control to cruise RPM.
- 9.) Advance throttle to desired power.

### D.) Emergency Extension of Landing Gear:

- 1.) Reduce power -- airspeed not to exceed 100 MPH.
- 2.) Place Landing Gear Selector Switch in the center "OFF" position if equipped with a three position gear switch or the "GEAR DOWN LOCKED" position if equipped with a two position gear switch.
- 3.) Disengage motor. Raise motor release arm and push forward through full travel.
- 4.) Remove gear extension handle from stowage. If left socket is not in clear position, place handle in right socket. Engage slot and twist clockwise to secure handle. Extend handle and rotate forward until left socket is in clear position. Remove handle and place in left socket and secure. Extend handle. Rotate handle forward FULL forward to extend landing gear and to engage emergency safety lock.
- 5.) Handle locked in full forward position indicates landing gear is down and emergency safety lock engaged. Gear "DOWN LOCKED" indicator light should be "ON".

NOTE: Reducing power and rocking gear extension handle will aid in manually extending the landing gear. DO NOT RETRACT WITH HANDLE IN SOCKET. DO NOT RE-ENGAGE MOTOR IN FLIGHT.

## PROCEDURES (Cont.)

### E.) Circuit Breakers:

(SN 30-1 Through 30-1744 Except 30-1717) All circuit breakers are grouped in one panel in floor aft of the nose wheel well under a door marked "CIRCUIT BREAKER ACCESS DOOR".

(SN 30-1717 and 30-1745 Through 30-2000) All circuit breakers are grouped in the lower right corner of the instrument panel.

To reset the circuit breakers push in on the reset button.

### F.) Stopping Engines:

When operating under high ambient temperature conditions engine shutdown by mixture alone may not be positive.

Shutting down the engines under these conditions should be as follows:

- 1.) Pull the mixture controls to idle cut-off.
- 2.) Depress button on left side of quadrant.
- 3.) Pull back on throttles and hold until engines stop.

### G.) Warning:

#### 1.) Maneuvers:

This airplane is certified as a normal category airplane and must be operated in compliance with the Airplane Flight Manual. Acrobatic maneuvers (including spins) are prohibited. Stalls and slow flight should be performed only in accordance with the Airplane Flight Manual.

Avoid abrupt maneuvers. Maneuvers at speeds and weights in excess of the maneuvering speeds and loadings listed under Limitations Section of this Flight Manual may subject the airplane to load factors beyond which it is certificated.

Maintain at least 5,000 feet of terrain clearance when practicing stalls.

#### 2.) Spins:

All spins are prohibited, however, in the event an unintentional spin is encountered recovery can be accomplished by immediately using the following procedures:

- a.) Retard both throttles to the idle position.
- b.) Apply full rudder in the opposite direction to the spin.
- c.) Push control wheel full forward. While it is not necessary for recovery, the use of ailerons against the turn (i.e. right aileron if the spin is to the left) will expedite recovery.
- d.) Maintain controls in these positions until the spin stops. Then neutralize rudder and ailerons.
- e.) Recover from dive with smooth back pressure on the control wheel. No abrupt control movement should be used during recovery from the dive, as the maneuvering speed and positive limit maneuvering load factor may be exceeded.

## PROCEDURES (Cont.)

### H. Alternator System: (Non-Paralleling Type)

Press-to-test switches, in conjunction with the ammeter, are used to determine the output of each alternator. These switches are located directly below the ammeter. In the normal position the ammeter indicates battery charge or discharge current. Depressing the ammeter press-to-test switch causes the ammeter to indicate the output current for the corresponding alternator, viz. the left switch checks the left alternator.

A preflight check of the alternators should be made during engine run-up. With both engines operating at approximately 2000 RPM, depress the alternator press-to-test switches individually and check alternator outputs. These should be approximately equal.

In the event of failure of the voltage regulating system an auxiliary regulating system may be switched into the circuit. Abnormal operation may be indicated by zero output on both alternator test positions and a discharge indication for the battery. To energize the auxiliary regulating system the following procedure shall be followed:

- 1.) Reduce aircraft electrical load to minimum for continued safe flight.
- 2.) Switch "VOLTAGE REGULATOR SELECTOR" to "AUXILIARY" position.
- 3.) Reset tripped breakers but do not reset "MAIN" Voltage Regulator Breaker.
- 4.) Return to normal required electrical load.

If the electrical system still fails to maintain correct output while using the AUX VOLTAGE REGULATOR system, an alternator failure has probably occurred. To isolate the faulty component the following procedure should be followed:

- 1.) Reduce aircraft electrical load to minimum for continued safe flight.
- 2.) Turn aircraft MASTER SWITCH "OFF"
- 3.) Place both alternator output circuit breaker switches "OFF".
- 4.) Reset both MAIN and AUX Voltage Regulator Circuit Breakers, if tripped. Return Voltage Regulator Selector to "MAIN".
- 5.) Turn aircraft MASTER SWITCH "ON". Reset voltage regulator circuit breaker if tripped.
- 6.) Close one alternator output circuit breaker switch. Observe if electrical system is operating normally by checking for alternator output current on the ammeter. If not operating properly, open the alternator output circuit breaker; turn aircraft MASTER SWITCH "OFF" for approximately six seconds to reset the overvoltage relay.
- 7.) Turn aircraft MASTER SWITCH "ON". Close other alternator output circuit breaker switch and observe if electrical system is operating normally by checking ammeter indication as above.
- 8.) Check that aircraft electrical load does not exceed the output capability of the operating alternator causing the battery to discharge.

#### Caution:

Use of the voltage regulator selector switch and alternator circuit breakers should be limited to the above conditions.

## SECTION 3 - EMERGENCY PROCEDURES

PA-30 \* 3600 LBS GROSS WEIGHT

### Table of Contents

#### ENGINE INOPERATIVE PROCEDURES:

Determining Inoperative Engine .....	3-2
Engine Failure During Takeoff .....	3-2
Engine Power Loss During Climb .....	3-3
Engine Power Loss During Flight .....	3-3
Engine Securing Procedure (Feathering Procedure) .....	3-3
Single Engine Operation on Crossfeed .....	3-4
Air Start (Unfeathering Procedure) .....	3-4
Engine Roughness in Flight .....	3-4
Engine Fire During Start .....	3-5
Fire in Flight .....	3-5
Electrical Fire .....	3-5
Engine Fire .....	3-5
Power Off Landing (Both Engines Out) .....	3-6
Gear Down Emergency Landing Procedure .....	3-6
Gear Up Emergency Landing Procedure .....	3-6
Single Engine Landing .....	3-7
Single Engine Go-Around .....	3-7
Simulated Single Engine Operation .....	3-7

#### SYSTEMS EMERGENCIES:

Electrical Failures (Delco Generator) .....	3-8
Electrical Failures (Prestolite Alternator) .....	3-9
High Oil Temperature .....	3-10
High Cylinder Head Temperature .....	3-10
Loss of Oil Pressure .....	3-10
Loss of Fuel Pressure .....	3-10
Induction System Icing .....	3-10
Gyro Suction Failure .....	3-11
Propeller Overspeed .....	3-11
Open Door in Flight .....	3-11
Landing Gear Failure and Manual Gear Extension .....	3-12
Spin Recovery .....	3-13
Emergency Descent .....	3-13
Oxygen System Failure .....	3-13
Other Emergency .....	3-13

## EMERGENCY PROCEDURES

PA-30 \* 3600 LBS GROSS WEIGHT

### DETERMINING INOPERATIVE ENGINE

- 1.) **Dead foot, dead engine** - The airplane will yaw in the direction of the dead engine. Rudder pressure required to maintain directional control will be on the side of the good engine.
- 2.) **Verify by throttle** - Manifold pressure gauges and tachometers will indicate near normal readings, and should not be used to determine an inoperative engine. Partially retard the throttle on the engine that is believed to be inoperative. There should be no change in control pressures or engine sound if the correct throttle has been selected.

### ENGINE FAILURE DURING TAKEOFF

#### 1.) If 90 MPH IAS (78 KT) Has Not Been Attained:

Throttles ..... Both Closed  
 Braking ..... Maximum

If insufficient runway remains for stopping:

Fuel Selector ..... Off  
 Master Switch ..... Off

Continue straight ahead, turning to avoid obstacles.

**\*\* WARNING \*\***

Runway length should be greater than the accelerate/stop distance required.

A check should be made early in the takeoff roll for proper engine operation. Any indication of a sluggish or rough running engine is reason to discontinue the takeoff.

#### 2.) If Between 90 and 105 MPH IAS (78 and 91 KT):

The pilot must decide whether to abort the takeoff or continue on a single engine. Consideration must be given to runway remaining, weight, density altitude, obstacles, weather and pilot capability.

#### 3.) If 105 MPH IAS (91 KT) Has Been Attained:

If sufficient runway remains for a normal landing, land straight ahead.

If insufficient runway remains:

Landing Gear ..... Retract  
 Wing Flaps ..... Retract  
 Airspeed ..... Maintain  $V_{YSE}$  (105 mph or 91 kt)

Initiate **Engine Power Loss During Climb** procedure. (Page 3-3)



### ENGINE POWER LOSS DURING CLIMB

- Airspeed ..... Establish  $V_{YSE}$  (105 mph or 91 kt)
- Inoperative Engine ..... Identify and Verify
- Rudder ..... Apply Towards Operating Engine
- Aileron ..... Bank 5 Degrees Into Operating Engine
- Turn-and-Bank Indicator ..... Displace Ball 1/2 Ball Width Toward Operating Engine
- Operative Engine ..... Full Power

Initiate **Engine Securing Procedure**. (Below)

### ENGINE POWER LOSS DURING FLIGHT

The most important aspect of engine failure is the necessity to maintain lateral and directional control. If airspeed is below  $V_{MCA}$  (90 mph) reduce power on both engines and lower nose of aircraft as required to maintain control and increase speed to 105 mph.

- Inoperative Engine ..... Identify and Verify
- Rudder ..... Apply Towards Operating Engine
- Aileron ..... Bank 5 Degrees Into Operating Engine
- Turn-and-Bank Indicator ..... Displace Ball 1/2 Ball Width Toward Operating Engine
- Operative Engine ..... Adjust Power as Required

Initiate **Engine Securing Procedure**. (Below)

### ENGINE SECURING PROCEDURE (FEATHERING PROCEDURE)

Before securing inoperative engine:

- Fuel Selector ..... Switch to Tank Containing Fuel
- Crossfeed ..... As Required
- Electric Fuel Pump ..... On
- Ignition Switch ..... Check On
- Mixture ..... Full Rich
- Alternate Air ..... On
- Engine Gauges ..... Check For Indication of Cause of Power Loss

If power is restored:

- Electric Fuel Pump ..... Off
- Alternate Air ..... Off

If power cannot be restored:

- Mixture ..... Idle Cut Off
- Fuel Selector ..... Off
- Electric Fuel Pump ..... Off
- Magneto Switch ..... Off
- Cowl Flap ..... Closed
- Propeller Control ..... Feather Position
- Generator or Alternator ..... Off
- Electrical Load ..... Reduce if Necessary

Land as soon as practical at nearest suitable airport.

Initiate **Single Engine Operation On Crossfeed** procedure if necessary. (Page 3-4)

### SINGLE ENGINE OPERATION ON CROSSFEED

The fuel crossfeed system should be used only during emergency conditions and only in level flight.

Inoperative Engine Side ..... Fuel Valve on "MAIN" or "AUX"  
Operative Engine Side ..... Crossfeed On

**\*\* NOTE \*\* - Do Not Put BOTH Fuel Selector Valves on Crossfeed.**

Before landing the fuel system should be taken off crossfeed by the following procedure.

Operative Engine Side ..... Fuel Valve on Inboard Main Tank  
Inoperative Engine Side ..... Fuel Valve Off  
Operative Engine Side ..... Electric Fuel Pump On

### AIR START (UNFEATHERING PROCEDURE)

Magneto Switch ..... On  
Mixture ..... Rich  
Fuel Selector ..... On  
Electric Fuel Pump ..... On  
Throttle ..... 1/4 in. Open  
Propeller Control ..... Forward to Cruise Setting  
Starter ..... Engage Until Propeller Windmills

When engine starts, adjust throttle, propeller and mixture controls.

Oil Pressure ..... Check  
Electric Fuel Pump ..... Off  
Cowl Flap ..... As Required  
Generator or Alternator ..... On

Warm engine at approximately 2000 rpm and 15 in. Hg.

### ENGINE ROUGHNESS IN FLIGHT

Affected engine:

Alternate Air ..... On

If roughness continues after one minute:

Alternate Air ..... Off

In the interim:

Mixture ..... Adjust for Maximum Smoothness  
Electric Fuel Pump ..... On  
Fuel Selector ..... Switch Tanks  
Engine Gauges ..... Check for Indication of Cause of Power Loss  
Magnetos ..... Check Left Then Right Then Both

If operation is satisfactory on one magneto, continue at reduced power and standard mixture to the nearest airport.

Prepare for **Engine Power Loss During Flight Procedure.** (Page 3-3)

### ENGINE FIRE DURING START

Affected engine:

Starter ..... Continue Cranking Engine  
Mixture ..... Idle Cut-Off  
Throttle ..... Open  
Electric Fuel Pump ..... Off  
Fuel Selector ..... Off  
If Fire Continues ..... Extinguish With Best Available Means

**\*\* NOTE \*\*** - Use radio if necessary to call for fire fighting assistance.

### FIRE IN FLIGHT

Determine Source of Fire ..... Electrical or Engine

#### 1.) Electrical Fire: (Or Smoke In Cabin)

Master Switch ..... Off  
Vents ..... Open  
Door ..... Open (If Necessary) as an Exhaust  
Cabin Heater ..... Off  
Oxygen (If Equipped) ..... As Required

Land as soon as possible without flaps. ( $V_{APP} = 100$  mph or 87 kt)

Initiate **Manual Gear Extension** procedure @ Part 3. (Page 3-12)

#### 2.) Engine Fire:

Affected engine:

Throttle ..... Full Aft - Closed  
Mixture ..... Idle Cut-Off  
Fuel Selector ..... Off  
Electric Fuel Pump ..... Check Off

Initiate **Engine Power Loss During Flight** procedure. (Page 3-3)

### POWER OFF LANDING (BOTH ENGINES OUT)

Locate suitable field, preferably with an alternate.

Determine wind direction.

Establish Best Glide and Spiral Pattern ..... 110 mph (96 kt) @ Full Gross Weight  
Propellers ..... Feather

Tune radio to 121.5, tune transponder to 7700.

While at altitude - if time allows:

Broadcast ..... Mayday

#### \*\* Aircraft Identification - Location - Number On Board \*\*

#### 1.) Gear Down Emergency Landing Procedure:

When committed to landing:

ELT ..... Activate Manually  
Throttles ..... Full Aft - Closed  
Fuel Selectors ..... Off  
Mixture Controls ..... Idle Cut-Off  
Ignition Switches ..... Off  
Seat Belt and Harness ..... Tight  
Door ..... (Pilot's Discretion) ..... Block Open  
Wing Flaps ..... As Required

#### \*\* WARNING \*\*

Glide ratio is reduced radically when gear is lowered. Landing gear down operation time is approximately 7 seconds.

Landing Gear ..... Lower Just Before Touchdown  
Master Switch ..... Off

Touchdown should normally be made at the slowest possible airspeed.

#### 2.) Gear Up Emergency Landing Procedure:

A gear up landing should only be made during an emergency when:

- A.) The surface is too soft or rough for a gear down landing.
- B.) A field is too short. (Pilot's discretion)
- C.) Ditching (a forced water landing) is necessary.

Wing Flaps ..... Up  
Throttles ..... Full Aft - Closed  
Fuel Selectors ..... Off  
Mixture Controls ..... Idle Cut-Off  
Ignition Switches ..... Off  
Seat Belt and Harness ..... Tight  
Door ..... (Pilot's Discretion) ..... Block Open  
Master Switch ..... Off

### SINGLE ENGINE LANDING

On final approach when it is certain the field can be reached:

Landing Gear ..... Extend  
Wing Flaps ..... Extend 15 Degrees  
Airspeed ..... Blue Line (105 mph or 91 kt)

### SINGLE ENGINE GO-AROUND

Power ..... Full Power  
Rudder ..... Apply Towards Operating Engine as Required  
Aileron ..... Bank 5 Degrees Into Operating Engine  
Turn-and-Bank Indicator ..... Displace Ball 1/2 Ball Width Toward Operating Engine  
Landing Gear ..... Retract  
Wing Flaps ..... Retract  
Airspeed ..... Establish  $V_{YSE}$  (105 mph or 91 kt)

**\*\* NOTE \*\*** - Aircraft will not climb with gear and flaps extended.

### SIMULATED SINGLE ENGINE OPERATION

Simulated engine failure of a multi-engine aircraft is the most dangerous form of training a pilot is likely to experience. It is recommended that in order to remain proficient, the pilot should practice single-engine operation periodically, and only with an experienced multi-engine instructor. Simulated engine failure should be performed at an altitude that will allow enough room for safe recovery (5000 ft min. terrain clearance is recommended) should control of the airplane be lost.

Airspeed ..... Less Than 125 mph (109 kt)  
Left Engine Throttle ..... Retard  
Right Engine ..... Full Power  
Rudder ..... Toward Operating Engine  
Aileron ..... Bank 5 Degrees Into Operating Engine  
Turn-and-Bank Indicator ..... Displace Ball 1/2 Ball Width Toward Operating Engine  
Left Engine Propeller ..... Feather  
Maintain Airspeed Above  $V_{SSE}$  ..... 97 mph (84 kt)

**\*\* NOTE \*\***

While  $V_{SSE}$  is the accepted airspeed below which an engine should never be intentionally failed, it is recommended that the airspeed never be allowed to fall below the blue line (105 mph) when operating on a single engine.

Due to asymmetrical thrust, the airplane will yaw and roll toward the dead engine. Maintaining wings level and holding the ball of the turn-and-bank indicator in the center can increase  $V_{MCA}$  as much as 20 knots. In addition, the high drag caused by the wings level, ball centered configuration can reduce single-engine climb performance by as much as 300 ft./min.

To overcome the yaw and roll moments induced by an engine failure, bank approximately 5 degrees into the operating engine, and displace the ball of the turn-and-bank indicator approximately 1/2 ball width toward the operating engine.

## ELECTRICAL FAILURES

(For an Aircraft Equipped With Dual Generators)

### 1.) Excessive Discharge:

**\*\* NOTE \*\***

Generators produce no charging output when engines are operated below 1200 rpm.

An excessive rate of discharge at normal operating rpm indicates a defective generator or voltage regulator.

Ammeter ..... Indicates Battery Discharge  
Generator Circuit Breakers ..... Check and Reset as Required

**\*\* NOTE \*\***

Before attempting to reset any circuit breaker, allow for a two to five minute cooling off period. Reset only once.

If circuit breaker is reset (closed):

Electrical Load ..... Reduce to a Minimum

If at least one generator output cannot be maintained with electrical load reduced to a minimum:

Generator Circuit Breaker (Defective Generator) ..... Pull

Maintain minimum electrical load and land as soon as practical.

**\*\* NOTE \*\***

With both generators inoperative, the battery is the only remaining source of power. If the battery is depleted:

Land without wing flaps. ( $V_{APP} = 100$  mph or 87 kt)

Initiate **Manual Gear Extension** Procedure @ Part 3. (Page 3-12)

### 2.) Battery Overcharge:

**\*\* NOTE \*\***

A high rate of charge is normal for the first few minutes of flight.

An excessive rate of charge after several minutes at normal operating rpm indicates a defective battery or voltage regulator.

Ammeter ..... Indicates Excessive Charge  
Generator Circuit Breaker (Defective Generator) ..... Pull  
Electrical Load ..... Reduce to a Minimum

Anticipate complete electrical failure. Land as soon as practical.

**\*\* NOTE \*\***

The battery (which may be defective) is the only remaining source of power.

### ELECTRICAL FAILURES

(For an Aircraft Equipped With Non-Paralleling Dual Alternators)

**\*\* NOTE \*\***

The ammeter normally indicates battery charge or discharge. Depressing and holding the alternator "LEFT" or "RIGHT" press-to-test switch will indicate the output of the corresponding alternator. The outputs of the two alternators should be approximately equal.

Ammeter ..... Indicates Battery Discharge

Check press-to-test switches. If output of one alternator is zero, reduce non-essential electrical load until ammeter indicates charging, and proceed with flight. Check circuit breaker of the defective alternator. If tripped, reduce load to a minimum and attempt to reset. Allow for a two to five minute cooling off period before attempting to reset any circuit breaker. Reset only once.

**\*\* CAUTION \*\***

The alternator circuit breakers and voltage regulator selector switch should never be operated when the engine is running except in an emergency.

If both alternators read zero, reduce electrical load to a minimum.

Voltage Regulator Selector Switch ..... "AUX" Position  
Voltage Regulator Circuit Breakers ..... Reset if Necessary

If one or both alternators return on line (ammeter indicates battery charging) reinstate electrical load (as ammeter indication permits).

If output is not restored:

Voltage Regulator Selector Switch ..... Return to "MAIN" Position  
Both Alternator Circuit Breakers ..... Off

A defective alternator will trip the system's overvoltage relay. Reset the overvoltage relay by turning the master switch "OFF", waiting a minimum of 6 seconds for the overvoltage relay to reset, and then returning the master switch to the "ON" position. Activate alternators one at a time by resetting the respective alternator circuit breaker and then resetting the overvoltage relay again if necessary. When the defective alternator is identified, continue flight on the remaining alternator. Operate with only essential load if necessary.

If both alternators are defective, or for any other reason the electrical system cannot be restored, maintain minimum electrical load and land as soon as practical.

With both alternators inoperative, the battery is the only remaining source of power. If the battery is depleted:

Land without wing flaps. ( $V_{APP} = 100$  mph or 87 kt)

Initiate **Manual Gear Extension** Procedure @ Part 3. (Page 3-12)

### HIGH OIL TEMPERATURE

Cowl Flaps ..... Open  
Mixture ..... Enrich  
Power ..... Reduce if Necessary  
Airspeed ..... Maintain Above 130 mph (113 kt)

Land as soon as possible and investigate cause.

Prepare for **Engine Power Loss During Flight** Procedure. (Page 3-3)

### HIGH CYLINDER HEAD TEMPERATURE

Excessive cylinder head temperature may parallel high oil temperature, and the procedure for handling it is the same. Refer to **High Oil Temperature** procedure. (above)

### LOSS OF OIL PRESSURE

Land as soon as possible and investigate cause.

Prepare for **Engine Power Loss During Flight** procedure. (Page 3-3)

### LOSS OF FUEL PRESSURE

**\*\* NOTE \*\***

The most common cause of fuel pressure loss is fuel exhaustion due to improper fuel management. In the event of fuel pressure loss:

Fuel Selector ..... Switch to a Tank Containing Fuel  
Electric Fuel Pump ..... On  
Mixture ..... Enrich

If pressure is not regained:

Electric Fuel Pump ..... Off

Initiate **Engine Power Loss During Flight** procedure. (Page 3-3)

### INDUCTION SYSTEM ICING

It is very rare but possible for ice to form in the engine's induction system. The first indication of induction system icing is usually a drop in fuel flow, followed by engine roughness.

Alternate Air ..... Full On  
Throttle ..... Full Open  
Mixture ..... Adjust for Maximum Smoothness

When ice is cleared:

Alternate Air ..... Full Off  
Throttle ..... Normal Cruise Setting  
Mixture ..... Adjust to EGT Gauge  
Fuel Flow Gauge ..... Monitor for Recurrence



### GYRO SUCTION FAILURE

The Twin Comanche is equipped with dual vacuum pumps. If one of the vacuum pumps should fail, a mechanical indicator will identify "left" or "right" and the remaining pump will take over the load.

If a problem should arise where suction is lost:

Suction Below 4.8 in. Hg.

RPM ..... Increase to 2700  
Altitude ..... Descend to Maintain 4.8 in. Hg.

Use electric turn coordinator and magnetic compass to monitor artificial horizon and directional gyro.

If adequate gyro suction can not be maintained, initiate VFR or partial panel IFR procedures as appropriate.

Land as soon as practical and investigate cause.

### PROPELLER OVERSPEED

Affected engine:

Propeller Control ..... Aft - Decrease rpm.  
Throttle ..... Retard  
Airspeed ..... Reduce  
Throttle ..... As Required to Remain Below 2700 rpm.

Feather propeller if necessary.

Land as soon as possible and investigate cause.

#### \*\* NOTE \*\*

If an overspeed condition should occur, refer to Lycoming Service Bulletin 369F for appropriate corrective action.

### OPEN DOOR IN FLIGHT

If latches are not secure, the door will trail slightly open and airspeed will be slightly reduced. Buffeting may be experienced.

To close door in flight:

Airspeed ..... Below 100 mph (87 kt)  
Cabin Vents ..... Close  
Storm Window ..... Open  
Slip Airplane ..... Facing Door Into Wind  
Latch ..... Secure

An open door in flight presents no real danger. However, the high level of noise caused by an open door can give concern to passengers and be distracting to the pilot. If unable to close the door in flight, land as soon as practical with approximately a 10 mph increase over normal landing speed.

## LANDING GEAR FAILURE AND MANUAL GEAR EXTENSION

### 1.) Prior To Executing Emergency Procedure:

Master Switch ..... Check On  
Landing Gear Circuit Breakers ..... Check and Reset as Required

If breakers are reset (closed), continue with emergency procedure:

### 2.) If Landing Gear Operates, But Green (Gear Down - Locked) Lamp Fails To Illuminate:

Navigation Lights ..... Check Off  
Landing Gear Indicator Light ..... Replace as Required

#### \*\* NOTE \*\*

If this procedure is due to an electrical failure, landing gear position lights and warning horn will be inoperative.

### 3.) If Landing Gear Fails To Operate, Initiate Manual Gear Extension Procedure:

Airspeed ..... Below 100 mph (87 kt)  
Landing Gear Switch ..... Gear "DOWN LOCKED" Position  
Landing Gear Switch (Three Position Type) ..... Center "OFF" Position  
Motor Release Arm ..... Disengage and Push Forward. Through Full Travel

Allow landing gear to fall.

Gear Extension Handle ..... Remove From Stowage

If left socket is not in clear position, place handle in right socket.

Gear Extension Handle ..... Engage Slot and Twist Clockwise to Secure

Extend handle and rotate forward until left socket is in clear position.

Gear Extension Handle ..... Place in Left Socket and Secure

Extend handle and rotate **FULL** forward to extend landing gear and (if installed) emergency safety lock will engage.

Handle locked in full forward position indicates landing gear is down and (if installed) emergency safety lock engaged. Gear "DOWN LOCKED" indicator light should be on.

Do not retract landing gear with handle in socket.

#### \*\* CAUTION \*\*

Do not re-engage landing gear operating motor in flight. To reduce landing gear side loads to a minimum, avoid a crosswind landing and high speed turns while taxiing.

## SPIN RECOVERY

### \*\* WARNING \*\*

The Twin Comanche is certified as a Normal category airplane. Intentional spins are prohibited.

Throttles ..... Idle  
Ailerons ..... Neutral  
Rudder ..... Full Opposite to Direction of Rotation  
Control Wheel ..... Briskly Forward Full Travel  
Rudder ..... Neutral When Rotation Stops  
Control Wheel ..... Back Pressure to Recover From Dive

### \*\* NOTE \*\*

Application of the ailerons opposite the direction of rotation can expedite recovery of the Twin Comanche.

## EMERGENCY DESCENT

### 1.) Oxygen System Failure:

#### \*\* WARNING \*\*

Time of useful consciousness in the event of oxygen system failure while operating an aircraft at 20,000 ft. is ten minutes.

Seat Belt and Harness ..... Secure  
Throttles ..... Retard  
Propeller Controls ..... Full Forward - Increase rpm.  
Landing Gear ..... Down Under 150 mph (130 kt)  
Airspeed ..... Maintain Below 150 mph (130 kt)

#### \*\* CAUTION \*\*

A 2,000 to 3,000 ft./minute descent is adequate to answer the emergency with minimal risk of damage to the engines, and discomfort to the passengers.

Consider elevation of terrain on descent. Initiate recovery procedure at 10,000 ft. MSL. or 2,000 ft. AGL. as appropriate.

Landing Gear ..... Retract  
Mixture ..... Enrich  
Throttles ..... Increase Slowly  
Propeller Controls ..... Cruise Setting

Adjust altitude and power setting as appropriate and continue flight to destination airport.

### 2.) Other Emergency:

In the event of an emergency where thermal shock to the engines and passenger discomfort are overridden by other factors (such as a fire that cannot be extinguished) which require getting the airplane on the ground as quickly as possible, the additional action of rolling the aircraft to a 40 to 45 degree bank and descending in a spiral destroys a large portion of lift and increases rate of descent substantially.

## SECTION 4 - NORMAL PROCEDURES

PA-30 \* 3600 LBS GROSS WEIGHT

### Table of Contents

Airspeeds for Safe Operation .....	4-2
Noise Abatement .....	4-2
Preflight Check .....	4-3
Cabin .....	4-3
Walk Around Inspection .....	4-3
Right Wing .....	4-3
Nose Section .....	4-3
Left Wing .....	4-3
Fuselage and Empennage .....	4-4
Preflight Check for Night Operation .....	4-4
Before Starting Engines .....	4-4
Starting Engines When Cold .....	4-5
Starting Engines When Hot .....	4-5
Starting Engines When Flooded .....	4-5
Starting With External Power Source .....	4-6
Before Taxiing .....	4-6
Taxiing .....	4-6
Engine Run-Up .....	4-7
Before Takeoff .....	4-7
Takeoff .....	4-8
Maximum Performance Climb .....	4-8
Reduced Power Climb .....	4-8
Short Field Takeoff and Obstacle Clearance .....	4-8
Soft Field Takeoff .....	4-9
Climb .....	4-9
Cruising .....	4-10
Descent .....	4-10
Approach and Landing .....	4-10
Short Field Landing .....	4-11
Soft Field Landing .....	4-11
Go Around .....	4-11
After Landing .....	4-11
Engine Shutdown .....	4-12
Parking and Mooring .....	4-12

## NORMAL PROCEDURES

PA-30 \* 3600 LBS GROSS WEIGHT

### AIRSPEEDS FOR SAFE OPERATION

The following airspeeds are those which are significant for safe operation of the airplane. The figures are for a standard airplane flown at gross weight under standard sea-level conditions.

V <sub>A</sub> - Design Maneuvering Speed / Turbulent Air Penetration Speed .....	162 mph	141 kt
V <sub>APP</sub> - Final Approach to Landing Speed .....	95 mph	83 kt
V <sub>FE</sub> - Flap Extension Speed .....	125 mph	108 kt
V <sub>FE</sub> - Recommended .....	100 mph	87 kt
V <sub>LO</sub> - Landing-Gear Operation Speed .....	150 mph	130 kt
V <sub>LO</sub> - Recommended .....	125 mph	108 kt
V <sub>MCA</sub> - Single Engine Minimum Control Speed .....	90 mph	78 kt
V <sub>NE</sub> - Never Exceed Speed .....	230 mph	200 kt
V <sub>R</sub> - Rotation Speed (W/Zero Degrees of Flap) .....	90 mph	78 kt
V <sub>S0</sub> - Stall Speed (Power Off - Full Flaps and Gear Extended) .....	69 mph	60 kt
V <sub>S1</sub> - Stall Speed (Power Off - Clean) .....	76 mph	66 kt
V <sub>SSE</sub> - Minimum Intentional Single Engine Speed .....	97 mph	84 kt
V <sub>X</sub> - Best Angle-of-Climb Speed (At Sea Level) .....	90 mph	78 kt
V <sub>XSE</sub> - Best Single Engine Angle-of-Climb Speed .....	94 mph	82 kt
V <sub>Y</sub> - Best Rate-of-Climb Speed (At Sea Level) .....	112 mph	97 kt
V <sub>YSE</sub> - Best Single Engine Rate-of-Climb Speed .....	105 mph	91 kt
Best En Route Rate-of-Climb Speed .....	130 mph	113 kt
Demonstrated Crosswind Component .....	20 mph	17 kt

### NOISE ABATEMENT

Environmental concerns require that measures be taken to minimize the effect of airplane noise around airports or when operating near the ground. The following is a general guideline.

Many airports have published noise-abatement procedures. Pilots should become familiar with these procedures and conform to them. Pilots should also avoid noise-sensitive areas such as recreational and residential areas.

VFR departure from, and approach to an airport should be made so as to avoid prolonged flight at an altitude lower than 2,000 ft AGL. This procedure would only apply where weather permits. Other factors such as conflict with instructions from Air Traffic Control or the pilot's responsibility to see and avoid other aircraft will override this procedure.

No determination has been made by the Federal Aviation Administration as to whether the noise level of the Comanche is or should be acceptable by any standard for operation at, into, or out of any airport.

### PREFLIGHT CHECK

#### 1.) Cabin:

Control Wheel ..... Release Restraint  
Avionics Master (Or Radios) ..... Check Off  
Ignition ..... Check Off  
Landing Gear Selector ..... Down  
Master Switch ..... On  
Fuel Quantity Gauge ..... Check Each Tank  
Wing Flaps ..... Lower  
Master Switch ..... Off  
Oxygen Quantity (If Equipped and Required) ..... Adequate  
Required Papers and Navigation Charts ..... On Board

### WALK AROUND INSPECTION

Exterior ..... Check for Damage and Evidence of Fluid Leaks

#### 2.) Right Wing:

Control Surfaces ..... Check for Interference  
Wing Tip and Navigation Light ..... Check  
Fuel Tanks ..... Check Supply Visually - Adjust and Secure Caps  
Fuel Tank Vents and Overflow Drains ..... Open  
Tie Down and Wheel Chock ..... Remove  
Main Gear Strut ..... Proper Inflation 2-3/4 in  
Tire ..... Check for Wear and Proper Inflation  
Oil ..... Check Level  
Dip Stick and Oil Inspection Cover ..... Secure  
Air Inlets ..... Clear  
Propeller ..... Check for Nicks  
Area Around Propeller ..... Clear of Debris  
Cowling ..... Secure

#### 3.) Nose Section:

Windshield ..... Clean  
Heater and Ventilating Air Inlet ..... Clear  
Nose Gear Strut ..... Proper Inflation 2-3/4 in  
Tire ..... Check for Wear and Proper Inflation

#### 4.) Left Wing:

Oil ..... Check Level  
Dip Stick and Oil Inspection Cover ..... Secure  
Air Inlets ..... Clear  
Propeller ..... Check for Nicks  
Area Around Propeller ..... Clear of Debris

### WALK AROUND INSPECTION (Cont.)

#### 4.) Left Wing:(Cont.)

Cowling ..... Secure  
Fuel Tanks ..... Check Supply Visually - Adjust and Secure Caps  
Fuel Tank Vents and Overflow Drains ..... Open  
Tie Down and Wheel Chock ..... Remove  
Main Gear Strut ..... Proper Inflation 2-3/4 in  
Tire ..... Check for Wear and Proper Inflation  
Stall Warning Transmitter Switch ..... Free  
Pitot Head ..... Cover Removed - Hole Clear  
Wing Tip and Navigation Light ..... Check  
Control Surfaces ..... Check for Interference

#### 5.) Fuselage and Empennage:

Static Vents ..... Holes Clear  
Control Surfaces ..... Check for Interference  
Navigation Lights ..... Check  
Antennas ..... Check  
Dorsal Fin Ventilating Air Inlet ..... Clear  
Tie Down ..... Remove  
Baggage Door ..... Secure

**\*\* WARNING \*\*** In winter insure that all surfaces are free of ice, frost and snow.

### PREFLIGHT CHECK FOR NIGHT OPERATION

If operation of aircraft extends into night:

Master Switch ..... On  
Navigation and Landing Lights ..... Check  
Panel and Cabin Lights ..... Check  
Master Switch ..... Off  
Flashlight ..... On Board

### BEFORE STARTING ENGINES

Seats ..... Erect  
Belts and Harness ..... Fastened and Adjusted  
Brakes ..... Set  
Fuel Strainers ..... Drain Sample (5 Seconds) and Check Each Tank  
Fuel Selectors ..... Inboard Main Tanks  
Circuit Breakers ..... Check In  
Avionics Master (Or Radios) ..... Check Off  
Generator Switches (If Equipped with Generators) ..... Check On  
Air Vents, Heater and Defroster ..... As Desired  
Alternate Static Source (If Installed) ..... Closed  
Controls ..... Free and Correct  
Door ..... Latched  
Cowl Flaps ..... Open

### STARTING ENGINES WHEN COLD

Throttle ..... 1/2 in Open  
Propeller Control ..... Full Forward - Increase rpm  
Master Switch ..... On  
Electric Fuel Pump ..... On  
Mixture ..... Full Rich  
Fuel Flow Meter ..... Indicates 5 gpm Flow (Engine is Primed)  
Mixture ..... Idle Cut-Off

**\*\* CLEAR PROP \*\***

Magneto Switches ..... On  
Starter ..... Engage (Maximum 15 Seconds)  
Mixture ..... Advance Slowly to Full Rich  
Throttle ..... Adjust  
Oil Pressure ..... Check

**\*\* CAUTION \*\***

If oil pressure is not indicated within 30 seconds, stop engine and determine cause of trouble.

Repeat Procedure for Opposite Engine.

### STARTING ENGINES WHEN HOT

Throttle ..... Full Forward - Open  
Propeller Control ..... Full Forward - Increase rpm  
Master Switch ..... On  
Electric Fuel Pump ..... On  
Mixture ..... Full Rich to Purge Lines - Then Idle Cut-Off  
Electric Fuel Pump ..... Off

**\*\* CLEAR PROP \*\***

Magneto Switches ..... On  
Starter ..... Engage (Maximum 15 Seconds)  
Throttle ..... Adjust  
Mixture ..... Advance Slowly to Full Rich  
Oil Pressure ..... Check

### STARTING ENGINES WHEN FLOODED

Throttle ..... Full Forward - Open  
Propeller Control ..... Full Forward - Increase rpm  
Master Switch ..... Check On  
Mixture ..... Idle Cut-Off  
Electric Fuel Pump ..... Off

**\*\* CLEAR PROP \*\***

Magneto Switches ..... On  
Starter ..... Engage (Maximum 15 Seconds)  
Throttle ..... Retard  
Mixture ..... Advance to Full Rich  
Oil Pressure ..... Check

**\*\* CAUTION \*\***

Starter manufacturers recommend that cranking periods be limited to thirty seconds with a two minute rest between cranking periods. Longer cranking periods shorten the life of the starter.



### STARTING WITH EXTERNAL POWER SOURCE

(For an aircraft that is equipped with an auxiliary power receptacle.)

Master Switch ..... Check Off  
All Electrical Equipment ..... Check Off  
Alternate Battery Terminals ..... Connect  
External Power Cable ..... Insert in Fuselage

Initiate appropriate starting procedure.

Throttle(s) ..... Lowest Possible rpm  
External Power Cable ..... Disconnect From Fuselage  
Throttle ..... Above 1200 rpm  
Master Switch ..... On  
Ammeter ..... Check for Normal Charging

**\*\* NOTE \*\*** Do not attempt flight if battery is not charging properly.

### BEFORE TAXIING

Rotating Beacon ..... On  
Electric Fuel Pump ..... Off  
Wing Flaps ..... Retract  
Wing Flap Selector ..... Center "OFF" Position  
Landing Gear Indicator Light ..... Check Green  
Avionics Master (Or Radios) ..... On  
Radio Transfer Switches ..... As Required

Flight Instruments:

Artificial Horizon ..... Check Erect and Set  
Rate-of-Climb Indicator ..... Check Zero  
Altimeter ..... Adjust to Local Barometric Setting and Verify  
Field Elevation Reading is Within Acceptable Limits  
Clock ..... Wind and Set

**\*\* NOTE \*\*** If flight plan anticipates instrument meteorological conditions:

Pitot Heat ..... On (Check Ammeter Discharge) Then Off

### TAXIING

Taxi Area ..... Clear  
Throttle ..... Apply Slowly  
Brakes ..... Check  
Steering ..... Check

### ENGINE RUN UP

Brakes ..... Set  
Warm Up ..... 2 to 4 Minutes at 800 to 1200 rpm  
Mixture Controls ..... Check Rich

**\*\* NOTE \*\***

Above 5,000 ft density altitude, mixture should be leaned for takeoff until, and only until, any engine roughness is eliminated.

Propeller Controls ..... Check Full Forward - Increase rpm  
Throttle ..... 2000 rpm

**\*\* CAUTION \*\*** Do not exceed 2200 rpm in a routine static test.

Propeller ..... Cycle as Needed to Circulate Oil and Operate Governor  
Normal Drop - 300 to 400 rpm

Throttle ..... 1000 to 1500 rpm  
Propeller ..... Feather

**\*\* CAUTION \*\***

Move propeller in and out of feathered position rapidly. Do not exceed a 500 rpm drop.

Manifold Pressure ..... 15 in Hg  
Magnetos ..... Check Left and Right

Maximum Drop - 175 rpm  
Maximum Difference - 50 rpm

Vacuum ..... 5.0 in Hg + .1 or - .2 in  
Vacuum L and R Indicators ..... Check  
Ammeter ..... Check Charging  
Alternator Push-to-Test (If Installed) ..... Check  
Oil Temperature ..... Check  
Oil Pressure ..... Check Green  
Throttle ..... Retard

Repeat Procedure for Opposite Engine.

### BEFORE TAKEOFF

Fuel Selectors ..... Leave on Inboard Main Tanks  
Electric Fuel Pumps ..... On  
Wing Flaps ..... Set for Takeoff (Zero to 15 Degrees as Desired)  
Trim Tab ..... Set for Takeoff (Neutral Position for Most Operations)  
Directional Gyro ..... Set Heading  
Engine Gauges ..... Normal  
Strobe Lights (If Installed) ..... On

**\*\* NOTE \*\***

Engines are warm enough for takeoff when throttles can be opened without the engines faltering.

## TAKEOFF

Throttles ..... Open Using a Smooth, Steady Movement  
Accelerate to  $V_R$  ..... 90 mph (78 kt)  
Control Wheel ..... Back Pressure to Rotate to Climb Attitude

**\*\* Establish Positive Rate of Climb \*\***

Brakes ..... Tap  
Landing Gear ..... Retract  
Landing Gear Indicator ..... Amber  
Climb Out at  $V_Y$  ..... 112 mph (97 kt)

### 1.) Maximum Performance Climb:

Power ..... Full Throttle and Maximum rpm

### 2.) Reduced Power Climb:

Full Power ..... Until 1000 ft AGL  
Reduce Power to Climb Setting ..... 25-25  
Continue Climb at Best En Route Speed ..... 130 mph (113 kt)  
Cylinder Head Temperature ..... Maintain in Green

## SHORT FIELD TAKEOFF AND OBSTACLE CLEARANCE

Wing Flaps ..... 15 Degrees  
Trim Tab ..... Set for Takeoff  
Brakes ..... Partial Power Before Brake Release

Release brakes and continue opening throttle using a smooth, steady movement.

Accelerate to 70 to 80 mph (61 to 70 kt) depending on airplane weight.

Control Wheel ..... Back Pressure to Rotate to Climb Attitude

After breaking ground:

Accelerate to  $V_X$  ..... 90 mph (78 kt)

Climb past obstacle.

Accelerate to  $V_Y$  ..... 112 mph (97 kt)  
Landing Gear ..... Retract  
Wing Flaps ..... Retract  
Power ..... As Required Above 1000 ft AGL  
Continue Climb at Best En Route Speed ..... 130 mph (113 kt)

### SOFT FIELD TAKEOFF

Wing Flaps ..... 15 Degrees  
Trim Tab ..... Set for Takeoff  
Control Wheel ..... Full Back Pressure to Relieve Airplane Weight  
Throttle ..... Apply Slowly

**\*\* NOTE \*\***

Once breakaway is achieved and taxi has begun, maintain airplane momentum to avoid becoming bogged down in soggy terrain.

Accelerate until airplane breaks ground. After breaking ground:

Stay in Ground Effect and Accelerate to  $V_X$  ..... 90 mph (78 kt)  
Landing Gear ..... Retract

**\*\* Establish Positive Rate of Climb \*\***

Accelerate to  $V_Y$  ..... 112 mph (97 kt)  
Wing Flaps ..... Retract  
Power ..... As Required Above 1000 ft AGL  
Continue Climb at Best En Route Speed ..... 130 mph (113 kt)

**\*\* NOTE \*\***

The figures for  $V_X$  and  $V_Y$  are based on a 3600 pound gross weight. Both  $V_X$  and  $V_Y$  decrease approximately one mph for every 100 pounds that the airplane is below maximum allowable gross weight.

$V_X$  increases approximately 0.25 mph for each 1,000 foot increase in density altitude above mean sea level.

$V_Y$  decreases approximately 0.75 mph for each 1,000 foot increase in density altitude above mean sea level.

### CLIMB

Best Angle-of-Climb Speed ( $V_X$ ) ..... 90 mph (78 kt)  
Best Rate-of-Climb Speed ( $V_Y$ ) ..... 112 mph (97 kt)  
Best En Route Rate-of-Climb Speed ..... 130 mph (113 kt)  
Cylinder Head Temperature ..... Maintain in Green  
Mixture Controls ..... Adjust With Ascent  
Electric Fuel Pumps ..... Off at Desired Altitude - Check Fuel Flow  
Cowl Flaps ..... Closed at Desired Altitude

**\*\* NOTE \*\***

Best en route rate-of-climb speed decreases approximately 0.75 mph for each 1,000 foot increase in density altitude above mean sea level.

When en route below 5,000 feet MSL, always return mixtures to full rich before increasing power settings. Above 5,000 feet MSL, adjust mixtures as required as over enriching the mixtures at high altitude will result in engine roughness.

## CRUISING

**\*\* NOTE \*\*** Operation above Flight Level 200 is not approved.

Power ..... Set Per Power Table in Section 5 (Performance)  
Normal Maximum Cruise Power ..... 75 Percent  
Mixture Controls ..... Adjust to EGT Gauge

Adjust to 100 degrees Fahrenheit rich of peak EGT at 75 % power.

Adjust to 50 degrees Fahrenheit rich of peak EGT at 65 % power.

### **\*\* WARNING \*\***

Test and verify that fuel is flowing properly from all tanks.

Auxiliary/Tip fuel may be used only in level cruise flight. If aircraft is equipped with wing tip tanks, use tip tank fuel first.

Oxygen is recommended when operating aircraft above 10,000 feet MSL, and required above 12,500 feet MSL. No smoking with oxygen in use.

Propellers ..... Synchronize  
Engine Gauges ..... Monitor

## DESCENT

Propeller Controls ..... Cruise rpm  
Manifold Pressure Gauges ..... 15 to 17 in Hg  
Airspeed ..... Maintain Cylinder Head Temperature in Green  
Mixture Controls ..... Enrich With Descent

## APPROACH AND LANDING

Seats ..... Erect  
Belts and Harness ..... Fasten and Adjust  
Electric Fuel Pumps ..... On  
Fuel Selectors ..... Inboard Main Tanks  
Landing Gear Selector ..... Down Under 125 mph or 108 kt (Recommended)  
Landing Gear Indicator ..... Green  
Wing Flaps ..... As Required Under 100 mph or 87 kt (Recommended)  
Cowl Flaps ..... Open  
Trim Tab ..... Set for Landing  
Propeller Controls ..... 2400 rpm  
Mixture Controls ..... Enrich as Required  
GUMP Check ..... On Final  
V<sub>APP</sub> ..... 95 mph (83 kt)

### **\*\* NOTE \*\***

If crosswind component is above 12 kts, use partial or no wing flaps and above normal approach speed.

### SHORT FIELD LANDING

Airspeed on Final ..... Coordinate to 90 mph (78 kt)  
Throttles ..... Carry Power Until Flare  
Wing Flaps ..... Retract Immediately After Touchdown  
Control Wheel ..... Full Back Pressure to Put Airplane Weight on Main Landing Gear  
Brakes ..... Apply Heavily

### SOFT FIELD LANDING

Airspeed on Final ..... Coordinate to 90 mph (78 kt)  
Throttles ..... Carry Power Until Flare  
Wing Flaps ..... Leave Extended to Maximize Wing Lift  
Control Wheel ..... Back Pressure to Relieve Airplane Weight  
Brakes ..... Utilize Field Conditions to Slow Airplane, Minimum Braking Application

#### \*\* NOTE \*\*

The Comanche has been demonstrated safe when operating in and out of rough grass surfaces.

### GO AROUND

Propeller Controls ..... Full Forward - Increase rpm  
Throttles ..... Full Forward - Open  
Control Wheel ..... Rotate to Climb Attitude

**\*\* Establish Positive Rate of Climb - Move to Right of Runway \*\***

Landing Gear ..... Retract  
Landing Gear Indicator ..... Amber  
Climb Out at  $V_Y$  ..... 112 mph (97 kt)  
Wing Flaps ..... Retract  
Power ..... As Required Above 1000 ft AGL  
Continue Climb at Best En Route Speed ..... 130 mph (113 kt)

### AFTER LANDING

(Clear of Runway)

Wing Flaps ..... Retract  
Wing Flap Selector ..... Center "OFF" Position  
Strobe Lights (If Installed) ..... Off

### ENGINE SHUTDOWN

Idle ..... Until a Decided Decrease in CHT is Noted  
Electric Fuel Pumps ..... Off  
Cabin Heater (If Used) ..... Off  
Tune Comm Radio to 121.5 ..... Check ELT for False Operation  
Rotating Beacon ..... Off  
Avionics Master (Or Radios) ..... Off  
Throttles ..... 1800 rpm  
Clear Plugs ..... 15 to 20 Seconds  
Throttles ..... Reduce to 1200 rpm  
Mixture Controls ..... Idle Cut-Off

**\*\* NOTE \*\***

When operating in high ambient temperatures, engine shutdown by mixture alone may not be positive. Under these conditions, to shut down engines, depress throttle cut-off release button on the left side of the power quadrant and retard throttles fully aft.

Magnetos ..... Off  
Master Switch ..... Off

### PARKING AND MOORING

Control Wheel ..... Secure Restraint  
Wheel Chocks ..... In Place  
Tie Downs ..... Secure  
Pitot Head ..... Cover  
Cabin Fresh Air Inlets ..... Closed  
Storm Window ..... Secure  
Doors ..... Locked

## SECTION 5 - PERFORMANCE

PA-30 \* 3600 LBS GROSS WEIGHT

### Table of Contents

Introduction .....	5-2
Flight Planning Example .....	5-2
Aircraft Loading .....	5-2
Takeoff .....	5-2
Climb .....	5-3
Cruise .....	5-3
Descent .....	5-3
Landing .....	5-3
Flight Summary .....	5-4
Flight Planning Information Supplement .....	5-4
Factors Addressed in the Performance Charts .....	5-4
Factors Not Addressed in the Performance Charts .....	5-4
Figure 5-01 Altitude Conversion Chart .....	5-5
Figure 5-1A Temperature Conversion Chart .....	5-5A
Figure 5-1B Crosswind Component Graph .....	5-5B
Figure 5-02 Airspeed Calibration .....	5-6
Figure 5-03 Part Throttle Fuel Consumption .....	5-7
Figure 5-04 Altitude Performance Curve .....	5-8
Figure 5-05 Power-Off Stall Data .....	5-9
Figure 5-06 Takeoff Ground Run Distance .....	5-10
Figure 5-07 Takeoff Distance Over a 50 ft Obstacle .....	5-11
Figure 5-08 Accelerate-Stop Distance .....	5-12
Figure 5-09 Multi-Engine Rate of Climb Data .....	5-13
Figure 5-10 Single-Engine Rate of Climb Data .....	5-14
Figure 5-11 $V_X$ and $V_Y$ Data .....	5-15
Figure 5-12 True Airspeed .....	5-16
Figure 5-13 Range Profile .....	5-17
Figure 5-14 Endurance Profile .....	5-18
Figure 5-15 Landing Ground Roll Distance .....	5-19
Figure 5-16 Landing Distance Over a 50 ft Obstacle .....	5-20
Figure 5-17 Power Setting Table .....	5-21



## PERFORMANCE

PA-30 \* 3600 LBS GROSS WEIGHT

### INTRODUCTION

The performance graphs in this section were prepared by Piper Aircraft in accordance with FAA regulations. Test data is corrected to ICAO Standard Day conditions. The information shown is unfactored and does not make any allowance for variations in pilot proficiency and/or mechanical condition of the aircraft.

Effects of conditions not considered in the charts such as a grass runway surface on takeoff and landing performance, or the effect of winds aloft on cruise and range performance must be evaluated by the pilot. Range and endurance can be greatly affected by improper leaning. In-flight fuel flow and quantity checks are therefore recommended.

### FLIGHT PLANNING EXAMPLE

The following sample flight problem utilizes information derived from the various charts in this section to determine the predicted performance data for a typical flight. Many of the charts contain an example to show how they are used.

**\*\* WARNING \*\***

Performance information is not valid if readings from the charts are obtained by extrapolation beyond the limits shown on the charts.

#### 1.) Aircraft Loading:

Airplane gross weight and center of gravity may be determined by utilizing information provided in Section 6 (Weight and Balance) of this Manual. The following has been provided for the purpose of computing this flight planning example.

Takeoff Weight .....	3400 lbs
Center of Gravity .....	Within Approved Limits
Usable Fuel .....	84 US gal/504 lbs

#### 2.) Takeoff:

Takeoff Conditions:

Temperature .....	70 Degrees F. (21 Degrees C.)
Pressure Altitude .....	2000 ft MSL
Runway Length Available .....	4100 ft
Runway Headwind Component .....	10 kt

When consulting the Takeoff Performance chart it is necessary to keep in mind that the distances shown are based on use of the short field technique. Ground run distance can be expected to be approximately twice the distance shown when making a standard takeoff.

Ground Run (Figure 5-06) .....	1200 ft
Total Distance to Clear a 50 ft Obstacle (Figure 5-07) .....	2500 ft
Accelerate-Stop Distance (Figure 5-08) .....	2700 ft

### FLIGHT PLANNING EXAMPLE (Cont.)

#### 3.) Climb:

Planned Cruise Altitude ..... 7000 ft MSL  
Average Rate of Climb (Figure 5-09) ..... 1200 ft/min  
Time to Climb ..... 4.0 min  
Fuel Consumption Rate (Figures 5-03 & 5-04) ..... 26.5 gph/159.0 pph  
Fuel Consumption ..... 1.8 US gal/10.8 lbs

#### 4.) Cruise:

##### Cruise Conditions:

Pressure Altitude ..... 7000 ft MSL  
Temperature ..... 40 Degrees F. (05 Degrees C.)  
Expected Headwind Component En Route ..... None

**\*\* NOTE \*\*** Fuel consumption rates are based on best economy mixture.

Power Setting ..... 75 Percent  
TAS (And Ground Speed) (Figure 5-12) ..... 194 mph 169 kt  
Time to Cruise ..... 165 min  
Fuel Consumption Rate (Figures 5-03 & 5-04) ..... 17.2 gph/103.2 pph  
Fuel Consumption ..... 47.3 US gal/283.8 lbs

#### 5.) Descent:

Average Rate of Descent (Each Inch Decrease in MAP = 100 fpm Descent Rate) 700 ft/min  
Time to Descend ..... 4.5 min  
Fuel Consumption Rate (Figures 5-03 & 5-04) ..... 11.0 gph/66.0 pph  
Fuel Consumption ..... 0.8 US gal/4.8 lbs

#### 6.) Landing:

##### Landing Conditions:

Temperature ..... 60 Degrees F. (15 Degrees C.)  
Pressure Altitude ..... 4000 ft MSL  
Runway Length ..... 5200 ft  
Runway Headwind Component ..... 10 kt

When consulting the Landing Performance chart it is necessary to keep in mind that the distances shown are based on use of the short field technique with maximum braking effort. Ground roll distance can be expected to be approximately twice the distance shown on the chart when making a standard landing.

Landing Weight ..... 3100 lbs  
Ground Roll (Figure 5-15) ..... 530 ft  
Total Distance to Clear a 50 ft Obstacle (Figure 5-16) ..... 1800 ft

**FLIGHT PLANNING EXAMPLE (Cont.)**

**7.) Flight Summary:**

Total Flight Time ..... 174 min  
Total Range ..... 557 sm  
Total Fuel Required ..... 50 US gal/300 lbs

**FLIGHT PLANNING INFORMATION SUPPLEMENT**

Takeoff and landing performance is of primary interest in operating an aircraft because it defines the runway length requirements. In addition to the importance of proper piloting technique, any factor which affects the velocity or acceleration during the takeoff run will affect the takeoff distance. Likewise, any factor which affects the landing velocity or deceleration during the landing roll will affect landing distance. Because not all factors affecting takeoff and landing performance are included in the accompanying charts, the following information is provided.

**1.) Factors Addressed in the Performance Charts:**

- A.) Ambient Temperature
- B.) Pressure Altitude
- C.) Gross Weight
- D.) Headwind Component

Runway surface: paved, level, dry.

**2.) Factors Not Addressed in the Performance Charts:**

Percent increase in distance required  
for ground roll and total  
distance over a 50 ft obstacle.

**\*\* NOTE \*\*** Factors are cumulative and must be added.

	Takeoff	Landing
<b>A.) Runway Surface:</b>		
Dry Grass (Short - Less Than 5 in)	20%	20%
Dry Grass (Tall - Greater Than 5 in)	25%	30%
Wet Grass (Short)	25%	30%
Wet Grass (Tall)	30%	40%
Soft Ground or Deep Snow	25% +	25% +
<b>B.) Runway Slope: (Each 2 Degrees)</b>		
(Uphill)	10%	(Downhill) 10%
<b>C.) Tailwind Component: (Equal to 10% of Liftoff Speed)</b>	20%	20%

**\*\* NOTE \*\***

High humidity will reduce engine power as much as 10% and increase takeoff run proportionally.

Numerous variables prevent the precise measurement of the effects of runway surface on rolling resistance. Figures related to runway surface are estimates, and can deviate vastly. A wet and/or icy runway, together with the effects of hydroplaning will greatly reduce braking effectiveness and increase stopping distance up to as much as **six times** normal. Tall grass, soft ground and snow all increase rolling resistance and shorten landing roll, but no set figures are given for their effect.

# ALTITUDE CONVERSION CHART

**\*\* NOTE \*\***

THIS CHART SHOULD BE USED TO DETERMINE DENSITY ALTITUDE FROM EXISTING TEMPERATURE AND PRESSURE ALTITUDE CONDITIONS.

FOR USE WITH THE ACCOMPANYING PERFORMANCE CHARTS.

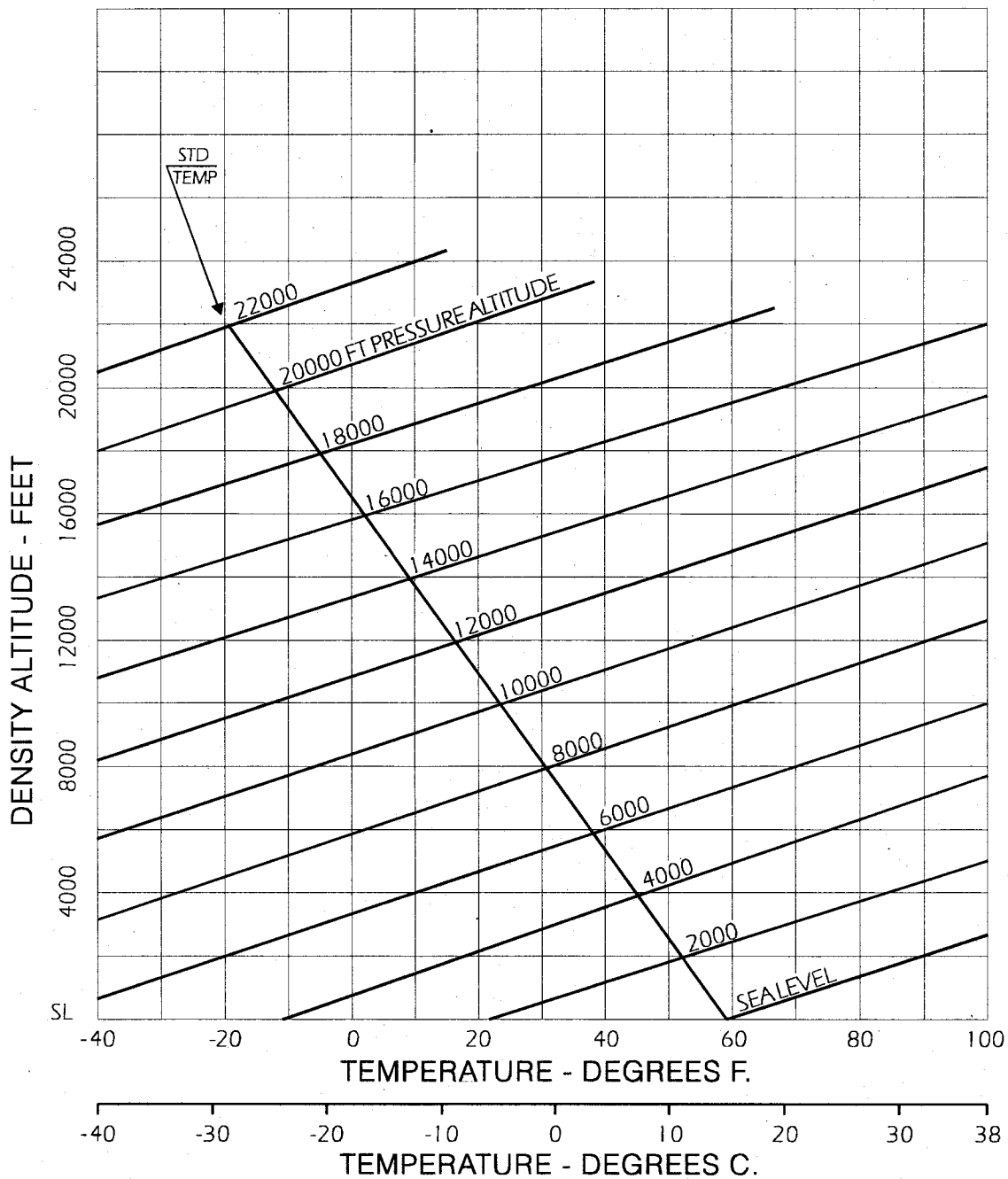

**FIGURE 5-01**

# TEMPERATURE CONVERSION CHART

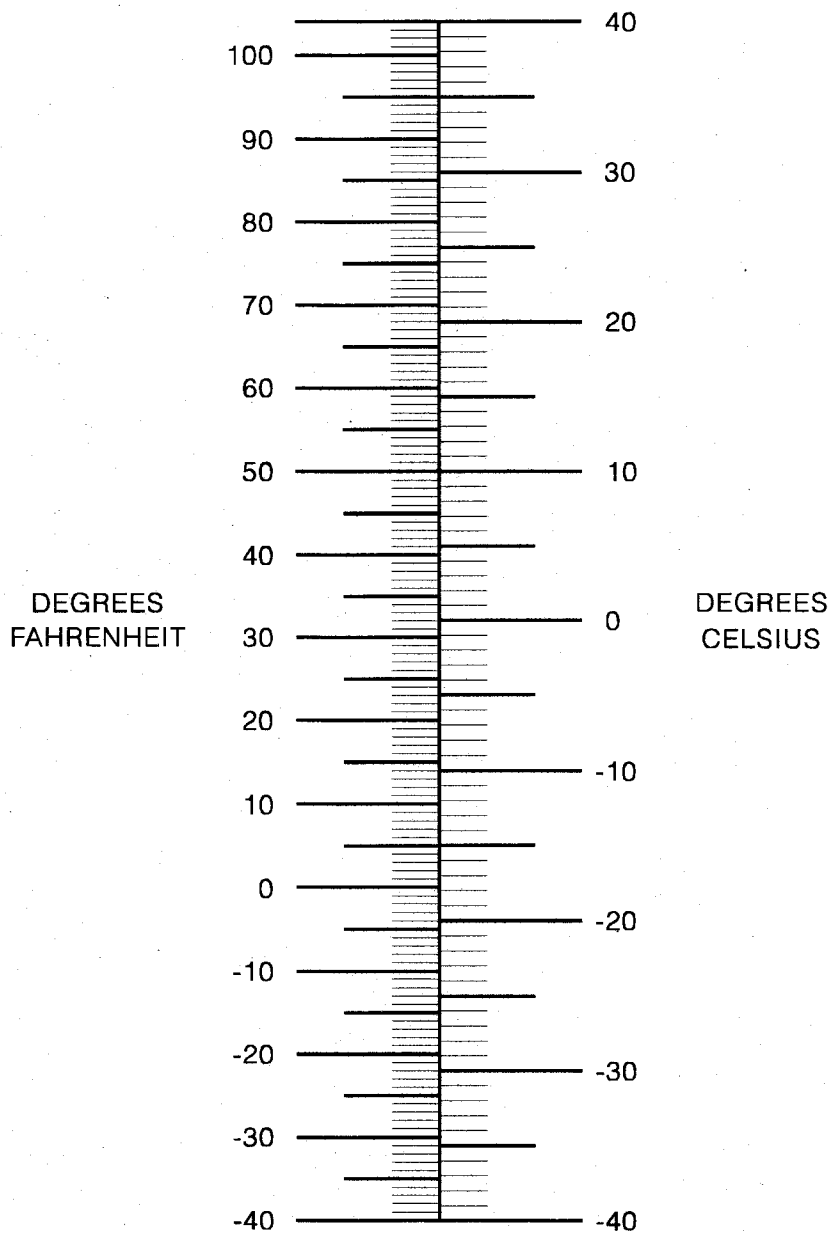

FIGURE 5-1A

# CROSSWIND COMPONENT GRAPH

**\*\* NOTE \*\*** DEMONSTRATED CROSSWIND COMPONENT IS 17 KT (20 MPH)

EXAMPLE DEPICTED:

Windspeed:	20 Kt
Angle Between Wind Direction and Flight Path:	60 Degrees
Headwind Component:	10 Kt
Crosswind Component:	17 Kt

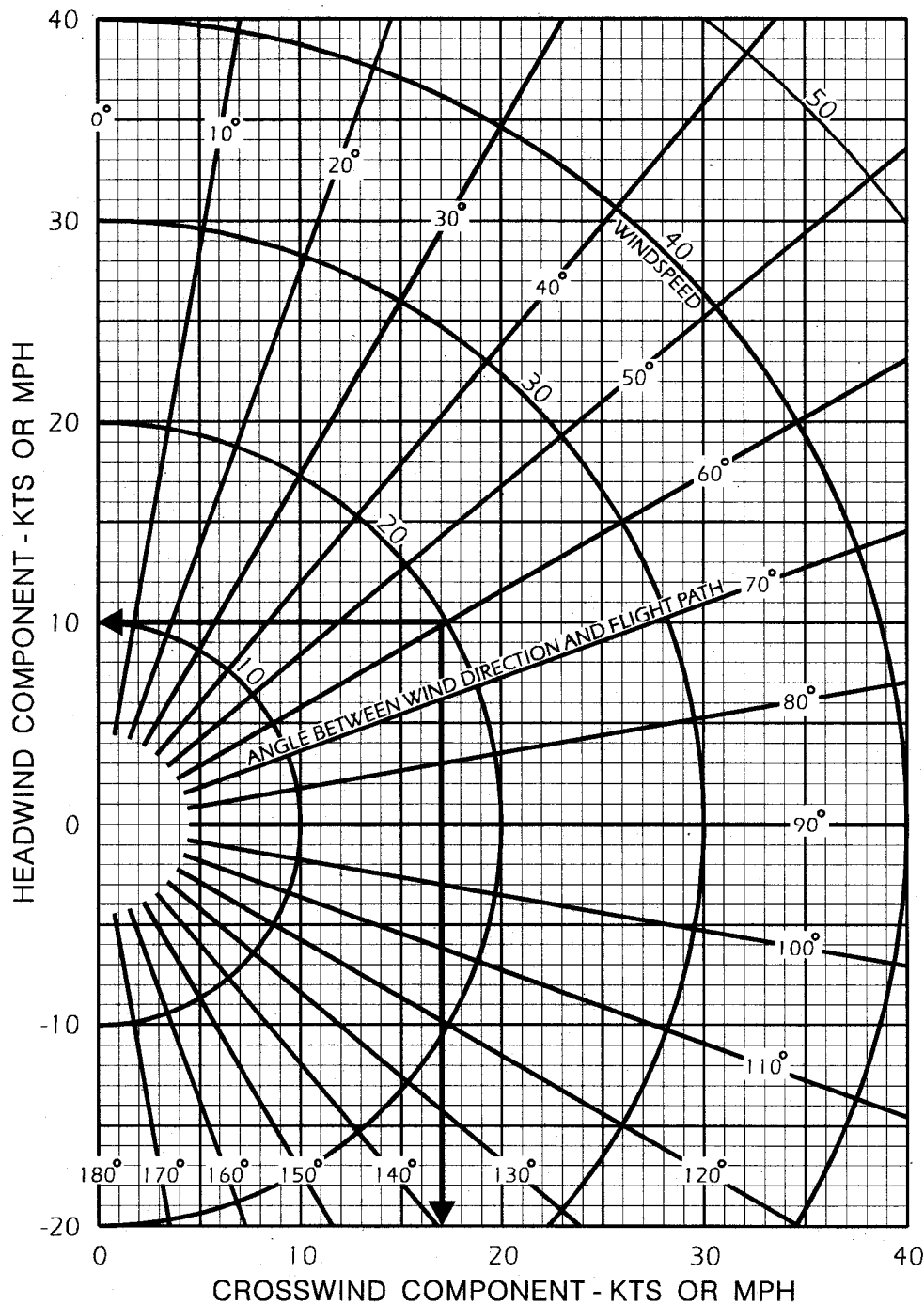

**FIGURE 5-1B**

# AIRSPEED CALIBRATION

PRIMARY PITOT-STATIC SYSTEM

STANDARD PITOT-STATIC HEAD

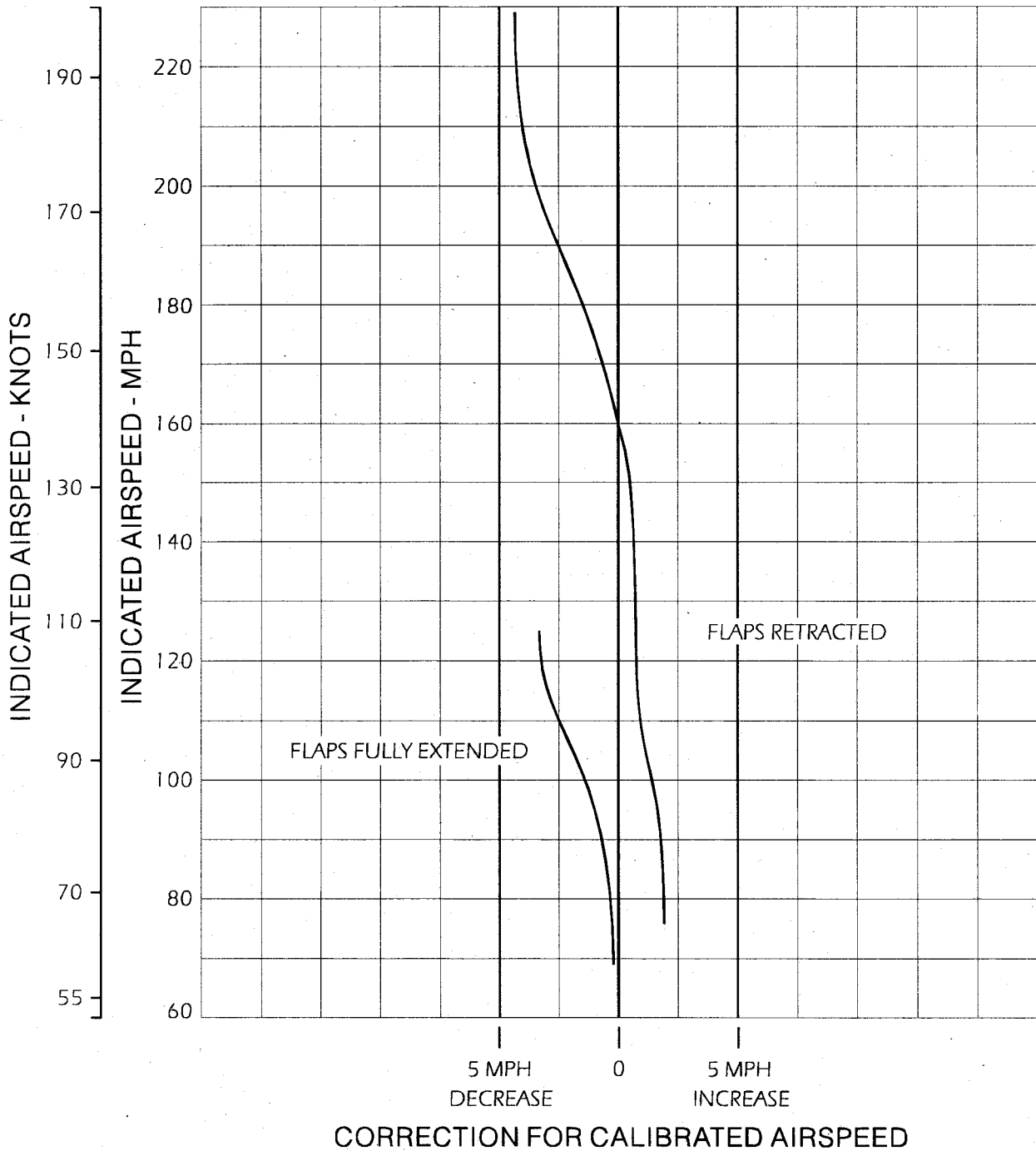

FIGURE 5-02

# PART THROTTLE FUEL CONSUMPTION

LYCOMING IO-320-B SERIES ENGINE  
FUEL INJECTOR: BENDIX RSA-5AD1  
STANDARD SEA LEVEL CONDITIONS

COMPRESSION RATIO: 8.5 TO 1  
MINIMUM FUEL GRADE: 91/96  
MIXTURE: AS NOTED

**\*\* NOTE \*\***

TO OBTAIN FUEL CONSUMPTION AT ALTITUDE, REFER TO ACCOMPANYING  
ALTITUDE PERFORMANCE CURVE.

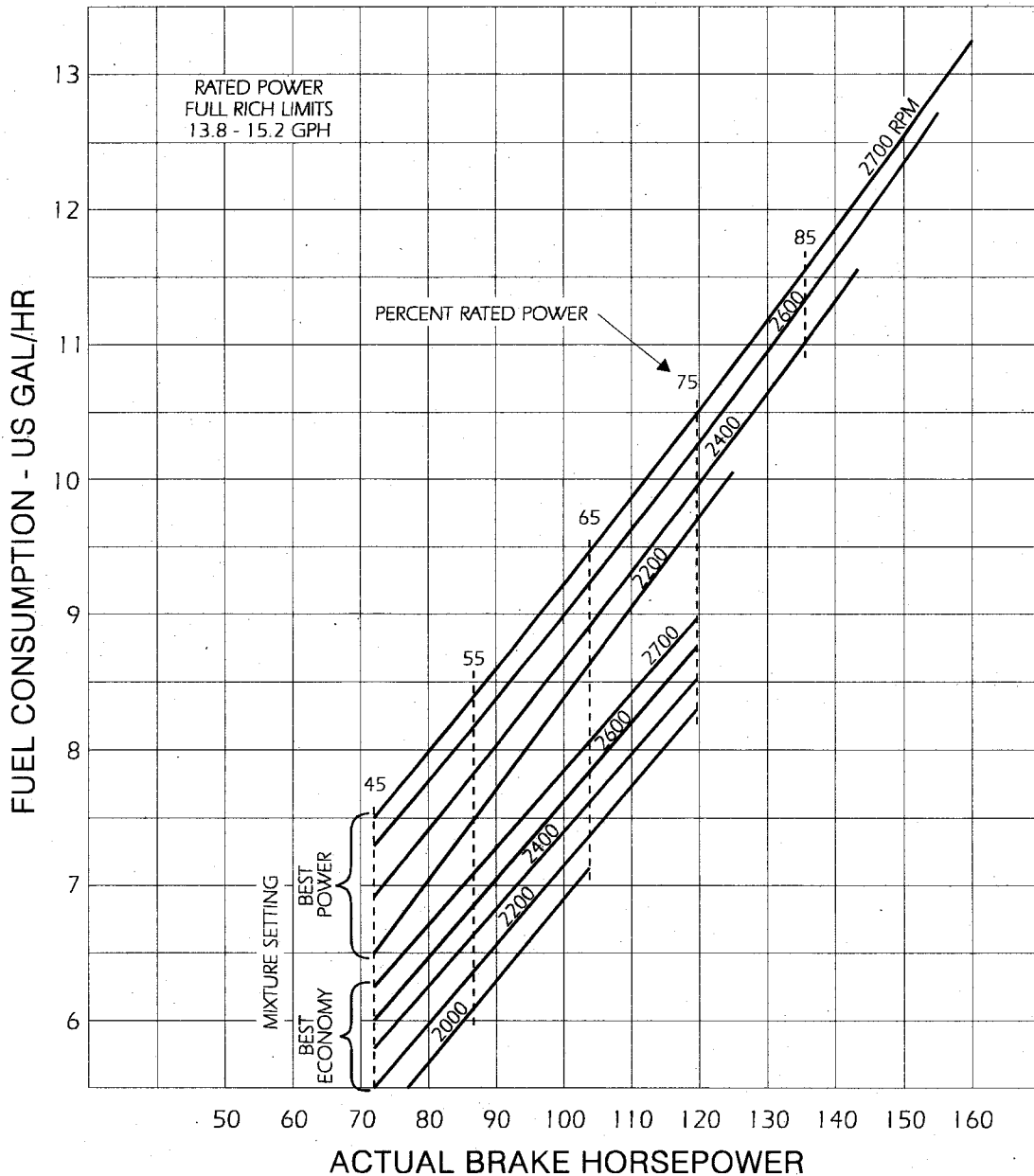

FIGURE 5-03



# ALTITUDE PERFORMANCE CURVE

LYCOMING IO-320-B SERIES ENGINE  
FUEL INJECTOR: BENDIX RSA-5AD1  
STANDARD ATMOSPHERE

COMPRESSION RATIO: 8.5 TO 1  
MINIMUM FUEL GRADE: 91/96  
MIXTURE: BEST POWER

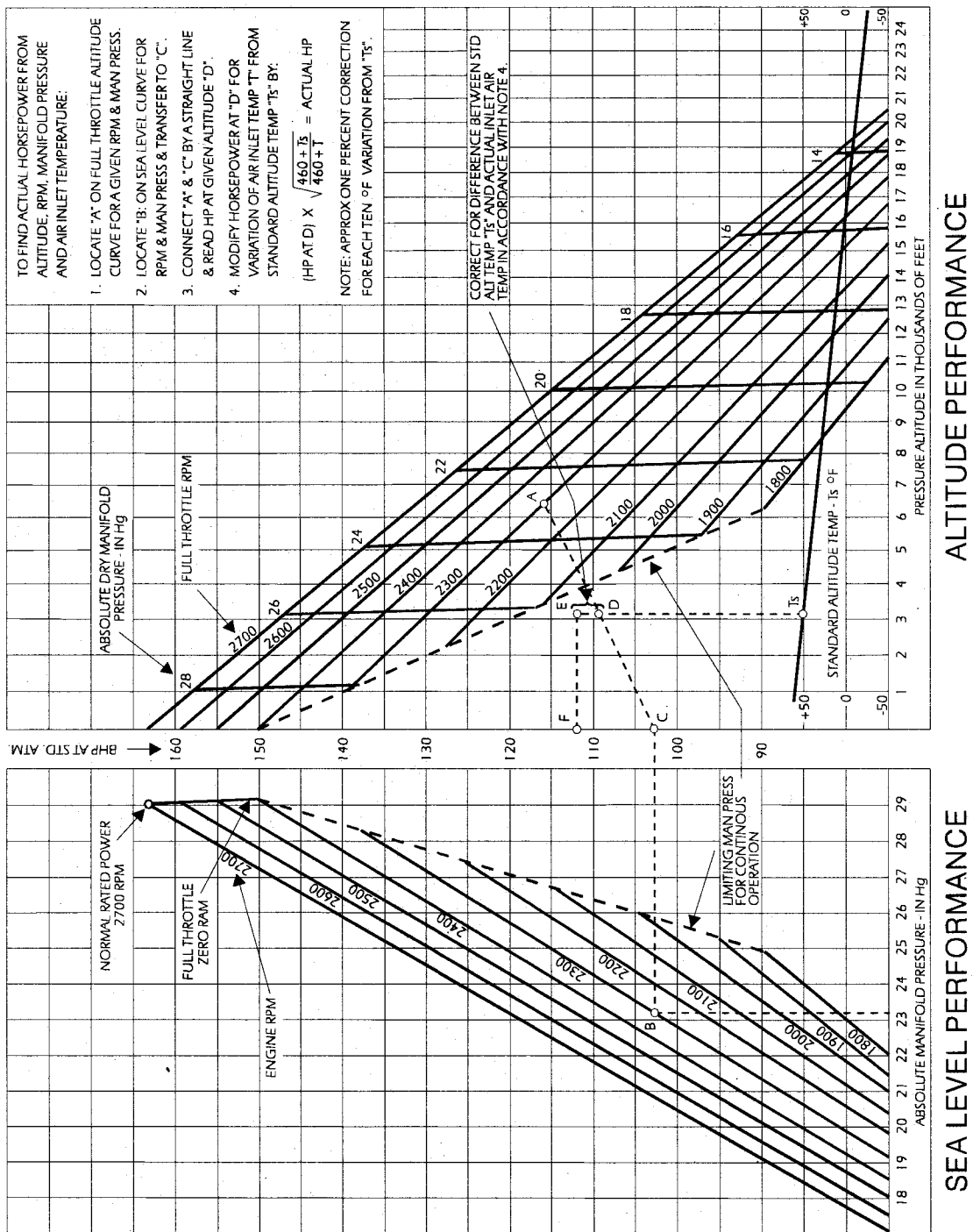

FIGURE 5-04

# STALL SPEED VS GROSS WEIGHT

STANDARD ATMOSPHERE

POWER OFF

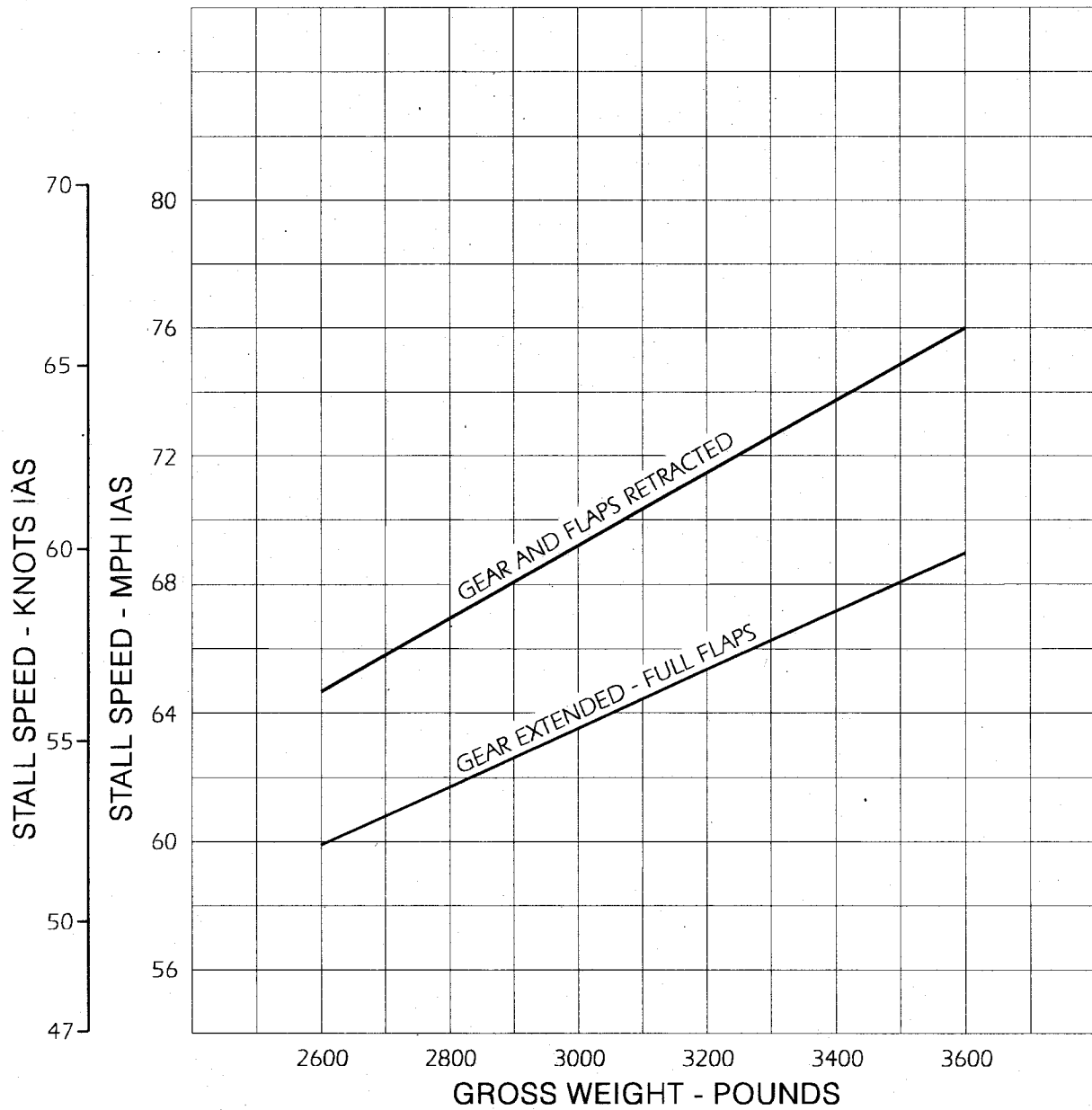

FIGURE 5-05

# STALL SPEED vs GROSS WEIGHT

(Normally Aspirated Model Equipped With Tip Tanks -- 3725 Lbs Gross Weight)

STANDARD ATMOSPHERE

POWER OFF

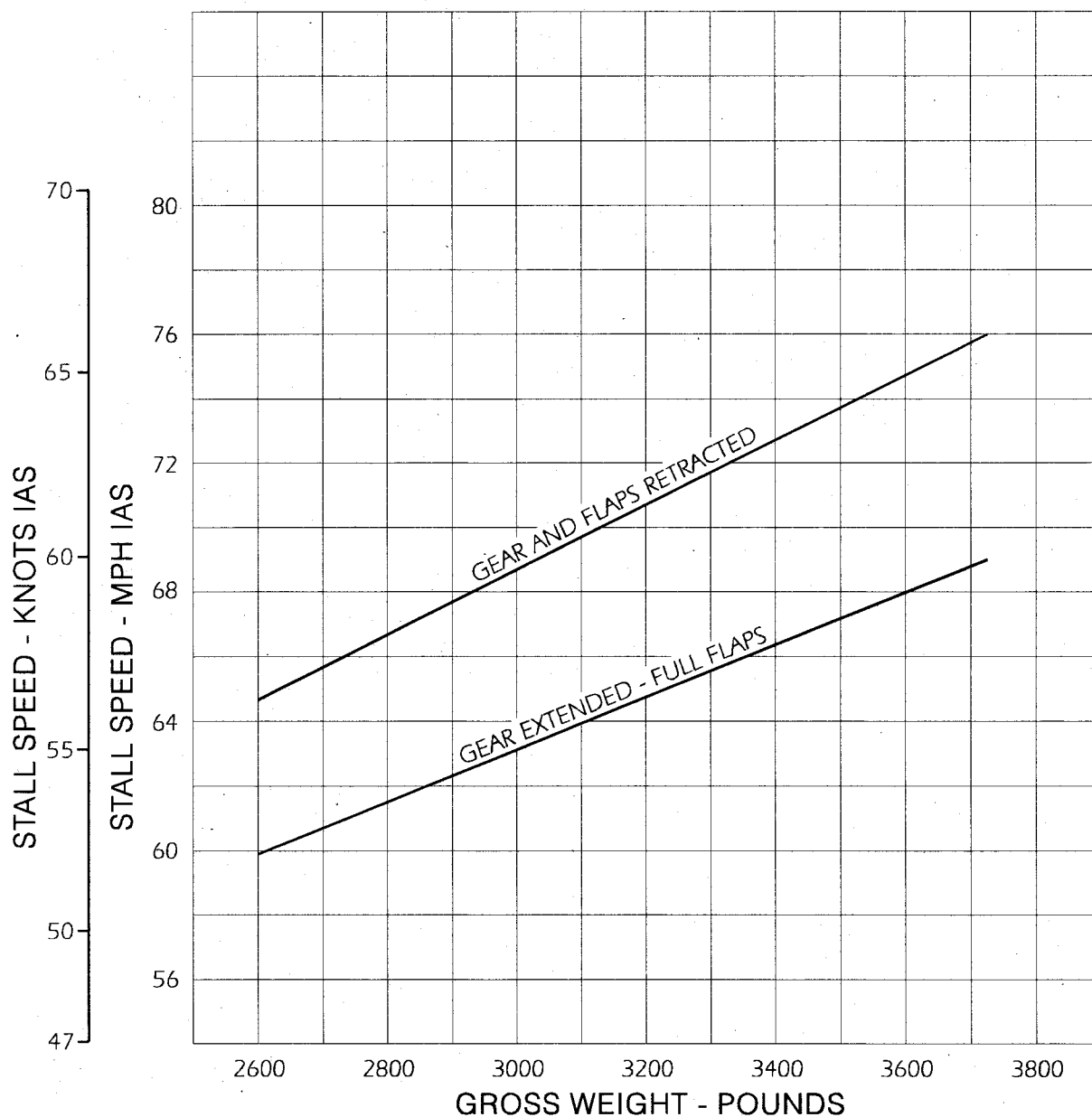

FIGURE 5-05

# TAKEOFF GROUND RUN DISTANCE

WING FLAPS: 15 DEGREES  
 RUNWAY SURFACE: PAVED, LEVEL, DRY

FULL THROTTLE AND MAX RPM  
 TAKEOFF SPEED = 80 MPH IAS

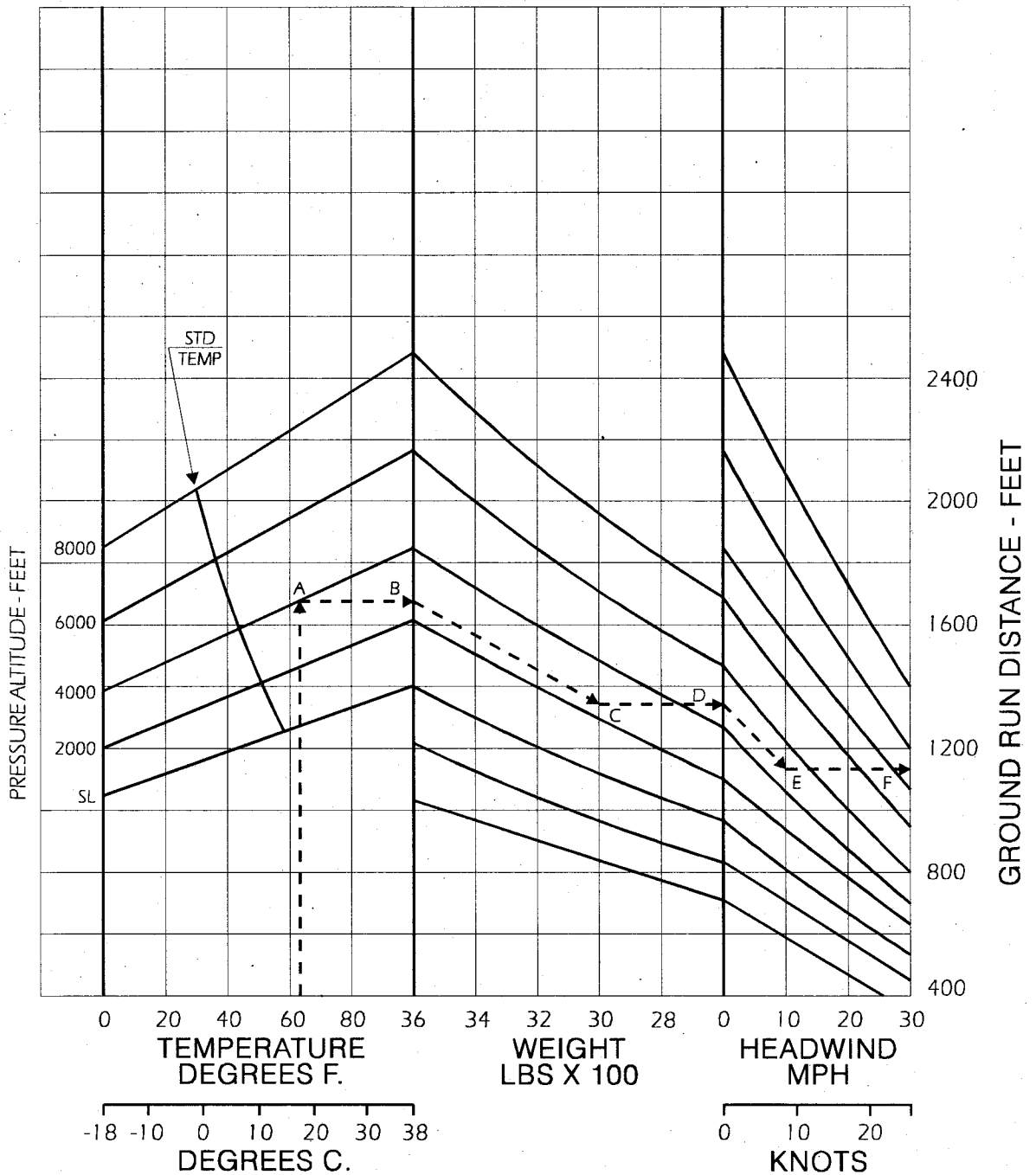

FIGURE 5-06

# TAKEOFF GROUND RUN DISTANCE

(Normally Aspirated Model Equipped With Tip Tanks -- 3725 Lbs Gross Weight)

WING FLAPS: 15 DEGREES  
 RUNWAY SURFACE: PAVED, LEVEL, DRY

FULL THROTTLE AND MAX RPM  
 TAKEOFF SPEED = 80 MPH IAS

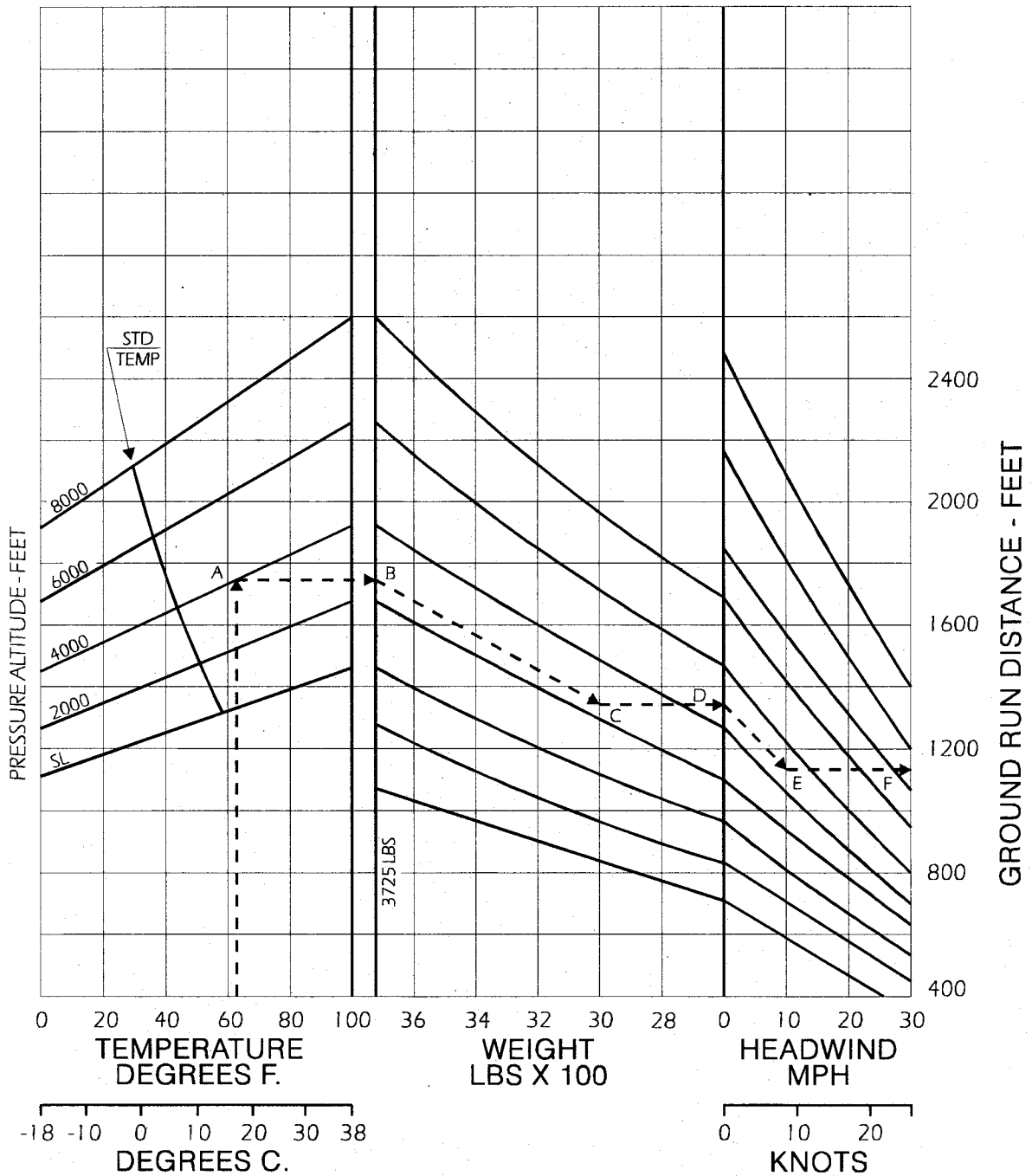

FIGURE 5-06

# TAKEOFF DISTANCE OVER A 50 FT OBSTACLE

WING FLAPS: 15 DEGREES  
 RUNWAY SURFACE: PAVED, LEVEL, DRY

FULL THROTTLE AND MAX RPM  
 ATTAIN 91 MPH AT 50 FT AGL

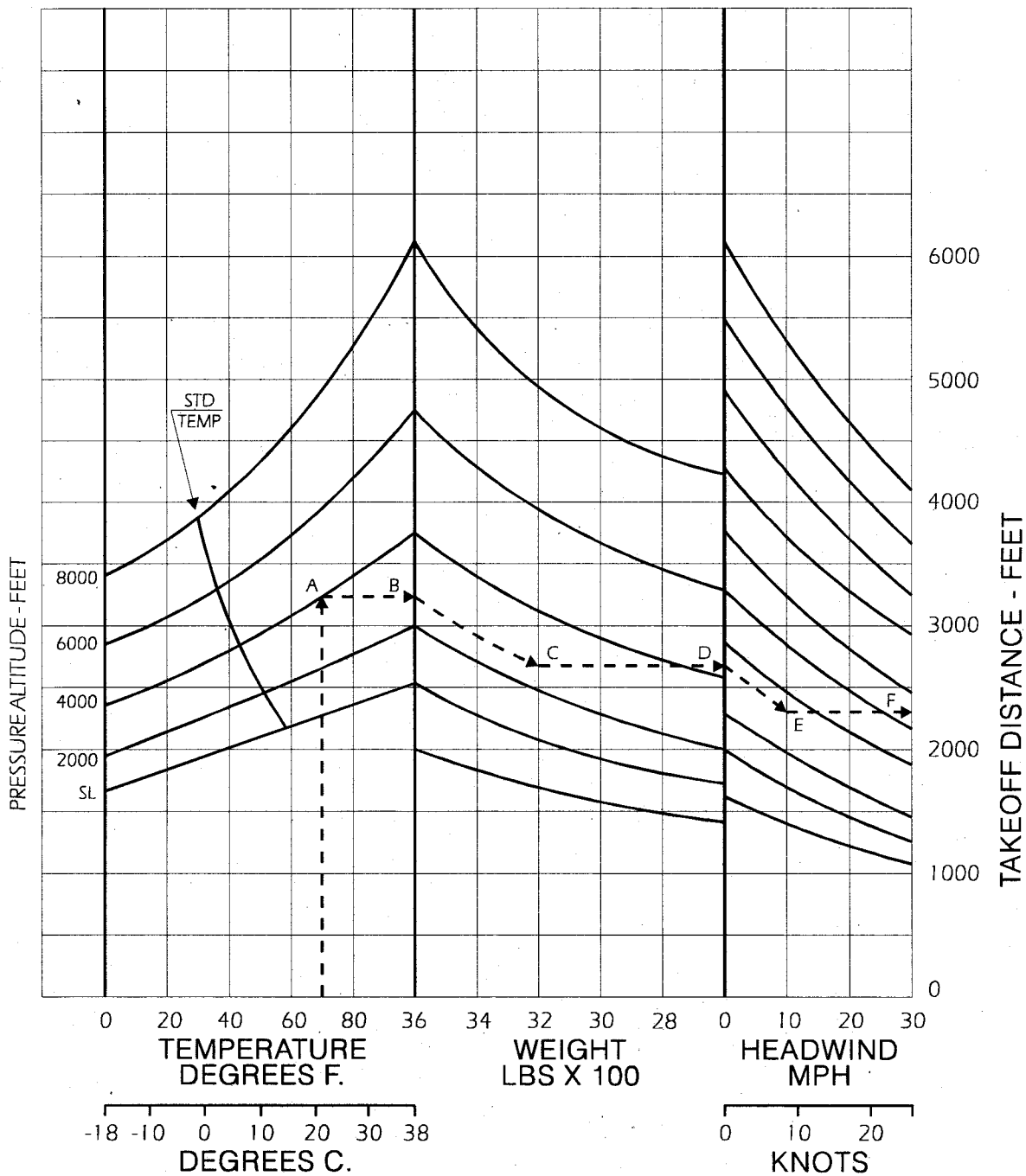

FIGURE 5-07

# TAKEOFF DISTANCE OVER A 50 FT OBSTACLE

(Normally Aspirated Model Equipped With Tip Tanks -- 3725 Lbs Gross Weight)

WING FLAPS: 15 DEGREES  
RUNWAY SURFACE: PAVED, LEVEL, DRY

FULL THROTTLE AND MAX RPM  
ATTAIN 91 MPH AT 50 FT AGL

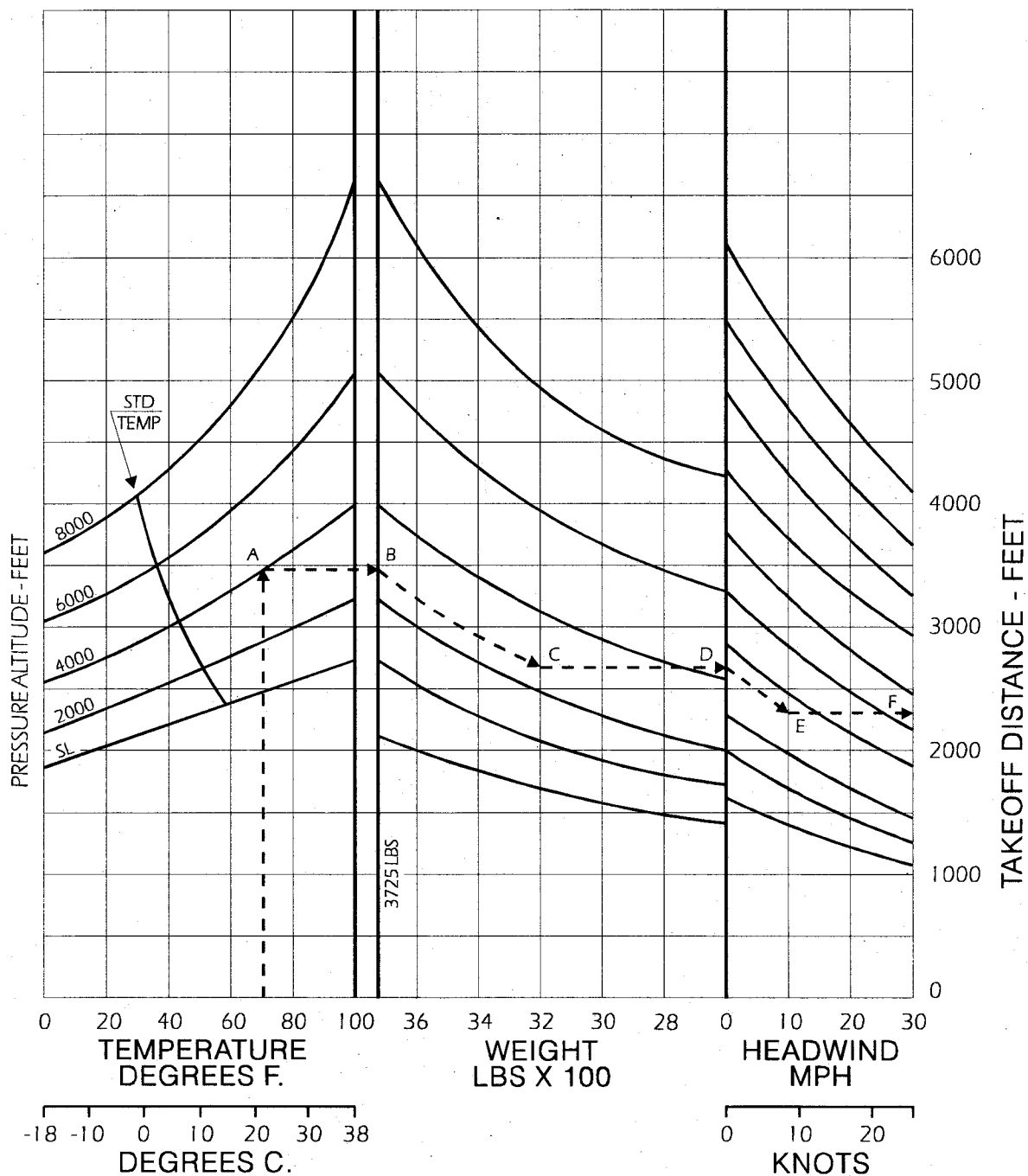

FIGURE 5-07

# ACCELERATE - STOP DISTANCE

WING FLAPS RETRACTED  
 FULL THROTTLE AND MAX RPM  
 BOTH THROTTLES CLOSED AT DECISION SPEED

RUNWAY SURFACE: PAVED, LEVEL, DRY  
 ACCELERATE TO 90 MPH IAS  
 MAXIMUM BRAKING EFFORT

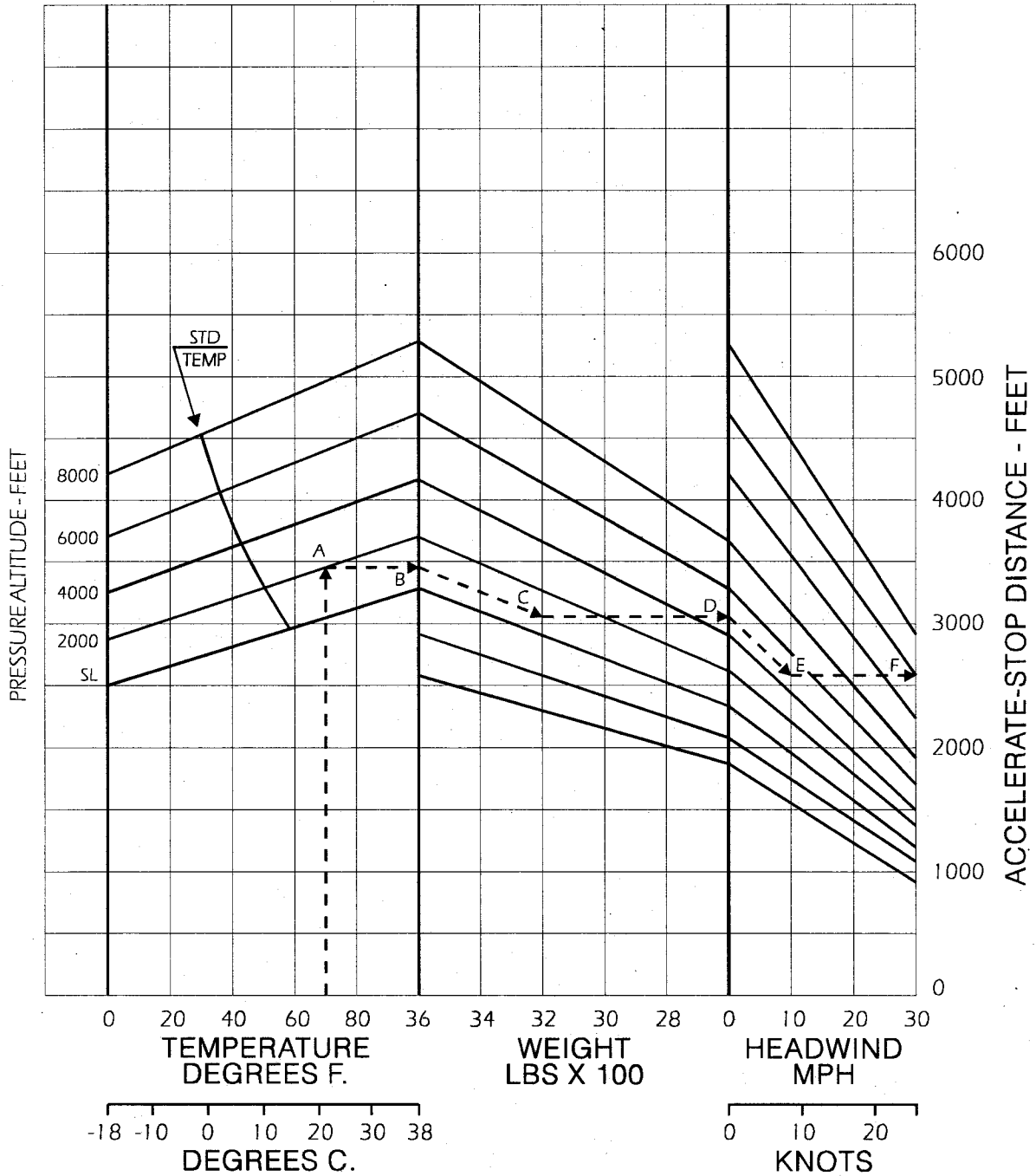

FIGURE 5-08



# ACCELERATE - STOP DISTANCE

(Normally Aspirated Model Equipped With Tip Tanks -- 3725 Lbs Gross Weight)

WING FLAPS RETRACTED  
 FULL THROTTLE AND MAX RPM  
 BOTH THROTTLES CLOSED AT DECISION SPEED

RUNWAY SURFACE: PAVED, LEVEL, DRY  
 ACCELERATE TO 90 MPH IAS  
 MAXIMUM BRAKING EFFORT

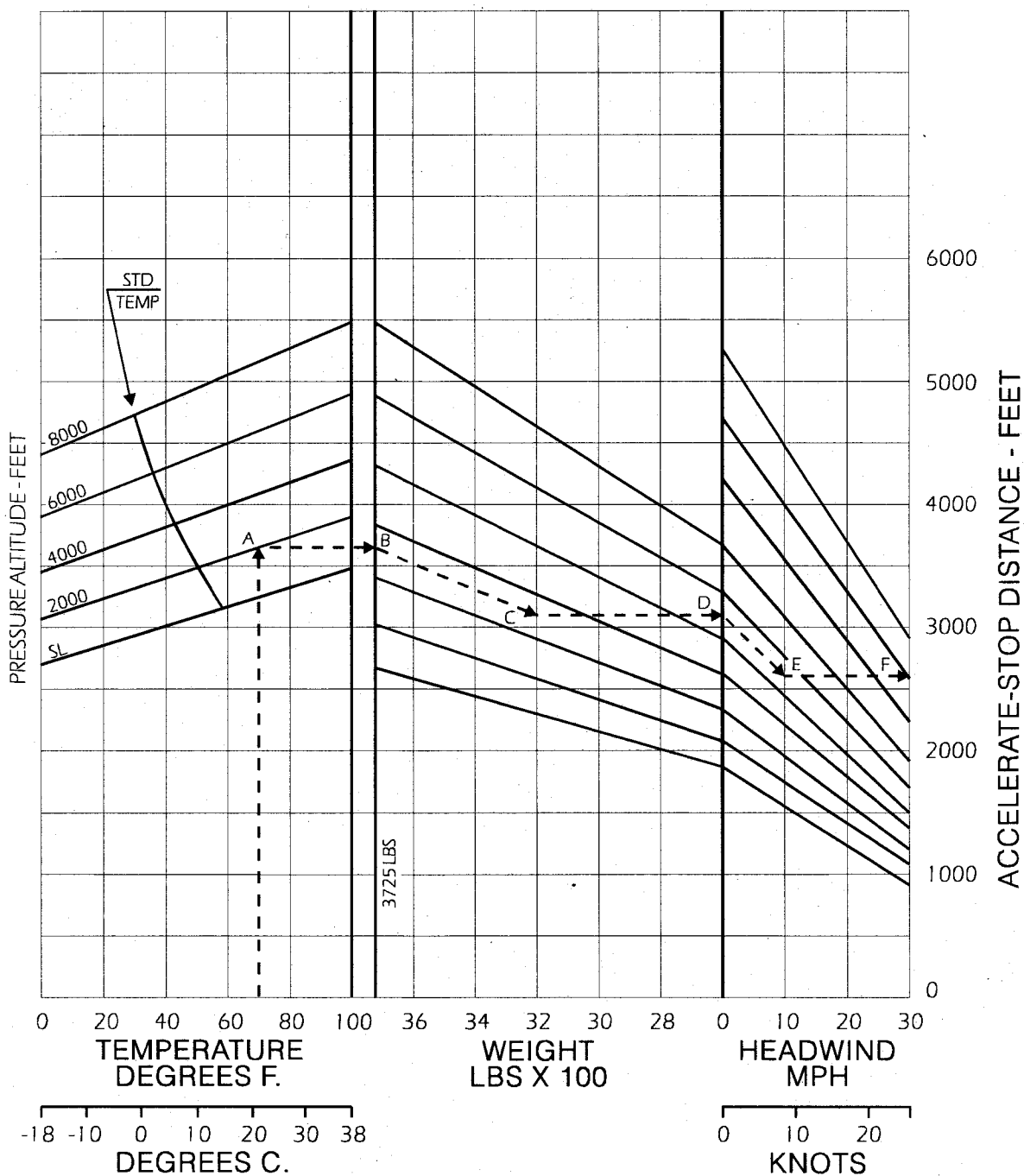

FIGURE 5-08

# MULTI-ENGINE RATE OF CLIMB VS DENSITY ALTITUDE AND WEIGHT

COWL FLAPS OPEN  
FULL THROTTLE AND MAX RPM  
LANDING GEAR AS NOTED

MIXTURE: ADJUST FOR SMOOTH OPERATION  
OPTIMUM AIRSPEED  
WING FLAPS AS NOTED

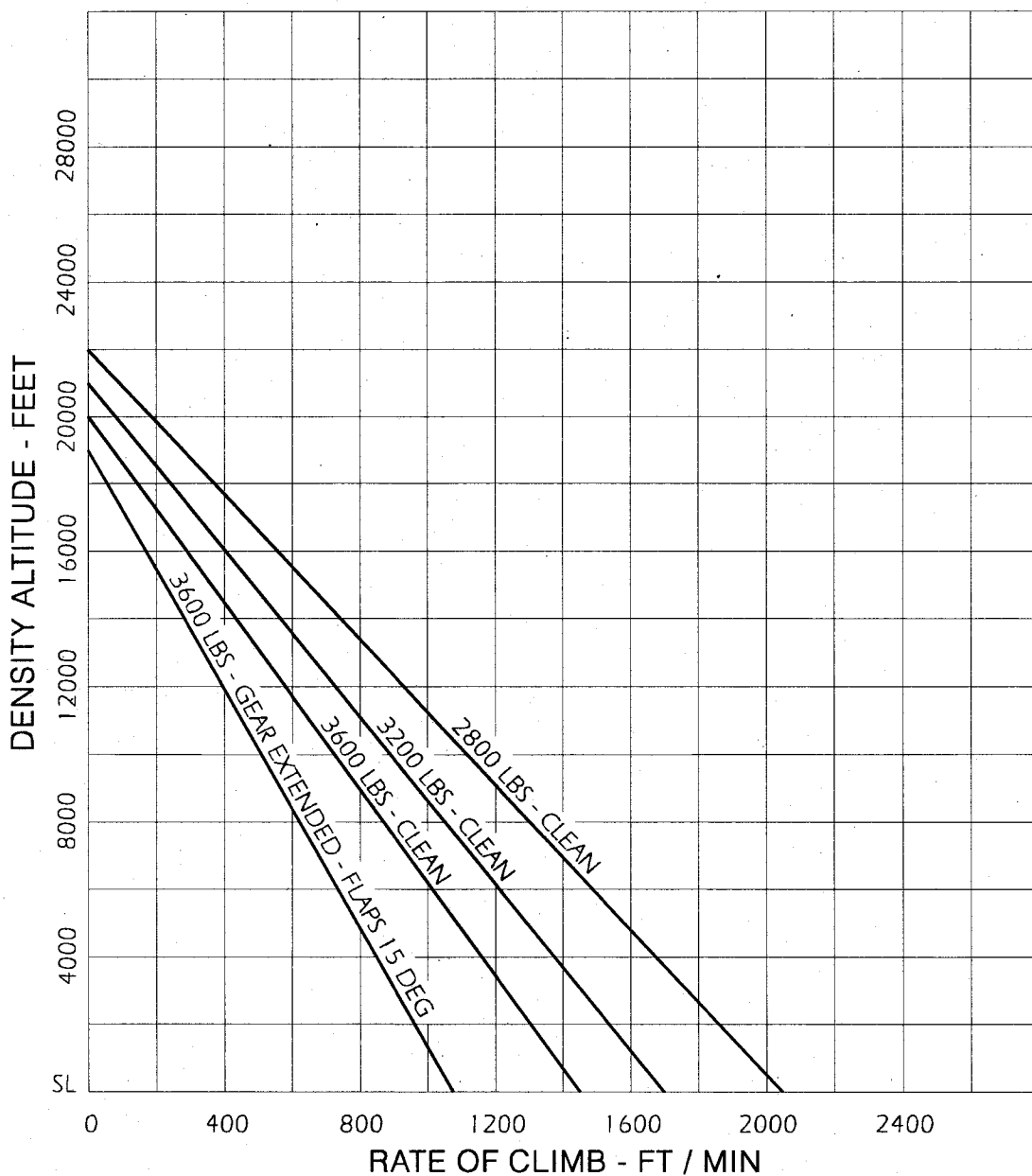

FIGURE 5-09

# MULTI-ENGINE RATE OF CLIMB

VS

## DENSITY ALTITUDE AND WEIGHT

(Normally Aspirated Model Equipped With Tip Tanks -- 3725 Lbs Gross Weight)

COWL FLAPS OPEN  
FULL THROTTLE AND MAX RPM  
LANDING GEAR RETRACTED

MIXTURE: ADJUST FOR SMOOTH OPERATION  
OPTIMUM AIRSPEED  
WING FLAPS RETRACTED

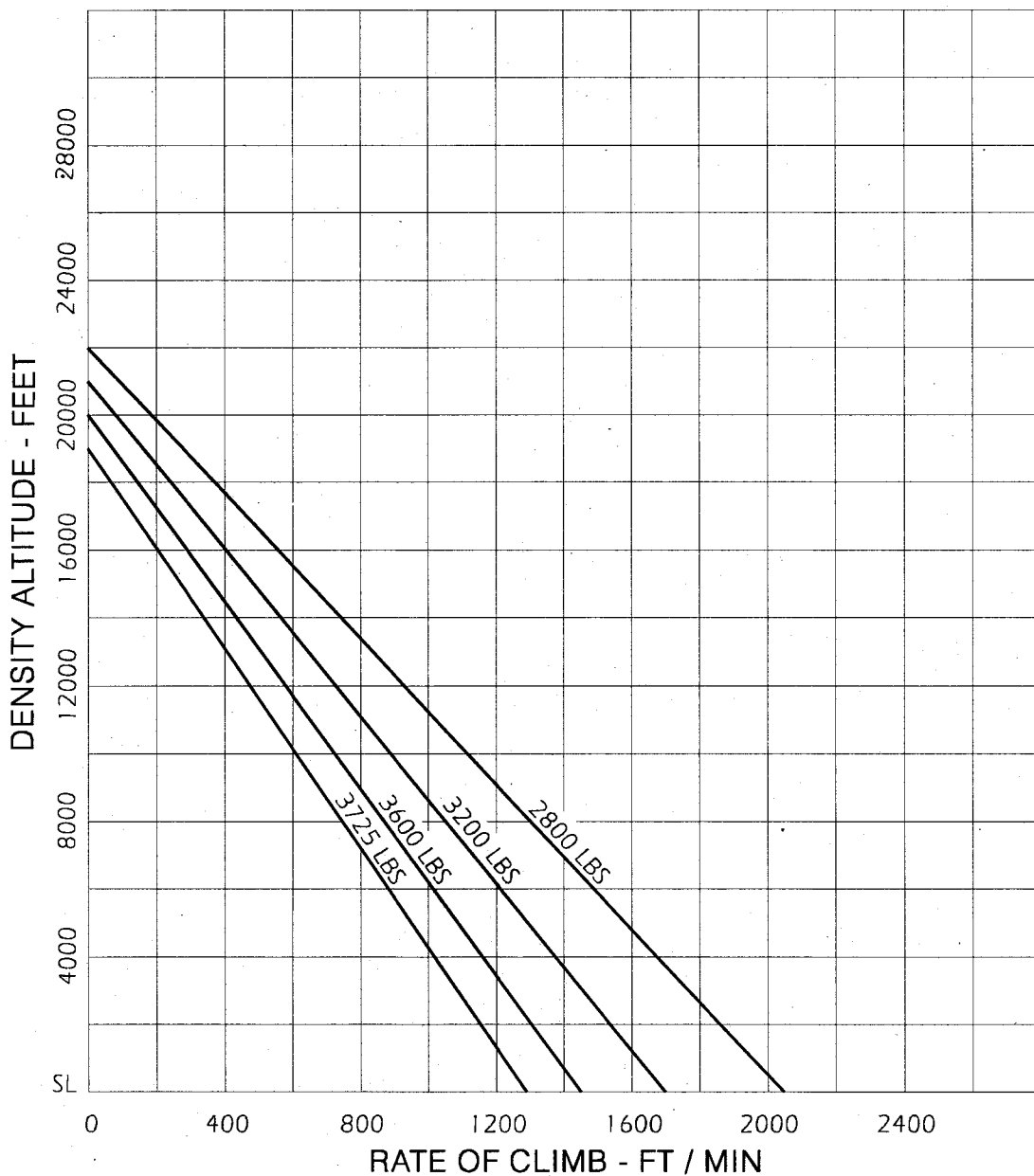

FIGURE 5-09

# SINGLE-ENGINE RATE OF CLIMB VS DENSITY ALTITUDE AND WEIGHT

LEFT ENGINE: INOPERATIVE  
LEFT PROPELLER: FEATHERED  
RIGHT ENGINE: FULL THROTTLE  
RIGHT PROPELLER: MAX RPM

MIXTURE: ADJUST FOR SMOOTH OPERATION  
GEAR AND WING FLAPS RETRACTED  
OPTIMUM AIRSPEED  
COWL FLAPS OPEN

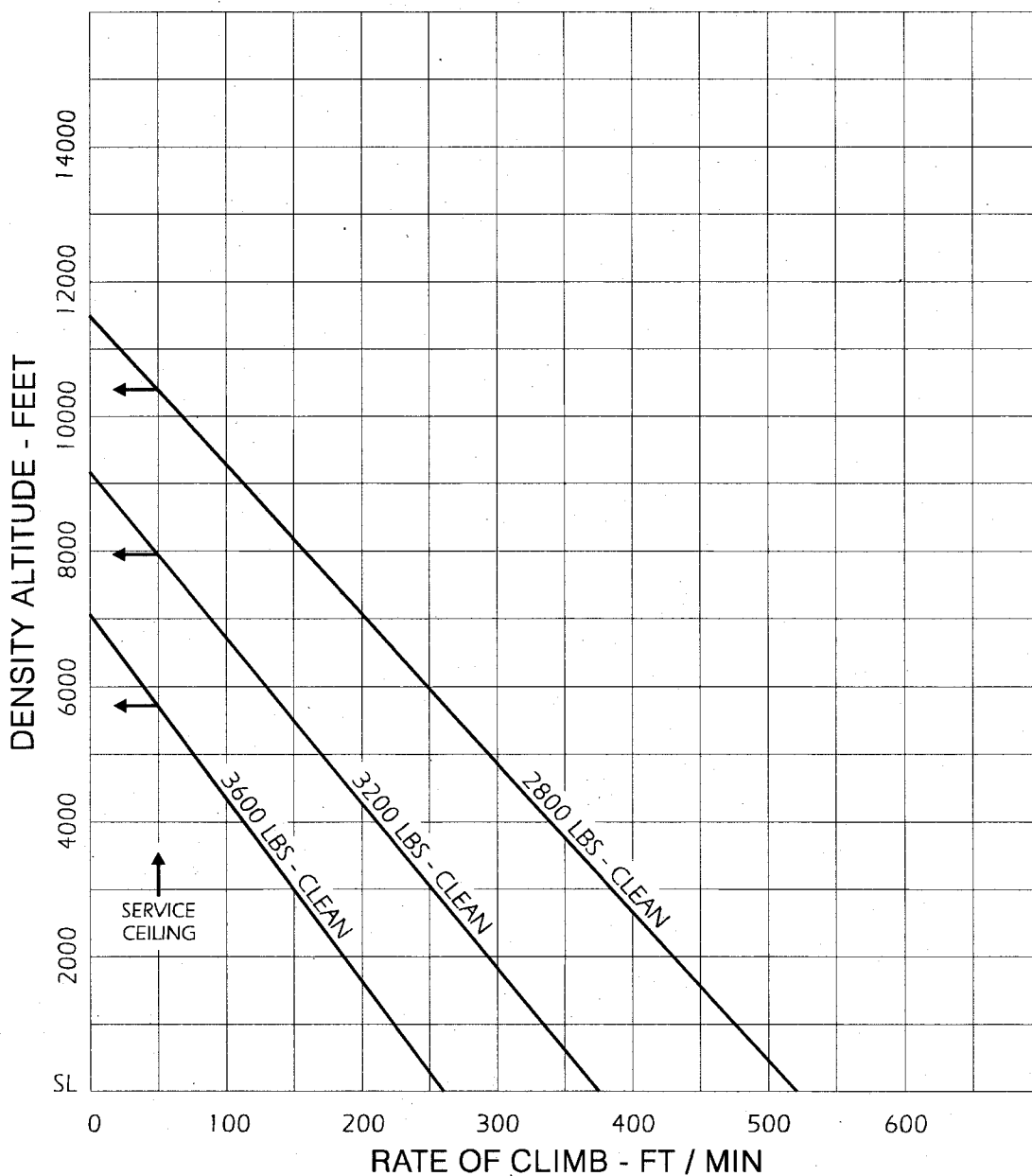

FIGURE 5-10

# SINGLE-ENGINE RATE OF CLIMB

VS

## DENSITY ALTITUDE AND WEIGHT

(Normally Aspirated Model Equipped With Tip Tanks -- 3725 Lbs Gross Weight)

LEFT ENGINE: INOPERATIVE  
LEFT PROPELLER: FEATHERED  
RIGHT ENGINE: FULL THROTTLE  
RIGHT PROPELLER: MAX RPM

MIXTURE: ADJUST FOR SMOOTH OPERATION  
GEAR AND WING FLAPS RETRACTED  
OPTIMUM AIRSPEED  
COWL FLAPS OPEN

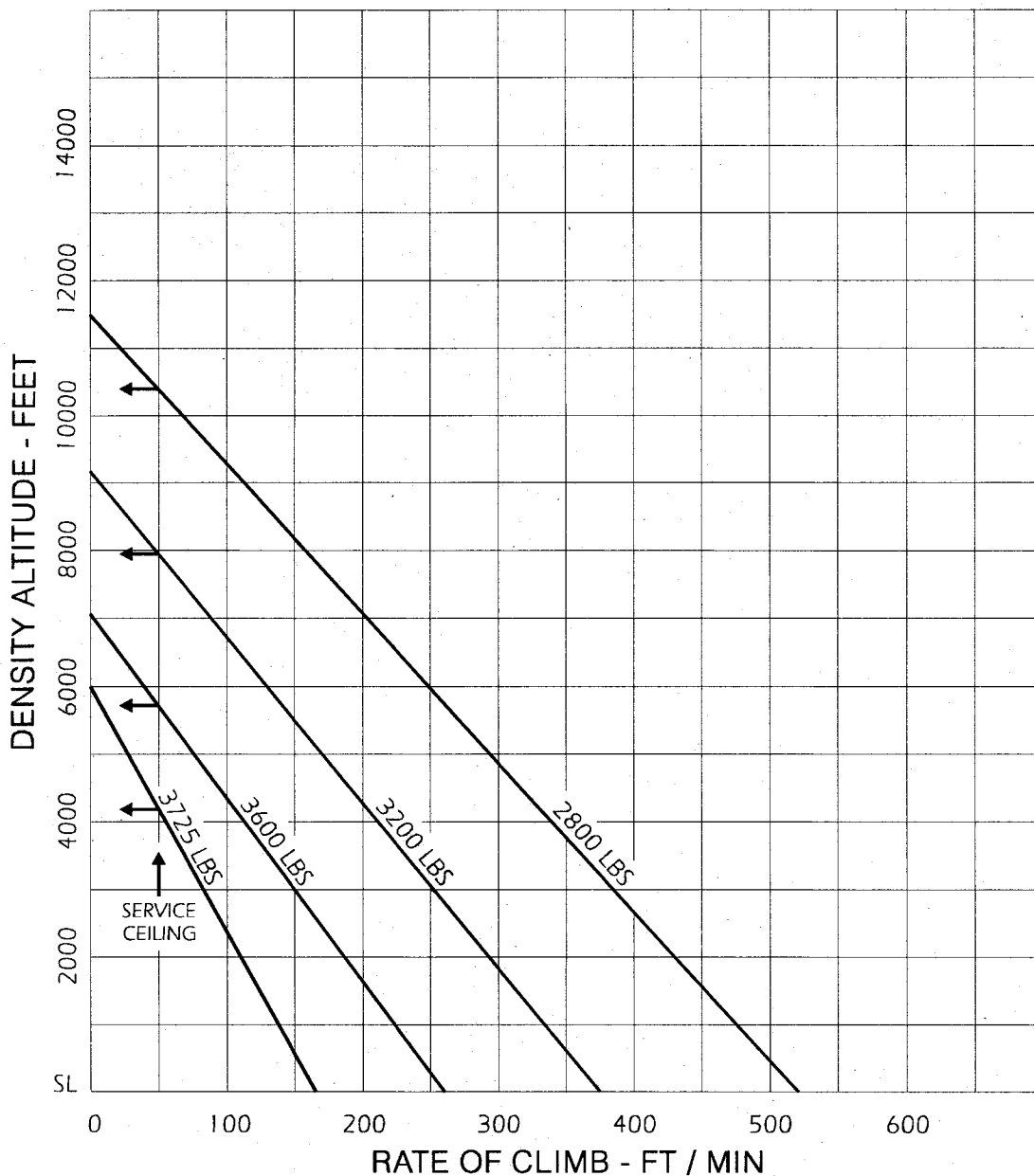

FIGURE 5-10

# $V_X$ AND $V_Y$ VS DENSITY ALTITUDE

LANDING GEAR RETRACTED  
FULL THROTTLE AND MAX RPM  
WING FLAPS RETRACTED

MIXTURE: ADJUST FOR SMOOTH OPERATION  
GROSS WEIGHT: 3600 POUNDS  
COWL FLAPS OPEN

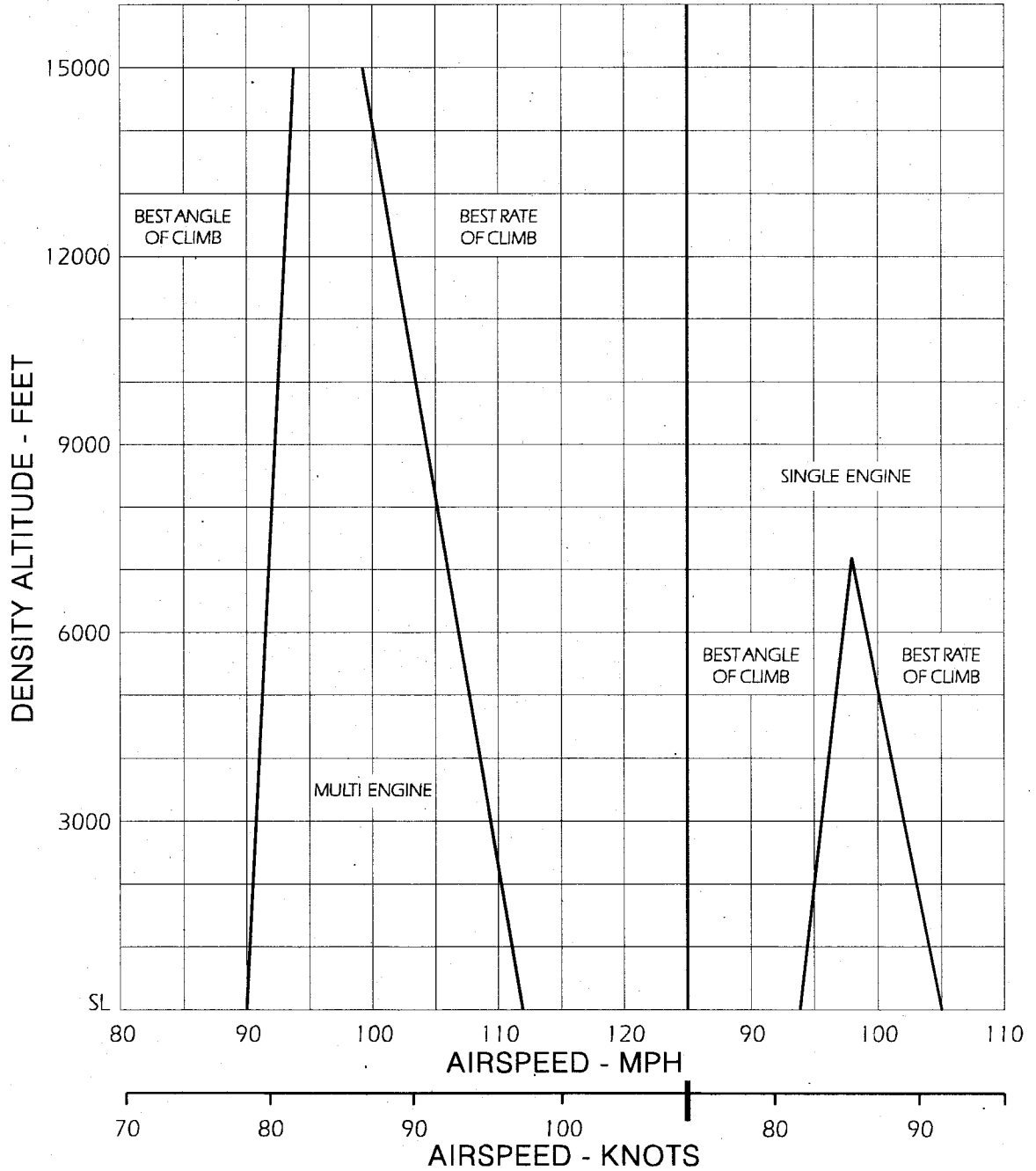

FIGURE 5-11

# TRUE AIRSPEED VS DENSITY ALTITUDE

GROSS WEIGHT: 3600 POUNDS  
GEAR AND WING FLAPS RETRACTED

MIXTURE: BEST POWER CRUISE  
COWL FLAPS CLOSED

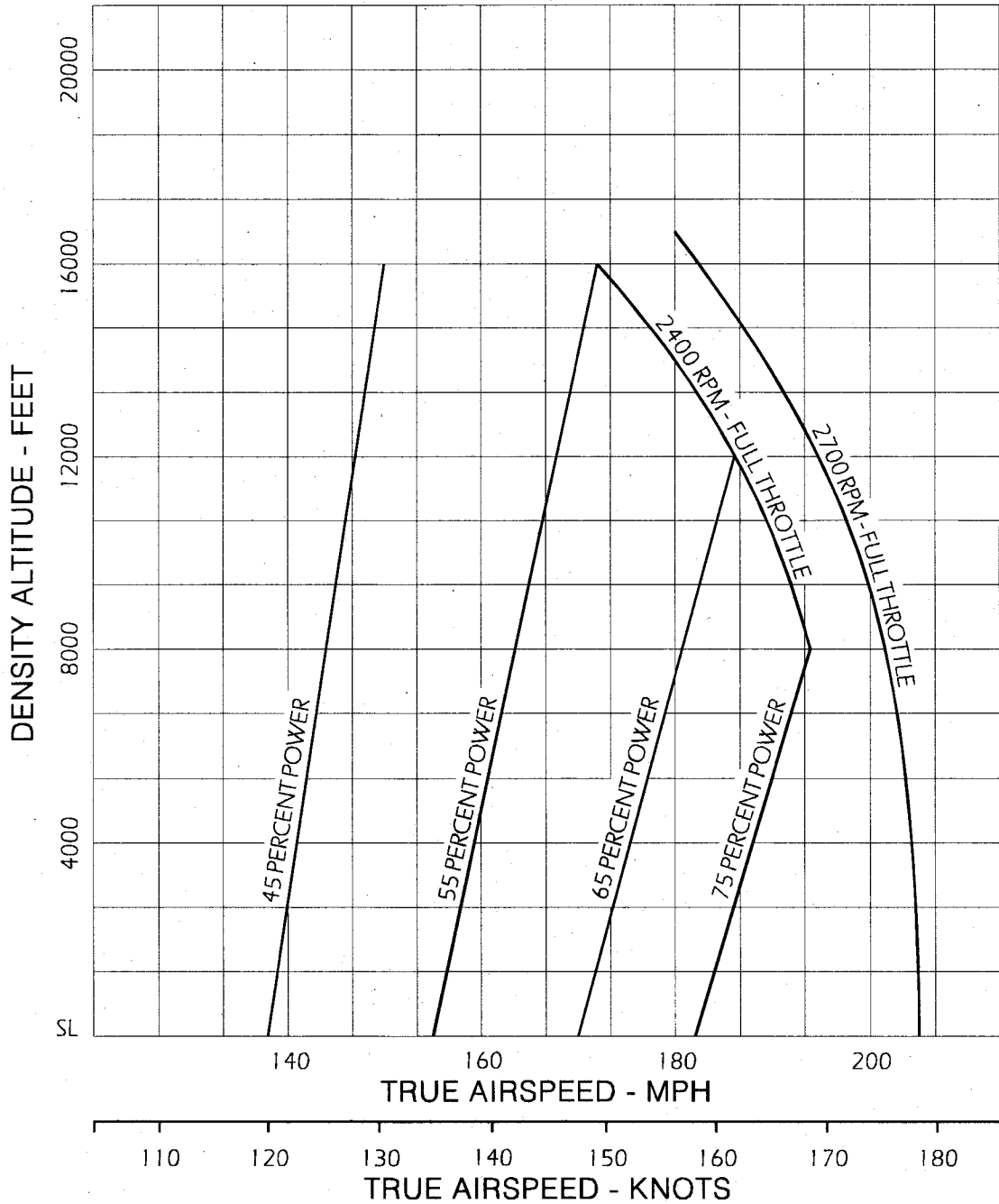

FIGURE 5-12

# RANGE PROFILE

INITIAL FUEL LOAD: AS SHOWN  
 WEIGHT: 3600 POUNDS AT START

GEAR AND FLAPS RETRACTED  
 MIXTURE: BEST ECONOMY CRUISE

**\*\* WARNING \*\***

FIGURES SHOWN IN THIS CHART GIVE NO CONSIDERATION TO WIND OR NAVIGATIONAL ERRORS.  
 RANGE INCLUDES AN ALLOWANCE FOR FUEL USED IN START, TAXI, TAKEOFF, CLIMB AND  
 DESCENT PLUS 45 MINUTES RESERVE FUEL AT MAXIMUM RANGE POWER ( $V_{IMR}$ ).

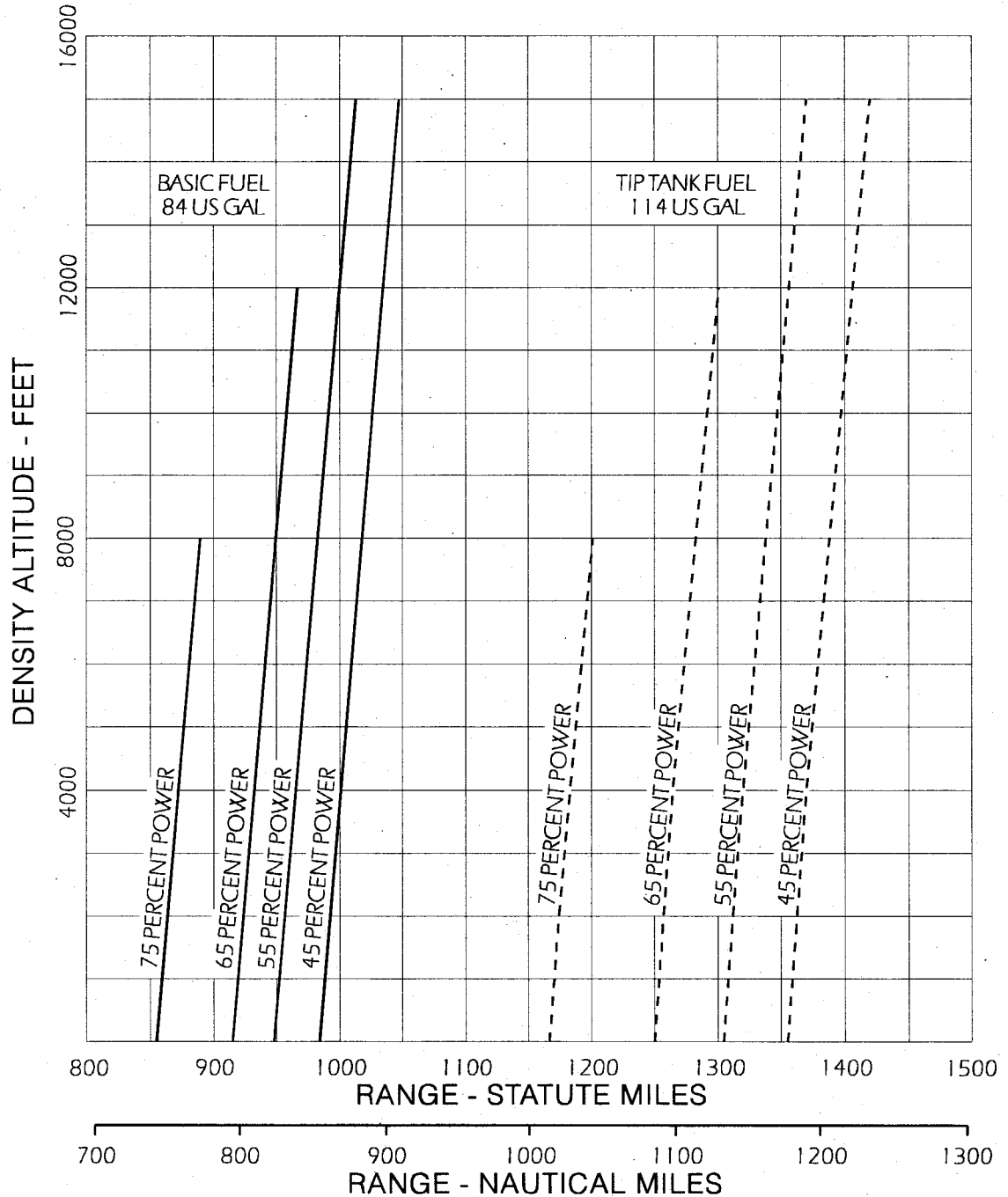

**FIGURE 5-13**



# ENDURANCE PROFILE

INITIAL FUEL LOAD: AS SHOWN  
WEIGHT: 3600 POUNDS AT START

GEAR AND FLAPS RETRACTED  
MIXTURE: BEST ECONOMY CRUISE

**\*\* WARNING \*\***

FIGURES SHOWN IN THIS CHART GIVE NO CONSIDERATION TO WIND OR NAVIGATIONAL ERRORS.  
ENDURANCE INCLUDES AN ALLOWANCE FOR FUEL USED IN START, TAXI, TAKEOFF, CLIMB, AND  
DESCENT PLUS 45 MINUTES RESERVE FUEL AT MAXIMUM ENDURANCE POWER ( $V_{IMD}$ ).

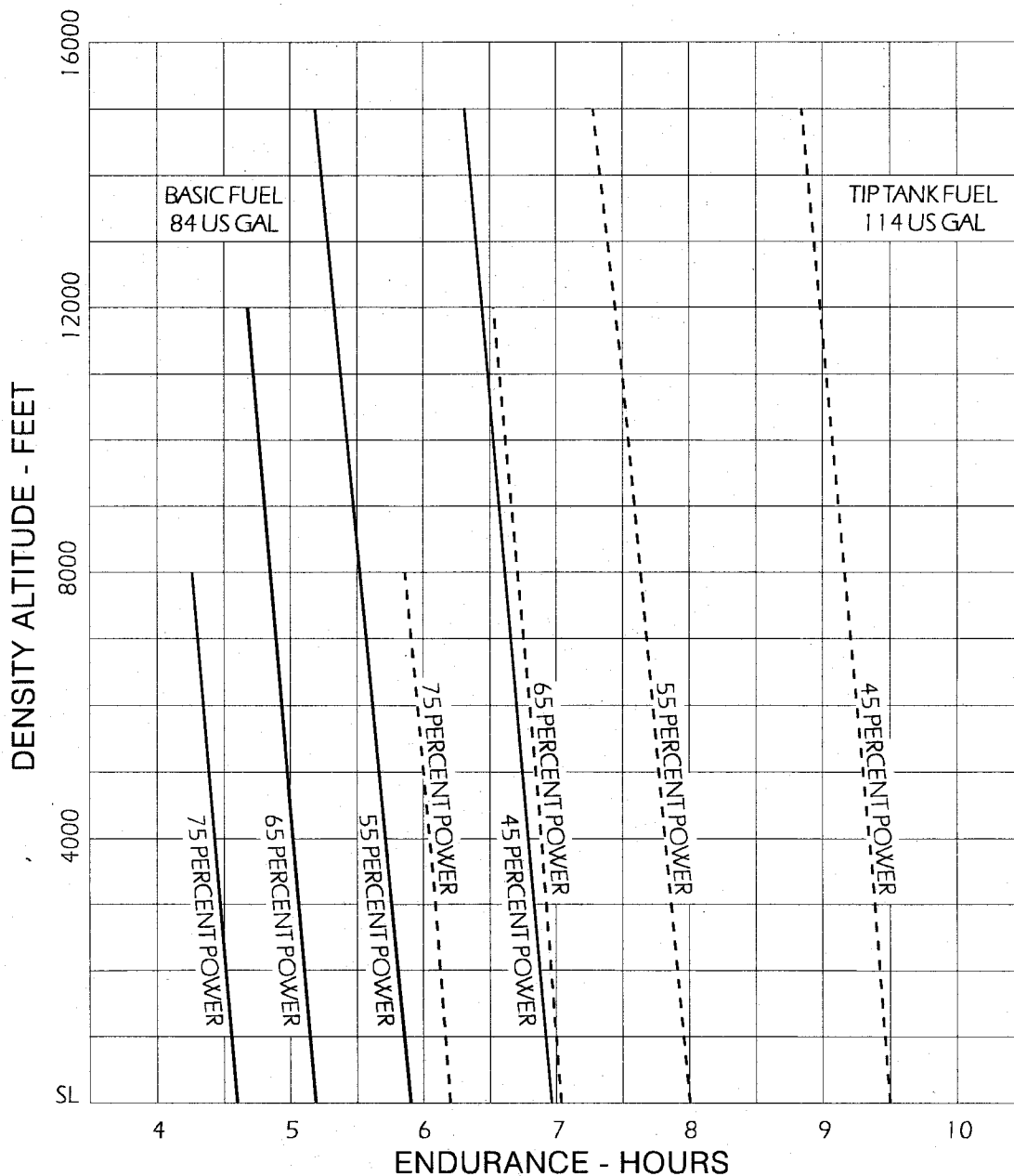

**FIGURE 5-14**

# LANDING GROUND ROLL DISTANCE

WING FLAPS: 27 DEGREES  
 RUNWAY SURFACE: PAVED, LEVEL, DRY  
 THROTTLES CLOSED

MAXIMUM BRAKING EFFORT  
 APPROACH SPEED = 90 MPH IAS  
 TOUCHDOWN SPEED = 70 MPH IAS

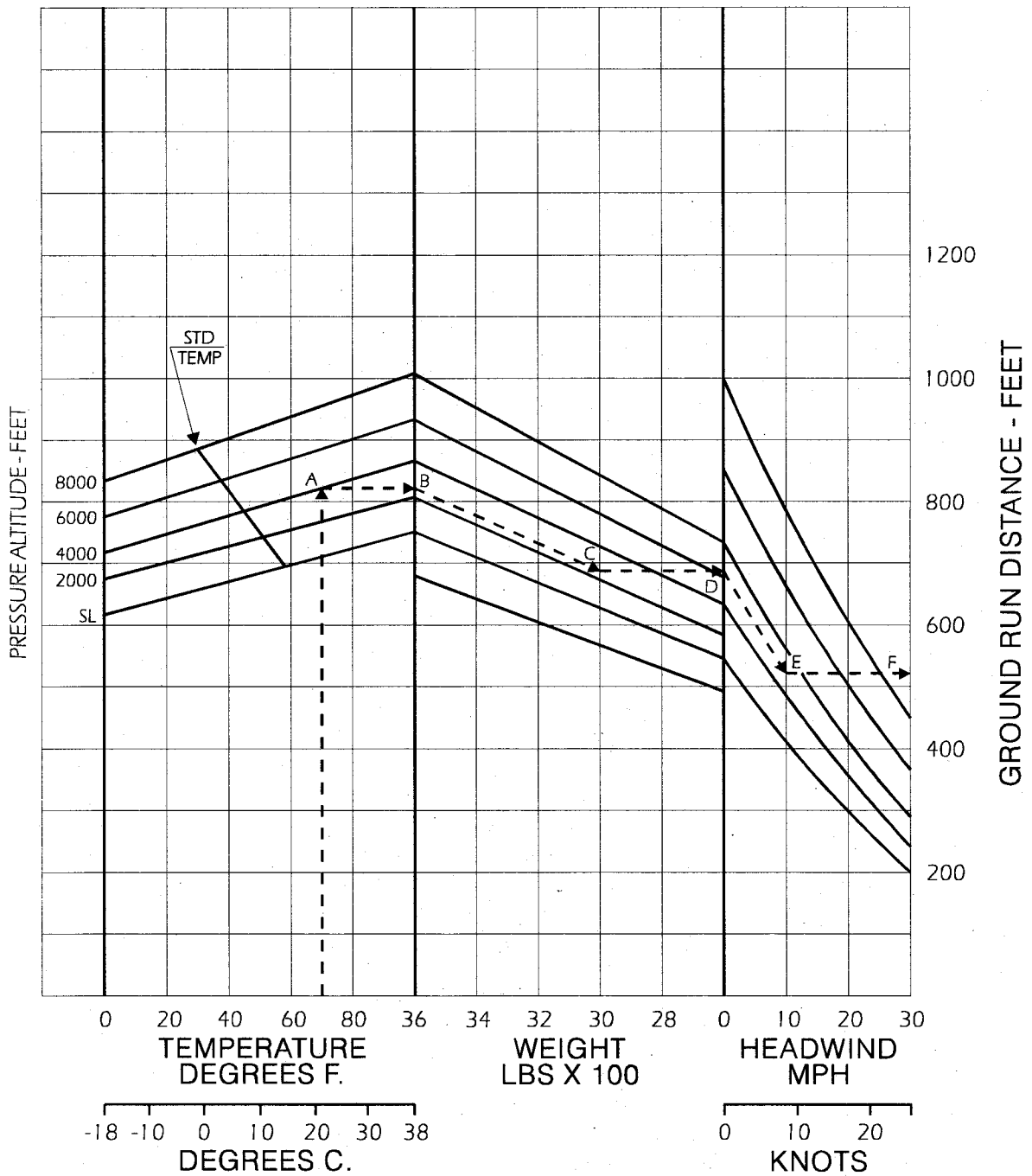

FIGURE 5-15

# LANDING GROUND ROLL DISTANCE

(Normally Aspirated Model Equipped With Tip Tanks -- 3725 Lbs Gross Weight)

WING FLAPS: 27 DEGREES  
 RUNWAY SURFACE: PAVED, LEVEL, DRY  
 THROTTLES CLOSED

MAXIMUM BRAKING EFFORT  
 APPROACH SPEED = 90 MPH IAS  
 TOUCHDOWN SPEED = 70 MPH IAS

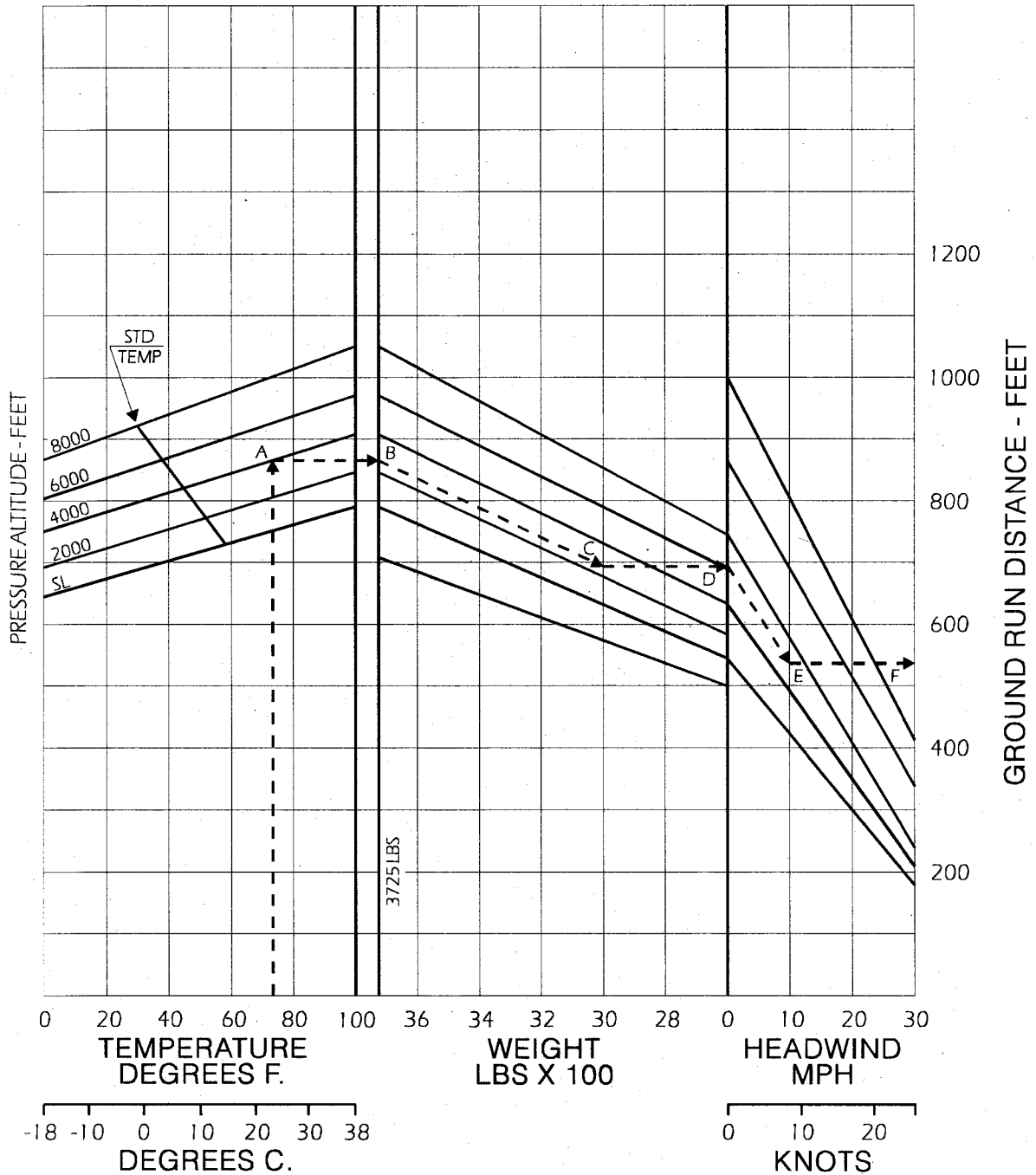

FIGURE 5-15

# LANDING DISTANCE OVER A 50 FT OBSTACLE

WING FLAPS: 27 DEGREES  
 RUNWAY SURFACE: PAVED, LEVEL, DRY

MAXIMUM BRAKING EFFORT  
 APPROACH SPEED = 90 MPH IAS

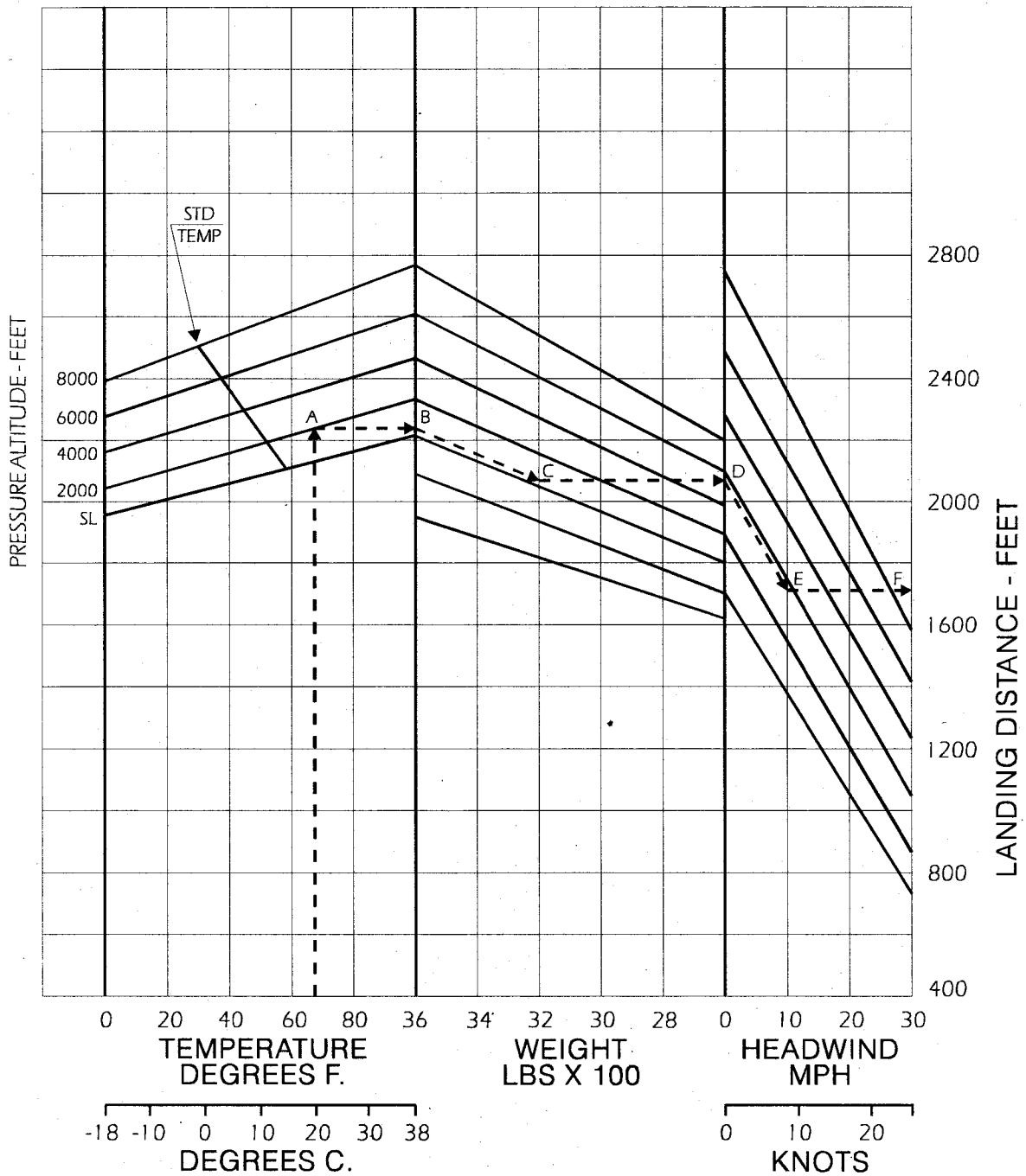

FIGURE 5-16

# LANDING DISTANCE OVER A 50 FT OBSTACLE

(Normally Aspirated Model Equipped With Tip Tanks -- 3725 Lbs Gross Weight)

WING FLAPS: 27 DEGREES  
 RUNWAY SURFACE: PAVED, LEVEL, DRY  
 THROTTLES CLOSED

MAXIMUM BRAKING EFFORT  
 APPROACH SPEED = 90 MPH IAS  
 TOUCHDOWN SPEED = 70 MPH IAS

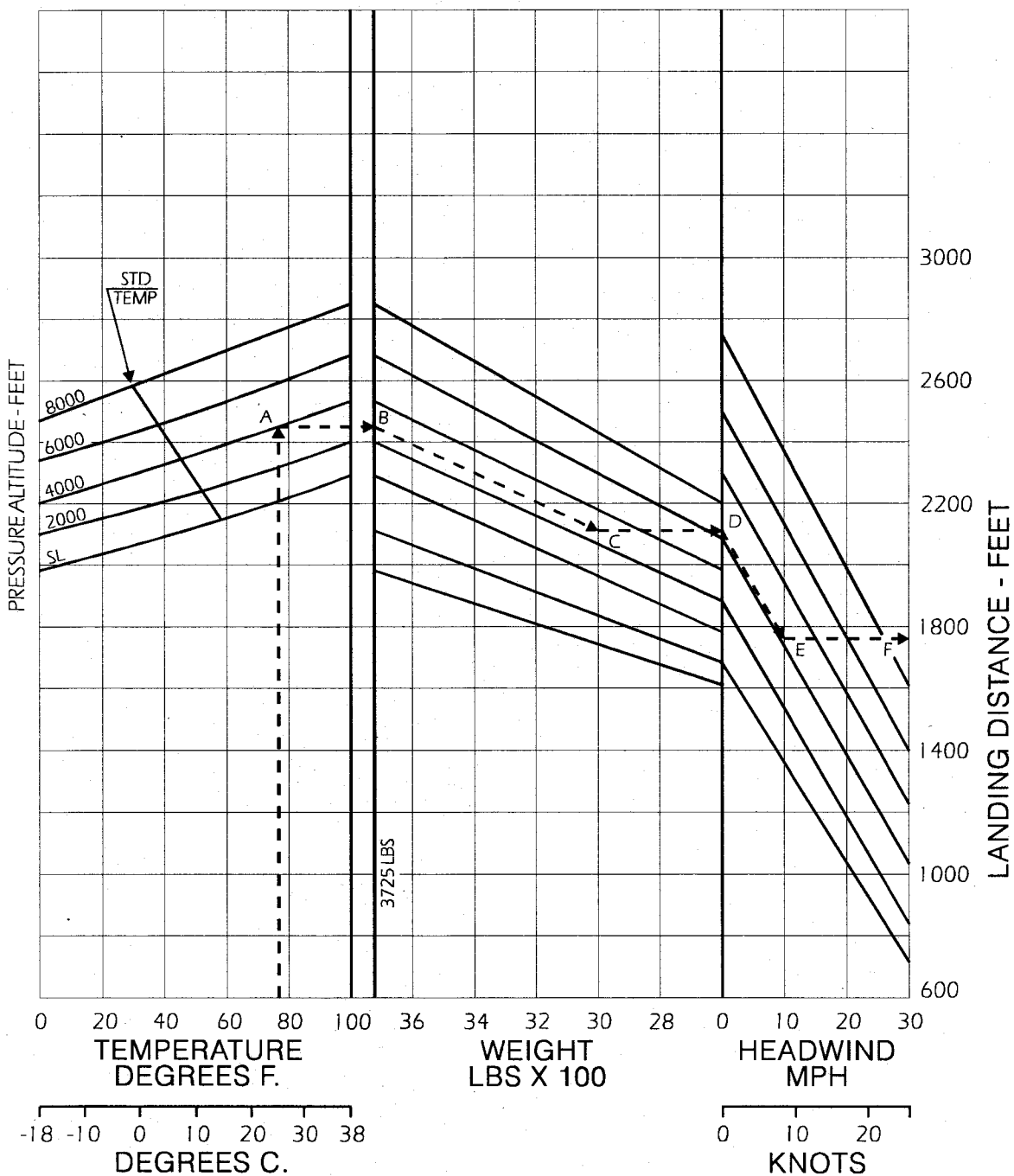

FIGURE 5-16

**POWER SETTING TABLE**

LYCOMING MODEL IO-320-B, 160 HP NORMALLY ASPIRATED ENGINE

PRESSURE ALTITUDE	STD AIR TEMP	F. C.	88 HP - 55% RATED			104 HP - 65% RATED			120 HP - 75% RATED					
			1. APPROX 13.4 GPH	2. APPROX 16.0 GPH	RPM AND MAN PRESS	1. APPROX 15.2 GPH	2. APPROX 17.7 GPH	RPM AND MAN PRESS	1. APPROX 17.2 GPH	2. APPROX 20.0 GPH	RPM AND MAN PRESS			
			2100	2200	2300	2400	2100	2200	2300	2400	2100	2200	2300	2400
SEA LEV	59	15	22.4	21.7	21.0	20.4	25.0	24.2	23.3	22.7	26.5	25.6	24.9	
1,000	55	13	22.1	21.5	20.7	20.2	24.7	23.9	23.0	22.4	26.2	25.3	24.6	
2,000	52	11	21.8	21.2	20.5	19.9	24.4	23.6	22.8	22.2	25.9	25.0	24.3	
3,000	48	09	21.6	20.9	20.2	19.7	24.1	23.3	22.5	21.9	25.6	24.7	24.0	
4,000	45	07	21.3	20.6	19.9	19.4	23.8	23.0	22.2	21.6	25.3	24.3	23.7	
5,000	41	05	21.0	20.4	19.7	19.2	23.5	22.7	21.9	21.3	24.0	24.0	23.4	
6,000	38	03	20.8	20.1	19.4	18.9	23.2	22.4	21.6	21.1	24.0	24.0	23.1	
7,000	34	01	20.5	19.8	19.1	18.7	22.1	21.3	20.8	20.8				
8,000	31	-01	20.2	19.5	18.9	18.4	21.8	21.0	20.5	20.5				
9,000	27	-03	19.9	19.2	18.6	18.2	20.7	20.3	20.3	20.3				
10,000	23	-05	19.7	19.0	18.3	17.9								
11,000	19	-07	19.4	18.7	18.1	17.7								
12,000	16	-09	18.4	17.8	17.4	17.4								
13,000	12	-11	17.5	17.2	17.2	17.2								
14,000	09	-13	16.9	16.9	16.9	16.9								
15,000	05	-15												

- 1.) BEST ECONOMY CRUISE - PEAK EGT
- 2.) BEST POWER CRUISE - 100 DEGREES FAHRENHEIT RICH OF PEAK EGT

**\*\* NOTE \*\***

TO MAINTAIN CONSTANT POWER, CORRECT MANIFOLD PRESSURE APPROXIMATELY 0.17 INCH Hg. FOR EACH 10 DEGREE FAHRENHEIT VARIATION IN INDUCTION AIR TEMPERATURE FROM STANDARD ALTITUDE TEMPERATURE. ADD MANIFOLD PRESSURE FOR TEMPERATURES ABOVE STANDARD; SUBTRACT FOR TEMPERATURES BELOW STANDARD.

**FIGURE 5-17**

## SECTION 6 - WEIGHT AND BALANCE

PA-30 \* 3600 LBS GROSS WEIGHT

### Table of Contents

Introduction .....	6-2
Airplane Weighing Procedure .....	6-3
Preparation .....	6-3
Leveling .....	6-3
Weighing - Airplane Basic Empty Weight .....	6-3
Calculation - Basic Empty Weight Center of Gravity .....	6-3
Weight and Balance Data Record .....	6-4
Weight and Balance Data Form .....	6-4
Center of Gravity Data .....	6-5
Stations .....	6-5
Weight and Balance Determination for Flight .....	6-6
Use of the Weight and Balance Plotter .....	6-6
Manual Method of Determining Weight and Balance .....	6-6
Loading Problem Example .....	6-7
Sample Loading Problem .....	6-7
Equipment List .....	6-8
Engines .....	6-8
Propellers and Accessories .....	6-8
Engine Accessories .....	6-8
Landing Gear .....	6-9
Electrical Equipment .....	6-9
Autopilots .....	6-9
Miscellaneous Equipment .....	6-10
Other Equipment .....	6-11
Avionics .....	6-11
Figure 6-01 Weight and Balance .....	6-12

## WEIGHT AND BALANCE

PA-30 \* 3600 LBS GROSS WEIGHT

### INTRODUCTION

This section describes the procedure for calculating the loaded weight and center of gravity of the Twin Comanche for various flight operations. In addition, procedures are provided for recalculating the basic empty weight and center of gravity when removal and/or addition of equipment results in changes to these values.

In order to achieve the performance and flying characteristics which are designed into the aircraft, it must be flown with the weight and center of gravity position within the approved operating envelope. Although the airplane offers flexibility of loading, it cannot be flown with the maximum number of adult passengers, full fuel tanks and maximum baggage. With this flexibility comes responsibility. The pilot must insure that the airplane is within the loading envelope before takeoff.

Misloading carries consequences for any aircraft. An overloaded airplane will not perform as well, or as safely, as a properly loaded one. The heavier the airplane is loaded within the approved limit, the less climb performance it will have, and the higher the stall speed will be.

Center of gravity is also a determining factor in any airplane's flight characteristics. If the C.G. is too far forward, it may be difficult to rotate for takeoff or flare for landing. Loading the airplane so that the center of gravity is toward, but within, the aft C.G. limit will result in less drag, a faster airplane and increased range. However, if the C.G. is too far aft, the airplane may rotate prematurely on takeoff or tend to pitch-up during climb. Longitudinal stability will be reduced, which can lead to inadvertent stalls and even spins. Spin recovery becomes more difficult, and even impossible, as the center of gravity moves aft of the approved C.G. limit.

A properly loaded aircraft, by comparison, will perform as intended by its design. Before the airplane is delivered, it is weighed, and a basic empty weight and C.G. location are computed. Using this information, the pilot can easily determine the gross weight and C.G. location for the loaded airplane. This is accomplished by computing the total weight and moment following the example supplied in this section, and then determining whether they are within the approved envelope.

The basic empty weight and center of gravity location are recorded in the actual weight and balance record supplied with the airplane when new. Whenever equipment is installed and/or removed, or major modifications are made to the aircraft, the mechanic responsible for the work is required to compute the new basic empty weight and C.G. location, and record these in the aircraft logbook. The owner of the aircraft should make sure that this is done.



## AIRPLANE WEIGHING PROCEDURE

At the time of licensing, Piper Aircraft Corporation provided each airplane with the basic empty weight and C.G. location. The removal and/or addition of equipment or aircraft modifications can affect the basic empty weight and center of gravity. The following procedure is used to re-determine the basic empty weight and C.G. location.

### 1.) Preparation:

- A.) Be certain that all items checked in the equipment list are installed in the proper location in the airplane.
- B.) Remove excessive dirt, grease, moisture and foreign items such as rags and tools from the airplane before weighing.
- C.) De-fuel the airplane, then add the unusable fuel (6.0 gallons total, 3.0 gallons to each main tank). Fill engines with oil.
- D.) Place pilot and copilot seats in a normal seating position (approximately the eighth notch aft of full forward position). Put flaps in the fully retracted position and all control surfaces in the neutral position. Secure the tow bar in its proper location and close all doors.

### 2.) Leveling:

- A.) With the airplane on scales, inflate main gear oleo pistons to the fully extended position.
- B.) Level the airplane both laterally and longitudinally by deflating the tires to center the bubble on the level. On serial numbers 30-1 through 30-901 the longitudinal level point is across the two machine screws above the baggage compartment door, and the lateral level point is located at the station 136.5 bulkhead in the baggage compartment. On serial numbers 30-902 and up the longitudinal level point is across the two machine screws on either side of the right rear window, and the lateral level point is the hat section channel of the forward cabin bulkhead.

### 3.) Weighing - Airplane Basic Empty Weight:

- A.) Weigh the airplane inside a closed building to prevent errors in scale readings due to wind.
- B.) With the airplane level and the brakes released, record the weight shown on each scale. Deduct the tare, if any, from each reading to determine the net weight. Basic empty weight is the sum of all three readings.

### 4.) Calculation - Basic Empty Weight Center of Gravity:

- A.) The basic empty weight center of gravity can be determined by the following formula:  
(See Figure 6-01)

$$\text{C.G. Arm} = \frac{N(A)+(R+L)(B)}{T} \text{ Inches}$$

Where  $T=N+R+L$

$A=21.7$   $B=108.7$

### WEIGHT AND BALANCE DATA AND RECORD

The basic empty weight of the airplane as delivered from the factory should be the first entry in the data record below. This form is provided to present the current status of the airplane and a complete history of previous modifications as shown in the aircraft logbook. Any subsequent modification which affects weight or moment should be entered in the Weight and Balance Record.

The information contained herein applies only to the specific Piper PA-30 airplane designated by serial number and registration number in Section 1 (General) of this Manual.

### WEIGHT AND BALANCE DATA FORM

Date	Description of Modification	Wt Change		Running Empty Wt			
		Add +	Sub -	Wt Lbs	Moment	Arm in	Useful Load
	Basic Empty Weight <u>As Delivered</u>	<u>xxxx</u>	<u>xxxx</u>	_____	_____	_____	_____
_____	_____	_____	_____	_____	_____	_____	_____
_____	_____	_____	_____	_____	_____	_____	_____
_____	_____	_____	_____	_____	_____	_____	_____
_____	_____	_____	_____	_____	_____	_____	_____
_____	_____	_____	_____	_____	_____	_____	_____
_____	_____	_____	_____	_____	_____	_____	_____
_____	_____	_____	_____	_____	_____	_____	_____
_____	_____	_____	_____	_____	_____	_____	_____
_____	_____	_____	_____	_____	_____	_____	_____
_____	_____	_____	_____	_____	_____	_____	_____
_____	_____	_____	_____	_____	_____	_____	_____
_____	_____	_____	_____	_____	_____	_____	_____
_____	_____	_____	_____	_____	_____	_____	_____
_____	_____	_____	_____	_____	_____	_____	_____

Maximum Takeoff Weight .....	3,600 lb
Maximum Landing Weight .....	3,600 lb
Maximum Baggage (SN 30-1 Through 30-901) .....	200 lb
Maximum Baggage (SN 30-902 Through 30-2000) .....	250 lb
Standard Empty Weight .....	2,207 lb
Maximum Standard Useful Load .....	1,393 lb
Basic Empty Weight .....	_____ lb
Maximum Useful Load (As Equipped) .....	_____ lb
Maximum Useful Load - With Basic Fuel and Oil (60 US gal) .....	_____ lb
Maximum Useful Load - With Internal Reserve Fuel (30 US gal) .....	_____ lb
Gross Weight (With Tip Tanks Installed) .....	3,725 lb
Maximum Useful Load - With Tip Tank Reserve Fuel (30 US gal) .....	_____ lb

**CENTER OF GRAVITY DATA**

Basic Empty Measurement:

Center of Gravity (Aft of Datum) ..... \_\_\_\_\_ in  
Moment ..... \_\_\_\_\_ in lb  
Moment Increase With Landing Gear Retracted ..... 770.0 in lb

Normal Category.

Weight Pounds	Arm Forward Limit Inches Aft of Datum	Arm Rearward Limit Inches Aft of Datum
3,725 *	87.6	91.4
3,600	86.5	92.0
3,200	83.0	92.0
2,450 or Less	81.0	92.0

**\*\* NOTE \*\***

\* Any weight in excess of 3,600 pounds must consist of symmetrically loaded fuel in the tip tanks.

Straight line variation exists between the points given.

When using auxiliary fuel, use wing tip tank fuel first.

Datum is located 79 inches ahead of the wing leading edge. It is measured longitudinally from station 65.5 and laterally from spanwise station 97.0 (First leading skin lap outboard of engine nacelle).

**STATIONS**

(Arm Aft of Datum)

Engine Oil .....	51.0 in
Front Seat Passengers .....	84.8 in
Basic Fuel - Inboard Tanks .....	90.0 in
Reserve Fuel - Outboard Tanks .....	95.0 in
Reserve Fuel - Tip Tanks (If Installed).....	90.5 in
Center Seat Passengers (SN 30-1 Through 30-589).....	118.5 in
Center Seat Passengers (SN 30-590 Through 30-2000) .....	120.5 in
Baggage Compartment .....	142.0 in
5th and 6th Seat Passengers (If Installed) .....	148.0 in

## WEIGHT AND BALANCE DETERMINATION FOR FLIGHT

### 1.) Use of the Weight and Balance Plotter:

A weight and balance plotter is available for the Twin Comanche, and greatly simplifies loading of the aircraft. The plotter was originally produced by Piper, and supplied with each airplane. When factory stock of the plotter was depleted, a reproduction was made available through the International Comanche Society. This second source is also exhausted, so no new plotter is available as of the publication date of this Manual.

The beginning reference point of the weight and balance plotter is the basic empty weight and C.G. of the airplane. This information can be obtained from the airplane logbook, and should be recorded in the "Weight and Balance Data Form" section of this chapter.

The term "basic empty weight" as it is used in this Manual includes unusable fuel and full engine oil. Original weight and balance data supplied with the PA-30 was "empty weight", and the additional weight and moment of unusable fuel and engine oil must be added to obtain the beginning reference point on the plotter.

Directions for use are on the face of the plotter. If a plotter is not available, the weight and balance can be determined manually by using the information contained herein.

### 2.) Manual Method of Determining Weight and Balance:

- A.) Add the weight of all items to be loaded to the airplane's basic empty weight.
- B.) Multiply the weight of each item by the stations arm to determine the moment of all items.
- C.) Add the moment of all items to be loaded to the basic empty weight moment.
- D.) Divide the total moment by the total weight to determine the C.G. location with landing gear extended.
- E.) Add the moment increase with landing gear retracted.
- F.) Divide the new total moment by the total weight to determine the C.G. location with landing gear retracted.
- G.) Determine that total weight and C.G. meet weight and balance requirements.

**LOADING PROBLEM EXAMPLE**

Item	Weight (lbs)	Arm (Aft of Datum)	Moment (in lb)
Empty Weight as Weighted at Factory	2,386.0	83.6	199481.6
Engine Oil (16 US qts)	30.0	51.0	1530.0
Unusable Fuel (Inboard Tanks - 6 US gal)	36.0	90.0	3240.0
Basic Empty Weight	2,452.4	83.3	204251.6
Fuel (Inboard Tanks - 54 US gal)	324.0	90.0	29160.0
Fuel (Outboard Tanks - 30 US gal)	180.0	95.0	17100.0
Pilot and Passenger (Front Seats)	310.0	84.8	26288.0
Passengers (Center Seats)	185.0	120.5	22292.5
Passengers (5th and 6th Seats)	60.0	148.5	8880.0
Baggage	34.0	142.0	4828.0
<b>Total</b>	<b>3,545.0</b>	<b>88.2</b>	<b>312800.1</b>
Fuel (Tip Tanks - 30 US gal - If Installed)	180.0	90.5	16290.0
<b>Total</b>	<b>3,725.0</b>	<b>88.3</b>	<b>329090.1</b>
Moment Increase With Landing Gear Retracted .....			770.0
<b>Total</b>	<b>3,725.0</b>	<b>88.6</b>	<b>329860.1</b>

**SAMPLE LOADING PROBLEM**

Item	Weight (lbs)	Arm (Aft of Datum)	Moment (in lb)
Basic Empty Weight	_____	_____	_____
Fuel (Inboard Tanks - 54 US gal Usable)	_____	90.0	_____
Fuel (Outboard Tanks - 30 US gal Usable)	_____	95.0	_____
Pilot and Passenger (Front Seats)	_____	84.8	_____
Passengers (Center Seats - SN 30-1 to 30-589)	_____	118.5	_____
Passengers (Center Seats - SN 30-590 and Up)	_____	120.5	_____
Passengers (5th and 6th Seats - 235 lb Max)	_____	148.0	_____
Baggage (200 or 250 lb Capacity)	_____	142.0	_____
Total (3600 lb Maximum Allowable)	_____	_____	_____
Fuel (Tip Tanks - 30 US gal - If Installed)	_____	90.5	_____
Total (3725 lb Maximum Allowable)	_____	_____	_____
Moment Increase With Landing Gear Retracted .....			770.0
<b>Total</b>	_____	_____	_____

**\*\* NOTE \*\***

100/130 Octane Fuel Density is Calibrated at: ..... 6.00 lbs/gal (0.72 kg/L)  
 100 LL Fuel Density is Calibrated at: ..... 5.82 lbs/gal (0.70 kg/L)  
 Ashless Dispersant Oil Density is Calibrated at: ..... 1.875 lbs/qt or 7.50 lbs/gal (0.90 kg/L)

**EQUIPMENT LIST**

	Mark if Installed	Weight (lbs)	Arm (Aft of Datum)	Moment (in lb)
<b>1.) Engines:</b>				
One or Two Lycoming Model IO-320-B	_____	293.0 ea.	45.8	26838.8
One Lycoming Model LIO-320-B (Right)	_____	293.0	45.8	13419.4
<b>2.) Propellers and Accessories:</b>				
Two Hartzell Constant Speed, Full Feathering Model HC-E2YL-2, 2A, 2B, 2C or 2D With HC-7663-4 Blades or One Model HC-E2YL-2BL With J7663-4 Blades (Right)	_____	54.5 ea.	23.0	2507.0
Two Governors - Hartzell Model F-6, F-6-3 F-6-3A, or F-6-3S (Left) or F-6-3AL (Right)	_____	4.6 ea.	61.8	568.6
Two Spinner Domes and Bulkhead Adapters	_____	4.0 ea.	20.1	160.8
<b>3.) Engine Accessories:</b>				
Two Fuel Pumps - Aux. Electric, Rotary One Weldon No. 8100A (R) and One Weldon No. 8100AA (L) or One Weldon No. 8100C (R) and One Weldon No. 8100CC (L) or One Weldon No. B8100C (R) and One Weldon No. B8100CC (L)	_____	3.0 ea.	90.0	540.0
Two Fuel Pumps - Engine Driven AC JT Model No. 5656696-A	_____	2.0 ea.	58.0	232.0
AC JT Model No. 6440160	_____	2.0 ea.	58.0	232.0
AC JT Model No. 6440296	_____	2.0 ea.	58.0	232.0
AC JT Model No. 6440652	_____	2.0 ea.	58.0	232.0
AC JT Model No. GP5656999	_____	2.0 ea.	58.0	232.0
Two Oil Radiators Harrison Model No. APO7AU06-03	_____	2.1 ea.	62.3	130.8
Two Starters Delco Remy 12 Volt, Model No. 1109511 or Model No. 11-1923 (Right)	_____	18.0 ea.	37.0	1332.0
Prestolite 12 Volt, Model No. MZ-4206	_____	18.0 ea.	37.0	1332.0
Two Vacuum Pumps Airborne Mechanisms Model No. 113A8, or 200CC (L) or 200CW (R)	_____	3.5 ea.	58.9	412.3
Two Full Flow Oil Filters W/Adapters AC No. 5578941 or Lycoming 75528	_____	2.5 ea.	60.6	303.0
AC No. 5578770 or Lycoming 74911	_____	2.5 ea.	60.6	303.0
AC No. 5578770 or Lycoming 77853	_____	2.5 ea.	60.6	303.0
Two Induction Air Filters Fram Model No. CA-144-PL	_____	0.7 ea.	57.0	79.8
Two 15 Gal Brittain Tip Tanks STC SA727WE	_____	25.0	91.2	2280.0

**EQUIPMENT LIST (Cont.)**

	Mark If Installed	Weight (lbs)	Arm (Aft of Datum)	Moment (in lb)
<b>4.) Landing Gear:</b>				
Two Main Wheel Brake Assemblies				
6:00 X 6 Type III				
Wheel, Cleveland 40-34				
Brake, Cleveland 30-23	_____	10.6 ea.	108.5	2300.2
6:00 X 6 Type III				
Wheel, Cleveland 40-90				
Brake, Cleveland 30-23	_____	10.6 ea.	108.5	2300.2
Two Main Wheel Tires (W/Tubes)	_____	9.4 ea.	108.5	2039.8
One Nose Wheel 6:00 X 6 Type III				
Wheel, Cleveland 38501 (Less Drum)	_____	6.4	21.0	134.4
One Nose Wheel Tire (W/Tube)	_____	9.4	21.0	197.4
<b>5.) Electrical Equipment:</b>				
Generator				
Delco Remy 12 Volt - 50 Ampere	_____	18.0	37.0	666.0
Dual Generators				
Delco Remy 12 Volt - 50 Ampere	_____	38.7	38.2	1478.3
Dual Alternators				
Prestolite 12 Volt - 70 Ampere	_____	32.0	38.1	1219.2
Battery - Forward Mount				
12 Volt - 35 Ampere Hour	_____	27.0	16.8	453.6
Battery - Aft Mount				
12 Volt - 35 Ampere Hour	_____	27.0	162.0	4374.0
Two Landing Lights				
GE Model 4509	_____	1.0 ea.	86.0	172.0
Rotating Beacon				
Whelen No. WRML-12	_____	1.4	275.0	385.0
Anti-Collision Lights				
Whelen Red Strobe Model HS	_____	3.1	175.2	543.1
Whelen White Strobe Model HD-T2	_____	4.8	134.4	645.1
Heaters				
Janitrol Model No. 20D35	_____	29.0	15.0	435.0
Southwind Model No. 94C-DC12	_____	24.5	15.0	367.5
<b>6.) Autopilots:</b>				
Piper Auto Control II (W/O Gyros)	_____	4.6	55.3	254.4
Piper Auto Control III (W/O Gyros)	_____	4.0	113.0	452.0
Piper Altimatic II (W/O Gyros)	_____	13.1	56.5	740.2
Piper Altimatic II (W/O Gyros)	_____	17.1	81.4	1391.9
Piper Altimatic III (W/O Gyros)	_____	18.9	119.5	2258.6

**EQUIPMENT LIST (Cont.)**

	Mark If Installed	Weight (lbs)	Arm (Aft of Datum)	Moment (in lb)
<b>7.) Miscellaneous Equipment:</b>				
Heated Pitot Head PAC 21301	_____	1.0	99.0	99.0
Fire Extinguisher - Walter Kidde PAC 21731	_____	5.0	84.8	424.0
Fire Extinguisher - MIL-E-5220A PAC 21731	_____	8.0	84.8	678.4
Fire Extinguisher - Scott Aviation PAC 21731	_____	4.3	84.8	364.6
Mixture Monitor PAC 25280	_____	2.0	68.0	136.0
Mixture Monitor PAC 26738	_____	2.5	61.6	154.0
Mixture Control Indicator PAC 26738	_____	2.5	61.6	154.0
Dual Brake Installation (Copilot) PAC 24438	_____	5.0	58.0	290.0
Dual Tachometer Installation PAC 26897	_____	2.2	64.6	142.1
Dual Altimeter Installation PAC 26730	_____	3.0	64.2	192.6
Piper Radio Coupler PAC 25001	_____	0.5	66.0	33.0
Piper Electric Trim PAC 24889	_____	4.0	163.0	652.0
Anti-Static Equipment PAC 25043	_____	2.0	154.0	308.0
Air Flow Modification Kit PAC 27205	_____	1.6	110.0	176.0
Rudder-Aileron Connect Kit PAC SK2169	_____	2.3	123.0	282.9
Seat Installation - Fifth PAC 25302	_____	7.5	148.0	1110.0
Seat Installation - Sixth PAC 26602	_____	7.5	148.0	1110.0
Vertically Adjustable Front Seats PAC 26971	_____	21.3 ea.	84.8	3612.5
Head Rests (Seats 1 & 2) PAC 26652	_____	1.0 ea.	95.0	190.0
Head Rests (Seats 3 & 4) PAC 26652	_____	1.0 ea.	130.0	260.0
Shoulder Harness (Seats 1 & 2) PAC 27006	_____	0.6 ea.	100.0	120.0
Shoulder Harness (Seats 3 & 4) PAC 27006	_____	0.6 ea.	133.0	159.6
Aux Power Receptacle W/Jumper Cable	_____	7.0	153.3	1073.1
Aux Power Receptacle W/Jumper Cable	_____	6.5	113.3	736.5
Oxygen System Installation PAC 25342	_____	41.5	161.2	6689.8
Oxygen System Installation PAC 25542	_____	41.5	161.2	6689.8
Oxygen System Installation PAC 25724	_____	41.5	161.2	6689.8
Oxygen System Installation PAC 26682	_____	41.5	161.2	6689.8
Glar Ban Lights PAC 26871	_____		Negligible Weight Change	
Stall Warning Indicator PAC 26651	_____		Negligible Weight Change	
Landing Gear Security Kit PAC 760-627	_____		Negligible Weight Change	
Alternate Static Air Source PAC 26722	_____		Negligible Weight Change	
DMCR Approved Airplane Flight Manual	_____		Negligible Weight Change	
FAA Approved Airplane Flight Manual	_____		Negligible Weight Change	
Applicable Flight Manual Supplements	_____		Negligible Weight Change	



**EQUIPMENT LIST (Cont.)**

	Mark If Installed	Weight (lbs)	Arm (Aft of Datum)	Moment (in lb)
<b>8.) Other Equipment:</b>				

	SN	Weight (lbs)	Arm (Aft of Datum)	Moment (in lb)
<b>9.) Avionics:</b>				

**WEIGHT AND BALANCE**

PA-30 \* 3600/3725 POUNDS GROSS WEIGHT

SERIAL NO: 30 - \_\_\_\_\_ REGISTRATION NO: N - \_\_\_\_\_ DATE: \_\_\_\_\_

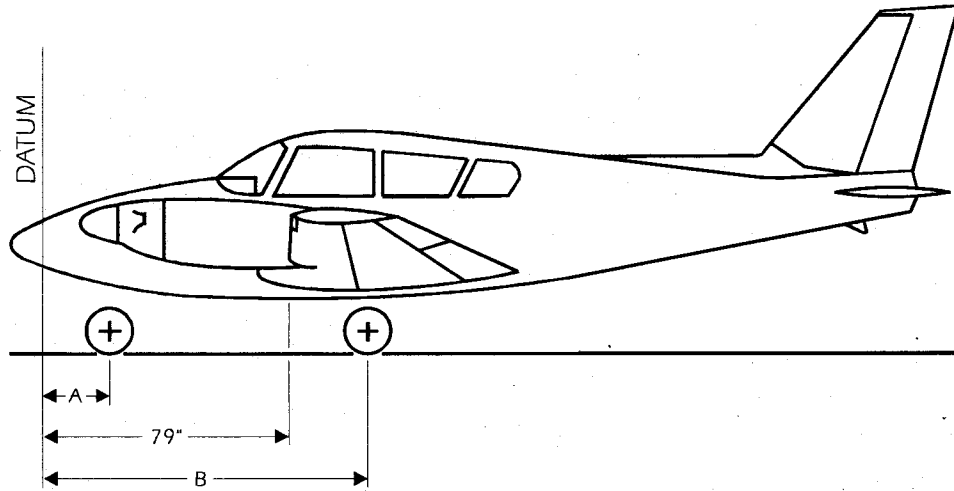

Basic Empty Weight as Weighed

Left Wheel	(L)	_____
Right Wheel	(R)	_____
Nose Wheel	(N)	_____
Total	(T)	_____

APPROVED C.G. RANGE AND WEIGHT

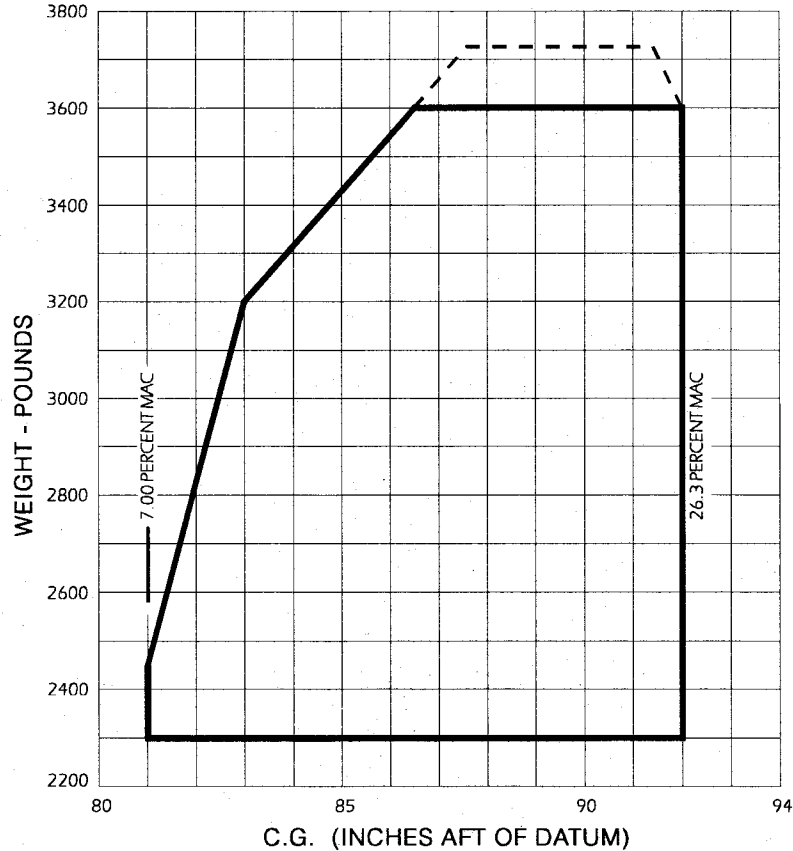

**FIGURE 6-01**

## SECTION 7 - SYSTEMS DESCRIPTION

PA-30 \* 3600 LBS GROSS WEIGHT

### Table of Contents

Introduction .....	7-2
Airframe .....	7-2
Engine and Propeller .....	7-2
Engine Controls .....	7-3
Flight Controls .....	7-3
Landing Gear .....	7-4
Brake System .....	7-4
Fuel System .....	7-5
Electrical System .....	7-6
Instrument Panel .....	7-6
Vacuum System .....	7-6
Pitot-Static System .....	7-7
Heating and Ventilating System .....	7-7
Cabin Features .....	7-8
Stall Warning .....	7-9
Oxygen System .....	7-9
Emergency Locator Transmitter .....	7-9
Figure 7-01 Fuel System Schematic .....	7-10
Figure 7-02 Generator and Starter Schematic .....	7-11
Figure 7-03 Alternator and Starter Schematic (Supplement) .....	7-12
Figure 7-04 Instrument Panel (A & B Models) .....	7-13
Figure 7-05 Instrument Panel (C Model) .....	7-14
Figure 7-06 Heating and Ventilating System .....	7-15
Figure 7-07 Vacuum System Schematic .....	7-16

## **SYSTEMS DESCRIPTION**

PA-30 \* 3600 LBS GROSS WEIGHT

### **INTRODUCTION**

The PA-30 Comanche is a high-performance, twin-engine, low-wing, retractable-gear monoplane of all-metal construction. It has four (optional six) place seating, 200 or 250 pound baggage capacity, and two 160 horsepower engines with full feathering propellers.

### **AIRFRAME**

The structures of the PA-30, except for the tubular-steel engine mount, steel landing-gear struts, and other miscellaneous steel parts, are of sheet-aluminum construction, alodine treated and completely primed with zinc-chromate primer, then covered with acrylic lacquer on the exterior surfaces. The extremities (wing tips, stabilator and rudder end pieces) are constructed of fiberglass or ABS thermoplastic. The fuselage is an all-metal semi-monocoque construction composed of bulkheads, stringers, stiffeners and longitudinal beams to which the outer skin is riveted.

The laminar-flow wing is of all-metal stressed skin, full-cantilever design. The wing section is a NACA 64<sub>2</sub> A215 airfoil with maximum thickness approximately forty-percent aft of the leading edge. This permits the main spar to pass through the cabin under the rear seats, providing unobstructed cabin-floor space. The extruded-beam type main spar is joined with high-strength butt fittings at the center of the fuselage making in effect a continuous main spar. The spars are attached to the fuselage at the side and in the center of the structure. The wings are also attached at the rear spar and at an auxiliary front spar. The ailerons are cable and push-rod controlled and are statically and dynamically balanced. The trailing-edge wing flaps are electrically operated. Flush riveting is used over the forward part of the wing up to the main spar.

The all-metal empennage group is a full-cantilever design consisting of a vertical fin, rudder, and stabilator with an anti-servo tab. The rudder and stabilator are statically and dynamically balanced. The stabilator and vertical fin have two-channel main spars running full length. The stabilator is attached to the fuselage by a torque tube supported by bearing blocks.

### **ENGINE AND PROPELLER**

The normally aspirated Twin Comanche is powered by two Lycoming IO-320-B series engines rated at 160 bhp each at 2700 rpm. The IO-320-B series engines are four cylinder, direct drive, wet sump, horizontally opposed, air cooled, and have 319.8 cubic inches of displacement. These engines are designed to operate on 91/96 (minimum) octane aviation-grade fuel. Major accessories furnished with the engines are geared starters, 50-ampere, 12-volt generators or 70 ampere, 12 volt alternators, dual vacuum pumps, direct-drive fuel pumps, dry automotive-type induction air filters, and dual magnetos. An external oil cooler is mounted on the left rear of each engine baffle.

Cowl flaps are manually operated by two push-pull controls located to the right of the power quadrant. The cowl flaps should be open during ground operations and in climbs. In no case should the cylinder head temperature be allowed to exceed 500 degrees Fahrenheit or the oil temperature be allowed to exceed 245 degrees Fahrenheit.

The fuel injection system is a Bendix self-purging servo regulator metering system. The system is equipped with a manual mixture control and idle cut-off mechanism. A fuel flow indicator is installed in the instrument panel to give an accurate indication of fuel flow. It is important to note that an indication of increasing or abnormally high fuel flow is a possible symptom of restricted injector lines or nozzles.

Induction air is normally directed through a filter, but the induction system includes a spring loaded door which opens automatically if the filter becomes blocked to allow air to the engine. This alternate air door can also be operated manually by a push-pull (ALT AIR) control on the instrument panel. This control should be operated if induction system icing is suspected.

The constant speed, full feathering, controllable pitch propellers are alloy forged and controlled by a governor mounted on the engine which supplies oil to the propeller at various pressures through the engine crankshaft.

The feathering mechanism is dry nitrogen operated. Feathering is accomplished by moving the propeller controls fully aft through the low rpm operating range into the feathering position. Feathering takes place in approximately three seconds. An optional propeller synchrophaser automatically matches the rpm and phase angle of both propellers. The right engine is slaved to the left, and the systems range of control is limited to 50 rpm.

## **ENGINE CONTROLS**

Engine controls consist of dual throttle controls, mixture controls, and propeller rpm controls which are located in a power control quadrant at the lower center of the instrument panel where they are accessible to both the pilot and copilot.

## **FLIGHT CONTROLS**

The primary flight controls of the PA-30 are of conventional design consisting of a control wheel that operates the ailerons and stabilator, and pedals that operate the rudder. Duplicate controls are provided for the copilot.

The stabilator trim is operated by an overhead crank in the cabin or an electric trim mechanism activated by a switch mounted on the control wheel. Both methods control a rotating drum in the tail section. The rudder trim is operated by a knob mounted below the right center of the instrument panel that controls a bungee mechanism that extends forward to the nose gear steering arm. Coordinated action of the rudder and ailerons is accomplished by cables that are interconnected by a cable-spring system.

Installed on the Twin Comanche are electrically operated fowler flaps which can be lowered and stopped at any position up to 27 degrees. The flap control switch is located below the right center of the instrument panel just above the rudder trim control. A flap position indicator is located in the instrument panel. It is marked to show the degree of flap travel and also shows a range of operation for takeoff. A locking mechanism holds the flap on the right side when it is in the up position so that it may be used as a step while entering or exiting the aircraft.

## LANDING GEAR

The PA-30 tricycle landing-gear system is a fully retractable air-oil, oleo-strut type, and is electrically operated by a selector switch located on the instrument panel. The gear selector is in the shape of a wheel to distinguish it from the flap control which is in the shape of an airfoil. The three landing gear are mechanically connected, and move as a unit.

The nose gear is steerable with the rudder pedals through a forty-degree arc. The steering mechanism is disconnected automatically during gear retraction to reduce rudder pedal loads in flight. The nose wheel is equipped with a hydraulic shimmy damper.

Retraction of the landing gear is accomplished by an electric motor and transmission assembly located under the floorboard, activating push-pull cables to each of the main gear, and a push-pull tube to the nose gear. Limit switches are installed in the system to cut off the gear motor when the gear is fully extended or retracted.

To guard against inadvertent movement of the landing-gear selector switch while on the ground, a mechanical guard is positioned just below the switch. The switch handle must also be pulled aft before being placed in the "GEAR UP" position. A warning horn will sound if the selector switch is placed in the "GEAR UP" position while the weight of the airplane is resting on the landing gear.

To prevent inadvertent retraction of the landing gear while the airplane is on the ground, a safety "squat" switch is installed on the left main gear to open the electric circuit to the landing-gear motor until the strut is fully extended.

If manifold pressure on both engines is reduced below approximately 12-inches, and the landing gear is not down and locked, a warning horn will sound to alert the pilot to the possibility of a gear-up landing. The landing-gear warning horn emits a continuous sound.

A green light on the instrument panel is the primary indication that the landing gear is down and locked. When the gear is fully extended, the series circuit that lights this lamp is completed through a switch located on each of the three gear. All three gear must be down and locked for the indicator to light. An amber light above the landing-gear selector switch indicates the gear is up. This lamp will flash if the landing gear is up and manifold pressure of one engine is reduced below approximately 12 inches. A third white light (installed on later models) will indicate that the landing gear is in transit. It is important to note that the landing-gear indication lights are automatically dimmed when the navigation lights are turned on.

A removable emergency handle is used to manually extend the landing gear in the event of a malfunction of the electrical system.

## BRAKE SYSTEM

The brakes are activated by toe pedals mounted above the pilot (optional copilot) rudder pedals, or by a hand lever located below the left center of the instrument panel. The hydraulic brake system is a self-adjusting, single-disk, double-piston assembly. Each rudder pedal has its own master cylinder, but both share a common reservoir.

The parking brake is connected mechanically to the master cylinders and may be set by applying the toe brakes or hand lever and pulling out the parking brake "T" handle. To prevent inadvertent application of the parking brake in flight, a safety lock is incorporated to eliminate the possibility of pulling out the "T" handle until pressure is applied by use of the toe brakes or hand lever. To release the parking brake, apply the brakes and push in on the parking brake "T" handle.

## FUEL SYSTEM

The fuel cells on the Twin Comanche consist of rayon-neoprene bladders which are contained in cavities in the forward sections of the wing. The inboard main cells hold a capacity of 30 gallons (27 usable) each and the outboard auxiliary cells have a capacity of 15 gallons each. Optional wingtip tanks (if installed) also have a capacity of 15 gallons each. It is important to note that due to several factors including aircraft attitude while refueling, many fuel cells do not hold their full rated capacity.

Fuel cells should be kept full when the aircraft is not in use to prevent accumulation of moisture through condensation and to keep the rubber from deteriorating by drying out.

Fuel cells are vented individually by NACA anti-icing vent tubes located beneath the wing. Fuel from each cell passes through a selector-shutoff valve to a sediment bowl in the lowest part of the fuel system where it is filtered, and any water or foreign particles are trapped. From there the fuel is drawn to the fuel injection system by an engine driven pump. In the event of failure of the engine driven pump, an electric auxiliary fuel pump is provided. In addition to the back-up function, this pump is normally operated when switching fuel tanks and during starting, takeoff and landing.

The fuel strainer units are located under the floorboard between the pilot and copilot seats just aft of the fuel selector valves. Daily draining of the sediment bowls is accomplished by opening the hinged access door and operating the quick drain valve for approximately five seconds with the fuel selector valve on one cell. Change the fuel selector to the next cell and repeat the process until all cells are checked. Allow enough fuel to flow to clear each of the lines as well as the sediment bowl strainer. Positive fuel flow shutoff can be observed by means of the clear plastic tube which carries the fuel overboard.

Fuel quantity is indicated by two electric gauges located in the engine instrument cluster. The fuel quantity gauges will indicate the amount of fuel in the cells that are selected by the selector-shutoff valves.

A crossfeed is provided for emergency single engine operation. To use fuel from the side opposite of the operating engine, place the fuel selector for the inoperative engine in the "MAIN" or "AUXILIARY" position (solenoid switch in the "AUX" or "TIP" position if wingtip fuel tanks are installed) and place the fuel selector for the operating engine in the "CROSSFEED" position.

Never place both fuel selectors in the crossfeed position at the same time, and the fuel system should be taken off crossfeed before executing a single engine landing.

## ELECTRICAL SYSTEM

Electrical power for the Twin Comanche is supplied by a 12-volt, direct-current, negative-ground system. The primary electrical power source on the A and B models is a 12-volt, 50-ampere generator (dual generators optional) controlled by a voltage and current regulator. The C model is equipped with dual 12-volt, 70-ampere alternators protected by an overvoltage relay. Secondary power is provided by a 12-volt, 35 ampere-hour battery which supplies power for starting, and is a reserve power source in the event of generator or alternator failure.

The battery is mounted in a stainless-steel box either immediately aft of the baggage compartment or in the nose section. The voltage regulator and overvoltage relay is mounted on the aft bulkhead of the nose section. The ammeter, located on the instrument panel near the engine gauge cluster, indicates battery discharge.

Electrical switches are located on the lower left side of the instrument panel. The master switch is positioned on the far left of these switches. Circuit breakers on the A and B models are mounted in the floorboard below the power quadrant. Circuit breakers on the C model are mounted on the lower right of the instrument panel.

Standard lighting on the Twin Comanche includes navigation lights, landing lights, cabin and instrument lights. Optional equipment includes a rotating beacon and strobe lights. A combination on-off rheostat switch controls the instrument and radio lights.

## INSTRUMENT PANEL

The instrument panel is designed to accommodate the customary advanced flight instruments, the normally required engine instruments, and avionics for VFR and IFR flight. Flight instruments on the C model are arranged in the "T" configuration. The artificial horizon and directional gyro are vacuum operated. The turn-indicator or turn coordinator gyro is electrically operated and serves as a standby for the vacuum gyros in the event of a vacuum system failure.

Radios are located in the center section of the instrument panel. The avionics master switch (if installed) is typically located with the other electrical switches to the right of the master switch.

## VACUUM SYSTEM

The vacuum system provides the suction necessary to operate the attitude indicator and the directional gyro. The engine-driven system consists of two vacuum pumps, each of which has its own vacuum relief valve with filter, a system inlet-air filter, and a suction gauge. If suction is lost from one of the vacuum pumps, a check valve closes and adequate suction is supplied by the remaining pump. A mechanical warning indicator located in the suction gauge will indicate which pump has failed.

The vacuum pumps are dry-type pumps. A shear drive in the pump assembly protects the engine from damage. Caution should be exercised to insure that the propeller is never pulled through backward, as doing so will damage the rotary vanes in the vacuum pump and potentially render the gyros inoperative.

The vacuum regulator is adjustable to a normal reading of 5.0 inch Hg plus .1 or minus .2 inch Hg. Proper adjustment is important because higher settings will damage the gyros, and the instruments will be unreliable with a low setting.



### PITOT-STATIC SYSTEM

The pitot-static system provides ram air pressure to the airspeed indicator and static pressure to the airspeed indicator, vertical speed indicator, and altimeter. The system is composed of a heated (optional) pitot tube mounted on the lower surface of the left wing, a pair of static ports located on either side of the fuselage aft of the baggage compartment, and the associated piping necessary to connect the instruments to the sources.

An alternate static source is available as an option. Airspeed and altitude readings can be expected to be higher than normal when operating from the alternate air source.

The following table shows corrections to use when operating on the alternate static system.

Indicated Airspeed (mph)	Standard Static System	Alternate Static System	
	CAS (mph)	CAS (mph)	
80	82	81	
88	90	91	
120	121	113	Gear and Flaps Retracted
160	160	148	
200	197	185	
220	216	204	
80	80	81	Gear and Flaps Extended
91	90	91	
100	98	97	
120	117	113	

### HEATING AND VENTILATING SYSTEM

There are four individual controls located on the lower right side of the instrument panel which regulate the flow of heating, defrosting and ventilating air.

Heat for the cabin interior is provided by a gasoline heater installed in the nose section. Heated air for the defroster system is provided by the same heater, but has an individual control. Caution should be used when operating the defroster on the ground as prolonged application of heat may cause damage to the Plexiglas windshield.

The cabin heater consumes approximately one gallon of gasoline an hour when operating, and its source is the right engine fuel supply. If the cabin heater is used, this factor should be computed when figuring fuel consumption.

Fresh air is supplied to the cabin by air inlets located in the fuselage nose. Two adjustable ventilators are located near the floor forward of the front seats. In addition, there is a fresh air scoop located in the dorsal fin which provides air to the rear seating positions.

The early model Twin Comanche (SN 30-1 through 30-401) is equipped with a cabin heater manufactured by Southwind. Later models (SN 30-402 and above) are equipped with a Janitol heater. Controls are provided to direct the airflow to both the front and rear cabin. The heater uses gasoline supplied from the right engine fuel system. If the right fuel selector is off, the heater is inoperative. A temperature limit switch will override heater operation if a malfunction occurs resulting in excessive temperatures.

To operate the Southwind heater, first turn on the fuel valve, then move the heater switch to "LOW" or "HIGH" position. If the heater does not start, move the switch to the "PRIME" position for 15 seconds and then to "HIGH". If all controls are in the closed position, heated air is exhausted overboard. High heat is normally used only in flight as ground operation may result in excessive exhaust smoke from the heater.

When the heater is turned off, combustion stops but the fan continues to operate for a few minutes to cool the heater and purge it of fumes. It is recommended that the heater be turned off as soon as practical after landing to insure that it has cycled before shutting off the master switch.

To operate the Janitol heater, the manual fuel valve must be "ON" and the three position switch on "HEAT". No priming is required. Heat is regulated by a thermostat and no excess hot air is exhausted overboard.

When the Janitol heater is turned off, and the manual fuel valve is closed, combustion stops and no purge time is required.

## **CABIN FEATURES**

The front seats adjust fore and aft for ease of entry and exit to the cabin, and occupant comfort. All seats are easily removed and all seat positions are equipped with seat belts.

The early model PA-30 has a single rear seat. The back of the seat is adjustable to various fore and aft positions by use of latches located at the upper outboard corners. The B and C models are equipped with two individually adjustable rear seats.

A large baggage area is located aft of the rear seat. On the early model, it is accessible through a 20 x 20 inch outside baggage door on the right side of the fuselage. Maximum capacity is 200 pounds, and tie down straps are provided. On the B and C models, the baggage compartment is accessible either from the cabin or through a 19 x 21 inch outside baggage door on the left side of the fuselage. Maximum capacity is 250 pounds, and optional 5th and 6th seats are available.

The baggage door on the later models may be used as an emergency exit. It is opened from inside the aircraft by holding the door knob up while turning the latch clockwise.

Each aircraft is equipped with a tow bar. It is stowed either in the baggage compartment or next to the main spar under the flap covering.

## **STALL WARNING**

An approaching stall is indicated by a stall-warning light (and optional horn) which is activated between five and ten knots above stall speed. The stall warning horn emits an interrupted sound to distinguish it from the landing gear warning horn. Mild to moderate airframe buffeting and gentle pitching may precede the stall. The stall-warning lamp is activated by a lift detector installed in the leading edge of the left wing. The stall-warning system is inoperative with the master switch off.

## **OXYGEN SYSTEM**

The oxygen system for the PA-30 consists of an oxygen cylinder and regulator, filter valve, pressure gauge, outlets for masks and an on-off control mounted on the instrument panel. The cylinder has a 63 cubic foot capacity at a working pressure of 1800 pounds per square inch. Each outlet has a spring-loaded valve that prevents the flow of oxygen until a mask hose is engaged into the outlet.

### **\*\* WARNING \*\***

The utmost care should be taken to insure that no combustion source exists in the cabin while operating on oxygen. Smoking is prohibited while oxygen is in use.

When recharging the oxygen supply, be certain to use only aircraft quality aviator's breathing oxygen. Do not use hospital or industrial oxygen because the moisture contained in these products may freeze at altitude and disable the oxygen system.

## **EMERGENCY LOCATOR TRANSMITTER**

Federal Aviation Regulations require (with certain exceptions) that all civil aircraft registered in the United States must be equipped with an ELT which meets the applicable requirements of TSO-C91 or TSO-C91-A.

The ELT battery must be replaced if the transmitter has been used in an emergency, or after one hour of accumulated testing time, or if the unit has been inadvertently activated for an undetermined period of time, or after half of the useful life has expired. The battery expiration date is marked on the outside of the ELT case.

The ELT should be checked after each flight to make certain that the unit has not been accidentally activated. Check by tuning a radio receiver to 121.5 and listening for an oscillating sound. If the ELT has been activated, it should be turned off immediately.

### **\*\* NOTE \*\***

Testing of the ELT should be conducted only in the first five minutes of the hour, and limited to three audio sweeps.

# FUEL SYSTEM SCHEMATIC

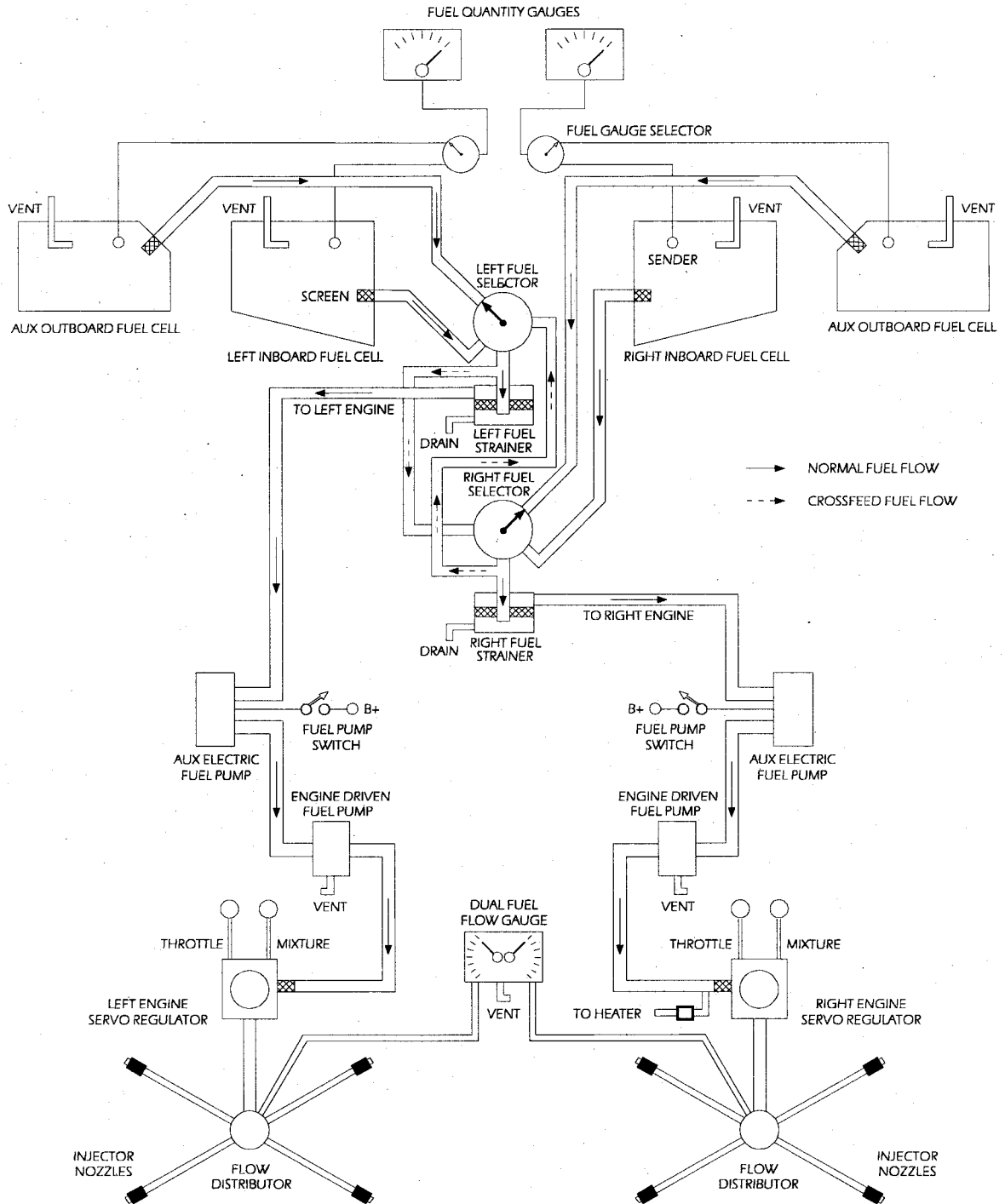

FIGURE 7-01

# FUEL SYSTEM SCHEMATIC

(Normally Aspirated Model Equipped With Tip Tanks -- 3725 Lbs Gross Weight)

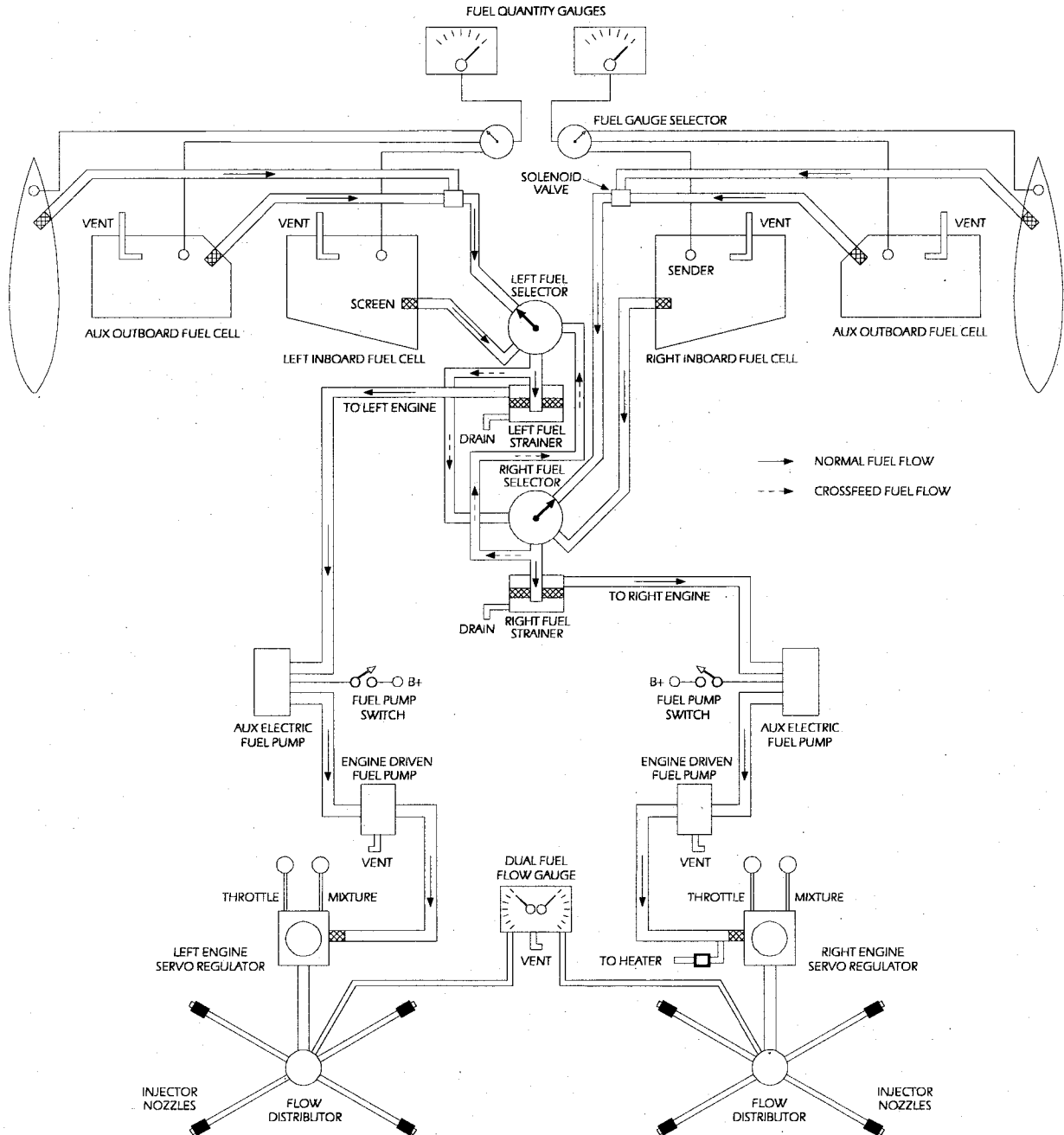
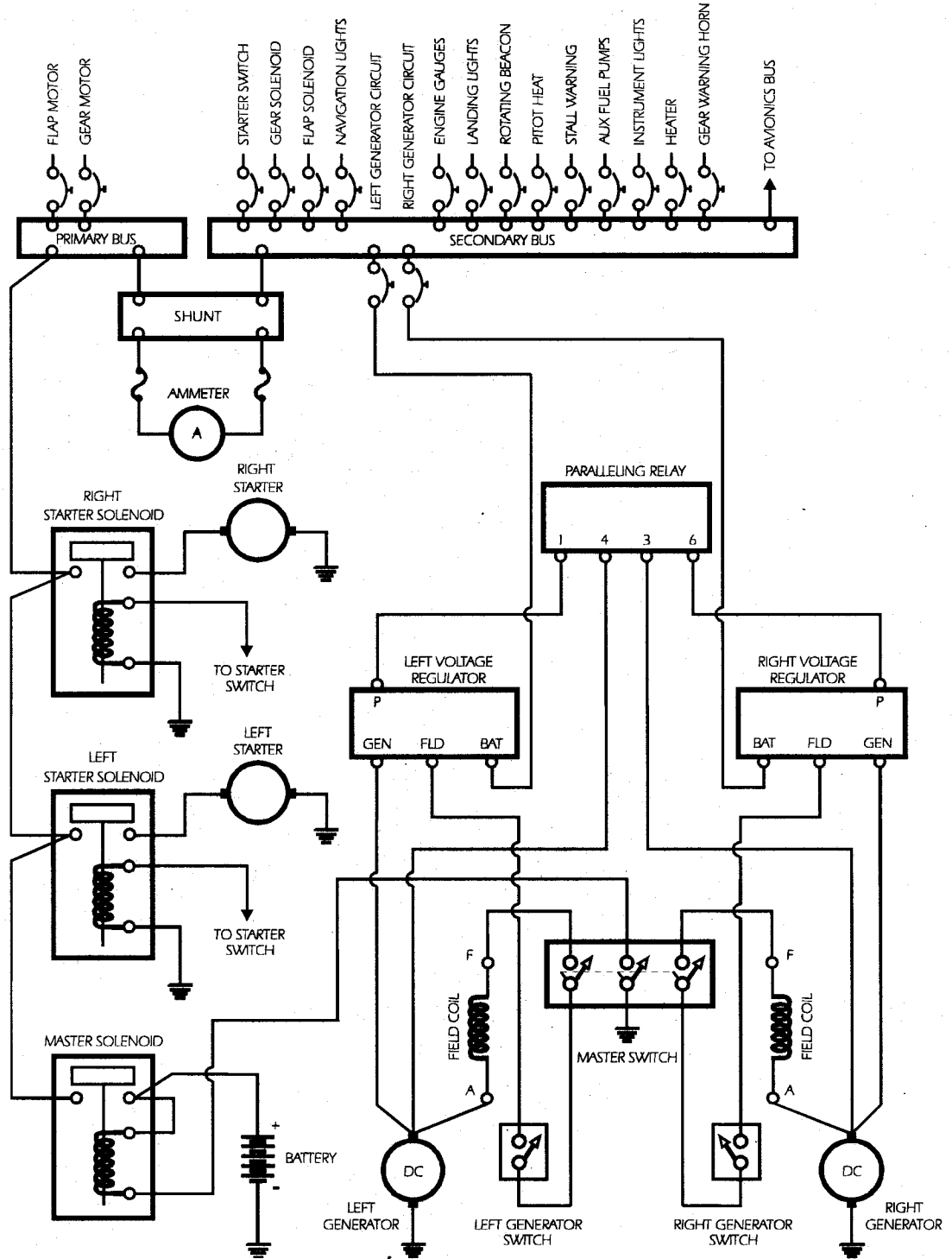

FIGURE 7-01

# GENERATOR AND STARTER SYSTEM SCHEMATIC



**FIGURE 7-02**

# ALTERNATOR AND STARTER SYSTEM SCHEMATIC

(Non-Paralleling System)

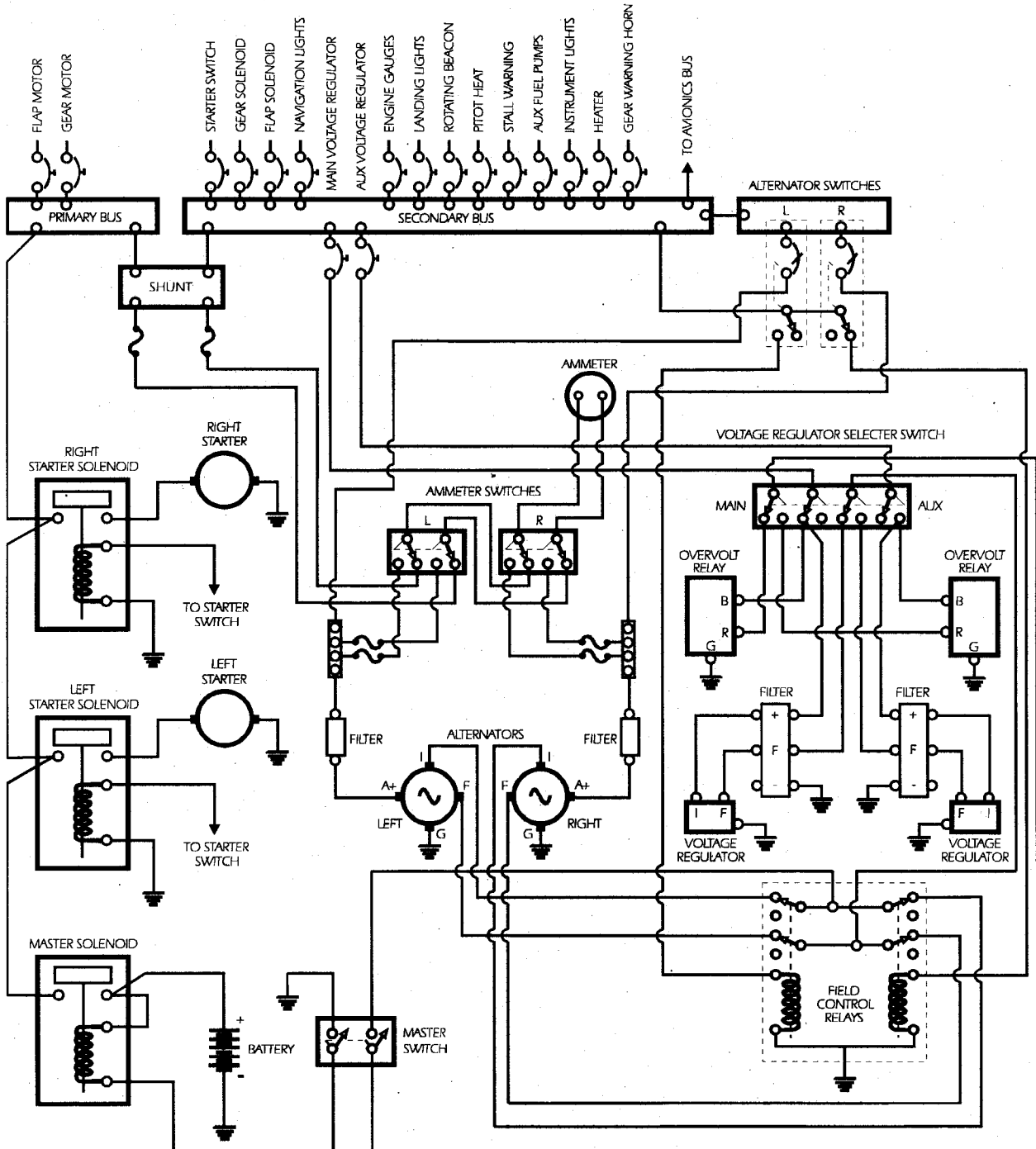

FIGURE 7-03

# TYPICAL INSTRUMENT PANEL

(A & B MODELS)

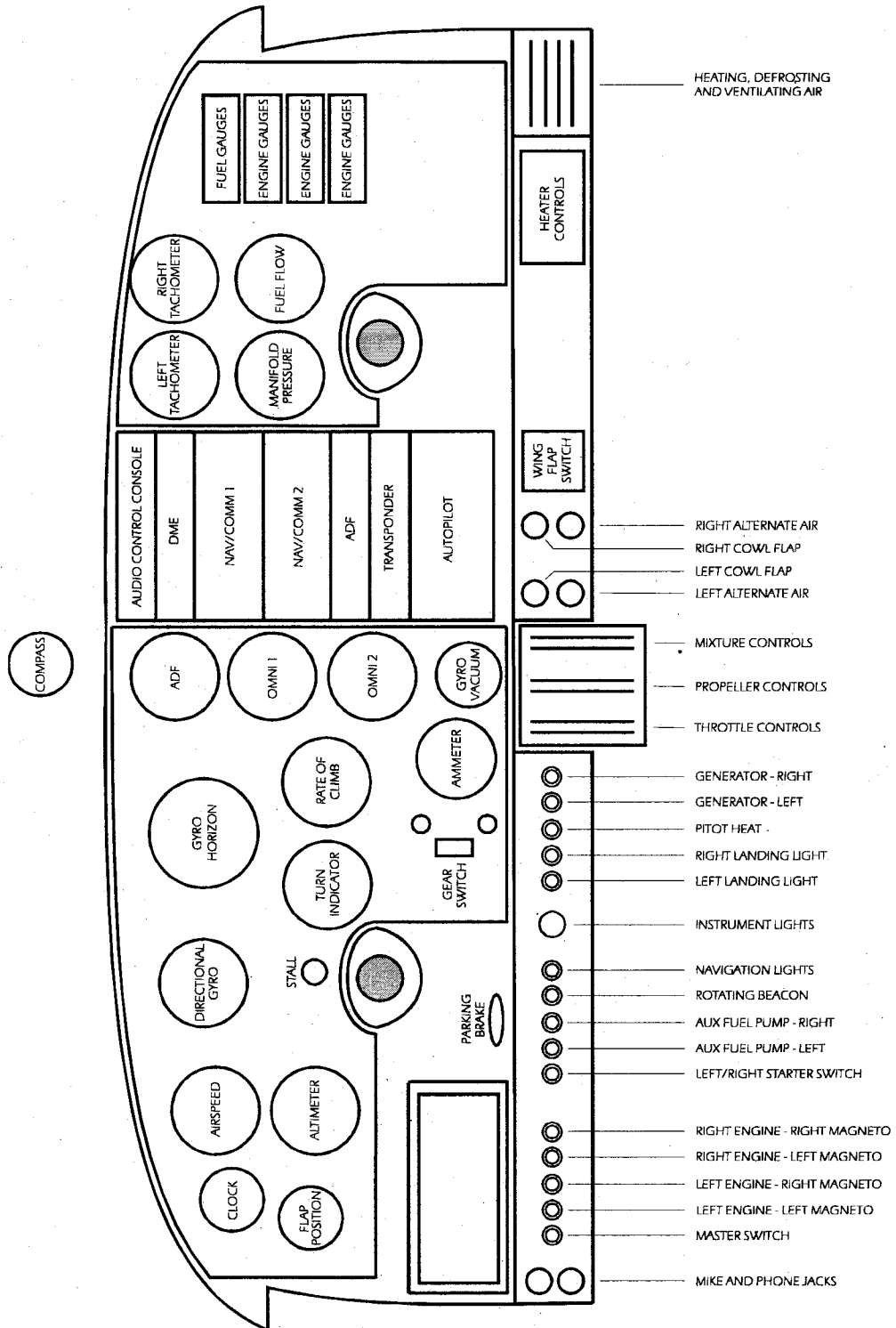

FIGURE 7-04



# TYPICAL INSTRUMENT PANEL (C MODEL)

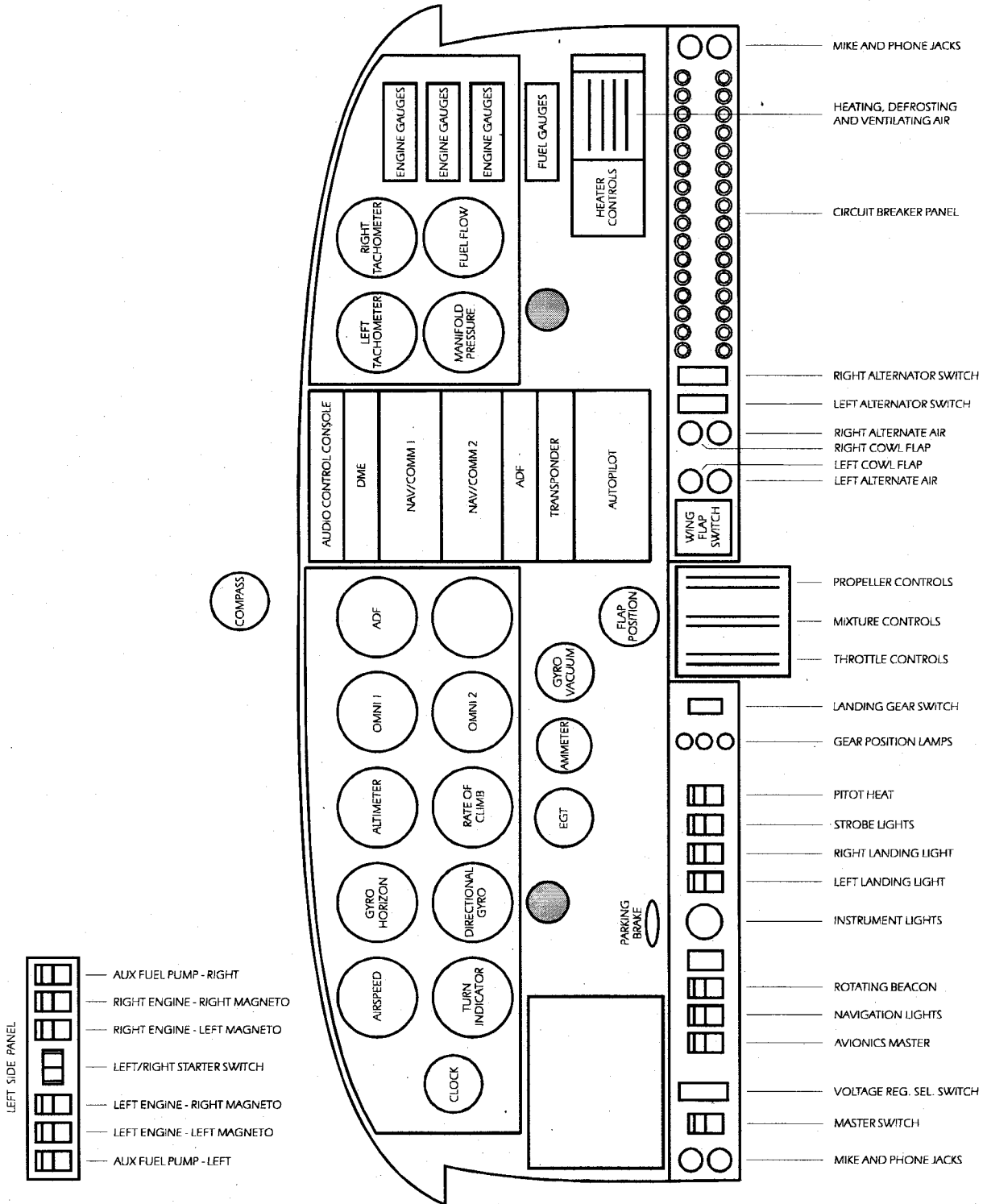

FIGURE 7-05

# HEATING AND VENTILATING SYSTEM

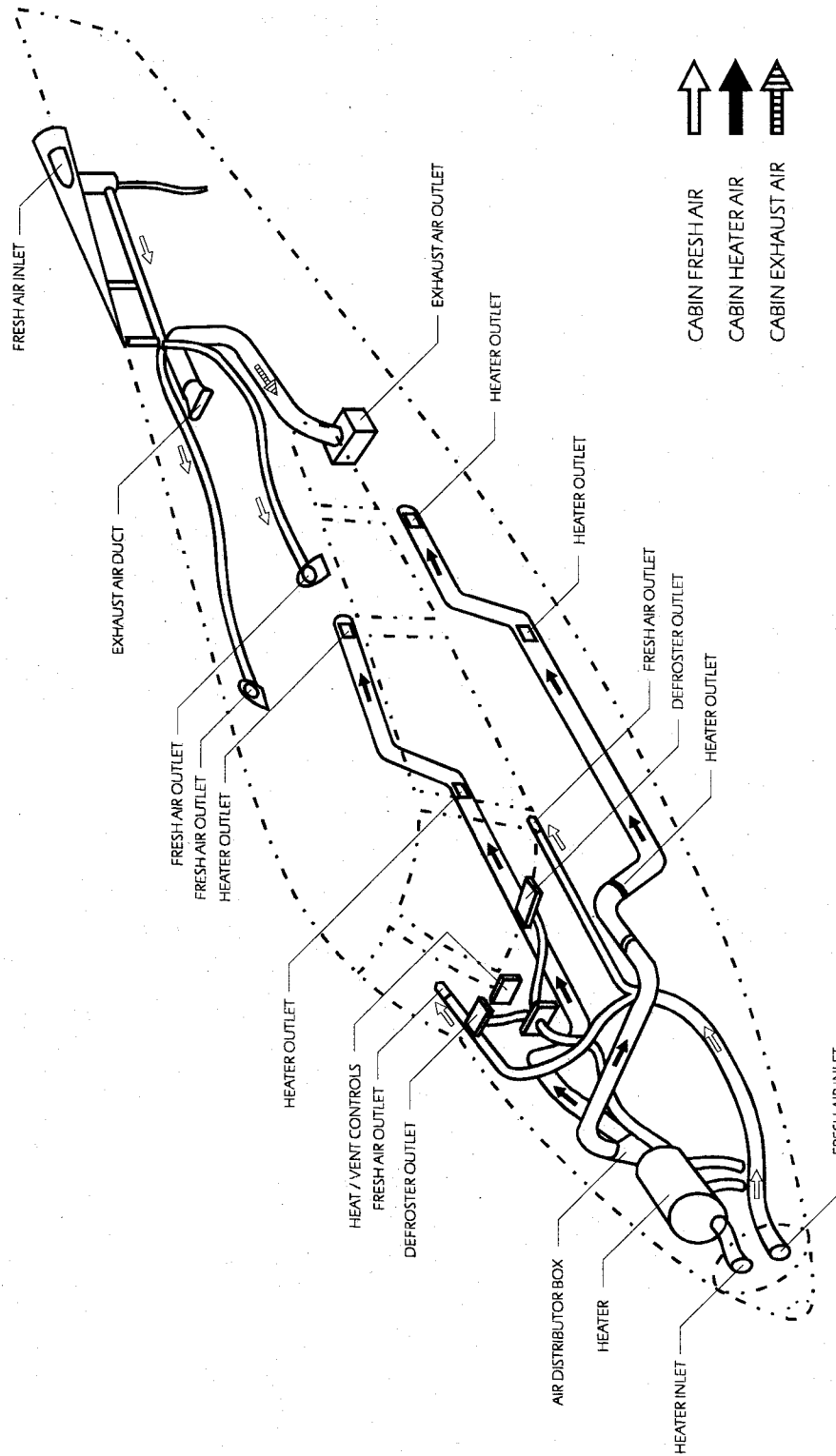
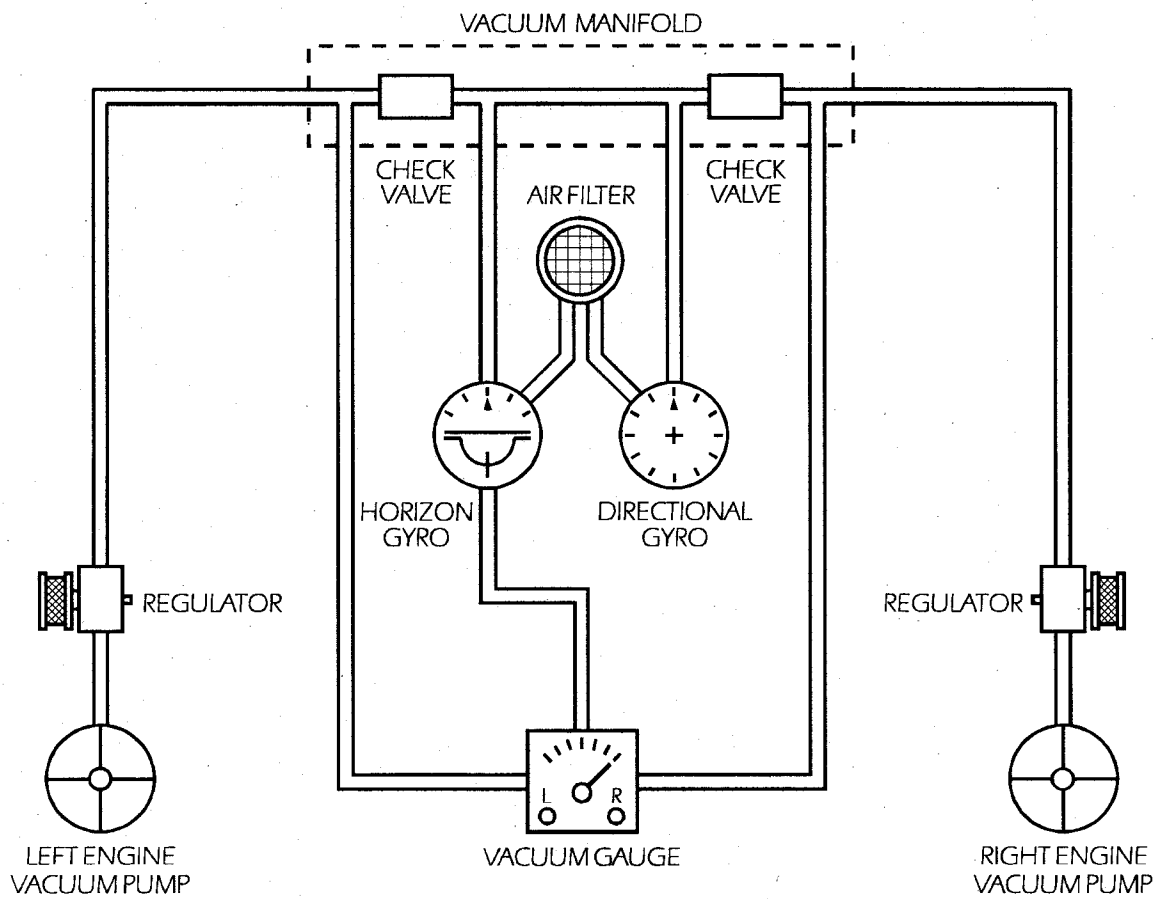

FIGURE 7-06

# VACUUM SYSTEM SCHEMATIC



**FIGURE 7-07**

## SECTION 8 - MAINTENANCE

PA-30 \* 3600 LBS GROSS WEIGHT

### Table of Contents

Introduction .....	8-2
Serial Number Plate .....	8-2
Inspection Periods .....	8-2
Alterations .....	8-3
Ground Handling .....	8-3
Towing .....	8-3
Parking and Mooring .....	8-3
Jacking .....	8-3
Preventative Maintenance .....	8-4
Engine Care .....	8-4
Fuel Requirements .....	8-4
Oil Requirements .....	8-5
Battery Service .....	8-5
Air Filter Care .....	8-5
Propeller Care .....	8-6
Landing Gear Service .....	8-6
Brake Service .....	8-6
Tire Care .....	8-7
Lubrication .....	8-7
Cleaning .....	8-7
Windshield and Windows Care .....	8-7
Exterior Surfaces .....	8-7
Interior Care .....	8-7
Intermittent Operation Procedure .....	8-8
Airplane File .....	8-8

## **MAINTENANCE**

PA-30 \* 3600 LBS GROSS WEIGHT

### **INTRODUCTION**

This section provides general guidelines relating to servicing and maintenance of the Twin Comanche. Piper Aircraft has from time to time issued Service Bulletins, Service Letters and Service Spares Letters relating to the aircraft which have been available from various sources including a subscription service.

Service Bulletins are of special importance and should be complied with promptly. Service Letters deal with product improvements and service hints pertaining to the aircraft. Service Spares Letters offer improved parts, kits and optional equipment that were not available originally, and which may be of interest to the owner. In addition, numerous STC modifications are available for the aircraft from independent sources.

A Service Manual and Parts Catalog are also available from Piper dealers and other sources.

### **SERIAL NUMBER PLATE**

The serial number plate on the Twin Comanche is located in one of the following locations: On the left side of the fuselage by the tail skid; inside the left side of the fuselage opposite the rear fuselage access panel, or on the forward cabin bulkhead. The serial number of the plane should always be used when referring to the airplane in service matters.

### **INSPECTION PERIODS**

The FAA occasionally publishes Airworthiness Directives that apply to specific groups of aircraft. When an AD is issued, it is sent to the registered owner of the aircraft. The owner is advised to periodically check with his Piper dealer or A&P mechanic to insure that he has all ADs issued against his aircraft.

One-Hundred Hour Inspections are required by law if the aircraft is used commercially, otherwise this inspection is left to the discretion of the owner. Details of the inspection are listed in the inspection report of the Service Manual.

An Annual Inspection is required once each twelve calendar months to keep the Airworthiness Certificate in effect. It is the same as a 100 Hour Inspection except that it must be signed by an IA mechanic or a GADO representative. This inspection is required whether the aircraft is operated commercially or otherwise.

In place of the 100 Hour and Annual Inspection requirements, an aircraft may be inspected in accordance with a Progressive Inspection schedule which allows the work to be divided into smaller operations that can be accomplished in shorter time periods thereby allowing maximum utilization of the aircraft while complying with all FAA and factory recommended maintenance procedures.

## ALTERATIONS

If the owner of an aircraft desires to have it modified, FAA approval must be obtained prior to modification to insure that the proposed alteration does not violate the airworthiness of the aircraft. Any major alteration to the basic airframe or any aircraft system requires a STC and must be accomplished by licensed personnel.

## GROUND HANDLING

### 1.) Towing:

The airplane is most safely and easily moved on the ground by use of the nose wheel steering bar that is stowed in the baggage compartment. Towing lugs are incorporated as part of the nose gear fork. The three-view drawing in Section 1 of this Handbook shows the minimum clearances needed to hangar the airplane.

#### **\*\* CAUTION \*\***

When towing with power equipment, do not exceed the nose gear steering angle of 20 degrees either side of center or structural damage will result. To insure adequate propeller ground clearance, always observe recommended strut servicing procedures and tire inflation pressures.

### 2.) Parking and Mooring:

When parking the airplane, face it into the wind if possible and set the parking brake. Care should be exercised when setting parking brakes that are overheated or in cold weather when accumulated moisture can freeze the brake.

The airplane should be moored for immovability, security and protection. The following procedure is recommended.

- A.) Block the wheels, fore and aft.
- B.) Secure tie-down ropes to the wing tie-down rings and tail skid at approximately 45 degree angles to the ground. Use bowline or square knots; do not use slip knots.
- C.) Immobilize ailerons and stabilator.
- D.) Retract the wing flaps.
- E.) Close fresh air inlets.
- F.) Release the parking brake.
- G.) Install a pitot head cover.
- H.) Cabin, baggage compartment and storm window should be locked when the airplane is unattended.

### 3.) Jacking:

When jacking the airplane for landing-gear service or any other purpose, two hydraulic jacks and a tail stand should be used. The airplane is equipped with a jacking pad located on each main spar just outboard of the main landing gear. Approximately 300 to 400 pounds of ballast should be placed on the base of the tail stand before jacking the airplane.

## PREVENTATIVE MAINTENANCE

A certified pilot who owns or operates an aircraft not used as an air carrier is authorized to perform certain preventative maintenance described in FAR Part 43. A Service Manual should be obtained prior to performing any preventative maintenance to insure that proper procedures are followed.

Although such maintenance is allowed by law, each individual should determine whether he has the ability to perform the work. All other maintenance not outlined in FAR Part 43 is required to be accomplished by appropriately licensed personnel. A pilot can, however, perform any other maintenance on an aircraft if he works under the direct supervision of a properly certified mechanic.

If maintenance is performed, an entry must be made in the appropriate logbook. The entry should contain:

- 1.) Date the work was accomplished.
- 2.) Engine tachometer hours.
- 3.) Description of the work.
- 4.) Signature and certificate number of pilot performing the work.

Among the examples listed in FAR Part 43 considered as preventative maintenance are:

### 1.) Engine Care:

The engines may be cleaned with Stoddard solvent or the equivalent then thoroughly dried. Cleaning solutions should be used cautiously and should always be properly neutralized after use. Care should be taken to prevent cleaning fluids from entering the magnetos, starters, generators, alternators or vacuum pumps. Spark plugs should be cleaned and gapped every 50 hours of engine operation.

### 2.) Fuel Requirements:

The minimum grade of aviation fuel that can be used in the normally aspirated Twin Comanche is (blue) 91/96 octane (100 LL). The use of lower grades of fuel can cause serious engine damage in a short period of time, and use of fuel with lower grades of octane will invalidate the engine warranty.

The fuel system sumps should be drained daily to avoid the accumulation of contaminants such as water or sediment. Keep fuel tanks full after aircraft operation to minimize the chance of accumulation of water in the tanks due to condensation. The fuel strainer and injector screens should be checked and cleaned with acetone at 50 hour intervals.

### 3.) Oil Requirements:

Ashless dispersant aircraft engine oil must be used for all operating conditions. The oil capacity of each engine is 8 US quarts, but the operating level is normally kept a few quarts below maximum to reduce oil consumption. It is recommended that the oil and filter be changed and the oil screen be checked after every 50 hours of operation (25 hours if the engine is not equipped with an external full flow, spin-on oil filter) or every four months, whichever comes first. Under unfavorable conditions, the oil should be changed even sooner.

The following oil grades are required for the specified temperature:

Temperature	Single-Viscosity	Multi-Viscosity All Temps.
Above 60 Degrees F.	SAE 50	
Between 30 & 90 Degrees F.	SAE 40	
Between 00 & 70 Degrees F.	SAE 30	15W50 or 20W50
Below 10 Degrees F.	SAE 20	

During the oil and filter change it is advisable to inspect the overall condition of the engine compartment giving attention to items not normally checked during a preflight inspection.

Hoses, metal lines and fittings should be inspected for signs of oil or fuel leaks, and checked for abrasions, chafing, support and evidence of deterioration. Inspect the intake and exhaust systems for cracks, evidence of leakage and security of attachment. Inspect wiring for loose, broken or corroded terminals and any evidence of chafing, burning or heat deterioration.

### 4.) Battery Service:

The 12-volt, 35 ampere-hour battery is located either in the tail section aft of the baggage compartment or in the nose section of the fuselage. The stainless-steel battery box has a plastic drain tube which is normally closed off with a clamp and should be opened occasionally to drain off any accumulation of liquid.

The battery should be checked frequently for proper fluid level. Do not fill the battery above the baffle plates. Use only distilled water to replenish the electrolyte, never use acid.

A hydrometer can be used to determine the percentage of charge in the battery. If the battery is not up to proper charge, re-charge following the instructions located on the battery-box cover and in Section 9 (Supplements) of this Manual under the heading "Placards". Quick charges are not recommended.

### 5.) Air Filter Care:

The induction system air filters must be cleaned at least once every 50 hours and more often, even daily, when operating in dusty conditions. To clean the filters, tap gently to dislodge dust particles. Do not use compressed air or wash the filters in any liquid.

Replace each filter when it becomes excessively dirty or shows any damage. The usable life of a filter should be limited to one year or 500 hours of operation, whichever comes first.



## 6.) Propeller Care:

Before each flight, the propellers should be checked for nicks and corrosion. Small nicks produce stress concentrations and should be dressed out as soon as possible to prevent serious cracks or the loss of a propeller tip.

The propeller cylinder charge should be kept at the proper pressure. A placard specifying pressure readings is located inside the spinner caps and a table of pressure readings for both high and low pressure systems is listed in Section 1 (General) or Section 2 (Limitations) of this Manual under the heading "Placards". The cylinders should be charged with dry nitrogen to eliminate the possibility of any moisture collecting in the cylinders and freezing in cold weather or while operating the aircraft at altitude.

## 7.) Landing Gear Service:

Raise the airplane on jacks using procedures outlined in "Ground Handling" of this Section.

Wheels are removed by taking off the hub nut and withdrawing the axle bolt, the axle retainer clips and the axle. Main gear wheels also require the removal of four bolts from the brake assembly.

Mark the tire and wheel for re-installation. Tires are dismounted from the wheels by deflating the tube, then removing the wheel through-bolts, allowing the wheel halves to be separated.

Landing-gear strut exposure is measured with the airplane parked on a level surface with all fuel tanks full. Should the strut exposure be below that required, it should be determined if oil or air is needed. To do this, first raise the airplane on jacks.

To add oil, release the air in the strut allowing the oleo to compress fully. Remove the air-valve core and fill the unit through this opening by attaching a clear plastic hose to the valve stem and submerging the other end in a container of hydraulic fluid. Fully compress and extend the strut several times, thus drawing fluid from the container and expelling air from the strut chamber. When air bubbles cease to flow through the hose, compress the oleo to within 1/4 inch of full compression allowing excess oil to escape.

Air (or preferably dry nitrogen) is then added to the oleo struts with the aid of a strut pump. Re-insert the valve core, and with the airplane on the ground; inflate the strut to the proper position.

Wheel bearings should be replaced if they show signs of pitting or wear. If the bearings are serviceable, clean them thoroughly in solvent and re-pack with wheel-bearing grease.

## 8.) Brake Service:

The hydraulic brake system is filled with petroleum base MIL-H-5606 (red) hydraulic fluid. The fluid level should be checked after every 50 hours of airplane operation and replenished if necessary. The brake fluid reservoir is located on the firewall in the engine compartment.

No adjustment of brake clearances is necessary. If brake blocks become worn excessively, an A&P mechanic can easily replace them with new segments.

### **9.) Tire Care:**

For maximum service from the tires, keep them inflated to the proper pressures. When checking tire pressure, examine the tires for wear, cuts and bruises.

All wheels and tires are balanced before installation, and the relationship of tire, tube and wheel should be maintained when servicing. Unbalanced wheels can cause extreme vibration in the landing gear. In the installation of new components, it may be necessary to re-balance the wheels with the tires mounted.

### **10.) Lubrication:**

Lubrication at regular intervals is an essential part of the maintenance of any aircraft. The Service Manual contains charts showing lubrication points, types of lubricants to be used, and recommended frequency of application. Refer to the Service Manual for detailed lubrication instructions and methods.

## **CLEANING**

### **1.) Windshield and Window Care:**

The Plexiglas windshield and windows should be cleaned with an aircraft windshield cleaner following directions supplied with the cleaner. If windshield cleaner is not available, the Plexiglas can be cleaned by using water and a mild soap to remove dirt and loose particles. After cleaning, apply a thin coat of a good commercial wax. A severe scratch or mar can be removed with Plexiglas polish.

Oil and grease can be removed with kerosene or Stoddard solvent. Never use gasoline, benzine, alcohol, acetone, paint or lacquer thinner, or glass cleaner to clean the Plexiglas. These materials will attack the plastic and cause it to craze.

### **2.) Exterior Surfaces:**

The airplane should be washed with a mild soap and water. Harsh abrasives or alkaline detergents can cause scratches on painted and plastic surfaces or cause corrosion of metal. Oil and grease can be removed with kerosene or Stoddard solvent. Any good auto wax may be used to preserve painted surfaces.

### **3.) Interior Care:**

Clean side panels, seats and carpet with a stiff-bristle brush and vacuum cleaner. Soiled upholstery may be cleaned with a good upholstery cleaner suitable for the material. Carefully follow the instructions supplied with the product.

## **INTERMITTENT OPERATION PROCEDURE**

Airplanes that receive only intermittent operation should be flown once every two to three weeks for fifteen to thirty minutes. This practice is intended to prevent accumulation of corrosion on engine cylinder walls and keep the battery fully charged. It also helps to eliminate accumulations of water in the fuel system and air spaces in the engine, and helps prevent seals from drying out and leaking.

If the airplane is to be stored temporarily or indefinitely, refer to the Service Manual for proper storage procedures.

### **AIRPLANE FILE**

The pilot is responsible for insuring that the following papers are in order and in the aircraft for inspection by the proper authority.

#### **1.) To be displayed in the airplane at all times:**

- A.) Aircraft Airworthiness Certificate (FAA Form 8100-2)
- B.) Aircraft Registration Certificate (FAA Form 8050-3)
- C.) Aircraft Radio Station License (FCC Form 556)

#### **2.) To be carried in the airplane at all times:**

- A.) FAA Approved "Airplane Flight Manual"
- B.) Weight and Balance Data
- C.) Aircraft Equipment List
- D.) Repair and Alteration Form (FAA Form 337)

#### **3.) To be made available upon request:**

- A.) Airplane Logbook
- B.) Engine Logbook

#### **\*\* NOTE \*\***

The items listed are required by Federal Aviation Regulations of the United States of America. Owners of aircraft not registered in the United States should check with their country's aviation officials to determine their individual requirements.

## SECTION 9 - SUPPLEMENTS

PA-30 \* 3600 LBS GROSS WEIGHT

### Table of Contents

Introduction .....	9-2
Log of Supplements .....	9-2
Supplement 1 - Complete Operating and Limiting Airspeeds .....	9-3
Supplement 2 - Additional Placards .....	9-4
Supplement 3 - Official Comanche World Records .....	9-7
Supplement 4 - Comparison of Single Engine Comanches .....	9-8
Supplement 5 - Comparison of Twin Engine Comanches .....	9-9
Supplement 6 - Emergency Procedures Information .....	9-10
Supplement 7 - Normal Procedures Information .....	9-12



**SUPPLEMENT 1 - COMPLETE OPERATING AND LIMITING AIRSPEEDS**

**PA-30 \* 3600 LBS GROSS WEIGHT**

**V<sub>A</sub> - Design Maneuvering Speed / Turbulent Air Penetration Speed**

At 3,600 lbs Gross Weight .....	162 mph	141 kt
At 2,450 lbs Gross Weight .....	135 mph	117 kt

**\*\* CAUTION \*\***

Maneuvering speed decreases at lighter weight as the effects of aerodynamic forces become more pronounced. Linear interpolation may be used for intermediate gross weights. Maneuvering speed should not be exceeded while operating in rough air.

V <sub>APP</sub> - Final Approach to Landing Speed .....	95 mph	83 kt
V <sub>APP</sub> - Final Approach (W/Zero Degrees of Flap) .....	100 mph	87 kt
V <sub>APP</sub> - Final Approach (IFR Approach/Clean) .....	120 mph	104 kt
V <sub>C</sub> - Design Cruising Speed .....	183 mph	159 kt
V <sub>D</sub> - Demonstrated Diving Speed .....	256 mph	222 kt
V <sub>FE</sub> - Flap Extension Speed .....	125 mph	108 kt
V <sub>FE</sub> - Recommended .....	100 mph	87 kt
V <sub>H</sub> - Maximum Operating Speed .....	205 mph	178 kt
V <sub>IMD</sub> - Maximum Endurance Speed .....	100 mph	87 kt
V <sub>IMR</sub> - Maximum Range Speed .....	130 mph	113 kt
V <sub>LE</sub> - Landing-Gear Extended Speed .....	150 mph	130 kt
V <sub>LO</sub> - Landing-Gear Operation Speed .....	150 mph	130 kt
V <sub>LO</sub> - Recommended .....	125 mph	108 kt
V <sub>MCA</sub> - Single Engine Minimum Control Speed .....	90 mph	78 kt
V <sub>NE</sub> - Never Exceed Speed .....	230 mph	200 kt
V <sub>NO</sub> - Normal Operating Speed / Maximum Structural Cruising Speed .....	194 mph	169 kt
V <sub>R</sub> - Rotation Speed (W/Zero Degrees of Flap) .....	90 mph	78 kt
V <sub>S0</sub> - Stall Speed (Power Off - Full Flaps and Gear Extended) .....	69 mph	60 kt
V <sub>S1</sub> - Stall Speed (Power Off - Clean) .....	76 mph	66 kt
V <sub>SSE</sub> - Minimum Intentional Single Engine Speed .....	97 mph	84 kt
V <sub>X</sub> - Best Angle-of-Climb Speed (At Sea Level) .....	90 mph	78 kt
V <sub>XSE</sub> - Best Single Engine Angle-of-Climb Speed .....	94 mph	82 kt
V <sub>Y</sub> - Best Rate-of-Climb Speed (At Sea Level) .....	112 mph	97 kt
V <sub>YSE</sub> - Best Single Engine Rate-of-Climb Speed .....	105 mph	91 kt

**Emergency Airspeeds**

Best Engine-Out Glide Speed (Optimum) .....	110 mph	96 kt
Best Engine-Out Glide Speed (Endurance) .....	90 mph	78 kt

**Other Speeds**

Best En Route Rate-of-Climb Speed .....	130 mph	113 kt
Demonstrated Crosswind Component .....	20 mph	17 kt

## SUPPLEMENT 2 - ADDITIONAL PLACARDS NOT LISTED IN SECTION 2

The following is a list of placards that are not a part of the FAA approved placards that are listed in Section 2 (Limitations). They are provided here as they appear on the airplane.

### 1.) In Full View of the Pilot:

#### TAKEOFF CHECK LIST

COWL FLAPS -----	OPEN	ELECTRIC FUEL PUMPS -	ON
SEAT BELTS ----	FASTENED	MIXTURE CONTROLS ----	SET
CONTROLS -----	FREE	ALT. AIR -----	OFF
TRIM TAB -----	SET	PROPELLERS -----	SET
WING FLAPS -----	SET	ENGINE GAUGES ----	CHECK
FUEL ----	ON PROPER TANK	DOOR -----	LATCH

#### LANDING CHECK LIST

COWL FLAPS -----	OPEN	MIXTURE CONTROLS -----	SET
SEAT BELTS -----	FASTENED	PROPELLERS -----	SET
FUEL -----	ON PROPER TANK	LANDING GEAR DOWN ---	LOCKED
ELECTRIC FUEL PUMPS -----	ON	FLAPS -----	DOWN UNDER 100 MPH

### 2.) On Instrument Panel: (When Item is Installed)

#### WARNING

TO AVOID SPATIAL DISORIENTATION  
TURN OFF STROBE LIGHTS WHEN IN CLOSE  
PROXIMITY TO THE GROUND, OR DURING  
FLIGHT THROUGH CLOUDS, FOG OR HAZE.

### 3.) Inside Cabin Door:

ENGAGE LATCH BEFORE FLIGHT

### 4.) Adjacent to the Parking Brake Handle:

PARKING BRAKE - PULL ON

#### WARNING

NO BRAKING WILL OCCUR IF AIRPLANE  
BRAKES ARE APPLIED WHILE PARKING  
BRAKE HANDLE IS PULLED AND HELD.

**SUPPLEMENT 2 - ADDITIONAL PLACARDS (Cont.)**

**5.) Inside Landing Gear Motor Release Arm Access Door:**

INSTRUCTIONS FOR EMERGENCY EXTENSION OF LANDING GEAR

1. REDUCE POWER - AIRSPEED NOT TO EXCEED 100 M.P.H.
2. PLACE LANDING GEAR SELECTOR SWITCH IN CENTER "OFF" POSITION.
3. DISENGAGE MOTOR - RAISE MOTOR RELEASE ARM AND PUSH FORWARD THROUGH FULL TRAVEL.
4. EXTEND EMERGENCY GEAR HANDLE TO FULL LENGTH.
5. ROTATE HANDLE FORWARD FULL TRAVEL TO EXTEND LANDING GEAR. GREEN LIGHT ON PANEL INDICATES LANDING GEAR DOWN AND LOCKED.

DO NOT RE-ENGAGE MOTOR IN FLIGHT

**6.) On Brake Fluid Reservoir:**

BRAKE FLUID  
HYDRAULIC OIL  
MIL-H-5606

**7.) Adjacent to Fuel Filler Caps:**

MAIN FUEL	AUX. FUEL
91-96 OCTANE MIN. TANK CAPACITY 30 GAL. USABLE CAPACITY 27 GAL. FILLING INSTRUCTIONS TO OBTAIN MAXIMUM CAPACITY, AIRPLANE MUST BE APPROXIMATELY LEVEL WITH LANDING GEARS EQUALLY EXTENDED	91-96 OCTANE MIN. CAPACITY 15 GAL.

**8.) Adjacent to Oil Filler Cap:**

ENGINE OIL SPEC.	
VISCOSITY	OUTSIDE AIR TEMP.
SAE 50	ABOVE 40 DEGREES F.
SAE 30	BELOW 40 DEGREES F.
SAE 20	BELOW 10 DEGREES F.

OIL CAPACITY 8 QTS.



**SUPPLEMENT 2 - ADDITIONAL PLACARDS (Cont.)**

**9.) On Battery Compartment Cover:**

ALWAYS ADD WATER - NEVER ADD ACID  
DO NOT FILL ABOVE BAFFLES  
FULLY CHARGED SPECIFIC GRAVITY 1.275  
CHARGING RATE  
START 4 AMPERES - FINISH 2 AMPERES  
MAXIMUM TEMPERATURE ON CHARGE 120 DEGREES F.  
KEEP CHARGED TO PREVENT FREEZING

**10.) Inside The Propeller Spinner Cap:**

**PROPELLER CHAMBER PRESSURE REQUIREMENTS  
(HIGH PRESSURE TYPE)**

TEMP. DEGREES F.	PRESS. (PSI)	TEMP. DEGREES F.	PRESS. (PSI)
100	188	30	165
90	185	20	162
80	182	10	159
70	178	0	154
60	175	-10	152
50	172	-20	149
40	168	-30	146

**PROPELLER CHAMBER PRESSURE REQUIREMENTS  
(LOW PRESSURE TYPE)**

TEMP. DEGREES F.	PRESS. (PSI)
100	53
70	50
40	47
10	44
-20	42

NOTE: DO NOT CHECK PRESSURE WITH PROPELLER IN FEATHER POSITION.

**11.) At Each Oxygen Outlet: (When Item is Installed)**

NO SMOKING WITH OXYGEN IN USE

**SUPPLEMENT 2 - ADDITIONAL PLACARDS (Cont.)**

**12.) Above Alternate Static Source Valve: (When Item is Installed)**

ALTERNATE STATIC SOURCE  
PULL AFT TO OPEN

INSTRUCTIONS FOR USE OF ALTERNATE STATIC SOURCE

1. IN CASE OF STATIC PRESSURE TUBE MALFUNCTION DUE TO ICE OR OTHER OBSTRUCTIONS CLOSE WINDOW AND ACTIVATE ALTERNATE STATIC SOURCE VALVE.
2. THE FOLLOWING AIRSPEEDS APPLY WHEN ALTERNATE STATIC SOURCE IS USED.

INDICATOR READS	ACTUAL
104 MPH IAS	100 MPH IAS
140 MPH IAS	130 MPH IAS
163 MPH IAS	150 MPH IAS
185 MPH IAS	170 MPH IAS

**13.) On Wing Flap Indicator:**

TAKEOFF	15°
LANDING	27°

**14.) On The Instrument Panel:**

CAUTION

THIS AIRPLANE IS EQUIPPED WITH A MANUALLY CONTROLLED ALTERNATE ENGINE INDUCTION AIR SYSTEM. ALTERNATE AIR IS AVAILABLE ONLY BY PULLING "ALT AIR" CONTROL FULL ON.

### SUPPLEMENT 3

## OFFICIAL WORLD RECORDS HELD BY MAX CONRAD IN COMANCHE AIRCRAFT

World class records recognized by the Federation Aeronautique Internationale and the National Aeronautic Association.

Category: C (Airplanes)  
Group: 1 (Piston Engine)  
Class: 1 (Landplanes)

#### WORLD RECORD #1

Sub Class: D - 1,750 to 3,000 kg (3,858 to 6,614 lb)  
Record: Distance in a Straight Line (Non-Stop)  
From: Casablanca, Morocco - To: Los Angeles, California  
Distance: 7,668 sm \* 6,663 nm \* 12,338 km  
Time: 58 Hours, 38 Minutes  
Date: June 02, 1959  
Airplane Model: Piper Comanche PA-24-250

#### WORLD RECORD #2

Sub Class: C - 1,000 to 1,750 kg (2,204 to 3,858 lb)  
Record: Distance in a Straight Line (Non-Stop)  
From: Casablanca, Morocco - To: El Paso, Texas  
Distance: 6,967 sm \* 6,053 nm \* 11,212 km  
Time: 56 Hours, 26 Minutes  
Date: November 24, 1959  
Airplane Model: Piper Comanche PA-24-180

#### WORLD RECORD #3

Sub Class: C - 1,000 to 1,750 kg (2,204 to 3,858 lb)  
Record: Distance in a Closed Circuit (Non-Stop)  
From: Minneapolis, Minnesota - To: Chicago, Illinois - To:  
Des Moines, Iowa - To: Minneapolis, Minnesota  
Distance: 6,921 sm \* 6,014 nm \* 11,139 km  
Time: 60 Hours, 10 Minutes  
Date: July 14, 1960  
Airplane Model: Piper Comanche PA-24-180

#### WORLD RECORD #4

Sub Class: E - 3,000 to 6,000 kg (6,614 to 13,228 lb)  
Record: Distance in a Straight Line (Non-Stop)  
From: Capetown, South Africa - To: St. Petersburg, Florida  
Distance: 7,879 sm \* 6,845 nm \* 12,677 km  
Time: 56 Hours, 8 Minutes  
Date: December 24, 1964  
Airplane Model: Piper Twin Comanche PA-30

**SUPPLEMENT 4 - COMPARISON OF PRODUCTION MODEL SINGLE ENGINE COMANCHES**

**SPECIFICATIONS**

Type Designation	PA-24-180	PA-24-250	PA-24-250	PA-24-250	PA-24-250	PA-24-260	PA-24-260	PA-24-260B	PA-24-260C	PA-24-260T	PA-24-400
Year(s) Manufactured	1957-64	1958-60	1961	1962-64	1962-64	1965	1966-68	1966-68	1969-72	1970-72	1964-65
Approximate Number Built	1,143	1,526	407	604	300	N/A	504	225	25.8	N/A	146
Length (ft)	24.7	24.9	24.9	24.9	25.0	25.0	25.3	25.3	25.8	25.8	25.7
Height (ft)	7.3	7.3	7.3	7.3	7.5	7.5	7.5	7.5	7.5	7.5	7.8
Wing Span (ft)	36.0	36.0	36.0	36.0	36.0	36.0	36.0	36.0	36.0	36.0	36.0
Powerplant (Lycoming)	O-360-A	O-540-A	O-540-A	O-540-A	O-540-C	O-540-D	O-540-D	O-540-E	O-540-N	O-540-R	IO-720-A
BHP-RPM	180-2700	250-2575	250-2575	250-2575	250-2575	260-2700	260-2700	260-2700	260-2700	260-2700	400-2650
TBO (hr)	2,000	2,000	2,000	2,000	2,000	2,000	2,000	2,000	2,000	1,800	1,800
Wing Area (sq ft)	178	178	178	178	178	178	178	178	178	178	178
Wing Loading (lb/sq ft)	14.3	15.7	16.3	16.3	16.3	16.3	17.4	17.4	18.0	18.0	20.2
Power Loading (lb/bhp)	14.2	11.2	11.6	11.6	11.2	11.2	11.9	11.9	12.3	12.3	9.0
Seats	4	4	4	4	4	4	4-6	4-6	4-6	4-6	4
Fuel Capacity (US gal)	60	60	90	90	90	90	90	90	90	90	130
Baggage Capacity (lb)	100/200	200	200	200	200	200	250	250	250	250	200
Gross Weight (lb)	2,550	2,800	2,900	2,900	2,900	2,900	3,100	3,100	3,200	3,200	3,600
Max Landing Weight (lb)	2,550	2,800	2,900	2,900	2,900	2,900	2,945	2,945	3,040	3,040	3,600
Standard Empty Weight (lb)	1,455	1,600	1,630	1,690	1,690	1,700	1,728	1,728	1,773	1,894	2,110
Max Useful Load (lb)	1,095	1,200	1,270	1,210	1,210	1,200	1,372	1,372	1,427	1,306	1,490
Max Useful Load W/Full Fuel (lb)	735	840	730	670	670	660	832	832	887	766	710

**PERFORMANCE**

Fuel Flow @ 75% Power (gph)	10.0	14.0	14.0	14.0	13.7	14.1	14.1	14.5	14.1	14.1	20.0
Fuel Flow @ 55% Power (gph)	7.4	10.3	10.3	10.3	11.0	11.4	11.4	10.7	11.4	11.4	15.5
Endur @ 75% Power W/45 min Rsv (hr)	5.2	3.7	5.7	5.7	5.9	5.7	5.7	5.5	5.7	5.3	5.6
Endur @ 55% Power W/45 min Rsv (hr)	7.1	5.1	7.8	7.8	7.3	7.1	7.1	7.5	7.1	6.7	7.2
Range @ 75% Power W/45 min Rsv (sm)	832	670	1,032	1,032	1,068	1,055	1,037	1,001	1,055	1,177	1,193
Range @ 55% Power W/45 min Rsv (sm)	994	836	1,279	1,279	1,197	1,193	1,157	1,223	1,228	1,313	1,426
Cruise Speed @ 75% Power (mph)	160	181	181	181	181	185	182	182	185	222	213
Cruise Speed @ 55% Power (mph)	140	164	164	164	164	168	163	163	173	196	198
Rate of Climb (ft/min)	910	1,350	1,350	1,350	1,350	1,500	1,370	1,370	1,320	1,320	1,600
Climb Gradient (ft/nm)	658	890	890	890	890	938	856	856	817	817	923
Ceiling (ft)	21,000	22,000	22,000	22,000	22,000	22,000	21,400	21,400	21,000	25,000	21,000
Takeoff Distance, Ground Run (ft)	1,370*	1,095	1,180	1,180	1,180	1,090	1,260	1,260	1,360	1,360	980
Total Over a 50 ft Obstacle (ft)	2,250*	1,575	1,675	1,675	1,675	1,540	1,725	1,725	1,800	1,800	1,500
Landing Distance, Ground Roll (ft)	460	885	920	920	920	920	925	925	965	965	1,180
Total Over a 50 ft Obstacle (ft)	1,340	1,390	1,420	1,420	1,420	1,420	1,435	1,435	1,465	1,465	1,820

**LIMITING AND RECOMMENDED AIRSPEEDS (MPH)**

V <sub>A</sub> - Design Maneuvering Speed	154	144	144	144	144	144	144	144	150	150	160
V <sub>FE</sub> - Max Flap Extension Speed	100/125	125	125	125	125	125	125	125	125	125	125
V <sub>H</sub> - Max Operating Speed	167	190	190	190	190	195	194	194	195	233	223
V <sub>LO</sub> - Max Gear Operation Speed	125/150	150	150	150	150	150	150	150	150	150	150
V <sub>NE</sub> - Never Exceed Speed	202	227	227	227	227	227	227	227	227	227	250
V <sub>NO</sub> - Normal Operation Speed	160	180	180	180	180	180	180	180	180	180	210
V <sub>R</sub> - Rotation Speed *	75	85	85	85	85	85	85	85	85	85	90
V <sub>SO</sub> - Stall Speed (Landing Configuration)	60	64	62	63	63	63	67	67	67	67	68
V <sub>S1</sub> - Stall Speed (Clean)	67	71	71	71	71	71	75	75	77	77	78
V <sub>X</sub> - Best Angle-of-Climb Speed	75	84	85	85	85	85	87	87	88	88	92
V <sub>Y</sub> - Best Rate-of-Climb Speed	96	105	105	105	105	110	111	111	112	112	120
Engine-Out Glide Speed (Optimum)	95	100	100	100	100	100	105	105	105	105	115

\* = With Zero Degrees of Flap N/A = Information Not Available

**SUPPLEMENT 5 - COMPARISON OF PRODUCTION MODEL TWIN COMANCHES**

**SPECIFICATIONS**

Type Designation	PA-30	PA-30T	PA-39	PA-39T
Years Manufactured	1963-69	1964-69	1970-72	1970-72
Approximate Number Built	2,000	N/A	155	N/A
Length (ft)	25.2	25.2	25.2	25.2
Height (ft)	8.2	8.2	8.2	8.2
Wing Span (ft)	36.0	36.8	36.0	36.8
Powerplant (Lycoming)	IO-320-B	IO-320-C	IO-320-B	IO-320-C
Ratings (bhp-rpm)	160-2700	160-2700	160-2700	160-2700
TBO (hr)	2,000	1,800	2,000	1,800
Wing Area (sq ft)	178	178	178	178
Wing Loading (lb/sq ft)	20.2	20.9	20.2	20.9
Power Loading (lb/bhp)	11.3	11.7	11.3	11.7
Seats	4-6	4-6	4-6	4-6
Fuel Capacity (US gal)	90	120	90	120
Baggage Capacity (lb)	200-250	200-250	250	250
Gross Weight (lb)	3,600	3,725	3,600	3,725
Maximum Landing Weight (lb)	3,600	3,725	3,600	3,725
Standard Empty Weight (lb)	2,207	2,384	2,270	2,416
Maximum Useful Load (lb)	1,393	1,341	1,330	1,309
Maximum Useful Load W/Full Fuel (lb)	853	621	790	589

**PERFORMANCE**

Fuel Flow @ 75% Power (gph)	17.2	17.2	17.2	17.2
Fuel Flow @ 65% Power (gph)	15.2	15.2	15.2	15.2
Fuel Flow @ 55% Power (gph)	13.4	13.4	13.4	13.4
Range @ 75% Power W/45 min Reserve (sm)	892	1,316	892	1,316
Range @ 65% Power W/45 min Reserve (sm)	967	1,353	967	1,353
Range @ 55% Power W/45 min Reserve (sm)	1,015	1,386	1,015	1,386
Endurance @ 75% Power W/45 min Reserve (hr)	4.6	5.9	4.6	5.9
Endurance @ 65% Power W/45 min Reserve (hr)	5.2	6.7	5.2	6.7
Endurance @ 55% Power W/45 min Reserve (hr)	5.9	7.7	5.9	7.7
Cruise Speed @ 75% Power (mph)	194	223	194	223
Cruise Speed @ 65% Power (mph)	186	202	186	202
Cruise Speed @ 55% Power (mph)	172	180	172	180
Rate of Climb(ft/min)	1,460	1,290	1,460	1,290
Single-Engine Rate of Climb(ft/min)	260	165	260	165
Climb Gradient (ft/nm)	903	798	903	798
Service Ceiling (ft)	18,600	25,000	18,600	25,000
Absolute Ceiling (ft)	20,000	25,000	20,000	25,000
Single-Engine Service Ceiling (ft)	5,800	8,800	5,800	8,800
Single-Engine Absolute Ceiling (ft)	7,100	12,600	7,100	12,600
Accelerate - Stop Distance (ft)	3,000	3,100	2,470	2,560
Takeoff Distance, Ground Run (ft)	1,250	1,300	940	990
Total Over a 50 ft Obstacle (ft)	2,160	2,285	1,530	1,590
Landing Distance, Ground Roll (ft)	700	700	700	725
Total Over a 50 ft Obstacle (ft)	2,100	2,155	1,870	1,900

**LIMITING AND RECOMMENDED AIRSPEEDS (MPH)**

V <sub>A</sub> - Design Maneuvering Speed	162	162	162	162
V <sub>FE</sub> - Maximum Flap Extension Speed	125	125	125	125
V <sub>H</sub> - Maximum Operating Speed	205	240	205	240
V <sub>LO</sub> - Maximum Gear Operation Speed	150	150	150	150
V <sub>MCA</sub> - Minimum Control Speed W/Critical Engine Inoperative	90	90	80	80
V <sub>NE</sub> - Never Exceed Speed	230	230	230	230
V <sub>NO</sub> - Normal Operation Speed	194	194	194	194
V <sub>R</sub> - Rotation Speed	90	90	90	90
V <sub>S0</sub> - Stall Speed (Landing Configuration)	69	69	70	70
V <sub>S1</sub> - Stall Speed (Clean)	76	76	76	76
V <sub>SSE</sub> - Minimum Intentional Single-Engine Speed	97	97	97	97
V <sub>X</sub> - Best Angle-of-Climb Speed	90	90	90	90
V <sub>XSE</sub> - Best Single-Engine Angle-of-Climb Speed	94	94	94	94
V <sub>Y</sub> - Best Rate-of-Climb Speed	112	112	112	112
V <sub>YSE</sub> - Best Single-Engine Rate-of-Climb Speed	105	105	105	105
Both Engine Out Glide Speed (Optimum)	110	110	110	110

N/A = Information Not Available

## SUPPLEMENT 6 - EMERGENCY PROCEDURES INFORMATION

### Engine-Out Glide Speed:

During the era when Piper Aircraft was producing the Twin Comanche, no flight tests were conducted to determine the best (both) engine-out glide speed for the airplane. The one exception to this was the Turbo 260C, and it is estimated that only two dozen were built. The figures in this Handbook have been determined by the following method:

Use of the term "best" is a misnomer, however, best glide speed is most generally referred to as the optimum, or maximum-range glide speed, and results in the best glide ratio.

Best glide ratio is obtained when the wing is operated at an angle of attack that will produce the best lift-drag ratio, or  $L/D_{max}$ . This is basically true of the airplane's best rate-of-climb speed also.

Theoretically, optimum glide speed will be close to the best rate-of-climb speed, but included among the variables in the mathematical formulas related to the best rate-of-climb speed are the elements of thrust and drag. Because efficiency is reduced by the dead engines (thrust is now zero), and airplane drag is increased (even when the propellers are feathered), optimum glide speed can be expected to be a value somewhat less than  $V_Y$ .

The generally accepted formula for estimating the both-engine-out glide speed in a typical reciprocating-engine, propeller-driven, light twin airplane when it is not provided by the aircraft manufacturer is to multiply 1.5 times  $V_{S1}$ .

$V_Y$  for the Twin Comanche both with and without wingtip fuel tanks is 112 mph, and 1.5 times  $V_{S1}$  is 114 mph. Therefore, for the purposes of this Handbook, the best both-engine-out glide speed for the Twin Comanche at 3725 lbs and 3600 lbs maximum allowable gross weight has been established to be 110 mph IAS.

Glide testing done on sub-sonic aircraft by the military has produced graphs which show that a five-percent deviation from best glide speed will not cause a significant reduction in glide ratio. This means that if this figure is not exactly correct, the error is not enough to produce a measurable difference.

In addition, since optimum glide speed decreases as the airplane's gross weight decreases, this fact also allows the specifying of glide speeds for a range of gross weights. An example of when use of a lower glide speed applies would be a solo pilot who is totally out of fuel. In this case the airplane would be several hundred pounds below maximum allowable gross weight, and use of an airspeed below 110 mph IAS would be appropriate.

Airplane Gross Weight	Suggested Glide Speed
3725 lbs .....	110 mph (96 kt)
3600 lbs .....	110 mph (96 kt)
3400 lbs .....	106 mph (92 kt)
3200 lbs .....	102 mph (87 kt)
3000 lbs .....	98 mph (85 kt)

## SUPPLEMENT 6 - EMERGENCY PROCEDURES INFORMATION (Cont.)

### Engine-Out Glide Speed: (Cont.)

Equally important in any discussion of both engine-out glide speed is the best endurance, or minimum sink glide speed. This airspeed is used when glide range is not important (such as when directly over an airport at an altitude of several thousand feet AGL), and the possibility of re-starting the engines is a factor (such as when engine failure is due to having run the selected fuel tanks dry, but then starting difficulty is experienced after switching tanks).

Best endurance glide speed is typically equal to 75 percent of the optimum glide speed. However, there is a problem associated with this figure due to the fact that this airspeed is close to the airplane's stall speed. This condition could become dangerous for the pilot who is otherwise distracted by the emergency.

For this reason, the generally accepted formula for estimating best endurance glide speed is to multiply 1.2 times  $V_{S1}$ . This results in an airspeed of 90 mph IAS for the Twin Comanche.

It is suggested that at approximately 1000 feet AGL, the pilot should establish optimum glide speed in preparation of landing. The additional airspeed will provide maneuvering control, and a safety margin to counter any unexpected low-level wind shear. Also, if the airplane is operated close to stall, there may be insufficient airspeed with which to flare on landing.

For the individual who wants a more in-depth knowledge of this subject, the books by Kershner and Hurt referenced in the Preamble of this Handbook are recommended reading.

### Glide Ratio:

Both-engines-out glide ratio for the Twin Comanche with landing gear and flaps retracted and propellers windmilling is 10 to 1, or approximately two miles of gliding distance for each 1,000 feet of altitude above the terrain. Drag is substantially reduced when the propellers are feathered, and glide ratio improves to 13 to 1. When the landing gear is extended, drag is increased and glide ratio is radically reduced to approximately 7 to 1. For this reason, it is suggested that the landing gear and flaps not be extended in most engine-out emergencies until over the threshold of the landing area. Landing gear down operating time is approximately 7 seconds.

## SUPPLEMENT 7 - NORMAL PROCEDURES INFORMATION

### Best Range Speed:

High speed and the resultant savings in time is one of the major reasons for using an aircraft as transportation. In recent years, however, increasing fuel costs have led to an interest in efficiency to minimize fuel usage. In addition, every year there are a large percentage of accidents caused by fuel exhaustion and poor fuel management. Moreover, there can be unexpected headwinds or adverse weather conditions that result in a much longer flight than anticipated. For all of these reasons, a pilot will want to give consideration to getting the maximum range possible from an aircraft. Range and endurance records established by Max Conrad in various models of the Comanche are substantial, and are listed in this Handbook.

Tests were not conducted by Piper Aircraft to determine the airspeeds that will result in maximum range ( $V_{IMR}$ ) and maximum endurance ( $V_{IMD}$ ) for the Twin Comanche. In the absence of this information, the following is provided:

The aerodynamic principals that are involved in determining maximum gliding distance for a typical reciprocating-engine, propeller-driven, light twin airplane (see Emergency Procedures Information in this section) are the same that are used in determining its maximum range. Maximum range is obtained when the wing is operated at the angle of attack that produces the best lift-drag ratio or  $L/D_{max}$ . This is basically true of the best rate-of-climb speed, but  $V_{IMR}$  can be expected to be some value higher than  $V_Y$  because other factors are involved such as the lift coefficient of the wing, and the propulsive efficiency of the engine/propeller combination.

A common method of estimating the best range speed when it is not provided by the aircraft manufacturer is to use a figure that is approximately 15 percent greater than  $V_Y$  which for the Twin Comanche is equal to 129 mph. Another generally accepted formula for estimating  $V_{IMR}$  is to multiply 1.7 times  $V_{S1}$ . This also results in a figure of 129 mph. Studies have shown that a five-percent deviation from optimum range speed will not cause a significant variation in the range obtained. For this reason, the figure of 130 mph is suggested. This figure is applicable for the airplane at full gross weight and will decrease at a rate of approximately two mph for every 100 pound decrease in weight.

Along with airspeed, other factors to consider when there is a need to obtain maximum range are:

- 1.) Decrease the aircraft weight and avoid headwinds.
- 2.) If possible, redistribute any movable weight within the airplane to obtain the most rearward center of gravity within C.G. limits. This will reduce drag and increase efficiency.
- 3.) Reduce rpm so the engines will consume less fuel. Operation at low rpm will typically result in a relatively high manifold pressure, but this is not a problem as long as the engines are operated within allowable rpm and manifold pressure limits as designated in the Lycoming charts.
- 4.) Adjust the mixtures to the lean side of peak EGT. This condition is also acceptable because the power developed by the engines can be expected to be equal to 40 percent and less.



## SUPPLEMENT 7 - NORMAL PROCEDURES INFORMATION (Cont.)

### Best Range Speed: (Cont.)

#### \*\* CAUTION \*\*

Never use low power settings during an engine's break-in period. This practice will result in glazed cylinder walls and high oil consumption. Also, routine operation at low power and the resultant low operating temperature can lead to problems such as high oil consumption and sticking valves. These problems are amplified during cold weather operation, so the practice of cruising at low power settings is not recommended as a standard operating procedure.

### Best Endurance Speed:

The most common application where there is a need to obtain maximum endurance from the airplane is when directed into a holding pattern by Air Traffic Control. Best endurance speed is typically equal to 75 percent of the best range speed. The generally accepted formula for estimating best endurance speed is to multiply 1.3 times  $V_{S1}$ . Seventy-five percent of 130 mph is 98 mph, and 1.3 times  $V_{S1}$  is 99 mph. Therefore, for the purposes of this Handbook, maximum endurance airspeed is suggested to be 100 mph.

An airspeed of 100 mph is not practical in many applications due to the increased angle of attack at this relatively low speed which results in high induced drag and poor aerodynamic efficiency. In addition, an airspeed this low will result in comparatively sluggish control response requiring the pilot to have to work that much harder to control the airplane. For these reasons, the pilot may wish to operate off-optimum when seeking to extend the airplane's endurance. Since the most common application of the use of the best endurance speed is the holding pattern, it is suggested that the airplane's IFR approach speed of 120 mph be used.

Another factor to consider is the fact that maximum endurance is obtained at sea level, so it is advisable to use the lowest practical altitude. Also, wind is not a factor with endurance, but turbulence should be avoided, if possible, because of the drag that turbulence will induce.

These are the major factors involved in extending an aircraft's range and endurance, but they do not provide actual figures that the pilot can expect to obtain. It is therefore recommended that the aircraft owner/operator conduct his own tests using these techniques to determine the specific fuel consumption that can be expected from the airplane. For the individual who wants a more in-depth knowledge of this subject, the books by Kershner and Hurt referenced in the Preamble of this Handbook are recommended reading.

### IFR Approach Speed:

There are several factors involved in IFR approach stability, most of which are beyond the scope of this discussion. The aircraft needs to be stable at all times during an IFR approach, and one of the most important factors contributing to approach stability is the aircraft's speed. The airspeed chosen by the pilot when making an IFR approach is dependent on several factors.

## SUPPLEMENT 7 - NORMAL PROCEDURES INFORMATION (Cont.)

### IFR Approach Speed: (Cont.)

Among the most significant factors to consider are:

- 1.) Requirements and demands of single-pilot IFR. FAR Part 135 specifies that an auto-pilot is required when operating single-pilot IFR. The rules in Part 135 are not required of most private pilots, but they are nonetheless a good guideline. Therefore the limitations of the auto-pilot should be considered. Most auto-pilots approved for use in the Twin Comanche have a minimum airspeed limitation of 110 mph, so this figure is used to define the low end of airspeeds for consideration.
- 2.) Air Traffic Control requirements and the pilot's responsibility to expedite traffic flow. The pilot making an instrument approach will comply with ATC airspeed instructions in most circumstances, however, prior to reaching the Final Approach Fix/Point the pilot will want to be established at the airspeed normally used to make the final approach. Since the choice of this airspeed is left to the pilot's discretion, choice of a reasonably high speed is preferable.
- 3.) Airplane controllability. Aircraft stability is greater the higher the airspeed and this reduces the pilot's work load. For this reason the highest airspeed within the aircraft's limitations is preferred.
- 4.) Limitations of the aircraft. The Comanche has a wing-flap operating limitation of 125 mph so it is this figure that is used to define the high end of airspeeds for consideration. Choice of an airspeed just below this limitation gives a buffer in the event of any deviation in airspeed control, and some pilots prefer the option of using partial flaps on approach.
- 5.) Transition from approach configuration to touchdown configuration. FAR Part 91 requires that the pilot must be able to use normal maneuvers to land, and FAR Part 135 requires that the airplane must touch down within the touchdown zone which is defined as the first 3,000 ft of the runway. Under conditions of hard IFR (200 ft ceiling, and 1/2 mile visibility) and a 5,000 ft runway, it is not likely that the pilot will be able to transition the airplane, get it on the ground, and land it safely if the airspeed is much above 125 mph. Consistency is important in the IFR environment, for this reason the instrument pilot should be prepared for these minimal conditions even though they are not what he faces with every instrument approach and landing. Operating in conditions of hard IFR into an airport with a relatively short runway is not the time to be improving your proficiency.

Therefore, for the purposes of this Handbook, the IFR approach speed for the Twin Comanche has been established to be 120 mph.

## SECTION 10 - SAFETY INFORMATION

PA-30 \* 3600 LBS GROSS WEIGHT

### Table of Contents

Introduction .....	10-2
General Sources of Information .....	10-2
Pilot Physiology .....	10-3
Medical Certification .....	10-3
Fatigue .....	10-3
Stress .....	10-3
Emotion .....	10-4
Illness .....	10-4
Medication .....	10-4
Alcohol .....	10-4
Hypoxia .....	10-5
Carbon Monoxide Poisoning .....	10-6
Scuba Diving .....	10-6
Aerobatic Flight .....	10-6
Spatial Disorientation .....	10-7
Illusions in Flight .....	10-8
Pilot Proficiency .....	10-9
Preflight Preparation .....	10-9
Fuel Management .....	10-10
Stalls/Spins .....	10-12
Wake Turbulence .....	10-14
Night Flying .....	10-14
Mountain Flying .....	10-16
Inflight Collision Avoidance .....	10-17
Multi-Engine Airplane (Single-Engine Procedures) .....	10-18
Weather .....	10-21
The Weather Briefing .....	10-21
Wind Shear .....	10-22
Thunderstorm Avoidance .....	10-22
Icing .....	10-24
Additional Information .....	10-26

## SAFETY INFORMATION

PA-30 \* 3600 LBS GROSS WEIGHT

### INTRODUCTION

This section provides tips and safety information of particular importance in the operation of an airplane. The FAA recommends that the pilot periodically review the airplane's POH to remain familiar with its contents and help ensure safe operation of the airplane. Familiarity with the information contained in the POH is considered essential to the safe and efficient operation of the airplane.

There are several safety related items that every pilot should consider before any flight. Among them are the pilot's physical condition and proficiency, the airworthiness of the airplane, airplane loading, the weather, the flight's route and fuel required, en route airport facilities, and en route navigational facilities. Failure to consider these items could result in personal injury, fatalities, and/or substantial damage to property.

### GENERAL SOURCES OF INFORMATION

Subjects in this section are composed of excerpts from various FAA publications which pertain to flying safety. The information contained herein is general in nature and not limited to any particular make or model of aircraft. The Pilot's Operating Handbook and FAA Approved Airplane Flight Manual is the proper source for information and operating procedures on a specific airplane. It is also recommended that the pilot be familiar with the following publications in order to have a greater understanding of the subjects related to flight safety.

- 1.) **Federal Aviation Regulations (FAR)** -- Regulations that govern the aviation community are available locally or through the Superintendent of Documents at the U.S. Government Printing Office, Washington, DC. The Regulations are sold as individual parts. The more frequently amended parts are sold by subscription service, and less active parts are sold on a one-time basis. Information about changes in the Regulations are published in AC 00-44 (Status of Federal Aviation Regulations).
- 2.) **Airman's Information Manual (AIM)** -- This manual is intended to provide the pilot with basic flight information and information on Air Traffic Control procedures. It also contains items of interest to pilots concerning medical physiology, flight safety, accident and hazard reporting procedures, IFR procedures, and an extensive pilot/controller glossary to name only a few. This manual is revised on 6 month intervals and is available locally or through the Superintendent of Documents.
- 3.) **Airworthiness Directives (AD)** -- These are notices issued by the FAA for the purpose of amending the certification of an aircraft. No aircraft may be operated except in accordance with the requirements of any and all ADs that have been issued on it.
- 4.) **Notices To Airman (NOTAMS)** -- This is a compilation of information considered essential to the safety of flight. It also includes regulatory matters issued to establish restrictions to flight or amend Aeronautical Charts or Instrument Approach Procedures. This publication is issued every 2 weeks and is made available locally and by subscription from the Superintendent of Documents.

- 5.) **Advisory Circulars (AC)** -- These are issued by the FAA to disseminate non-regulatory material of interest to the aviation community. AC 00-2 (Advisory Circular Checklist) contains a listing of ACs and covers a wide range of subjects. AC 00-2 is issued every 4 months by the U.S. Department of Transportation, Publications Section, Washington, DC.
- 6.) **Airport Facility Directory** -- This directory contains information on airports, frequencies for communications, navigational aids, instrument landing systems, VOR receiver check points, Flight Service telephone numbers, Air Route Traffic Control Center frequencies and other information essential to air navigation. This directory is available locally or from the National Ocean Service (NOS), NOAA Distribution Branch, Riverdale, Maryland.

## **PILOT PHYSIOLOGY**

### **1.) Medical Certification:**

All pilots, except those flying gliders and free air balloons, must possess a valid Medical Certificate in order to exercise the privileges of their Airman's Certificate. The standards for medical certification are contained in FAR Part 67. It is the responsibility of the pilot to consider the status of his personal health when planning a flight. A pilot should never fly if it is known that a condition exists that would void the standards of the pilot's Medical Certificate.

### **2.) Fatigue:**

Fatigue is one of the most treacherous hazards to flight safety because it may not become apparent to a pilot until serious errors have been made. Fatigue can be classified as both acute and chronic. Acute fatigue is the tiredness felt after long periods of physical and mental activity. This includes strenuous muscular effort, heavy mental workload, strong emotional pressure, and monotony and lack of sleep. Consequently, coordination and alertness, so vital to safe pilot performance, can be reduced. Acute fatigue is prevented by adequate rest, adequate sleep, regular exercise, and proper nutrition.

Chronic fatigue occurs when there is not enough time for full recovery between episodes of acute fatigue. Performance continues to decline and judgment becomes impaired to the point that unwarranted risks may be taken. Recovery from chronic fatigue requires a prolonged period of rest.

### **3.) Stress:**

Stress from the pressures of everyday living can impair pilot performance in very subtle ways. Difficulties, both personal and professional, can occupy thought processes enough to markedly decrease alertness. The distraction precipitated by stress can so interfere with judgment that unwarranted risks will be taken. Stress coupled with fatigue can be an extremely hazardous combination. When more than the usual difficulties in everyday life are being experienced, a pilot should consider postponing flying until these difficulties are satisfactorily resolved.

#### **4.) Emotion:**

Emotionally upsetting events such as a serious argument, the death of a family member or friend, separation or divorce, the loss of a job, or a financial misfortune can contribute to the factors that can make a pilot unable to fly an aircraft safely. The emotions of anger, depression, and anxiety that result from events such as these not only decrease alertness, but may also lead to unnecessary risk-taking. Any pilot who suffers an emotionally upsetting event should not fly until satisfactorily recovered from it.

#### **5.) Illness:**

Even a minor illness can seriously impair a pilot's performance. Illness can produce fever and distracting symptoms that can diminish judgment, memory, alertness, and the ability to make calculations. The symptoms of an illness can often be brought under control by medication, but the medication itself may decrease pilot performance. The safest rule is not to fly if suffering from any illness. If this restriction is considered too stringent for a particular illness, the pilot should consult an Aviation Medical Examiner for advice.

#### **6.) Medication:**

Pilot performance can be substantially degraded by both prescription and non-prescription drugs, in addition to the medical condition for which the drugs were taken. Many medications, such as antihistamines, cough suppressants, strong pain relievers, motion sickness drugs, blood pressure medications, muscle relaxants, tranquilizers, and sedatives have primary effects that can impair alertness, vision, memory, coordination, judgment, and the ability to make calculations. Any medication that depresses the nervous system such as antihistamines, tranquilizers, and sedatives can also make a pilot much more susceptible to hypoxia.

Federal Aviation Regulations prohibit pilots from performing crewmember duties while using any medication that affects the faculties in any way contrary to safety. The safest rule is not to fly as a crewmember while taking any medication unless approved by an Aviation Medical Examiner.

#### **7.) Alcohol:**

Numerous studies and accident reports have chronicled the hazards of alcohol consumption and flying. As little as 1 bottle of beer, 4 ounces of wine, or 1 ounce of liquor can impair a pilot's flying skills, and the amount of alcohol in these drinks can be detected in the breath and blood for at least 3 hours after consumption. Even after the body completely metabolizes a moderate amount of alcohol, a pilot can still be impaired for several hours by hangover. The body metabolizes alcohol at a fixed rate, and there is no way of increasing the metabolism rate of alcohol by the use of coffee, medication, or any other remedy.

Do not fly while under the influence of alcohol or while impaired by a hangover. Federal Aviation Regulations prohibit pilots from performing crewmember duties while under the influence of alcohol or within 8 hours after drinking any alcoholic beverage. Because a pilot may still be under the influence for as long as 8 hours after consuming even a moderate amount of alcohol, it is recommended that the pilot allow at least 12 to 24 hours before operating an aircraft depending on the amount of alcoholic beverage consumed.

## 8.) Hypoxia:

Hypoxia is a condition of oxygen deficiency in the blood that is sufficient to impair functions of the brain and other organs. In addition to progressively diminishing oxygen pressure as altitude increases, anything interfering with the body's ability to carry oxygen can contribute to hypoxia.

Deterioration of night vision occurs at a cabin pressure altitude as low as 5,000 feet, but other significant effects of altitude hypoxia usually do not occur in the typical healthy pilot below 12,000 feet. From 12,000 feet to 15,000 feet of pressure altitude, judgment, memory, alertness, coordination, and the ability to make calculations are impaired, and headache, dizziness, drowsiness, and either euphoria or belligerence occurs. These effects occur more quickly the higher the altitude, and can manifest themselves within 15 minutes at 15,000 feet. At cabin pressure altitudes above 15,000 feet, the periphery of the field of vision "grays out" to a point where only central (tunnel) vision remains. A blue coloration of the fingernails and lips occurs indicating cyanosis. The ability to take corrective and protective action is lost within 20 to 30 minutes at 18,000 feet and within 5 to 12 minutes at 20,000 feet, followed soon thereafter by unconsciousness.

The altitude at which significant effects of hypoxia occur can be lowered by a number of factors. Carbon monoxide inhaled from smoking or from exhaust fumes, anemia, and certain medications can reduce the oxygen carrying capacity of the blood to the degree that the adverse effects mentioned above will occur at altitudes several thousand feet lower. Even small amounts of alcohol and low doses of drugs such as antihistamines, tranquilizers, sedatives and analgesics can, through their depressant action, render the brain much more susceptible to hypoxia. Extreme heat or cold, fever, and anxiety increase the body's demand for oxygen and hence its susceptibility to hypoxia.

The effects of hypoxia are usually quite difficult to recognize, especially when they occur gradually. Symptoms of hypoxia can vary greatly among individuals, but since they are always consistent with any one individual, the ability to recognize hypoxia can be greatly improved by experiencing the effects of hypoxia in the controlled environment of an altitude chamber. The FAA provides this opportunity at military facilities throughout the United States. Pilots can apply for this training by contacting the Physiological Operations and Training Section of the Civil Aeromedical Institute in Oklahoma City, Oklahoma.

Hypoxia can be prevented by heeding factors that reduce tolerance to altitude, by enriching the inhaled air with oxygen from an appropriate oxygen system, and by maintaining a comfortable and safe cabin pressure altitude. For optimum protection, pilots are encouraged to use supplemental oxygen above 10,000 feet during the day, and above 8,000 feet at night.

Federal Aviation Regulations require that pilots use supplemental oxygen after 30 minutes of exposure to cabin pressure altitudes above 12,500 feet and immediately upon exposure to cabin pressure altitudes above 14,000 feet. Every occupant of the airplane must be provided supplemental oxygen at cabin pressure altitudes above 15,000 feet.

### **9.) Carbon Monoxide Poisoning:**

Carbon Monoxide is a colorless, odorless, and tasteless gas that is a byproduct of internal combustion and present in engine exhaust. When breathed, even in exceptionally small quantities over a period of time, it can significantly reduce the ability of the blood to transport oxygen. Consequently, the effects of hypoxia occur. Most heaters in light aircraft work by flowing air over the muffler or exhaust manifold. Use of these heaters while exhaust is escaping through cracks and seals is responsible for several aircraft accidents every year, many of them fatal. A pilot who detects the odor of exhaust fumes, or experiences the symptoms of headache, drowsiness, or dizziness while using the airplane's heater should suspect carbon monoxide poisoning and take the corrective action of shutting off the heater and opening the air vents. If symptoms are severe, the pilot should land as soon as possible and seek medical attention.

### **10.) Scuba Diving:**

Decompression sickness caused by exposure to altitude after scuba diving can create a serious inflight emergency. Anyone intending to fly after scuba diving should allow the body sufficient time to rid itself of excess nitrogen absorbed while diving. The recommended waiting period before going to flight altitudes of up to 8,000 feet MSL is at least 12 hours after diving which has not required controlled ascent (non-decompression stop diving), and at least 24 hours after diving which has required controlled ascent (decompression stop diving). The waiting period before going to flight altitudes above 8,000 feet MSL should be at least 24 hours after any scuba dive. These recommended altitudes are actual flight altitudes not pressurized cabin altitudes, and are intended to avoid any risk to the individual should an unplanned decompression of the aircraft occur during flight.

### **11.) Aerobatic Flight:**

Pilots planning to engage in aerobatics should be aware of the physiological stresses associated with accelerative forces experienced during aerobatic maneuvers. Forces associated with a rapid pull-up maneuver result in the blood and body organs being displaced toward the lower part of the body away from the head. Since the brain requires a continuous circulation of blood to maintain an adequate oxygen supply, there is a limit to the time a pilot can tolerate higher G forces before losing consciousness. As the blood circulation to the brain decreases, the pilot will experience a narrowing of the visual field called: "gray out" followed by a complete visual loss called: "black out" followed by unconsciousness. Forces associated with a rapid push-over maneuver result in the blood and body organs being displaced toward the head. Depending on the magnitude of the forces involved and individual tolerance, the pilot will first experience the visual phenomena called: "red out" followed by unconsciousness.

Physiologically, humans progressively adapt to the strains and stresses imposed by aerobatic flight, and with practice, any maneuver will have decreasing effect. Tolerance to G forces is dependent on the physiology of the individual pilot. The factors involved include the skeletal anatomy, the cardiovascular architecture, the nervous system, the quantity of blood in the body, and the general physical state of the pilot along with his experience and recency of exposure. The pilot should consult an Aviation Medical Examiner prior to aerobatic training, and be aware that poor physical condition can reduce tolerance to accelerative forces.



## **12.) Spatial Disorientation:**

Spatial disorientation is the confusion of the senses resulting in the inability to determine relative geometric position. Simply put: spatial disorientation is the inability to tell which way is up, or the attitude and position of the airplane.

The human body utilizes three sensory systems in determining orientation: the visual system, the motion-sensing system of the inner ear, and the position sensing system involving nerves in the skin and muscles. Vision is the most dominate of the senses for orientation and in most cases provides accurate and reliable information. At times in flight, however, visual surface references to the natural horizon become obscured by numerous phenomena such as smoke, fog, haze, darkness, etc. During periods of low visibility the supporting senses sometimes conflict with what is observed. When this happens a pilot is particularly vulnerable to spatial disorientation.

During flight the human body is subjected to forces not normally experienced on the ground. The forces experienced in maneuvering an aircraft such as centrifugal force and the forces of turbulence, which can act in any direction, can result in a confused interpretation of the direction of gravity. Spatial disorientation most often leads to vertigo or "motion sickness" which will further jeopardize flight safety.

Under IFR conditions aircraft attitude can only be determined by observing and properly interpreting the flight instruments. A pilot who is not trained and competent in the ability to control an airplane by exclusive reference to instruments has very little chance of surviving an unintentional flight into IFR conditions.

Disorientation in flight is not limited to the VFR rated pilot alone. When operating under instrument meteorological conditions, the sensations of motion and position during various flight maneuvers are often quite misleading. The instrument rated pilot should always be aware of his physical and mental condition, his proficiency level in the airplane he is flying, and the weather conditions in which he will be operating. If the pilot experiences vertigo and anticipates losing control of the airplane and the airplane is not equipped with an autopilot, it is recommended that the landing gear be lowered. Lowering the landing gear will help stabilize the aircraft and substantially reduce the possibility of reaching an excessive airspeed that could result in airframe separation.

The following basic steps will substantially assist any pilot in preventing spatial disorientation.

- A.) Before flying in conditions of less than 3 miles visibility, obtain training or maintain proficiency in control of an airplane by reference to instruments.
- B.) When flying at night or in conditions of reduced visibility, keep reference to the airplane's instruments.
- C.) Maintain currency in night operation. Practice should include cross-country and local operations at different airports.
- D.) Be familiar with any unique geographical conditions along the route of any flight. Prominent terrain features will assist in orientation.
- E.) Be familiar with weather conditions along the route of the planned flight and the kinds of meteorological conditions that can lead to spatial disorientation.
- F.) Rely on instrument indications when the natural horizon or reference to the earth's surface is clearly not visible.

### 13.) Illusions In Flight:

There are several illusions (false interpretations) that can be experienced in flight which can lead to spatial disorientation and/or landing errors. Illusions rank among the most common factors cited as contributing to fatal aircraft accidents. Only through awareness of these illusions (and proficiency in instrument flight procedures) can an airplane be operated safely under conditions of low visibility. Examples of the illusions encountered in flight are:

- A.) **Coriolis Illusion** -- An abrupt head movement in a prolonged constant-rate turn may set the fluid in more than one semicircular canal (located in the inner ear) in motion creating the illusion of turning or accelerating in an entirely different axis. The disoriented pilot will typically maneuver the aircraft into a dangerous attitude in an attempt to correct the perceived rotation. This most overwhelming of flight illusions may be prevented or alleviated by not making sudden extreme head movements particularly while making prolonged constant-rate turns under IFR conditions.
- B.) **Graveyard Spin** -- In a prolonged spin the fluid in the semicircular canals in the axis of the spin will cease in motion. The deceleration that occurs during recovery to level flight will again set the fluid in motion creating the illusion of spinning in the opposite direction. The disoriented pilot will return the aircraft to its original spin.
- C.) **Graveyard Spiral** -- In a prolonged coordinated constant-rate turn the fluid in the semicircular canals in the axis of the spin will cease in motion. An observed loss of altitude as indicated by the aircraft's instruments, combined with the absence of any sensation of turning may create the illusion of being in a wings-level descent. The disoriented pilot will pull back on the controls, tightening the spiral and increasing the loss of altitude.
- D.) **Somatogravic Illusion** -- A rapid acceleration during takeoff can create the illusion of being in a nose-up attitude. The disoriented pilot will push the aircraft into a nose-down or dive attitude. Similarly, a rapid deceleration by a quick reduction of the throttle(s) will have the opposite effect resulting in the disoriented pilot pulling the aircraft into a nose-up or stall attitude.
- E.) **Inversion Illusion** -- An abrupt change from a climb to straight-and-level flight can create the illusion of tumbling backwards. The disoriented pilot will push the aircraft into a nose-low attitude, possibly intensifying this illusion.
- F.) **Elevator Illusion** -- An abrupt upward vertical acceleration, usually caused by an updraft, can create the illusion of being in a climb. The disoriented pilot will push the aircraft into a nose-low or dive attitude. An abrupt downward vertical acceleration, usually caused by a downdraft, can create the opposite illusion, with the disoriented pilot pulling the aircraft into a nose-up or stall attitude.
- G.) **False Horizon** -- A sloping cloud formation, an obscured horizon, a dark scene spread with ground lights and stars, and certain geometric patterns of ground lights at night can provide inaccurate visual information for aligning the aircraft with the actual horizon. The disoriented pilot may place the aircraft in a dangerous attitude.
- H.) **Autokinesis** -- In the dark, a stationary light will appear to move about when stared at for many seconds. The disoriented pilot could lose control of the aircraft in an attempt to align it with the perceived movements of this light.

Various surface features and atmospheric conditions encountered in landing can create illusions of incorrect height above, and distance from, the runway threshold. Landing errors caused from these illusions can be prevented by anticipating them during approaches, by making an aerial visual inspection of an airport before landing, or by maintaining proficiency in landing procedures. Landing errors can also be avoided by use of landing aids such as a Visual Approach Slope Indicator (VASI), or an electronic glide slope (ILS) when available. Among the illusions leading to landing errors are:

- A.) **Runway Width Illusion** -- A runway that is more narrow than usual can create the illusion that the aircraft is at a higher altitude than it actually is. The pilot who does not recognize this illusion will fly a lower approach with the risk of striking objects along the approach path or landing short. A runway that is wider than usual can have the opposite visual effect with the accompanying risk of leveling out high and landing hard or overshooting the runway.
- B.) **Runway and Terrain Slopes Illusion** -- An upsloping runway and/or upsloping terrain can create an illusion that the aircraft is at a higher altitude than it actually is. The pilot who does not recognize this illusion will fly a lower approach. A downsloping runway and/or downsloping terrain will have the opposite visual effect.
- C.) **Featureless Terrain Illusion** -- An absence of surrounding ground features, as experienced when approaching over water, darkened areas, and terrain made featureless by snow can create the illusion that the aircraft is at a higher altitude than it actually is. The pilot who does not recognize this illusion will fly a lower approach.
- D.) **Atmospheric Illusions** -- Rain on the windshield can create the illusion of being at a higher altitude, while atmospheric haze can create the illusion of being at a greater distance from the runway. The pilot who does not recognize these illusions will fly a lower approach. Also, penetration of fog can create the illusion of pitching up. The pilot who does not recognize this illusion will steepen the approach, often quite abruptly with potentially disastrous results.
- E.) **Ground Lighting Illusions** -- Lights along a straight path, such as a road, or even lights on a moving train can be mistaken for runway or approach lights. Bright runway and approach lighting systems, especially where few lights illuminate the surrounding terrain, may create the illusion of less distance to the runway than actually exists. The pilot who does not recognize this illusion will tend to fly a higher approach.

## PILOT PROFICIENCY

### 1.) Preflight Preparation:

Federal Aviation Regulations require that each Pilot In Command (PIC) of an aircraft shall, before beginning a flight, familiarize himself with all available information concerning the flight. The FAA maintains a nationwide network of Flight Service Stations (FSS) to provide pilots with weather data and other information necessary for flight preparation. The FSS can furnish the pilot with local, en route, and destination weather information as well as en route navigational aid (NAVAID) information. Because weather conditions can change quickly, it is also recommended that the pilot obtain updated weather information from an FSS while en route.

Preflight preparation should include a review of any Notices To Airman (NOTAMS) applicable to the route of the planned flight, runway information for destination airport(s), en route terrain and obstructions, and alternate airport(s) available. The pilot should only use current aeronautical charts for planning and conducting flight operations, and is encouraged to file a flight plan.

The pilot must be completely familiar with the performance characteristics of the airplane he will be operating. At a minimum this should include the takeoff and landing data for the airplane being flown, and the minimum fuel requirements for the planned flight. Federal Aviation Regulations require that an FAA approved Airplane Flight Manual must be carried on board the airplane when it is in flight and must be accessible to the pilot.

A complete preflight inspection of the airplane is also essential to safety. Each airplane has (or should have) a checklist for conducting the preflight inspection. The consistent use of the checklist is necessary for the safe operation of the airplane. Items on the checklist should be considered the minimum to review for preflight. Testing has shown that pilots who rely on memory rather than using a checklist will often leave out one or more important items. For this reason, pilots are encouraged to always use a checklist.

## **2.) Fuel Management:**

The simplest fuel systems have only two tanks and feed from both at once. The more complex systems have main, auxiliary, and even wing-tip tanks in both wings which have to be rotated by the pilot to maintain lateral balance of the airplane. Most high-wing aircraft feed fuel to the engine by gravity. The fuel selector on most of these airplanes has a position that allows fuel flow from both tanks simultaneously and is normally set to this position to obtain automatically balanced fuel consumption. Many of these high-wing systems do not have a fuel pump, but some are designed in such a way that a fuel pump is required. All low-wing airplanes require a fuel pump. Multi-engine aircraft will also have a fuel crossfeed that can be used to feed the operating engine when the other engine fails.

The engine-driven fuel pump will be backed up by an auxiliary (typically) electric pump. This auxiliary boost pump is normally used for a starting aid and as a safety standby in the event of failure of the engine-driven pump. Some aircraft manufacturers recommend use of the auxiliary boost pump for starting the engine, others recommend that the boost pump be used before starting only, and still others recommend not using the auxiliary pump at all during start. If the auxiliary boost pump is used for starting, turn the pump off for taxiing to verify that the engine driven pump is working properly prior to takeoff. Typically the auxiliary pump will be turned on again just before takeoff and then once the airplane reaches cruising altitude the auxiliary pump will normally be turned off. It is recommended that the pilot check the fuel pressure as the boost pump is turned off to verify that the engine-driven pump is operating properly.

While cruising at altitude, it is recommended procedure to monitor the time on each fuel tank, because fuel gauges can be misleading. Study the fuel system schematic and carefully read the fuel system description in the Pilot's Operating Handbook. Understanding the characteristics of the fuel system is essential to safe operation of the aircraft.

Leaning reduces fuel consumption, extends flight range, reduces spark plug fouling, and establishes optimum engine operating temperature. Normally aspirated engines with manual mixture control should be leaned at *any* altitude once established in cruise flight at 75% or less power. Leaning is normally accomplished with the aid of an exhaust gas temperature (EGT) gauge, but many carbureted engines are not equipped with one. In this case the procedure is to lean the mixture until the engine begins to run rough, and then enrichen the mixture until the roughness stops. The roughness experienced at these cruise power settings is not caused by detonation, but rather by fuel starvation in the leanest cylinder.

A fuel injected engine with an EGT gauge can be leaned to achieve either best-power or best-economy fuel flow. Best-economy fuel flow is accomplished by leaning to peak EGT and best-power fuel flow is obtained by operating at 50 to 100 degrees rich of peak EGT depending on the aircraft and engine. When leaning to peak EGT be sure to monitor cylinder head temperature and enrichen the mixture if CHT begins to move out of the green.

Turbocharged engines have numerous operating restrictions for power settings, fuel flow, and operating temperature range which are prescribed by the manufacturer. Turbine inlet temperature (TIT) is considered to be the best parameter for measuring critical operation of a turbocharged engine and should be monitored carefully because over-leaning a turbocharged engine can cause a great deal of damage in a short amount of time. The manufacturer will typically recommend 65% or less power for a standard cruise setting for an aircraft equipped with a turbocharged engine, but consult the Pilot's Operating Handbook for operating information on any specific aircraft.

Unusable fuel is the quantity of fuel that can not be safely used in critical flight attitudes, and/or any residual fuel that will not flow through the aircraft's fuel system. The amount of unusable fuel varies among airplanes, and is determined in accordance with federal regulations. Unusable fuel is not available for flight planning purposes, and should always be included in the airplane's basic empty weight. The pilot should consult the Pilot's Operating Handbook to determine the amount of unusable fuel allocated for any specific aircraft.

Fuel mismanagement continues to be one of the major causes of General Aviation accidents. Listed among the improper practices that have resulted in crashes are:

- A.) Failure to determine that there is enough fuel capacity on board to complete the planned flight, resulting in fuel exhaustion. This error is compounded by the pilot who also fails to monitor the fuel gauge(s) during the flight. Always consult the Pilot's Operating Handbook to verify the range capabilities of the aircraft and plan the flight with enough fuel to reach an alternate airport with 45 minutes reserve.
- B.) Failure to visually verify the fuel supply during the preflight check, resulting in fuel exhaustion. This error is compounded by an inoperative fuel gauge and an inattentive pilot. Verifying that the fuel tanks are topped-off before flight and frequent inflight monitoring of fuel flow will prevent emergencies resulting from fuel exhaustion.
- C.) Fuel contamination caused by improper fueling with the wrong grade of fuel or from water, rust particles, dust and sand particles, microorganisms, or unauthorized additives. Always verify that the proper grade of fuel is loaded and examine a fuel sample from each tank sump drain during preflight for water or other contaminants. Never use unauthorized additives which might rapidly deteriorate fuel system bladders, O rings, seals, and other essential rubber parts resulting in restricted or blocked fuel flow and an expensive repair.

- D.) Changing fuel tanks after preflight runup and subsequently experiencing engine trouble in a critical phase of takeoff or climbout. If the preflight checklist directs verification of fuel flow from multiple tanks, always accomplish this task and select a fuel tank for takeoff prior to taxi and runup. If a fuel flow problem exists, this procedure is intended to allow enough time for the fuel line to run dry before the takeoff run is begun.
- E.) Changing fuel tanks on short final and unintentionally switching to an empty tank. The resulting engine loss typically occurs at too low an altitude to identify and correct the error before the airplane contacts the ground. When changing fuel tanks prior to landing at the destination airport, always do so well before entering the airport traffic pattern to allow enough altitude and time to correct any problem that might develop.
- F.) Cruising at low altitude. By the time fuel mismanagement is identified there is often not enough time to correct the problem before contacting the ground. Always cruise at a high enough altitude to allow adequate time to complete any emergency procedure and recover should the need arise. If recovery is not possible, altitude will expand options and allow more opportunity to glide to a suitable landing site.
- G.) Routinely running a fuel tank dry before switching tanks. Vapor lock can occur under this condition, and if it cannot be corrected the result will be an emergency landing. Switch tanks on a periodic basis to balance the aircraft laterally and always do so prior to fuel exhaustion.

### 3.) Stalls/Spins:

Stall/spin accidents are responsible for 25% of the fatalities and serious injuries in General Aviation. Numerous factors affect the stall speed of an aircraft. They include: weight, center of gravity, altitude, temperature, turbulence, and the presence of frost, snow, or ice on the wings.

A stall occurs when the wing is flown at an angle of attack that is greater than the angle for maximum lift. This causes a disruption of the smooth airflow over the wing and results in a precipitous loss of lift. A stall can occur at *any* airspeed, in *any* attitude, and at *any* power setting. Stalls should be practiced periodically in order to familiarize the pilot with the airplane's particular stall characteristics. The practice of stall recovery and the resulting awareness of an imminent stall help familiarize the pilot with the conditions that produce stalls. Stall awareness is the primary means of avoiding a stall/spin accident. Single-engine stalls in a multi-engine airplane are very dangerous and should not be practiced.

The power-off stall is performed with the airplane in a normal landing configuration to simulate the conditions of an accidental stall occurring during the approach-to-landing. The power-on stall is practiced to simulate the conditions of an accidental stall occurring during takeoff and departure climb. The accelerated stall will occur in steep turns, pull-ups, or other abrupt changes in the airplane's flight path.

If recovery from a stall is not made promptly and correctly, a secondary stall or even a spin may result. A spin is a condition in which the aircraft descends in a helical path. The spin occurs because one wing is producing some lift, and the other wing is stalled. In order for a spin to take place a stall must first occur. The primary cause of an unintentional spin is exceeding the wing's critical angle of attack while executing an uncoordinated (cross-controlled) turn.

The following graphs depict how an aircraft's load and stall speed will increase with the angle of bank. Above 45 degrees of bank the increase in load factor and stall speed is quite rapid. This fact emphasizes the need for avoiding steep turns at low airspeeds (a flight condition common to stall/spin accidents).

STALL SPEED CHART

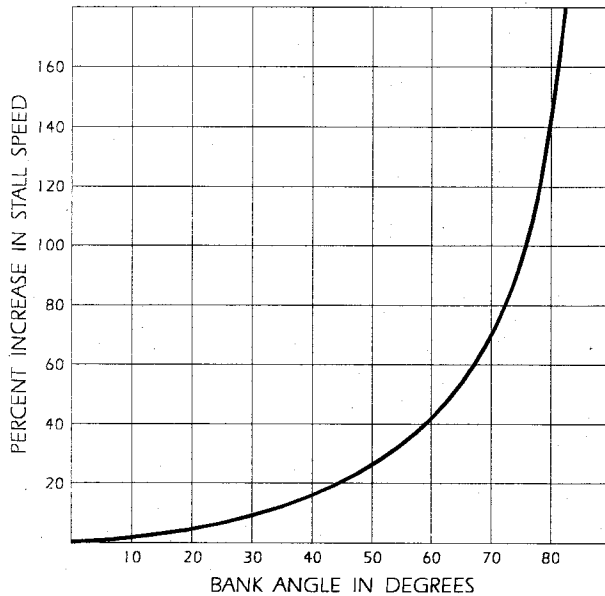

LOAD FACTOR CHART

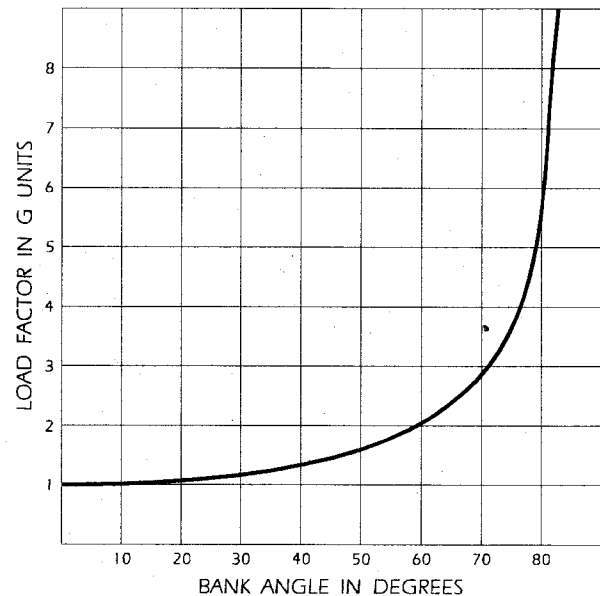

A spin is divided into two phases. They are: incipient, and fully developed. An incipient spin occurs between that period of time when the airplane stalls and rotation begins, and when the stall fully develops. A fully-developed spin occurs when the aircraft's angular rotation rates, airspeed, and vertical speed are stabilized while turning in a path that is close to vertical. If the aircraft's center of gravity is too far aft when it enters a spin, this will result in a flat spin. Recovery from a flat spin may be extremely difficult, and is often impossible.

Aircraft that are certified in the Normal Category are spin tested, but only on a limited basis and only in the incipient phase. Airplanes placarded against spins provide no assurance whatsoever that recovery from a fully-developed spin is possible under any circumstance.

Before engaging in spin recovery practice the pilot should be familiar with the characteristics of the aircraft he is operating. Spin training should only be practiced in an aircraft that is approved for spins. Any aircraft should have a specific procedure for spin recovery, and if so, this procedure will be outlined in the Pilot's Operating Handbook. The standard procedure for recovering from a spin is to close the throttle, neutralize the ailerons, and apply full rudder opposite to the direction of the turn. Then briskly move the elevator control forward. (Some aircraft require merely a relaxation of back pressure, others require full forward elevator control pressure.) Once the stall is broken, the spinning will stop. The pilot should neutralize the rudder when the spinning stops to avoid entering a spin in the opposite direction. Once the aircraft is stabilized in a dive, quickly apply aft elevator to return to level flight. It is important not to overstress the aircraft if, at this point, the airspeed exceeds  $V_A$  (maneuvering speed).

It is essential that the pilot learn to recognize the cues of an impending stall and apply immediate corrective action to prevent the aircraft from entering into an unintentional stall or spin. The senses of sight, hearing, and feeling are the means by which a pilot is made aware of an impending stall. The major cause of an inadvertent stall is the pilot becoming distracted from sensing these normal cues. Anything that takes the pilot's attention away from his primary responsibility of flying the aircraft may lead to trouble.

#### **4.) Wake Turbulence:**

Every airplane generates a wake while in flight. Part of this wake is caused by propwash or jetblast but the majority of the turbulence is caused by a pair of counter-rotating vortices trailing from the airplanes wingtips. The strength of these wingtip vortices is determined by the weight, speed, and wing configuration of the airplane. The most severe wake turbulence is produced by large and heavy commercial and military aircraft flying slowly while in a takeoff or landing configuration. Wake turbulence produced by large aircraft can pose a problem for smaller aircraft and can be extremely hazardous when encountered at low altitude.

Wingtip vortices trail behind and below an aircraft and are only produced when the wing is generating lift. For this reason, prior to takeoff or landing pilot's of General Aviation aircraft should always note the rotation or touchdown point of preceding large aircraft when operating into and out of major airports.

The following recommendations are made to avoid wake turbulence caused by large aircraft at or near an airport:

- A.) When landing, touchdown prior to the rotation point of a departing large aircraft.
- B.) When departing, become airborne before a preceding large aircraft's rotation point and climb above its flight path.
- C.) When landing, remain above the approach path of a large aircraft and land beyond its touchdown point.
- D.) When departing, lift off before the touchdown point of a large aircraft that is landing.

Airport Traffic Controllers will apply procedures under certain circumstances to separate small General Aviation aircraft from large, heavy commercial airliners. ATC may also issue wake turbulence warnings. Regardless of whether a warning has been given, the pilot of a small airplane is expected to adjust his flight path to avoid wake turbulence encounters.

#### **5.) Night Flying:**

Proficiency in night flying not only increases utilization of the aircraft, but it can prove to be important in the event an intended day flight inadvertently extends into darkness. Flying at night requires that pilots have a complete realization of their abilities and limitations, and observe more caution than during day operations.



Good night vision depends on the pilot's physical condition. Fatigue, illness, alcohol, smoking, and medication can impair the pilot's ability to see well at night. Once adjusted to the darkness, the human eye becomes thousands of times more sensitive to light. Because of this, temporary blindness can be caused by any bright light and may result in illusions or "after images" during the time the eyes are recovering. Other illusions that the brain can create result in misjudging or incorrectly identifying objects. A primary example of this is mistaking slanted clouds for the horizon. Vertigo experienced at night can create or increase illusions. The illusions seem very real and pilots with *any* level of experience and skill can be affected. Recognizing that the brain and eyes can play tricks in this manner is the best protection for the pilot flying at night.

A flashlight should always be carried when flying at night. This flashlight should have a means to switch between white and red light, because red light is non-glaring and will not impair night vision. It is important to note, however, that if red light is used to read an aeronautical chart, red features on the chart will disappear.

Preparation for night flight should include a thorough study of the available weather reports and forecasts with particular attention given to the temperature/dewpoint spread because of the possibility of the formation of ground fog at night. Also, emphasis should be placed on awareness of wind direction and speed, since drifting cannot be detected as readily at night as in the day. Prominently lighted checkpoints along the intended route should be noted. Rotating beacons at airports, lighted obstructions, lights of cities or towns, and lights from major highway traffic routes all provide excellent visual checkpoints. The use of radio navigation aids and communication facilities also add significantly to the safety and efficiency of flight at night.

Pilots should be aware of the importance of being alert and looking for other aircraft while on night flights. All pilot's should be able to recognize another airplane's position and direction of travel by the color pattern of the other aircraft's position lights.

Generally, at night it is difficult to see clouds and other restrictions to visibility, particularly on moonless nights or under an overcast. The pilot flying under Visual Flight Rules must exercise caution to avoid flying into clouds or a layer of fog. Usually, the first indication of flying into restricted visibility conditions is the gradual disappearance of lights on the ground. Under no circumstance should VFR flight be made at night during poor or marginal weather conditions.

Crossing large bodies of water on night flights could be potentially hazardous, not only from the standpoint of ditching in the water should it become necessary, but also because the horizon may blend in with the water, in which case, control of the airplane may become difficult. During haze conditions over open water the horizon may become obscure, and this may result in the loss of spatial orientation. Even on clear nights the stars may reflect on the water's surface, giving the appearance of a continuous array of lights, thus making the horizon difficult to identify.

The pilot's ability to properly judge distance at night is limited by the poor lighting, lack of intervening references on the ground, and the inability to compare the size and location of different ground objects. This also applies to the ability to estimate altitude and speed. Consequently, more dependence must be placed on flight instruments, particularly the altimeter and airspeed indicator.

Adverse weather and poor pilot judgment account for many nighttime accidents, but one of the major concerns about flying a single-engine airplane at night is complete engine failure. If the engine fails at night, the first action the pilot should take is to maintain control of the airplane. Do not allow a stall to occur. A normal glide should be established and maintained, and the airplane turned toward an airport or away from congested areas. Wind direction should be determined to avoid a downwind landing. A checklist should be used to determine the cause of the engine failure. It is possible that the cause of the malfunction can be corrected and the engine restarted. The landing lights should be checked at altitude and turned on in sufficient time to illuminate the terrain or obstacles along the glidepath. If the landing lights are not usable and outside visual references are not available, the airplane should be held in a level landing attitude until the ground is contacted.

The FAA has initiated a voluntary pilot safety program called: "Operation Lights On" to enhance the see-and-be-seen concept of averting collisions both in the air and on the ground, and to reduce bird strikes. All pilots are encouraged to turn on their landing lights when operating within 10 miles of an airport (day and night), in conditions of reduced visibility, and in areas where flocks of birds may be expected.

#### **6.) Mountain Flying:**

A pilot's first experience flying over mountainous terrain can develop into a nightmare event if he is not aware of the potential hazards involved. Among the hazards that can be encountered are: abrupt changes in wind direction and velocity, common and severe updrafts and downdrafts particularly near cliffs, and a distinct lack of areas suitable to make a forced landing in the event of an emergency.

Mountain flying need not be hazardous if the pilot follows these few recommendations.

- A.) Obtain dual instruction from a qualified CFI to become familiar with conditions which may be encountered when flying in mountainous terrain.
- B.) File a flight plan. Plan the route to avoid topography which would prevent a safe forced landing. The route should be over populated areas and well-known mountain passes. Sufficient altitude should be maintained to permit maximum gliding range should the engine fail.
- C.) Do not fly a light aircraft over mountainous terrain when the winds aloft at the proposed cruising altitude exceed 35 mph. Approach mountain passes with as much altitude as possible. Downdrafts of as much as 1,500 to 2,000 fpm are routinely found on the leeward side of a mountain ridge.
- D.) Do not fly near or above abrupt changes in terrain. Severe turbulence can be expected, especially in high wind conditions.
- E.) Some canyons run into a dead end. Never fly down the middle of a canyon. Fly on the updraft side and allow enough room to make a 180 degree turn to avoid becoming trapped.

- F.) Plan your flight for early morning or late afternoon. As a rule, the wind begins to pick up by 10:00 a.m. and builds steadily until about 4:00 p.m. then gradually decreases until dark. Avoid flying in mountainous terrain after dark.
- G.) It is important to factor in the effects of density altitude when flying in mountainous terrain, especially in the summer months. Indicated airspeed should be used when landing at a high-altitude airfield the same as a field at sea level. Because the air at altitude is less dense, however, the same indicated airspeed results in a higher true airspeed. This results in a higher landing speed and longer landing distance. At high density altitudes an aircraft's engine will obtain only a percentage of its sea-level horsepower, and the propeller is less efficient as well. The combination of a high-altitude airport and a hot summer day might well result in the need for 2 to 3 times the amount of runway required at sea level before the plane will become airborne on takeoff. The aircraft's climb rate will also be reduced by these conditions. It is recommended that you consult the Pilot's Operating Handbook to determine the performance characteristics of the airplane under these conditions. If it is determined that there is not a reasonable margin of error, the pilot should consider decreasing the airplane's load or waiting for a cooler day.
- H.) Mountain waves occur when the air is being blown approximately perpendicular to a mountain ridge. The turbulence associated with a mountain wave is expected with high winds, but can occur when the wind's velocity is as little as 15 knots and the angle of intersection is greater than 30 degrees. Turbulence can extend for over 100 miles on the leeward side of a mountain range. The presence of standing lenticular clouds and "roll clouds" is indicative of a mountain wave, but this telltale sign can not be relied upon because there is not always enough moisture in the air for clouds to exist. Since the downdraft of a mountain wave can exceed the climb capability of a small aircraft, pilots are cautioned to avoid areas where mountain waves might form. If excessive turbulence is encountered, reduce airspeed to  $V_A$  (maneuvering speed) and fly away from the area.

### 7.) Inflight Collision Avoidance:

Scanning the sky for other aircraft is a key factor in collision avoidance. Scanning should be used continuously by the pilot and copilot (or right seat passenger) to cover all areas of the sky visible from the cockpit. The probability of spotting a potential collision threat increases with the time spent looking *outside* the cockpit. Therefore, the pilot must use timesharing techniques to effectively scan the surrounding airspace while monitoring the aircraft's instruments.

While the eyes can observe an approximate 200 degree arc of the horizon at one glance, only a very small center area is capable of producing sharply focused images. Because the eyes can focus sharply on only a narrow viewing area, effective scanning is accomplished with a series of short, regularly spaced eye movements that bring successive areas of the sky into the central visual field. Each movement should not exceed 10 to 15 degrees and each area should be observed for at least 1 to 2 seconds to allow detection of anything relevant. Since the brain of most people is already trained to process sight information from left to right, most pilots find it easier to start scanning in the same way. Scan an area of the sky approximately 60 degrees to the left and right of the aircraft's centerline. After finishing the scan outside the aircraft, a quick scan of the instruments can be made before returning attention to the outside again.

Familiarity with the following information will reduce the possibility of a mid-air collision.

- A.) **Determine Relative Altitude** -- Use the horizon as a reference point. If the other aircraft is above the horizon, it is probably on a higher flight path. Likewise, if the aircraft appears to be below the horizon, it is probably flying at a lower altitude.
- B.) **Take Appropriate Action** -- Pilots should be familiar with the rules of right-of-way in order to take appropriate immediate evasive action if it is determined that the aircraft is on a collision course.
- C.) **Recognize Collision Course Targets** -- Any aircraft that appears to have no relative motion, but increases in size, is on a collision course. Take evasive action. The decision to climb, descend, or turn is a matter of personal judgment. Watch the other aircraft during the evasive maneuver, and immediately begin scanning for other aircraft in the area.
- D.) **Be Alert in High Hazard Areas** -- Airways, especially near VORs and around airports are places where aircraft tend to cluster. Remember, most mid-air collisions occur during the day when the weather is good.
- E.) **Practice Cockpit Management** -- Reduce the amount of time devoted to studying maps, checklists, and manuals during flight by accomplishing as much of this work as possible during preflight planning. This will permit more time for scanning. Also, the pilot needs to move his head to see around fixed aircraft structures such as door posts, wings, etc.
- F.) **Keep The Windshield Clean** -- Dirty or bug-smearred windshields can greatly reduce the pilot's ability to see other aircraft.
- G.) **Be Alert in Low Visibility Conditions** -- Smoke, haze, dust, rain, and flying into the sun can all greatly reduce the ability of the pilot to detect other aircraft.
- H.) **Fly With Lights On** -- Day or night, use of exterior lights can greatly increase the ability of any aircraft to be seen. Keep interior lights low at night.
- I.) **Utilize Air Traffic Control Support** -- Flight through Class C and Class D airspace requires communication with ATC, but ATC facilities will provide radar traffic advisories outside positive control areas on a workload-permitting basis. Use this support whenever possible or when required.

#### 8.) **Multi-Engine Airplane (Single-Engine Procedures):**

Engine failure of a multi-engine aircraft can be a serious situation. Loss of an engine on a light twin results in the loss of 80% or more of the performance capabilities of the airplane. The pilot's knowledge and proficiency are the most important factors for handling an engine-out emergency safely. The following information is intended to be general in nature and applicable to a typical reciprocating-engine, propeller-driven, light twin airplane. Refer to the Pilot's Operating Handbook for specific emergency procedures on any particular airplane.

### A.) Single Engine Cruise

Engine failure in cruise flight is the least critical of single-engine emergencies. The primary concern is to maintain directional control. Beyond this, the pilot will want to determine the cause of the problem and correct it if possible. Securing the dead engine is accomplished by the following procedure.

- 1.) **Identify** -- The airplane will yaw in the direction of the dead engine. Rudder pressure required to maintain directional control will be on the side of the good engine. The most common memory aid for identifying the failed engine is: dead foot, dead engine.
- 2.) **Verify** -- Manifold pressure gauges and tachometers will indicate near-normal readings, and should not be used to determine an inoperative engine. Partially retard the throttle on the engine that is believed to be inoperative. There should be no change in control pressures or engine sound if the correct throttle has been selected.
- 3.) **Feather** -- Feathering procedure varies among airplanes, but generally it is accomplished by reducing the throttle to idle, reducing the mixture to idle cut-off, and placing the prop control in the feather detent.

If both engines on a twin have propellers that rotate clockwise (as viewed from the cockpit) as they do on most aircraft manufactured in the United States, then the left engine is termed the "critical engine". This terminology becomes important since  $V_{MCA}$  is determined with the critical engine inoperative. Failure of the left engine is significant because the clockwise-rotating right engine will produce greater yaw and roll moments due to propeller P-factor. If the two engines have counter-rotating propellers, the yaw and roll moments are equal and opposite one another, and neither engine is the critical engine.

Due to asymmetrical thrust, when one engine fails the airplane will yaw and roll toward the dead engine. Maintaining wings level and holding the ball of the turn-and-bank indicator in the center can increase  $V_{MCA}$  as much as 20 knots.

In addition, the high drag caused by the wings-level, ball-centered configuration can reduce single-engine climb performance by as much as 300 feet per minute. To overcome the yaw and roll moments induced by an engine failure, bank approximately 5 degrees into the operating engine, and displace the ball of the turn-and-bank indicator approximately 1/2 ball width toward the operating engine.

Monitor the gauges (especially cylinder head temperature) on the operating engine frequently. If for any reason it becomes necessary to fly for any distance on one engine, fuel management in the form of crossfeed will become necessary. If crossfeed of fuel is required, the fuel supply should be taken off crossfeed before landing.

## **B.) Engine Failure On Takeoff**

The takeoff run is the most critical time for the pilot of a light twin. The pilot should plan the takeoff in sufficient detail to be prepared to take immediate action if an engine fails during the takeoff process. Many factors influence the decision to abort or continue a takeoff in a light twin when an engine fails. The major factors include: runway length, aircraft weight, headwind component, terrain or obstructions, and the single-engine climb capability of the airplane as determined by performance graphs in the Pilot's Operating Handbook. The takeoff is divided into three phases. They are:

- 1.) If an engine fails prior to reaching lift-off speed, or below  $V_{MCA}$  close both throttles and abort the takeoff. If an engine fails just after lift-off, the takeoff should still be aborted because continued flight may be marginal or impossible. This procedure is only applicable if the landing gear has not been retracted, and there is enough runway remaining for touchdown and landing roll. The pilot should have determined the accelerate-stop distance requirements of the airplane during preflight preparation.
- 2.) Once  $V_{MCA}$  is attained and before  $V_{YSE}$  has been reached, a decision must be made whether to abort or continue the takeoff. If the decision is made to continue the takeoff, the pilot must immediately retract the landing gear and achieve  $V_{YSE}$  if no obstacles are involved and  $V_{XSE}$  if obstacles are a factor.
- 3.) Once the aircraft has attained  $V_{YSE}$  the landing gear should be retracted, and the takeoff continued. Once the aircraft is stabilized, the dead engine can then be identified, verified, and feathered.

## **C.) Single Engine Approach and Landing**

In most light twins a single-engine approach can be accomplished with a flight path and procedure almost identical to a normal approach and landing. The final approach speed should not be less than  $V_{YSE}$  and the landing gear should not be extended until the landing is assured. It is recommended that the approach be made with less than full flaps in case a go-around becomes necessary. The pilot should be careful to complete the landing checklist, because it is not unusual for a pilot to forget important items (such as putting the landing gear down) due to the distraction caused by the engine-out emergency. Once the landing is assured, the airspeed should be appropriate for the selected flap position until the landing roundout is begun.

It is not desirable to execute a single-engine go-around. Every effort should be made to avoid this procedure because it is difficult at best and may not even be possible. The sudden application of full power can present control problems due to asymmetrical thrust. If a single-engine go-around can not be avoided, the gear and flaps should be retracted as soon as possible. Attain  $V_{YSE}$  and then attempt to gain altitude.

## WEATHER

### 1.) The Weather Briefing:

Flight Service Stations (FSS) are the primary source for obtaining a preflight briefing and inflight weather information. Flight Service Specialists are qualified and certified by the National Weather Service as Pilot Weather Briefers. They are authorized to translate and interpret available forecasts and reports directly into terms describing the weather conditions which the pilot can expect along the route of flight and at the destination airport. Three basic types of preflight briefings are available. They are: Standard Briefing, Abbreviated Briefing, and Outlook Briefing.

A pilot should request a Standard Briefing when he has not received a previous briefing or has not received preliminary information through mass dissemination media. The data provided by the briefer will include information on any adverse conditions, whether VFR flight is recommended, a synopsis, current conditions, en route forecast, destination forecast, winds aloft, any Notices To Airmen (NOTAMS), and any ATC delays.

An Abbreviated Briefing should be requested to update a previous briefing, when only 1 or 2 items of information are needed, or to supplement mass dissemination data. The pilot requesting an Abbreviated Briefing should provide the briefer with appropriate background information, the time the information was received, and/or the specific items needed. The briefer will supply any needed data and/or appreciable changes in weather conditions since the pilot's last briefing.

An Outlook Briefing should be requested whenever the flights proposed time of departure is 6 or more hours from the time of the briefing. The briefer will provide available forecast data applicable to the proposed flight. This type of briefing is provided for flight planning purposes only. The pilot should obtain a Standard or Abbreviated Briefing prior to departure.

Pilots are encouraged to obtain an Inflight Briefing whenever conditions along the route of flight indicate that it would be appropriate to do so. Once communications are established, the pilot will advise the briefer of the type of information required and any applicable background information. Enroute Flight Advisory Service (EFAS) is intended to provide aircraft in flight with timely and meaningful weather advisories. This service is normally available to aircraft flying at 5,000 feet AGL throughout the contiguous United States between the hours of 6:00 a.m. and 10:00 p.m. All communications are conducted on the designated EFAS frequency of 122.0 MHz.

Numerous other weather advisory services are available to pilots. They include: the Automated Weather Observing System (AWOS), Pilots Automatic Telephone Weather Answering Service (PATWAS), Transcribed Weather Broadcast (TWEB), Hazardous Inflight Weather Advisory Service (HIWAS), and Weather Radar Services. Pilots are encouraged to become familiar with all of these services and avail themselves of them as often as necessary.

## **2.) Wind Shear:**

Wind shear is caused when air masses with differing speed and direction adjoin each other causing abrupt changes in the velocity and/or direction of the wind. Wind shear can occur horizontally or vertically and is most often associated with frontal activity, thunderstorms, strong temperature inversions that trap stable air beneath unstable air, and surface obstructions. Wind shear can occur at high or low altitude but it is the low-level wind shear that is of concern to pilots, especially during final approach. Wind shear can induce significant loss in airspeed and full power may not be able to be gained in enough time to prevent a crash.

The most dangerous component of wind shear is the downdraft or microburst which can force an aircraft to the ground. Microbursts are associated with the mature and dying stages of a thunderstorm and are small-scale intense downdrafts which on reaching the surface, spread outward in all directions. Microbursts are not easily detectable by conventional weather radar due to their small size, and short life-span. The microburst is typically less than 1 mile in diameter and can create a severe hazard for aircraft within 1,000 feet of the ground. Because the velocity of the downdraft in a microburst can exceed the climb capabilities of an aircraft, flight in the vicinity of suspected or reported microburst activity should always be avoided.

The pilot should be aware of the conditions that produce low-level wind shear and be prepared to execute a go-around maneuver at the first indication that wind shear has been encountered. Any pilot that encounters wind shear should file a Pilot Weather Report (PIREP) at once.

## **3.) Thunderstorm Avoidance:**

The thunderstorm often encompasses some of the worst weather hazards known to flight. The General Aviation pilot must contend with thunderstorms of varying intensities in virtually all parts of the world.

The initial stage of a thunderstorm is always a cumulous cloud. When a predominate updraft caused by an abundance of heat occurs in conjunction with a cumulous cloud it causes the cloud to begin to build. If this building continues, rain droplets will begin to form. When rain appears at the surface, the thunderstorm is said to have reached the mature stage. In a limited state thunderstorm the precipitation will tend to cool the lower portion of the cloud and thereby cut-off the storm's fuel supply. The cell loses its energy and the storm dissipates. In a steady-state thunderstorm the updrafts and downdrafts tend to balance one another creating excellent conditions for extreme turbulence, damaging lightning, icing, and large hail. Thunderstorms often form rapidly especially during the summer months, and severe storms can last as long as 24 hours and travel as far as 1,000 miles.

The following list should be considered the minimum of items to observe regarding thunderstorms.

- A.)** Don't takeoff or land in the face of an approaching thunderstorm. A sudden wind shift or low-level turbulence could result in loss of control of the aircraft.
- B.)** Don't attempt to fly under a thunderstorm even if you can see through to the other side. Turbulence under the storm could cause disaster.



- C.) Don't fly into a cloud mass containing embedded thunderstorms without the aid of airborne radar. Scattered thunderstorms that are not embedded in a cloud mass can usually be circumnavigated.
- D.) Don't trust the visual appearance of a cloud to be a reliable indicator of the turbulence inside a thunderstorm.
- E.) Do avoid, by at least 20 miles, any thunderstorm identified as severe. This is especially true under the anvil of a large cumulonimbus cloud.
- F.) Do circumnavigate an entire area if the area has 6/10 storm coverage as observed visually or by airborne radar.
- G.) Do remember that vivid and frequent lightning indicates the probability of a severe thunderstorm.
- H.) Do regard any thunderstorm with tops of 35,000 feet or higher as extremely hazardous.
- I.) Do check for convective activity during your preflight weather briefing and monitor the Flight Watch frequency (122.0 MHz) while in flight to learn current weather conditions.

If penetration of a thunderstorm cannot be avoided, the following items are suggested before entering the storm.

- A.) Tighten your safety belt, put on your shoulder harness if you have one, and secure all loose objects.
- B.) Plan your course to take you through the storm in a minimum of time, and hold to it.
- C.) Establish a penetration altitude below the freezing level or above the level of -15 degrees Celsius to avoid the most critical icing.
- D.) Verify that the pitot heat is on and turn on the carburetor heat. Icing can be rapid at any altitude and cause almost instantaneous power failure and/or loss of airspeed indication.
- E.) Establish power settings for  $V_A$  (turbulent air penetration speed) recommended in the Pilot's Operating Handbook. Reduced airspeed decreases the structural stresses on the aircraft.
- F.) Turn up cockpit lights to the level of highest intensity to counteract the temporary blindness caused by lightning.
- G.) Disengage altitude hold and speed hold mode if using an autopilot. The automatic altitude and speed controls will increase maneuvering of the aircraft, thus increasing structural stresses.
- H.) If using airborne radar, tilt the antenna up and down occasionally. This will permit the detection of other storm-cell activity at altitudes other than the one being flown.

If penetration of a thunderstorm has occurred either intentionally or accidentally, the following items are suggested.

- A.) Do keep your eyes on the instruments. Looking outside the cockpit can increase the possibility of temporary blindness from lightning.
- B.) Don't change power settings. Maintain setting for  $V_A$  (turbulent air penetration speed).
- C.) Do maintain a constant attitude. Maneuvers made in trying to maintain a constant altitude increase stresses on the airframe. It is best to let the aircraft ride with the turbulence.
- D.) Don't turn back once you are in the thunderstorm. A straight course through the thunderstorm will most likely get you out of the hazards sooner than changing direction.

All thunderstorms are dangerous regardless of their level of intensity. Avoiding all thunderstorms is the recommended policy.

#### 4.) Icing:

Aircraft icing is one of the major weather hazards to aviation, and is experienced most often in IFR flight. Icing is a cumulative hazard because it reduces the aircraft's efficiency by increasing weight, reducing lift, decreasing thrust, and increasing drag. Other icing effects include: impaired engine performance, false indications of flight instruments, loss of radio communication, and loss of operation of control surfaces, brakes, and landing gear.

Two conditions are necessary for structural icing to occur in flight. First, the aircraft must be flying through visible moisture such as rain or cloud droplets, and second, the temperature at the point where the moisture strikes the aircraft must be close to zero degrees Celsius. The most rapid accumulation of icing occurs when supercooled water droplets (liquid below freezing temperature) increase the rate of icing. The types of structural icing are: clear ice, rime ice, and a mixture of the two. Each has its identifying features.

Clear ice is transparent and usually deposited in smooth layers. This type forms when droplets are large as in rain or as are found in cumuliform clouds. Rime ice is opaque and usually a rough deposit. This type forms when droplets are small such as those found in stratified clouds or light drizzle. Rime ice is lighter in weight than clear ice, but its weight is of little significance because its irregular shape and rough surface make it very effective in increasing drag. A mixture of clear and rime ice forms when liquid droplets are combined with snow or ice particles. Ice particles become imbedded in clear ice causing a rapid buildup that is very rough.

The FAA, in cooperation with other organizations, has established a standard for reporting icing intensity and accumulation. Pilots should be familiar with this standard and use it in reporting icing conditions.

- A.) **Trace** -- Ice becomes perceptible. The rate of accumulation is slightly greater than the rate of sublimation. It is not hazardous even though de-icing/anti-icing equipment is not utilized, unless encountered for an extended period of time (over 1 hour).

- B.) Light** -- The rate of accumulation may create a problem if flight is prolonged in this environment (over 1 hour). Occasional use of de-icing/anti-icing equipment removes/prevents accumulation. It does not present a problem if the de-icing/anti-icing equipment is used.
- C.) Moderate** -- The rate of accumulation is such that even short encounters become potentially hazardous and use of de-icing/anti-icing equipment and/or diversion of the flight is necessary.
- D.) Severe** -- The rate of accumulation is such that de-icing/anti-icing equipment fails to reduce or control the hazard. Immediate flight diversion is necessary.

Forecasters can identify regions where icing is possible, but they cannot define the precise pockets in which it will occur. The pilot should plan the flight to avoid those areas where icing is possible, and must be prepared to escape this hazard when en route.

The following is provided as a general guide and is considered to be the minimum items for the pilot to consider before and during flight in winter weather.

#### **A.) Preflight Checks**

- 1.) Prior to flying in weather that is favorable to icing, obtain a complete weather briefing including any Pilot Weather Reports (PIREPS) for the planned route.
- 2.) If the aircraft is equipped with deice boots, perform a thorough preflight check of the pneumatic system including an inspection of the boots for damage and proper inflation.
- 3.) Check electrically powered anti-ice equipment such as pitot-static heat and windshield panels. Also check engine carburetor/induction heat for proper operation.
- 4.) Remove any ice, frost, or snow from all fuselage surfaces, airfoil surfaces, control surfaces, and the propeller.
- 5.) In cold weather, avoid taxiing or taking off through water, mud, or slush to prevent accumulations that can freeze landing gear and/or control surfaces.

#### **B.) Inflight Checks**

- 1.) Avoid clouds and visible precipitation when outside air temperatures are between zero degrees Celsius and -15 degrees Celsius.
- 2.) Turn on anti-icing equipment before entering possible icing conditions.
- 3.) If the aircraft is not equipped with pitot-static anti-ice, be alert to erroneous readings from the airspeed indicator, rate-of-climb indicator, and altimeter.
- 4.) If ice accumulates when flying in clouds or precipitation, change altitude immediately. Fly at an altitude free of clouds or where temperatures are above zero degrees Celsius and below -15 degrees Celsius.

- 5.) When climbing through an icing layer, climb at a higher than normal airspeed to minimize ice accumulation and provide a margin of protection for stall.
- 6.) Avoid cumuliform clouds. Clear ice may be encountered anywhere in these clouds above the freezing level.
- 7.) Avoid abrupt maneuvers if the aircraft is coated with ice, and fly the landing approach with power.

Carburetor icing has always been a problem for any aircraft equipped with a float-type carburetor. Rapid cooling occurs in a float-type carburetor because of fuel vaporization and low pressure developed in the venturi tube(s). It is possible for ice to form in the carburetor when the relative humidity is above 50% and the air temperature is between 20 and 90 degrees Fahrenheit. Ice forming in the carburetor can result in partial or complete engine power loss. If carburetor icing develops or is even suspected, application of full carburetor heat is the standard remedy.

The fuel injected engine does not have the threat of venturi ice, but other parts of the induction system are subject to icing. Induction system icing can happen to any reciprocating engine aircraft and will usually occur in IFR conditions due to slush, snow, and impact ice blocking the engine's air filter. This form of icing will also result in partial or complete engine power loss. The restricted air flow resulting from induction system icing can be dealt with by opening the alternate-air door.

#### **ADDITIONAL INFORMATION**

The pilot who desires a greater understanding of, or additional information on, the various subjects covered in this section is referred to the General Aviation Accident Prevention Program sponsored by the FAA. Numerous pamphlets are published for this program that are a very good source of information and highly recommended for ongoing pilot safety training.