

AT MICROFICHE
REFERENCE
LIBRARY

A project of Volunteers in Asia

Raising Goats for Milk and Meat

by Rosalee Sinn

Published by:

Heifer Project International
Box 808
Little Rock, Arkansas 72203
USA

Available from:

same as above

Reproduced by permission.

Reproduction of this microfiche document in any form is subject to the same restrictions as those of the original document.

Raising Goats For Milk and Meat

By Rosalee Sinn

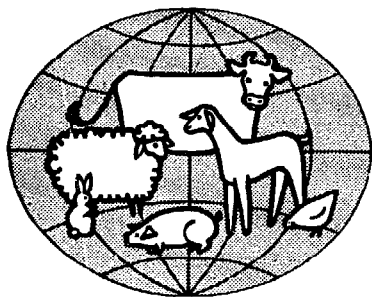
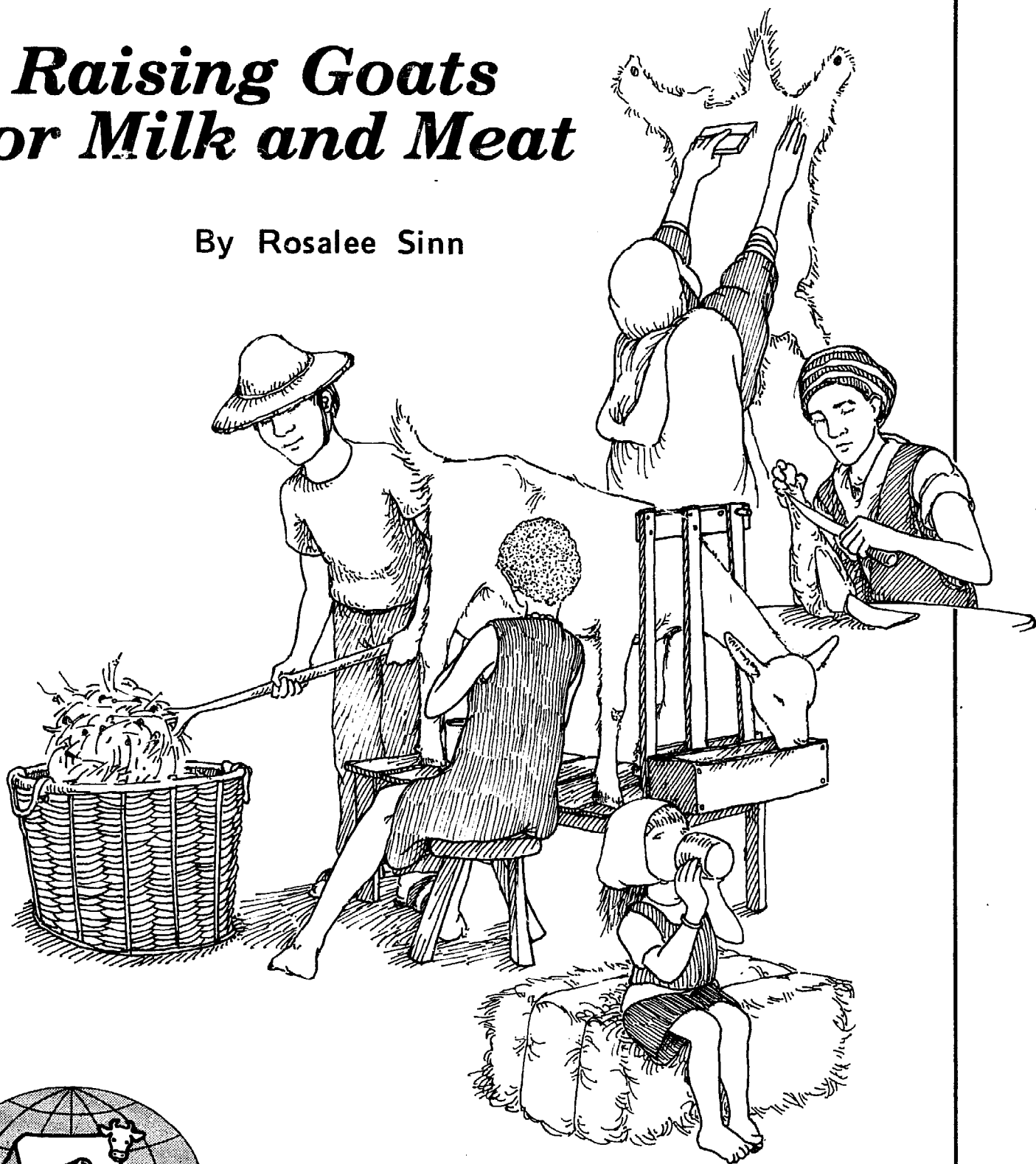

A HEIFER PROJECT INTERNATIONAL TRAINING COURSE



Rosalee Sinn is the Northeast Director for Heifer Project International. She has selected, processed and shipped thousands of goats for HPI to program areas located in dozens of developing countries and in rural areas of the United States. She has visited goat projects in Central America and the Caribbean and has taught dairy goat management courses in Cameroon, West Africa. This manual was originally written for training courses in Cameroon. It has been revised for more universal use.

Raising Goats for Milk and Meat

Rosalee Sinn

A Heifer Project International Training Course

Heifer Project International

Box 808

Little Rock, Arkansas 72203

Original Printing December 1983

Second Printing July 1983

Third Printing (With Revisions) July 1985

This book is dedicated to the small farmers in the Northwest Province of Cameroon, West Africa. I am indebted to them for their encouragement in my early attempts to formalize this training manual and for their willingness to work with me in discovering anew the benefits of goat husbandry.

- Rosalee Sinn

MEMO TO TRAINING INSTRUCTORS

This manual is directed toward persons in rural development areas. Educational backgrounds will vary. Most people in the course will have backgrounds in either livestock or crop farming.

The focus of the manual is on European breeds of dairy goats. However, we recognize that in many areas there are crossbreds which may have been upgraded to milk animals. The material in the manual is applicable to native (local) milk animals as well.

The manual has been field tested in Cameroon, West Africa. Some of the management procedures are adapted from those experiences.

The manual may reflect different procedures than those used in your particular area. During the training sessions you will want to give additional information which is appropriate to your situation.

GENERAL PROCEDURES

- 1) Read the entire manual. Identify those areas which you will want to adapt or change.
- 2) Review each lesson.
- 3) Identify words that need clarification.
- 4) Decide on tasks, "hands-on" experiences, and arrange for animals, equipment and supplies needed.

Note: A filmstrip is available to accompany the course. Write Heifer Project International, Box 808, Little Rock, AR 72203

RAISING GOATS FOR MILK AND MEAT
A Heifer Project International Training Course

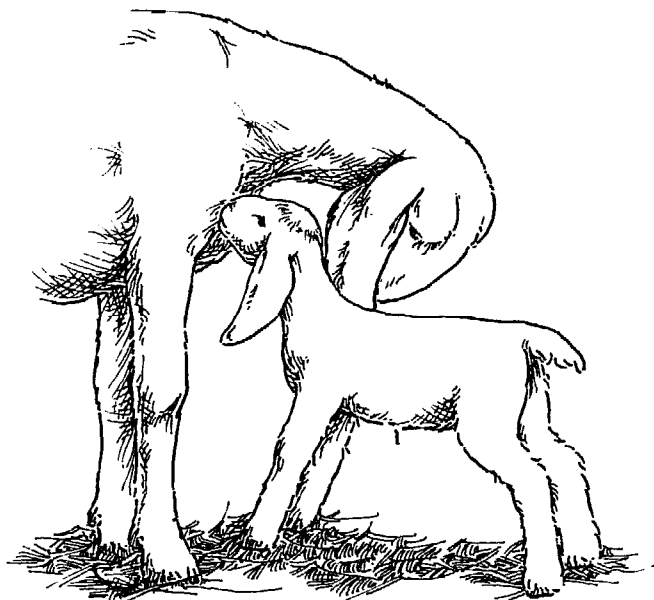

Rosalee Sinn
Northeast Director
Heifer Project International

Illustrations by:
Barbara Carter,
Randolph, Vermont

INTRODUCTION

Purpose	1
History of Goats	1
Vocabulary	3
Review of Breeds	3
European/USA Breeds - "Exotics"	5
Breed Size Standards for European/USA Breeds	9

LESSON I - INTRODUCTION TO DAIRY GOATS

Benefits of Owning a Dairy Goat	10
Problems of Owning a Dairy Goat	11
Parts of the Goat's Body	12
Selecting a Good Dairy Goat	14
Evaluating Bucks	16
Determining the Age of Goats	17
Determining the Weight of a Goat	18
Growth Records	19
Observation Sheet	20

LESSON II - HOUSING, FEEDERS AND CONTAINMENT

Housing	21
Mangers and Feeding Equipment	22
Containment	23
Milking Equipment	25

LESSON III - FEEDING

The Ruminant Digestive System	27
Feeding the Newborn	28
CAE Prevention Program	29
Feeding the Weaned Kid Up to One Year	31
Feeding the Mature Goat	31
Feeding the Milking Doe	32
Feeding the Pregnant Doe	32
Feeding the Breeding Buck	33
Nutrients in a Goat's Diet	33
Example Feeds	33
Hay Storage	33
Silage	33a
Forages and Grasses	33a
Protein Supplements	38
Husbandry Systems	40
Managing Goats During Wet and Dry Seasons	41

LESSON IV - BREEDING AND CROSSBREEDING

Breeding the Doe	43
Crossbreeding	45
Selecting a Buck	46
Caring for the Pregnant Doe	46
Reproductive Organs of Buck and Doe	47
Gestation Table	48

LESSON V - KIDDING

Preparation for Kidding	49
Signs of Kidding	50
Normal Delivery Positions	51
Abnormal Birth Positions	52
Helping With a Difficult Birth	53
General Procedures	53
Stages of Birth	54
Disbudding/Dehorning	56
Building a Disbudding Box	57
How to Care for Growing Kids	58
Castration and Vasectomy of Bucks	59
Health Care for Kids	60

LESSON VI - CARE OF THE MILKING DOE - MILK PRODUCTS

Milking Equipment and Supplies	61
Proper Milking Procedures	62
How to Care for the Milk	64
Drying Off a Doe	65
Mastitis	65
Milk Products - Yogurt	66
Cheese	67
Composition of Milk	72

LESSON VII - HEALTH CARE FOR YOUR GOATS

Signs of a Healthy Goat	73
Normal Goat Physiological Data	73
Vaccination Program	74
Hoof Trimming	75
How to Take a Goat's Temperature	76
How to Drench an Animal	76
How to Give a Bolus	77
How to Give an Injection	77
Guide to Common Goat Diseases	78
Parasites - Lice, Ear Mites	82
Parasites - Ticks	82
Parasites - Stomach Worms, Tapeworms	84
Items and Medications to Keep Your Goat Healthy	87

LESSON VIII - RECORD KEEPING

The Importance of Records	88
Individual Goat Records	89
Milk Records	97

LESSON IX - SELECTING AND SLAUGHTERING GOATS FOR MEAT

Culling	102
Handling Animals Prior to Slaughter	102
Preparation for Slaughter	102
Equipment Needed	103
Slaughtering	103

Tables	107
--------	-----

References	109
------------	-----

Appendix

(Additional copies of Observation and record sheets and expense and income ledger.)

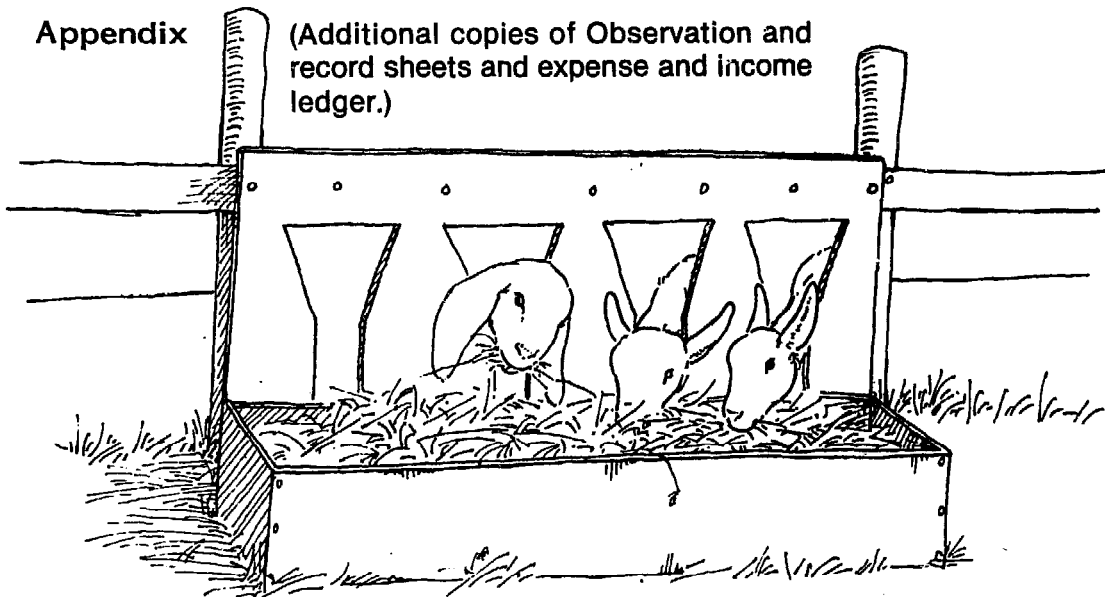

RAISING GOATS FOR MILK AND MEAT

INTRODUCTION

PURPOSE

The purpose of this course is to provide a guide to learning basic care and management of dairy goats. It is directed toward persons in rural development areas. It is designed to be used in a classroom situation. The ideal classroom setting will provide for "hands-on" experiences with goats. If possible, plan to have a yearling doe, a lactating (milking) doe, a mature buck and two kids present during the instruction period.

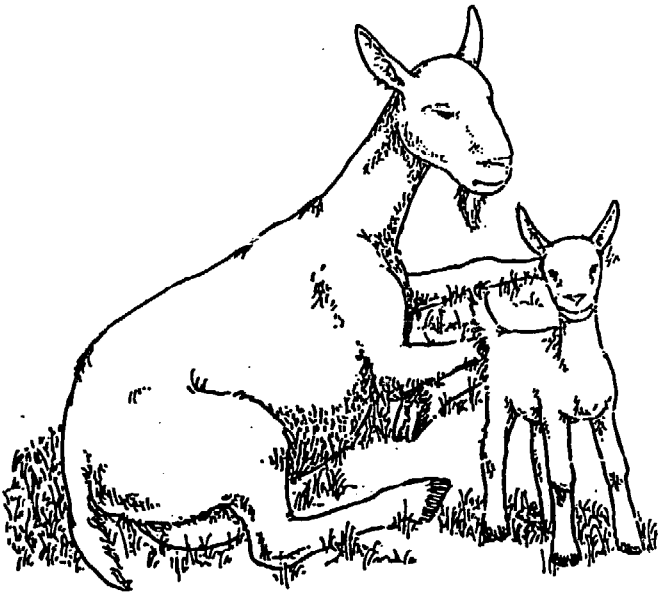

Experience with and observation of goats during the training course is important. Good management begins with basic knowledge and daily observation. Observation at special times such as estrus (heat period), and breeding, parturition (birth) or during illness is critical. While all areas of management cannot be observed during the training course, students may be invited to return to the training center or visit another goat breeder at the other significant periods.

Information on forages, feed by-products and climate may vary in each situation. However, most of the material in this manual is applicable regardless of location.

The course can also be used by an individual student, utilizing the advice and assistance of other goat breeders, extension personnel and local veterinarians.

HISTORY OF GOATS

Goats have been used as a source of meat and milk since the earliest days of recorded history. They were first domesticated about ten thousand years ago in the Tigris-Euphrates Valley in Southwestern Asia. Goats are mentioned two hundred times in the Bible. Moses ordered the altar cloths in the Tabernacle woven of silk and goat hair. In 1981, the goat population of the world was reported at 445 million.

The goat has been traditionally raised for meat and milk. The fact that goats are comparatively small animals and cost very little for maintenance has led goat farming to be popular among small scale farmers.

Goats have some advantages over other animals. They are widely adapted throughout the world. They thrive and reproduce in tropical or cold climates and in humid as well as dry regions.

Their small size compared to cattle permits them to be maintained on a limited area of land. Goats transform feeds left behind by other species into meat, milk and fiber. They will consume a wide variety of grasses, weeds and leaves and small branches of bushes and trees. Goats also serve as scavengers, consuming discarded leaves, peelings and roots of vegetables, husks of corn, citrus and banana peelings and other waste plant residues that would otherwise cause pollution. About two-thirds of the feed energy used in producing these animals comes from substances which are undesirable, indigestible and inedible by humans.

Goats play a positive role in environmental protection, clearing away undesirable plant species. They reduce bush encroachment in rangeland areas.

Their small size makes them ideal for family milk and meat production. The milk is sufficient to contribute to the nutrition of children without having storage problems associated with the larger supplies from cattle. The meat can be consumed by a family before it spoils in warm climates where no refrigeration is available.

In addition to meat and milk, goats make important contributions to the world's supply of skins and of by-products such as blood and bone meal, horns and fertilizer. Goats in the developing nations contribute about 75% of the world's supply of goat skins.

There are negatives too. Uncontrolled grazing and or too many goats directly cause deterioration of rangelands. Goats are probably not the initial cause of rangeland deterioration, but they may be the primary culprit during the later stages of destruction. Uncontrolled goats can be destructive of household and neighborhood crops.

Goats have had and will continue to have an important role in agricultural development and food production on small farms around the world.



VOCABULARY

Buck:	Male Goat
Sire:	Father
Wether:	Castrated Male
Doe:	Female Goat
Dam:	Mother
Kid:	Young goat under six months of age
Kidding:	Giving birth
Doeling:	Female goat 6 to 12 months old
Buckling:	Male goat 6 to 12 months old
Yearling:	Any goat 12 to 24 months old
Purebred:	Both sire and dam belong to the same breed
Crossbred:	Sire and dam are of different breeds
Bush Goat:	Sire and dam are of unknown breeds (local goat)
Colostrum:	The first milk coming after kidding
Lactation Period:	Time during which milk is given
Gestation Period:	Time doe carries young before birth

REVIEW OF BREEDS

Most of the dairy goats in use today originated in the Middle East. There are some 60 recognized breeds. The vast majority of these are multipurpose animals.



The JAMNAPARI of Northern India is a dual purpose goat that has undergone some selection for milk production. Its coat color is white with patches of tan or black often on the head. It has a large convex face and large pendulous ears. The average milk yield is 160-200 kg over 210-240 days. The maximum yield is reported at 544 kg in 250 days.

Grade Jamnapari female goat, Surabaya, Indonesia

The BEETAL is a large spotted black goat of the Punjab in India. It has large pendulous ears, a Roman nose and wattles usually present on both sides of the lower neck. Milk yield averages 140-230 kg in 150-225 days. Maximum yield reported for a Beetal is 592 kg in 177 days.

The BARBARI, Often called the dwarf milk goat, is a white or spotted fawn goat of Northern India. The ears are small and erect. They are considered prolific breeders. Milk production is lower, averaging 100-700 kg in 200-250 days.

The DAMASCUS is a red goat of the eastern Mediterranean region. The does are polled or horned and have tassels hanging from the lower neck. Milk production is usually highest during the sixth lactation. Average milk yield ranges from 400 to 500 kg over a lactation of 238-263 days.

The SUDANESE Nubian originated in East Africa. It has the typical Nubian convex face with large ears. Color markings vary. Average milk yields are low, about 1-1.25 kg per day, but usually only 60 kg per lactation.

The BLACK BENGAL is an interesting breed since it has a number of outstanding features. These goats are found in Bengal, India and in the northern part of East Pakistan where they are very widely distributed. The breed is economically important because in addition to its production of meat of high quality, it also produces a skin for which there is considerable demand. The skin is used extensively for making high quality shoes.

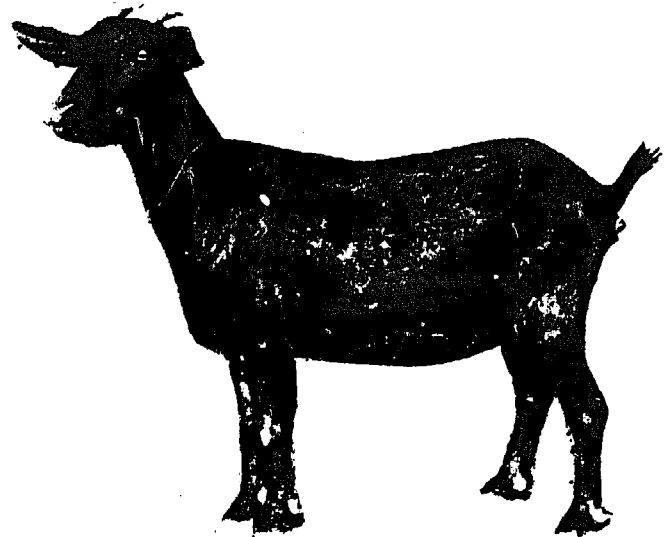

West African Dwarf goats; the doe on the right had 12 kids and reared 11, in 4 kidding at intervals of 6 months.

DWARF GOATS with disproportionately short legs, which are often bent, occur in and near the tropical forest belt in West and Central Africa. A typical example is the Fonta Djallon or WEST AFRICAN DWARF GOAT. These are about 50 cm in height and 20 kg in weight. Growth rate and milk yield are very low, but twin and triplet births are common and they breed at all times of the year. They are used almost exclusively for meat production. Dwarf goats are Tsetse fly resistant.

EUROPEAN - USA BREEDS - "EXOTICS"

European Breeds were introduced to the United States and other areas as the quickest means for increasing milk production. These breeds are generally above average in size with mature does weighing 45-55 kg and bucks 60-75 kg. Milk production ranges from 350-900 kg in a 300 day lactation.

Four European breeds - Saanen, Nubian, Alpine and Toggenburg - will be the focal point for this course. They will be considered both as purebred producers and for their potential in crossing with local goats such as the African Dwarf.

**SAANEN - Average lactation
800-900 kg in 275-300 days.***

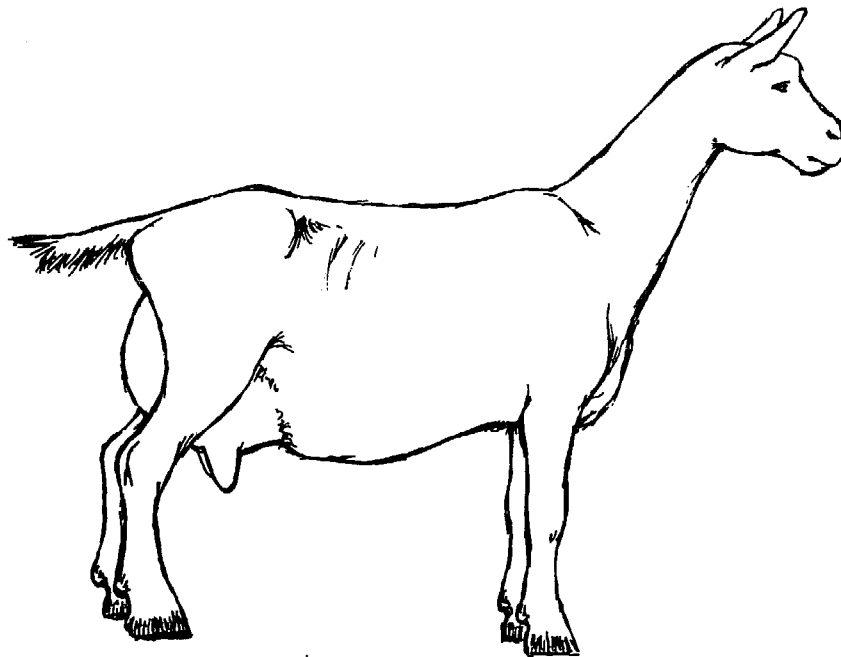

The Saanen is a large animal of strong bone. The breed originated in Switzerland with records indicating that the first imports to the United States were in 1904. It is an all white or creamy-colored animal. The face is straight, the ears are upright and alert. The hair is short and fine. Saanens are vigorous animals and high producers.

* Milk production figures indicate amounts which will be high for animals receiving limited protein and energy supplements. On the other hand, they will be low for herds on heavy concentrate diets.

ALPINE - Average lactation
600-900 kg in 250-305 days.

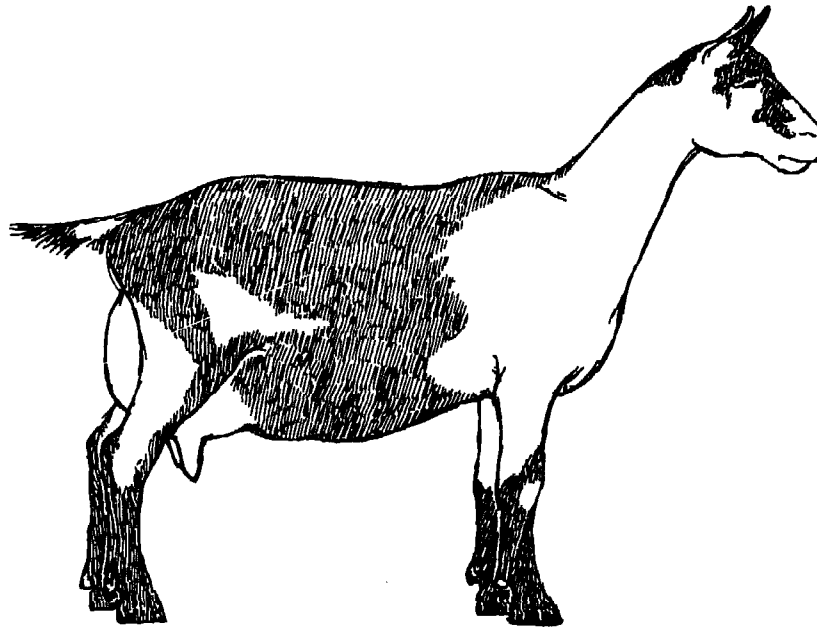

The French Alpine originated in the French Alps, and most goats of the Alpine type were imported to the United States from France. They are medium to large in size and are hardy and adaptable animals, thriving in many climates. The face is either straight or slightly dished. The color patterns can vary. The French Alpine is described in the following terms:

Cou Blanc - (coo blanc) this means literally "white neck" - the frontquarters are white and the hindquarters are black, with black or gray markings on head.

Cou Clair - (coo clair) the literal translation is "clear neck" - frontquarters are tan or off-white, or a shading to gray with black hindquarters.

Cou Noir - (coo nwah) literally "black neck" - black frontquarters and white hindquarters.

Sundgau - (sundgow) black with white markings such as belly and facial trim.

Pied - spotted or mottled.

Chamoisee - (shamwahzay) brown or bay - often with black face, dorsal stripe, feet and legs. On a buck this is spelled chamoise.

TOGGENBURG

Average Lactation - 600-900 kg 275-305 days

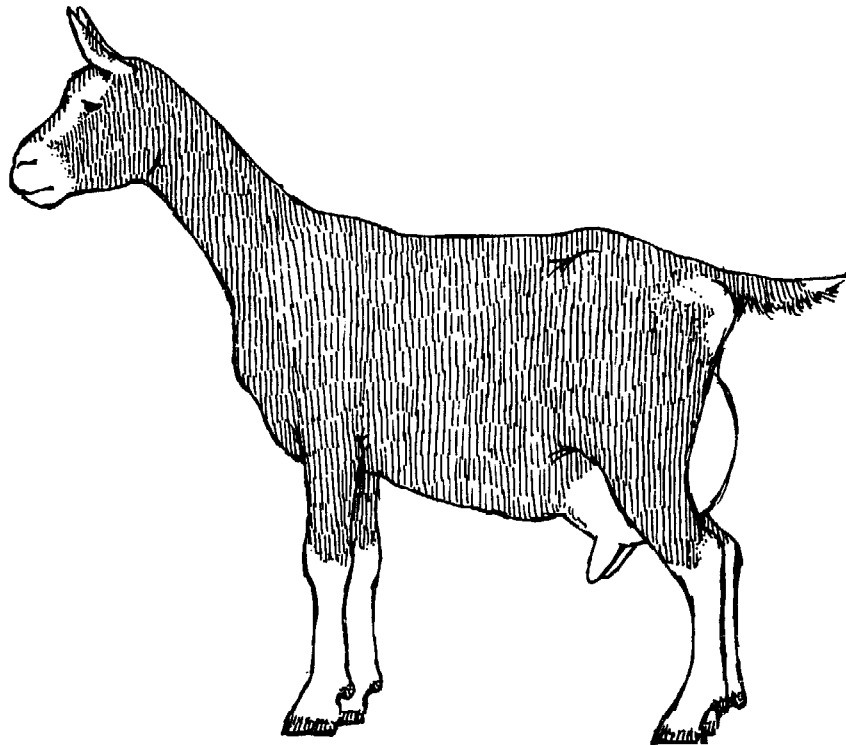

The Toggenburg is a Swiss breed from the Toggenburg Valley in Switzerland. It has been called the oldest breed of Switzerland and was one of the first to be imported to the United States. It is a medium size and sturdy in appearance. The hair is usually short to medium and is fine and soft. However, some individuals have a heavy hair coat. The color varies from light fawn to dark chocolate. The distinct white markings are two white stripes down the face from above each eye to the muzzle; hind legs white from hocks to hooves; forelegs white from knees downward with dark below the knee acceptable; a white triangle on either side of the tail; a white spot may be at root of wattles* or in that area if no wattles are present. The ears are erect and carried forward. The nose is straight or slightly dished.

* Wattles are small appendages, usually hanging from the neck of a goat, but may appear anywhere about the head and neck. They do not appear on all goats and are hereditary. They serve no purpose and are often removed during the first few weeks as they are subject to getting caught in fences, etc. (see goat on page 14)

**NUBIAN - Average lactation
700-900 kg in 275-300 days.
Milk has high butterfat content.**

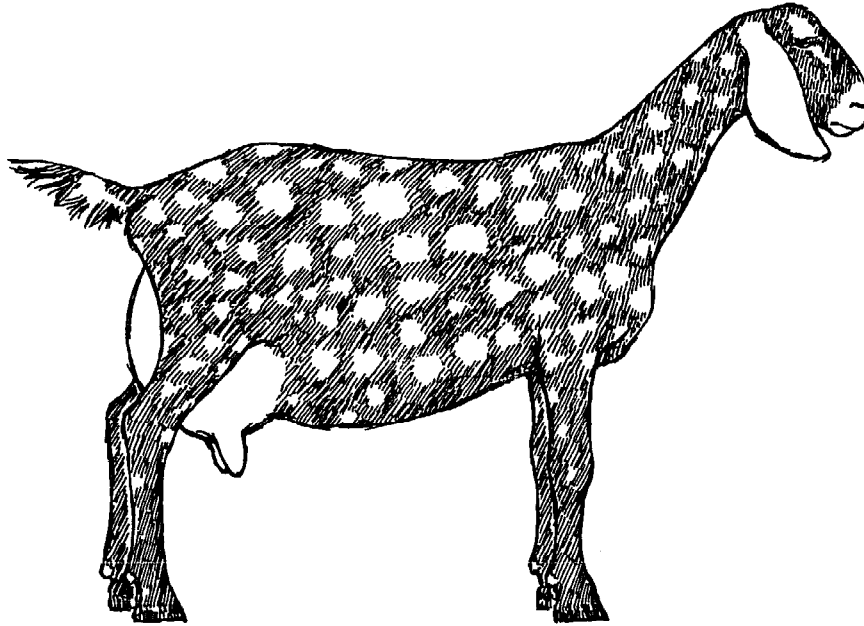

The Nubian is a relatively large, graceful dairy goat. It is said to be of Oriental origin. Its distinguishing characteristic is the head. The profile between the eyes and the muzzle is strongly convex, creating its Roman nose. The ears are long, wide and pendulous. They lie close to the head at the temple and gently flare out and forward. The hair is short and glossy. The colors vary greatly, with black, tan or red colors predominating. Any color or pattern is acceptable.

Nubians often adjust more readily to extreme heat.

BREED SIZE STANDARDS

<u>Breed</u>	<u>Min. Height Mature Does</u>		<u>Min. Weight Mature Does</u>		<u>Min. Height Mature Bucks</u>		<u>Min. Weight Mature Bucks</u>	
Alpine	76.2 cm	30"	61.3 kg	135 lbs	81.2 cm	32"	77.2 kg	170 lbs
Nubian	76.2 cm	30"	61.3 kg	135 lbs	81.2 cm	32"	77.2 kg	170 lbs
Saanen	76.2 cm	30"	61.3 kg	135 lbs	81.2 cm	32"	77.2 kg	170 lbs
Toggenburg	66.0 cm	26"	54.5 kg	120 lbs	71.1 cm	28"	68.1 kg	150 lbs

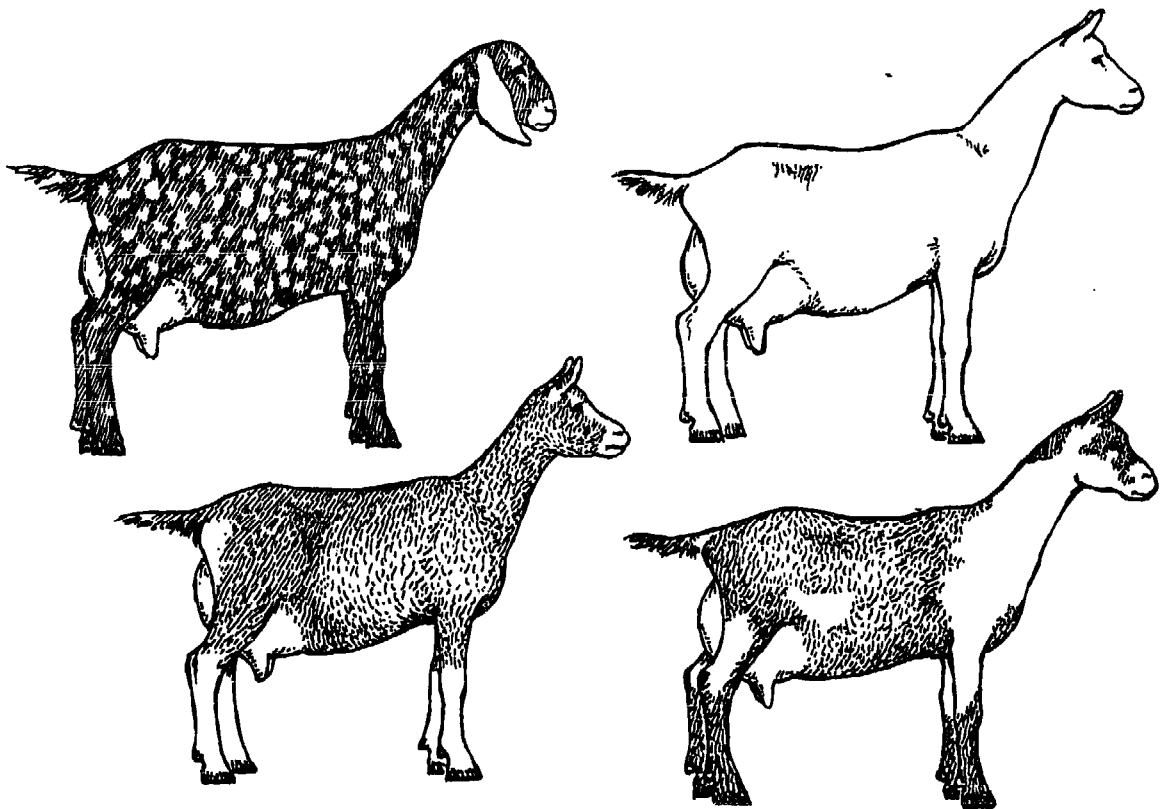



LESSON I - INTRODUCTION TO DAIRY GOATS

- 1) What are the benefits of owning a dairy goat?
 - a) **Nutritional** - While forty-nine per cent of the world's population drink goats' milk, eighty per cent of children in rural areas do not have milk or milk products. A dairy goat will help provide milk for good health in children and adults. Dairy goat milk provides protein and calcium. The fat in goats' milk is in smaller pieces than in cows' milk and is easier to digest. It is very good for people who have stomach (gastric) problems and for babies, small children and older people. One or two goats produce enough milk for a family. Since the milk can be used in a day, refrigeration is not required. Pasteurization of the milk is recommended, particularly in areas where regular tests for Tuberculosis and Brucellosis are not available for the animals.
 - What is Protein? Protein in our diet builds strong bones, teeth, hair and muscle.
 - What foods are high in protein? Beans, meat, eggs, and milk -- milk, meat and eggs are complete proteins. Beans eaten with rice make a more complete protein.
 - What is Calcium? Calcium is a mineral used to make bones and teeth. Without it children get weak, have crooked bones and bad teeth. Older people who do not have enough calcium in their diet have bones that break easily. Children often complain of "growing pains."
 - What does one liter of goats' milk a day provide?
 - all the protein a child needs to age six
 - 60% of the protein a child needs to age 14
 - half the protein a child age 14-20 needs
 - all the calcium a child to age 10 needs
 - almost all the calcium a child age 10-18 needs
 - all the calcium old people need
 - What does goat meat provide? Good nutrition - plenty of protein and important vitamins and minerals.
 - b) **Economic** - If you care for your dairy goat properly and give her plenty of green chop (forage), she will give you at least a liter of milk every day for 300 days each year. She will also give you one or two kid goats each year which you can sell, use for meat or raise for additional milk producers. If you give your dairy goat rice bran, wheat bran, cottonseed cake or other protein supplements, she will give more milk. If you have extra milk you can make cheese to eat or sell. You can also sell the horns and skin from your goats.

- c) **Fertilizer** - If you put the manure and urine collected from your goats on your garden, it will improve the soil and make the garden grow better. You can put the manure directly on your garden and mix it into the soil or put the manure in a bucket, cover with water and the next day pour the "tea" on your plants.

Whey is the by-product of cheesemaking. It can be fed to pigs or chickens. Whey can also be used to fertilize your crops. Put approximately 2.54 cm or 1 inch of whey on the first year. Individual applications can be put at half this amount. Do not put on growing foliage. Whey is a complete fertilizer similar to manure. Apply whey to the same crops you would apply manure. Apply at rates consistent with nitrogen needs.

- d) **Pleasure** - Holidays and special occasions are times when goat meat is appreciated. Children and adults enjoy goats. They are affectionate, intelligent and energetic. They enjoy climbing on rocks. They like to go for walks with the person who cares for them. Goats are easier to keep clean than cows.

2) What are the problems of owning a dairy goat?

- a) She must be fed plenty of green chop (forage) at least twice a day. A mature goat needs to have green feed before her as often as possible to produce plenty of milk.
- b) A dairy goat needs plenty of water - 6-8 liters a day.
- c) A dairy goat needs milking twice a day - morning and evening. You will get more milk if you milk your goat twice a day than if you only milk once.
- d) A dairy goat who is not tethered (tied) may get into your garden or even worse your neighbor's garden. If she is not tied, she needs a fenced paddock. If you tie your goat you need to move her several times each day.



12 Introduction to Dairy Goats

- e) You will have to care for your goat when she is sick.
 - f) You will need to find a good buck to breed her once a year.
 - g) You will have to find someone to care for her while you are away.
- 3). How does a dairy goat differ from a local (bush, country) goat?
- a) local goats range freely
 - b) local goats receive no supplements
 - c) local goats have no special shelter
 - d) local goats produce only enough milk to raise the kids.
- 4) Identify the parts of the goat's body.

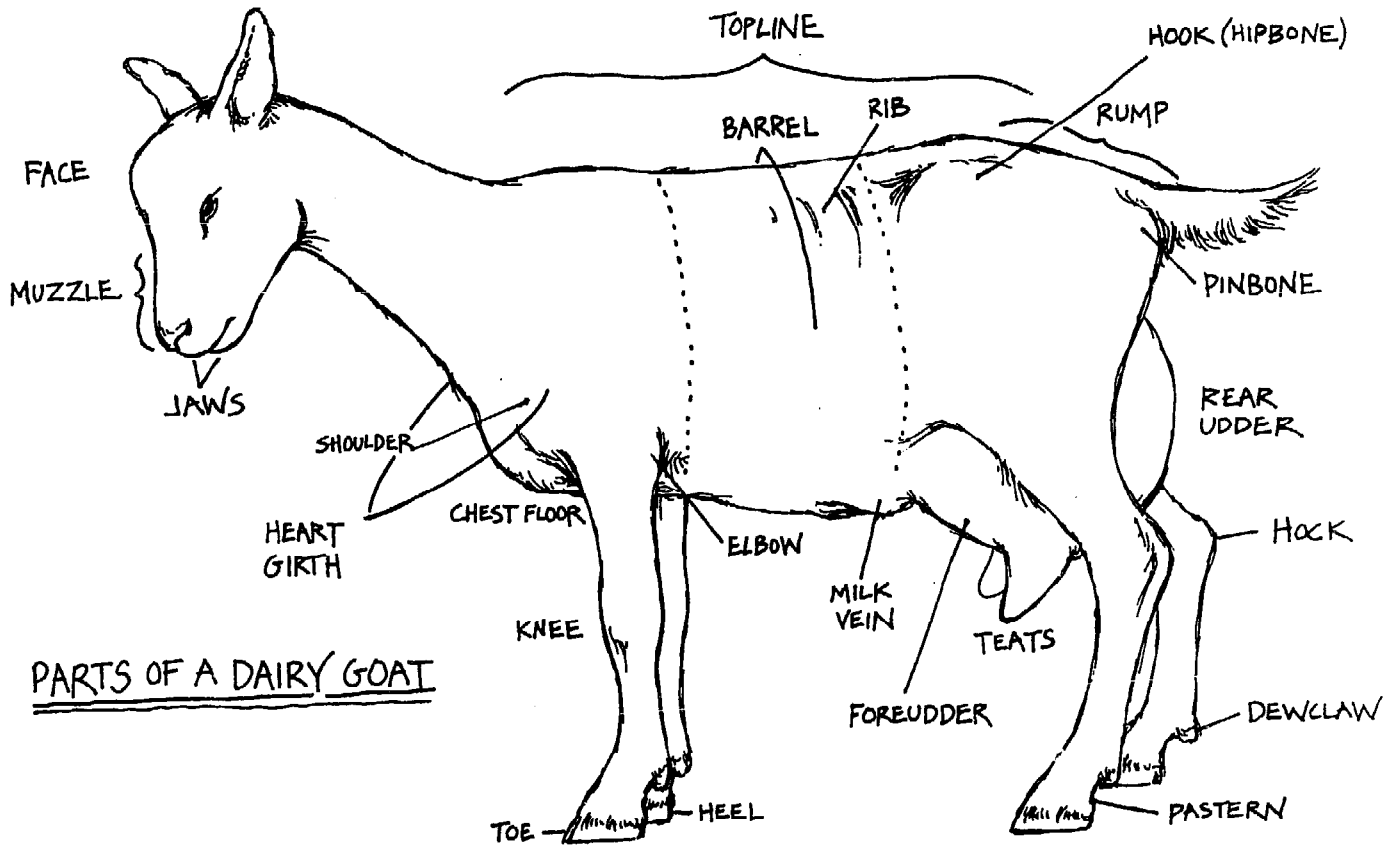

**USE THE DIAGRAM BELOW TO PRACTICE IDENTIFYING
THE PARTS OF A GOAT'S BODY:**

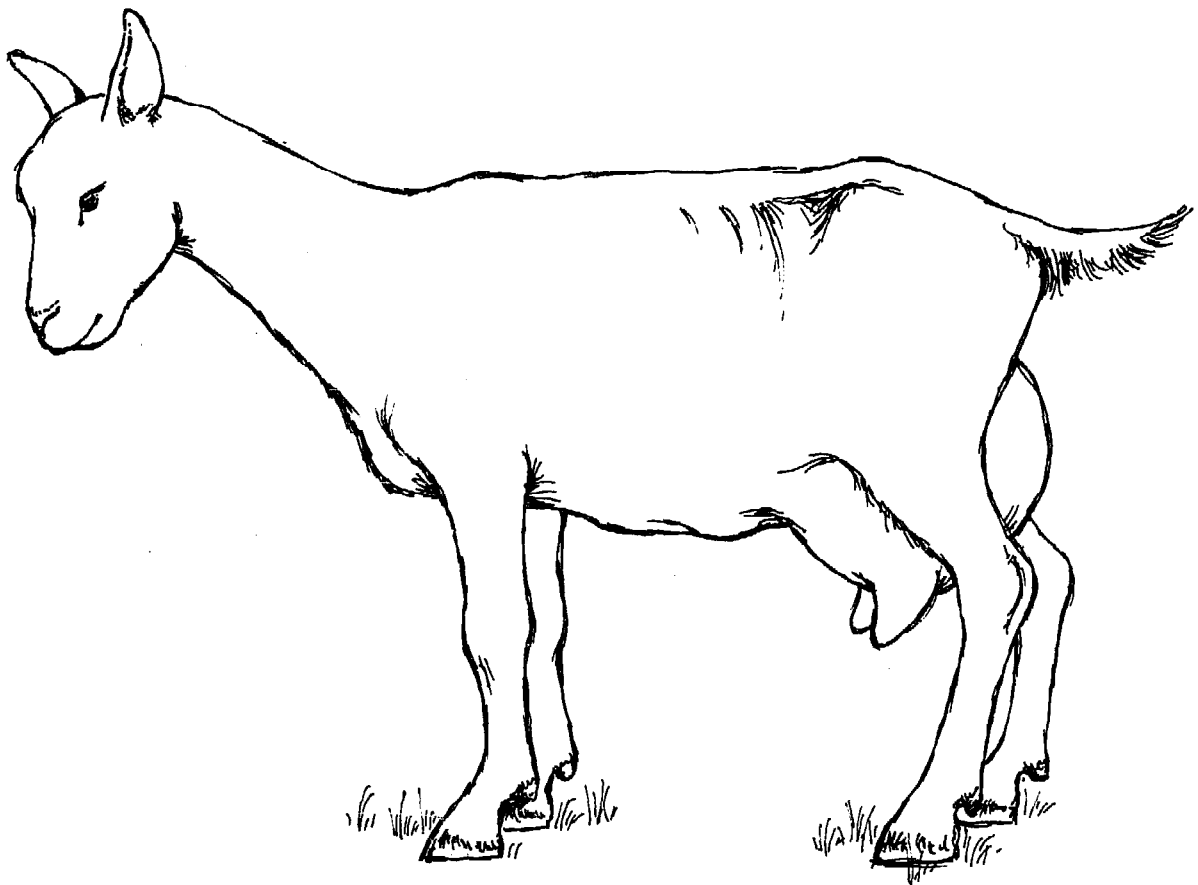

6) How do you select a good dairy goat?

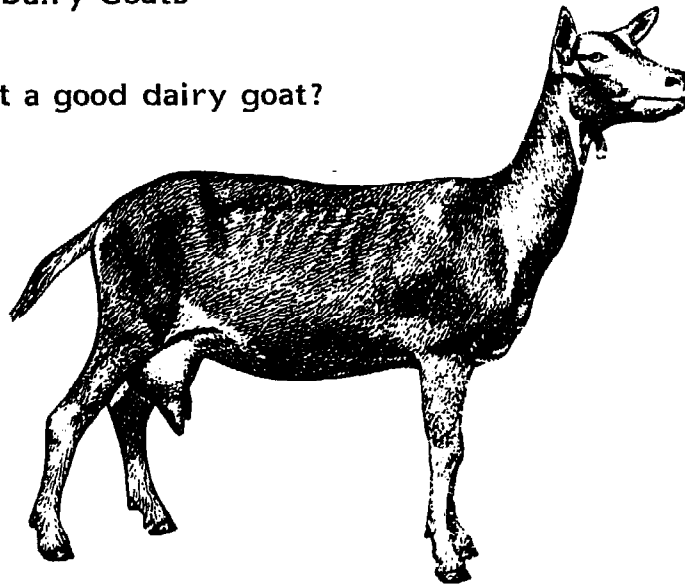

The goat pictured above has excellent dairy qualities.

- a) a dairy doe (female) should have feminine characteristics. She should have fine features - not like a male - not coarse.
- b) straight top line - feel individual vertebrae - sharp withers not fat
- c) long rump - not too steep
- d) wide chest - plenty of space for lungs to breathe and heart to pump blood
- e) bright sleek coat
- f) plenty of capacity for feed and kids; open ribs
- g) large heart girth
- h) straight legs - hips prominent, pins sharp
- i) strong muzzle - jaw not undershot or overshot
- j) loose, pliable coat
- k) alert, bright eyes
- l) she should walk soundly with no trace of a limp
- m) a dairy goat's udder should blend smoothly with the body wall and be securely bound across the entire upper surface. It is carried well forward, sloping gently into a gradual upward curve. The rear udder attachment is high, wide, firm and strong. It is firmly fastened at a wide escutcheon.

Here are examples of a good udder

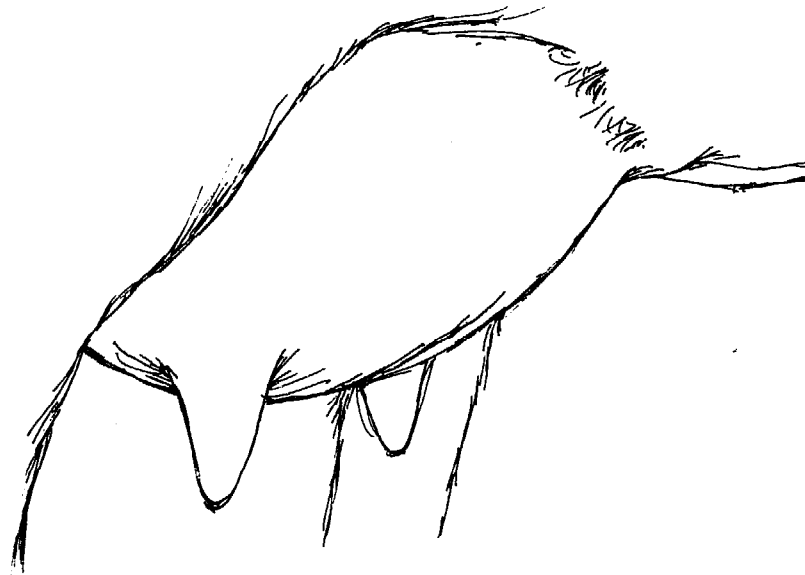
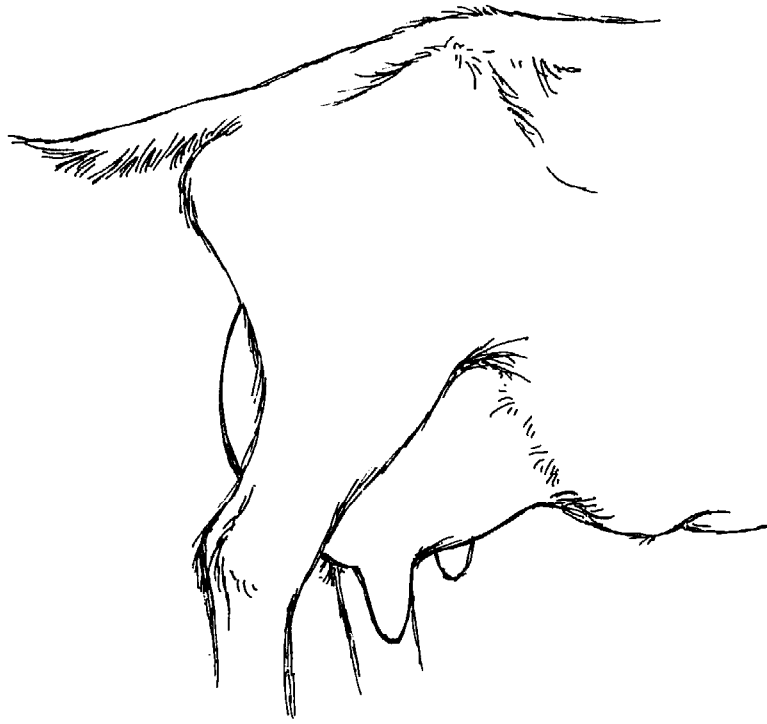

Look for good conformation in your bucks.

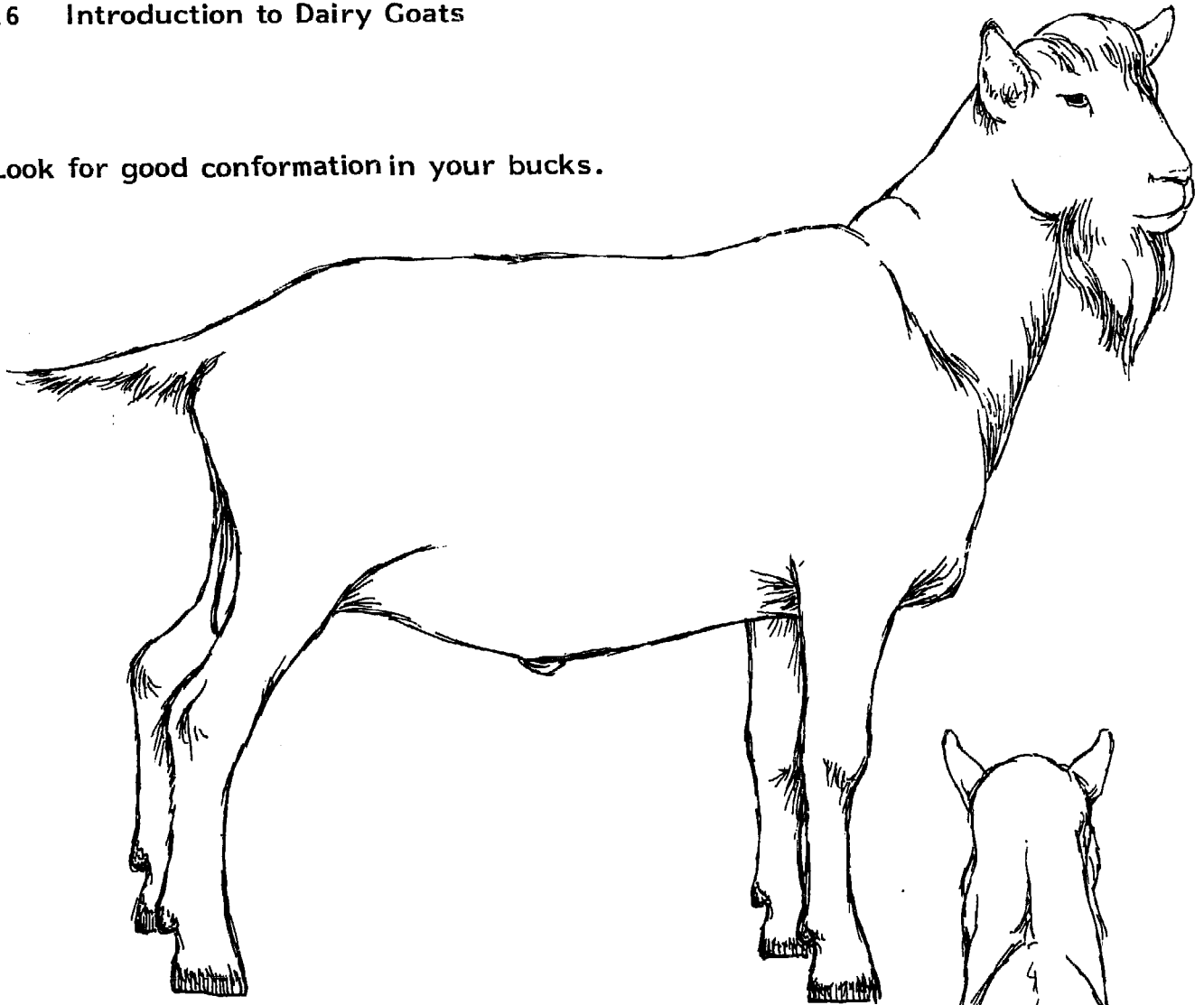

7) Evaluating Bucks - When you select a buck to breed your doe, be sure he is in good health.

- a) The buck should be masculine. His head should be medium in length. He should have a broad muzzle with large open nostrils. His eyes should be bright.
- b) His back should be strong and straight. His rump long, wide and nearly level. He should have strong legs and feet. His legs should be wide apart and squarely set.
- c) The buck should have two testicles of appropriate size. Visible parts of the reproductive system should show no evidence of disease or disability.
- d) Two rudimentary teats of uniform size should be squarely placed below a wide, arched escutcheon.
- e) A buck should have dairy character and show animation, general openness and freedom from excess tissue. He should have a large body capacity to provide ample digestive capacity, strength and vigor.



8) Determining the Age of Goats

Sometimes when we look at a dairy goat, it is helpful to know the age. We can determine this by looking at the goat's teeth.

Goats have no teeth in the upper jaw. The lower jaw has eight front teeth. Toward the back of the mouth goats have large teeth called molars to chew the grass.

The front teeth are small and sharp in animals less than one year of age. At about one year, the center pair of teeth will drop out and are replaced by two large permanent teeth. At about two years, two more large front teeth appear, one on each side of the first two yearling teeth. The three to four year old has six permanent teeth. The four to five year olds have a complete set of eight permanent teeth in front.

After this age, the approximate age can be told by the amount of wear in the front teeth. As the animal gets older, the teeth spread apart and finally become loose and some drop out. At this age the animal begins to lose its usefulness as a grazing animal. It may be kept and fed specially prepared feeds if the animal is still capable of reproduction. (Colby, Dairy Goats, Breeding, Feeding, Management)

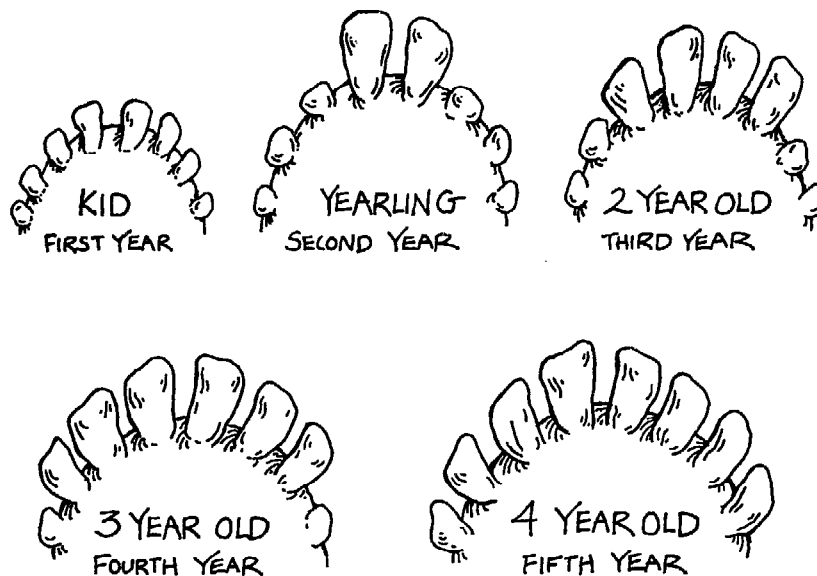

- 9) To determine the weight of a goat, measure the goat around the heart girth. Pull the tape tightly.

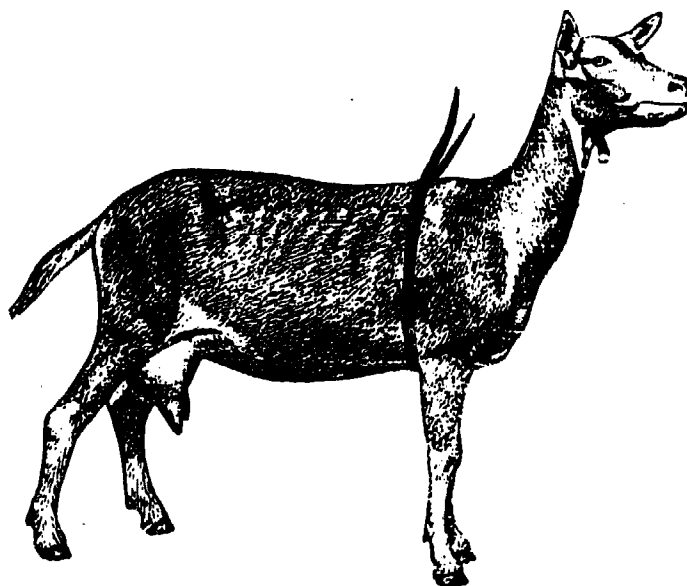

WEIGHT CHART

Inches	Centimetres	Pounds	Kg.	Inches	Centimetres	Pounds	Kg.
10- $\frac{1}{4}$	27.3	5	2.27	26- $\frac{1}{4}$	66.7	63	28.57
11- $\frac{1}{4}$	28.6	5- $\frac{1}{2}$	2.49	26- $\frac{3}{4}$	67.9	66	29.93
11- $\frac{3}{4}$	29.9	6	2.73	27- $\frac{1}{4}$	69.2	69	31.29
12- $\frac{1}{4}$	31.1	6- $\frac{1}{2}$	2.95	27- $\frac{3}{4}$	70.5	72	32.65
12- $\frac{3}{4}$	32.4	7	3.17	28- $\frac{1}{4}$	71.7	75	34.01
13- $\frac{1}{4}$	33.7	8	3.63	28- $\frac{3}{4}$	73.0	78	35.37
13- $\frac{3}{4}$	34.9	9	4.08	29- $\frac{1}{4}$	74.3	81	36.73
14- $\frac{1}{4}$	36.2	10	4.54	29- $\frac{3}{4}$	75.6	84	38.10
14- $\frac{3}{4}$	37.5	11	4.99	30- $\frac{1}{4}$	76.8	87	39.46
15- $\frac{1}{4}$	38.7	12	5.44	30- $\frac{3}{4}$	78.0	90	40.82
15- $\frac{3}{4}$	40.0	13	5.90				
16- $\frac{1}{4}$	41.3	15	6.80	31- $\frac{1}{4}$	79.4	93	42.18
16- $\frac{3}{4}$	42.7	17	7.71	31- $\frac{3}{4}$	80.7	97	44.00
17- $\frac{1}{4}$	43.8	19	8.62	32- $\frac{1}{4}$	81.9	101	45.80
17- $\frac{3}{4}$	45.1	21	9.52	32- $\frac{3}{4}$	83.2	105	47.62
18- $\frac{1}{4}$	46.4	23	10.43	33- $\frac{1}{4}$	84.5	110	49.89
18- $\frac{3}{4}$	47.6	25	11.34	33- $\frac{3}{4}$	85.7	115	52.15
19- $\frac{1}{4}$	48.9	27	12.24	34- $\frac{1}{4}$	87.0	120	54.42
19- $\frac{3}{4}$	50.2	29	13.15	34- $\frac{3}{4}$	88.3	125	56.69
20- $\frac{1}{4}$	51.4	31	14.06	35- $\frac{1}{4}$	89.5	130	58.96
20- $\frac{3}{4}$	52.7	33	14.97	35- $\frac{3}{4}$	90.8	135	61.22
21- $\frac{1}{4}$	53.9	35	15.87				
21- $\frac{3}{4}$	55.3	37	16.78	36- $\frac{1}{4}$	92.1	140	63.49
22- $\frac{1}{4}$	56.5	39	17.69	36- $\frac{3}{4}$	93.4	145	65.76
22- $\frac{3}{4}$	57.8	42	19.05	37- $\frac{1}{4}$	94.6	150	68.08
23- $\frac{1}{4}$	59.1	45	20.41	37- $\frac{3}{4}$	95.9	155	70.29
23- $\frac{3}{4}$	60.3	48	21.77	38- $\frac{1}{4}$	97.2	160	72.56
24- $\frac{1}{4}$	61.6	51	23.13	38- $\frac{3}{4}$	98.4	165	74.83
24- $\frac{3}{4}$	62.9	54	24.49	39- $\frac{1}{4}$	99.7	170	77.10
25- $\frac{1}{4}$	64.1	57	25.85	39- $\frac{3}{4}$	101.0	175	79.37
25- $\frac{3}{4}$	65.4	60	27.21	40- $\frac{1}{4}$	102.2	180	81.63
				40- $\frac{3}{4}$	103.5	185	83.90
				41- $\frac{1}{4}$	104.8	190	86.17
				41- $\frac{3}{4}$	106.1	195	88.44

GROWTH RECORDS

It is important to keep growth records. This helps you to determine if kids are developing properly.

<u>Age</u>	<u>Kg</u>	<u>Lbs</u>
Birth	3.8	8
1 mo.	9.4	21
2 mo.	14.4	32
4 mo.	25.6	57
6 mo.	32.8	73
12 mo.	48.6	108
18 mo.	61.4	136
21 mo.	64.8	144



Although these figures are not necessarily offered as the "ideal", they should give you some indication as to average growth patterns.

Source: Adapted from Dairy Goat Journal, April 1971

TASKS FOR LESSON 1:

- 1) Work with another person to identify the parts of a goat's body.
- 2) Use the teeth chart to determine a goat's age.
- 3) Select a goat and use the observation sheet.

OBSERVATION SHEET

Additional Observation Sheets will be found at the end of the manual.

Name of goat to be observed _____

Tag Number (if any) _____ Tattoo _____ Sex _____

Breed _____ Age _____

If Female: Bred _____ Open _____ Date Due to Kid _____

If Male: Check testicles to be sure both are descended. Check general condition of reproductive organs.

Current Feeding Schedule _____

Weight _____ Compare with projected weights on Page 19 of Manual.

Treated for parasites _____ When _____ Medication _____

Each day observe the following and record:

- 1) General Appearance
- 2) Activity Level
- 3) Legs and Hooves
- 4) Any external problems such as abscesses, parasites, etc.
- 5) Condition of eyes, nose, mouth
- 6) Condition of feces (droppings) - pellet-like, ploppy, loose, diarrhea
- 7) Milk Production - if lactating _____ kilos per day
 _____ liters per day

Any signs of mastitis

- 8) Eating habits
- 9) Check any of the following signs of illness:

- | | |
|----------------------------|-----------------------------------------------|
| _____ off feed | _____ standing off from group |
| _____ dehydration | _____ abnormal temperature |
| _____ limping | _____ pale mucosa around eyes and in mouth |
| _____ blindness | _____ heavy mucous in nose or mouth |
| _____ diarrhea | _____ no sign of cud chewing |
| _____ runny eyes | _____ swelling at any point in body |
| _____ circling movements | _____ hair falling out or rough in appearance |
| _____ clots or bloody milk | |

LESSON II - HOUSING, FEEDERS AND CONTAINMENT

I) HOUSING

Housing for your goats should have a dry floor and good ventilation. The housing should protect your goats from the sun and rain.

Stilted housing is common where rainfall is heavy and goats need protection against possible waterlogging. In this type of housing the floor of the pen is raised about 1-1.5 meters above ground level. This facilitates easy cleaning and collection of manure and urine. Slatted floors are one of the components of this type of housing.

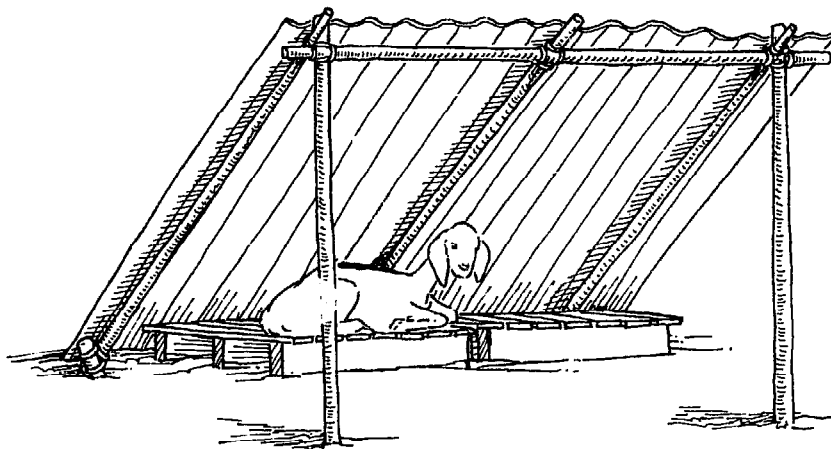

The ground-level house with a dirt floor takes several forms. It may be a lean-to type of building. In this type of housing the buildings are about 2-3 meters high, sloping to about 1-1.5 meters behind. The floor can be made out of rough concrete, but more commonly is packed clay or earth. If you put a drainage ditch around the housing, it will keep the floor dry during heavy rains. If you use a dirt floor, make pallets or sleeping benches for your goats to rest on.

Whatever the type of housing, it must be light, well-ventilated, and easily cleaned. Materials must be suitable to local conditions.

(Above paragraphs adapted from C. Devendra - Goat Production in the Tropics.)

Housing for bucks should be separate from the does. Having a buck near the milking area will give the milk a bad taste. His building can be small, but he should have an outside pen and dry floor. He can also have a pallet to sleep on and should have appropriate mangers and feeders.

Kids should be separated from the doe by the age of two weeks. Up to six weeks of age, they can be kept in one meter boxes which have solid sides. These should be cleaned daily, but are good in that they keep the kids from drafts. The kids should have small mangers and feeders.

Each mature goat needs:

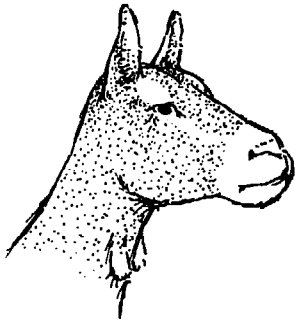

- 1.5 meters by 1 meter of space
- shelter from rain, heavy winds and too much sun
- a dry floor - well drained soil works well
 - a slatted floor should be wide enough for manure to fall through, but narrow enough that a goat's legs do not get caught
 - housing designed for easy manure removal
 - good ventilation. Hot air rises, so make openings high to prevent drafts
 - a pallet or sleeping bench
 - exercise

2) MANGERS AND FEEDING EQUIPMENT

The most important thing about the manger is that it keeps the green chop, hay or vegetable cuttings off the ground so that they will not be contaminated. There are many different kinds of mangers. They must be built suitable to the goat's size and in such a way that the goats cannot contaminate them with their feet.

Slatted Feeder

If slatted feeders are too high above the goat's head, the dust from the hay can irritate the goat's eyes. There will always be some waste in this type of feeder as the hay which falls on the ground will be wasted. Put a bar on the top. Otherwise the goats may sleep in the feeder.

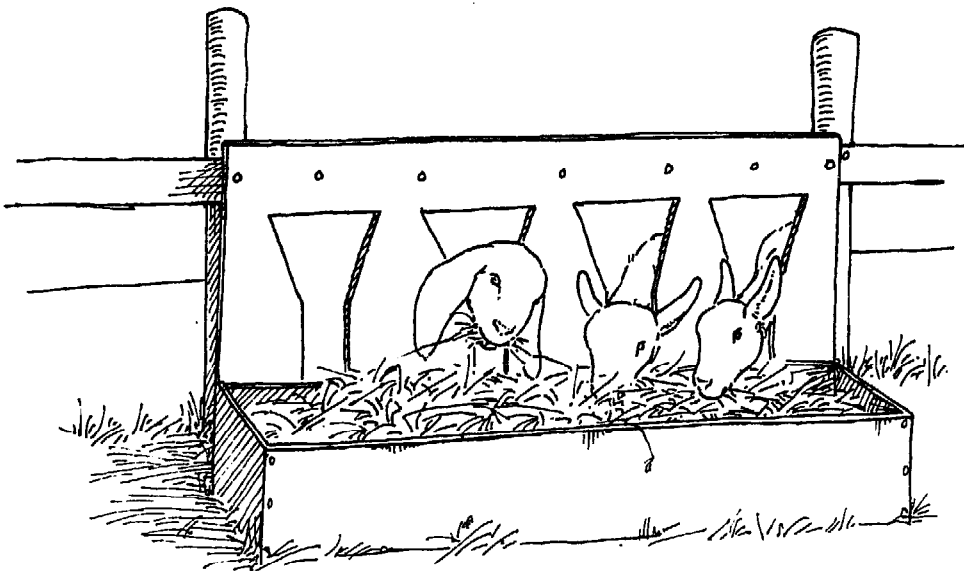
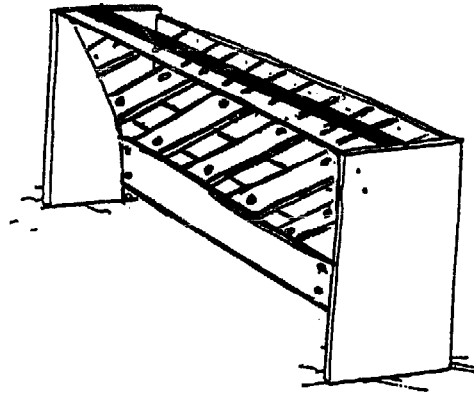

Keyhole Feeder

Keyhole feeders prevent contamination of the feed. Waste is further prevented if a box can be placed on the opposite side from the keyholes.

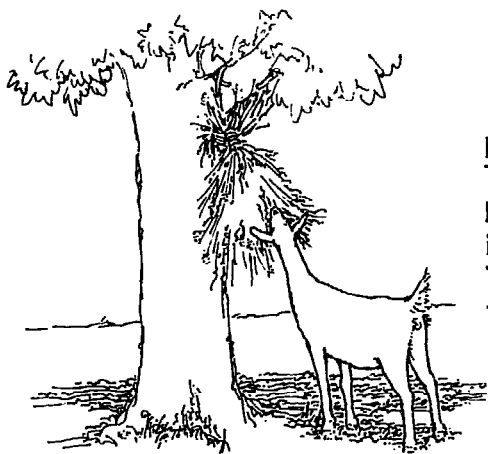

Hay Can Be Tied

Hay can be tied to the pen or on a tree branch if you do not have a manger or keyhole feeder. The important thing is that the hay is kept off the ground. Be sure the rope is tied in such a way that when the hay is gone the goat cannot be strangled by the rope.

Water Buckets

Water buckets are very important. They should be kept clean and should be low enough to be reached by small animals. For larger animals hanging the buckets above the ground keeps the water from being soiled. Water buckets can also be placed outside the pen with access through keyhole opening.

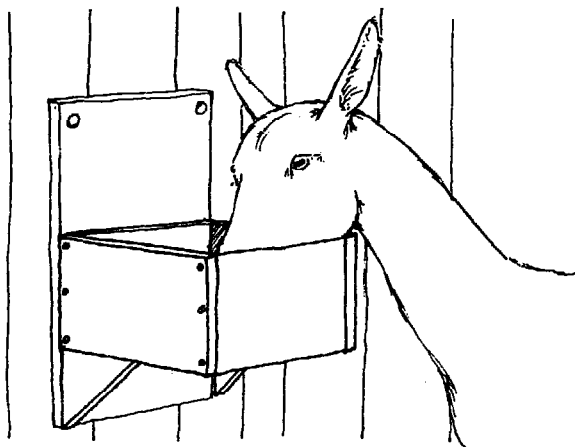
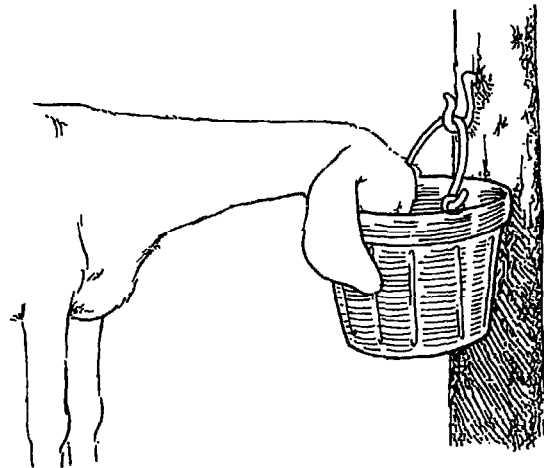

Salt Boxes

Mineral salt should be offered free choice and be kept in a container which is off the ground. This can be a small wooden box. If mineral salt is not available, then give common salt to your animals.

3) CONTAINMENT

Fencing must be strong and high enough to contain a goat. Wire fencing is expensive so you will probably want to make your fences from bamboo or other small timbers. A living fence can be planted. The top of the fence often can be cut and used for forage. *Leucaena* (Ipil-Ipil) is one example.

Tethering or tying a goat is a popular way of keeping the animal. When a goat is tethered it is important to see that the goat can get into the shade and be moved often so that it can get enough feed. A running tether is

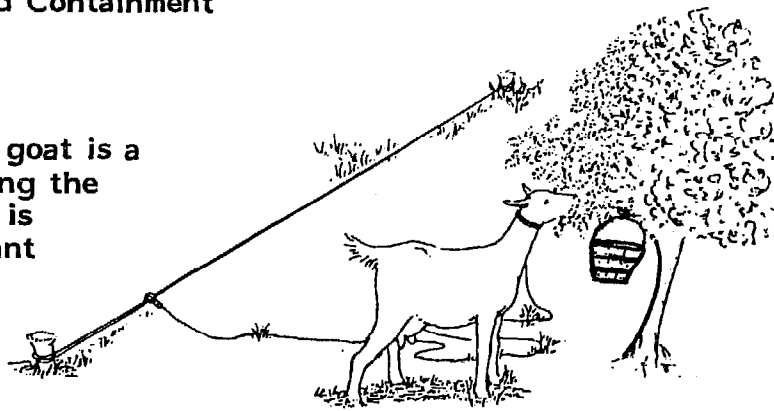

one which has a long wire or rope staked at both ends. The tether is attached with some kind of ring. This gives the goat opportunity to forage in a wider area.

Be sure water is available.

Do not tether your animal if dogs or wild animals may attack.

Be sure to check for any poisonous plants.

Herding

There may be times when you want to herd your goats so they can get different varieties of forage.

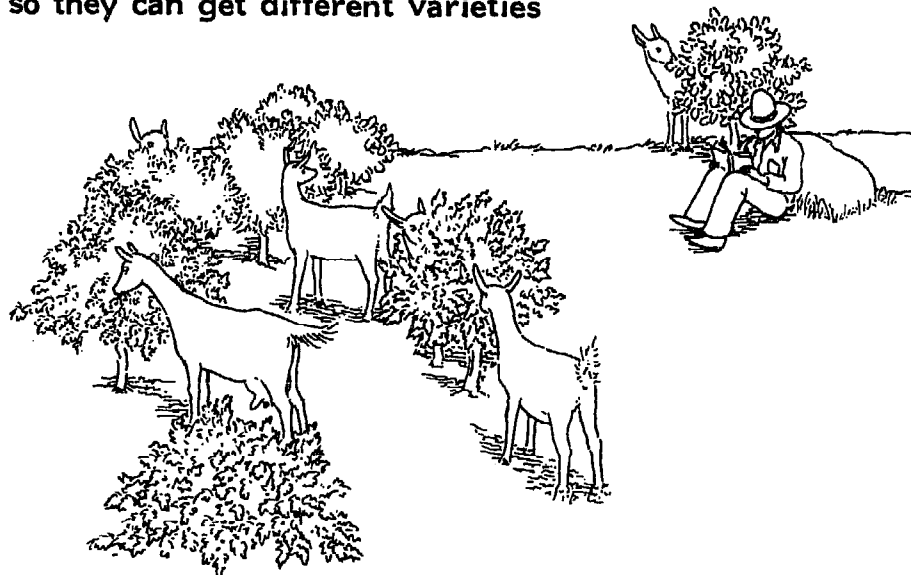

4) MILKING EQUIPMENT

You will need the following equipment and supplies for milking your goat:

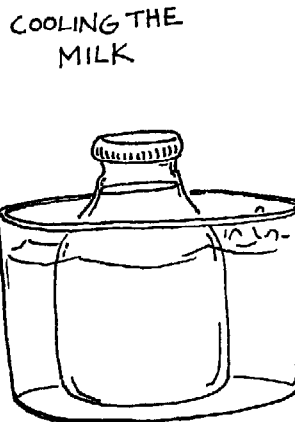
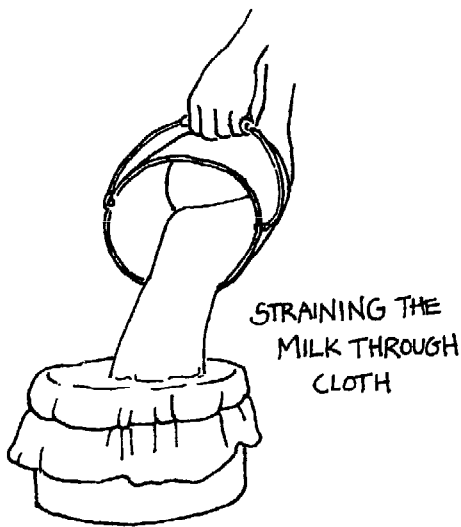
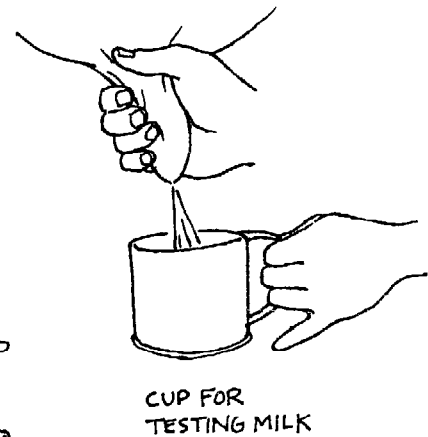
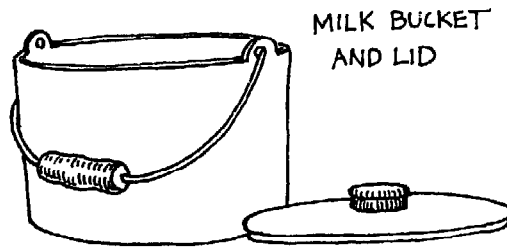
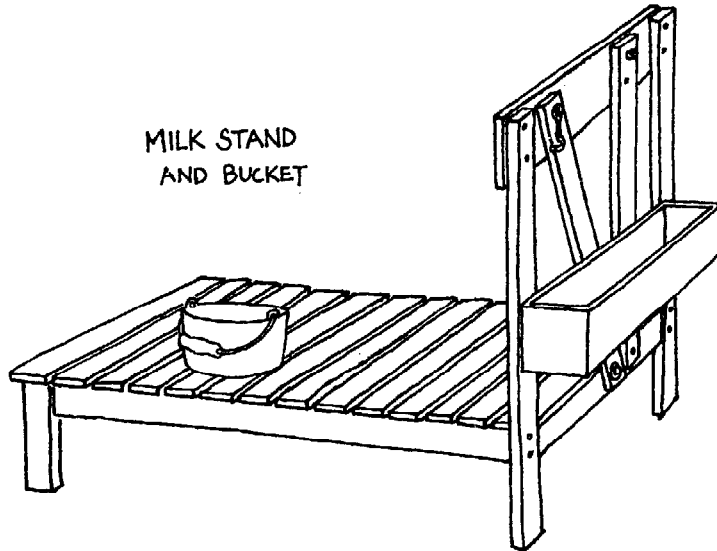

LESSON III - FEEDING

The dairy goat requires five major classes of nutrients - energy, protein, minerals, vitamins and water. Fiber is also important in the diet.

Dairy goats are energetic, inquisitive and versatile in the art of food gathering. They can consume large amounts of browse (tree leaves, bushes, twigs, etc.) in contrast to cattle and sheep who prefer grasses and legumes.

Their mobile upper lip enables them to discriminate select favored parts of plants. Goats chew their food more completely than cattle and therefore can obtain a higher per cent of digestible material from their diet.

1) The Ruminant Digestive System

Goats are ruminant animals. This means they chew their cud. Cows are ruminants. Sheep are ruminants. Ruminants are animals with four stomachs. This means they can eat grasses and feeds that are not digestible by one stomach animals. A pig and a chicken have only one stomach. Their digestive system is called monogastric.

To feed, the goat grips the grass or forage with the upper jaw and teeth in the lower jaw and jerks its head to pull out the grass.

It does not chew the grass, but swallows it and the grass goes into the first stomach (rumen).

Grass comes back into the mouth to be chewed for a long time. This is called "chewing the cud." Then it goes to the second stomach (reticulum) and to the third stomach (omasum) and fourth stomach (abomasum).

Ruminants can eat grass, bush, corn stocks and all kinds of products that humans and single stomach animals cannot eat. They then transform these roughages into milk and meat which provide protein, calcium, vitamins and minerals for human growth.

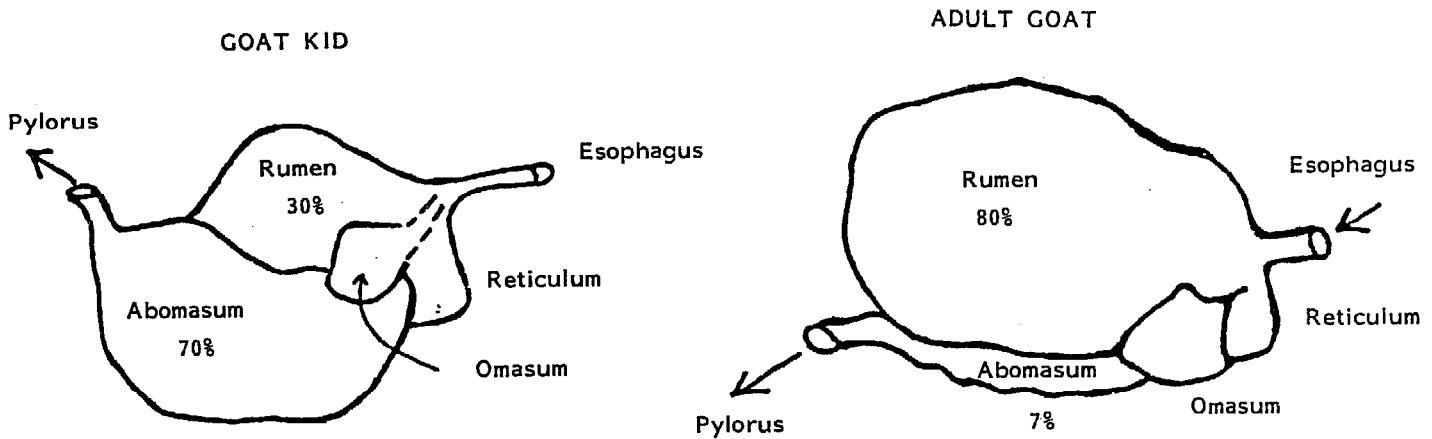

The RUMEN is the largest of the compartments and contains many microorganisms which supply enzymes to break down fiber. It is often called the fermentation vat. Protein and B Vitamins and also Vitamin K are all produced in the rumen.

The RETICULUM is the second stomach and is just below the entrance of the esophagus into the stomach. Actually, the reticulum is part of the rumen, being separated by a partial wall. The lining of the reticulum looks like a honeycomb.

The OMASUM consists of hanging layers of tissue. The large surface area of these folds permits absorption of moisture from feed as it passes into the fourth stomach.

The ABOMASUM is considered the true stomach. It contains hydrochloric acid and enzymes that break down feeds into simple compounds that can be absorbed by the stomach walls and the intestines.

2) Feeding the Newborn

COLOSTRUM is the most important ingredient for a newborn kid's diet. This is the first milk produced by the doe. It is usually very thick and may be pale yellow in color. It is rich in antibodies which protect young kids against disease. Newborn kids should have colostrum within the first hour after birth.

Normal Program

- First Week Leave kids with doe
- Second Week Take kids from doe and bottle or pan feed.
- Give $\frac{1}{2}$ liter (1 pint or 2 cups) of milk three times each day.
- Put protein supplements, hay and water near the kids and they will soon learn to eat and drink well.

- Third and Fourth Week Two liters of milk divided into three feedings, along with protein supplement, hay and water.
- Fifth and Sixth Week Continue to feed 2 to 2½ liters of milk divided into three feedings.
- Seventh Week Decrease number of feedings to two
- Eighth and Ninth Week Same as seventh
- Ninth to Twelfth Week Decrease milk slowly to once a day.
Wean kid.



4 cups = about 1 liter

If your doe is penned and the kids are left with the doe, you may want to make a creep feeder for the kids. This is a space in the fence that the kids can pass through to get feed and water and green chop, but which the doe cannot reach.

The kids should weigh about 15 kilos at the weaning age of three months.

CAE Prevention Program (See also P. 79)

- At Birth Take kids from doe immediately. Do not let kid suckle. Do not let doe lick kids. Towel dry.
Feed kid(s) at least 2 ounces heat treated colostrum within one hour of birth.
Continue to feed colostrum at 4-hour intervals during first day.
- First Week Give ¼ liter (1 pint or 2 cups) pasteurized milk or milk replacer 3 times each day.
- Second through Twelfth Week . . . Follow feeding schedule in normal program using pasteurized milk.

Keep kids away from physical contact with adult goats.

HOW TO HEAT TREAT COLOSTRUM

- Fill stainless steel thermos with water that has been heated to 131°F.
- Seal for 1 hour. The water should still be at 131°F or a few degrees higher when removed from thermos.
- Heat colostrum to 131°F. Watch carefully. Do not exceed 131°F or you will kill antibodies.
- Pour water out of thermos.
- Pour in heated colostrum.
- Seal for one hour.
- Refrigerate or freeze in another container for future use.

How to Feed a Kid When It Is Taken From the DoeBottle Feed

- a baby bottle or Coke or Fanta bottle will do. Be sure the bottle and nipple are clean at every feeding.

Pan Feed

- you can teach the kid to drink from the pan by sticking your finger in the milk and letting the kid suck your finger or by putting the kid's mouth into the milk. Pan feeding is often easier and there is less contamination. Wash the pan with soap and water and sun dry after every feeding.

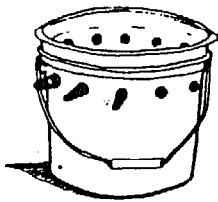
Bucket Nurser

- As your goat herd grows and you have many kids, you may want to make a bucket nurser. This takes a plastic bucket, some kind of plastic tubes and nipples. You can feed up to 8 kids at a time. However, it is very important that the tubes, nipples and bucket be kept very clean. Place bucket in some kind of sturdy frame at correct height.

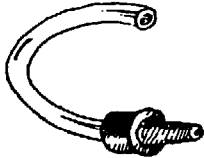
Lambar Nipples

- Australian-made natural rubber nipples for lambar-style feeders. Flange on back holds tube which reaches into milk. Nipple fits through 5/8" hole which should be placed 7" above bottom of bucket.

Order from Caprine Supply, 6657 Woodland, Shawnee, Kansas, U.S.A. 66218.

Multiple Bottle Nurser

- You can make a similar nurser to hold bottles with nipples.

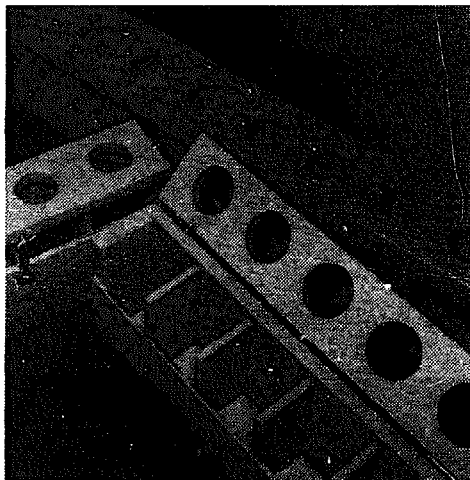

Taking the Kids From the Doe at Night Provides Extra Milk for Your Family

You may choose to leave the kids with the doe until they are weaned. However, you may still want a small amount of milk for your family.

Take the kids from the doe each evening and place them in a 1 x 1 meter enclosure with solid sides. This prevents unhealthy drafts.

Each morning, milk out the doe and save that milk for your family to drink. Put the kids back with the doe. Repeat this procedure each day.

Milk Replacers

If the doe should die or be unable to produce enough milk for her kids, you will need to use a substitute for the doe's milk. Try to get colostrum from another doe to give to the kid. In some locations milk replacers made especially for goats are available. If these are not available, use powdered milk or cow's milk. In the early stages you may want to dilute it with about 10% water.

3) Feeding the Weaned Kid Up to One Year

The important thing is to provide enough feed that a kid will grow well. Be sure the kid gets plenty of good mixed hay, browse or pasture, plus a protein supplement, mineralized salt and water.

4) Feeding the Mature Goat

A dairy goat will produce best on a diet of plenty of green chop and at least one-half kilo of 16% protein concentrate (feed) a day.

A mixture of green chop and legume hay is excellent for dairy animals. Legume hay is hay made from special grasses and plants high in protein. Lucerne (alfalfa), Desmodium spp. (silverleaf desmodium, greenleaf desmodium), clover, beans, peas and groundnuts are legumes.

Remember if you tether (tie) your goat or have her in a pasture, be sure your goat has access to shade and water. Remember, goats are browsers, not grazers, although they will eat grass. An area with low bushes is ideal for your goat.

You can also feed your dairy animal trimmings from your vegetable garden - beets, cassava leaves, cabbage leaves and bean vines. Be careful of green potatoes, tomato and potato vines; they contain solanin, which is toxic. You can also give your goat beans, groundnuts or bambara groundnuts, sunflower seeds and banana peels. Do not feed too many banana peels as this can cause diarrhea.

ALWAYS GIVE YOUR ANIMAL MORE GREEN CHOP (FORAGE, BROWSE) THAN SHE CAN EAT. BE SURE THAT IF YOU ARE CUTTING AND CARRYING THE GREEN CHOP TO YOUR ANIMAL THAT IT IS PLACED IN A MANGER OFF THE GROUND. YOU CANNOT FEED TOO MUCH GREEN CHOP.

WATER IS ONE OF THE MOST IMPORTANT INGREDIENTS OF A DAIRY GOAT'S DIET. BE SURE SHE RECEIVES 6-8 LITERS OF CLEAN WATER EACH DAY. IF THE WATER IS CONTAMINATED BY FECES OR OTHER FOREIGN MATTER, YOUR GOAT WILL NOT DRINK IT.

Protein and mineral supplements are recommended.

Cottonseed cake is a good protein supplement. One kilo of cottonseed cake will provide your goat with adequate protein for four days. Wheat bran and rice bran contain good amounts of protein, although they are generally referred to as energy feeds.

Goats require calcium and phosphorus in their diet. Bone meal is high in calcium. Alfalfa, timothy, red clover, mulberry, kudzu, elephant grass (napiergrass), seaweed (kelp) and dried citrus pulp are also good sources of calcium. Orchardgrass, sudangrass, rice bran, wheat bran and oats are good sources of phosphorus. Many tropical grasses are low in phosphorus.

Be sure your goat has salt in her diet. Mineralized salt is best. Iodized salt will provide needed amounts of iodine. Common table salt can be used if prepared mixes are not available. Make a salt box and put in loose salt for your goat to eat free choice. Salt blocks are also acceptable.

Vitamin E and selenium should be provided in areas where these are deficient. Most of the other minerals your goat requires will be supplied in the forages your goat eats.

5) Feeding the Milking Doe

Rations for the milking doe should contain 14-16% crude protein. Feed requirements are greatly increased during lactation. If you feed a prepared concentrate, feed .5 kilo of concentrate for each 1.5 kilo of milk produced. High quality hay will provide extra protein.

If you feed the milking doe on the milk stand, leave her on the stand for about five minutes after you finish milking so that she will consume additional protein supplements or concentrate.

6) Feeding the Pregnant Doe

When a doe is three months pregnant you should stop milking her. The kids inside the doe will be growing the fastest and requiring the most nutrition during these final weeks.

If you have been feeding legumes (clover, alfalfa) which are high in calcium, it is best to replace these with grass hay at least three weeks prior to kidding to help prevent milk fever. This forces the animal to mobilize her own body stores and prepare for lactation.

A fat doe will have trouble kidding.

Be sure the goat gets mineralized salt and water during these critical times.

7) Feeding the Breeding Buck

Proper feeding is very important for the breeding buck. High quality hay in large quantity will help maintain and grow the buck at a reasonable cost. When not being used for breeding, good pasture alone will maintain the buck in good health.

Two weeks before and during the breeding season gradually build up to $\frac{1}{2}$ kilo of concentrate or some kind of protein supplement twice each day. Plenty of water and exercise is also important for the breeding buck. Never let a buck become fat or sluggish or this may cause him to be sterile. Excessive gain when the buck is inactive may cause overweight. A buck needs only 12-14% protein in his diet. After the breeding season, reduce concentrate feeding.

8) Compositions of nutrients in a goat's total diet should be:

14-16% Protein
 11% Digestible Protein
 63% TDN (Total Digestible Nutrients)
 16-18% Fiber
 .6-1.0% Calcium
 .4-.5% Phosphorus
 (The ideal calcium/phosphorus ratio for milking does is 1.5:1)

9) Examples of Feeds

ENERGY FEEDS - Barley, oats, corn, bran, beetpulp, milo, wheat

PROTEIN FEEDS - Peas, beans, cottonseed cake or meal, soybean meal, linseed meal, brewers grains

CALCIUM FEEDS - Bone meal, elephant grass, citrus pulp

PASTURE/LEGUMES - Hay (alfalfa, grass, clover), silage (alfalfa, grass, corn), roots (sugar beets, yucca) and garden refuse free from chemical residue

COMMERCIAL FEEDS - Concentrates, mineral mixtures

10) Hay Storage

During the rainy season and during the extreme part of the dry season, you will want to cut hay (forage) and bring into your barn or shelter to dry and store for your animals. Cut forages or grasses for hay in the early bloom stage of maturity. Try to cut the hay during rain-free weather. Leave to dry one or two days before baling or stacking.

33a Feeding

Hay which contains too much moisture will mold and be unsuitable for feeding. You can store the hay for many weeks and it will make management of your animals easier during times when it is difficult for your animals to graze.

Elephant grass grows well in many places. If this is cut when it is young, it makes good hay. Sudangrass may also be used.

11) Silage

Silage is less palatable to goats than hay, but may have storage advantages. Silage is hay which is cut into small pieces and stored in airtight conditions until fermentation occurs. Corn silage is made by chopping the stalk and the ear. Corn silage is an acceptable feed, but should be combined with other forages and a protein supplement. Grass and legume silage are fed extensively to goats in Norway and France.

Small amounts of silage may be cut and stored in plastic bags. After cutting, press silage tightly into the bag. Press out all of the air and tie the opening. Each time you feed, press out the air.

Larger amounts of silage may be stored in a trench silo. Your livestock extensionist can advise you on proper procedures.

12) Forages and Grasses

On the following pages are photographs of various forages. This is not an exhaustive list. You will want to add the forages from your area.

In Central America, Mulberry leaves, Confrey and Ramio are widely used. In the Caribbean, Acacia is an important forage plant. The following are used in West Africa.



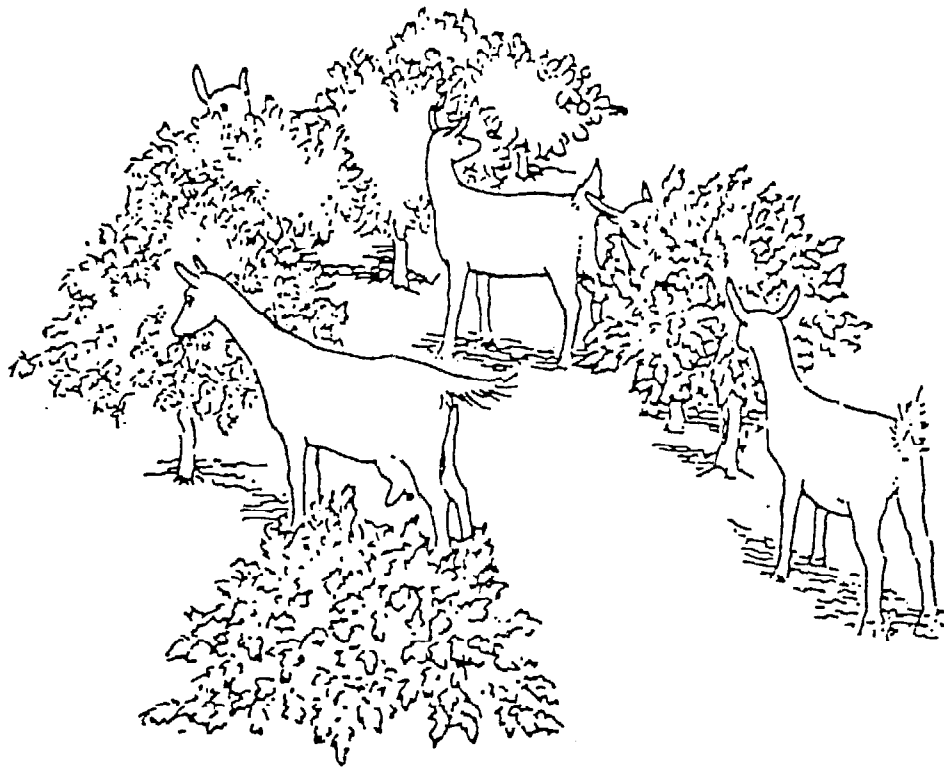

Photos by Barbara Needham
Forage Specialist - Martin Djakari



STYLO or BRAZILIAN LUCERNE

Alfalfa-like perennial. Mixes well with grasses. Palability low in rainy season, but readily eaten in dry season. Young plants best. A legume.

DESMODIUM spp.

Prostrate creeping perennial or annual with small leaflets of pink, blue and purple flowers. For grazing, but not as desirable as others. A legume.





PENNISETUM PURPUREUM
Elephant grass, Napiergrass,
Uganda grass

High yielding, tall erect perennial grass with thick stems. Tolerant of short drought, but not waterlogging. Prefers deep soils of moderate to heavy texture. Used for hay, silage and potential grazing. Contains some calcium.

TRIPSACUM LAXUM
Guatemala grass, Honduras grass

Tall broad-leafed perennial. Grows tall. Is a good crop for dry season. Grows in humid areas, but not suited for grazing. Can be used as green chop or hay. More persistent, but less nutritious than Elephant Grass.



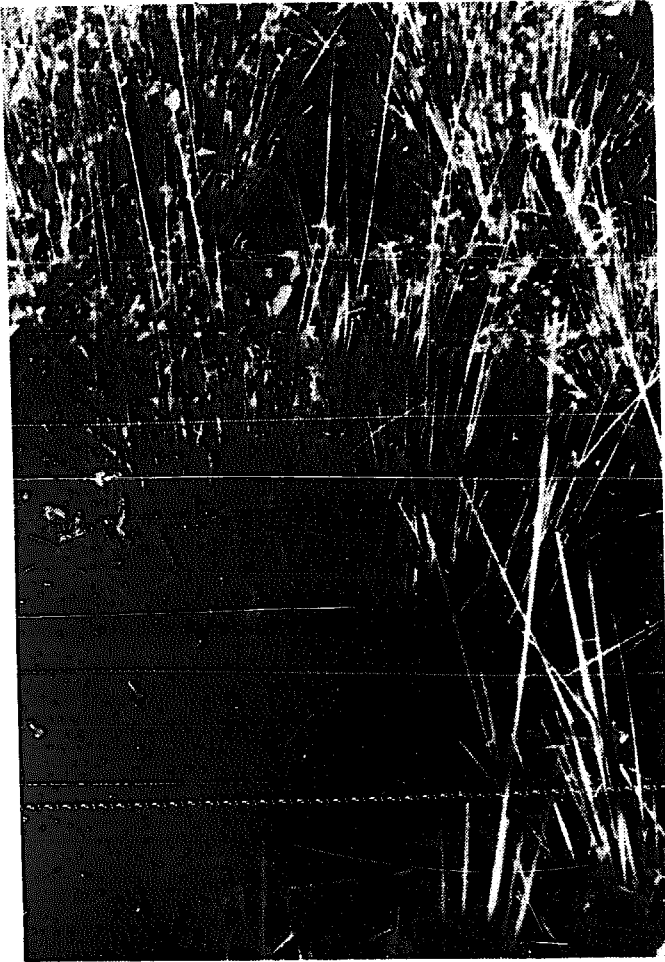

HYPARRHENIA RUFA
(Jaragua Grass or
Thatching Grass)

Palatable forage before tussocks form. Can be used as hay. Flowering stands must be mowed or burned.

CYMBOPOGAN spp.
Oil grass

Hardy, upright perennial - bunchgrass with many leaves. Seed heads resemble oats. Well adapted to light textured soils suitable for pasture or hay.

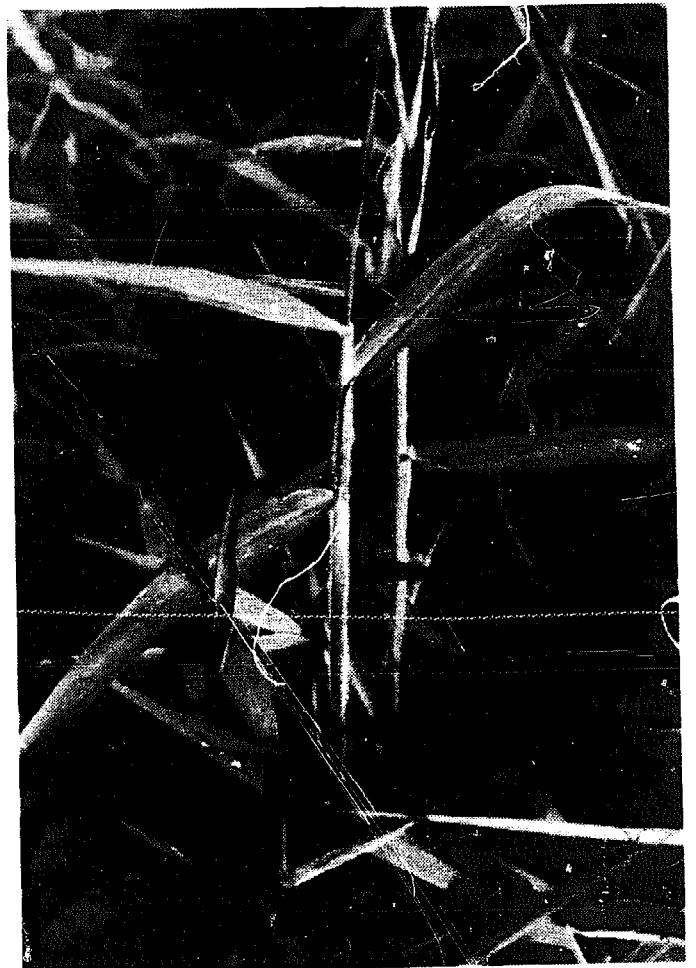

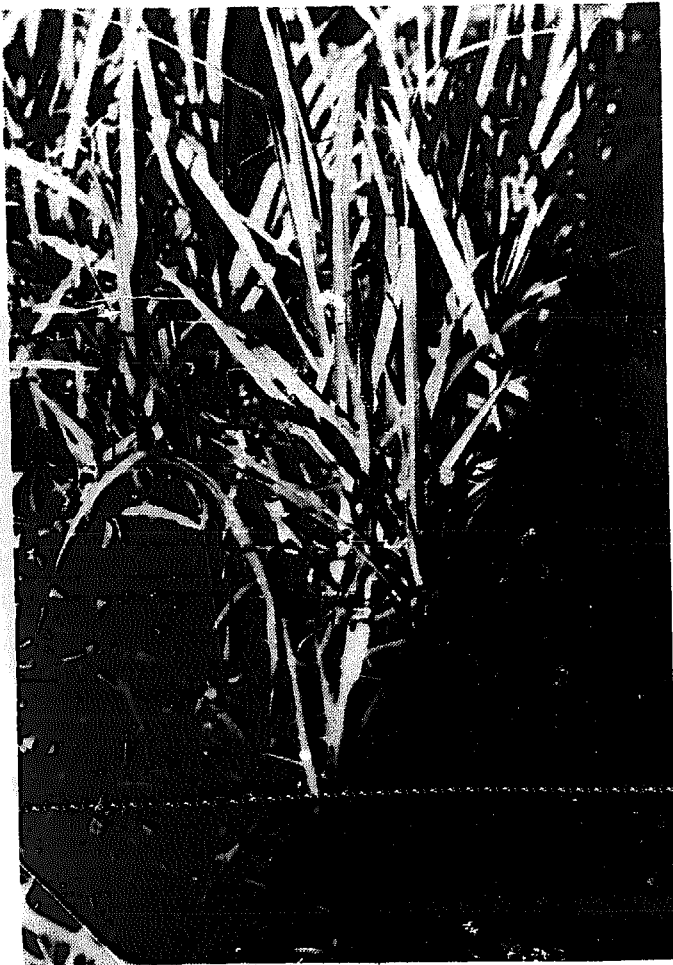

PENNISETUM CLANDESTINUM
Kikuyu grass

Excellent pasture -
contains high levels
of digestible protein
through maturity.
Stocking rates should
be light until grass
is well established.
Vigorous, aggressive,
perennial grass.
Prefers well-drained
soils - drought
resistant.

BRACHIARIA spp.

Tufted perennial with
erect or sub-erect stems.

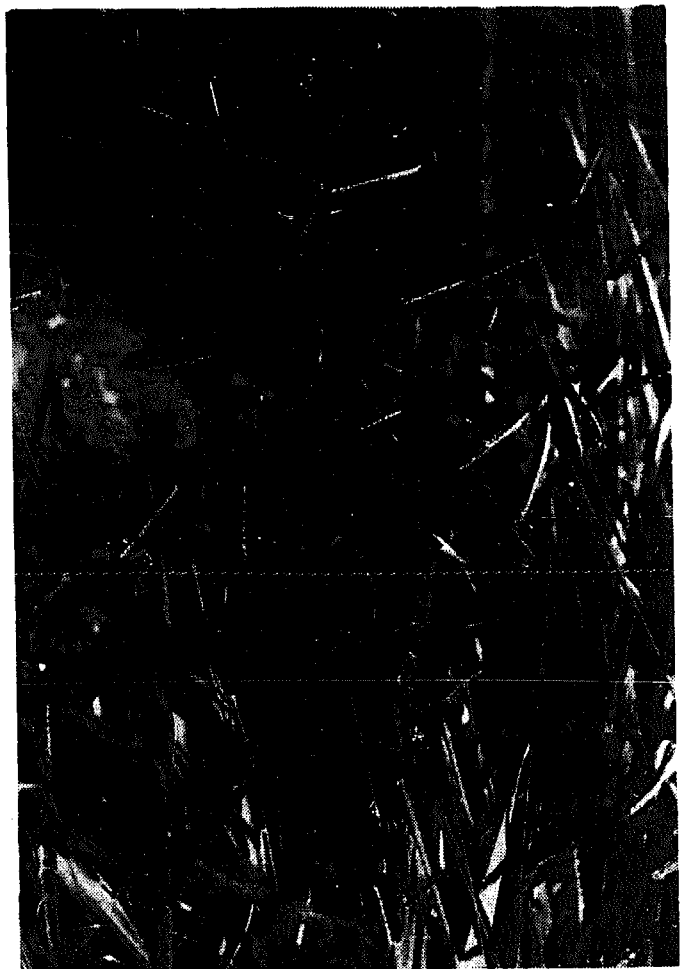

13) PROTEIN SUPPLEMENTS	% Dry Matter	% Digestible Protein	% TDN	% Calcium	% Phosphorus
Cottonseed Cake	93.5	14.9	90.0	.14	.67
Rice Bran	90.7	8.4	58.9	.07	1.59
Soybean Meal	91.3	46.6	71.2	.29	.65
Brewers Grain	91.0	19.1	60.3	.27	.48
Groundnuts (peanuts)	91.5	42.7	70.3	.20	.65

Comparative Feeding Value of Selected Feedstuffs

Feedstuff	% Dry Matter	% Crude Protein	% Dig. Protein	% Total Dig. Nut.	% Fiber	% Cal.	% Phos.
Legume hays:							
Alfalfa, ave. anal	90	15.9	11.7	51	27	1.38	.20
Alfalfa, early cut	89	17.7	13.4	51	25	1.28	.23
Alfalfa, mature	91	12.0	8.4	50	35	1.07	.16
Alfalfa, dehy, pel.	92	17.5	12.7	56	24	1.33	.24
Peanut (few nuts)	91	9.9	6.1	51	30	1.12	.15
Cowpea	90	15.6	10.6	52	25	1.22	.31
Soybean	90	14.4	9.7	50	30	1.10	.24
Velvet bean	87	12.9	7.9	56	31	1.10	.22
Clover, white	90	19.0	13.9	57	22	1.71	.29
Non-legume hays:							
Coastal bermuda	91	11.1	6.9	50	28	.35	.17
Common bermuda	91	9.0	4.6	45	26	.40	.19
Sudan grass	91	10.0	5.2	52	28	.56	.29
Johnson grass	90	8.6	4.7	54	30	.63	.26
Oat, headed	90	8.0	4.6	51	29	.26	.24
Cottonseed hulls	91	3.8	.0	43	43	.14	.08
Peanut hulls	92	6.1	1.5	19	54	.24	.06
Grains:							
Barley	88	12.2	9.6	73	5.0	.04	.33
Corn, # 2 yel.	89	8.7	6.7	82	2.0	.02	.34
Milo	89	10.6	7.5	78	2.3	.03	.28
Oats, all anal.	89	12.1	9.6	68	10.9	.06	.33
Wheat	88	14.9	11.9	78	2.5	.03	.38
Molasses, cane	75	3.9	1.1	55	.	.78	.09
Cottonseeds	92	21.7	14.9	90	18.2	.14	.67
Wheat bran	89	15.2	11.7	63	10.4	.11	1.26
Protein Feeds:							
Cottonseed meal	91	41.0	31.3	66	12.3	.18	1.11
Soybean meal	91	46.7	42.0	73	2.3	.33	1.11
Peanut meal	92	46.7	43.8	71	6.3	.20	.63
Linseed meal	91	35.9	31.2	72	8.8	.39	.84
Bean, pinto	90	22.6	17.2	79	4.0	.13	.46
Cowpea seed	89	23.8	19.5	76	5.0	.09	.44
Pasture/Range:							
Alfalfa, ave.	24	4.7	3.5	14	6.4	.46	.06
Coastal bermuda	31	4.6	3.4	21	8.8	.35	.17
Common bermuda	39	3.6	unkn	23	10.5	.40	.13
Honeysuckle	41	4.1	2.7	23	9.4	.40	.19
Oat, immature	16	2.5	unkn	10	4.0	unkn	unkn
Ryegrass, Ital.	26	3.8	1.6	15	6.2	.17	.11
Sundagrass, Avn	27	3.4	2.2	17	8.4	.19	.09
Milk:							
Goat, fresh	13	3.5	unkn	17	.0	.13	.11
Cow, fresh	13	3.6	3.4	17	.0	.12	.10
Ewe, fresh	19	6.4	unkn	26	.0	.21	.12

POULTRY LITTER - an optional protein for your goats.

The manure from poultry houses where birds are maintained on litter is designated as "poultry-house litter".

Poultry litter may be successfully fed to goats and other ruminants as a protein supplement. It may contain up to 23% digestible protein. Nutrient composition varies due to bedding, number of birds, etc. Litter from replacement pullets or ongoing layer house programs is best suited. Bedding should not be too deep. Select the litter from well agitated areas when the birds have been on it for at least ten weeks. These are usually within a short distance from the feeders.

The litter may be fed immediately or stockpiled for 4-6 weeks. If you stockpile the litter, it must be out of the rain and well ventilated. Do not cover with plastic. Feed less of your regular concentrate and mix from 10-50% litter in with the concentrate. On a maintenance program you can feed only poultry litter and green chop with no other concentrate.

* Loss of ammonia through evaporation lowers the protein content of the poultry litter.

COMPOSITION OF BROILER LITTER

Dry matter (%)	84.7
Composition of dry matter	
Crude protein (%)	31.3
True protein (%)	16.7
Digestible protein (%)	23.3
Percent digestibility (%)	74.6
Crude fibre (%)	16.8
Ether extract (%)	3.3
NFE (%)	29.53
DE (sheep) (kcal/kg)	2440
ME (sheep) (kcal/kg)	2181
Total digestible nutrients (sheep) (%)	72.5
Ash (%)	15
Calcium (%)	2.37
Phosphorus (%)	1.8
Potassium (%)	1.78
Copper (mg/kg)	98
Iron (mg/kg)	451
Manganese (mg/kg)	225
Zinc (mg/kg)	235
Magnesium (%)	0.44

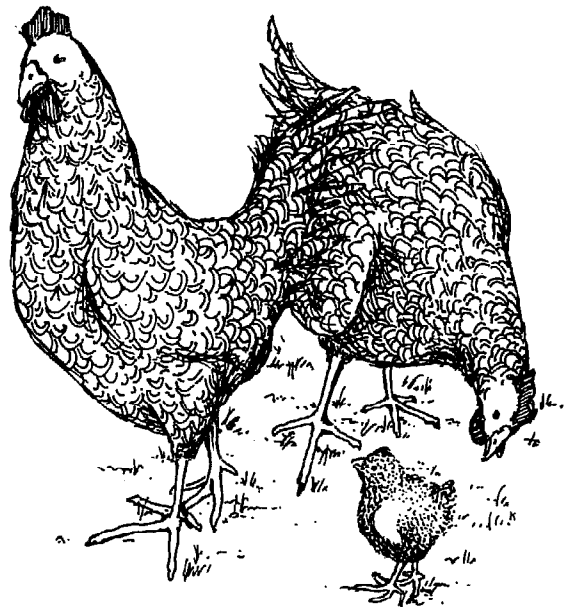

(Source: Bhattacharya and Taylor, 1975)

14) HUSBANDRY SYSTEMS

a) Extensive Production

Extensive husbandry systems are those which provide least protection from the natural environment and involve a minimum of labor. In regions where climatic conditions are favorable and predators are not too numerous, animals may be left free to graze on natural pastures without fencing or housing, being herded into enclosures only when required. The most extensive system in the tropics is bush or range grazing with housing at night and during the rains. It is generally accepted that goats, although hardy in other ways, are intolerant of wet or damp conditions and under such circumstances they are reputed to be particularly susceptible to pneumonia and in the case of milk goats, mastitis.

b) Intensive Production

The most intensive form of production involves continuous housing or "zero grazing". This provides maximum protection from the adversities of difficult environments and gives complete control over the destructive aspects of the goat's feeding habits. It is ideal for dairy goats under tropical conditions and perfect for small family herds. It makes no use of the independent feeding habits of the goat, but cheap materials such as crop wastes, industrial wastes and vegetable peelings can be utilized. Where small numbers are concerned, it is more economical of labor than herding them in the bush and very convenient for the control of feeding and mating. The system is suited to high-producing animals and exotic breeds and their crosses are more likely to be successful on zero grazing than on any other system.

c) Semi-Intensive Systems

This term covers all degrees of compromise between range management and zero grazing, but usually involves controlled grazing of fenced pastures with supplementary concentrate feeding. Tethering commonly replaces fencing.

When tethering is used care must be taken that there is no possibility of strangulation. Shade must be always available, with drinking water and shelter from rain provided when required. It is essential to change the place of tethering every day so that fresh herbage and a variety of plants can be obtained by the animal.

The great advantage of permitting some grazing, whether free or tethered is that it gives the goat an opportunity to supplement the diet provided for it under zero grazing and to do some selective feeding to overcome dietary deficiencies.

Above paragraphs from C. Devendra, Goat Production in the Tropics

15) MANAGING GOATS DURING WET AND DRY SEASONS

Wet Season - Browsing for your animals may need to be limited during the rainy months. Parasites live in the moist grasses and can reinfect your animal easily. In tick infested areas, you will need to spray or dip your animals in insecticide twice a week during the rainy season. Bring the animals into a shelter during the heavy rains and let them browse when it is not raining. You may need to bring hay and green chop to them if they are unable to browse long enough to get adequate feed.

Dry Season - At the beginning of the dry season forage will be plentiful. This is probably the best time for kids to be born and to develop your milking animals. As the season grows longer, there will be fewer bushes and grasses for the animals to browse. For this reason, early in the dry season you may want to cut and store hay to use when it is not plentiful. Also, in tick infested areas spray or dip your animals at least once a week, twice a week if ticks are abundant.



TASKS FOR LESSON III:

- 1) Practice feeding kid goats with both a bottle and pan.

- 2) Identify forages and grasses available in your area and collect samples.

- 3) List the feed resources available to you and write a formula for a good goat ration utilizing forage, pasture and supplements.

LESSON IV - BREEDING AND CROSSBREEDING

1) BREEDING THE DOE

In the Northern Hemisphere goats are, on the average, seasonal breeders. The normal breeding season is August to March. There may be some individuals who cycle at other times during the year, particularly if a buck is introduced or artificial lighting is used.

In tropical climates, goats cycle year round. It is, however, recommended that you breed your does to kid at the beginning of the dry season, as feed will be abundant and both kids and lactating animals will perform well.

The heat (estrus) period lasts from 12-48 hours and ovulation occurs 24-36 hours after the onset of the heat period. The doe should be bred the last half of the estrus. General advice is to breed the second day and repeat in twelve hours if she is still in heat.

The estrus cycle is 17-23 (average 21) days, with older does having shorter cycles.

A doe should be 7-10 months old, or better yet 36-41 kg (80-90 lbs.) before breeding.

WHEN TO BREED TIMING GUIDE FOR DAIRY GOATS

DOE COMES INTO HEAT

DOE IN FULL STANDING HEAT

DOE AT END OF HEAT

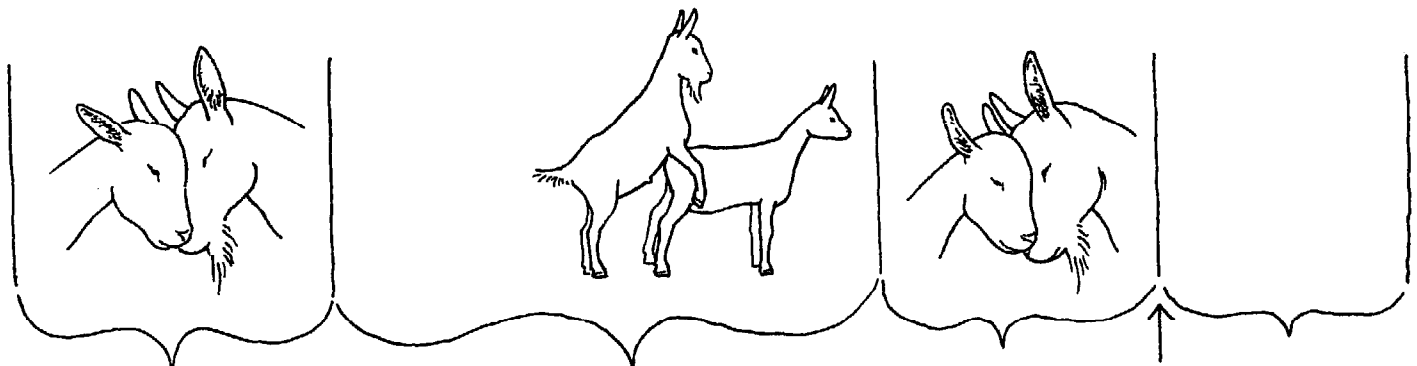

30 hrs.

EGG RELEASED

0 hrs. . . EARLY HEAT . . . 24 hrs. . . . STANDING HEAT . . . 36 hrs. . . . LATE HEAT 48 hrs.
 ↑ TOO EARLY ↑ GOOD ↑ BEST TIMING ↑ GOOD ↑ TOO LATE

2) SIGNS OF ESTRUS (heat)

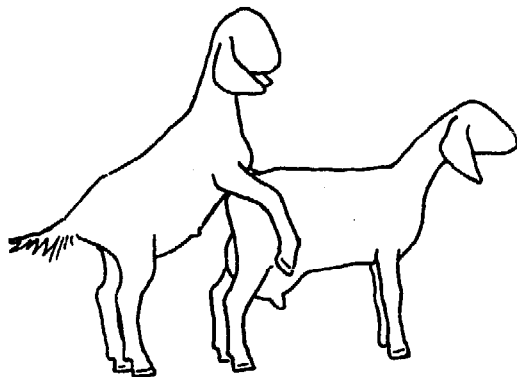

Swelling and redness of the vulva
Mucous discharge
Flagging of the tail
Nervousness and bleating
Mounting and being mounted by
other goats
Frequent urination

Does come into heat for the first time at a very early age. As stated earlier, it is best to wait until the doe is 7-10 months old and weighs 36-41 kg (80-90 lbs.).

You can "flush" your doe 2-3 weeks before planning to breed. This increases the number of ovulations. To do this you might feed extra concentrate or protein supplement. If you carefully watch and record heat dates, then you can estimate the next period at which you wish to breed. You are more likely to have multiple births if the doe has been flushed. A doe should always be gaining weight when she is bred, but should not be fat.

It is also a good practice to worm your doe a few weeks before you plan to breed.

Decreasing light and temperature helps bring a doe into heat. Shorter days trigger heat cycles.

If the doe fails to show a strong heat, you can either place her with a buck or rub a rag on a buck's head (behind horn area where musk glands are located) and bring the rag to the doe once a day. Keep the rag in a covered jar.

Good nutrition is also essential for both the doe and the buck at the time of breeding. A good buck can serve two does a day and 4-5 does a week.

The introduction of a buck or its smell at the beginning of the season will often bring the whole group into heat in about eight days. Most goats will cycle even without the buck's presence.

3) CROSSBREEDING

When unrelated goats are mated, the system is known as crossbreeding. First cross progeny are usually superior to their parents. This is known as hybrid vigor.

Crossbreeding is used to improve the productivity of local animals. Using an exotic buck to breed a native doe will produce strong, vigorous offspring. These offspring will have increased production potential.

purebreds

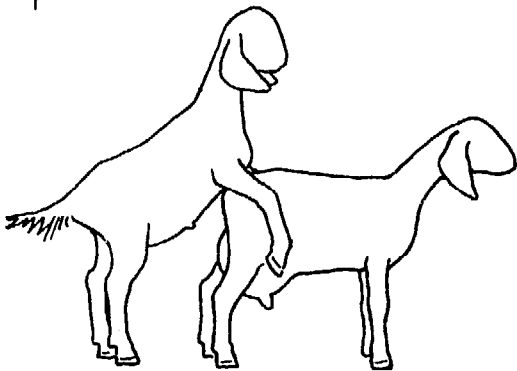

good milker

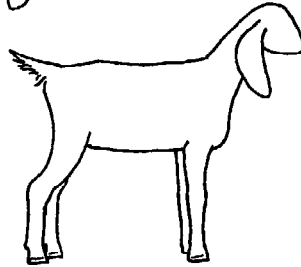

breeding buck



cross breeds

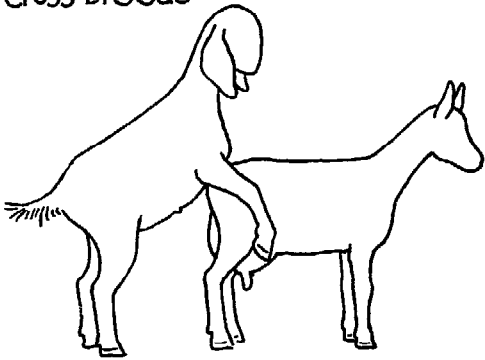

better milker

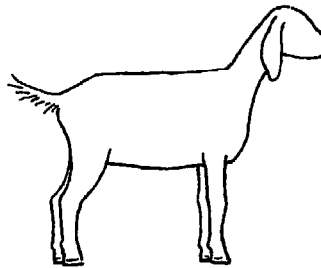

meat

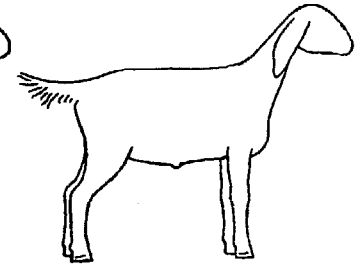

4) SELECTING A BUCK

The buck you use is one-half your herd.
The buck should be better than your best doe.

Look for a buck who will reinforce your does' strong points and at the same time does not possess any of their major faults.

- a) Be sure the buck is in excellent health.
- b) In selecting your buck for milk production, be sure that the dam (mother) of the buck gives as much or more milk than the mother of the doe.
- c) Feed the buck .5 kilo of concentrate per day and plenty of green chop during the breeding season. If you cannot get concentrate or other protein supplements, be sure he has all the green chop he needs and let him browse extensively.
- d) If you are breeding for purebred kids, select a buck of the same breed as your doe.
- e) If you are crossbreeding, it is best to breed a native doe to an exotic buck.
- f) For increased vigor you may also want to breed two exotic goats of different breeds, i.e., Nubian and Toggenburg.
- g) Do not breed two hornless animals (hornless at birth). If you breed two hornless animals, the genitals of the kids may not be normal.

5) CARING FOR THE PREGNANT DOE

Protein supplements are important during the dry period (non-lactating period). The kids are growing fast at this time.

If you are feeding legumes (clover, alfalfa) which are high in calcium, it is best to replace these with grass hay at least three weeks prior to kidding to help prevent milk fever. This forces the animal to mobilize its own body stores and prepare for milking.

If available, give the doe a *Clostridium Perfringens* C & D vaccination and tetanus toxoid three weeks prior to kidding. If possible give Vitamin E and Selenium during the dry season to prevent white muscle disease. There is also good indication that Selenium plays an important role in enhancing female reproduction.

It is also good to worm your doe two weeks prior to kidding.

REPRODUCTIVE ORGANS OF BUCK

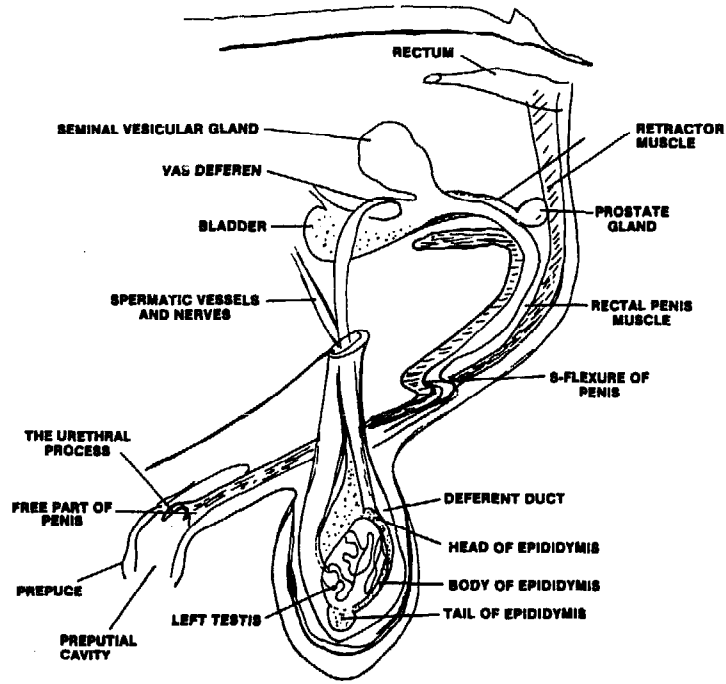

REPRODUCTIVE TRACT OF DOE

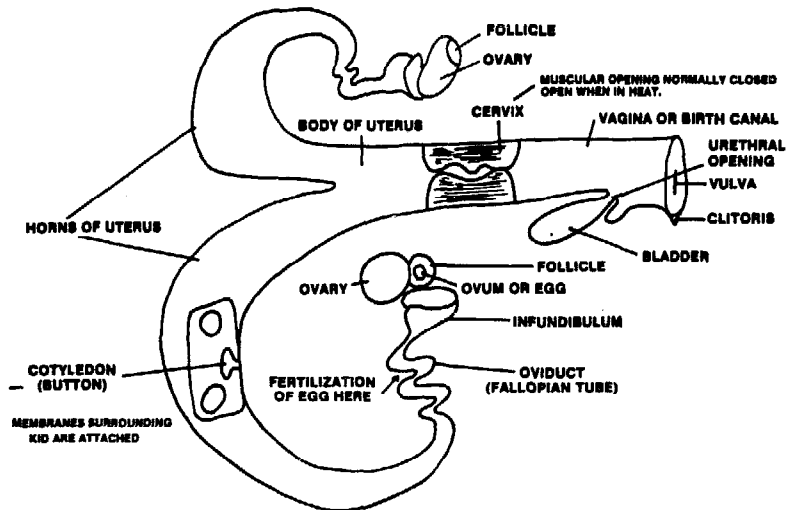

Source: University of Guelph, *Independent Study: Dairy Goat Production.*

GESTATION TABLE

Breeding Date	Kidding Date	Breeding Date	Kidding Date
January 1	May 30	July 5	December 1
6	June 4	10	6
11	9	15	11
16	14	20	16
21	19	25	21
26	24	30	26
31	29	August 4	31
February 5	July 4	9	January 5
10	9	14	10
15	14	19	15
20	19	24	20
25	24	29	25
March 2	August 29	September 3	30
7	August 3	8	February 4
12	8	13	9
17	13	18	14
22	18	23	19
27	23	28	24
April 1	September 28	October 3	March 1
6	September 2	8	6
11	7	13	11
16	12	18	16
21	17	23	21
26	22	28	26
May 1	October 27	November 2	31
6	October 2	7	April 5
11	7	12	10
16	12	17	15
21	17	22	20
26	22	27	25
31	27	December 2	30
June 5	November 1	7	May 5
10	6	12	10
15	11	17	15
20	16	22	20
25	21	27	25
30	26	31	29

Source: Penn State University, Dairy Goat Correspondence Course No. 105.

TASKS FOR LESSON IV:

- 1) Observe does to detect possible heats.
- 2) Select bucks you feel are best for breeding with specific does.
- 3) Breed animals if possible.

LESSON V - KIDDING

1) PREPARATION FOR KIDDING

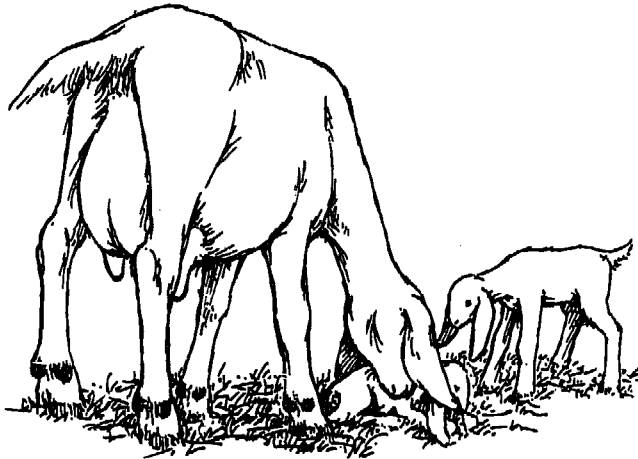

It takes 146-156 days after breeding for the doe to kid. Two weeks before kidding prepare the kidding pen. It is important that the pen be clean and have fresh bedding.

Be sure to have a bottle of iodine and a soft towel near the pen to use at the time of birth.

About a week before kidding, the doe's udder will bag up and become larger and fill with milk. Several days before you expect the doe to kid, put her in a clean kidding pen with plenty of bedding. Give her grass hay, a protein supplement and water.

DO NOT LEAVE THE WATER BUCKET IN THE PEN WHILE YOU ARE NOT WATCHING. IF YOU LEAVE THE WATER IN THE PEN, THE DOE MAY DROP THE KID IN THE WATER AND IT WILL DROWN. BRING THE WATER TO THE DOE SEVERAL TIMES EACH DAY.

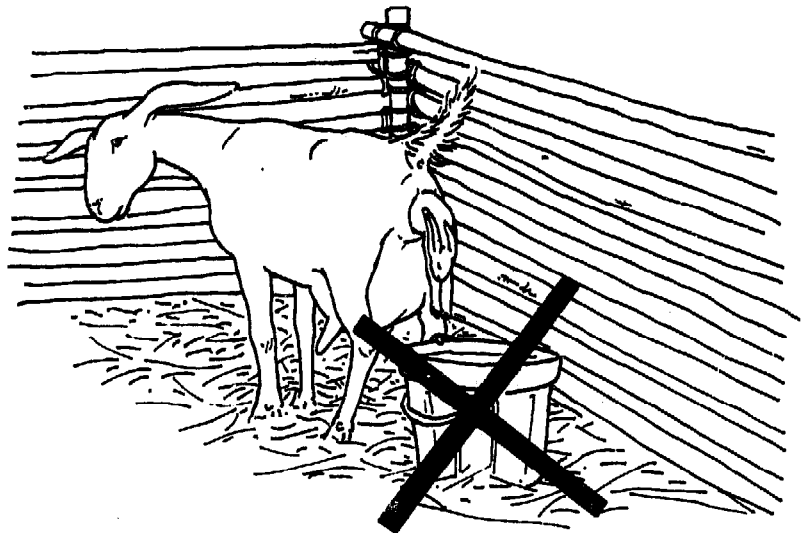

Once you see signs of kidding, stay with your goat. You cannot help if you are not there.

Kids can be felt on the right side of the doe. As long as you can feel the kids moving, they probably won't be born for at least 12 hours.

2) SIGNS OF KIDDING

- Doe is restless and paws the bedding
- Doe appears hollow on either side of the tail
- In a group of animals she may stand off by herself
- She will show a great display of affection
- There will be a discharge from the vulva

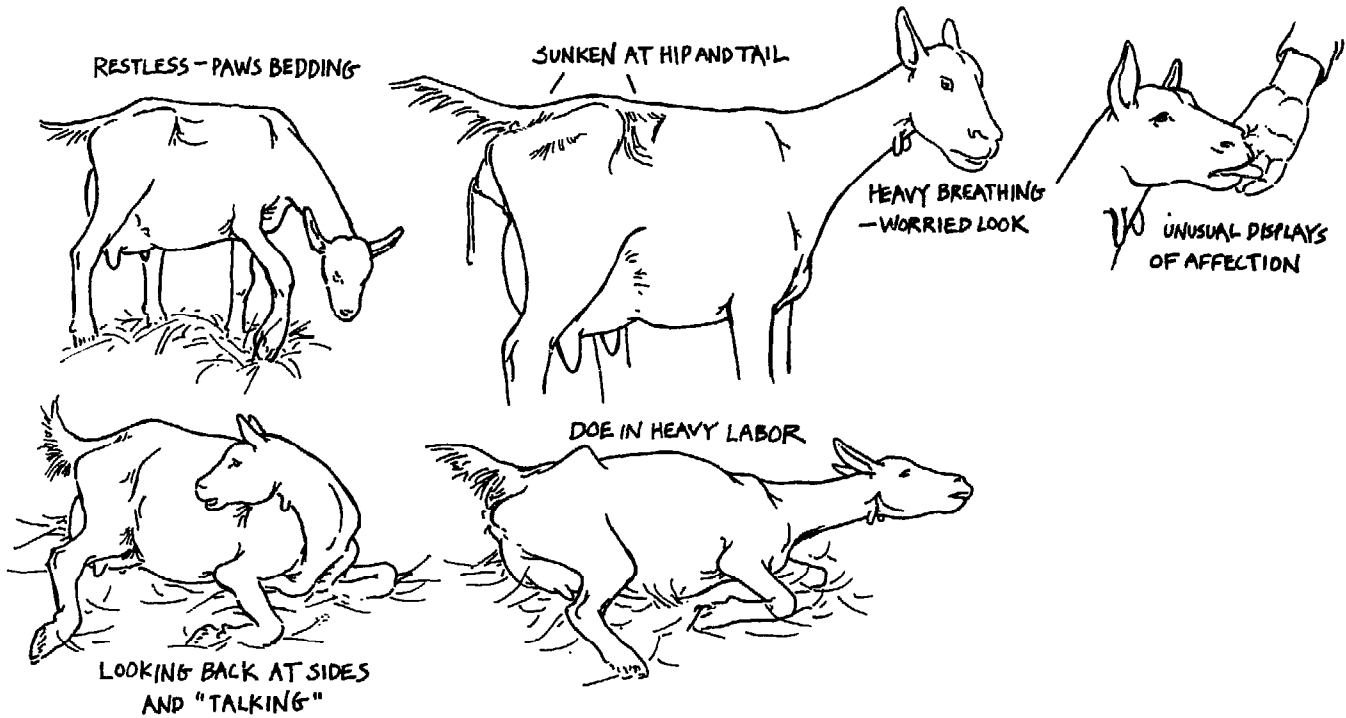

After the water sac breaks, the doe will have a long discharge hanging from the vulva. The kid should start appearing within one hour.

3) NORMAL DELIVERY POSITIONS

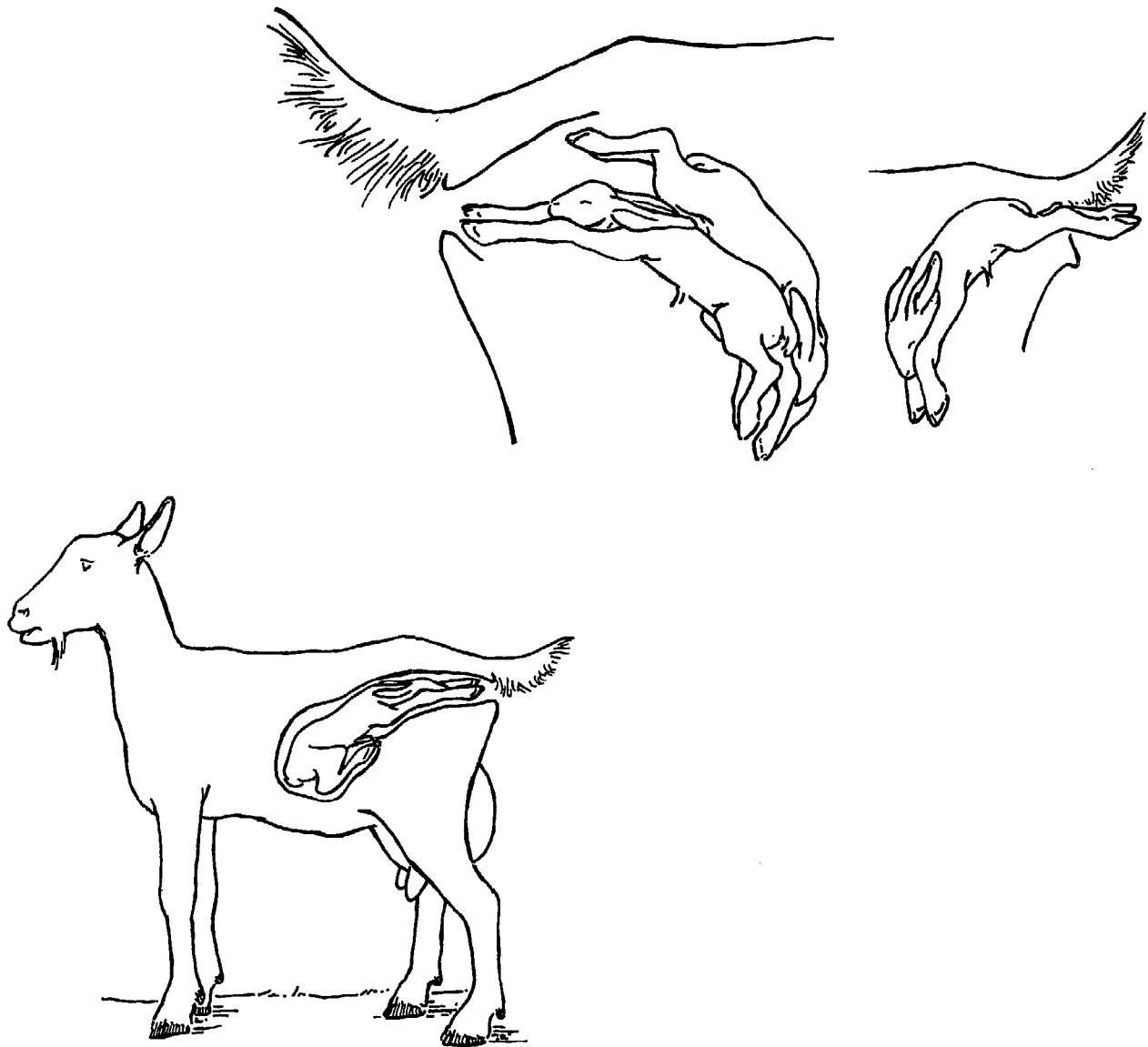

There are two normal delivery positions. The nose diving between the front legs or with both hind legs together and the dew claws up. The kid should be right side up, face down.

4) ABNORMAL BIRTH POSITIONS

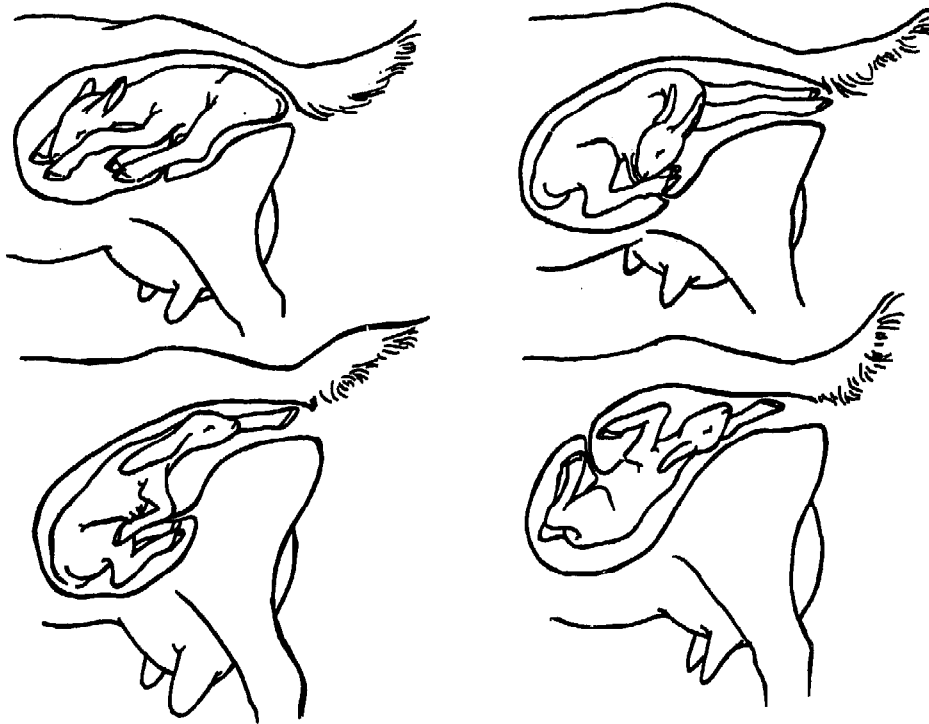

NEVER PUSH THE HEAD BACK IN ONCE THE SAC OVER THE NOSE IS BROKEN OR YOU WILL SUFFOCATE THE KID.

Front legs back - Reach inside the doe next to the kid's neck and follow it to the kid's chest and then to the elbow of one front leg. Hook the front leg with a finger and gently pull it forward and straight. Try the other front leg. Rock one shoulder and then the other gently out of the doe. Pull with the doe, not against her. Wipe off the kid's nose with a clean cloth. Clear its mouth with your finger and get it breathing. Towel the kid dry with fast strokes.

Legs present, but head twisted back - Push legs back into uterus. Slide hand into uterus and grasp head with palm of hand and hold head steady while bringing legs into diving position. Guide head with palm of hand and fingers until it enters pelvic area.

Breech presentation - rump first. Try to rotate the animal into the normal positions, perhaps hind legs first, dew claws up.

THE KID SHOULD BE BORN WITHIN ONE HOUR AFTER HARD LABOR BEINGS. IF THIS DOES NOT OCCUR, WASH THE DOE OFF WITH A MILD SOLUTION OF SOAP AND WATER. WASH YOUR HAND AND PUT IT GENTLY INSIDE TO FIND OUT WHAT IS GOING ON. HAVE SOMEONE HOLD THE GOAT IF POSSIBLE. MOVE THE KID UNTIL IT IS IN A NORMAL BIRTH POSITION.

HELPING WITH A DIFFICULT BIRTH

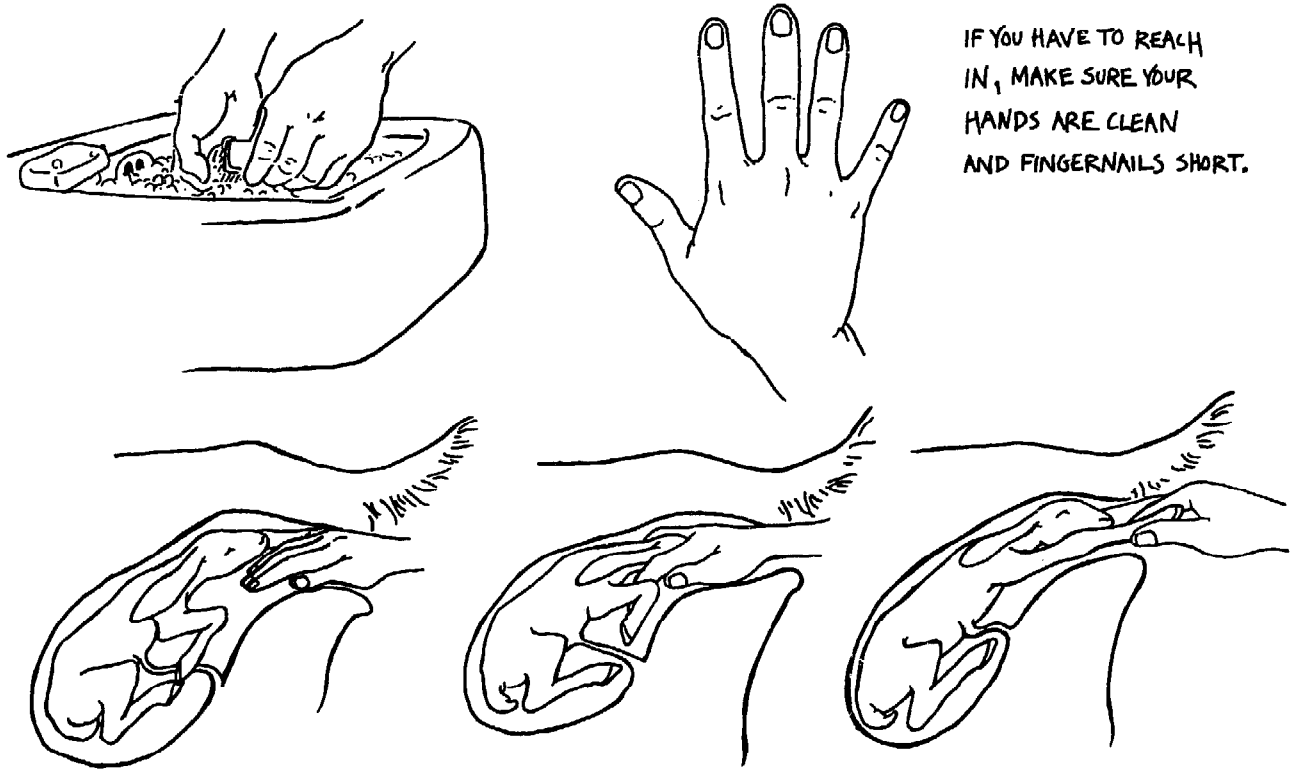

IF YOU HAVE TO REACH
IN, MAKE SURE YOUR
HANDS ARE CLEAN
AND FINGERNAILS SHORT.

5) GENERAL PROCEDURES

Try to let the cord break naturally so all the blood in it flows into the kid. If sac is not broken, you can break it for the doe.

Dip the cord in 7% iodine to prevent deadly germs from moving up inside the kid's body. Cover the navel with a small container containing iodine. Turn the opening against the kid's body and hold for one minute.

Clean mucous out of nose, throat and mouth. A straw up the nose provokes sneezing which helps clear the airways.

If the kid appears lifeless, swing it by its hind legs - fast and hard. Give it short hits with your fingers in the middle of the heart. Try artificial respiration.

THE FIRST MILK (COLOSTRUM) CONTAINS ANTIBODIES WHICH PROTECT THE KID FROM DISEASE. GIVE THE KID COLOSTRUM WITHIN 15 MINUTES AFTER BIRTH, AND CONTINUE COLOSTRUM FEEDING FOR AT LEAST 24 HOURS AT 4 HOUR INTERVALS.

If you have decided to guard against CAE (Caprine Arthritis Encephalitis) you will want to have heat-treated colostrum available for immediate use. If frozen, be careful to thaw in warm water only to avoid killing antibodies. (Temperature of water should not be more than 131°F). If you are not following a CAE management program, you can let the kids suckle.

The Birth Process

STAGE ONE : CERVIX IS DILATING

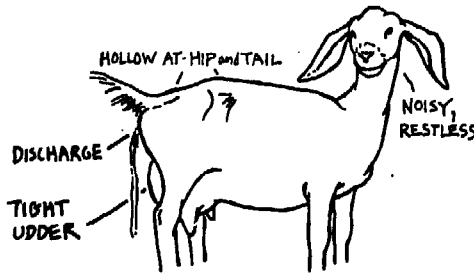

STAGE TWO:
KID IS IN-PASSAGE

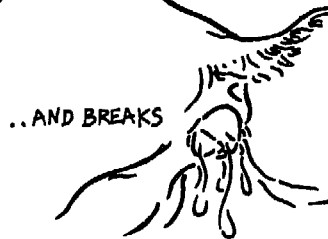
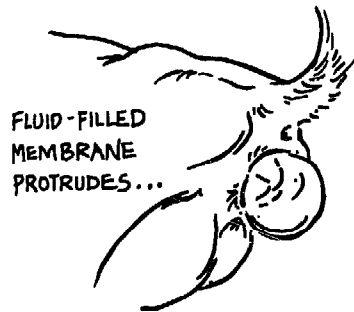
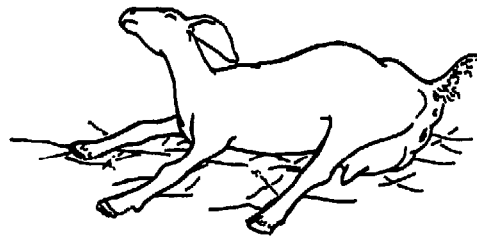

DOE SHOULD CLEAN KID NOW UNLESS ANOTHER IS ON THE WAY. FINISH DRYING THE KID WITH A TOWEL.



APPLY IODINE TO THE NAVEL

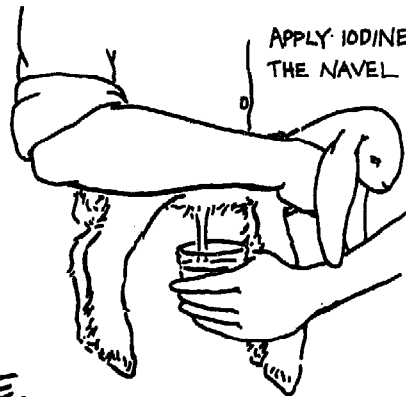

GIVE THE KID(S) COLOSTRUM AS SOON AS POSSIBLE.



Photos by Rosalee Sinn
Taken at LaFiesta Farm,
Paso Robles, California,
U.S.A.

6) DISBUDDING/DEHORNING - Should be done 3 days to 2 weeks of age.

Disbudding and dehorning may not be widely practiced outside of the United States. However, it is highly recommended. Dehorning prevents goats that are tethered from getting tangled in bush or fencing. It also prevents injuries due to fighting among goats.

Equipment needed:

a metal rod which is fairly thick - about 1 cm in diameter (3/4")

the metal rod should have a handle on it which will not conduct heat

a hot fire

a person to help or a disbudding box

It is wise to give the kid an anti-tetanus shot prior to dehorning.

Heat the iron until it is red hot. Place the kid in the disbudding box and sit on top of the box, or have your helper hold the kid tightly between his/her knees, exposing the head. Feel for the horn buds. Place the hot iron firmly and directly over the horn bud. Do not be timid. Hold firmly for 10-20 seconds, pushing against the head and turning the iron. The hotter the iron, the shorter the time. A copper colored ring is a good sign of successful disbudding. Release the animal. You may give the kid a bottle of warm milk following the dehorning.

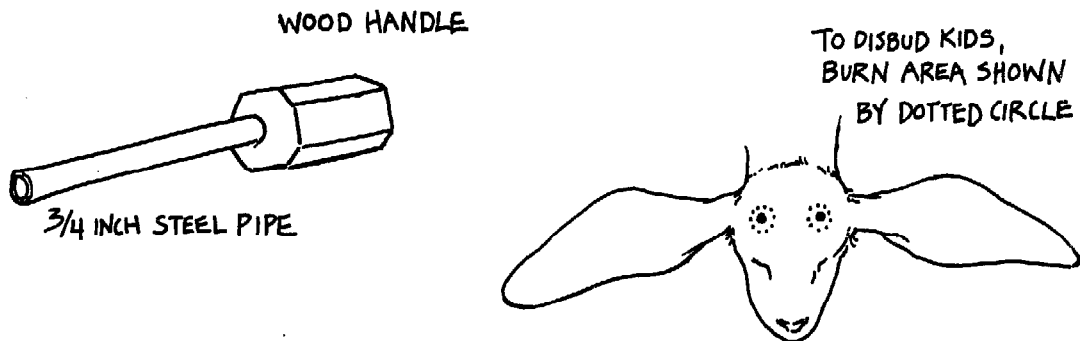

Build Your Own Disbudding Box

by Jan Kelley
Dimondale, Michigan

As goat owners, we all have developed techniques for restraining goats while disbudding. These restraint techniques are usually a direct result of burning either yourself or the goat in an inappropriate place.

And with today's economics, more owners are opting to "do it themselves" rather than pay a large vet bill.

This disbudding box effectively solves restraint and inadvertent burning problems. Its rather large size can accommodate most kids. Bedding will raise the box floor, as many of the kids I disbud are too young to have grown to 18 inches high at the shoulders. I do encounter very large kids and the bedding can be removed to suit each individual goat's height.

The box was designed by Gordon Millis of Mason, Michigan, who was the disbudding "king" of our area for years. Using his basic design, I have added a flexible handle on top, and hooks and eyes on the front sides to hold the top down. The hook and eye arrangement make transport and carry an easy proposition.

To use this box, you straddle the top so you are directly over the goat. With one hand, I steady the head, holding the lower jaw and muzzle, while applying the hot iron.

I then remove the hair cap making sure the area is clear and clean, and do the opposite side in the same manner. Everyone varies this technique to suit their needs, but restraint need never be a problem using this disbudding box.

I use a screwworm aerosol spray around the wound area to discourage flies. You may also wish to use a topical antibiotic powder and/or tetanus antitoxin injection which is quite inexpensive. Some 500 disbuddings later, I've lost one kid to tetanus. However, he was quite valuable. If you think tetanus might be a problem on your farm use your own judgement and/or consult with your veterinarian. □

Use $\frac{1}{4}$ " plywood or masonite, nails, wood screws and glue for assembling.

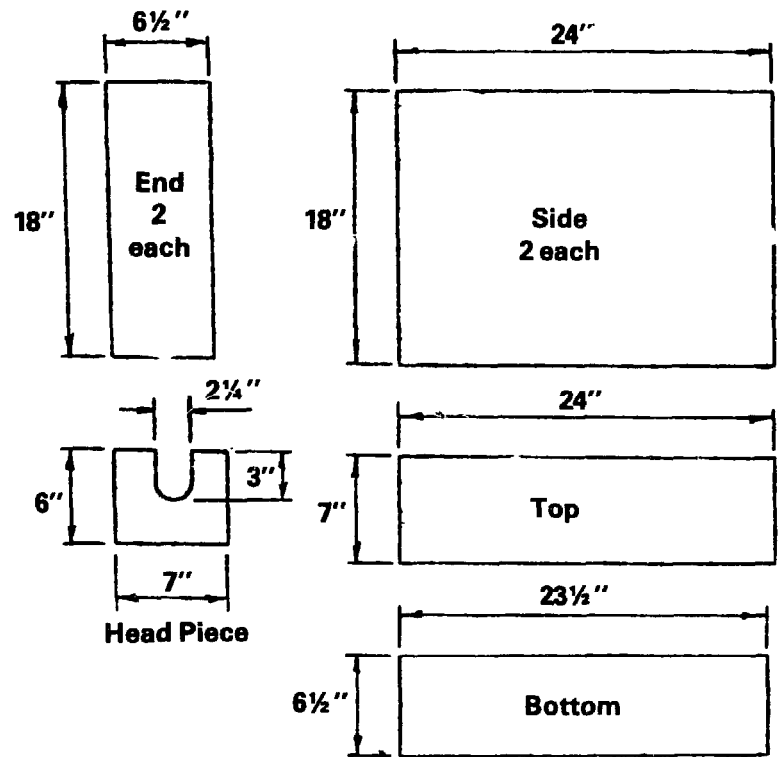

1" x 1"
Corner Bracing

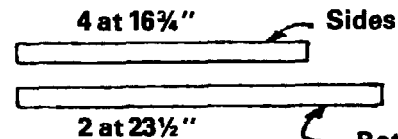

Door Hinge

4 1/2" 2 each

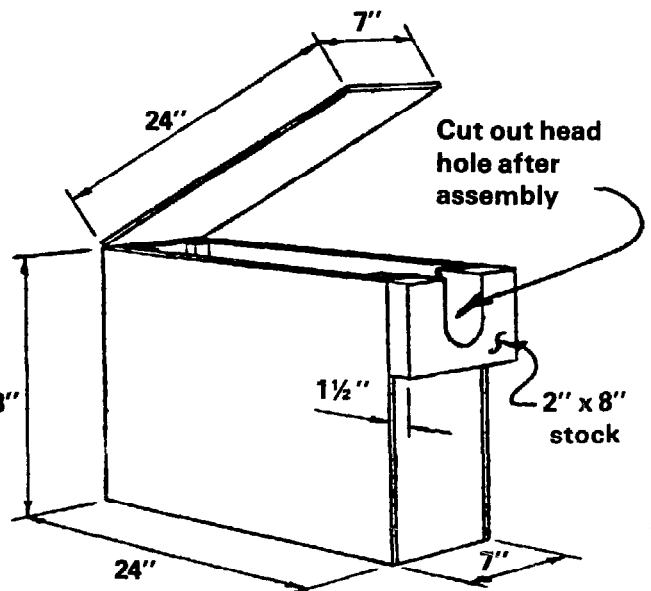
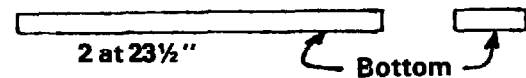

7) HOW TO CARE FOR GROWING KIDS

A feeding schedule for kids through the weaning stage is given under the section on feeding. Your management system will tell you whether or not you will hand feed the kids milk (with bottle or pan) or leave them with the does until weaned. Good nutrition is most important. From the first day kids should be offered green chop and protein supplements as well as salt and water. Provide these in feeders in an area where the doe cannot get to them. Kids are extremely active and need plenty of exercise.

If you want some milk for your family prior to weaning the kids, separate the kids from the doe at night. Milk the mother out first thing in the morning and return the kids to her. This method works best when you have decided to leave the kids with the doe until they are weaned. (This would not be practiced in a CAE prevention program.)

Here is the growth chart for kids once again:

<u>Age</u>	<u>Kg</u>	<u>Lbs</u>
Birth	3.8	8
1 mo.	9.4	21
2 mo.	14.4	32
4 mo.	25.6	57
6 mo.	32.8	73
12 mo.	48.6	108
18 mo.	61.4	136
21 mo.	64.8	144

KID BOX KEEPS KIDS WELL

When kids are under one month and separated from doe, place them in a box with solid sides which is 1 meter square. Change bedding each day. Even if they are outside in the day, putting them in the "kid box" at night keeps them out of cool drafts. Three kids per box.

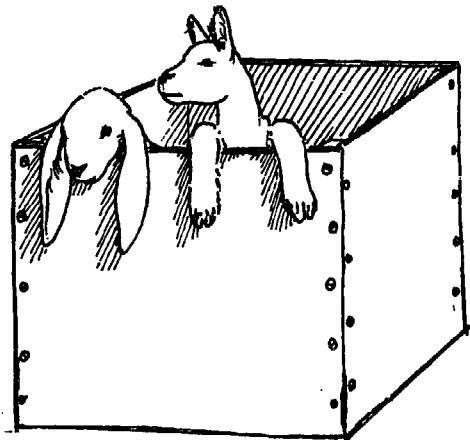

8) CASTRATION AND VASECTOMY OF BUCKS

You will want to keep your finest bucks to sell as breeding animals or to keep for your own herd. However, it is best to castrate or vasectomize the bucks you plan to use for meat. You can do this anytime from two weeks to two months. However, you will get better growth if you wait until nearer two months.

Materials needed:

tetanus anti-toxin shot is recommended prior to either method
sharp knife, razor blade or scissors that have been sterilized
alcohol
iodine
soap and water
person to help

Procedure:

Place the materials needed on a clean surface. Wash your hands with soap and water. Dip the scrotum in either alcohol or iodine.

Castration - Cut off lower third of scrotal sac (holding it taut) and push testicles out through the opening. Gently pull the testicles until the cord is severed. Dip scrotum in iodine. Release kid.

Cut off tail of Epididymis - Grasp lower end of scrotum with forefinger and thumb and pull it taut. Cut off lower third of scrotum. Push testicles through scrotum. You will see two ball-shaped protrusions, one at the end of each testicle. Cut these off. Dip scrotum in iodine. Release kid.

The advantage of this method is that the buck will be sexually active and can be used as a teaser buck.

Cutting off tail of epididymis

CUT OFF LOWER
1/4 OF SCROTUM.
PUSH TESTICLES
THRU INCISION.
CUT OFF BALL
SHAPED
PROTRUSIONS
AT END OF
EACH TESTICLE.
DIP SCROTUM
IN IODINE.

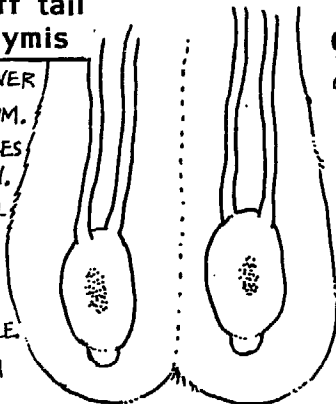

Castration

CUT OFF LOWER
1/4 OF SCROTUM.
PUSH TESTICLES
OUT THRU INCISION.
PULL
UNTIL SEVERED.
DIP SCROTUM
IN IODINE.

9) HEALTH CARE FOR KIDS

3-4 Weeks - Vaccinate

Tetanus

Soremouth (Be cautious when vaccinating as the disease is transmissible to humans.)

Enterotoxemia (over-eating disease)

Use Clostridium Perfringens C & D if available

1 Month

Worm with Thibenzole or check with vet for alternative wormer
Remember internal parasites (worms) will take important nutrition from your animal.

Coccidiosis is often present in kids. Diarrhea is one of the signs.

The following treatment has been used successfully:

At one month, two months and three months of age administer Amprol in proper dosage for 4 days.

Sulmet and other Sulfa based drugs also effective.

External Parasites

In areas where ticks are present spray with Supona solution or other treatment once a week in dry season, twice a week in rainy season.

Signs of Illness:

Temperature

Off Feed

Diarrhea

Mucous Discharge from Nose

Heavy breathing - respiratory problems.

TASKS FOR LESSON V:

- 1) Dehorn Kids
- 2) Castrate Buck Kid
- 3) Vasectomize Buck Kid
- 4) Vaccinate for soremouth, tetanus and enterotoxemia

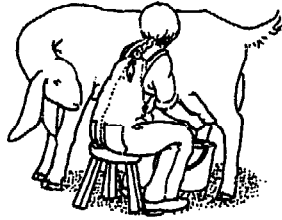
**LESSON VI - CARE OF THE MILKING DOE
MILK PRODUCTS**

Good Nutrition is the single most important thing you can provide for the milking doe. If she has adequate feed, plenty of water, proper health care and exercise, she will provide milk 305 days a year, plus one or two kids every year. Caring for her properly will provide a great deal of satisfaction.

1) MILKING**a) Equipment and Supplies (see illustrations on page 25)**

- A milking stand (optional)
- A milk bucket - a two liter pail is fine. Stainless steel or enamel is best. Any deep container can be used
- 2 cups - one for examining the milk prior to milking
one for teat dip
- A filter or strainer if available or a clean cloth for straining the milk
- A pan for pasteurizing the milk
- A container for the milk
- A bucket of cold water to cool the milk
- Teat dip - may be either 2% iodine or a solution of 50% bleach and 50% clean water.
- Soap and water
- Clean cloths

BE SURE ALL OF THE EQUIPMENT YOU USE IS CLEAN: THAT IT HAS BEEN WASHED WITH SOAP AND WATER AND AIR OR SUN DRIED. COVER THE EQUIPMENT WHEN NOT IN USE WITH A CLEAN CLOTH.

b) Proper Milking Procedures

Put some feed in a bucket or in the feed container attached to the milking stand.

Wash your hands.

Bring the goat to the milking location and tie her or put her on the milking stand.

If the goat's udder is dirty, wash it with soap and water and dry with a clean towel. If the goat's udder is clean and free of manure and dirt you do not need to wash it. Brush away loose hair or dirt.

Direct the first milk from each teat into a cup. Examine the milk. If the milk is clear and good, you are ready to proceed. This first squirt also clears bacteria out of the teat canal. If you see stringy or lumpy milk or blood in the milk, this is an indication of sickness or mastitis. Do not use the milk if this occurs. **DO MILK OUT THE UDDER AND DISCARD THE MILK.** Ask your extension person or veterinarian about proper treatment.

Place the pail under the goat.

Grasp the teat with your thumb and index finger together to trap the milk in the teat.

Gently, but firmly, bring pressure on the teat with your second finger forcing the milk down further. The third finger does the same and then the little finger.

Bump the udder and massage it and you will get more milk.

Do not drag (pull) or jerk down on the udder. Use a steady pressure and loosen your grip before you squeeze again. It should take approximately five minutes to milk the doe.

When you are finished milking, dip each teat into the teat dip. Let the doe remain on the stand until the teats are dry and return her to her pen.

MILK THE DOE TWICE EACH DAY - MORNING AND EVENING - ON A REGULAR SCHEDULE. Twelve hours apart is ideal, but this can vary according to your schedule. The important thing is that you milk at approximately the same time each day. Record the milk production. (There is a chart in the Record Section of this manual.)

PROPER MILKING PROCEDURES



WASHING THE DOE'S
UDDER BEFORE MILKING

MASSAGING UDDER
FOR MORE MILK



TRAPPING MILK
IN TEAT BY CLAMPING
AT TOP WITH THUMB
AND INDEX FINGER

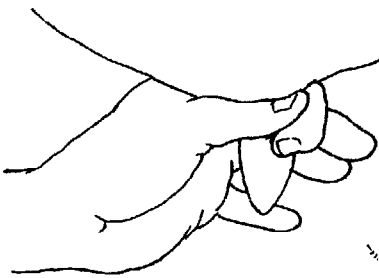

DIPPING TEATS
AFTER MILKING



SQUEEZING MILK DOWN
BY ADDING LOWER FINGERS
- DO NOT LOOSEN THUMB
AND INDEX FINGER -

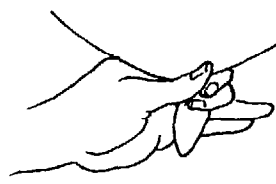

ALL FINGERS
SQUEEZING FIRST
SQUIRT INTO THE
TEST CUP

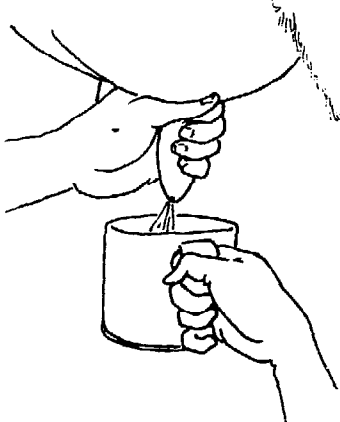

DO NOT
MILK LIKE
THIS



2) HOW TO CARE FOR THE MILK

Strain the milk through a filter or cloth into a clean container. This will remove any hair or other dirt that has fallen into the milk.

Pasteurize the milk. Place the milk on the stove and bring it almost to the point of boiling. Hold for one minute. If you have a thermometer you can use these guidelines:

63° C	145° F	for 30 minutes
72° C	161° F	for 15 seconds
100° C	212° F	for 0.01 second (boiling)

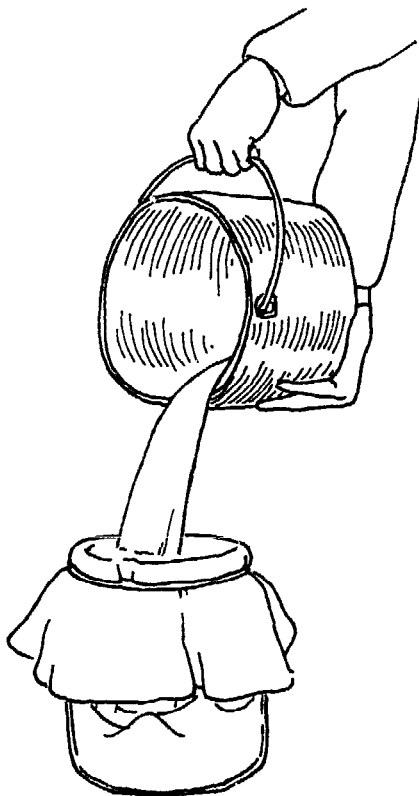

(Feeding pasteurized milk to kids helps with control of diseases like CAE and John's.)

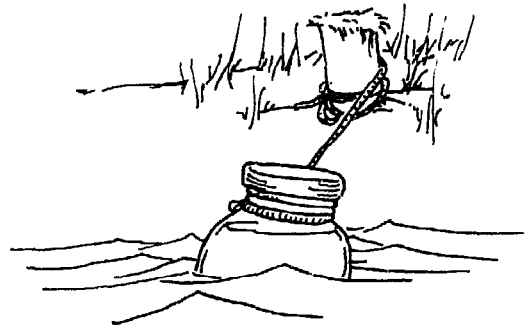
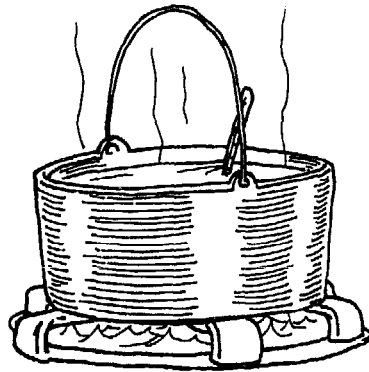

Pasteurized milk should remain sweet for several days even without refrigeration.

Place the milk in a clean container. If you have a jar with a tight cover this is good. Place the container in a bucket of cold water or in a stream to cool. If you have a refrigerator, the milk will stay good for at least a week.

IF POSSIBLE HAVE YOUR VETERINARIAN TEST YOUR DOES FOR BRUCELLOSIS AND TUBERCULOSIS EACH YEAR.

3) DRYING OFF A DOE

Stop milking the doe when she is three months pregnant. Her udder will become hard, but gradually the milk will stop and she will not produce any more. If she is too uncomfortable you can milk her out again, but be sure to milk her out completely.

It is important to dry off the doe because during the last two months the kids are growing fast inside the doe and need the sustenance of her body.

The doe needs a 12% protein feed at this time. Add a few drops of iodine to the drinking water each day toward the end of pregnancy. Keep nutrition high. Avoid abrupt dietary changes.

4) MASTITIS

Mastitis is an infection of the udder caused by bacteria. Good sanitation is the best way to prevent mastitis. This includes using teat dip after each milking.

Hard udders are occasionally seen when a doe kids. These are not necessarily mastitic. Usually having the kid nurse and milking the udder out will relieve this condition.

Mastitis is characterized by heat, pain and swelling of the udder. You may find hard knots in the udder, see some discoloration and abnormal qualities in the milk. Milk may be almost normal or may be watery and pale, dark yellow and thick, chunky, greenish or bloody.

Antibiotics for insertion in the teat are available. Use only one-half the dosage for a cow. Divide between teats, insert and massage. Milking the udder out at one or two hour intervals and applying hot packs will help. When treating with antibiotics allow the recommended withdrawal time before using milk for human consumption.

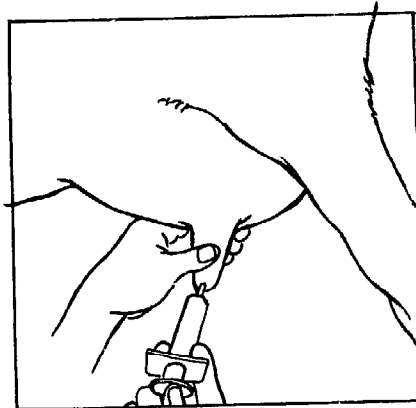

5) MILK PRODUCTS

Yogurt

- a) Heat one liter of milk to just below the boiling point for one minute. This wipes out bacteria.
- b) Cool the milk for 45 minutes to just above body temperature. The milk should feel warm, but not hot, on the inside of your wrist.
- c) Put two tablespoons of plain fresh yogurt or dry yogurt into the lukewarm milk. Be sure these are generous spoonfuls. Stir gently, but well. Mix thoroughly with milk.
- d) Pour the inoculated milk into a clean jar or jars. Put on covers. Put containers in a large pot. Put a tight cover on the pot. Wrap pot with heavy towel or blanket and set aside away from drafts. You can also place the pot in the sun.
- e) Leave 4-8 hours. When yogurt is ready, put in a cool place.

Soft or Cottage Cheese

Use two liters of milk.

Bring goat milk to just under a rolling boil, stirring so it will not stick or burn. Remove from fire, keep stirring and add drop by drop 8 teaspoons vinegar or lemon juice. Strain curds at once. The acidity of the vinegar or lemon juice will determine how much you add. If curds do not form, add a little more.

Use the whey (left from the curds) for drinking or cooking.

Pressed Cheese

Use 7.5 liters or 2 gallons of milk. Heat to 63° C or 145° F. Cool to lukewarm immediately by setting in cold water. Add about 1/4 cup yogurt or buttermilk. Stir well. Dissolve 1/8 of a rennet tablet in 1/4 cup cold water. Add to milk and stir well. Let set until firm or when you insert a knife it comes out clean. Cut curd in 1/4 inch strips up and down and crosswise until you have small pieces. Let stand until all the whey has separated from the curd - at least 1/2 hour to 1 hour. Stir, strain through a cheese cloth or other similar cloth. Squeeze out as much moisture as possible and press overnight. Keep in cool place.

Semi-hard Goat Cheese (takes 2 hours)

Into an 8 liter pot (2 gallons), pour 6 liters or 1.5 gallons of just drawn goat milk. (Do not cool milk - this gives cheese a rubbery texture.) Add 1 cup buttermilk, stir. (Yogurt can also be used.) Dissolve 1/2 of a rennet tablet in 1/4 cup of cold water, crush with spoon. Add rennet solution to warm milk, stir for one minute.

Let stand in a warm place until a firm curd forms, about 45 minutes. Use a long knife to cut curd into cubes two ways, vertically and at an angle. Warm slowly, about 20 minutes (very low heat) to about 42° C or 110° F stirring frequently with a spoon to keep curds from sticking together.

Pour curds and whey into a cloth lined strainer. Drain curds. Add 1 tsp salt and mix with hands. Add herbs if desired. Squeeze out whey by twisting cheese cloth. When firm remove from cloth and wrap in plastic. Ready to eat.

Other Cheeses

You can make a mold out of any round container with holes in it or use a cloth. The mold should hold at least 1 kilo of curd. Piece the container so the whey can drain away from the curd.

You can make a press out of a jar full of water or any other weight that will fit on top of your mold. The weight should be 1-2 kilos.

It is important to have a fine mesh cheese cloth or other cloth to strain the whey from the curd. Be sure that your cloth and all containers are clean. You may even want to sterilize the pans and cloth by boiling in water before using.

Many cheeses require a culture - yogurt or buttermilk. They also require rennet (liquid or tablet). Rennet goes a long way and your culture, once developed, can be saved from a previous batch.

Here are some additional recipes. Note that the temperatures are in Fahrenheit (F). Experiment with your own special cheese. It will provide important protein and good nutrition for your family.

Ricotta Cheese

If you have the ambition, you can use the whey to make some ricotta. It's wonderfully easy.

Take two quarts of whey and heat it until a creamy substance rises to the top. Pour in three cups of milk and heat it until it is scalding. Then stir in 3½ tablespoons of vinegar or lemon juice. Stir briskly until the curd floats, keeping it very hot, not boiling.

Remove the curd to a strainer as it rises and drain it for 7-8 hours at room temperature. Salt to taste and place in cool place. If you prefer to save the whey for another time, it will keep for about a week in a cool place.

Brousse Cheese Recipe

Heat one gallon of milk to 90° F in a sterilized, stainless steel or enameled pan immersed in a larger pan of water. (Heat goat's milk only to 85° F). Stir in thoroughly 1 tablespoon of cheese starter culture (or 1 tablespoon of either buttermilk or yogurt). Cover pan and leave for 30 minutes at same temperature. Dissolve 1/4 rennet tablet in 1/4 cup cooled, sterilized water and add to milk, stirring for one minute. Cover pan again and leave undisturbed at the same temperature for one hour until curd is set.

Cut curd carefully into 1/2 inch cubes and let rest for 10 minutes. Slowly raise temperature to 120° F (this should take about an hour) and gently stir curds with stainless steel spoon (or your clean hands), bringing curds up from the bottom and carefully cutting any that are over 1/2 inch cubes. Curds will gradually lose their cube shape as they release whey. When they finally look like very large curd cottage cheese, ladle them into a sterilized cheese cloth placed over a strainer in a larger bowl.

Gather corners of cloth and hang cheese to drain over a bowl to catch the whey for an hour or two. Empty curds from cloth into a clean dry bowl and break up into small clumps, working about 2 teaspoons of coarse salt into the curds.

Place salted curds into the sterilized Brousse mould, pressing them down firmly with stainless steel spoon or ladle. Cover top of cheese with a circle of cheese cloth and set mould on an overturned bowl set in a larger bowl to catch the whey. After about an hour, fill a 2 pound coffee can (or similar jar) with water and place on top of cheese to press it.

In about two hours or so, gently remove cheese from mould and carefully replace it in the mould - upside down. Replace weight and continue pressing process. Turn cheese every few hours until it has taken on the neat, symmetrical shape of the mould, wipe dry with a clean cloth and place on a clean folded towel at room temperature to dry and form a rind. Turn occasionally to allow even drying. After 24 hours, cheese may be placed in cool place for 3 to 5 days to age before cutting.

(From the New England Cheesemaking Supply Co., P. O. Box 85, Ashfield, MA 01330)

HOW TO MAKE YOUR OWN RENNIN

Rennin is the ingredient that causes the curd to set. It is important to have rennet to make hard cheese.

Method 1)

Go to the slaughter house and ask for the fourth stomach (Abomasum) of a calf or young goat.

Clean and salt the stomach and hang it up to dry in a cool place. Store it where the dust will not get on it.

The day before you are to make cheese, break off a small piece of the dried stomach (about the size of your hand). Put in a small container and cover with cooled, sterilized water. Leave for at least three hours.

Add 1/4 cup of this solution to the milk when you are ready to form the curd.

Keep the leftover solution in a cool place. Use within three days.

Note: You can sterilize water by boiling it for 15 minutes and cooling.

Method 2)

If a calf or a kid goat is slaughtered or dies and is not more than two days old, the stomach will contain colostrum.

Take the colostrum out and save it. Clean the stomach carefully. Return the colostrum to the cleaned stomach. Tie off the opening. Hang in a cool place to age. When the contents are like butter or margarine, it is ready to use. Keep as cool as possible.

Use 1/2 teaspoon to set 8 liters of milk. Mix the colostrum in 1/4 cup cool water.

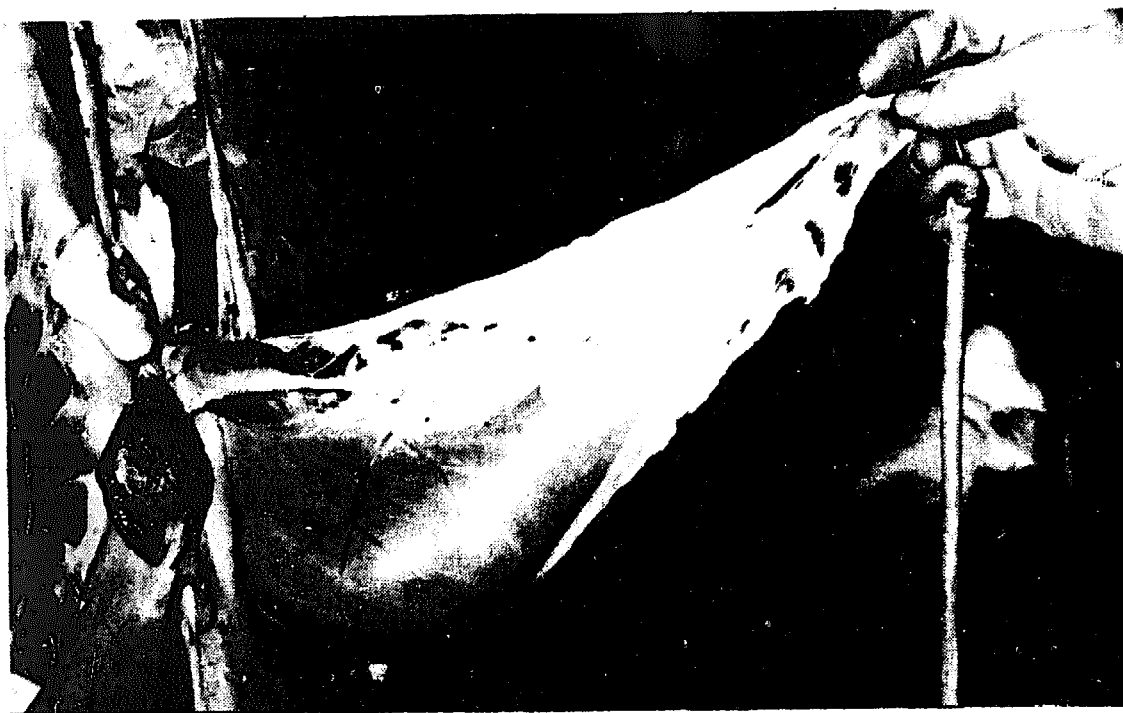

DOMESTIC RENNET

Use abomasa from kids that have been fed exclusively on milk (i.e., slaughtered when roughly 1 month old).

On receiving the abomasa, clean the outside portions, remove excess fat, close one of the two openings on each abomasum with a well-tied knot. Insert a pipette or straw into the other end and blow up like a balloon. Knot the end to keep the abomasum blown up. Dry in a dry, well-ventilated area for 2-3 days. Once the abomasa have dried, they keep for several months.

Rennet - 2 abomasa

- Cut the abomasa into 5-cm ($\frac{1}{4}$ -inch) wide strips.
- Add 500 ml water, 45 ml coarse salt, a pinch of boric acid.
- Let steep for 5 days at roughly 12°C (55°F). Stir 2 or 3 times during this period. Leave covered.
- Add 250 ml water and 15 ml coarse salt.
- Pour.

Pour first through an ordinary strainer, then through cheesecloth. Next pour through 3 thicknesses of cheesecloth. Repeat the last operation.

DIRECTIONS for Farmhouse Cheese

1 WARM THE MILK. Pour 2 gallons of milk into a stainless steel or enameled pot, set in a sink of warm water, stir and warm the milk to 90°F.

2 RIPEN THE MILK. Add 2 ounces of cheese starter culture and stir in well, yet gently. Cover pot and leave for 45 minutes to ripen at 90°F.

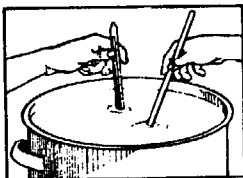

NOTE: If you plan to add cheese color, do it at this point - before the rennet is added.

3 ADD CHEESE RENNET. Dissolve completely one quarter of a cheese rennet tablet in a quarter cup of cooled, sterile water, breaking and crushing with back of spoon as you stir. Stabilize temperature of milk at 90°F. by regulating water temperature in sink outside cheese pot. Protect the pot from drafts. Add rennet solution and stir in thoroughly for one minute with a stainless steel spoon or ladle. Top-stir (if using cow's milk) 1/4 inch with back of ladle for another minute to keep cream from rising.

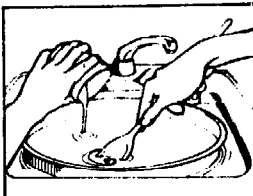

4 LET SET 'TIL CURD "breaks clean". Let covered pot stand undisturbed until a firm curd forms (30 to 45 minutes). Test firmness with your finger. When it "breaks clean", it is ready to cut.

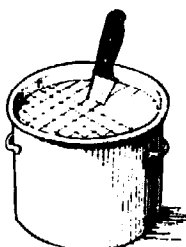
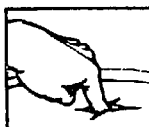

When the curd is all in cubes, gently stir them, turning them over, bottom to top, cutting any pieces of curd that are still too big.

5 CUT CURDS 4 WAYS. Cut the curds into small (1/2 inch) cubes with a long-bladed knife or spatula. The blade must be long enough to reach all the way to the bottom of the pot without immersing the handle. Start at one side of the pot and cut vertical, parallel lines in the curd, 1/2 inch apart. Turn the pot 90° and cut again at right angles to the first cuts. Then, with the knife at a slant, using the original lines in the curd, cut at a 45° angle in both directions. Your aim is to cut the entire curd into 1/2 inch cubes.

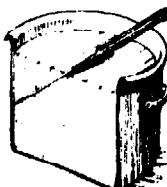

6 SCALDING THE CURD:

Run some hotter water into the sink outside of the pot and raise the temperature of the curds slowly to 100°F. The temperature must not rise more than 2° every 5 minutes. This should take 30 minutes, and you should stir gently as you cook. The curd pieces will shrink in size as the heating continues. The whey will increase as the curds decrease in size.

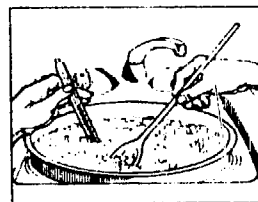

7 DRAINING THE WHEY Cover the pot and let the curd settle for 5 minutes, then pour off the whey into another pot (save it for Ricotta or Mysost). Pour the curds into a cheesecloth-lined colander.



8 HANG CURDS TO DRAIN: Knot one corner of the cloth around the other three corners and hang the bag of curds to drain for one hour at 70°F.

9 SALTING THE CURDS: Pour the drained curds into a scalded bowl and break them up with your fingers (gently) into walnut sized pieces. Mix in thoroughly 2 tablespoons of cheese salt for each 4 pounds of curd.

10 MOULDING AND PRESSING THE CURD

Scald and cool your mould and cheesecloth. Line mould with cheesecloth and put curds into the mould, folding cheesecloth neatly over the top when it is full.

Put the round follower on top of the curds and place under 20 pounds pressure for 10 minutes.

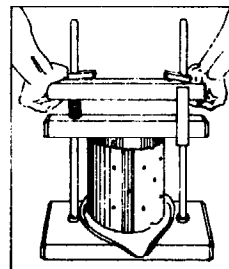

Then turn the mould upside down and replace the follower on top and increase pressure to 30 pounds for another 10 minutes.

Repeat twice more at 10 minute intervals and increase pressure by 10 pounds each time you turn the cheese. The last time, leave cheese under 50 pounds pressure for 14 to 16 hours.

11 FINISHING THE CHEESE: Remove the cheese from the mould and carefully peel away the cheesecloth, taking care not to rip the surface of the cheese. Air dry the cheese at room temperature on a cheese mat until a rind has developed and surface is dry. Turn several times a day. After 3 to 5 days, it will be ready to wax.

12 WAXING AND CURING THE CHEESE: Paint melted cheese wax (or paraffin - in a pinch) on a cool, dry cheese. Use a small, real-bristled paint brush kept just for this purpose. Wax must always be melted in a double boiler to reduce danger of fire. Cover cheese completely. Cure your Farmhouse Cheese at 50°F for at least three months. It's flavor will be even better after six months. Turn the cheese daily for 2 weeks, and occasionally after that until it is eaten.

COMPOSITION OF MILK

	<u>Solids/not Fat</u>	<u>DM</u>	<u>Protein</u>	<u>Fat</u>	<u>Lactose</u>	<u>Mineral</u>
Goat	8.9	12.6	3.4	3.8	4.1	0.8
Cow	9.0	12.2	3.2	3.6	4.7	0.7

The following values were compiled by Charles A. Parry, PhD., McLean, Virginia.

ITEM		Breast Milk	Goat's Milk	Cow's Milk
All Items Per Liter				
Energy	Kcal	710	670	660
Protein	gm	11	32	42
Fat	gm	38	40	37
Carbohydrate	gm	68	46	49
Calcium	mg	340	1290	1430
Phosphorus	mg	140	1060	1120
Sodium	meq	7	15	27
Potassium	meq	13	46	45
Iron	mg	.5	1	0.5
Zinc	mg	3.5	2.4	3.5
Chloride	mg	375-450	1200	1050
Magnesium	mg	46	100-145	120
<u>Vitamins</u>				
A	i.u.	2000	2074	1500
B ₁	mg	0.160	0.400	0.440
B ₂	mg	0.360	0.1840	0.2100
B ₃ (Niacin)	mg	1.47	1.9	1.0
B ₆	mg	0.100	0.70	0.640
B ₁₂	mcg	0.3	0.6	4.3
Pantothenate	mg	1.84	3.4	3.5
Folacin	mcg	52	6	55
Biotin	mcg	8	39	31
Choline	mg	90	150	121
Inositol	mg	330	210	110
C	mg	43	15	21
D	i.u.	22	22	14*
E	i.u.	1.8	—	0.4
Essential Fatty Acids, per 100 gm of Milk Fat			4.1	2.6
Percent Fat Globules Less Than 3 dram			63	43

* Not Fortified

Note: Actual values given vary over a considerable range. Reasonable values within ranges have been chosen as being representative.

TASKS FOR LESSON VI:

- 1) Build a Milking Stand
- 2) Learn Proper Milking Techniques
- 3) Pasteurize Milk
- 4) Make Cheese

LESSON VII - HEALTH CARE FOR YOUR GOATS

A HEALTHY GOAT

- . eats well
- . has a shiny coat
- . is free of disease
- . has strong legs and feet
- . chews its cud
- . is sociable
- . has eyes that are bright and clear

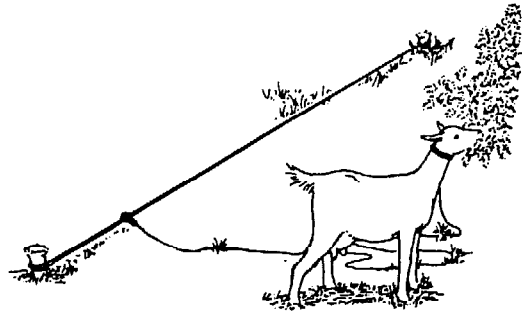

NORMAL PHYSIOLOGICAL DATA FOR A GOAT

- | | | |
|--------------------------|-----------------------------------|-------------------|
| . Temperature | 38.7° - 40.2° C | 101.7° - 104.5° F |
| . Heart (pulse) rate | 70-80 per minute, faster for kids | |
| . Respiration rate | 12-15 per minute, faster for kids | |
| . Rumen movements | 1 to 1.5 per minute | |
| . Onset of heat (estrus) | 7-12 months | |
| . Length of heat | 12-48 hours | |
| . Heat cycle | 17-23 days - average 21 days | |
| . Length of gestation | 145-156 days - average 150 days | |

SIGNS OF ILLNESS

- . off feed
- . standing off from group
- . dehydration (Pull skin out from body. If skin sticks to itself and does not slip back easily, animal is dehydrated.)
- . abnormal temperature
- . pale mucosa around eyes and in mouth
- . diarrhea
- . heavy mucous in nose and mouth
- . no sign of cud chewing
- . limping
- . runny eyes
- . blindness
- . swelling at any point in body
- . hair falling out or rough in appearance
- . circling movements
- . clots or blood in milk

GOOD HEALTH CARE BEGINS WITH

- . daily observation
- . good nutrition which includes green chop (hay and forage), protein and energy supplements and plenty of water
- . sanitation - clean pens, feeders and water buckets
- . exercise
- . a vaccination program - tetanus toxoid, soremouth, enterotoxemia (over-eating disease)
- . parasite control for internal and external parasites
- . regular hoof trimming

PREVENTATIVE HEALTH PROGRAM

The following preventative health program is recommended:

PREGNANT DOES

Vitamin E and Selenium - 60 days before kidding

Clostridium Perfringens C & D - 3 weeks before kidding

Tetanus Toxoid - 3 weeks before kidding

KIDS: 3 weeks to 3 months of age

Tetanus Toxoid	1/2 cc - 2 shots two weeks apart Annual booster
Contagious Ecthyma (Soremouth)	Vaccinate under tail or in bare skin under front leg at point of elbow. Be sure to check in 3 days for a take. Revaccinate every two years in heavily infected areas.
Clostridium Chauvoei Septicum-Novyi-Sordellii Perfringens Types C & D Bacterin	Protection against enterotoxemia, (over-eating disease), blackleg, malignant edema, black disease and clostridium sordellii infections. Give at 1 month, 6 weeks, 5 months of age. Annual booster

NEW ANIMALS COMING INTO HERD SHOULD ALWAYS BE VACCINATED.

GOOD HEALTH CARE BEGINS WITH DAILY OBSERVATION. Approach your goat as an individual. Be aware of any changes in her environment. Be gentle.

HOOF TRIMMING

While it is possible for goats on a rough terrain to wear down their hooves, most will need trimming at regular intervals. The diagrams below show the proper trimming method. Use either shears such as the Burdizzo Hoof Trimming Shear or a sharp knife.

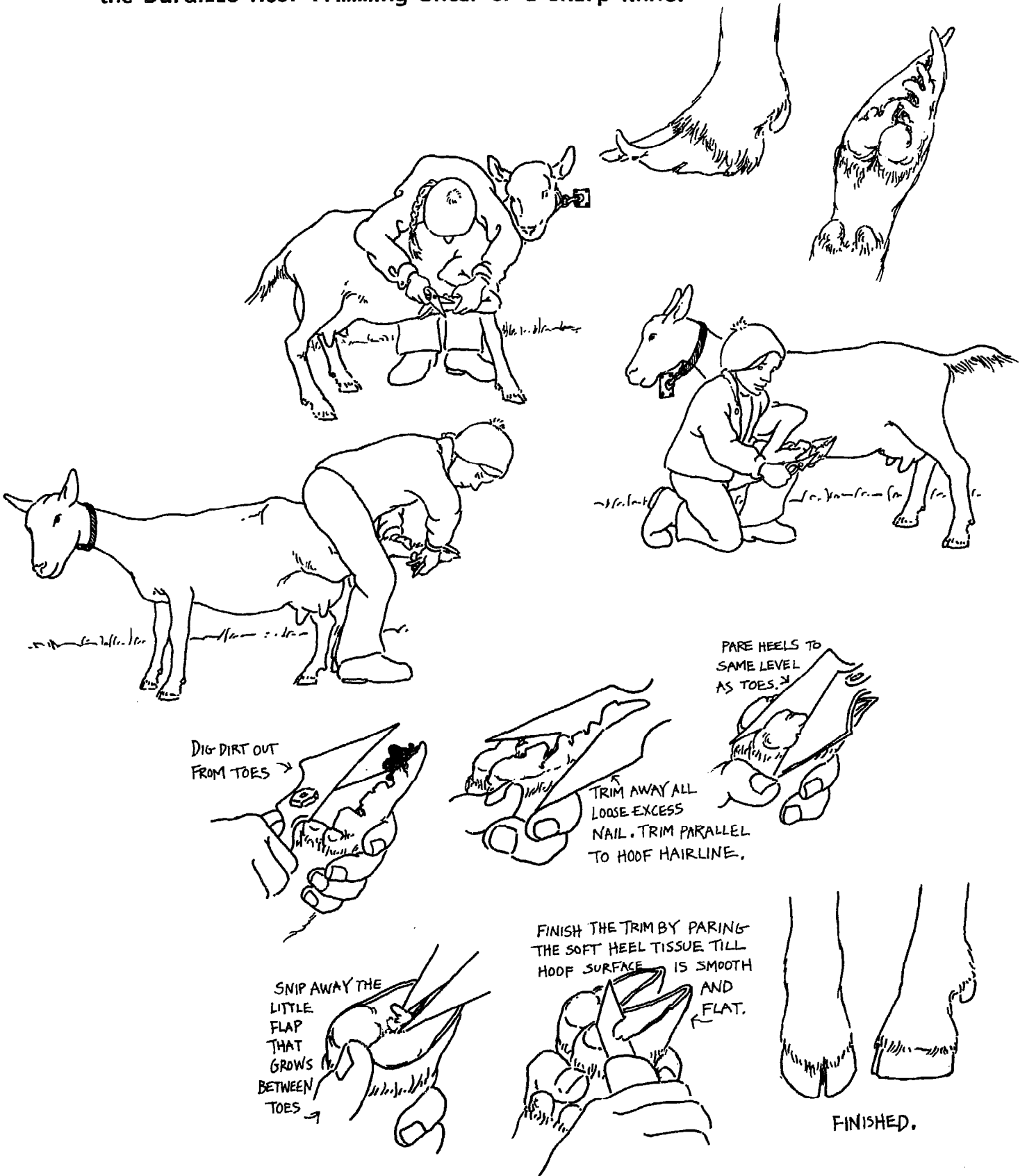

HOW TO TAKE A GOAT'S TEMPERATURE

Normal Temperature is 38.7° - 40.2° C
101.7° - 104.5° F

Wipe thermometer with antiseptic solution - alcohol, iodine or bleach. Shake the thermometer down to below normal, with a quick snap of the wrist.

Be sure not to hit anything as the thermometer breaks easily. Insert the mercury end of the thermometer into the goat's rectum.

Wait for two minutes.

Remove thermometer, wipe clean and read.

Shake down again.

Wipe with antiseptic before storing.

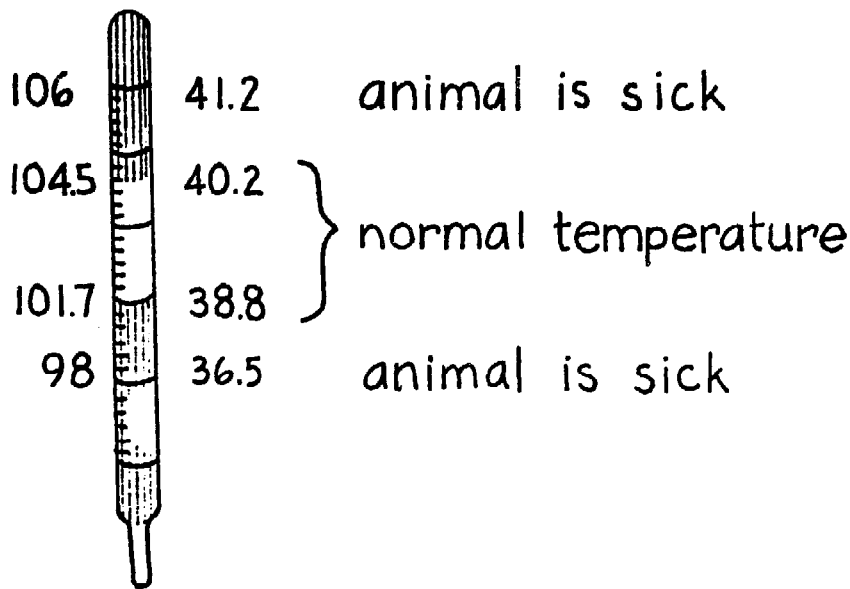

HOW TO DRENCH AN ANIMAL

Liquid medication can be given as a drench. You will need a dose syringe or a Fanta, Coke or beer bottle.

Measure the correct amount of drench. Keep goat's head in normal position. Place end of syringe or bottle in left side of mouth on back of tongue. Slowly pour drench into esophagus.

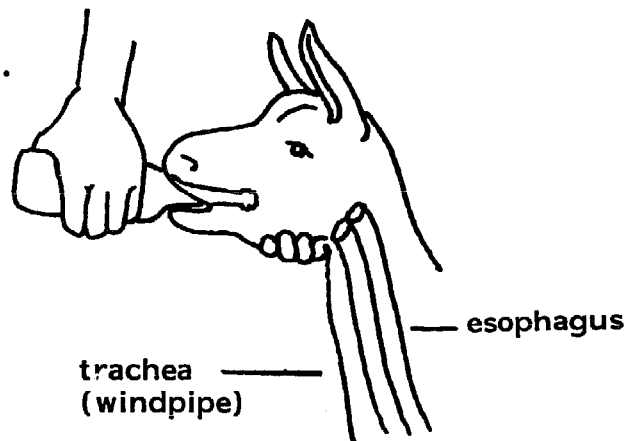

HOW TO GIVE AN ANIMAL A BOLUS

It is easier to give an animal a bolus if you have a tube made especially for this purpose or you can make one yourself by using two pieces of plastic pipe which can slide into each other - about 2 cm.

Remove bolus from container in proper dosage. Break bolus if needed.

Insert bolus in end of balling gun or tube. Hold tube upward to prevent bolus from dropping out.

Put tube in left side of goat's mouth.

Push plunger forward forcing bolus into esophagus.

Hold goat's mouth closed and stroke throat downward until bolus is swallowed.

HOW TO GIVE AN INJECTION

1) I.V. or Intravenous - Should be performed only by a veterinarian!

2) I.M. - Intramuscular

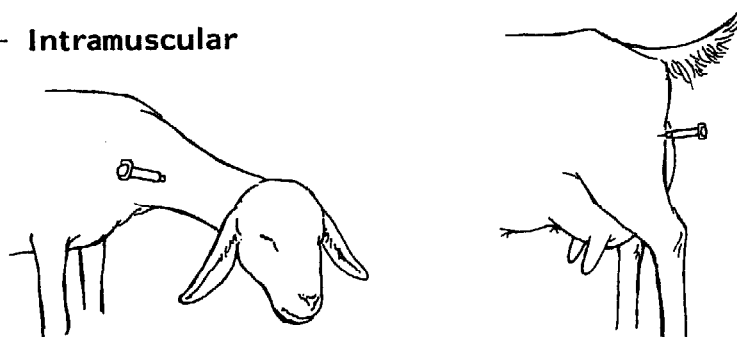

Use 20 gauge 1" needle for adult goats; 20 or 22 gauge 1" needle for kids. Insert needle to hub in thigh or in heavy part of neck. Draw back on plunger to aspirate for blood. If blood flows into syringe, withdraw needle and replace in another site.

3) SubQ. or Subcutaneous

Use same size needles as for I.M. injections. Lift the loose skin of the flank or underneath leg and insert needle at an acute angle. Aspirate for blood as with I.M. If performed properly, a bleb should appear under the skin as the plunger is depressed.



NOTE: ALWAYS USE A STERILE NEEDLE AND SYRINGE WHEN GIVING INJECTIONS. BOIL NEEDLES AND SYRINGES IN WATER FOR 20 MINUTES TO STERILIZE.

ALWAYS CHECK DOSAGE FOR SPECIES AND WEIGHT OF ANIMAL.

GUIDE TO COMMON GOAT DISEASES

The following is only a partial list of diseases affecting goats. Your veterinarian is your best source for diagnosis and treatment, but in the absence of a vet, these guidelines will be helpful.

HEALTH PROBLEM	SIGNS	PREVENTION AND TREATMENT
<u>NON-INFECTIOUS</u>		
ANEMIA	Listless, lack of energy, pale mucosa around eyes, pale gums.	Improve nutrition. Treat for parasites. Add iron to diet.
ABORTION	Loss of fetus.	Abortions may occur in 15% of gestations. Injury, such as butting, is a major cause of abortion. Poor nutrition and mineral deficiencies can cause abortion, along with viral and bacterial infections.
BLOAT	Swelling of paunch, shows on left side.	Prevent rapid filling on legume pastures. Drench with palm oil or mineral oil. Keep animal on feet and moving. Feed dry non-legume grass to animal before putting out on legume pastures.
KETOSIS	Lack of appetite. Occurs in late pregnancy or shortly after kidding. Normal temperature, animal prefers hay to grain - incoordinate. Sweet smelling breath.	Preferred Treatment: propylene glycol, if available. Or give sugars, honey or syrup. Prevent obesity in early pregnancy. Increase plane of nutrition in last two months of pregnancy.
NAVEL ILL	Lameness, stiffness, swollen joints, fever in newborn kids. Fatal if not treated.	Prevent by sanitation at birth and dipping navel with 7% iodine at birth. If infected give Pen-strep injections, plus broad spectrum antibiotic in milk.
TETANUS	Sawhorse stance, prolapse of third eyelid, stiffness. Enters through wounds.	Vaccinate with tetanus toxoid or if not vaccinated, give tetanus anti-toxin at onset of disease. Give large doses of penicillin.

HEALTH PROBLEM	SIGNS	PREVENTION AND TREATMENT
----------------	-------	--------------------------

CONTAGIOUS AND INFECTIOUS

ABCESSES
Caseous
lymphadenitis

Swollen lymph nodes commonly occurring under jaw and ear, in front of shoulder, on flank, above udder or scrotum or above hock. The nodes may be warm and swell 3-5 cm or larger. Contain greenish, cheesy pus.

Avoid contaminated feeds. Can be contracted through breaks in skin, insect bites, etc. Spread by contact. Treat by surgical lancing, irrigate with 7% iodine. Burn all material from abscess. Treat daily until healing occurs.

BRUCELLOSIS

Goats show only vague symptoms: occasional mastitis; lameness of feet, loose stools, does may abort in final 4-6 weeks of pregnancy. Rare in goats.

In goats caused by *Brucella melitensis*; only rarely do other species of *Brucella* affect goats. Disease spreads when goats eat contaminated feed or lick infected material from the reproductive track. Organism transmitted to humans through drinking raw (unpasteurized) milk from infected animals. No treatment for infected animals. Vaccine used to control spread of disease. Goats should be tested yearly.

CAPRINE
ARTHRITIS
ENCEPHALITIS
(CAE)

A viral disease. Goats develop weakness in rear legs, stumble and later cannot rise; they have no fever and eat well. Signs usually appear between one and two years. Older goats exhibit swollen joints and severe arthritis.

Transmitted most likely through colostrum and milk. Also spread by prolonged direct contact. Taking kids from doe and feeding heat-treated colostrum has been effective for prevention. (See Page 29.) A high percentage of goats tested show a positive titer, but actual clinical diagnosis of the disease is not as widespread.

HEALTH PROBLEM	SIGNS	PREVENTION AND TREATMENT
<u>CONTAGIOUS AND INFECTIOUS</u> (continued)		
COCCIDIOSIS	Most often seen in young kids. Affects digestive system and causes unthrifty condition and death. Persistent diarrhea, bloody feces or white feces may be present.	Give Amprol solution for 4 days at correct dosage. Treat with scour medication. Give electrolyte solution of 1 tsp. table salt, 1/4 tsp. baking soda, 4 oz. glucose (karo syrup), 2 quarts water. Give solution free choice. Sulmet also good treatment.
CONTAGIOUS ECTHYMA Soremouth	Lesions begin as small red spots in corners of mouth and become larger scabby areas. May also affect nostrils, eyelids and mouth. Scabs last 1-4 weeks. If in kids it may spread to teats of doe and prevent nursing.	Vaccinate kids at two weeks of age. Revaccinate every two years. Infected goats are said to be immune. Separate infected animals. Area in which animals are housed and pastured will be contaminated for up to 10 years.
DIARRHEA	Loose stools. Sign of another primary problem. May be caused by worms, coccidiosis.	Take off feed for 1 day. Give electrolyte solution. Give kapectate. Serious diarrhea - treat with amprolium or sulfa drugs.
ENTEROTOXEMIA Overeating Disease	Convulsion, sluggish, staggers, loss of appetite, diarrhea, death within 24 hours. Usually affects animals in good condition.	Vaccinate at least once a year. Good feeding practices. No effective treatment.
FOOT ROT	Lameness, inflammation and swelling of foot. Dermatitis commonly seen between toes.	Trim feet. Keep in dry lot and under sanitary conditions. Remove abcess between toes and destroy. Bathe infected area in copper sulfate solution, Chloramphenicol, formaldehyde or a solution of 75% bleach, 25% water. Advanced cases should be given heavy doses of penicillin.

HEALTH PROBLEM	SIGNS	PREVENTION AND TREATMENT
CONTAGIOUS AND INFECTIOUS (continued)		
HEMORRHAGIC SEPTICEMIA Shipping Fever	Fever, cough, discharge.	Most often encountered during periods of stress. Vaccination available. Give 1 week prior to stress, i.e. transporting. Nasalgen effective. Treat with antibiotics.
MASTITIS	Inflammation of udder. Hard knots. Bloody, thin or stringy milk. Caused by bacterial infection.	Milk udder out several times each day. Apply hot compresses. Use appropriate antibiotic in teats.
PINK-EYE Kerato-Conjunctivitis	Tearing of eyes in early stages. Inner eyes will be red. In advanced stages cloudiness appears and sometimes total blindness.	Administer lacribiotic or other salve which contains neomycin, polymycin and/or a Terra-Cortril Ophthalmic Suspension - twice each day. Keep animals out of direct sunlight. Apply a patch to severely infected eyes. Do not touch eye with tube while treating. Powders available, but often irritate eye.
PNEUMONIA	Nasal discharge, tongue out, rapid exaggerated movements of ribs, raspy sounds from lungs; temperature may be normal to high.	Bad ventilation is most often cause; also drafts and overcrowding. It may be a secondary infection following shipping fever. May result in death. Treat with Tetracycline, Oxytetracycline, Tylosin or Pen-strep.

HEALTH PROBLEM	SIGNS	PREVENTION AND TREATMENT
----------------	-------	--------------------------

PARASITES

Good nutrition is the best prevention for any type of parasite problem along with good sanitation, rotating pastures and feeding hay and other forage in racks off of the ground.

Parasites rob important nutrition from your animals and treatment and prevention are extremely important in the productivity of your herd.

EXTERNAL PARASITES

LICE	Animal will pick at hair, hair coat will look out of condition.	Treat with powders or spray solution such as Coral, Toxaphene, Lindane.
-------------	-----------------------------------------------------------------	-------------------------------------------------------------------------

EAR MITES	Dead skin in ear.	Mix cresyl with oil and rub in skin and clean ears once a week for 3 weeks.
------------------	-------------------	-----------------------------------------------------------------------------

TICKS

Ticks are a serious problem and a good program of management must be used to prevent fatal diseases.

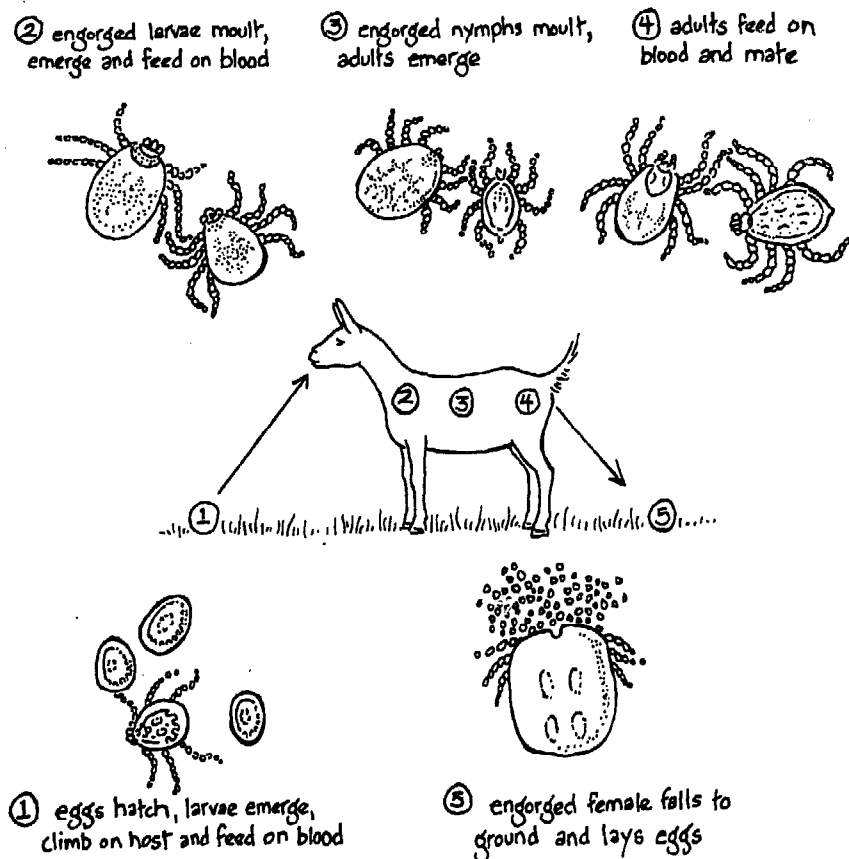

HEALTH PROBLEM

SIGNS

PREVENTION AND TREATMENT

TICKS AND TICK-BORNE DISEASES (continued)

ANAPLASMOSIS

White mucosa, anemia high temperature, animal is weak and slow. Abortion common. Wide-spread in African countries.

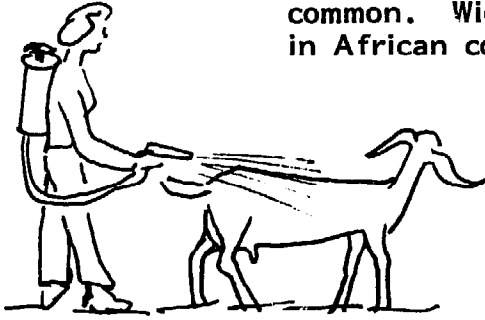

Prevention by regular dipping or spraying. Spray or dip animals twice weekly in rainy season, once weekly in dry season. 10 cc Supona mixed with 16 liters water effective. Be sure feet and head are treated.

Infected animals need good nursing care. Oxytetracycline (3-5 mg/kg body weight) should be administered daily.

HEARTWATER

Animal does not eat. High temperature. Continual movements of limbs, head, ears, tongue and jaw. Eventual convulsions and death.

Prevention by regular dipping or spraying described above. Administer Oxytetracycline or Sulphadimidine intravenously.

Note: Other products for spraying or dipping
Sevin, Lindane, Melathion, Asuntol

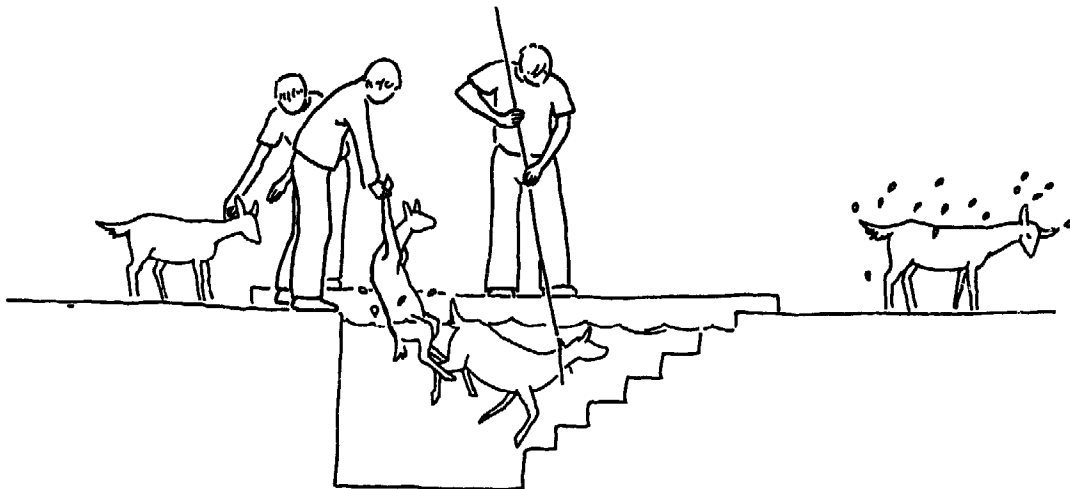

HEALTH PROBLEM	SIGNS	PREVENTION AND TREATMENT
----------------	-------	--------------------------

OTHER SKIN PROBLEMS

MANGE	Hair falls off, skin dry and flaky.	Apply red oil mixed with cresyl.
RINGWORM	Round scaly area with thin hair coat. Spreads rapidly. Highly contagious.	Thorough scrubbing with disinfectant. Treat with iodine or rub on thibendazole paste. Isolate infected animal.

INTERNAL PARASITES

STOMACH WORMS	Unthrifty animal
INTESTINAL WORMS	Anemia
TAPEWORMS	Pot-bellied
LUNGWORMS	Weight loss
LIVER FLUKES	Diarrhea Pale Mucosa Pale Gums

The following products should be used after reading the instructions on the product label. Be sure to note the product use with pregnant and/or lactating animals.

- Albendazole - (Valbazen)
Stomach worms,
Intestinal worms,
Tapeworms, Flukes
(Do not use in first 45
days of pregnancy.)
- Ivermectin - (Equalan)
Stomach worms,
Intestinal worms,
Lungworms, Tapeworms,
Flukes and external
parasites
- Fenbendazole - (Panacur,
Oxfendazole)
Stomach worms,
Intestinal worms,
Tapeworms
- Lavamisole - (Tramisol)
Stomach worms,
Intestinal worms,
Lungworms
- Thiabendazole - (Thibenzole,
TBZ, Omnizole)
Stomach worms,
Intestinal worms.

In heavily infected areas,
worm goats every four weeks.
Give second dose 2-3 weeks
later and repeat in 4 weeks.
Alternate wormers.

LIFE CYCLE OF TYPICAL STOMACH WORM

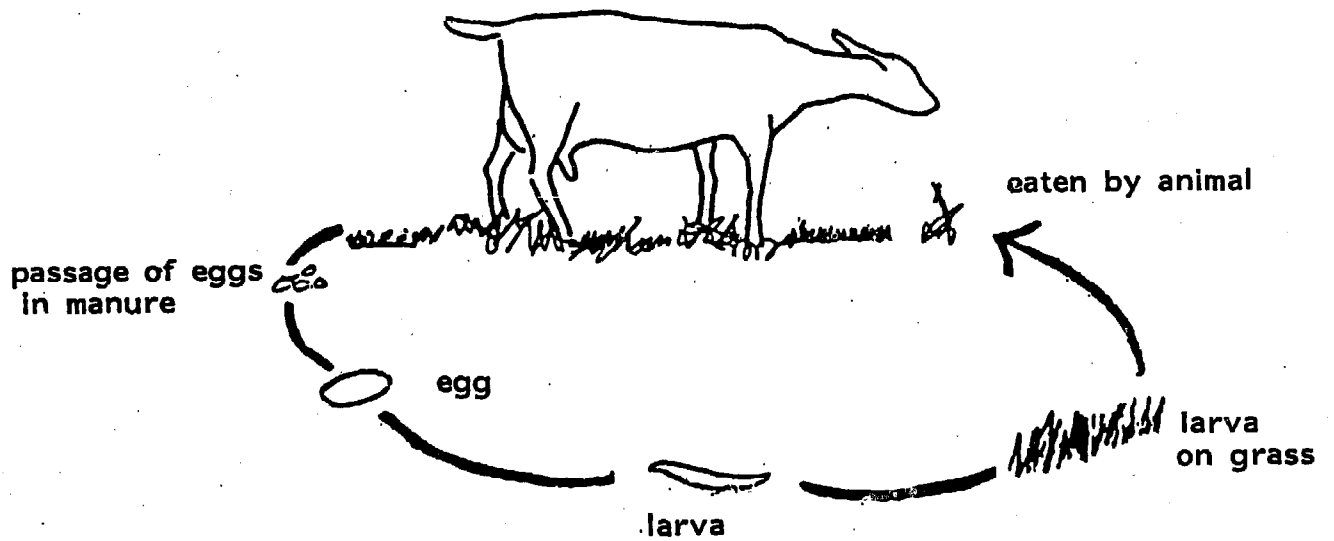

The cycle for the Tapeworm and Liver Fluke is similar except the intermediary host for the Tapeworm is a mite and for the Liver Fluke a snail.

LIFE CYCLE OF LIVER FLUKE

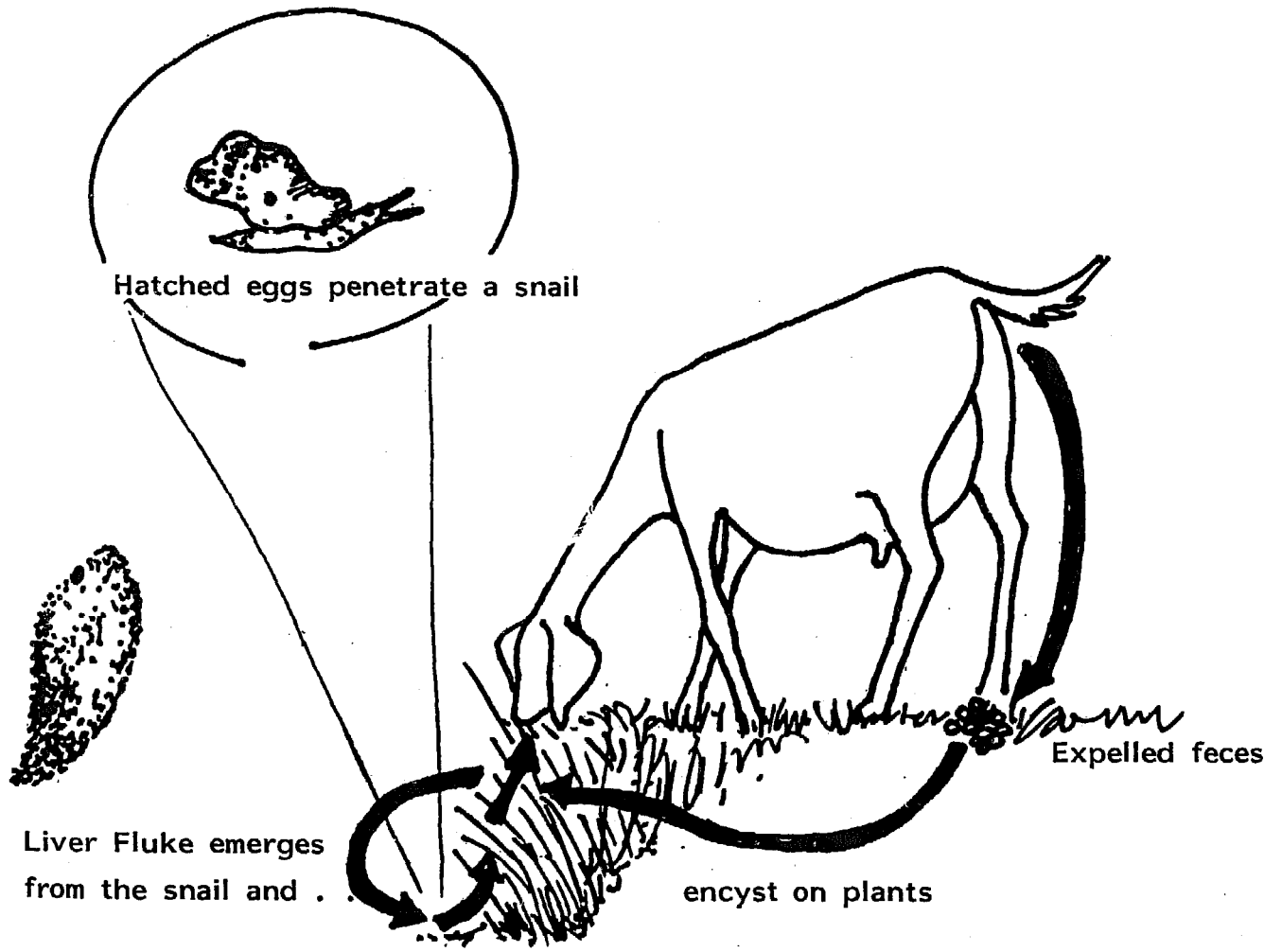

ITEMS AND MEDICATIONS YOU WILL NEED TO KEEP YOUR GOAT HEALTHY

Thermometer	
Disposable Syringes	3 cc and 5 cc are most used
Needles	20 and 22 gauge
Wounds	Vaseline, Cresyl, 3% Hydrogen Peroxide, Iodine
Foot Rot	Copper Sulphate, Bleach or Formaldehyde
Scours	Kaopectate, Electrolytes
Coccidiosis	Amprol
Respiratory Illness (pneumonia)	Terramycin, Oxytetracycline
Wormers	Thibenzole, Albendazole, Panacur, Omizole, Tramisol
Teat Dip	Iodine, Bleach
Tick Spray	Supona, Sevin
Buffers	Bicarbonate of Soda, Palm Oil, Mineral Oil
Disinfecting	Alcohol, Iodine



PANACUR (FENBENDAZOLE)



AMPROL SOLUTION (CO-RID)



MINERAL OIL

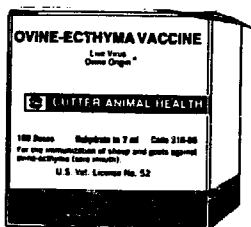

OVINE ECTHYMA VACCINE

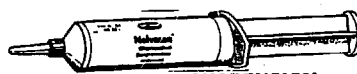

NOLVASAN SUSPENSION

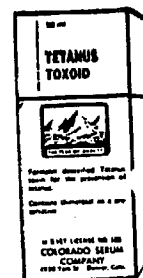

TETANUS TOXOID

TASKS FOR LESSON VII:

- 1) Temperature taking
- 2) Giving Medication by Bolus
- 3) Giving Medication by Drench
- 4) Giving I.M. and SubQ Injections

LESSON VIII - RECORD KEEPING

RECORDS ARE VERY IMPORTANT

THEY TELL YOU ABOUT YOUR GOAT

- what your goat is eating
- about your goat's health
- time of breeding
- the date and number of kids
- accurate record of milk production

EACH GOAT NEEDS HIS OR HER OWN INDIVIDUAL RECORD

KEEP A PAGE IN A NOTEBOOK OR A CARD ON EACH GOAT

Sample records are a part of this lesson. You may want to use these or adapt them to meet your own needs.

KEEP A RECORD OF YOUR GOAT'S VALUE AND SALES YOU MAKE	KEEP A RECORD OF ALL YOUR EXPENSES FOR YOUR GOAT
<ul style="list-style-type: none">- milk and meat for your family- sale of milk or cheese- sale of offspring	<ul style="list-style-type: none">- feed- health care and medications- breeding fees- equipment

THE DIFFERENCE BETWEEN THESE TWO COLUMNS WILL TELL YOU THE VALUE OF YOUR GOAT.

DAIRY GOAT RECORD SHEET

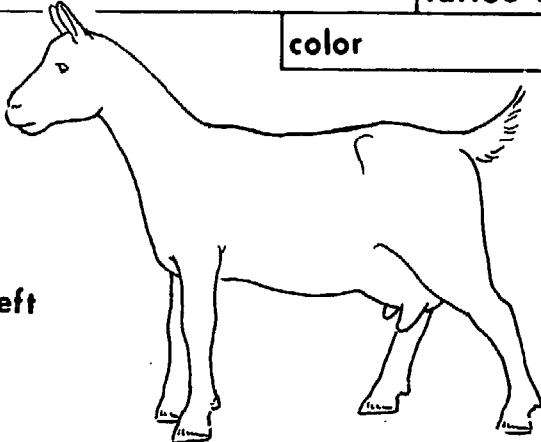
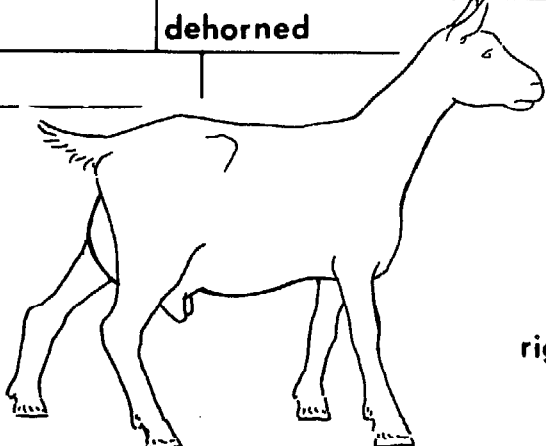
breed	reg. no.	born
name	tattoo no.	dehorned
color		
 left		 right
sire	no.	sire
		no.
dam	no.	dam
		no.
		dam
		no.

LACTATIONS

freshening age	total days	ibs. milk	B. F.	%

ORIGIN

farm reared	purchased from		
date	cost	date died	

INDIVIDUAL DAILY MILK RECORD

Name of Goat _____

Year _____

No. _____

Weigh milk and record in kilos or lbs. If no scale,
measure after straining and record in liters or quarts.

Day	Jan		Feb		Mar		Apr		May		Jun		Jul		Aug		Sep		Oct		Nov		Dec		Total		
	a	p	a	p	a	p	a	p	a	p	a	p	a	p	a	p	a	p	a	p	a	p	a	p			
	m	m	m	m	m	m	m	m	m	m	m	m	m	m	m	m	m	m	m	m	m	m	m	m			
1																											
2																											
3																											
4																											
5																											
6																											
7																											
8																											
9																											
10																											
11																											
12																											
13																											
14																											
15																											
16																											
17																											
18																											
19																											
20																											
21																											
22																											
23																											
24																											
25																											
26																											
27																											
28																											
29																											
30																											
31																											
Total																											



TASKS FOR LESSON VIII:

- 1) Record Daily Milk Production
- 2) Record Herd Milk Production
- 3) List the items your goat will provide which will have value
- 4) List the expenses you anticipate for your goat

LESSON IX - SELECTING AND SLAUGHTERING GOATS FOR MEAT

CULL ANIMALS

- 1) Not suitable for breeding, i.e. animals with genetic defects.
Note: If abnormal conditions are evident, further inspection by a qualified person, such as a veterinarian, would be advisable. Diseased animals should not be slaughtered for consumption.
- 2) Surplus breeding stock
- 3) Unthrifty animals
- 4) Poor producers
- 5) Older animals

HANDLING OF ANIMALS PRIOR TO SLAUGHTER

- 1) Withhold feed of all kinds - both hay and grain - for 24 hours prior to slaughter.
- 2) Do provide plenty of water.
- 3) Place animals in a clean, well-bedded area.
- 4) Do not excite animals prior to slaughter.
Do not pinch hide or beat with a stick because you will bruise the meat and it will spoil more quickly.

SLAUGHTER IN THE COOL OF THE DAY. IF REFRIGERATION IS NOT AVAILABLE, PLAN TO SLAUGHTER ONLY ANIMALS THAT CAN BE EATEN IN 24 HOURS. Otherwise, you may want to preserve meat by salting, drying, etc.

PREPARATION FOR SLAUGHTER

Plan to slaughter in an area with a concrete floor or put legs on your slaughtering cradle to keep the animal's carcass clean.

Make a Hanging Stick

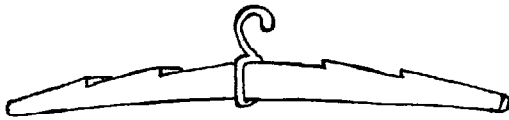

Make a Slaughtering Cradle

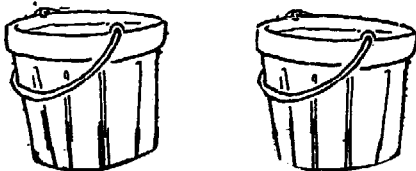
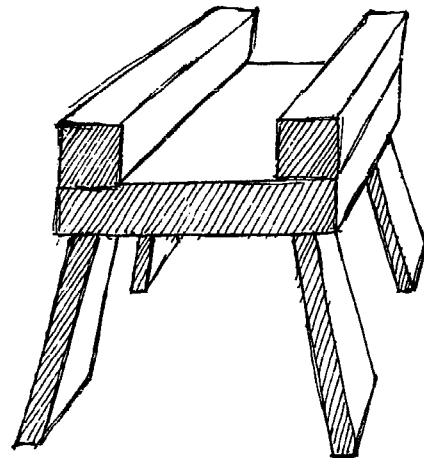

Have plenty of cold water available.

EQUIPMENT

Hammer or Pistol (for stunning, if preferred)

Sharp knife and sharpening stone
Steel for putting edge on the knife

Rack to hang hide on
Meat Saw (if available)

Container for Blood

SLAUGHTERING

- 1) Halter animal. Hold at about 6" distance.
- 2) Draw an imaginary cross between ears and eyes. Where the cross intersects is the place to strike the stunning blow. Use small blunt instrument like a hammer or pistol. Animal will probably not die, only be stunned.
- 3) Put the stick knife in below the ear and at the base of the jaw. Stick through to other side. Cutting edge should be pointed out. Speed is important. Let the blood flow freely. When you are sure animal is through bleeding, pull chin back until you can see neck bones. Sever windpipe, sever head.
- 4) Let animal bleed a couple of minutes until it has quit thrashing.
- 5) Put animal into cradle on its back, head down. Wait until reflexes have stopped.
- 6) Ring each hoof between hoof and declaw with knife. Run point down back of each front leg. On rear legs run knife all the way up leg to rectum. Go just through the skin. As you begin to trim skin away, the dew claw becomes holding point.
- 7) Separate skin from pastern area. Jerk hide down to hock holding onto dew claws.

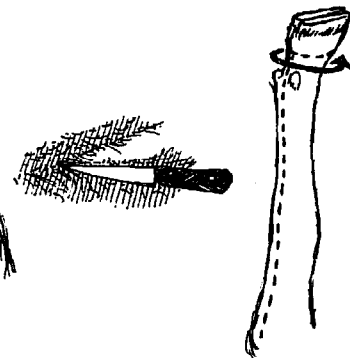
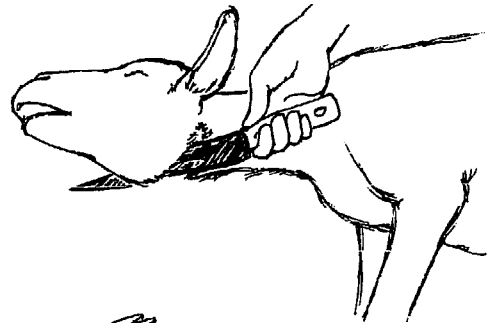
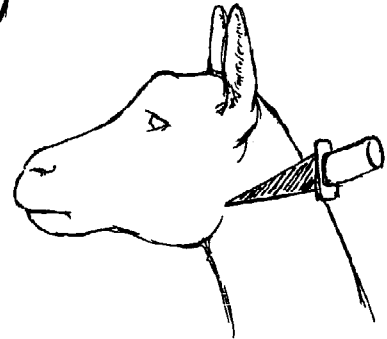
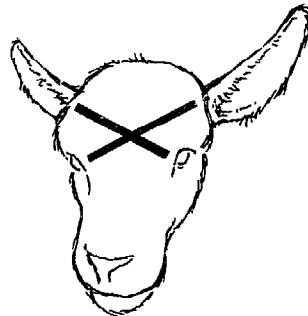

- 8) Now jerk up to crotch. Do both sides.
- 9) Separate tissue from severed line in crotch. Leave scrotal or mammary tissue in hide. Separate flap of skin from rectum to leg.
- 10) Front end. Do same as far as knee. Jerk it to top of arm.
- 11) Draw knife across sternum from armpit to armpit. Go right under skin. Do not cut meat. At the point line crosses brisket, go from there to throat and open.
- 12) Begin working back the skin to the armpits.
- 13) Now you have skinned front end - exposing throat, front portion of each shoulder and at legs.

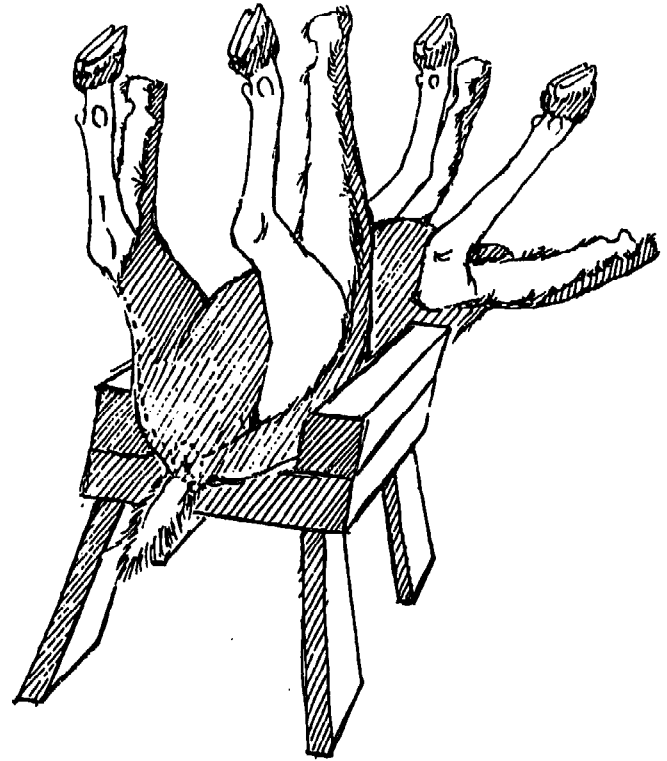

Once you have separated hide off legs at the break joint, sever the foot from the leg. (The break joint is only present in animals under a year of age.) Otherwise, remove foot at ball joint.

- 14) Take knife and open skin from sternum to crotch. In male remove penis.
- 15) Work hide back to each side using fingers. Try to keep thin layer of muscle on the carcass. It is important to keep carcass intact. The entire stomach is now exposed.
- 16) Put in the hanging stick through hock between the achilles tendon and lower section of thigh.
- 17) Suspend hanging stick from tree. Hoist animal off of cradle so it is hanging.

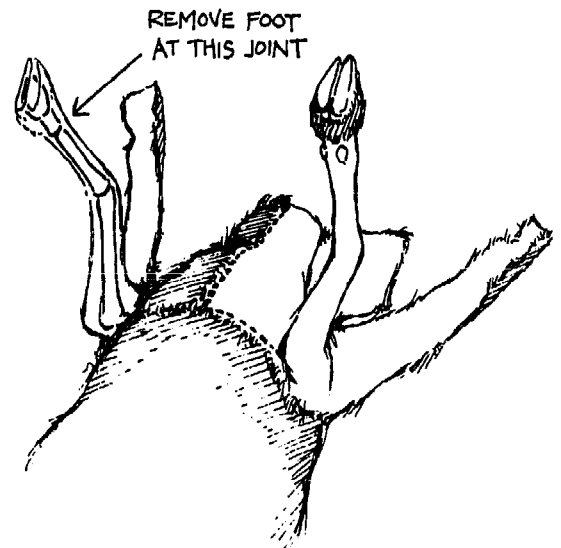

IMPORTANT: RINSE HANDS ANYTIME YOU TOUCH HIDE AND THEN MEAT.

- 18) Cut from throat to sternum, through sternum from middle of belly through throat. Chest cavity is exposed.
- 19) Work with fingertips and knife when necessary, working hide over rump. As you approach tail, grasp tail base and pull skin off.
- 20) At this point strip back with fingernails and knuckles trying to keep all muscle on carcass, going right down backbone. Strip right off. Again, keep subcutaneous muscle attached to carcass and not hide. Pull off. Lay hide on rack.
- 21) Go to front. Wash carcass. Pour bucket of clean water over it.
- 22) Put in knife at crotch - blade side toward you. Put finger behind dull side of knife and push finger and knife down toward navel and eventually to sternum. Guts will fall forward.
- 23) Reach into the crotch and draw the rectum through pelvic arch.
- 23) Ring the rectum with knife. Tie it off. Reach into the crotch and draw the rectum through pelvic arch.
- 24) Pull bladder free and let this go with guts. Leave kidneys in kidney fat at back side of body.
- 25) Approaching thoracic cavity, spleen will be on left hand side. Pull loose - discard. At this point you will see liver on the right. Grab base of gall bladder and strip from liver, leaving liver in body cavity.
- 26) You will see bottom of esophagus. Tie this off. Cut this and guts will fall loose on the ground.

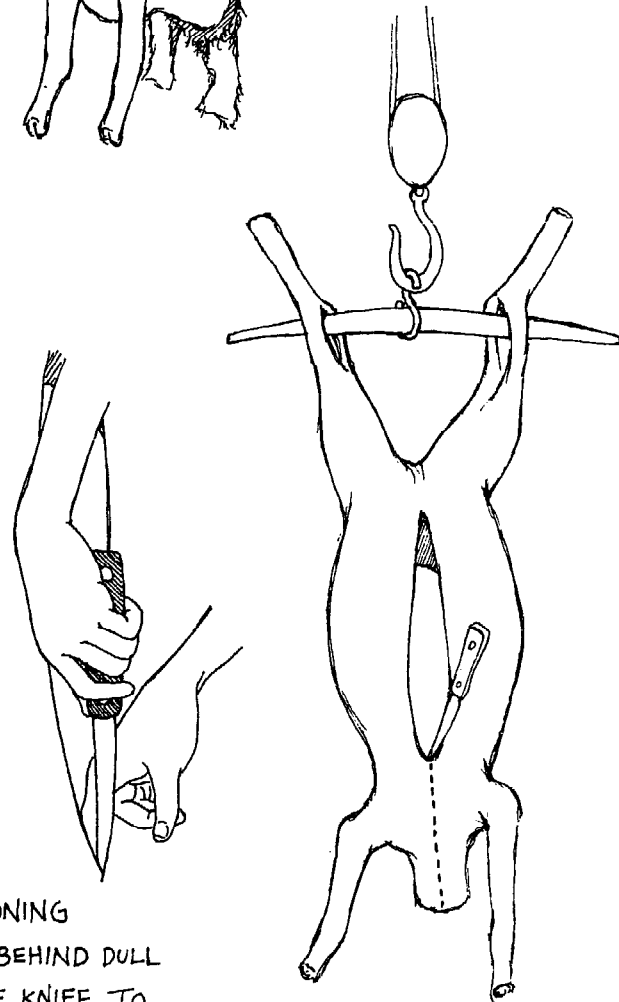
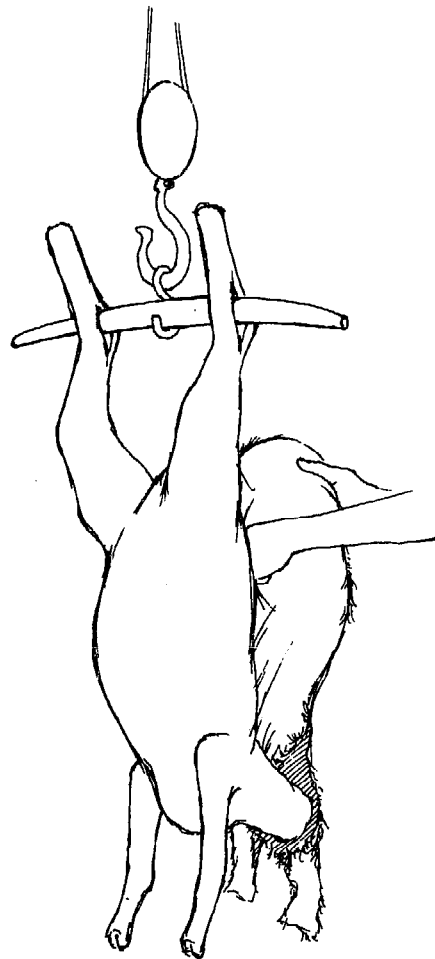

POSITIONING
FINGER BEHIND DULL
EDGE OF KNIFE TO
PROTECT STOMACH
FROM PUNCTURE

27) As you look at kidneys and liver, you will see beneath them a distinct red and white line (diaphragm). This band separates the thoracic cavity from the abdominal cavity. Run knife along muscular strip (red and white line) and cut to sternum on each side. Grasp in center and pull away from muscle supporting liver. Do not take out.

28) Heart, lungs, windpipe and esophagus (pluck) will be in the material you are dragging away. Remove pluck, opening the throat the full length of the chest cavity.

29) Thoroughly wash carcass inside and out.

30) Remove tongue from head and any other parts of head you wish to use, such as brains, etc.

31) Keep the meat in a cool place or throw cold water on it periodically. If you are going to leave hanging for any length of time, wrap in a clean cloth.

32) Cut in desired pieces. Edible by-products would include liver, heart, tongue, kidneys, brains. If you have use for casings, for sausage, the small and large intestines could be salvaged.

33) All inedible visera should be buried or disposed of in a sanitary manner.

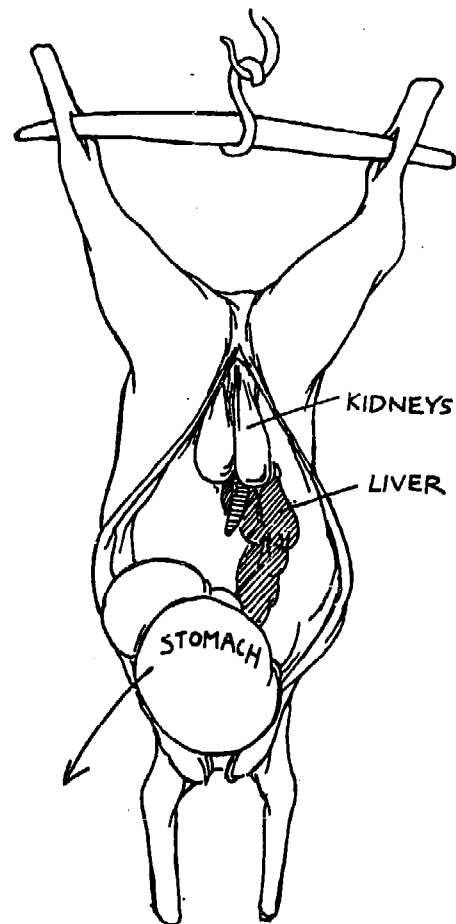

CONVERSION TABLE

1 milliliter (ml) = 1000 microliters
 1 liter (l) = 1000 ml

To convert ounces (oz), pints (pt),
 quarts (qt), and gallons (gal) to milli-
 liters (ml) and liters (l):

To convert liters (l) to ounces (oz), pints
 (pt), quarts (qt) and gallons (gal):

$\frac{1}{4}$ l = 8 $\frac{1}{2}$ oz
 $\frac{1}{2}$ l = 1 pt 1 oz
 1 l = 1 qt 2 oz
 4 l = 1 gal 7 oz
 10 l = 2 $\frac{1}{2}$ gal
 25 l = 6 $\frac{1}{4}$ gal

1 oz = 29.6 ml
 2 oz = 59.2 ml
 3 oz = 88.8 ml
 4 oz = 118.4 ml
 5 oz = 148 ml
 6 oz = 177.5 ml
 7 oz = 207 ml
 8 oz = 236.6 ml
 1 pt = 473.2 ml
 1 qt = 946 ml (or 0.946 l)
 2 qt = 1.893 l
 3 qt = 2.839 l
 4 qt = 3.785 l

50 l = 13 $\frac{1}{2}$ gal
 100 l = 26 $\frac{1}{2}$ gal

Temperature

To convert Centigrade (C)
 to Fahrenheit (F)

C = F			
36	96.8	39.8	103.6
36.5	97.7	40	104
37	98.6	40.2	104.4
37.5	99.5	40.4	104.7
38	100.4	40.6	105.1
38.2	100.8	40.8	105.4
38.4	101.1	41	105.8
38.6	101.5	41.2	106.2
38.8	101.8	41.4	106.5
39	102.2	41.6	106.8
39.2	102.6	41.8	107.1
39.4	102.9	42	107.5
39.6	103.3		

Note: To reduce degrees F to degrees
 C, subtract 32, then multiply by $\frac{5}{9}$. To
 reduce degrees C to degrees F, multi-
 ply by $\frac{9}{5}$ then add 32.

Linear Measure

1 millimeter (mm) = 0.04 inch (in.)
 1 centimeter (cm) = 0.4 in.
 1 decimeter = 4 in.

1 in. = 2.54 cm
 1 foot (ft) = 30.48 cm
 1 yard (yd) = 91.44 cm

10 mm = 1 cm
 100 cm = 1 meter (m)
 1000 m = 1 kilometer (km)

$\frac{1}{8}$ in. = 3 mm
 $\frac{1}{4}$ in. = 6 mm
 $\frac{1}{2}$ in. = 11 mm
 $\frac{3}{4}$ in. = 18 mm
 1 in. = 2.5 cm
 2 in. = 5 cm
 3 in. = 7.5 cm
 4 in. = 10 cm
 5 in. = 12.5 cm
 6 in. = 15 cm
 7 in. = 17.5 cm
 8 in. = 20 cm
 9 in. = 22.5 cm
 10 in. = 25 cm
 11 in. = 27.5 cm
 12 in. = 30 cm

Weights

1 gamma = 1 microgram (mcg)
 1,000 mcg = 1 milligram (mg)
 1,000 mg = 1 gram (gm)
 1,000 gm = 1 kilogram (kg)
 1,000 gm = 1 kg = 2.2 lb

To convert ounces (oz) and pounds (lb)
 to grams (gm) and kilograms (kg):

1 oz = 28.3 gm
 2 oz = 56.7 gm
 3 oz = 85 gm
 4 oz = 113.3 gm
 5 oz = 141.6 gm
 6 oz = 170 gm
 7 oz = 198.3 gm
 8 oz = 226.8 gm

9 oz = 255 gm
 10 oz = 283.5 gm
 11 oz = 311.8 gm
 12 oz = 340 gm
 13 oz = 368.3 gm
 14 oz = 396.6 gm
 15 oz = 425 gm
 16 oz (1 lb) = 453.6 gm
 1 lb = 453.6 gm
 2 lb = 907.2 gm
 3 lb = 1.4 kg
 4 lb = 1.8 kg
 5 lb = 2.3 kg
 10 lb = 4.5 kg
 50 lb = 22.7 kg
 100 lb = 45.4 kg
 1,000 lb = 453.6 kg
 2,000 lb = 907.2 kg

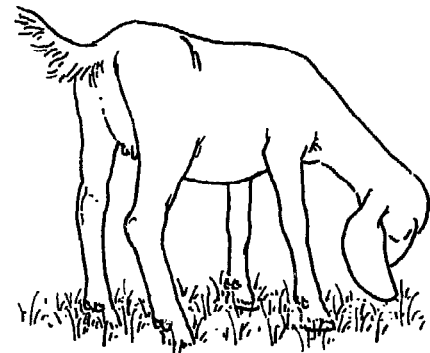

Goat milk weighs approximately 8.5 lb. (1.02 Kg) per gallon (L) at room
 temperature.

The weight will vary as it depends on the specific gravity of the milk. The
 higher the fat content of the milk, the lower is the specific gravity, thus the
 lower the weight per gallon of milk.

Milk freezes at approximately 30°F (-1°C)

QUICK REFERENCE CONVERSION

Inches	1	2	3	4	5	6	7	8	9	10
Centimeters	2.54	5.08	7.62	10.16	12.70	15.24	17.78	20.32	22.86	25.40
Centimeters	1	2	3	4	5	6	7	8	9	10
Inches	.39	.79	1.18	1.57	1.97	2.36	2.76	3.15	3.54	3.93
Pounds	1	2	3	4	5	6	7	8	9	10
Kilograms	.45	.91	1.36	1.81	2.27	2.72	3.18	3.63	4.06	4.53
Kilograms	1	2	3	4	5	6	7	8	9	10
Pounds	2.20	4.41	6.61	8.82	11.02	13.23	15.43	17.64	19.84	22.02

UNITS OF CAPACITY LIQUID MEASURE

Units	Fluid Ounces	Liquid Pints	Liquid Quarts	Gallons	Milliliters	Liters
1 fluid ounce =	1	0.062	0.031	0.007	29.573	0.029
1 liquid pint =	16	1	0.5	0.125	473.176	0.473
1 liquid quart =	32	2	1	0.25	946.352	0.946
1 gallon =	128	8	4	1	3,785.306	3.785
1 cubic inch =	0.554	0.034	0.017	0.004	16.387	0.016
1 cubic foot =	957.506	59.844	29.922	7.480	28,316.846	28.316
1 milliliter =	0.033	0.002	0.001	0.000	1	0.001
1 liter =	33.814	2.113	1.056	0.264	1,000	1

UNITS OF CAPACITY DRY MEASURE

Units	Dry Pints	Dry Quarts	Pecks	Bushels	Liters	Dekaliters
1 dry pint =	1	0.5	0.062	0.015	.550	.055
1 dry quart =	2	1	0.125	0.031	1.101	.110
1 peck =	16	8	1	0.25	8.809	.880
1 bushel =	64	32	4	1	35.239	3.523
1 cubic inch =	0.029	0.014	0.001	0.000	0.016	0.001
1 cubic foot =	51.428	25.714	3.214	0.803	28.316	2.831
1 liter =	1.816	0.908	0.113	0.028	1	0.1
1 dekaliter =	18.161	9.080	1.135	0.283	10	1



REFERENCES

Asian Livestock. March, 1983.

Belanger, J., Raising Milk Goats the Modern Way. Garden Way Publishing Co., Charlotte, Vermont, 1975.

Campbell, L., Ed., The Whole Goat Catalog. Gerard Publishing Co., Louisa, Virginia, 1981.

Caprine Supply, 1982 Catalog, Shawnee, Kansas.

Cochran, D. E., Common Diseases of Dairy Goats, 1980.

Colby, B., et al, Dairy Goats: Breeding Feeding and Management. American Dairy Goat Association, Spindale, North Carolina, 1972.

Cunha, T. J., The Animal Industries Are Here to Stay. Food and Nutrition News, National Livestock and Meat Board, Vol. 49, 1978.

Devendra, C., Burns, M., Goat Production in the Tropics. Commonwealth Agricultural Bureaux, Bucks, England, 1970.

Dunn, Peter, The Goatkeepers Veterinary Book. Farming Press Limited, Suffolk, England, 1982.

Ferguson, Elizabeth, Milk Goats for Nevis Handbook, Green Heron Press, Harpers Ferry, West Virginia, 1980.

Gall, C., Ed. Goat Production, Academic Press, New York, 1981.

Guss, S., Management and Diseases of Dairy Goats. Dairy Goat Journal Publishing Co., Scottsdale, Arizona, 1977.

Henderson, A. J., Sheep and Goat Breeding, FAO, Rome, Italy, 1977.

Leach, C., Aids to Goatkeeping. Dairy Goat Journal Publishing Co., Scottsdale, Arizona, 9th Ed., 1982.

Loosli, J. K., The Role of Goats in Meeting World Food Supplies, Proceedings, Florida Dairy Goat Production Conference, Gainesville, Florida, 1979.

MacKenzie, David, Goat Husbandry, Faber & Faber (London, England) Winchester, Massachusetts, 1980.

Nelson-Henrich, S., The Complete Book of Yogurt. Macmillan Publishing, New York, 1980.

New England Cheesemaking Supply, Ashfield, Massachusetts, 1982.

Owen, N., The Illustrated Standard of the Dairy Goat. Dairy Goat Journal Publishing, Scottsdale, Arizona, 1977.

Sands, M., McDowell, R., The Potential of the Goat for Milk Production in the Tropics. Department of Animal Science, New York State College of Agriculture, Cornell University, Ithaca, New York, 1978.

Smith, M., Goats: Management and Diseases. New York State College of Veterinary Medicine, Ithaca, New York, 1980.

Stanton, t., Papers on Goat Management and Health, 1982.

Stoddard, G., Nutrition and Feeding of Dairy Goats. Western Regional Extension Publication No. 14, April, 1979.

Williamson, G., Payne, W., An introduction to Animal Husbandry in the Tropics. Longman, New York, 1978.

Dairy Goat Guide, Countryside Publications, Waterloo, Wisconsin
March, 1982, November, 1981, June, 1981.

Nutrient Requirements of Goats, National Academy Press, Washington, D. C., 1981.

Proceedings of the Third International Conference on Goat Production and Disease, January, 1981. Dairy Goat Journal Publishing Co., Scottsdale, Arizona.

Goat Health Handbook, Winrock International Livestock Research and Training Center, Morrilton, Arkansas, 1983.

The Animal Health Competencies Resource Book, Cooperative Extension Service, Pennsylvania State University, University Park, Pennsylvania, 1981.

I wish to acknowledge the encouragement and contributions of the following individuals to the development of this manual.

Dr. James DeVries, African Program Director, HPI, Little Rock, Arkansas

Dr. Gordon Hatcher, DVM, Little Rock, Arkansas

Joseph Howell, HPI Field Staff, Cameroon, Africa

The Rev. George Jaques, Marstons Mills, Massachusetts

Dr. Wallace Roby, Ashford, Connecticut

William H. Rose, III, Chaplin, Connecticut

Joseph Silveira, Jr., South Dartmouth, Massachusetts

Nancy Silveira, South Dartmouth, Massachusetts

tatiana Stanton, International Dairy Goat Research Center, Prairie View, Texas

Dr. Emmanuel Tebong, Director, Institute of Animal Research, Cameroon, Africa

Ron Tempest, Hatboro, Pennsylvania

Dr. Gerald Williams, HPI Chief of Party, Cameroon, Africa

Appendix

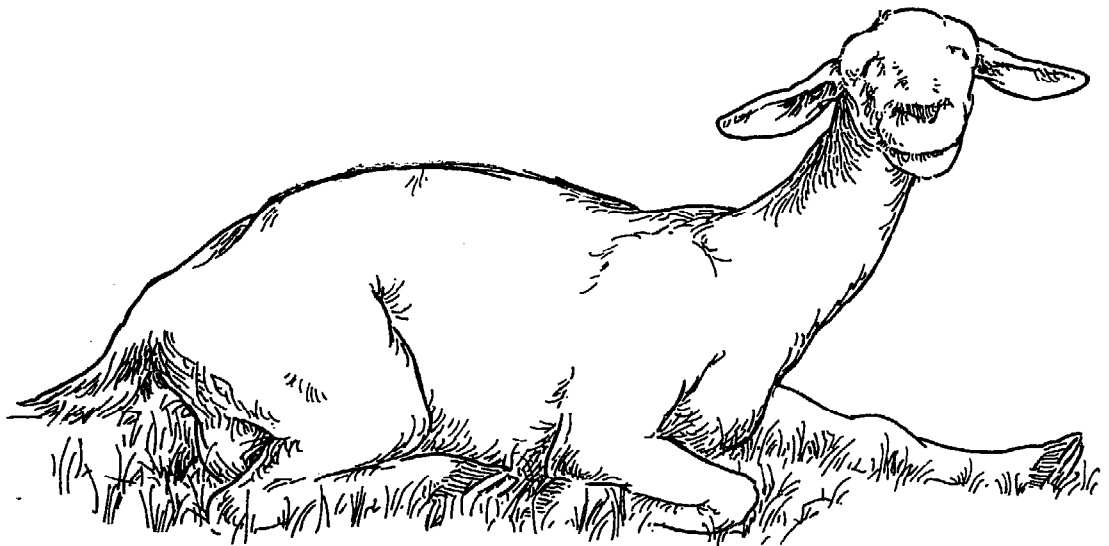

OBSERVATION SHEET

Name of goat to be observed _____

Tag Number (if any) _____ Tattoo _____ Sex _____

Breed _____ Age _____

If Female: Bred _____ Open _____ Date Due to Kid _____

If Male: Check testicles to be sure both are descended. Check general condition of reproductive organs.

Current Feeding Schedule _____

Weight _____ Compare with projected weights on Page 19 of Manual.

Treated for parasites _____ When _____ Medication _____

Each day observe the following and record:

- 1) General Appearance
- 2) Activity Level
- 3) Legs and Hooves
- 4) Any external problems such as abscesses, parasites, etc.
- 5) Condition of eyes, nose, mouth
- 6) Condition of feces (droppings) - pellet-like, ploppy, loose, diarrhea
- 7) Milk Production - if lactating _____ kilos per day
_____ liters per day

Any signs of mastitis

8) Eating habits

9) Check any of the following signs of illness:

_____ off feed

_____ dehydration

_____ limping

_____ blindness

_____ diarrhea

_____ runny eyes

_____ circling movements

_____ clots or bloody milk

_____ standing off from group

_____ abnormal temperature

_____ pale mucosa around eyes and in mouth

_____ heavy mucous in nose or mouth

_____ no sign of cud chewing

_____ swelling at any point in body

_____ hair falling out or rough in appearance

OBSERVATION SHEET

Name of goat to be observed _____

Tag Number (if any) _____ Tattoo _____ Sex _____

Breed _____ Age _____

If Female: Bred _____ Open _____ Date Due to Kid _____

If Male: Check testicles to be sure both are descended. Check general condition of reproductive organs.

Current Feeding Schedule _____

Weight _____ Compare with projected weights on Page 19 of Manual.

Treated for parasites _____ When _____ Medication _____

Each day observe the following and record:

- 1) General Appearance
- 2) Activity Level
- 3) Legs and Hooves
- 4) Any external problems such as abscesses, parasites, etc.
- 5) Condition of eyes, nose, mouth
- 6) Condition of feces (droppings) - pellet-like, ploppy, loose, diarrhea
- 7) Milk Production - if lactating _____ kilos per day
_____ liters per day

Any signs of mastitis

- 8) Eating habits
- 9) Check any of the following signs of illness:

- | | |
|----------------------------|-----------------------------------------------|
| _____ off feed | _____ standing off from group |
| _____ dehydration | _____ abnormal temperature |
| _____ limping | _____ pale mucosa around eyes and in mouth |
| _____ blindness | _____ heavy mucous in nose or mouth |
| _____ diarrhea | _____ no sign of cud chewing |
| _____ runny eyes | _____ swelling at any point in body |
| _____ circling movements | _____ hair falling out or rough in appearance |
| _____ clots or bloody milk | |

HEIFER PROJECT INTERNATIONAL is a non-profit organization. It is registered with the United States Department of State, and is a member of the American Council of Voluntary Agencies for Foreign Service. It also belongs to the International Council of Voluntary Agencies.

Founded in 1944, Heifer Project has since provided assistance to people in more than 100 countries.

The purpose of Heifer Project International is to assist small farmers achieve a better living through more efficient use of human and natural resources.

The method is to introduce genetic improvement in livestock and to demonstrate and teach proper management.

Distribution of Heifer Project livestock is made without regard to race, creed or political origin, and in a manner which requires the recipient to share the increase.

Projects are designed so as to be self-supporting and perpetuating. To accomplish this, plans and agreements are made with indigenous organizations.

The program of Heifer Project International is supported by voluntary contributions from thousands of individuals, churches, youth groups, businessmen, farmers and others who believe in the aims and objectives of Heifer Project.

INTERNATIONAL HEADQUARTERS
P. O. Box 808, Little Rock, Ar 72203

INTERNATIONAL LIVESTOCK CENTER
Route 2, Perryville, Ar 72126

NORTHEAST REGIONAL OFFICE
Overlook Farm, Wachusett Street, Rutland, Ma 01543

MIDWEST REGIONAL OFFICE
P. O. Box 767, Boshen, In 46526

MID-ATLANTIC REGIONAL OFFICE
P. O. Box 188, New Windsor, Md 21776

PACIFIC WEST REGIONAL OFFICE
P. O. Box 126, Ceres, Ca 95307

SOUTHWEST REGIONAL OFFICE
P. O. Box 1968, Whittier, Ca 90609