

CHAPTER 11

BASEMENT HOME FALLOUT SHELTER

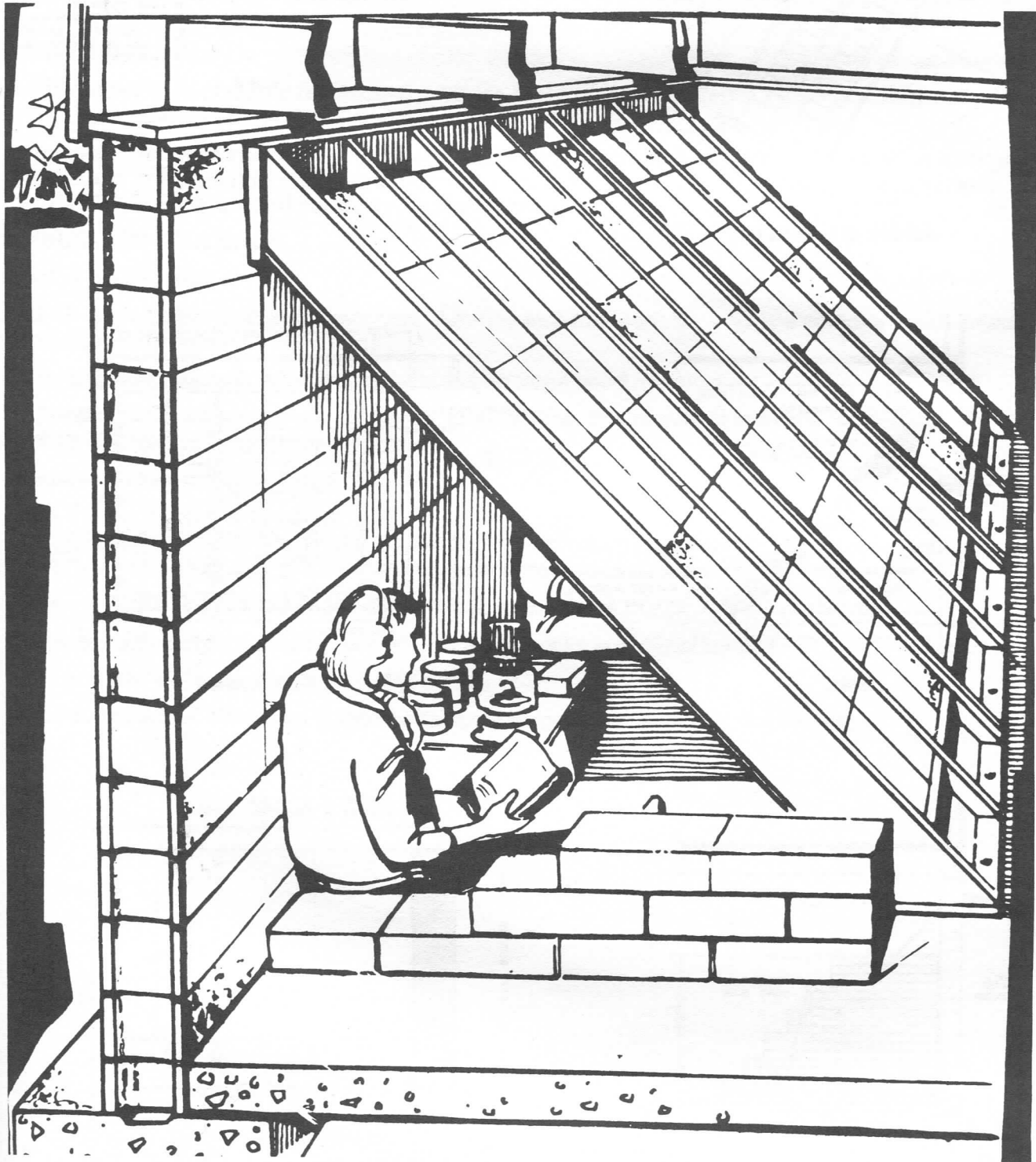

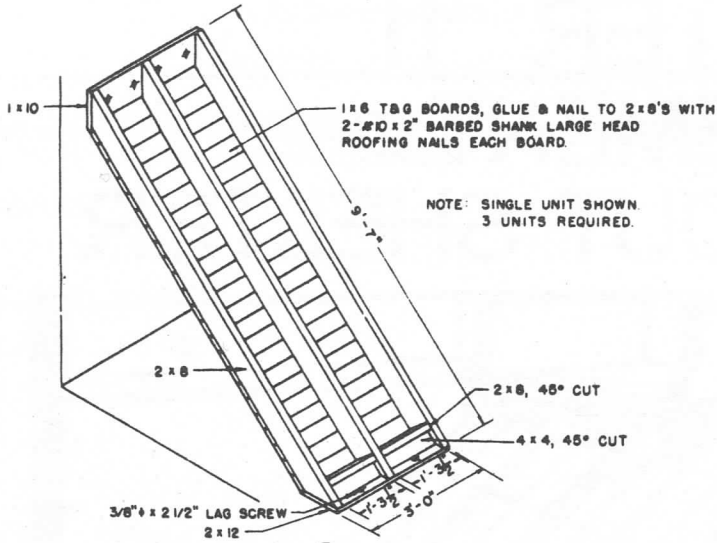

Isometric of Lean-To Unit

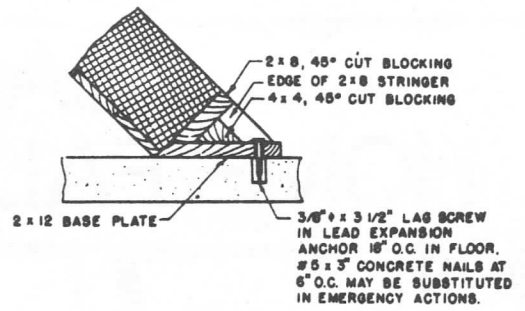

Detail

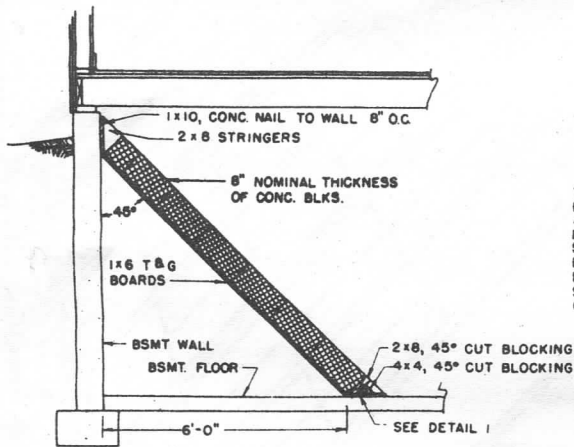

Section A

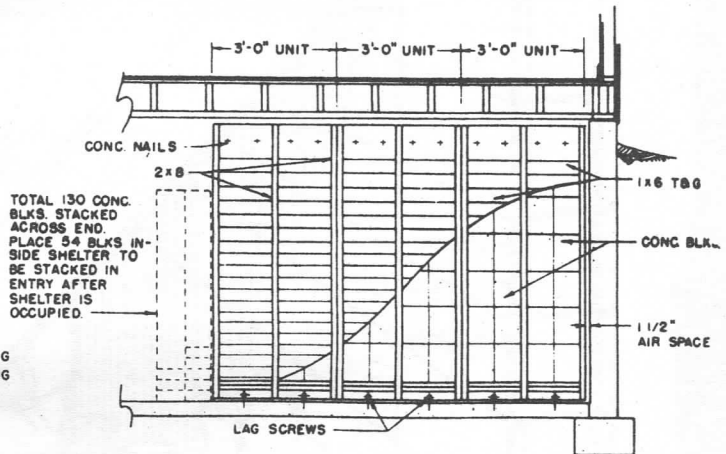

Front Elevation

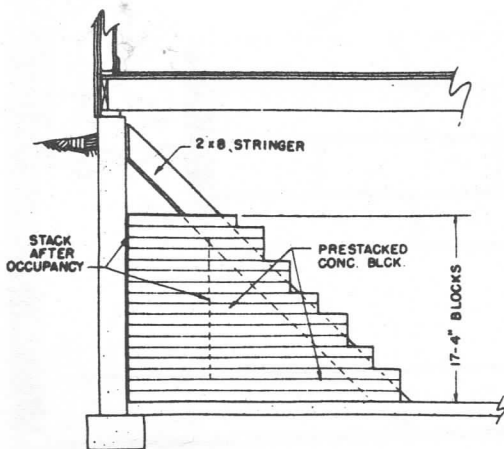

End Elevation

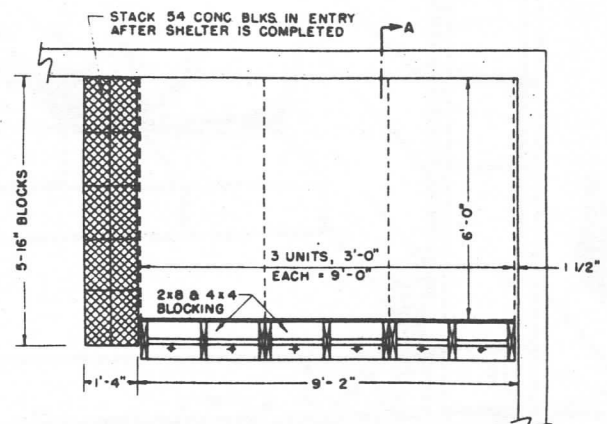

Plan

GENERAL INFORMATION

This shelter is designed to provide protection from the effects of radioactive fallout in the below grade basement of an existing house. Its advantages are low cost, simplicity of construction, general availability of material, and the fact that it may be easily disassembled.

TECHNICAL SUMMARY

This shelter design will provide 54 sq feet of area and approximately 216 cubic feet of space. It will house three persons. The shelter length can be increased by increments of 3 foot panels. The height may be increased by the use of more materials. This increase will be limited by basement height and handling of the panels.

The materials necessary to construct this shelter should be available from retail lumber yards.

Natural ventilation is obtained by omitting 3 blocks for the top of the entrance way closure and by leaving a 1 - 1 / 2" in. gap between the end of the shelter and the basement wall.

Construction time should not exceed 20 man hours when all the materials are on hand at the shelter location. It is desirable to pre-assemble the lean to units and store them in a corner. They can then be installed in the best corner of the basement and stacked with blocks in 1 hour.

CONSTRUCTION SEQUENCE

1. Prepare shelter units.
 - a. Cut 45 degree bevels on 2 X 8 stringers. Arrange in 3 foot panels using 16d common nails, attach bottom boards and blocking on the beveled ends first.
 - b. Fit in, glue and nail remaining bottom boards with large head roofing nails.
 - c. Units can be stored assembled, if desired, to save time. It is desirable to locate lag screw holes and install lead shields in floor and basement wall.
2. Assemble shelter (emergency actions)
 - a. Turn this panel right side up and place it in its permanent position. Fasten the panel to the floor with lag screws in lead shields leaving a 1 - 2 / 2" gap between the end of the shelter and the basement wall. If lead shields have not been installed ahead of time, use concrete nails as shown in the detail.
 - b. Fasten in sequence as many panels as are to be used. Nail to wall with concrete nails.
 - c. Fill panels with 2 layers of solid concrete blocks or bricks starting at bottom.
 - d. Build end wall of 76 stacked blocks, 456 bricks.
 - e. Place 50 blocks or 300 bricks in the shelter for emergency closure of entrance way.

LIST OF MATERIALS

MASONRY

4" X 8" X 16" solid concrete masonry units or	290 Blocks or
2 - 1 / 4" X 4" X 8" solid bricks	1740 Bricks

LUMBER

(construction or No 1 grades or better)	
Stringers 2 X 8 X 9' - 7" (45 degree diag. cut at both ends)	9 pieces
Boards 1 X 6 X 3' - 0" T & G (square edge may be used)	69 pieces
1 X 10 X 3' - 0"	1 pieces
2 X 10 X 3' - 0"	1 pieces
Blocking 2 X 8 X 1' - 3 - 1 / 2" stress grade lumber	6 pieces
4 X 4 X 1" - 3 - 1 / 2" (rip lengthwise at 45 degrees to provide the 6 pieces required)	3 pieces

HARDWARE

3 / 8" diam. X 2 - 1 / 4" lag screws and washers	12
3 / 8" bolt size lead expansion shield, 9 / 16" X 2" hole	12
#10 ga. X 2" barbed shank, large head roofing nails	3 pounds
16d common nails	1 pounds
Glue, protein emulsion (must develop 450 lbs. sq. in.)	1 - 1 / 2 pint
#5 X 3" concrete nails	36

SPECIAL TOOLS;

9 / 16" star drill to install anchor bolts into concrete basement floor and walls.

DON'T FORGET: Planning ahead saves money

TOP COVER Use some kind of disguise to eliminate your shelters being detected, whatever you do, don't use any plant that produces food, no sense in having every kid in the neighborhood picking berries right on top of your secret shelter. I don't recommend them but there are poisonous plants that will irritate or can even kill an intruder, plants like stinging nettles, poison ivy, oak, sumac, and ragwort, are skin irritants producing a delayed reaction before rash develops. Plants that may produce death with skin contact of the mature leaves, stem or sap, Giant Hogweed (*Hercleum Mantegzianum*) Sun Spurge (*Euphorbia Helioscopia*) are extremely toxic plants, even with the most casual contact. Thorn plants are a immediate deterrent and require little cultivation on your part once they have established themselves. If you chose foliage that is thorny, pick a plant that will remain throughout the year, like a woody stemmed plant. Remember anything you can do to reduce access to the area of your shelter will increase your chances of keeping your Survival shelter a secret.

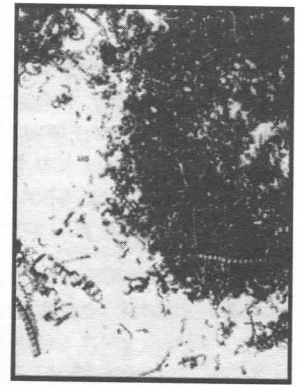

Don't forget to lace the area around your shelter with metal chips

AIR I recommend you construct a reliable air filtration system or buy one already constructed. No open air pipes, all piping must have valves to seal off your shelter. This is the most important life support system you have. Look at it this way, skimp now and whatever your enemy could dream up to use against you will work. Many Natural disasters will dictate a complete valve closure to eliminate any chance of toxic particles or gases from fires Etc. If chemical, Nuclear, bio pollutants are present, you and your family will suffer the consequence without sealing valves. Subscribe to *Mother Earth News*, it tells you how to live off the land, build the most amazing stuff like "AIR SCRUBBERS" for Survival Shelters, it's all about giving up on our pesticide polluted, industrialized, paper money world and becoming totally self sufficient.

WATER. Drilling for water is expensive and risky. Your shelter's location will be exposed to everyone by the huge trucks and the 50 foot high drilling tower, not to mention the ground shaking noise that can be heard for miles! Plus the fact that it will require a pump to get the water out of the ground in any quantity, remember you'll be using an old fashioned manual pump or a recreational camper battery powered pump. So build in a suitable location with spring feed drinking water near by if at all possible. If you think you will need 'just a little water' you say a five gallon jug or two will last you a week or so, I can assure you it's more like 5 gallons per person per day minimum, the more the better. You need a large quantities of good water to keep your family living a life-style that they can be comfortable with. Plan on taping into your present well or drilling or digging a new one. It is best if the well head is inside your shelter just in case there's trouble, you won't have to expose yourself outside to make the repairs. Never drink surface water after any type of major disaster, it's contaminated I guarantee it!

FOOD Something I do enjoy more and more as I get up in years. When I was young I could eat the most awful stuff while in the woods and enjoy it, but now that I'm 40 it seems far more important to enjoy a fine meal than to just sustain my daily existence. Call me a pig or not but good food and spices are on the top of my list of supplies. I can't tell you what to store away and in what quantities because you probably don't like what I like. I'll give you one suggestion, get as many MRE's as you can, you know the MEALS READY TO EAT the military issues to soldiers in the field. This is the most nutritious and highest energy food you will find for the cost and size, MRE's have an extremely long shelf life, for most packets it's 10 years. I love them, I take one every time I go into the woods. I have one in every vehicle I own just in case of emergency. They contain a full days supply of what ever it takes to keep you alive, even matches and toilet paper are included, just add hot water for the coffee pack or have the drink mix (KOOL-AID) even hot chocolate! I buy them by the case lot from suppliers like Pondersoa Products Box 1016 Eagle, ID. 83616 phone 208-939-1513 Remember to ask for the Manufacture Date it is important to get fresh MRE's Don't be confused by the Inspection Date, the Manufacture Date is your pricing guide, cheaper usually means your getting old or out of date MRE's. I once bought a case for 20 dollars at a gun show only to discover they were all bad, years past there expiration date, great deal right?

SEEDS Buy them now while they are plentifully and cheap, they will be in high demand after any large scale disaster. In fact history has shown that entire cultures have died off because hard times forced the people to eat next years seed stock. Again I can't recommend any particular variety because of the varied climates in which they will grow best.

INSANITY ✓ Here is a fun subject and something I know a lot about. Plan ahead for the worst case of cabin fever you can possibly imagine! It helps to read educational psychology books. Reading will occupy vast amounts of time and will help keep your family intact with fun stories, like families used to do before radio and TV. If you have children it will be your daily job to be their teacher, so prepare your children's educational library in advance. Books are very important but you should round things out with board games, cards, what ever you like, knitting, writing, Hey there is a good idea, write you entire life's story and don't leave one second out.

TIME ✓ Consider turning around your clock so you are awake during night hours and asleep during daylight hours? It makes perfect sense, you're in a cement box in the ground anyway. While your up cooking listening to the radio and going about your daily duties everyone else is sleeping. If you need to hunt for meat or perform a reconnaissance mission you would do it at night right. Why not let the night be your day, you would be rested and in full function at a time when your outside activities would be hardest to detect. Soon you would be quite adept to night life. Your shelter is really only designed to support a very limited number of people for a short time. Without water and sewer installation you will soon be forced to venture outside for supplies.

HEAT DETECTION ✓ Here is a trouble spot, they can fly over and perform spectra analysis in the infra red range to detect even a 2 degree temperature rise in air, land and sea. You should consider insulating you shelter using dense cell foam at least 2" thick and sealed between sheets using GE Silicone sealer. You will have a little harder time heating in the winter if the frost line drops below your roof slab, but it will be quite comfortable for you in the summer. The ground freezes 4 feet deep where I live and it's no problem at all. Electric heaters are out because they use to much electricity for you to make easily. I suggest a propane Recreational vehicle heater, they are extremely efficient with gas and electric because they are designed to use very small tanks of propane and run on batteries for days between charge up, they are thermostatically controlled so it will be just like home! If you are serious about making a live-able home you should try recreational vehicle dealers for your electric converters and inverters, water pumps, sinks, showers, etc.

SEWER ✓ Your shelter will need to have a toilet and some kind of bathing unit, once again the ones in my Winnebago are the best available for limited spaces and could be hooked up to a very small septic system (one 50 gallon main enzyme tank and 3 top feeder lines 4" dia 10' long) at least 2 feet below the floor line of your shelter. The installation of these life support devices goes beyond the scope of a shelter of this size, in an emergency it could be used with exceptional comfort, skillful pre-planning can make or break you survival experience. Let me give you an excuse to take a nice vacation! If you have never stayed a week end in a newer travel trailer or Winnebago you should do so for the experience in living in close quarters with your family. I assure you it is worth the experience, plus you'll get a good look at the miniaturized appliances that work so well on so little energy.

IT'S A SECRET ✓ Take this simple oath; I swear, never tell anyone about my shelter and will lie if necessary to keep from revealing the very existence of my Survival Shelter. I will never tell, it doesn't exist, I promise to tell no one, never, never, never, I will never tell.

Right: This survivalist is showing off his entrance which is very deceptive. The pit in his garage was transformed into a very livable "Hard Shelter" Pre-planing the job of cementing his garage floor to also provide a roof for his shelter. He utilized structural steel reinforcement in the cement floor which provides ample support for the shelters 12" thick roof. Although the walls and floor are of dirt, this shelter does have water and a crude waste disposal system, lights and basic furnishings.

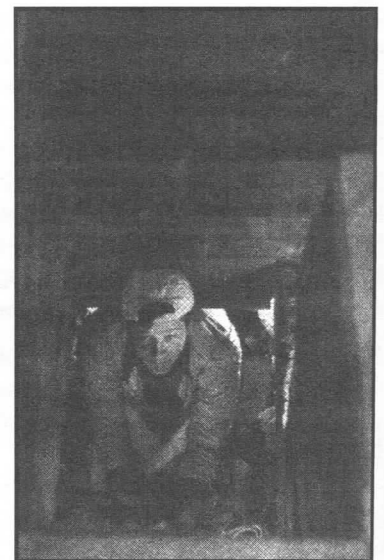

ANIMAL DETECTION

Dogs are a serious threat if hostile military or police units are employed in your area. Dogs have proven very useful, they are believed to use their keen sense of smell to detect a persons scent not the scent of the equipment. This means the dogs ability to home in on your locations will be hampered by wind and weather conditions. A general rule: if the scent is more than 2 days old a police attack dogs cannot maintain scent contact. On the other hand if real tracking dogs (hounds) are employed up to a week can pass and their ultra keen senses may still track you down! The dogs natural use of his other senses like visual detection, humans see moment, dogs are believed to see and recognize outlines and shades variations, or hearing, dogs can actually hear the vibration of trip wires in the wind at one hundred yards! Even the hair on his muzzle, forelegs and chest are very sensitive to the lightest touch.



RIGHT: The transmitter around the dogs neck is a radio tracker, allowing remote monitoring of his movements. If the dog makes a discovery it will remain in the area so troops can be alerted and dispatched. You know what to do

ELECTRONIC DETECTION

Portable electronic detectors used to locate buried metallic and non metallic materials are now commonly issued to military troops and police. Metallic detectors will reveal objects up to a maximum of 4 feet deep. Nonmetallic detectors can detect a change in the density of soil or materials under the ground up to 6 feet deep. Both types have limitations, they are exceptionally reliable in locating near surface objects (1 foot or less) but it takes an experienced operator to estimate the depth by the "ECHO". All metal detectors will react to any kind of buried metal like a nail or a tin can as well as a steel reinforced underground structure. A non magnetic ground density detector will give false signals when passing over tree roots or air pocket in the earth. If your shelter is near your home like in the back yard it will probably be passed off as a septic tank and no further investigation will be instituted. This would mean the total disguise of air pipes, entrances and escape tunnels so that it is not apparent there is a below ground structure.



LEFT: Hand held magnetic detector require slow smooth patterned moovementT of the operator.

RIGHT:: Hand held Non magnetic detector will give general ground density readings. Used primarily for detection of near surface plastic mines

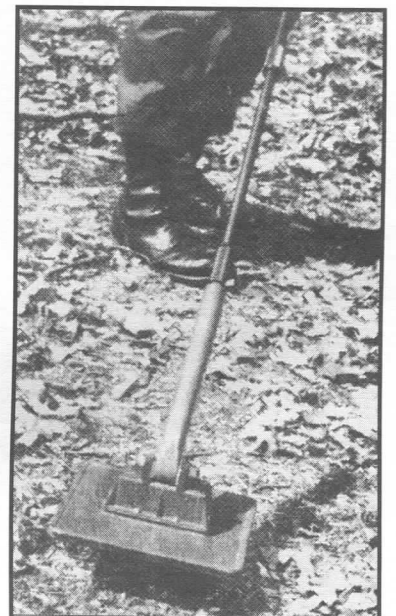

CHAPTER 12

BURIAL COFFINS

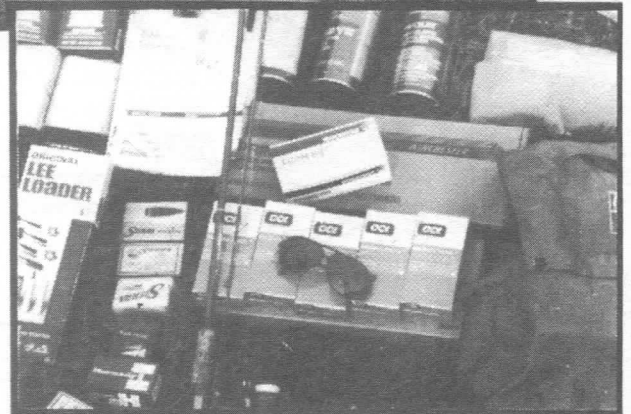
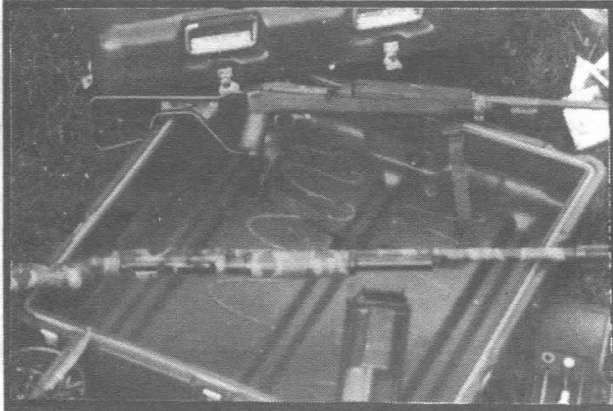

Recent history

The Vietnamese people suffered the historic TET offensive beginning January 29, 1968 and it lasted an incredible 60 days. The Vietnamese peoples use of deadly harassment tactics that many veterans say began the end of the "Vietnamese Policing Action" for America. The preparation and timing leading up to the 1968 Tet offensive is considered even today as a paramount disaster in the American Vietnamese conflict. Why is this 30 year old war relevant to this manual? The entire world felt the America Military should not be in Vietnam and began to support the "freedom revolution" with huge sums of money, political allies in the UN, and armaments, food and supplies of all kinds! During the late 1960's and early 1970's the entire world was secretly trying to sell or give arms to North Vietnam and that arsenal included many weapons systems not seen by American troops before. Light weight "Tube Artillery", Large rockets, Large Mortars, Tanks and Armored Carriers, up to date Modern small arms (AK-47 Type), anti-aircraft artillery, Heavy machine guns and explosives of every type! What did the North Vietnamese do with an estimated 10 million metric tons of foreign military supplies? They buried much of the small munitions, guns and supplies in the South Vietnamese grave yards! Right under the noses of the American intelligence system, an absolute and total surprise to the American military forces. Think about it, no one likes to visit a grave yard, let alone the fact that you are going to be digging up coffins. Why would anyone put a grave yard under surveillance, everybody's dead? The brilliant planning the Vietnamese people used in the Tet offensive was also the perfect tactic to use against our American culture. Americans are taught from early childhood to fear death, that a grave yard is full of ghosts and spirits, a place to avoid at night. The lessons Americans painfully learned in Vietnam can be used here in America to preserve your life saving food, medicine, weapons and supplies. As reported in Quan Doi Nhan Dan (People's Army Newspaper) Vo Nguyen Giap (Minister of National Defense) said in a speech in front of a hospital bombed out by American jets, "Let the innocent dead Vietnamese patriots rise up to take final revenge"

I have included some very high tech burial tubes and some common substitutes that will provide a generation or more of safe storage so those of you who are now pipe dreaming about your survival shelter can get ready right now to keep your survival goods safe. I will suggest that you buy your tube from a reputable company like NIC or BEREIT, but you could substitute another "vault" as a possible alternative.

Right: It was common for people to bury their money after the banking collapse in the 1920's. Many farmers who had lost everything buried milk containers filled with their life savings, guns and other goods (Remember gun control started with the 1934 Machinegun Tax).



Top: A no frills shelter which is uncompleted. This survivalist has found lots of rocks, some as large as a foot locker! He swears he will see it to completion, he lives right in the middle of a large north eastern city.

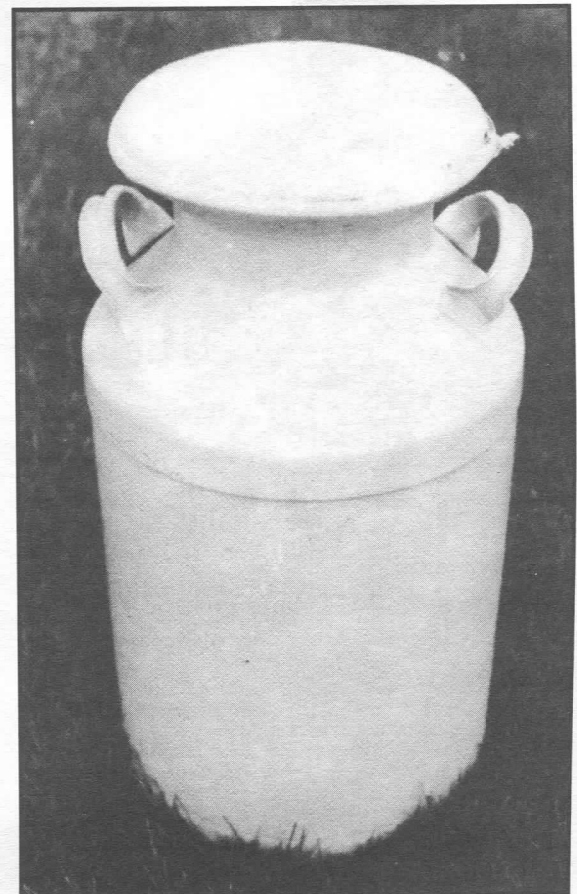



When I first began collecting information on Burial Tubes, I was set back by the "people" selling tubes who didn't advertise their telephone number? The majority didn't even reply to my letters or calls requesting info? There were no delay's at NIC, I called the company's president, detailing my intentions to revise my Shelter manual, well, Alan bent over backwards to get me photos, a sample tube and instructions. In fact the tube arrived in an unbelievable 4 days! NIC's tube utilize a reusable slip fit on end cap that is a super thick, 1/4 inch thick wall tube, 5/16 inch thick wall end caps. This super strong design will allow you to inspect or add to your goods from time to time and easily reseal with silicone. It's biggest advantage is it's large diameter which will easily accommodate 4 AR15's or M16's, 2 AK47's and 2300 rounds of ammo, with plenty of extra room to fit hand guns, money, reloading equipment, radios, night vision, lasers, electronic and optical equipment or anything else you need to safeguard! It is visibly larger and much stronger than the tubes sold by all other suppliers. (most of the other suppliers tubes require that you disassemble many rifles with hand grips or scopes and night vision to fit into the smaller 8" or 6" tube) You clearly get what you pay for with NIC, I guess it all boils down to how much are your possessions worth? and what would your expression be if you dug up your tube 20 years later only to find RUSTY JUNK. Play it totally safe with your irreplaceable survival supplies. NIC's GROUNDHOG VAULT is 58 inches long and 10 inches in diameter! Selling for only \$94.95 plus \$15.00 Shipping & Handling -- Alaska and Hawaii please call for current Shipping charges and deliver times.

NIC, INC.

PO Box 5950 Shreveport, LA 71135

Phone: 318- 688- -1365

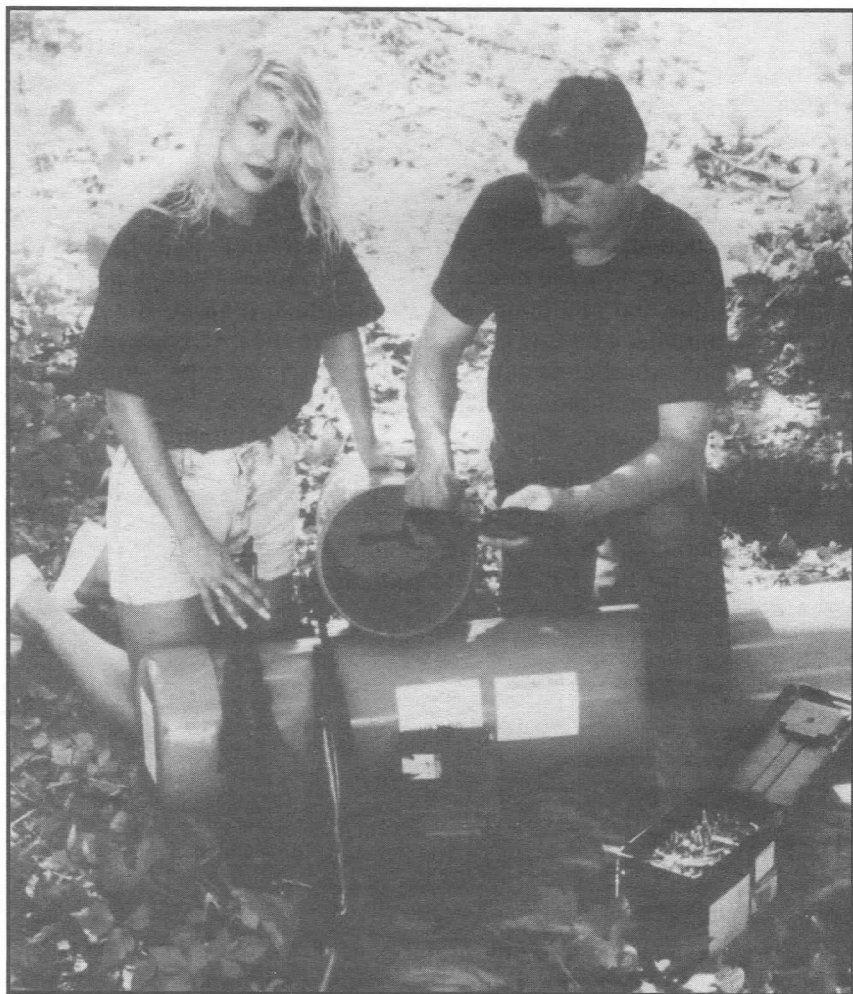

Bottom: A greater corrosion protection could be obtained by filling your vault with a variety of inert gases, (Most contain no water or oxygen and are commonly available at welding supply stores, for very little money. Here Carbon Dioxide is used with a smaller bottle of Nitrogen on stand by. Also used in soft drink dispensers as corrobortors and for welding. This will offer far greater protection for very long term storage, but always use a desiccant to absorb moisture as a back up.

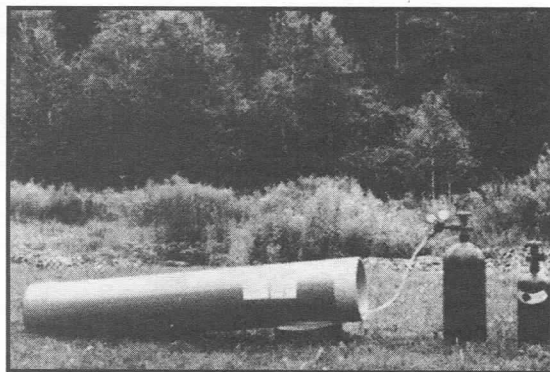

If you are reading this book I'm sure you've already noticed how many people are frightened right now by the present wave of anti-gun hysteria which seems to be sweeping our nation. At no time in our countries history have our freedoms faced such a serious threat. No foreign government could ever hope to subject and enslave the people of this nation, but somehow under the guise of "THE NEWWORLDORDER", our own political officials seem to want to do just that?

BEREIT INDUSTRIES COBRA CASE buryable gun vault will provide many people with piece of mind, knowing that they have the ability to prepare and survive the worst of times, (IF NECESSARY). BEREIT INDUSTRIES super high quality vaults are designed for very long term storage of firearms or any emergency supplies, which YOU can bury, store outside or carry in your vehicle or boat without any regards to water damage. The rifle case model is the most popular version, at 52 inches long it will easily accommodate even the longest rifles and shotguns, and when sealed they are totally water tight. Providing you with over 980 cubic inches of space inside, this case will easily protect up to three rifles with plenty of room left over for other survival necessities. The vaults are fabricated from super heavy duty high grade PVC plastic, with reinforced end caps. Being PVC plastic makes them non-magnetic and their dense heavy duty construction will make your vault "LOOK" like a rock to ground penetrating radar and sonic echo detection devices. Simple but rugged, BEREIT INDUSTRIES had the only reliable "SCREWON" end caps I tested. Easily opened and resealed over and over for you to inspect or to make timely additions as your needs arises. These vaults are delivered complete and ready for you to use the same day your U.P.S. driver arrives with it! Sold at only \$59.95 plus \$12.00 Shipping & Handling. -- Alaska and Hawaii residents please call for current shipping charges and delivery times --

BEREIT INDUSTRIES

P.O. BOX 130304 Tampa FL 33681

Phone: 813-832-3191

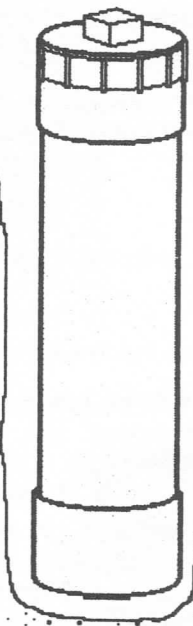



IMPORTANCE OF PRE-PLANNING

Clean your vault as thoroughly as you can, really use a lot of elbow grease with a little clorax to kill the Bactria that will feed on the grease you'll be using to preserve your metal. That's right! the germs will grow and thrive until the environment is totally contaminated with there own waste killing the germs off and leaving a waste filled vault. So rinse and dry the vault thoroughly, you can't have any corrosive detergents or bacterial residue remaining.

If the walls of your plastic barrel are unusually thin and you think they will collapse in time you had better make provisions for some sort of hole bracing or lining in your hole. I don't recommend using the far more common and cheaper 55 gal. steel drums they will rust through in only a few years and are very easy to detect with their strong magnetic signal.

WHAT TO BURY: I would bury things you would consider stupid so I won't go into just what to bury but I will suggest ALL GUNS that you bought or inherited without papers, I predict in the future that if the government knows you have guns (they have been tracking them for over 50 years), they will put you in jail until you turn them in. Plan ahead right now!. All the ammo you can get, I mean a shit load. Precious metals or coins that people will recognize, like silver dollars. If you like weapons accessories buy them now, bury whatever you are able to afford in weapons sighting systems, Freeze dried food only, most other foods will only rot, germinating a bacterial waste land, destroying the contents of your tube. Maps and survival books and the supplies to make the "stuff", this chemical knowledge could be a great advantage to your community.

SEALING; Is of course vital as any moisture even a minute amount of moisture will rapidly deteriorate your goods, pure high grade silicone sealer should be used in large amounts for sealing, don't skimp here and always test your seal before burial by total immersion in a water tank or swimming pool, any air bubbles will indicate a ineffective seal.

NO ONE CAN SEE YOU; Checking for hunting season: so you won't be seen.

WEATHER; So everything won't get wet in a rain storm.

AIR SURVEILLANCE; They are photographing everywhere looking for those pesky "terrorist marijuana growers". Don't let raw dirt accumulate around the sight, they will be searching for ground disturbance, it's a clear sign that marijuana growers were there. Remember they have been forced to live secret "underground" lives and could be your true friend in the future.

TOPOGRAPHICALLY LAYOUT: Don't burry in a swamp or even in seasonally wet areas or flood planes. Go to your local zoning board and request a map of zoning areas like forest and commercial land tracks. Don't bury where there will be future construction.

BOOBY TRAPS; It is just plain stupid to plant traps for little kids to find.

NO TRAILS: It may take some people days to carry in their goods, so plan a new path each trip,

BURY DEEP: At least 2 feet of soil to the top of the vault, 3 feet will be much better.

STAND THE VAULT UP: It's far more difficult to detect, and will be passed off as a much smaller "ECHO"

LOCATION; Like the old real estate slogan goes Location, Location, Location. If the landscape is changed by logging or other work you will be in deep shit looking for that big oak tree that was cut down ten years ago, so plan your recovery methods completely. My suggestion is to know the spot well, don't go out and dig a little hole in the middle of no where and expect to find it 20 years later, it's not going to happen and if you do find the location, it will be pure luck! Here is my suggestion, pick a land mark that has been there for at least one hundred years and one you expect to be there for another hundred, (grave yards, parks, forest, avoid places where construction is possible) carefully measure the distances and plot your sight. Always check your map by trying to find your sight right after the tube is buried, if everything is OK walk away and don't go back until a few weeks later to check if the ground foliage you replanted has returned, if not plant some more.

LAST BUT MOST IMPORTANT: Tell no one, never tell, don't speak of it for life, don't brag even when your drunk never, never, never, don't talk to your self about it, don't tell your wife, your father, your children, your doctor, not even your priest, no one, it does not exist, the end.



FREEBEE ALTERNATIVES

This country still has a few factories left that may allow you to take away one of these barrels. Keep in mind the workers are in most cases paid slave labor wages and would be glad to help you if they are made to feel they have worth are respected and knowledgeable. You could opt to buy one from companies that supply the food and plastics, paints and chemicals, wire coating and cloth coating, industries etc. New they are \$20 to \$180 for around a 40 gallon sizes. I called for pricing on 8" schedule 35 PVC with 2 caps and priced at \$110.00 the NICs 10" schedule 40 tube or the smaller BEREIT tube looks like a better deal all around.

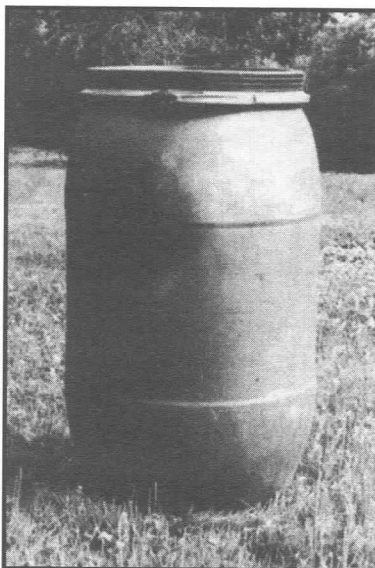

LEFT: This PVC Sealed plastic barrel with a steel retaining band is a very good choice. Holding approx 40 gallons and very durable. This was given to me, it held Teflon and had been cleaned spotless when I received it.

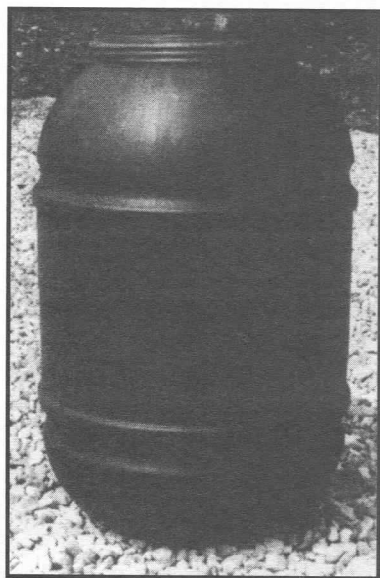

ABOVE: Here is a Food grade plastic barrel used to age pickles. The top screws on with a high quality rubber seal. This is a good choice at 42 gallons.

BELOW: Another freebee from a Plastics plant worker, it holds 27 gallons and is PVC and very strong indeed. It is returnable for a refill of plastic beads.

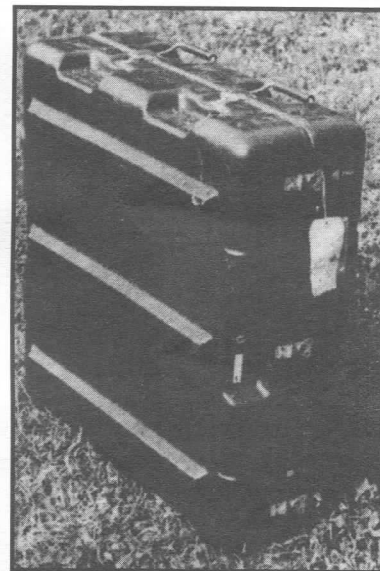
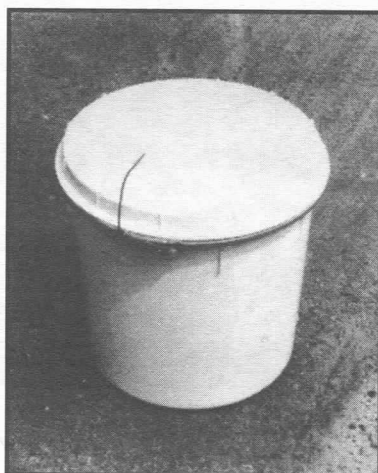

ABOVE: Military surplus will provide you with an unlimited choice in size and materials. The one shown above was originally used to protect electronic equipment once, then discarded on the battle field?

RIGHT: Ammo boxes are probably the very best vault for the money, they come in sizes up to 8 ft. tall and 2 ft. by 2 ft. square (they hold small rockets) I advise you to treat the outer metal surface with some kind of water repellent like roofing tar or high grade marine paint to stop rust through.





Is it possible to build an underground shelter in your home or garage? In fact I have been sworn to secrecy and shown some very nice shelters, ranging from one in VT costing one hundred thousand dollars which the owner (a public figure) wouldn't even let me bring my camera into, to ones people with more determination and far less money built that do provide very nice semi permanent shelters. One rural N.Y. resident sledged hammered a hole into his garage floor and dug the dirt away until he could fit in a small pull behind camper which he then lowered into the hole and buried, he then re-cemented his garage floor using an ingenious hidden entrance way. This family has the most comfortable shelter I have ever visited, their total cost was less then one thousand dollars for a shelter 7 ft. wide by 19 ft. long. He can shower with spring water and has a septic installed along with city electric with back up batteries and hand generator, heat and hot water, and an Air scrubbing system. Then there are those who just want to bury a small stash, in which case a large ammo can coated on the outside with roofing tar will do nicely. Research the local and federal law books to determine if your actions are in fact legal at the time you carry them out, so I leave you now to investigate the legal ramifications.

Below: You and I are not the first to bury their guns and supplies! This is being done all around this country and is increasing in popularity. Here a survivalist used a ammo can to safe guard his valuable and irreplaceable survival supplies. They said their can has been buried for over 3 years, they used a aerosol can of grease to preserve the metal.

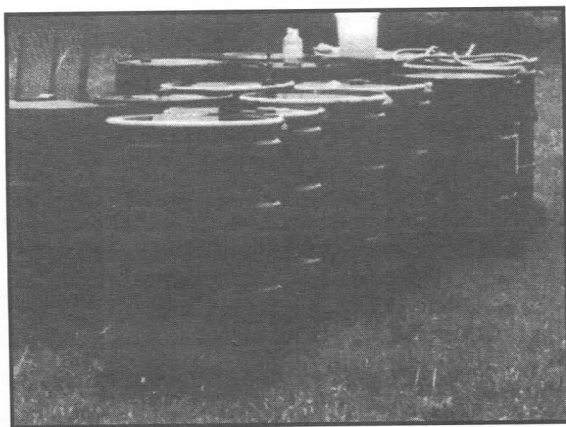

Left: Steel ring topped barrels are free in most cases, but I would recommend against them , they will rust through in only a few years. A tar coating might help?

Right: an 8" PVC tube with a low quality end cap. This cap is designed to be glued onto the tube and cut open when needed. It's low cost is nice but is it long lasting?

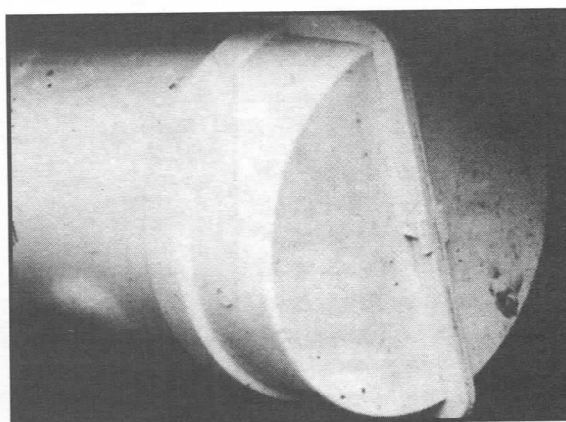

Other Books Available From Desert Publications

081	Crossbows/ From 35 Years With the Weapon	\$15.95	C-571	U. S. Marine Corps Scout/Sniper Training Manual	\$27.95
206	CIA Field Expedient Preparation of Black Powder	\$19.95	C-610	Aunt Bessie's Wood Stove Cookbook	\$9.95
221	Evaluation of Improvised Shaped Charges	\$19.95	C-622	Defensive Shotgun	\$14.95
411	Homeopathic First Aid	\$11.95	C-625	MAC-10 Cookbook	\$14.95
454	Survival Childbirth	\$15.95	C-627	Brown's Lawsuit Cookbook	\$26.95
C-002	How To Open A Swiss Bank Account	\$9.95	C-628	Can You Survive	\$16.95
C-011	Defending Your Retreat	\$9.95	C-633	Hand to Hand Combat	\$11.95
C-020	Methods of Long Term Storage	\$9.95	C-634	USMC Hand to Hand Combat	\$9.95
C-023	Federal Firearms Laws	\$11.95	C-635	Hand to Hand Combat by D'Eliscue	\$11.95
C-024	Select Fire Uzi Modification Manual	\$13.95	C-636	Prisons Bloody Iron	\$16.95
C-025	How to Build Silencers	\$6.95	C-639	Police Karate	\$17.95
C-027	Firearms Silencers Volume 1	\$13.95	C-646	Science of Revolutionary Warfare	\$16.95
C-029	M1 Carbine Arsenal History	\$7.95	C-668	Survival Shooting for Women	\$7.48
C-032	The Silencer Cookbook	\$9.95	C-680	Infantry Scouting, Patrol & Sniping	\$16.95
C-038	How To Build A Beer Can Mortar	\$4.95	C-694	CIA Field Expedient Incendiary Manual	\$19.95
C-040	Criminal Use of False ID	\$14.95	C-761	How to Lose Your X-Wife Forever	\$24.95
C-045	Improvised Weapons of American Underground	\$14.95	C-763	Vigilante Handbook	\$19.95
C-048	Catalog of Military Suppliers	\$18.95	C-775	Alcohol Distillers Handbook	\$27.95
C-056	Navy Seal Manual	\$29.95	C-776	How to Build a Junkyard Still	\$15.95
C-065	Poor Man's James Bond Vol 1	\$34.95	C-777	Engineer Explosives of WWI	\$19.95
C-113	Submachine Gun Designers Handbook	\$19.95	C-794	US Marine Corps Essential Subjects	\$19.95
C-114	AR-15, M16 and M16A1 5.56mm Rifles	\$13.95	C-815	US Marine Bayonet Training	\$11.95
C-117	Ruger Carbine Cookbook	\$13.95	C-818	The Poisoner's Handbook	\$29.95
C-120	Shootout II	\$14.95	C-823	Cold Weather Survival	\$14.95
C-122	AK-47 Assault Rifle	\$15.95	C-829	The Anarchist Handbook Vol. 2	\$14.95
C-123	Combat Loads for Sniper Rifles	\$18.95	C-889	Napoleon's Maxims of War	\$11.95
C-125	Browning Hi-Power Pistols	\$13.95	C-890	Company Officers HB of Ger. Army	\$19.95
C-126	UZI Submachine Gun	\$13.95	C-891	German Infantry Weapons Vol 1	\$18.95
C-127	FullAuto Vol 1 Ar-15 Modification Manual	\$11.95	C-896	Op. Man. 7.62mm M24 Sniper Weapon	\$13.95
C-128	Full Auto Vol 2 Uzi Mod Manual	\$11.95	C-899	US Army Bayonet Training	\$11.95
C-130	Full Auto Vol 4 Thompson SMG	\$11.95	C-9002	German MG-34 Machinegun Manual	\$11.95
C-131	FullAuto Vol 5 M1 Carbine to M2	\$11.95	C-9012	Firearm Silencers Vol 3	\$18.95
C-135	M-14 Rifle, The	\$12.95	C-9013	HK Assault Rifle Systems	\$27.95
C-136	Fighting Garand Manual	\$13.95	C-9047	SKS Type of Carbines, The	\$17.95
C-137	Ranger Training & Operations	\$19.95	C-9048	Rough Riders, The	\$24.95
C-138	Emergency War Surgery	\$29.95	C-9052	Private Weaponeer, The	\$17.95
C-140	Emergency Medical Care/Disaster	\$14.95	C-9057	Keys To Understanding Tubular Locks	\$11.95
C-143	Survival Medicine	\$15.95	C-9060	The Anarchist Handbook Vol. 3	\$14.95
C-150	Improvised Munitions Black Book Vol 1	\$17.95	C-9080	Leadership Handbook of Small Unit Ops	\$14.95
C-151	Improvised Munitions Black Book Vol 2	\$17.95	C-9081	Dirty Fighting	\$13.95
C-152	Impro. Munitions Black Book Vol 3	\$29.95	C-9082	Lasers & Night Vision Devices	\$29.95
C-155	Fighting Back on the Job	\$14.95	C-9083	Water Survival Training	\$8.95
C-162	Colt 45 Auto Pistol Manual	\$13.95	C-9084	Assorted Nasties	\$29.95
C-163	Survival Evasion & Escape	\$19.95	C-9085	Ruger P-85 Family of Handguns	\$19.95
C-165	USMC Sniping	\$19.95	C-9101	Guide to Germ Warfare	\$17.95
C-175	Beat the Box	\$7.95	C-9102	CIA Field Expedient Method for Explosives Preparation	\$19.95
C-197	How to Make Disposable Silencers Vol. 1	\$19.95	C-9119	Surviving Global Slavery	\$16.95
C-198	Expedient Hand Grenades	\$21.95	C-9120	Military Knife Fighting	\$14.95
C-199	U. S. Army Counterterrorism Training Manual	\$19.95	C-9127	H&R Reising Submachine Gun Manual	\$19.95
C-203	Explosives and Propellants	\$19.95	C-9131	Live to Spend It	\$29.95
C-204	Improvised Munitions/Ammonium Nitrate	\$19.95	C-9134	Military Ground Rappelling Techniques	\$15.95
C-205	Two Component High Explosives Mixtures	\$19.95	C-9135	Smith & Wesson Autos	\$19.95
C-207	CIA Improvised Sabotage Devices	\$19.95	C-9137	Caching Techniques of U.S. Army Special Forces	\$14.95
C-208	Special Forces Demolitions Training Handbook	\$19.95	C-9138	USMC Battle Skills Training Manual	\$49.95
C-210	Guerilla Warfare	\$17.95	C-9139	Survival Armory	\$27.95
C-211	FN-FAL Auto Rifles	\$21.95	C-9156	Concealed Carry Made Easy	\$17.95
C-218	Professional Homemade Cherry Bomb	\$15.95	C-9164	The Lil M-1, The 30 Cal. M-1 Carbine	\$17.95
C-219	Improvised Shaped Charges	\$19.95	C-9170	Urban Combat	\$27.95
C-220	Improvised Explosives, Use In Detonation Devices	\$19.95	C-9178	Apocalypse Tomorrow	\$17.95
C-227	Springfield '03 Rifle Manual	\$15.95	C-9198	MP40 Machinegun Manual	\$16.95
C-229	Lock Picking Simplified	\$11.95	C-9199	Clear Your Record & Own a Gun	\$24.95
C-230	How to Fit Keys by Impressioning	\$9.95	C-9200	Sig's Handguns Manual	\$19.95
C-231	Lockout -Techniques of Forced Entr	\$15.95	C-9210	Sniper Training	\$24.95
C-235	How to Open Handcuffs Without Keys	\$13.95	C-9212	Poor Man's Sniper Rifle	\$19.95
C-244	Camouflage	\$14.95	C-9221	The Official Makarov Pistol Manual	\$14.95
C-274	M14 and M14A1 Rifles and Rifle Marksmanship	\$23.95	C-9224	The Butane Lighter Hand Grenade	\$14.95
C-284	Thompson Submachine Guns	\$19.95	C-9228	Unarmed Against the Knife	\$14.95
C-289	M1 Carbine Owners Manual	\$13.95	C-9229	Black Book of Booby Traps	\$29.95
C-290	Clandestine Ops Man/Central America	\$14.95	C-9239	Militia Battle Manual	\$22.95
C-324	How to Make Disposable Silencers Vol. 2	\$19.95	C-9247	Black Book of Revenge	\$15.95
C-333	USMC AR-15/M-16 A2 Manual	\$21.95	C-9253	Bankruptcy, Credit and You	\$18.95
C-337	Sten MKII SMG Construction Manual	\$24.95	C-9255	The Sicilian Blade	\$15.95
C-356	Map Reading and Land Navigation	\$19.95	C-9259	How to Build Practical Firearm Silencers	\$18.95
C-365	Survival Gunsmithing	\$14.95	C-9262	Glock's Handguns	\$19.95
C-372	Poor Man's James Bond Vol 2	\$34.95	C-9263	Heckler and Koch's Handguns	\$19.95
C-386	Self-Defense Requires No Apology	\$15.95	C-9264	The Poor Man's Ray Gun	\$11.95
C-414	Select Fire 10/22	\$15.95	C-9265	The Poor Man's R. P. G.	\$24.95
C-415	Construction Secret Hiding Places	\$15.95	C-9279	Credit Improvement & Protection Handbook	\$19.95
C-416	Brown's Alcohol Motor Fuel Cookbook	\$24.95	C-9281	Build Your Own AR-15	\$19.95
C-417	Canteen Cup Cookery	\$9.95	C-9282	How to Live Safely in a Dangerous World	\$19.95
C-418	Improvised Batteries/Detonation Devices	\$19.95	C-9293	Black Book of Arson	\$24.95
C-421	Walther P-38 Pistol Manual	\$13.95	C-9322	How to Build Flash/Stun Grenades	\$19.95
C-422	P-08 Parabellum Luger Auto Pistol	\$14.95	C-9342	Entrapment	\$19.95
C-423	Sten Submachine Gun, The	\$11.95	C-9359	The FN-FAL Rifle Et Al.	\$21.95
C-427	How to Train a Guard Dog	\$16.95	C-9367	The Mental Edge, Revised	\$17.95
C-429	The Anarchist Handbook Vol. 1	\$14.95	C-9373	Survival Bible by Duncan Long	\$59.95
C-430	Beretta - 9MM M9	\$15.95	C-9405	The Internet Predator	\$17.95
C-432	Mercenary Operations Manual	\$14.95	C-9406	The Criminal Defendants Bible	\$49.95
C-439	Improvised Lock Picks	\$15.95	C-9430	Protect Your Assets	\$24.95
C-455	Modern Day Ninjutsu	\$17.95	C-9432	How To Build Military Grade Suppressors	\$21.95
C-512	FullAuto Vol 8 M14A1 & Mini 14	\$11.95	C-9441	Mossberg Shotguns	\$24.95
C-518	L A W Rocket System	\$14.95	C-9478	Poor Man's Primer Manual, The	\$24.95
C-528	With British Snipers, To the Reich	\$29.95	C-9546	Agents HB of Black Bag Ops	\$14.95
C-539	Dental Specialist	\$59.95	C-9556	Improvised Rocket Motors	\$14.95
C-558	Food, Fur and Survival	\$17.95	C-9612	Homestead Carpentry	\$14.95
C-561	The Squeaky Wheel	\$17.95			
C-562	Survival Chemist Book	\$17.95			
C-564	Medical Specialist	\$49.95			

PRICES SUBJECT TO CHANGE WITHOUT NOTICE

Desert Publications

870-862-3811

215 S. Washington Ave Dept. - BK - 262

Shipping & Handling 1

item \$6.95 - 2 or more \$11.95

El Dorado, AR 71730 USA

Look to *Desert Publications* for the finest in survival, self-defense, military & police science, firearms & weaponry and alternate energy books.

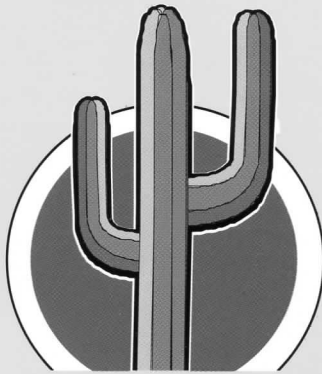

Desert Publication

215 S. Washington Ave.
El Dorado, AR 71730 U. S. A.
info@deltapress.com

ISBN: 978-0-87947-262-7



9 780879 472627