STATIM 2000/5000 G4

CASSETTE AUTOCLAVE™



- Operator's Manual



STATIM 2000/5000 G4 Operator's Manual 95-113364 Rev. 1.0 Copyright 2012 SciCan Ltd. All rights reserved.

SciCan

| Your Infection Control Specialist™

Table of Contents

1. Introduction	3	5. Using your STAT/IM	24
2. Important Information	4	5.1 Preparing Unit for Use	
2.1 Disclaimers		5.2 STAT/IM 2000 G4 – Selecting a Cycle	
2.2 STAT/IM 2000 G4 - Unit Overview		5.3 STAT/IM 5000 G4 – Selecting a Cycle	
2.3 STAT/IM 5000 G4 - Unit Overview		5.4 STAT/IM 2000 / 5000 G4 – Running a Cycle	
2.4 Touchscreen Overview		5.5 STAT/IM 2000 / 5000 G4 – Stopping a Cycle	
2.5 Setup Menu Overview		6. Storing and Retrieving Cycle Information.....	33
3. Setting Up your STAT/IM.....	10	6.1 Retrieving Cycle Information Using the Touchscreen	
3.1 Positioning and Powering your Unit		6.2 Retrieving Cycle Information Using the USB Data Backup	
3.2 Leveling your Unit		6.3 Cycle Printout Overview	
3.3 Connecting the Waste Bottle		7. Printer Cycle Information	35
3.4 Filling the Water Reservoir		7.1 Connecting to a Printer	
3.5 Priming the Pump		7.2 Adjusting your Printer Settings	
3.6 Shipping the Unit		7.3 External Printers and Specifications	
3.7 Setting the Time		8. Maintaining your STAT/IM	36
3.8 Setting the Date		8.1 Cleaning the Cassette	
3.9 Setting the Language		8.2 Cleaning the Water Reservoir Filter	
3.10 Assigning Unit Identifier Number		8.3 Cleaning the Reservoir	
3.11 Creating a User ID and PIN		8.4 Cleaning the Exterior Surfaces	
3.12 Setting Up Process Enforced Usage		8.5 Changing the Bacteria Retentive Filter and the Air Filter	
3.13 Changing the Touchscreen Display Themes		8.6 Replacing the Cassette Seal	
3.14 Adjusting the Screensaver Delay		8.7 Maintaining Fluid Levels	
3.15 Adjusting the Screen Contrast		8.8 Reading Water Quality	
3.16 Turning the Button Sound ON or OFF		8.9 Preventative Maintenance Schedules	
3.17 Adjusting the Button Beep Volume		9. Troubleshooting your STAT/IM	41
3.18 Connecting to a Network		10. Ordering Spare Parts	44
4. Using Cassettes and Preparing Instruments	18	11. Warranty	45
4.1 Using the STAT/IM 2000 G4 Cassette		12. Specifications	46
4.2 Using the STAT/IM 5000 G4 Cassette		12.1 STAT/IM 2000 G4	
4.3 Using Drying Plates with the STAT/IM 5000 G4		12.2 STAT/IM 5000 G4	
4.4 Preparing and Loading Instruments			
4.5 Using Biological and Chemical Indicators			
4.6 Instrument Weight Guide			

STAT/IM Cassette Autoclave and STAT/IM are registered trademarks and Your Infection Control Specialist, DriTec[®] and DriTec[®] logos are trademarks of SciCan Ltd. All other trademarks referred to in this manual are the property of their respective owners.

For all service and repair inquiries:

In Canada 1-800-870-7777
United States: 1-800-572-1211
Email: techservice.ca@scican.com

Manufactured by:

SciCan Ltd.

1440 Don Mills Road,
Toronto ON M3B 3P9
CANADA

Phone: (416) 445-1600
Fax: (416) 445-2727
Toll free: 1-800-667-7733

SciCan GmbH

Wangener Straße 78
88299 Leutkirch
Germany
Tel.: +49 (0)7561 98343 - 0
Fax: +49 (0)7561 98343 - 699

SciCan Inc.

701 Technology Drive
Canonsburg, PA 15317
USA
Phone: +1 724 820 1600
Fax: +1 724 820 1479
Toll free: 1-800-572-1211

SciCan Medtech

Alpenstrasse
166300 Zug
SWITZERLAND
Phone: +41 (0) 41 727 7027
Fax: +41 (0) 41 727 702

1 Introduction

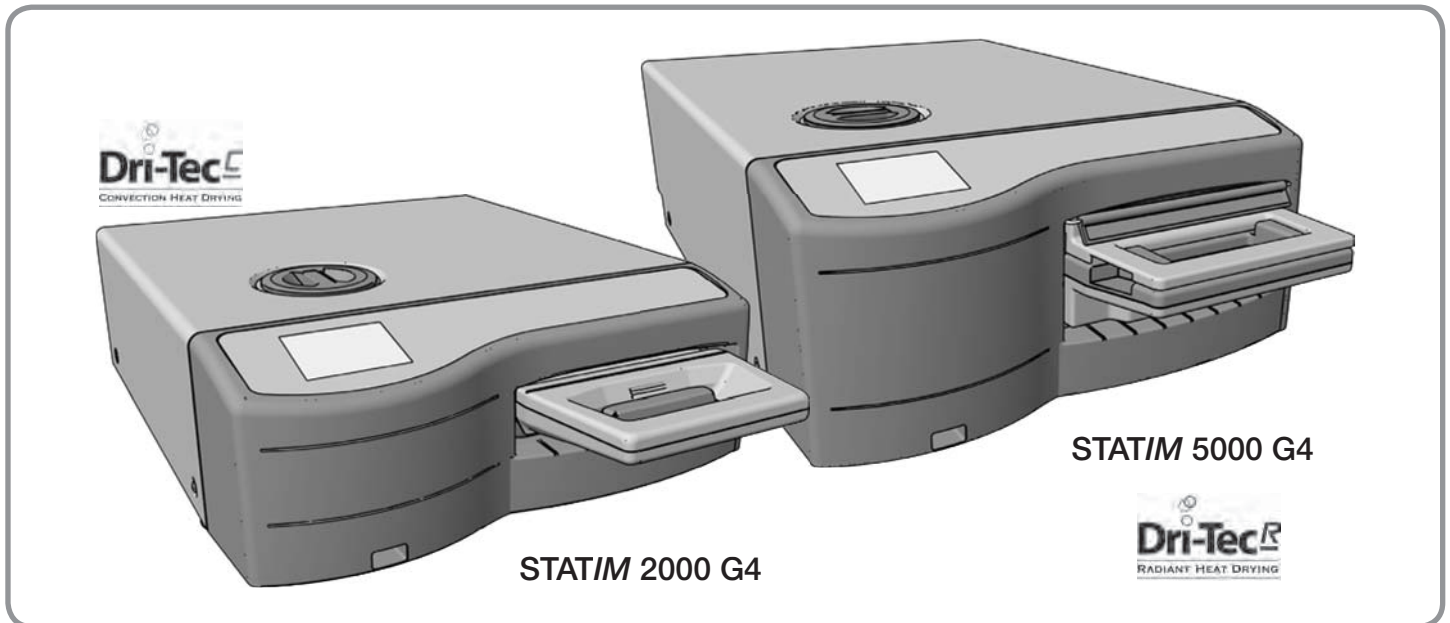

Congratulations on your selection of the STAT/M Cassette Autoclave®. We are confident that you have purchased the finest equipment of its type. The STAT/M® is a compact, counter-top unit that features a number of sterilizing cycles designed to meet your needs and suitability for steam sterilization.

The details of installing, operating and servicing your STAT/M are all contained within this operator's manual. To ensure years of safe, trouble-free service please read these instructions before operating this unit and keep them for future reference. Operational, maintenance and replacement instructions should be followed for the product to perform as designed. Contents of this manual are subject to change without notice to reflect changes and improvements to the STAT/M product.

The STAT/M is suitable for the sterilization of dental and medical instruments designed to withstand steam sterilization. The STAT/M is not designed to sterilize liquids, cloth loads, biomedical waste or materials not compatible with steam sterilization. The processing of such loads may result in incomplete sterilization and / or damage to the autoclave. For more information about instrument suitability for steam sterilization, consult the manufacturers' reprocessing instructions.

2 Important Information

2.1 Disclaimers

Use only steam-process distilled water in your STAT/M. Deionized, demineralized, or specially filtered water should not be used. Never use tap water.

Do not permit any person other than certified personnel to supply parts for, service or maintain your STAT/M. SciCan shall not be liable for incidental, special or consequential damages caused by any maintenance or services performed on the STAT/M by a third party, or for the use of equipment or parts manufactured by a third party, including lost profits, any commercial loss, economic loss, or loss arising from personal injury.

Never remove the cover of the unit and never insert objects through holes or openings in the cabinetry. Doing so may damage the unit and / or pose a hazard to the operator.

All elements of this book are common to both STAT/M 2000 G4 and STAT/M 5000 G4 except when noted.

IMPORTANT: Follow local guidelines governing verification of the sterilization procedure.

Drying Performance

The STAT/M 2000 G4 and 5000 G4 have been designed to provide a complete sterilization solution for your unwrapped and wrapped instrument needs: rapid sterilization balanced with rapid drying, by using the SciCan Dri-Tec Drying Technology.

To dry instruments, the STAT/M 2000 G4 uses a combination of forced filtered air and convection heat. The convection heat is derived from utilizing the remaining heat in the system after the sterilization phase has been completed. The heat is then captured and released into the cassette to rapidly dry a properly loaded cassette.

The STAT/M 5000 G4 also uses forced filtered air and heat generated by the sterilization phase to dry the instruments. The heat generated by the sterilization phase is absorbed by the drying plates and then transferred directly to the load. This then results in an accelerated, rapid drying of a properly loaded STAT/M cassette.

Please refer to this operator's manual for instructions on the proper arrangement of instruments in the cassette and the use of Drying plates (STAT/M 5000 G4). By carefully following these directions on how to properly load the cassette chamber, rapid drying of the load will be achieved.

2 Important Information

2.2 STATIM 2000 G4 – Unit Overview

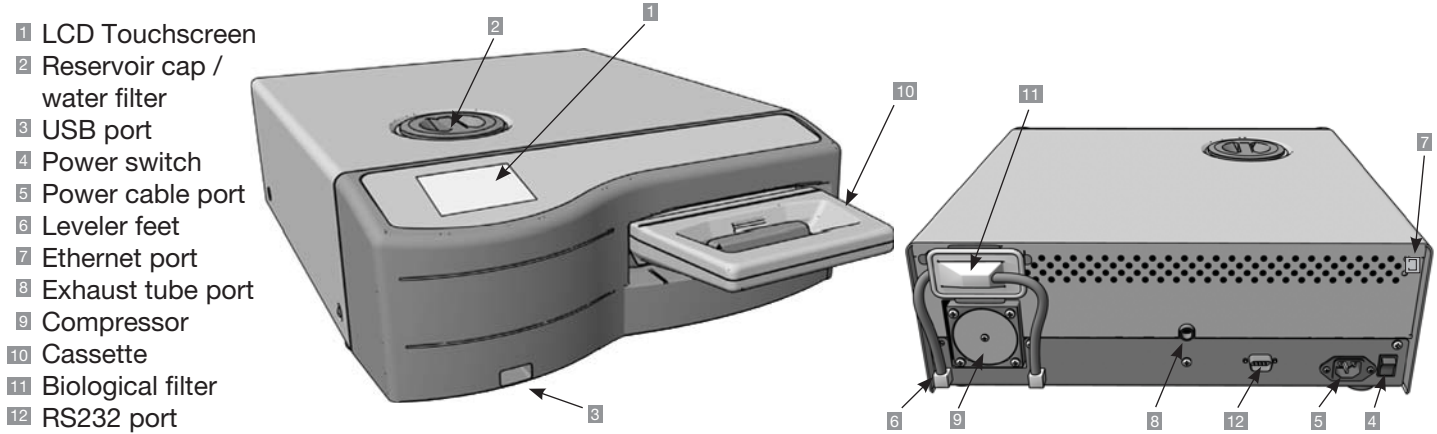

The following symbols appear in the margins of this book.

- A potential hazard to the operator.
- A situation which may lead to a mechanical failure.
- Important information.

The following symbols may appear on the unit:

- Caution: Hot Surface and/or Hot Steam
- Caution: Refer to user manual for details
- Caution: Risk of electrical shock. Disconnect supply before servicing
- Steam distilled water only (do not use tap water)
- START BUTTON
- STOP BUTTON
- UNWRAPPED CYCLE
- WRAPPED CYCLE
- AIR DRY ONLY CYCLE
- RUBBER / PLASTIC CYCLE

When you receive your STATIM 2000 G4, the items listed below will be included. If any of the items are missing, contact your dealer immediately.

	Cassette Tray and Lid
	Instrument Rack
	Waste Bottle
	Bottle Lid Fitting
	Tube Mounting Hardware

	Operator's Manual
	Exhaust Tube
	USB Memory Stick
	Power Cord

2 Important Information

2.3 STAT/IM 5000 G4 – Unit Overview

- 1 LCD Touchscreen
- 2 Reservoir cap / water filter
- 3 USB port
- 4 Power switch
- 5 Power cable port
- 6 Leveler feet
- 7 Exhaust tube port
- 8 Biological filter
- 9 Cassette
- 10 RS232 port
- 11 Ethernet port
- 12 Air filter

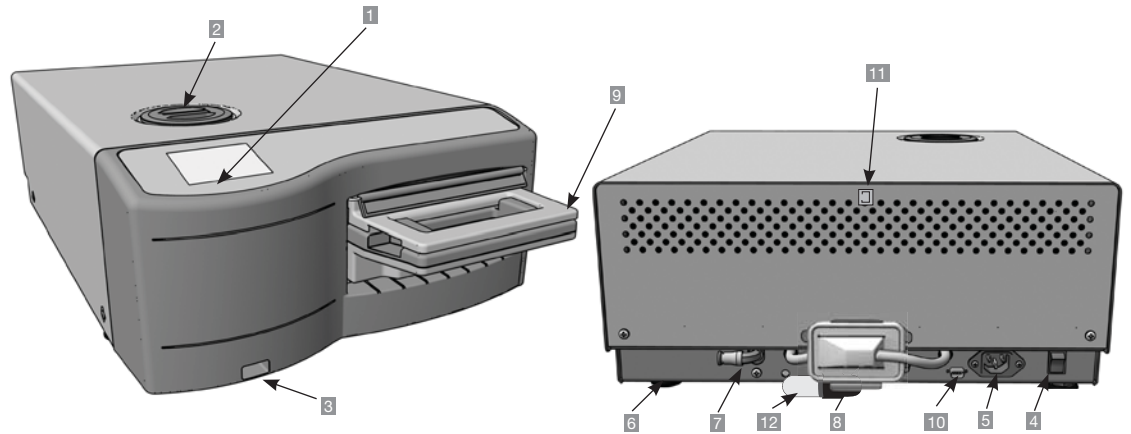

The following symbols appear in the margins of this book.



A potential hazard to the operator.



A situation which may lead to a mechanical failure.



Important information.

The following symbols appear on the unit:



Caution: Hot Surface and/or Hot Steam



Caution: Refer to user manual for details



Caution: Risk of electrical shock. Disconnect supply before servicing



Caution: Steam distilled water only (do not use tap water)



START BUTTON



STOP BUTTON



UNWRAPPED CYCLE



WRAPPED CYCLE



HEAVY DUTY UNWRAPPED CYCLE



RUBBER / PLASTIC CYCLE

When you receive your STAT/IM 5000 G4, the items listed below will be included. If any of the items are missing, contact your dealer immediately.

	Cassette Tray and Lid
	Unwrapped Instrument Rack
	Waste Bottle
	Bottle Lid Fitting
	Tube Mounting Hardware
	Rack with Drying Plates

	Power Cord
	Operator's Manual
	Exhaust Tube
	USB Memory Stick

2.4 Touchscreen Overview

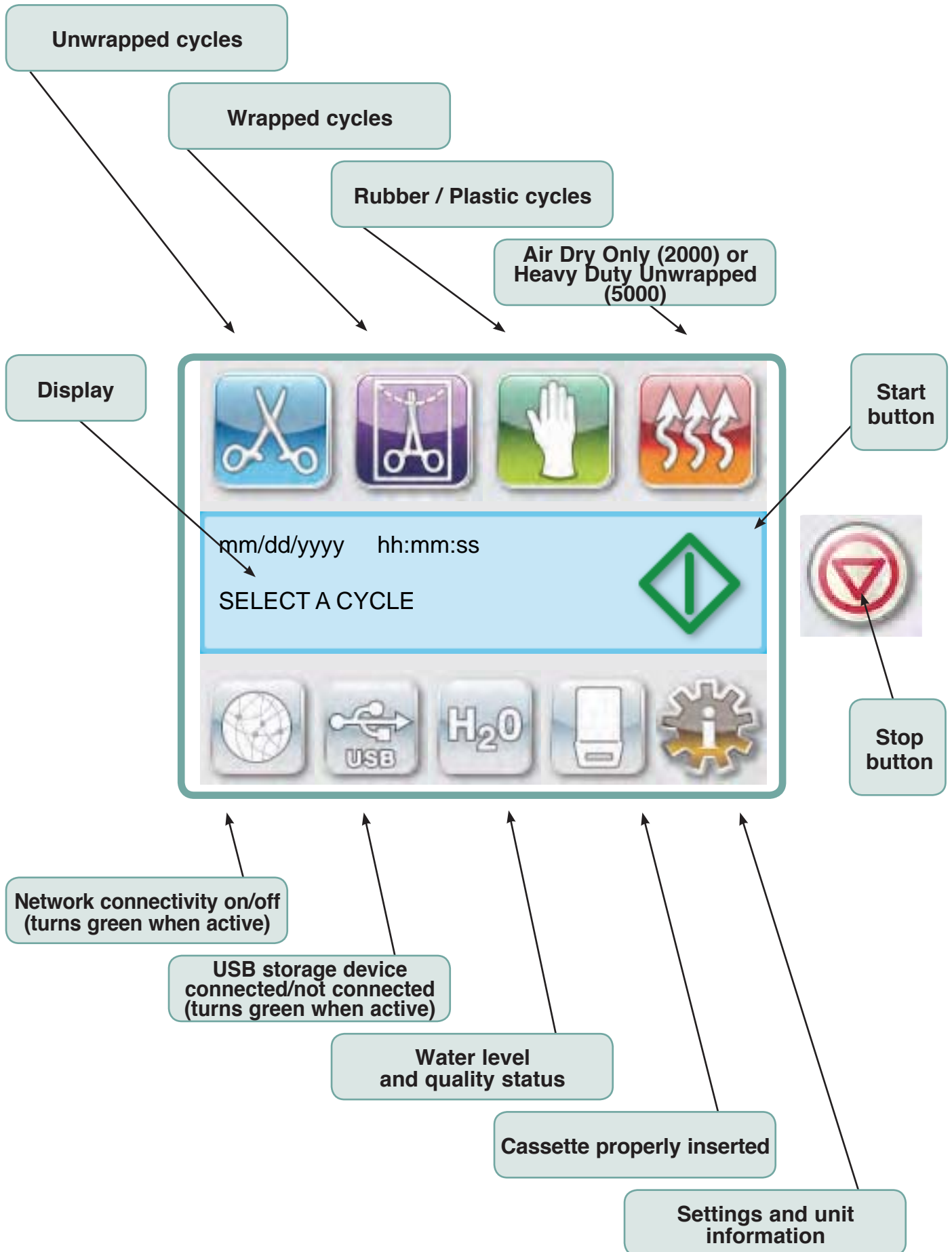

2.5 Setup Menu Overview

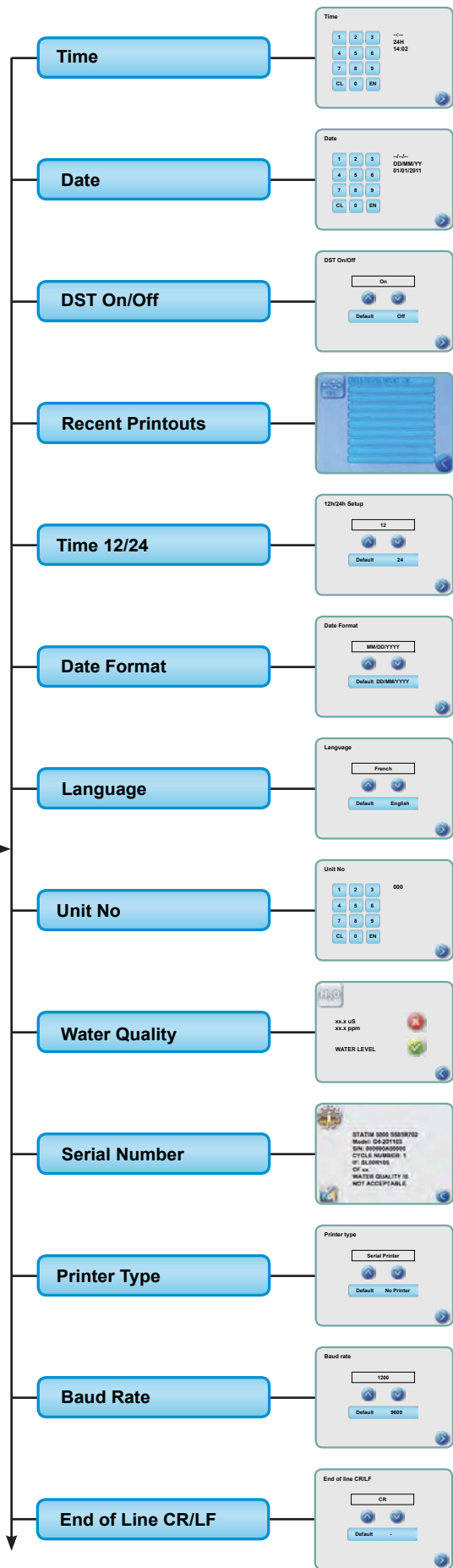

2.5 Setup Menu Overview

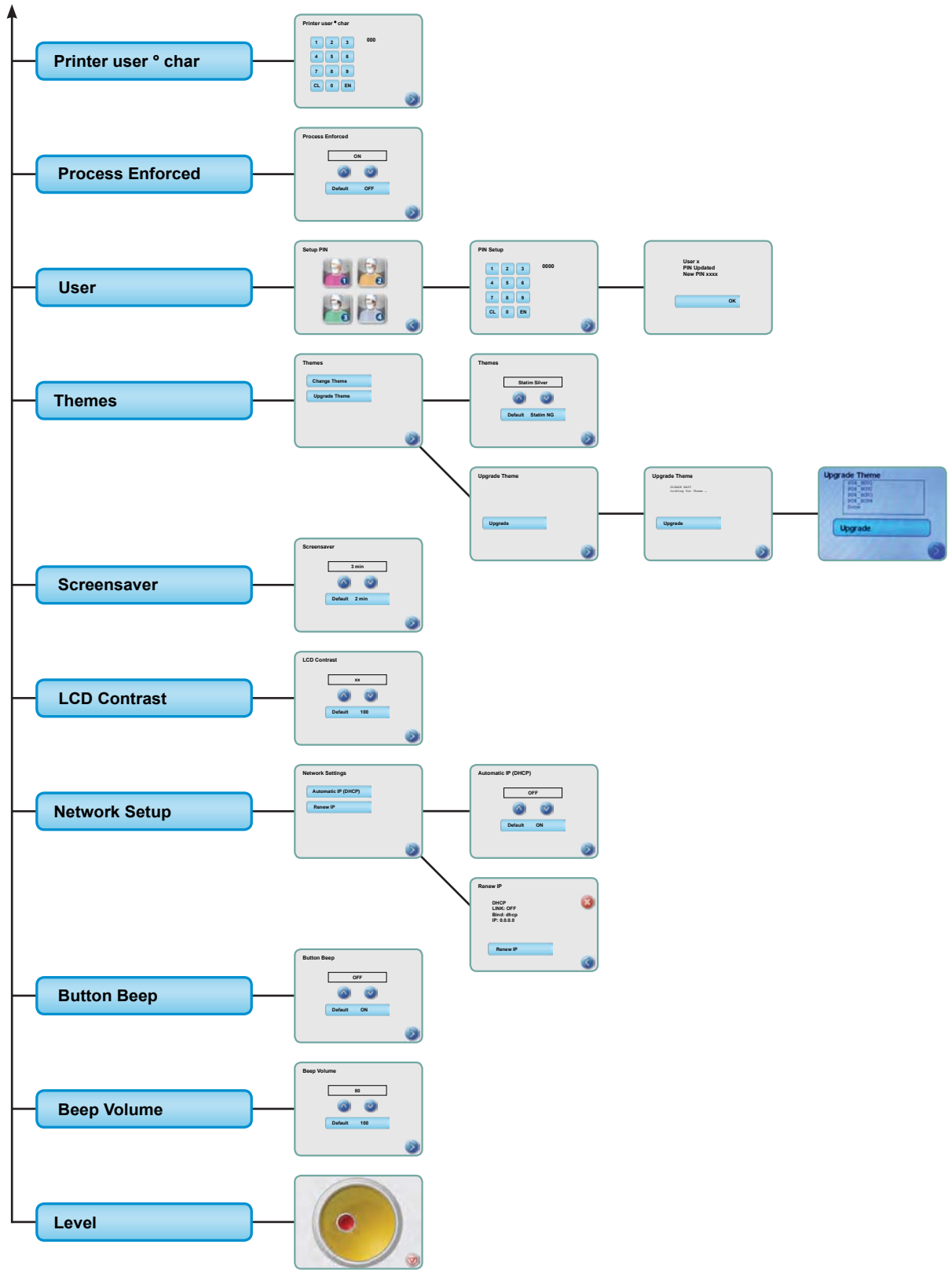

3 Setting up your STAT/M

3.1 Positioning and Powering your Unit.

Positioning your Unit

There are several factors that may affect the performance of your STAT/M. Please review these factors, and select a suitable location in which to install the unit.

- **Temperature and Humidity**

Avoid installing your STAT/M in direct sunlight or close to a heat source (e.g. vents or radiators). The recommended operating temperatures are 15-25°C (59°F to 77°F) with humidity of 25-70%.

- **Spacing**

The vents and openings on the STAT/M should remain uncovered and unobstructed. Leave a minimum of 50 mm/2" between the top, sides and back of the unit and any wall or partition. For more detailed information on clearances, see Specifications.

- **Venting**

The STAT/M should be operated in a clean, dust free environment.

- **Work Surface**

Your STAT/M should be placed on a flat, level, water-resistant surface. Never install and operate the unit on a sloped surface.

- **Electromagnetic Environment**

Your STAT/M has been tested and meets applicable standards for electromagnetic emissions. While the unit does not emit any radiation, it may itself be affected by other equipment which does. We recommend that your unit be kept away from potential sources of interference.

- **Electrical Requirements**

To power your unit, use properly grounded and fused power sources with the same voltage rating as indicated on the label at the back of your STAT/M. Avoid multiple outlet receptacles. If using a surge suppressor power bar, connect only one STAT/M to it.

Powering your Unit

To power your STAT/M, connect the power cord to the A.C. inlet receptacle at the back of the unit. Ensure the power switch is in the OFF position and connect the unit to your power source.

3 Setting up your STATIM

3.2 Levelling your Unit

When placing your unit on a counter top, ensure it is stable and that all four feet are securely in contact with the counter surface. This will prevent the unit from moving freely. Next, use the level indicator bubble function in the settings menu to adjust the three leveler feet so that the unit drains properly. To access the level indicator bubble from the main screen, follow these steps:



1. Scroll to and select.

3. Adjust the leveler feet to move the bubble. Position the bubble in the bottom right quadrant of the target. This will ensure that the unit drains properly. Press STOP to exit and return to the cycle select menu. When the unit is properly leveled, the bubble level will change from red to green.

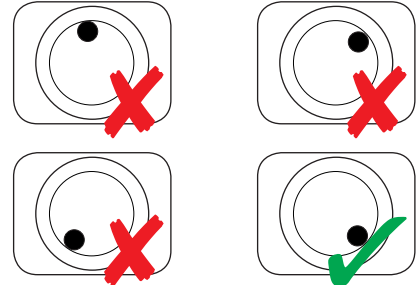

3 Setting up your STATIM

3.3 Connecting the Waste Bottle

The waste bottle **1** is used to collect the wastewater after it has been converted to steam and then drained from the cassette. To connect the waste bottle to the STATIM, follow these steps (see Figure 4):

1. Insert the exhaust tube **2** into the fitting **3** on the back of the unit and pull gently to confirm a tight fit.
2. Cut the tube to length and slide the waste bottle fitting **4** into place.
3. Place the free end of the tube into the hole in the lid of the waste bottle and hand-tighten the fitting. Do not coil the exhaust tube.
4. Unscrew the lid and copper condenser coil **5** assembly from the waste bottle. The lid and coil should come out together.
5. Fill the waste bottle with water to the MIN line and replace the lid and copper condenser assembly. Empty the waste bottle often to avoid unpleasant odors and discoloration of the contents. (A low-level disinfectant, prepared according to the manufacturer's instructions, may be added to the waste bottle to remedy this situation). As a minimum, empty the waste bottle each time you refill the reservoir.
6. Place the waste bottle near the unit. Store the bottle below the unit. The tube can be routed through a hole, (8 mm/0.3" in diameter) in the counter-top and secured with the provided nylon clamps.

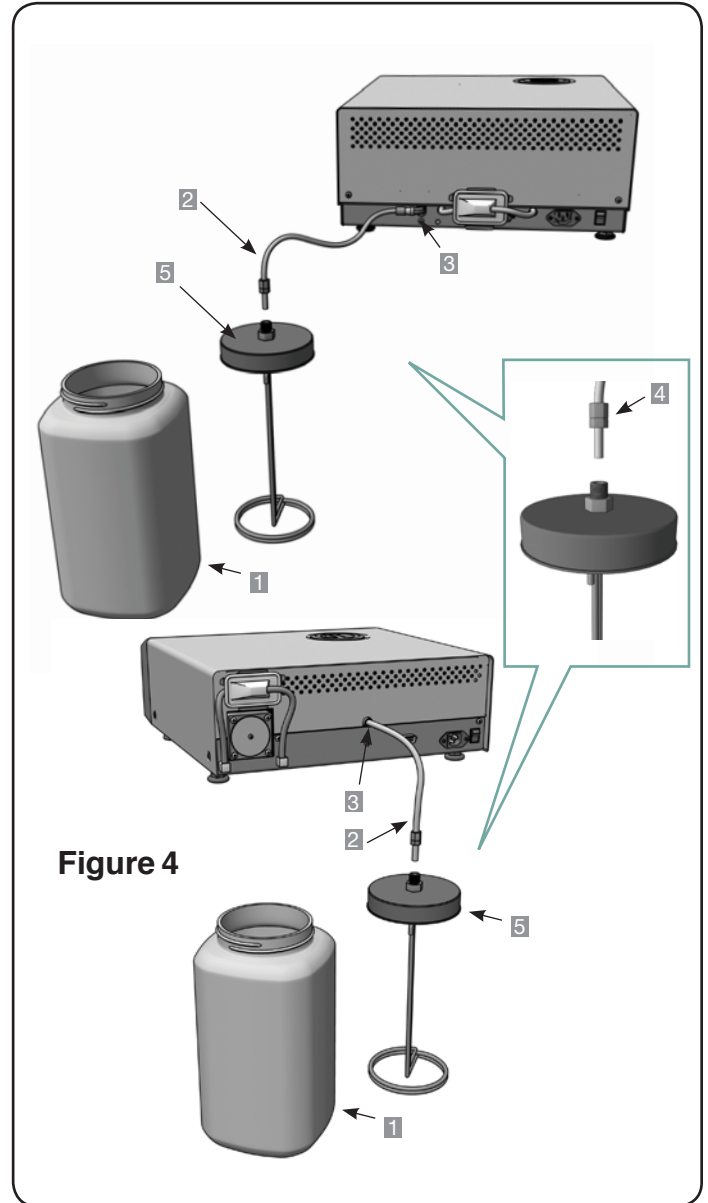

Figure 4

3 Setting up your STATIM

3.4 Filling the Water Reservoir

When filling the reservoir, ensure you only use steam processed distilled water containing less than 5 ppm total dissolved solids (having conductivity of less than 10 $\mu\text{S} / \text{cm}$). The impurities and additives in other water sources will cause an error reading on the LCD.

To fill the reservoir, follow these steps (see Figure 5):

1. Remove the reservoir cap **1**.
2. Pour steam-process distilled water into the reservoir until almost full (a maximum of 4L/1 U.S. gal). Use a funnel to avoid spillage.
3. Replace and secure the cap.

3.5 Priming the Pump

To prime the STATIM pump, follow these steps (see Figure 6):

1. Move the unit to the edge of the work surface. The front leveler feet should be approximately 12 mm/0.5" from the edge.
2. Lift the front left corner of the unit upward and remove the drain tube **2** from the clip located on the underside of the unit.
3. Pull the drain tube outward so the free end can be positioned over a water container.
4. Fill the reservoir with steam-process distilled water.
5. Remove the plug **3** from the end of the drain tube and allow water to drain from the tube into a container for 30 seconds. When the water flows in a steady stream, replace the stopper.
6. Lift the front left corner of the unit upward and reinsert the tube into the clip on the underside of the unit. Push the excess length of tubing back into the space provided.

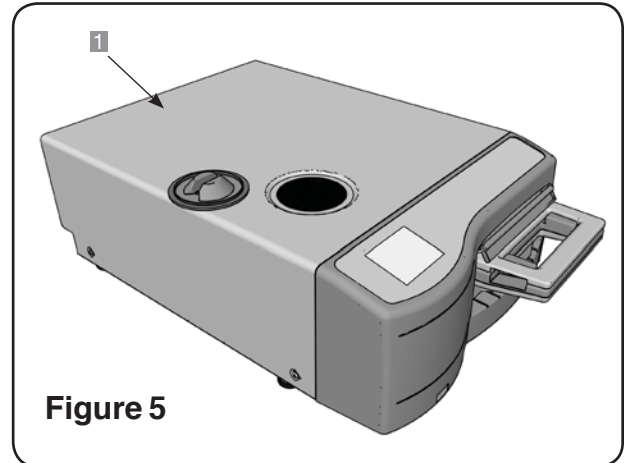

Figure 5

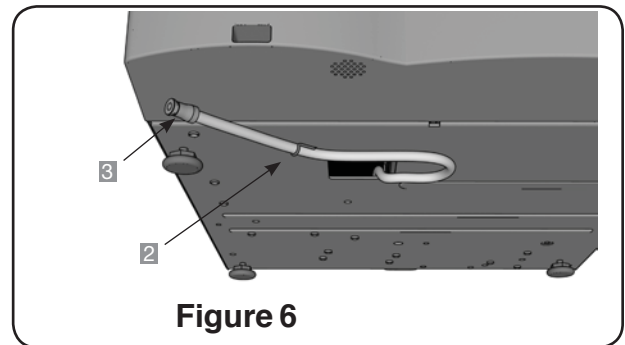

Figure 6

! Make sure the plug in the drain tube is secured.

After installation, and before sterilizing any instruments, run two Wrapped cycles. For further instructions, see Section Preparing the Unit for Use.







3.6 Shipping the Unit

Before you move the unit, you will need to drain the reservoir. To do so, follow these steps:





1. Place a water container below the unit.
2. Using the drain tube (see Section Priming the Pump, Figure 6) empty the contents of the reservoir into the water container.
3. Remove any remaining water from the reservoir with a non-linting, absorbent towel.
4. Screw-in the three leveler feet found underneath the unit.
5. Repack the unit in the original packing materials and include all accessories originally included with the unit.
6. Specify heated and insured shipping.

3 Setting up your STAT/M

3.7 Setting the Time



1. 
2. Scroll to and select.
3. From the TIME screen, use the keypad to set the time. Press to save and  to return to the Setup menu.
4. To change your unit to display 12-hour time format (24-hour time format is the default setting), go to the Setup menu and use  to scroll to TIME 12/24, select it and toggle to 12. Press  to save and return to the Setup menu.
5. To activate daylight savings time (DST), which is recommended if you have connected your unit to a network, go to the Set up menu and use  to scroll to DST ON/OFF and select. Use  to toggle DST ON or OFF and press the  to save and return to the Setup menu.

3.8 Setting the Date

1. 
2. Scroll to and select.
3. From the DATE screen, use the keypad to set the date. Press to save and  to return to the Setup menu.
4. To change your format in which the date appears, return to the Setup menu and use  to scroll to DATE FORMAT. Select it, and follow the prompts to have the date displayed in the desired format. Press  to save and return to the Setup menu.



3.9 Setting the Language

The messages displayed by your STAT/M can be presented in a number of different languages. To change the current language, follow these steps:



1. 
2. Scroll to and select.
3. From the Language screen, press  to scroll through the list of languages. When you have found the desired language, press  to save your selection and return to the Setup menu.

3 Setting up your STATIM

3.10 Assigning Unit Identifier Number

1. 
2. Scroll to **Unit No** and select.
3. Using the keypad, select a maximum of 3 digits to be used as the unit's identifier number. Press **EN** to save and  to return to the Setup menu.

3.11 Creating a User ID and PIN

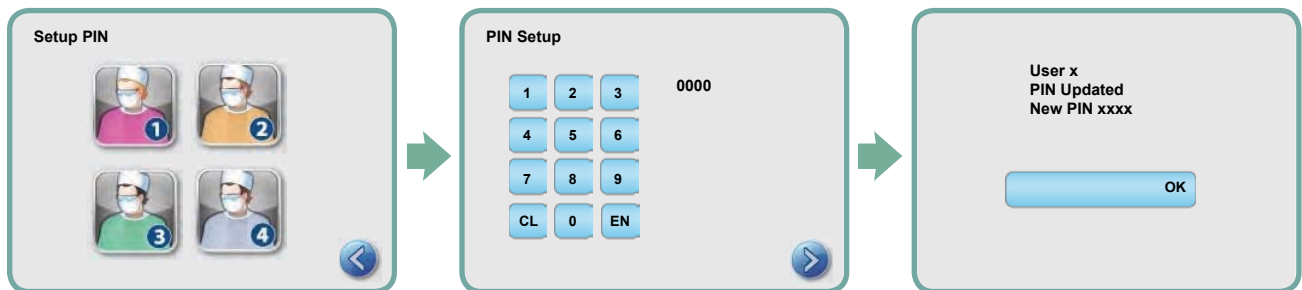

1. 
2. Scroll to **User** and select.
3. From the SETUP PIN screen, you can assign up to four PINs. Select one of the User icons to assign a PIN.
4. Using the keypad, assign a PIN of up to four digits and press **EN** to save and  to move to the confirmation screen.



5. If all of the information presented in the confirmation screen is correct, press OK to be returned to the PIN USER screen. To make a correction, select the PIN User you want to change and repeat the process described above.

3.12 Setting Up Process Enforced Usage

When process enforced usage is activated, users are required to enter a PIN both at the beginning and at the end of a cycle. For Process Enforced usage to function, User IDs and PINs must first be assigned. To set up User ID and PINs, refer to Section Creating a User ID and PIN. To activate Process Enforced usage, follow these steps:





1. 
2. Scroll to **Process Enforced** and select.
3. Use  to toggle Process Enforced function ON or OFF. Press  to save your selection and return to the Setup menu.

NOTE: Any user can stop a cycle and remove the cassette even with Process Enforced usage ON. However, the cycle data will record that an unauthorized user has stopped the cycle and/or removed the cassette.

3 Setting up your STATIM



3.13 Changing the Touchscreen Display Themes

Your STATIM G4 touchscreen themes (i.e. the colours of the icons and background) can be changed to one of the preset options or you can upload additional themes, as they become available from SciCan, using the USB port. To change themes follow these steps:

- 
- Scroll to **Themes** and select.
- From here, you can either select **Change Theme** for a menu of preloaded themes or **Upgrade Theme** to access a new theme that can be loaded using the USB port.
- In the **Change Theme** screen, use  to scroll through your available options. As you scroll, each theme will display on the touchscreen. Press  to select your theme and return to the Setup menu.
- To upgrade a theme available from SciCan, download the theme onto your computer's desktop and save the files onto a portable USB storage device. Insert the device into your STATIM's USB port and, from the UPGRADE THEME screen, press **Upgrade**.
 - The unit will load the files directly from the USB storage device. Do not remove the USB storage device while files are loading (this could take as long as 10 minutes). When it is complete, the screen will display the 'Done' message. This new theme will now be accessible from your THEMES menu.
 - Press  to select this theme and return to the Setup screen.



3.14 Adjusting the Screensaver Delay

To change the length of time before your inactive touchscreen activates the screensaver, follow these steps:

- 
- Scroll to **Screensaver** and select.
- Use  to scroll through your time options. When you have found the amount of time you require, press it. Press  to save and return to the Setup menu.

3.15 Adjusting the Screen Contrast

The STATIM G4 touchscreens are calibrated for the lighting condition of most sterilization centres. Should you need to adjust the contrast for your office, follow these steps:

- 
- Scroll to **LCD Contrast** and select.
- Use  to scroll through your contrast options. When you have found the contrast you require, press it. Press  to save and return to the Setup menu.

3 Setting up your STAT/M



3.16 Turning the Button Sound ON or OFF

The STAT/M G4 is preset to beep when a button is pressed. If you would like to turn the button sound off, follow these steps:

NOTE: Turning OFF the button sound does NOT turn off other alarms and cycle notification beeps.



2. Scroll to **Beep ON/OFF** and select.



3. Use  to scroll through your ON or OFF options and select it by pressing it. Press  to save and move back to the Setup menu.

3.17 Adjusting the Button Beep Volume

If you would like to adjust the beep volume, follow these steps:



2. Scroll to **Beep Volume** and select.

3. Use  to scroll through the volume settings. Select the one you want by pressing it. Press  to save and move back to the Setup menu.

3.18 Connecting to a Network

The STAT/M G4 has a 10/100Base-T Ethernet port located at the back of the unit. To connect your STAT/M to a network consult the separate manual titled STAT/M 2000/5000 G4 — Setting Up and Using Your Web Portal.

4 Using Cassettes and Preparing Instruments

4.1 Using the STAT/M 2000 G4 Cassette



When removing the cassette after a cycle, exercise caution as the metal areas will be hot and the cassette may contain hot steam.

- **Opening the Cassette:**

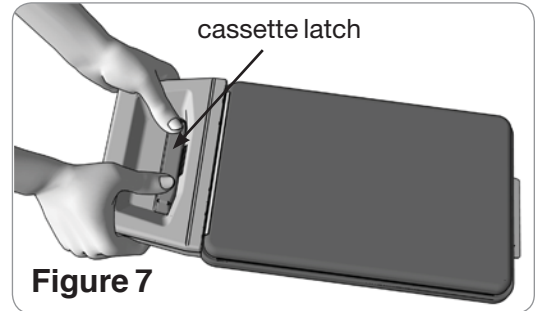

1. Hold the cassette handle with your thumbs facing inward on the cassette latch.
2. Push downward on the cassette latch.
3. Raise the cassette lid upwards and disengage the hinge.
4. Rest the lid on its outer surface.



- **Closing the Cassette:**

1. Align the hinge tab on the cassette lid with the hinge slot on the rear of the bottom tray.
2. As you begin to close the lid, the hinge tab and slot will engage.

- **Inserting the Cassette into the STAT/M 2000 G4:**

1. Place the end of the cassette into the unit.
2. Gently push inward until you hear a “click” sound and check the LCD icon for change from  to .



Never force the cassette into the STAT/M as the interior components could be damaged.

NOTE: The main menu screen will display  if the cassette is not properly inserted in the unit.

- **Removing the Cassette:**

1. Grasp the handle with two hands and pull away from the unit.
2. Pull the cassette clear of the unit and set down on a firm surface.

- **Disengaging the Cassette:**



When not in use, the cassette should be disengaged. To disengage the cassette, grasp the handle and pull the cassette out until there is a 15 mm to 20 mm ($\frac{1}{2}$ to $\frac{3}{4}$ ”) gap between the front of the STAT/M 2000 G4 and the cassette handle.

4 Using Cassettes and Preparing Instruments

4.2 Using the STAT/M 5000 G4 Cassette



When removing the cassette after a cycle, exercise caution as the metal areas will be hot and the cassette may contain hot steam.



- **Opening the Cassette:**

1. Push the carry handle **2** into the open position.
2. Put your hands on either side of the cassette handle **1**.
3. Insert your forefingers in the slots and place your thumbs on the thumb pads.
4. Press down with your thumbs and pull up with your forefingers until the lid opens.
5. Raise the cassette lid and disengage from the tray. Rest the lid on its outer surface.

- **Closing the Cassette:**

1. Align the hinge tab on the lid with the hinge slot on the tray.
2. As you begin to close the lid, the hinge tab and slot will engage.
3. Place the carry handle **2** into the closed position.

- **Inserting the Cassette into the STAT/M 5000 G4:**

1. Hold the cassette handle in one hand and the carry handle in the other as shown in Figure 8.
2. Place the end of the cassette into the unit and drop the carry handle into its closed position.
3. Gently push inward until you hear a “click” sound and check the LCD icon for change from  to .

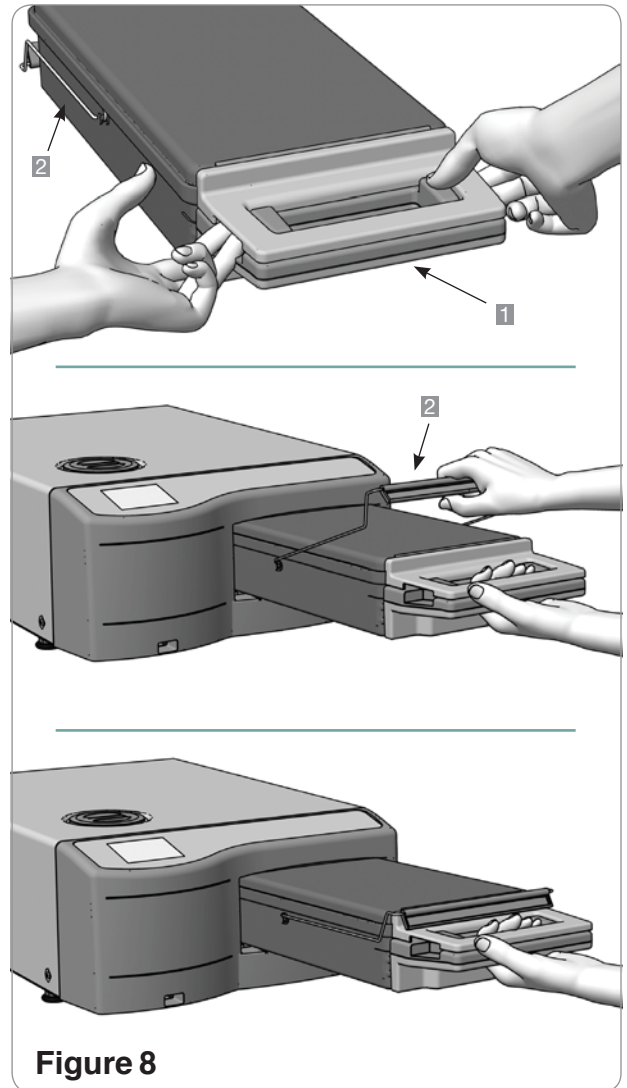

Never force the cassette into the STAT/M as the interior components could be damaged.

NOTE: The main menu screen will display  if the cassette is not properly inserted in the unit.

4 Using Cassettes and Preparing Instruments

- **Removing the Cassette:**

1. Grasp the cassette handle with one hand and pull out from the unit.
2. As the cassette emerges from the unit, grasp the carry handle with your free hand and lift it upwards.
3. Pull the cassette clear from the unit and set down on a firm surface.

- **Disengaging the cassette**



When not in use, the cassette should be disengaged. To disengage the cassette, grasp the handle and pull the cassette out until there is a 15 mm to 20 mm (1 / 2 to 3 / 4") gap between the front of the STAT/M 5000 G4 and the cassette handle.

4.3 Using Drying Plates with the STAT/M 5000 G4

The STAT/M 5000 G4 cassette comes with two racks, one with drying plates affixed and another without. To ensure optimal drying of instruments within autoclave bags use the rack with drying plates.

4.4 Preparing and Loading Instruments

Before loading any instruments into the STAT/M, consult the manufacturer's reprocessing instructions.

- **Clean Instruments**

Clean and rinse all instruments before loading them into the cassette. Disinfectant residues and solid debris may inhibit sterilization and damage the instruments, the cassette, and the STAT/M. Lubricated instruments must be wiped thoroughly and any excess lubricant should be removed before loading.

- **Unwrapped Instruments**



Arrange unwrapped instruments on the rack in the tray so that they do not touch one another. This ensures that steam reaches all surfaces and will promote drying.



Instruments must not be stacked or piled in the cassettes, as this will impede the sterilization process.

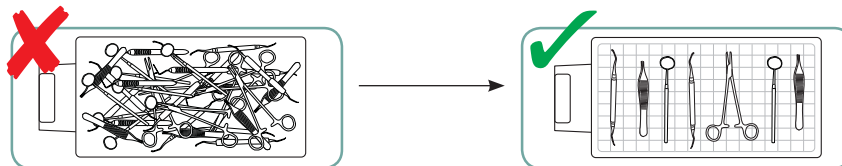

4 Using Cassettes and Preparing Instruments

- **Wrapped Instruments (single wraps)**



Place the instruments into single layer autoclave bags according to the manufacturer's instructions. Orient the instrument rack in the cassette to ensure that wrapped instruments rest approximately 6 mm / 0.25" above the cassette base. Place the wrapped instruments on the rack and arrange them to avoid overlap. Ensure that all wrapped loads are dry before handling and /or storage to maintain sterility.

! The use of cloth wraps in the STATIM is not recommended.

SciCan recommends the use of paper / paper and plastic / paper autoclave pouches. Pouches that have been cleared by the FDA for use with the respective cycle time and temperature of the STATIM 2000 / 5000 G4 Cassette Autoclaves must be used. The use of cloth wraps in the STATIM is not recommended. Loosely pack instruments in the bags to allow steam penetration to all instrument surfaces.

For STATIM 2000 G4:

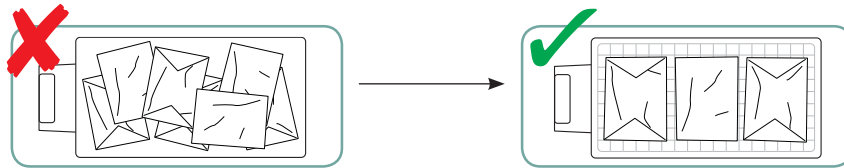

For STATIM 5000 G4:

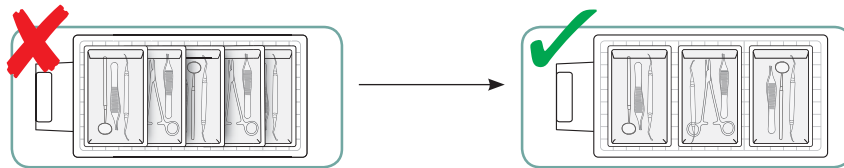

The rack with drying plates will hold 10 autoclave bags. Care must be taken to ensure that the combined weight of the loaded bags does not exceed 1.5 kg (3.3 lbs).

- **Rubber and Plastic Instruments**

The following materials can be sterilized in the STATIM:

Nylon, polycarbonate (Lexan™), polypropylene, PTFE (Teflon™), acetal (Delrin™), polysulfone (Udel™), polyetherimide (Ultem™), silicone rubber, and polyester.

! When loading rubber and plastic instruments in the tray, leave a space between the instruments and the cassette walls. This ensures that steam reaches all surfaces, and will promote drying.

4 Using Cassettes and Preparing Instruments



The following materials **CANNOT** be sterilized in the STAT/M:

Polyethylene, ABS, styrene, cellulose, PVC, Acrylic (Plexiglas™), PPO (Noryl™), latex, neoprene, and similar materials.



Use of these materials may lead to instrument or equipment damage. If you are unsure of your instrument's material or construction, do not load into your STAT/M until you have checked with the instrument manufacturer.

- **All Instruments**



The STAT/M is **NOT** intended for sterilizing textiles, liquids or biomedical waste. Instruments will remain sterile after a successful cycle until the cassette is disengaged from the unit. Unwrapped instruments, once exposed to ambient or external conditions, cannot be maintained in a sterile state. If sterile storage is desired, wrap the instruments to be sterilized in autoclave bags, according to the instrument manufacturer's instructions, and then allow the wrapped cycle to run until the air-dry phase is complete.

Best Practice: Allow instruments (wrapped or unwrapped) to dry completely prior to handling. Wrapped or pouched instruments must not touch each other to promote drying and enable effective sterilization.

SciCan recommends the final user carefully choose the most appropriate sterilization cycle according to the recommendations of their leading infection control authorities and local regulatory guidelines / recommendations.

- **Routine Monitoring**

Chemical process indicators suitable for steam sterilizers should be included in or on each package or load being sterilized. In addition, the weekly use of biological indicators, which allow you to ascertain whether the instruments have been exposed to sterilization condition, is recommended. Chemical and biological indicators that have been cleared by the FDA for use with the respective cycle time and temperature of the STAT/M 2000 / 5000 G4 Cassette Autoclaves must be used.

4.5 Using Biological and Chemical Indicators

For detailed instructions on how to handle, use and dispose of both the biological and chemical indicators, please consult the product literature accompanying the indicators or contact the manufacturer directly.

To use the indicators with the STAT/M, follow these steps:

1. Place the appropriate biological indicator in the STAT/M chamber.
2. Process the load in the sterilizer according to your usual practice.
3. Ensure that the message "Cycle Complete" is displayed on the LCD after the cycle is finished.
4. Recover the biological and / or chemical indicator and process further according to the literature that accompanied the indicator.

At the first indication of a potential sterilization failure:

1. Do not process any more instruments until favourable test results have been returned.
2. Ensure the correct indicator type was chosen.
3. Ensure the cassette was not overloaded. Consult the earlier portion of this section for proper loading instructions.
4. If the results do not change, do not process any more instruments within the STAT/M and contact your SciCan dealer for further assistance.

4 Using Cassettes and Preparing Instruments

It is recommended that the tests be conducted so that the incubation period occurs during a period of planned downtime such as the last cycle before a weekend.

4.6 Instrument Weight Guide

Instrument	Typical Instrument Weight
Scissors	30 g / 0.96 oz
Dental scalers	20 g / 0.64 oz
Forceps	15 g / 0.48 oz
Dental handpiece	40 to 60 g / 1.29 to 1.92 oz
Wrapped instrument rack	260 g / 8.35 oz
Unwrapped instrument rack	225 g / 7.23 oz
Suction cannula	10 g / 0.32 oz
Plastic mouth mirror	8 g / 0.25 oz
Impression tray	15 to 45 g / 0.48 to 1.45 oz
Plastic x-ray positioning ring	20 g / 0.64 oz

NOTE: The above weights are to be used as reference only. For exact weights of your instruments, consult the manufacturer's specifications.

5 Using your STATIM

Before using your STATIM for the first time, make sure the reservoir is full and the pump is properly primed. Refer to Sections Filling the Reservoir and Priming the Pump for detailed instructions.

5.1 Preparing Unit for Use

Once the unit is installed and before any instruments are sterilized, run two Wrapped Cycles (see Section STATIM 2000 / 5000 G4 - Running a Cycle. Remove the cassette once it has cooled. Clean the top (lid) and bottom (tray) sections using a soft cloth to wipe the inside surfaces and then rinse thoroughly with tap water.

5.2 STATIM 2000 G4 – Selecting a Cycle

The STATIM 2000 G4 has three sterilization cycles, each designed to sterilize a specific type of instrument. The instruments will remain sterile after a successful cycle until the cassette is removed from the autoclave. At the end of each sterilization cycle, microbiologically filtered air-drying will commence for 60 minutes by default. Air-drying can be interrupted at any time.

Unwrapped instruments, once exposed to ambient or external conditions, cannot be maintained in a sterile state. If sterile storage is desired, wrap the instruments to be sterilized in autoclave bags according to the instrument manufacturer’s instructions, and allow the wrapped cycle to run until the air-dry phase is complete.

The types of instruments, sterilization requirements, and a graph depicting each cycle are described over the next few pages. Consult the Instrument Weight Guide for information on how to make up an appropriate load for the masses specified for individual cycles.

5.2.1. Unwrapped Cycle (STATIM 2000 G4)



The Unwrapped Cycle is a general purpose sterilization cycle used to sterilize up to 1.0 kg (2.2 lbs) of solid metal instruments such as pliers, burs, scalers and forceps. Dental handpieces may be sterilized in this cycle.

To select the Unwrapped Cycle, press the Unwrapped Cycle button, then press the START button.

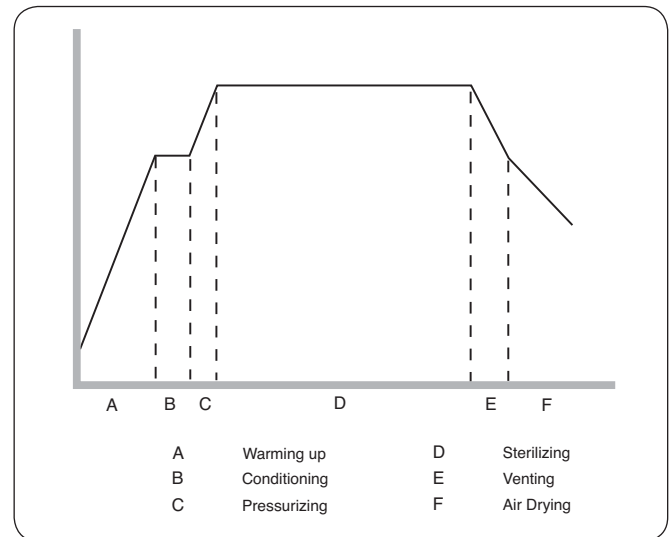

The sterilization temperature in the cassette is 134 °C (273 °F) and the holding time is 3.5 minutes. See Section STATIM 2000 G4 – Cassette, and Section Preparing and Loading Instruments before running this cycle.

5 Using your STATIM

5.2.2. Wrapped Cycle (STATIM 2000 G4)



The Wrapped Cycle is used to sterilize up to 1.0 kg (2.2 lbs) of solid and hollow metal instruments which have been sealed in paper / paper, or paper / plastic autoclave bags. Dental handpieces may be sterilized in this cycle.

To select the Wrapped Cycle, press the Wrapped Cycle button, then press the START button.

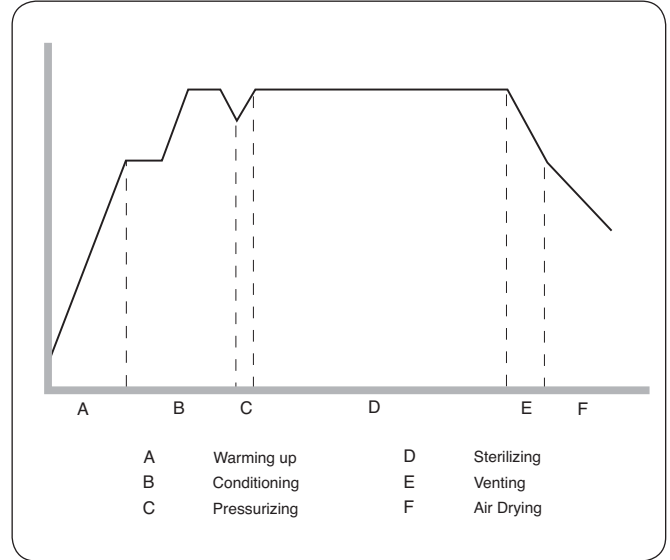
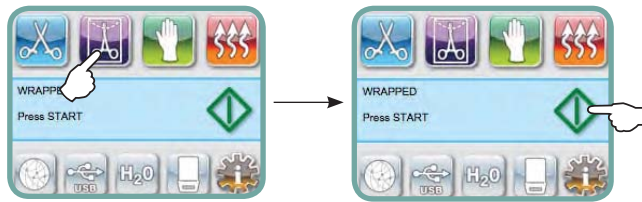

The sterilization temperature in the cassette is 134°C (273°F) and the holding time is 10 minutes. See Section STATIM 2000 G4— Cassette, and Section Preparing and Loading Instruments before running this cycle.

! If wrapped instruments are intended for storage, the wraps must be dry when the cassette is removed from the unit and opened.

5.2.3. Rubber and Plastics Cycle (STATIM 2000 G4)



The Rubber and Plastics Cycle is used to sterilize up to 0.4 kg (0.9 lbs) of solid unwrapped instruments constructed of metal or the materials listed in Section Preparing and Loading Instruments.

To select the Rubber and Plastics Cycle, press the Rubber and Plastics Cycle button, then press the START button.

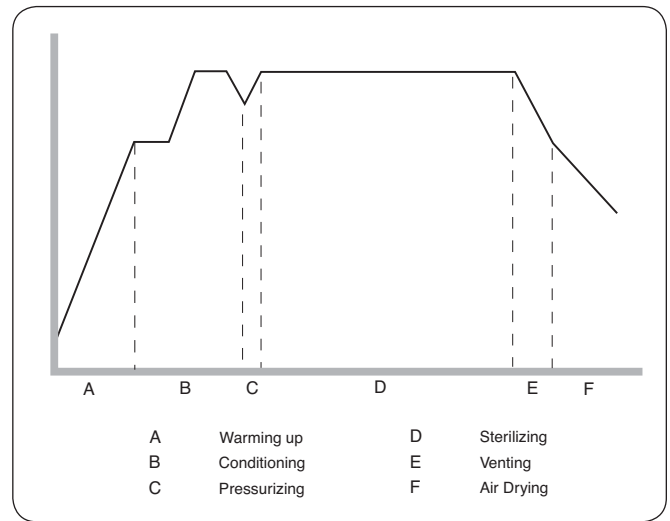
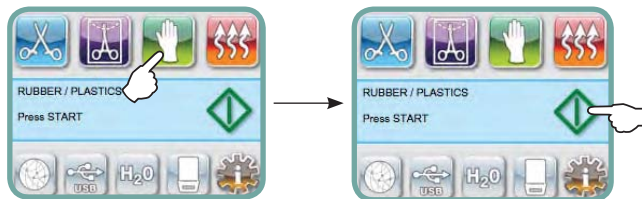

The sterilization temperature in the cassette is 121°C (250°F) and the holding time is 15 minutes.

5 Using your STATIM

5.2.4. Air Dry Only Cycle (STATIM 2000 G4)



This is not a sterilization cycle.



The load is considered sterile after the successful completion of the sterilization phase of the cycle. The Air Dry phase starts automatically after each sterilizing cycle and runs for 60 minutes. Air drying may be interrupted by pressing the STOP button anytime after the sterilization phase of the cycle is complete. To ensure that the contents of the cassette are dry, the cycle should run for the full 60 minutes. Dryness is important for unwrapped instruments for corrosion prevention. For wrapped instruments, a dry wrap is required to maintain sterility.

If the STOP button is pressed during the air drying stage of the sterilization cycle, and the cassette has not been removed from the autoclave, the Air Dry Only cycle may be used to promote further drying. If the cassette has been removed from the autoclave, it may NOT be reinserted for the Air Dry Only cycle. If the cassette contains wrapped instruments and the wraps are not dry when the cassette is opened, the instruments must be handled in an aseptic manner for immediate use or resterilized.

To start, press the Air Dry Only cycle button, then press the **START** button. User will be prompted to confirm cycle selection.



When started independently this cycle will run for 1 hour.

NOTE: Sterilized instruments should only be handled once they are dry. Drying times can vary depending on the weight of load. If best practices are exercised (refer to Sections 'Preparing and Loading Instruments' and 'Maintenance') and the load is less than the maximum capacity, instruments may be dry in less than 60 minutes.

5 Using your STATIM

Before using your STATIM for the first time, make sure the reservoir is full and the pump is properly primed. Refer to Sections Filling the Reservoir and Priming the Pump for detailed instructions.

5.3 STATIM 5000 G4 – Selecting a Cycle

The STATIM 5000 G4 has four sterilization cycles, each designed to sterilize a specific type of instrument. It is important not to overload the chamber as this can inhibit steam access to all instrument surfaces. The instruments will remain sterile after a successful cycle until the cassette is removed from the autoclave housing. At the end of each sterilization cycle, microbiologically filtered air-drying will commence for 60 minutes by default. Air-drying can be interrupted at any time.

Once unwrapped instruments are exposed to ambient or external conditions, they cannot be maintained in a sterile state. If sterile storage is desired, wrap the instruments to be sterilized in autoclave bags according to the instrument manufacturer’s instructions, and allow the wrapped cycle to run until the air-dry phase is complete.

The types of instruments, sterilization requirements, and graphs depicting each cycle are described on the next few pages. Consult the Instrument Weight Table in Section 4.6 for information on how to make up an appropriate load for the masses specified for individual cycles.

5.3.1. Unwrapped Cycle (STATIM 5000 G4)



The Unwrapped Cycle is used to sterilize light loads (less than 0.5 kg or 1.1 lbs) of solid metal instruments such as pliers, burrs, scalers, and forceps.

To select the Unwrapped Cycle, press the Unwrapped Cycle button, then press the START button.

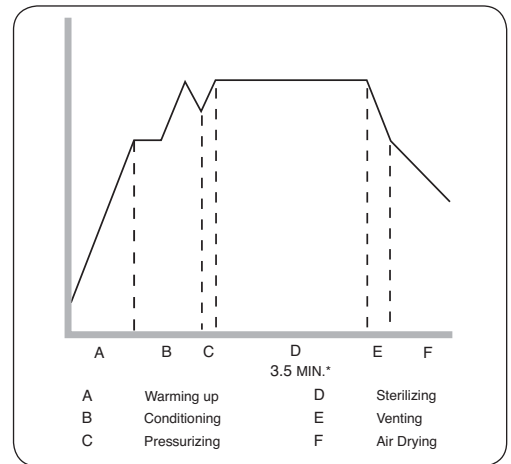
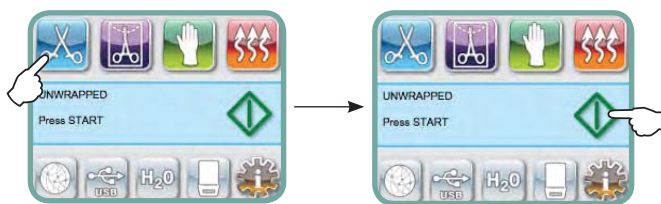

The sterilization temperature in the cassette is 132° C (270° F) and the holding time is 3.5 minutes. See Section STATIM 5000 G4 – Cassette and Section Preparing and Loading Instruments before running this cycle.

5 Using your STATIM

5.3.2. Wrapped Cycle (STATIM 5000 G4)



The Wrapped Cycle is used to sterilize up to 1.5 kg (3.3 lbs) of solid and hollow metal instruments which have been sealed in paper / paper, or paper / plastic autoclave bags. Dental hand pieces may be sterilized in this cycle.

To select the Wrapped Cycle, press the Wrapped Cycle button, then press the START button.

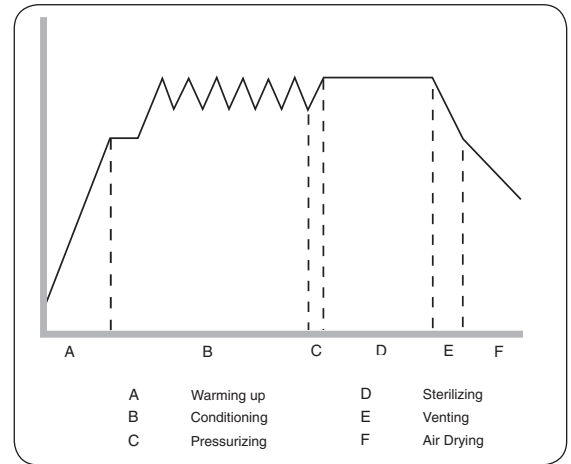
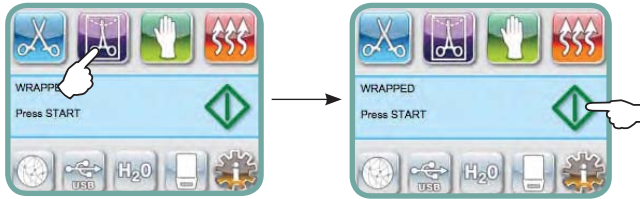

To select the Wrapped Cycle, press the Wrapped Cycle button, then press the START button. The sterilization temperature in the cassette is 132° C (270° F) and the holding time is 6 minutes. See Section STATIM 5000 G4— Cassette and Section Preparing and Loading Instruments before running this cycle.

! If wrapped instruments are intended for storage, the wraps must be dry when the cassette is removed from the unit and opened.

5.3.3. Rubber and Plastics Cycle (STATIM 5000 G4)



The Rubber and Plastics Cycle is used to sterilize up to 0.4 kg (0.9 lbs) of solid or hollow unwrapped instruments constructed of metal or the materials listed in Section 4.4 Preparing and Loading Instruments.

To select the Rubber and Plastics Cycle, press the Rubber and Plastics Cycle button, then press the START button.

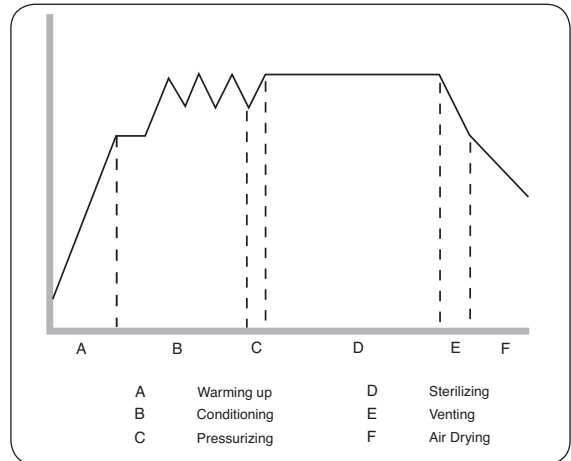
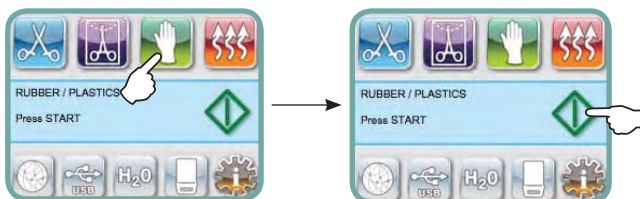

The sterilization temperature in the cassette is 121 °C (250 °C) and for the holding time is 35 minutes.

5 Using your STATIM

5.3.4. Heavy Duty Unwrapped Cycle (STATIM 5000 G4)



The Heavy Duty Cycle is used to sterilize larger loads of unwrapped metal instruments weighing up to 1.5 kg (3.3 lbs). Dental hand pieces can be sterilized in this cycle. Using the STATIM 5000 Extended Cassette (order no. 01-104104) will allow for the sterilization of rigid endoscopes in this cycle.

To select the Heavy Duty Unwrapped Cycle, press the Heavy Duty Unwrapped Cycle button, then press the START button.

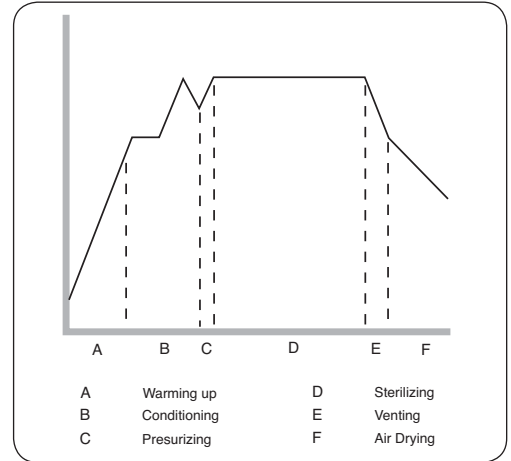

The sterilization temperature in the cassette is 132° C (270° F) and the holding time is 6 minutes.

5 Using your STATIM

5.4 STATIM 2000 / 5000 G4— Running a Cycle

To operate each cycle, follow these steps.

1. Turn the power switch at the back of the unit to ON.

At start up, the unit will display the main menu.



2. Press the appropriate cycle button on the touchscreen. The display will show the cycle name and parameters.
3. Press the START icon.



NOTE: If Process Enforced usage is enabled, a PIN screen will appear after you have pressed START. Enter your PIN to start the cycle.



5 Using your STAT/M

5.4 STAT/M 2000 / 5000 G4— Running a Cycle

When the cycle starts, the cycle parameters are displayed at the top of the screen.

Below it is the current phase. The unit's cycle counter is displayed at right.

A graph charts the progress of the cycle while current cycle information is displayed at right.

As the cycle is running, various sounds will be heard. This is the normal functioning of the unit.

Example of sterilization cycle phases in STAT/M 5000 G4:



5 Using your STATIM

5.4 STATIM 2000 / 5000 G4— Running a Cycle

As the cycle is running, an intermittent buzzing sound will be apparent as the pump injects water into the steam generator. A random clicking sound will also be heard as the exhaust valve opens and closes.

Once the sterilization cycle is complete, a reminder tone will sound as the cycle moves into the Air Drying phase.

The buzzing noise during the air drying stage is the compressor operating. The air drying phase of the cycle may be interrupted at any time by pressing the **STOP** button. The display will be similar to:

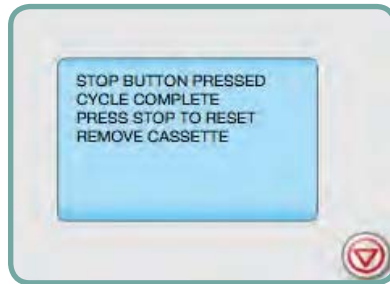

To ensure that wrapped instruments are dry, allow the cycle to run to completion.

If the cassette contains wrapped instruments and the wraps are not dry when the cassette is open, the instruments must be handled in an aseptic manner for immediate use or resterilized.

When the automatic 60-minute drying stage is finished the display reads::

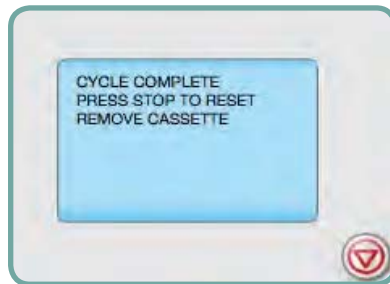

By default, if the sterilization cycle is successful, the reminder tone sounds for 30 seconds or until the **STOP** button is pressed, or the cassette is removed from the unit.



Be careful. The metal parts will be hot, and the cassette will contain hot steam. After the cassette is removed from the unit, it should be opened to hasten drying of unwrapped instruments.

5 Using your STATIM

If a message is displayed which gives a CYCLE FAULT code or a NOT STERILE message, the cassette contents are not sterile. See Section Troubleshooting for more information.

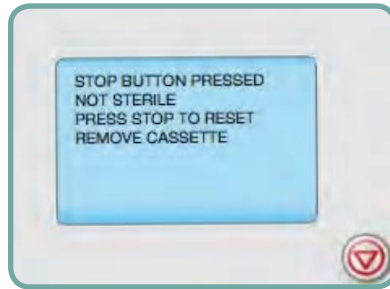

5.5 STATIM 2000 / 5000 G4— Stopping a Cycle

To stop a cycle press the **STOP** button. If the **STOP** button is pushed, the cassette is removed, or the unit detects a problem while operating, the cycle will stop. Once a cycle has been stopped, the **STOP** button must be pressed before another cycle can be started. The display reads any of the following messages:

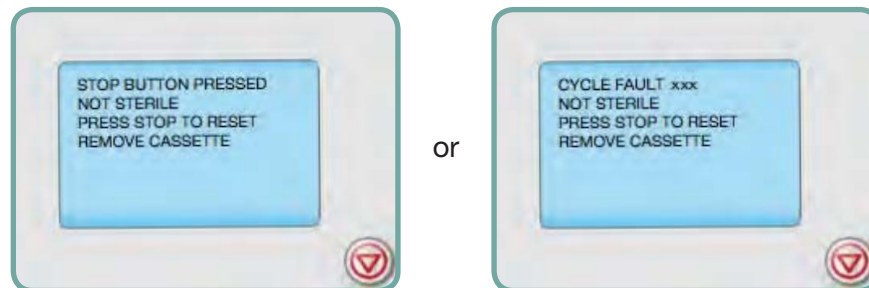

If the display shows the message, **CYCLE FAULT** or **NOT STERILE**, the cassette contents are not sterile! See Section Troubleshooting for more information.

If the cassette contains wrapped instruments and the wraps are not dry when the cassette is open, the instruments must be handled in an aseptic manner for immediate use and should not be stored.

6 Storing and Retrieving Cycle Information

The STAT/M G4 has an internal Data Logger capable of storing all cycle data on every cycle, whether successful or incomplete, for the lifetime of the unit. You can access this information through the touchscreen, through the web portal, using a USB storage device or by attaching a printer.

6.1 Retrieving Cycle Information Using the Touchscreen

1. From the main menu, press the USB icon.
2. The unit will record the last five successful cycles and the last five incomplete cycles. If you select a cycle from the list, it will display cycle information in a format similar to how it would be printed.
3. Use the arrow keys to scroll through and read.

NOTE: Regardless of whether you have a USB storage device attached to the unit or not, you can always see the last five successful cycles and the last five incomplete cycles. Use the STAT/M G4 web portal to access all the cycle information stored on your STAT/M from your computer. To connect your STAT/M to a network consult the separate manual titled STAT/M 2000/5000 G4 – Setting Up and Using Your Web Portal.

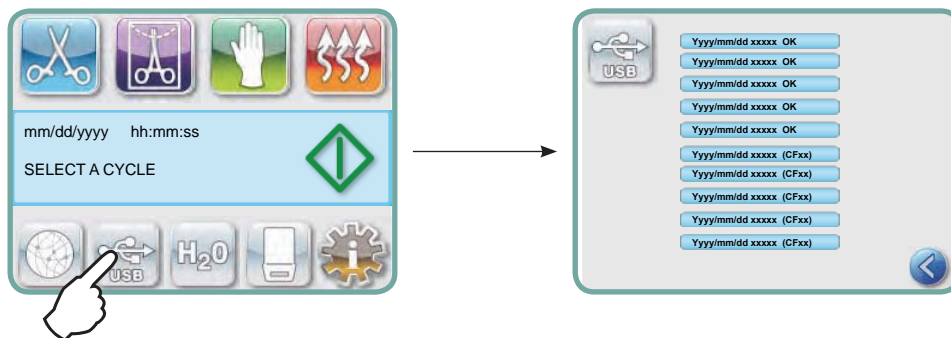

6.2 Retrieving Cycle Information Using the USB Data Back Up

The USB storage device can be used to transfer cycle information stored in the unit to a computer. Best practice suggests this should be done once a week. To transfer data using the USB port, follow these steps:

1. Plug the USB storage device into the USB port.
2. The STAT/M keeps track of what data has already been transferred to the USB storage device and will automatically load only new data.
3. When the activity light on the provided USB storage device stops blinking or the USB icon on the LCD turns from a flashing green to a solid grey, remove the USB storage device and transfer the information to your computer.

NOTE: If you select the USB storage device icon from the main menu, you will only be able to view the last five complete cycles and the last five incomplete cycles. To view all the cycles stored on the USB storage device, you must use your computer.

6 Storing and Retrieving Cycle Information

6.3 Cycle Printout Overview







Model: STATIM 2000 software: S201R604	STATIM 2000	S201R604
Unit Identifier: autoclave has been set up as number 000	UNIT #:	000
Water Quality: conductivity measurements	WATER QUALITY	1.3 µS / 13 ppm
Cycle Counter: the number of cycles having been run on the unit = 2	CYCLE NUMBER	000002
Time / Date: 10:47 am 25th October 2007	10:47	10/25/2007
Cycle Name: UNWRAPPED	UNWRAPPED	
Cycle Name cont'd - parameters: 135°C / 3.5 min.	135°C FOR 3.5 MIN.	
Cycle Clock: starting at 0:00	CYCLE START	0:00
Warm up complete: start of the conditioning phase is 1:19 (see cycle graph - 'A' phase complete, start of 'B' phase)	CONDITIONING	1:19
Start Time of Pressurization: 1:27 (start of 'C' phase)	PRESSURIZING	1:27
Start Time of Sterilization: 2:27 (start of 'D' phase)	STERILIZING	2:27
Temp. / Press. & Time at start of sterilization ('D' phase)	136.4°C 220KPA	2:27
Temp. / Press. & Time printed at 30 second intervals during sterilization. ("D" phase)	136.0°C 219KPA	2:57
	135.9°C 222KPA	3:27
	136.1°C 222KPA	3:57
	136.5°C 225KPA	4:27
	136.4°C 225KPA	4:57
	136.1°C 221KPA	5:27
Temp. / Press. & Time of end of sterilization phase (end of 'D' phase)	136.1°C 221KPA	5:57
Time Venting started: 5:57 (start of 'E' phase)	VENTING	5:57
Time Air Drying started: 6:42 (start of 'F' phase)	AIR DRYING	6:42
Cycle completion time: 22:42	CYCLE COMPLETE	22:42

7 Printing Cycle Information

The STAT/M G4 is equipped with an RS232 serial port to allow you to connect it to an external printer. (For a list of recommended printers, see the table below.)

7.1 Connecting to a Printer

To connect the printer, follow these steps:

1. Connect the external printer to the STAT/M G4's RS232 port using the serial printer cable supplied with your printer.
2. Power on the printer.
3. On the STAT/M G4, select  →  →  .
4. Scroll to and select.
5. Use   to toggle to the Serial Printer option and select. Press  to save and move back to the Setup menu.

7.2 Adjusting your Print Settings

The STAT/M G4 allows for several printer adjustments. You can access these settings from the user setup menu (see instructions above). Use the table below or your printer's operator manual to make the correct adjustments to your printer's , and .

7.3 External Printers and Specifications

Suggested External Printers by SciCan	End of Line CR/LF	Serial Port Bitrate	Printer user ° char
Epson TM-U220D (C31C515603)	CR/LF	9600	248 [0xF8]
Citizen IDP-3110-40 RF 120B	CR	9600	N / A
Star Micro SP212FD42-120	CR	9600	210 [0xd2]
Star Micro SP216FD41-120	CR/LF	9600	210 [0xd2]
Star Micro SP512MD42-R	CR/LF	9600	210 [0xd2]

8 Maintaining your STAT/M

8.1 Cleaning the Cassette

Keeping the STAT/M cassette clean is good clinical practice and assists in the function of the unit. SciCan recommends that the interior surface be cleaned at least once a week. Use dishwashing soap or a mild detergent that does not contain chlorine. Scrub the inside of the cassette with a cleaning pad designed for use with Teflon™ coated surfaces. After scouring, rinse thoroughly with water to remove all traces of the detergent. Cleaning the inside of your cassette is very important if you regularly sterilize lubricated instruments.

8.2 Cleaning the Water Reservoir Filter

The water reservoir filter should be cleaned at least once a week or when required. The filter can easily be removed and cleaned by placing the filter upside down under running water to wash away the particles until clean, and then placed back into the reservoir opening. If a replacement water reservoir filter is required, order part number 01-109300S.

8.3 Cleaning the Reservoir

Check the reservoir for dirt or particles. The reservoir may be cleaned by draining followed by cleaning and rinsing with steam process distilled water ONLY. Use of chemicals or cleaning agents is not recommended and could cause the unit damage.

8.4 Cleaning the Exterior Surfaces

Use a soft cloth moistened with soap and water to clean all exterior surfaces. Do not use harsh cleaning chemicals or disinfectants.

8 Maintaining your STAT/M

8.5 Changing the Bacteria Retentive Filter and the Air Filter

The filters should be replaced every six months or after 500 cycles to maintain an adequate supply of clean air during the air drying cycle.

To change the bacteria retentive air filter on the STAT/M 2000 G4 and 5000 G4, follow these steps:

1. Power the STAT/M OFF.
2. Disconnect tube A **1** from the bacteria retentive filter **2** and remove the filter from the filter bracket **3**. As you remove the filter from the bracket, note the orientation of the arrow mark on the filter.
3. When the filter is free of the bracket, carefully disconnect tube B **4** from the filter.
4. Before installing the replacement bacteria retentive filter **2** (SciCan order no. 01-102119S) check that the arrow mark on the filter matches the direction of the arrow on the bracket. Push the left hand filter fitting into tube B **4**.
5. Gently press the replacement filter into the filter bracket **3**. The arrow mark of the filter should be facing out and pointing to the left.
6. Re-connect tube A **1** to the right hand filter fitting.

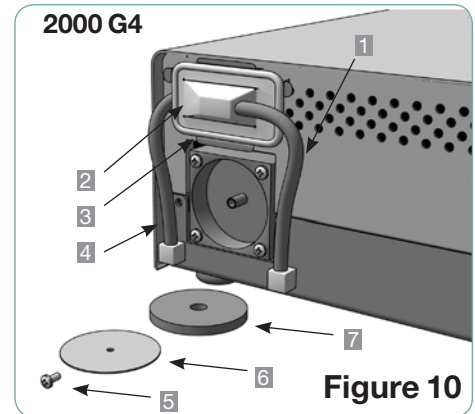

To change the air filter on the STAT/M 2000 G4, follow these steps:

1. Turn the power switch at the back of the unit OFF.
2. Remove and discard the old foam air filter **7**.
3. Install the new filter **7** (SciCan part no. 01-100207S).
4. Secure the filter plate **6** to the back of the compressor using the screw **5** retained during the disassembly procedure.

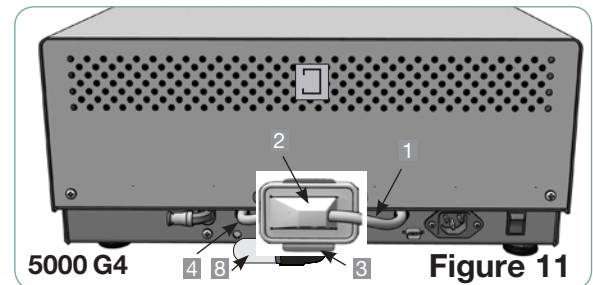

To change the air filter on the STAT/M 5000 G4, follow these steps:

1. Unscrew the cylindrical air filter **8** in a counter-clockwise direction.
2. Discard the old filter.
3. Screw the new filter (SciCan part no. 01-101652S), finger tight only, into place.

8 Maintaining your STATIM

8.6 Replacing the Cassette Seal

To ensure optimum performance of your STATIM cassette autoclave, change the cassette seal every 500 cycles or every six months, whichever comes first. Replacement seals are available from SciCan (order number 01-100028S for STATIM 2000 G4 and 01-101649S for STATIM 5000 G4).

To change the cassette seal, follow these steps:

Place the cassette lid and the new seal on a clean work surface. Examine the position of the old seal in the cassette lid and arrange the new seal in the same orientation, next to the lid.

Remove the old seal and discard. Clean any residue out of the seal channel and flush out the channel with distilled water.

Lubricate the new seal with the liquid seal lubricant provided.

Insert the rounded edge of the seal under the round lip of the lid. Align the holes in the new seal with the holes in the lid.

NOTE: At every corner and at the holes in the lid, two square nibs should be visible. The nibs should fit flush with the lid's outer surface.

Ensure the seal is completely inserted. Feel around the periphery to ensure the seal is securely in place.

NOTE: During a cycle, steam may appear between the lid and the tray. If this persists, remove the cassette and check that the seal is correctly installed.

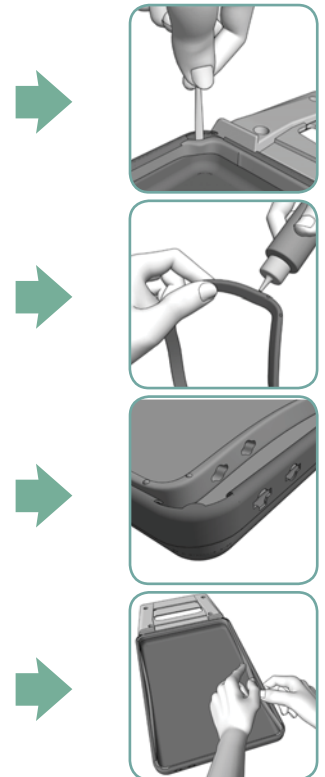



Figure 13





Be careful. The metal parts will be hot, and the cassette may contain hot steam.

8 Maintaining your STAT/M

8.7 Maintaining Fluid Levels

1. The water reservoir level is continually monitored by your STAT/M. If the reservoir is low, a red X will appear on the water icon  of the cycle select screen. Press the icon to go to the next screen to confirm that it is a water level issue and not a water quality issue.
2. If the reservoir is low, a  will appear next to WATER LEVEL.
3. To fill the reservoir, use only steam-processed distilled water containing less than 5 ppm total dissolved solids (having conductivity of less than 10 $\mu\text{S} / \text{cm}$). Remove the cap from the top of the unit and fill the reservoir. We recommend using a funnel to minimize spills. Each time you refill the reservoir, empty the waste bottle and refill with water to the MIN line. Empty the waste bottle often to avoid unpleasant odors and discoloration of the contents. (A low-level chlorine-free disinfectant, prepared according to the manufacturer's instructions, may be added to the waste bottle to remedy this situation).

8.8 Reading Water Quality

1. The water quality is continually monitored by your STAT/M to ensure that only steam-process distilled water is being used. If the water quality is beyond the tolerances specified above, a red X will appear on the water icon  of the cycle select screen. Press the icon to go to the next screen to confirm that it is a water quality issue and not a water level issue.
2. If the water quality not suitable,  will appear next to micro S. and parts per million values.
3. Using the drain tube (see Section Priming the Pump, Figure 6) empty the contents of the reservoir into the water container and replace with steam-process distilled water containing less than 5 ppm total dissolved solids (having conductivity of less than 10 $\mu\text{S} / \text{cm}$).

8 Maintaining your STATIM

8.9 Preventative Maintenance Schedules



To ensure trouble-free performance, both the operator and the dealer must follow a preventative maintenance schedule.



NOTE: Please refer to your National, Regional, State or Safety laws for any additional reoccurring user testing that may be required.

The schedules below describe the necessary actions.



Operator		
Daily	Water Reservoir	<ul style="list-style-type: none"> Replace water as needed. For ophthalmic use, drain after each working day, leave empty, and refill at the start of the next workday.
	Waste Bottle	<ul style="list-style-type: none"> Empty the waste bottle every time you refill the reservoir. Fill with tap water up to MIN line marking. You may also add some chlorine-free disinfectant.
Weekly	Cassette	<ul style="list-style-type: none"> Wash the interior of the cassette with dishwashing soap or a mild detergent that does not contain chlorine. Scrub the inside with a cleaning pad designed for use with Teflon™-coated surfaces..
	Biological and / or Air Filter	<ul style="list-style-type: none"> Check the filter for dirt and moisture. Replace if dirty. Call for service if wet.
	Water Filter	<ul style="list-style-type: none"> Check the water reservoir filter every week and clean if necessary. Replace only if necessary.
Every 6 months	Cassette Seal	<ul style="list-style-type: none"> Replace every 500 cycles or six months (whichever comes first), or whenever necessary
	Biological and / or Air Filter	<ul style="list-style-type: none"> Replace every 500 cycles or six months (whichever comes first).

Technician		
Once a year	Cassette	<ul style="list-style-type: none"> Check the tray, lid and seal for damage. Replace if necessary.
	Biological Filter	<ul style="list-style-type: none"> Inspect the biological filter for moisture.
	Solenoid Valve	<ul style="list-style-type: none"> Inspect the valve and clean if dirty. Replace the plunger if defective.
	Pump	<ul style="list-style-type: none"> Clean the filters, replace if dirty.
	Check Valve	<ul style="list-style-type: none"> Remove the exhaust tube from the back of the unit during the air drying phase. Check for air coming from the fitting. Remove the air compressor tube from the check valve inlet while running a cycle. Make sure no steam is leaking from the valve. Replace if there are any leaks.
	Water Reservoir	<ul style="list-style-type: none"> Check the reservoir for dirt. Clean and rinse with steam process distilled water if necessary.
	Calibration	<ul style="list-style-type: none"> Calibrate the unit.

9 Troubleshooting your STATIM

Problem	Solution
Unit does not power ON.	<p>Check that the unit is plugged into a properly grounded outlet and that the power cord is firmly seated at the rear of the machine.</p> <p>Try another circuit. Power unit OFF for 10 seconds and then power ON again.</p> <p>Check the condition of the line circuit breaker or fuse.</p>
There is water under the machine.  	<p>Check that water was not spilled when refilling the reservoir. Make sure the plug in the exhaust tube is secured. Remove and reinsert the cassette. Attempt another cycle.</p> <p>Be careful. The metal parts will be hot, and the cassette will contain hot steam.</p> <p>The cassette is leaking. If water drips from the underside of the unit during operation, check the cassette seal for misalignment or damage and replace the seal if required.</p> <p>Be careful. The metal parts will be hot, and the cassette will contain hot steam.</p> <p>Attempt another cycle. If it still leaks attempt another cycle using a different cassette if possible.</p> <p>If the leak persists, turn the unit OFF, remove and unload the cassette, unplug the unit, and call your dealer.</p>
Instruments do not dry.	<p>Best drying occurs when the cycle continues to completion. Allow the cycle to finish. Make sure the instruments are loaded correctly in the cassette. Refer to Section Using Cassettes and Preparing Instruments.</p> <p>Check the unit leveling.</p> <p>Check air/biological filters and replace if dirty.</p> <p>Examine the exhaust tube (tube to the waste bottle) for kinks. If kinked, straighten the tube. If the tube cannot be straightened, remove it from the push-in fitting attached to the STATIM. Depress the collar on the fitting and with the other hand pull firmly on the tube. Once the tube is free of the fitting, cut the damaged section of tubing away using a sharp instrument. Be sure that you leave enough tube to reach the unit when you re-attach the tube to the exhaust fitting. If the tube is too short to remove a section, contact your SciCan dealer for a replacement.</p> <p>Make sure the compressor is working. To check, remove the exhaust tube from the waste bottle. Start the Air Drying Only Cycle, and place the free end into a glass of water. If there is not a strong, steady flow of bubbles, the compressor is not functioning properly. Contact your SciCan dealer.</p>

9 Troubleshooting your STAT/M

Problem	Solution
<p>Cycle interrupted – NOT STERILE, Cycle aborted – NOT STERILE and CYCLE FAULT messages.</p> 	<p>Wait a few minutes and attempt another cycle before proceeding to the next solution. Remove the cassette.</p> <p>Be careful. The metal parts will be hot and the cassette will contain hot steam.</p> <p>Inspect the cassette to ensure that the holes in the back of the seal are perfectly aligned, and that the flexible lip of the seal is completely free. Check the exhaust tube for kinks or obstructions. If kinked, straighten the tube. If the tube cannot be straightened, remove it from the push-in fitting attached to the STAT/M. Depress the collar on the fitting and, with the other hand pull firmly on the tube. Once the tube is free of the fitting, cut the damaged section of tubing away using a sharp instrument. Be sure that you leave enough tube to reach the unit when you re-attach the tube to the exhaust fitting. If the tube is too short to remove a section, contact your SciCan dealer for a replacement.</p> <p>Check that the STAT/M has not inadvertently been exposed to any electrical interference. Refer to Section Positioning and Powering your Unit.</p> <p>Try running another cycle. If the problem persists, record the cycle fault message number and contact your dealer.</p>
<p>Excessive steam issuing from the front of the machine.</p> 	<p>Remove and reinsert the cassette. Attempt another cycle. Remove and check the cassette seal for misalignment or damage. Replace the seal if required.</p> <p>Be careful as the metal parts will be hot and the cassette will contain hot steam.</p> <p>If the leak persists, turn the unit OFF, remove and unload the cassette and contact your SciCan dealer.</p>
<p>Machine will not start and touchscreen shows:</p> 	<p>Press on the icon to confirm whether it is a water level problem or a water quality problem.</p> <p>If it is a water quality problem, you have likely used water which is not steam-process distilled or is improperly distilled.</p> <p>Empty the reservoir and refill with steam-process distilled water containing less than 5 ppm total dissolved solids (having conductivity of less than 10 $\mu\text{S} / \text{cm}$). If you have the water conductivity meter, check the quality of the water before refilling the reservoir. To empty the reservoir, see Section Shipping the Unit.</p> <p>If the level of the water in the reservoir is low, refill the reservoir. Refer to the steps described in Section Filling the Reservoir.</p>
<p>The printer does not work.</p>	<p>Make sure that the printer cable is connected securely with the connector on the back of the STAT/M. Make sure that the printer is powered ON. Power unit OFF for 10 seconds and then power ON again.</p>

9 Troubleshooting your STAT/M

Problem	Solution
Time and date are incorrect.	The time and date have not been set. See Section Setting up your STAT/M, for time and date instructions.
Touchscreen is blank/white.	Power was interrupted during a firmware upgrade. Power off the unit and power it on again. It can take up to 6 minutes before the main menu screen appears.
Touchscreen is blank/ dark.	Check power source.
USB storage device does not contain the last print out.	<p>Re-insert the USB storage device and wait for the data to copy over again.</p> <p>If problem persists, back up all the information you have on the USB device and reformat it.</p> <p>NOTE: You can always access all your unit's cycle information through the unit's web portal.</p>
<p>Touchscreen shows:</p> 	<p>An X over the connectivity icon means the unit is not connected to a network. If it is supposed to be connected to a network and the X is visible, it is because the unit is unable to acquire an IP address. To resolve the issue, try some of the following:</p> <ul style="list-style-type: none"> • Check that the router is functioning properly • Check the LAN cable (try a new cable if possible) • Make sure your router assigns IP addresses automatically. <p>Renew the IP address by following these steps:</p> <ol style="list-style-type: none"> 1. Scroll through the setup menu to NETWORK SETUP and select. 2. Select RENEW IP.
Unit is not sending emails.	<p>Check email settings by using the TEST button on the unit's web portal. From the SETUP web page, select the TOOLS tab. Click on TEST to check your router, unit, and Internet connections. If all settings appear to be OK. Go to the unit's touchscreen and renew the IP address by following these steps:</p> <ol style="list-style-type: none"> 1. Scroll through the setup menu to NETWORK SETUP and select. 2. Select RENEW IP.
Not receiving emails from the unit	Check your spam filter. Be certain the unit has been identified as an accepted email source.

10 Ordering Spare Parts

STATIM G4 SPARES	
01-100028S	Cassette Seal (2000)
01-112409S	Cassette Lid (2000 G4)
01-112410S	Cassette Handle - Lid (2000 G4)
01-103945S	Rack-tray Unwrapped Instr. Kit (2000)
01-101649S	Cassette Seal (5000)
01-112386S	Cassette Lid (5000 G4)
01-112387S	Cassette Handles Tray / Lid (5000 G4)
01-112388S	Cassette Handle - Lid (5000 G4)
01-112511S	Cassette Lid (5000 Ext G4)
01-112512S	Cassette Handles Tray / Lid (5000 Ext G4)
01-112513S	Cassette Handle - Lid (5000 Ext G4)
XXXX	Reservoir Cap
01-101787S	Reservoir Cap and Filter
01-100812S	Condenser Bottle
01-100724S	Condenser Bottle w/o Condenser
01-100735S	Waste Water Bottle Fitting
01-100204S	Exhaust Tube
01-100207S	Compressor Filter (2000)
01-101652S	Air Compressor Filter (5000)
01-102119S	Filter Biological
01-109300S	Water Reservoir Filter Kit
01-104343S	Plug - Drain Tubing
01-100780S	Bumper
01-101647S	Power Cord North America

STATIM G4 ACCESSORIES	
01-112406S	Cassette Complete (2000 G4)
01-112408S	Cassette Tray (2000 G4)
01-112407S	Cassette Tray with Mesh Rack (2000 G4)
01-106653	Mesh Rack - STATIM 2000
01-112384S	Cassette Complete (5000 G4)
01-112385S	Cassette Tray (5000 G4)
01-112509S	Cassette Complete (5000 Ext G4)
01-112510S	Cassette Tray (5000 Ext G4)
01-101709S	Mesh Rack (5000)
01-106325	Container Endoscope Complete (STATIM 5000)
01-103935	Drying Plates (Qty 5) STATIM 5000
01-103923	Condenser Additional Bottle

11 Warranty

Limited Warranty

For a period of one year, **SciCan** guarantees that the STAT/M 2000 / 5000 G4, when manufactured by **SciCan** in new and unused condition, will not fail during normal service due to defects in material and workmanship that are not due to apparent abuse, misuse, or accident.

The one year warranty will cover the performance of all components of the unit except consumables such as the cassette seal, the compressor filter and the microbiological filter, provided that the product is being used and maintained according to the description in the user's manual.

In the event of failure due to such defects during this period of time, the exclusive remedies shall be repair or replacement, at **SciCan's** option and without charge, of any defected part(s) (except gasket), provided **SciCan** is notified in writing within thirty (30) days of the date of such a failure and further provided that the defective part(s) are returned to **SciCan** prepaid.

This warranty shall be considered to be validated, if the product is accompanied by the original purchase invoice from the authorized **SciCan** dealer, and such invoice identifies the item by serial number and clearly states the date of purchase. No other validation is acceptable. After one year, all **SciCan's** warranties and other duties with respect to the quality of the product shall be conclusively presumed to have been satisfied, all liability therefore shall terminate, and no action or breach of any such warranty or duty may thereafter be commenced against **SciCan**.

Any express warranty not provided hereon and any implied warranty or representation as to performance, and any remedy for breach of contract which, but for this provision, might arise by implication, operation of law, custom of trade or course of dealing, including any implied warranty of merchantability or of fitness for particular purpose with respect to all and any products manufactured by **SciCan** is excluded and disclaimed by **SciCan**. If you would like to learn more about **SciCan** products and features, visit our website at www.scican.com.

12 Specifications

12.1 STAT/M 2000 G4

Machine Dimensions:	Length:	495 mm (19.5")
	Width:	415 mm (16.3")
	Height:	150 mm (5.9")
Cassette Size (External):	Length:	410 mm (16") (includes handles)
	Width:	195 mm (7.7")
	Height:	40 mm (1.6")
Cassette Size (Internal):	Length:	280 mm (11")
	Width:	180 mm (7.1")
	Height:	35 mm (1.4")
Sterilization Chamber Volume:		1.8 L (61 fl. oz.) U.S.
Reservoir Volume:		4.0 L (140 fl. oz.) U.S.
Weight (Without water):		21 kg (46 lbs)
Clearance required:		
	Top:	50 mm (1.9")
	Sides:	50 mm (1.9")
	Back:	50 mm (1.9")
	Front:	480 mm (18.9")
Maximum Steam Temperature:		138°C (280°F)
Maximum Operating Pressure:		341kP abs (49.5 psia)
Electrical Rating* (+/- 10%):		100 V, 50 / 60 Hz, 11A 110 V, 50 / 60 Hz, 11A 220 - 240 V, 50 / 60 Hz, 6 A
*see serial number label for requirements specific to your unit.		
Ethernet Port:		10/100 Base-T
USB Port:		USB 2.0
Protection Class:		I
Protection:		covered (indoor use only)
Ambient Operating Temperature and Humidity:		15°C to 25°C (59°F to 77°F) and 25% to 70%
Max. Altitude:		Up to 2000 meters (6600 ft)
Installation Category:		1

12 Specifications

12.2 STAT/M 5000 G4

Machine Dimensions:	Length:	600 mm (23.6")
	Width:	410 mm (16.1")
	Height:	190 mm (7.5")
Cassette Size (External):	Length:	495 mm (19.5") (includes handles)
	Width:	195 mm (7.7")
	Height:	80 mm (3.2")
Extended Cassette Size (External):	Length:	565 mm (22.2")
	Width:	195 mm (7.7")
	Height:	80 mm (3.2")
Cassette Size (Internal):	Length:	380 mm (15")
	Width:	180 mm (7.1")
	Height:	75 mm (3")
Extended Section (L x W x H):	110mm (4.3") x 130 mm (5.1") x 16 mm (0.6")	
Sterilization Chamber Volume:	5.1 L (170 fl. oz.) U.S.	
Reservoir Volume:	4.0 L (140 fl. oz.) U.S.	
Weight (Without water):	33 kg (73 lbs)	
Clearance required:	Top:	50 mm (1.9")
	Sides:	50 mm (1.9")
	Back:	50 mm (1.9")
	Front:	570 mm (22.4")
Maximum Steam Temperature:	138°C (280°F)	
Maximum Operating Pressure:	341kP abs (49.5 psia)	
Electrical Rating* (+/- 10%):	100 V, 50 / 60 Hz, 11A 110 V, 50 / 60 Hz, 11A 220 - 240 V, 50 / 60 Hz, 6 A	
*see serial number label for requirements specific to your unit.		
Ethernet Port:	10/100 Base-T	
USB Port:	USB 2.0	
Protection Class:	I	
Protection:	covered (indoor use only)	
Ambient Operating Temperature and Humidity:	15°C to 25°C (59°F to 77°F) and 25% to 70%	
Max. Altitude:	Up to 2000 meters (6600 ft)	
Installation Category:	1	