

EFFECTS OF THE CVP
UPON THE SOUTHERN DELTA WATER SUPPLY
SACRAMENTO-SAN JOAQUIN RIVER DELTA, CALIFORNIA

JUNE 1980

Prepared jointly by the
Water and Power Resources Service
and the South Delta Water Agency

State Water Resources Control Board
Bay-Delta Hearings Application No. 5626
PARTICIPANT: South Delta Water
Agency
EXHIBIT: SDWA048
INTRODUCED: 9/22/98
ACCEPTED IN EVIDENCE YES NO

REPORT
ON
EFFECTS OF THE CVP
UPON THE SOUTHERN DELTA WATER SUPPLY

THE PARTICIPATING PARTIES

THE U.S. WATER AND POWER RESOURCES SERVICE:

R. Keith Higginson, Commissioner
Billy E. Martin, Director, Mid-Pacific Region,

THE SOUTH DELTA WATER AGENCY:

Robert E. Ferguson, Chairman and Director
Albert Muller, Vice-Chairman and Director
Alex Hildebrand, Secretary and Director
Peter Alvarez, Director
Nat Bacchetti, Director

U.S. WATER AND POWER RESOURCES SERVICE STAFF

Mervin de Haas, Repayment Specialist
Donald Hebert, Hydraulic Engineer
George Link, Hydraulic Engineer
Harold Meyer, Hydraulic Engineer
David Schuster, Assistant Director, Operation
and Maintenance Policy Staff
Donald Swain, Civil Engineer

SOUTH DELTA WATER AGENCY STAFF

Alex Hildebrand, Secretary and Member of the
Board of Directors
Dr. Gerald T. Orlob, Engineer
John A. Wilson, Attorney

I N D E X

Chapter	Title	Page
I	INTRODUCTION AND DEFINITIONS	1
II	PURPOSES OF INVESTIGATION	5
III	DESCRIPTION OF THE SAN JOAQUIN RIVER SYSTEM, INCLUDING THE FEDERAL CENTRAL VALLEY PROJECT, THE SOUTHERN DELTA, AND DATA SOURCES	7
IV	INVESTIGATION PROCEDURE	21
V	WATER QUANTITY EFFECTS OF UPSTREAM DEVELOPMENT	29
VI	WATER QUALITY EFFECTS OF UPSTREAM DEVELOPMENT	69
VII	EFFECTS OF OPERATION OF CVP & SWP EXPORT PUMPS NEAR TRACY	149

<u>Figure No.</u>	<u>Title</u>
III-1	General Map
III-2	South Delta Water Agency
III-3	San Joaquin River Basin Stream Flow Gaging Stations
III-4	San Joaquin River Basin Water Quality Sampling Stations
III-5	Water Level Stations in the Southern Delta
V-1	Cumulative Runoff at Vernalis for April-September Period
V-2	Cumulative Actual Runoff San Joaquin River Above Merced River, MAF
V-3	San Joaquin River Near Vernalis Annual Flow
V-4	San Joaquin River Near Vernalis Flow
V-5	Upper San Joaquin River During April-Sept. Period
V-6	Actual Monthly Runoff Measured at Vernalis
V-7	Actual Monthly Runoff Above Merced River
V-8	Actual Monthly Runoff Measured at Vernalis
V-9	San Joaquin River Near Vernalis Dry years Flow Duration
V-10	San Joaquin River Near Vernalis Below Normal Flow Duration
V-11	San Joaquin River Near Vernalis Above Normal Years Flow Duration
V-12	San Joaquin River Near Vernalis Wet Years Flow Duration
V-13	Vernalis Flow Requirement vs Estimated Contribution to Vernalis Reduction Below Flow Requirement Due to Development in upper San Joaquin October through March
V-14	Vernalis Flow Requirement vs Estimated Contribution to Vernalis Reduction Below Flow Requirement Due to Development in Upper San Joaquin April through September
V-15	Vernalis Flow Requirement vs Estimated Contribution to Vernalis Reduction Below Flow Requirement Due to Development in Upper San Joaquin Annual Total

<u>Figure No.</u>	<u>Title</u>
VI-1	San Joaquin Valley System
VI-2	Concentrations of Principal Cations in the San Joaquin River and Its Major Tributaries
VI-3	Concentrations of Principal Anions in the San Joaquin River and Its Major Tributaries
VI-4	Sulfate Concentration in San Joaquin River System
VI-5	Noncarbonate Hardness in San Joaquin River System
VI-6	Boron Concentration in San Joaquin River System
VI-7	Average Monthly Salt Load (TDS) as a Function of Unimpaired Runoff at Vernalis - October
VI-8	Average Monthly Salt Load (TDS) as a Function of Unimpaired Runoff at Vernalis - January
VI-9	Average Monthly Salt Load (TDS) as a Function of Unimpaired Runoff at Vernalis - April
VI-10	Average Monthly Salt Load (TDS) as a Function of Unimpaired Runoff at Vernalis - July
VI-11	Quality-Flow Relationships San Joaquin River at Vernalis - October
VI-12	Quality-Flow Relationships San Joaquin River at Vernalis - January
VI-13	Quality-Flow Relationships San Joaquin River at Vernalis - April
VI-14	Quality-Flow Relationships San Joaquin River at Vernalis - July
VI-15	Chloride Salt Load vs Runoff, Tuolumne River at Tuolumne City, Pre-1950
VI-16	Chloride Salt Load vs Runoff, Tuolumne River at Tuolumne City, Post-1949
VI-17	Sample of Computer Printout Salt Balance Computation
VI-18	Chloride Salt Balance--San Joaquin River System, 1960-61

<u>Figure No.</u>	<u>Title</u>
VI-19	Sulfate Salt Balance for San Joaquin River System, 1960-61
VI-20	Noncarbonate Hardness Salt Balance San Joaquin River System, 1960-61
VI-21	Boron Salt Balance--San Joaquin River System, 1960-61
VI-22	Relationship Between Total Dissolved Solids at Vernalis and Chlorides at Mossdale
VI-23	Observed Chlorides at Mossdale and Estimated Total Dissolved Solids at Vernalis 1929-1971
VI-24	Water Quality and Flow Extremes at Vernalis 1930-1966
VI-25	Mean Monthly TDS at Vernalis by Decades 1930-1969
VI-26	Mean Monthly TDS (MG/L) vs Mean Monthly Runoff (KAF) for Four Decades, 1930-1969
VI-27	Mean Monthly TDS at Vernalis by Decades 1930-1969
VI-28	Mean Monthly TDS (MG/L) vs Mean Monthly Runoff (KAF) for Two Decades, 1930-1949, Based on Chloride Load-Flow Relationships
VI-29	Quality-Flow Relationships Tuolumne River
VI-30	Quality-Flow Relationships Tuolumne River, 1938-1969 (August-October)
VI-31	Relative TDS Concentration at Vernalis by Decades, 1930-1969
VI-32	Relative TDS Salt Load at Vernalis by Decades, 1930-1969
VI-33	Relative TDS Concentration at Vernalis by Decades, 1930-1969
VI-34	Relative Salt Load at Vernalis by Decades, 1930-1969
VI-35	Relative Runoff at Vernalis by Decades, 1930-1969

<u>Figure No.</u>	<u>Title</u>
VII-1	South Delta Channel Depth Surveys
VII-2	Channel Properties, Old River, Clifton Court to San Joaquin River
VII-3	Cumulative Hydraulic Resistance in Old River, Clifton Court to San Joaquin River
VII-4	Water Levels and Channel Characteristics Old River--South Delta
VII-5	Depression in HWL at Clifton Court Relative to Middle River at Bacon Island as a Result of CVP Export Pumping at Tracy
VII-6	Water Levels in Southern Delta, 20-21 June 1972
VII-7	Ratio of Flow at Two Locations on San Joaquin River as Influenced by Delta-Mendota Canal Pumping
VII-8	Total Dissolved Solids in the South Delta Channels July 1976

APPENDICES

<u>Appendix No.</u>	<u>Title</u>
1	Monthly flow data (KAF) and monthly chloride data (p/m)
2	Chloride load-flow regression curves
3	Salt (chloride) balances by representative months
4	Summary of network analysis of the lower Sacramento-San Joaquin Delta

EFFECTS OF THE FEDERAL CVP UPON THE QUALITY AND
VOLUME OF THE INFLOW OF THE SAN JOAQUIN RIVER TO
THE SACRAMENTO-SAN JOAQUIN DELTA AND UPON THE
IN-CHANNEL WATER SUPPLY IN THE SOUTHERN DELTA

CHAPTER I

INTRODUCTION AND DEFINITIONS

Over the last several years in the course of the discussions between representatives of the South Delta Water Agency (SDWA) and representatives of the United States Water and Power Resources Service (Service), formerly the United States Bureau of Reclamation (USBR), the parties have found that the available technical data relative to the impact of the Federal Central Valley Project (CVP) upon the San Joaquin River inflow to the Sacramento-San Joaquin Delta (Delta) and the effect of the operation of the Federal CVP and California State Water Project (SWP) export pumps near Tracy on the in-channel water supply in the southern Delta was limited and had never been thoroughly studied and evaluated.

At a meeting held in Washington, D.C., on July 17, 1978, attended by representatives of the Department of the Interior, a technical analysis and evaluation of the effect was authorized and undertaken. The State Department of Water Resources of the State of California (DWR) was invited to participate and did so to a limited extent. Since July, 1978, the technical staffs of the SDWA and the Service have engaged in a detailed study of subject matter, and committees representing the participating parties, from time to time, met for the purpose of reviewing progress of the technical advisors and generally directing the areas in which technical research should be conducted.

The purpose of this document is to set forth a report by the SDWA and the Service of the factual technical findings and the conclusions to this date resulting from such research and studies.

For purposes of this report, where substantial areas of disagreement exist between the SDWA and the Service on the interpretation of data, the differences will be noted and the differing views of the parties set forth.

In order to facilitate brevity and to assist in the understanding of this report, the following definitions are intended unless the context or express provision requires otherwise.

1. "South Delta Water Agency" (SDWA) is an agency created by the South Delta Water Agency Act (Cal. Stats. 1973, c. 1089, p. 2207) for the purposes therein described.

2. The "United States Water and Power Resources Service" (Service) is the agency responsible for the operation of the Federal Central Valley Project (CVP). Prior to November 6, 1979, this agency was known as the United States Bureau of Reclamation (USBR).

3. "Southern Delta" is defined as the area within the boundaries of the SDWA as defined in Cal. Stats. 1973, c. 1089, p. 2214, sec. 9.1 (California Water Code Appendix Chapter 116).

4. "Central Valley Project" (CVP) is defined as the Federal Central Valley Project in California.

5. "State Water Project" (SWP) is the State Water Resources Development System as defined in Section 12931 of the California State Water Code.

6. The "Delta Mendota Canal" (DMC) is a conveyance facility of the CVP by means of which water is exported from the Delta near Tracy and delivered on the west side of the San Joaquin Valley and to the Mendota pool in the San Joaquin River.

7. The "State Aqueduct" is a conveyance facility of the SWP by means of which water from the Delta is exported through Clifton Court Forebay near Tracy to the San Joaquin Valley and Southern California.

8. "Export Pumps" are defined as the CVP and SWP pumps located at the diversion point of the DMC and the State Aqueduct. They are operated as part of the CVP and the SWP for the purpose of diverting and exporting from the Delta via the canals.

9. "Delta" or the "Sacramento-San Joaquin Delta" is defined as all of the lands within the boundaries of the Sacramento-San Joaquin Delta as described in Section 12220 of the Water Code of the State of California on January 1, 1974.

10. "New Melones Project" is the Federal project on the Stanislaus River authorized by Public Law 78-534, dated December 22, 1944, as modified by Public Law 87-874, dated October 23, 1962.

11. "Vernalis" is defined as the San Joaquin River gaging station just below the mouth of the Stanislaus River at the Durham Ferry Bridge.

12. "Pre-1944" is defined as the years 1930 to 1943, inclusive, unless otherwise indicated.

13. "Post-1947" is defined as the years 1948 to 1969, inclusive.

14. "Total Dissolved Solids" (TDS) is defined as the concentration in milligrams per liter of a filtered water sample of all inorganic or organic constituents in solution determined in accordance with procedures set forth in the publication entitled "Standard Methods for the Examination of Water and Waste Water" published jointly by the American Public Health Association, the American Water Works Association and the Water Pollution Control Federation, 13th Edition, 1971.

15. "Cubic Foot Per Second" (ft^3/s) or (CFS) is the flow of 1 cubic foot of water per second past a given point.

16. "p/m" or "ppm" is defined as parts per million, and is used synonymously with mg/L in this report.

17. "mg/L" is defined as milligrams per liter.
18. "KAF" is 1,000 acre-feet.
19. "Mendota Pool" is a small storage reservoir impounded by a diversion dam on the San Joaquin River about 30 miles west of Fresno into which the Delta-Mendota Canal discharges water conveyed from the Tracy Pumping Plant.
20. "Unimpaired Rim Flow" is defined as the sum of gaged flows, adjusted for upstream storage, at four stations on the major tributaries as follows:

SAN JOAQUIN RIVER AT FRIANT DAM
MERCED RIVER AT EXCHEQUER DAM
TUOLUMNE RIVER AT DON PEDRO DAM
STANISLAUS RIVER AT NEW MELONES DAM

The sum of these gaged flows is also used in this report as the Vernalis unimpaired flow.

21. The "Lower San Joaquin River" is defined as that portion of the San Joaquin River downstream of the mouth of the Merced River.
22. The "Upper San Joaquin River" is defined as that portion of the San Joaquin River and basin upstream of the mouth of the Merced River.

CHAPTER II

PURPOSES OF INVESTIGATIONS

The purpose of the investigation was to analyze and prepare a written report upon the following:

- (a) The effect of the operation of the CVP upon the San Joaquin River inflow (quality and volume) to the Delta;
- (b) The effect of the operation of the CVP export pumps near Tracy upon the in-channel water supply in the Southern Delta.

While all water supply development in the San Joaquin River basin has the effect of reducing the annual flow of the San Joaquin River at Vernalis, this report is directly concerned only with the effects of the CVP on the in-channel water supply in the southern Delta. The available data has been reviewed and analyzed to determine what, if any, changes have occurred affecting the southern Delta in-channel water supply since the CVP began operation in 1947. The two agencies preparing the report have not agreed on the legal obligation of the Federal Government to the southern Delta. In addition, there are several other issues on which agreement has not been reached and further discussion and study will be needed. Therefore, the report does not include consideration of the following:

1. Water rights, priorities, or legal status of any party related to the in-channel water supply in the southern Delta, including water users in the southern Delta.
2. Economic consequences of any impacts discussed on southern Delta agriculture and other uses.

3. Alternative solutions to improve the in-channel water supply in the southern Delta.
4. The impact on the Southern Delta in-channel water supply of the operation of the CVP New Melones Reservoir.

The impacts of developments other than the CVP affecting the in-channel water supply in the southern Delta have been attributed to specific other developments when such impacts are clearly identifiable. The impact of the operation of the SWP export pumps has been specifically included. The impacts other than CVP have been determined incidentally to the principal purposes of this report.

While development other than the CVP has occurred in the upper San Joaquin River basin (as defined in Chapter I) since 1947, it was assumed in the investigation that the impact of other development is negligible. Consequently, for this report, the effects on San Joaquin River inflow to the Delta (both quantity and quality) of all development in the upper San Joaquin River basin since 1947 are considered as effects due to the CVP.

CHAPTER III

DESCRIPTION OF THE SAN JOAQUIN RIVER SYSTEM
INCLUDING THE FEDERAL CENTRAL VALLEY PROJECT
THE SOUTHERN DELTA, AND DATA SOURCES

A. PRINCIPAL FEATURES

1. General

The San Joaquin River basin lies between the crests of the Sierra Nevada Mountains and the Coast Ranges, and extends north from the northern boundary of the Tulare Lake Basin near Fresno to the Sacramento-San Joaquin Delta (see Figure III-1). It is drained by the San Joaquin River and its tributary system. The basin has an area of about 14,000 square miles extending about 100 miles from the crest of Sierra Nevada Range to the crest of the Coast Ranges and about 120 miles from the northern to the southern boundary. The Sierra Nevada Mountains have an average crest elevation of about 10,000 feet with occasional peaks higher than 14,000 feet. The Coast Ranges crest elevations reach up to about 5,000 feet. The San Joaquin valley area measures about 100 miles by 50 miles and slopes gently from both sides towards a shallow trough somewhat west of the center of the valley. Valley floor elevations range from about 250 feet at the south to near sea level at the north. The trough forms the channel for the Lower San Joaquin River and has an average slope of about 0.8 foot per mile between the Merced River and Paradise Cut.

Major tributary streams, from north to south, are the Cosumnes, Mokelumne, Calaveras, Stanislaus, Tuolumne, and Merced Rivers. These streams, plus the San Joaquin River, contribute the major portion of the surface inflow to the valley. Minor streams on the east side of the valley are the Fresno and Chowchilla Rivers and Burns, Bear, Owens, and Mariposa Creeks. Panoche, Little

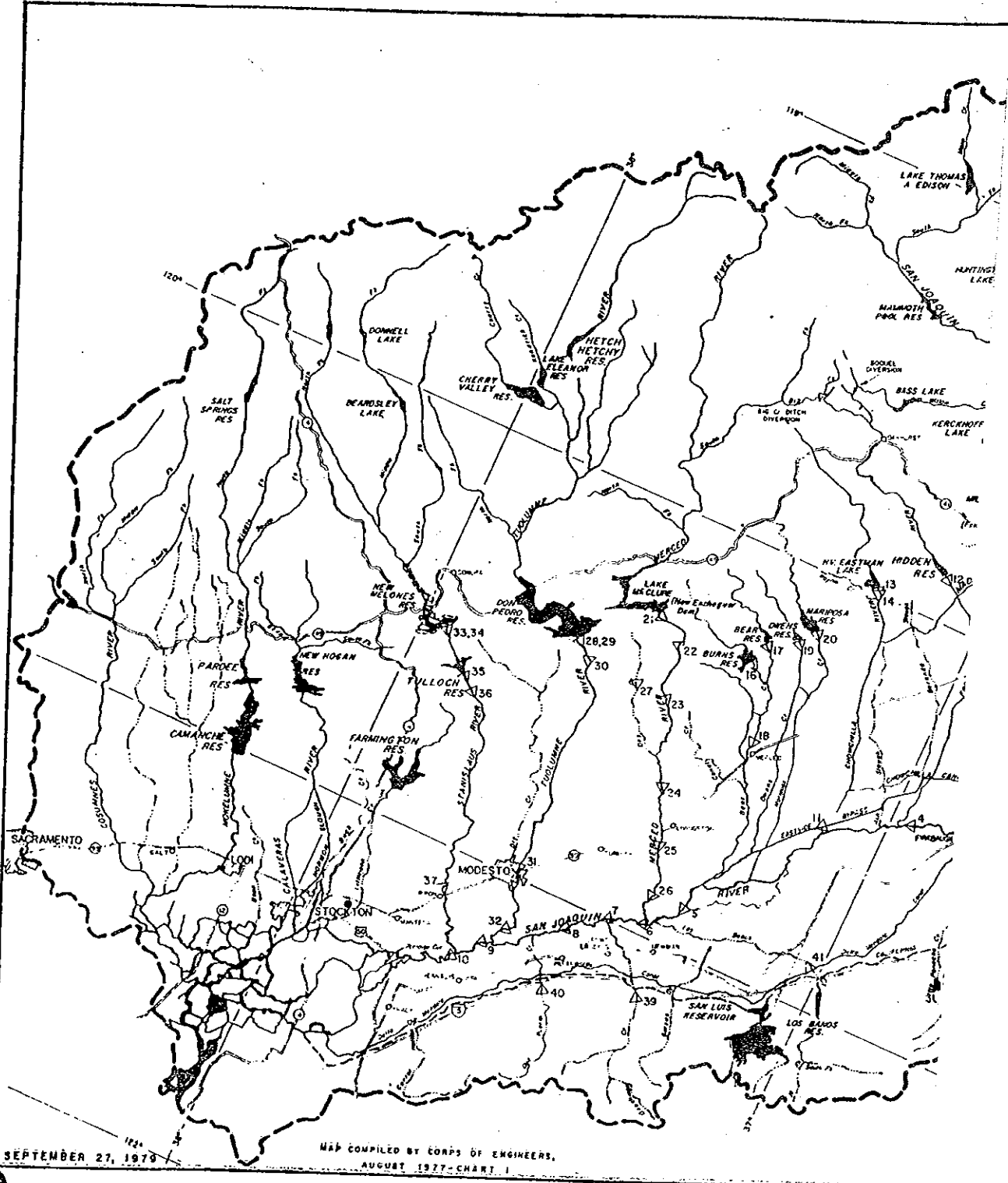

SEPTEMBER 27, 1970

MAP COMPILED BY CORPS OF ENGINEERS, AUGUST 1977-CHART 1

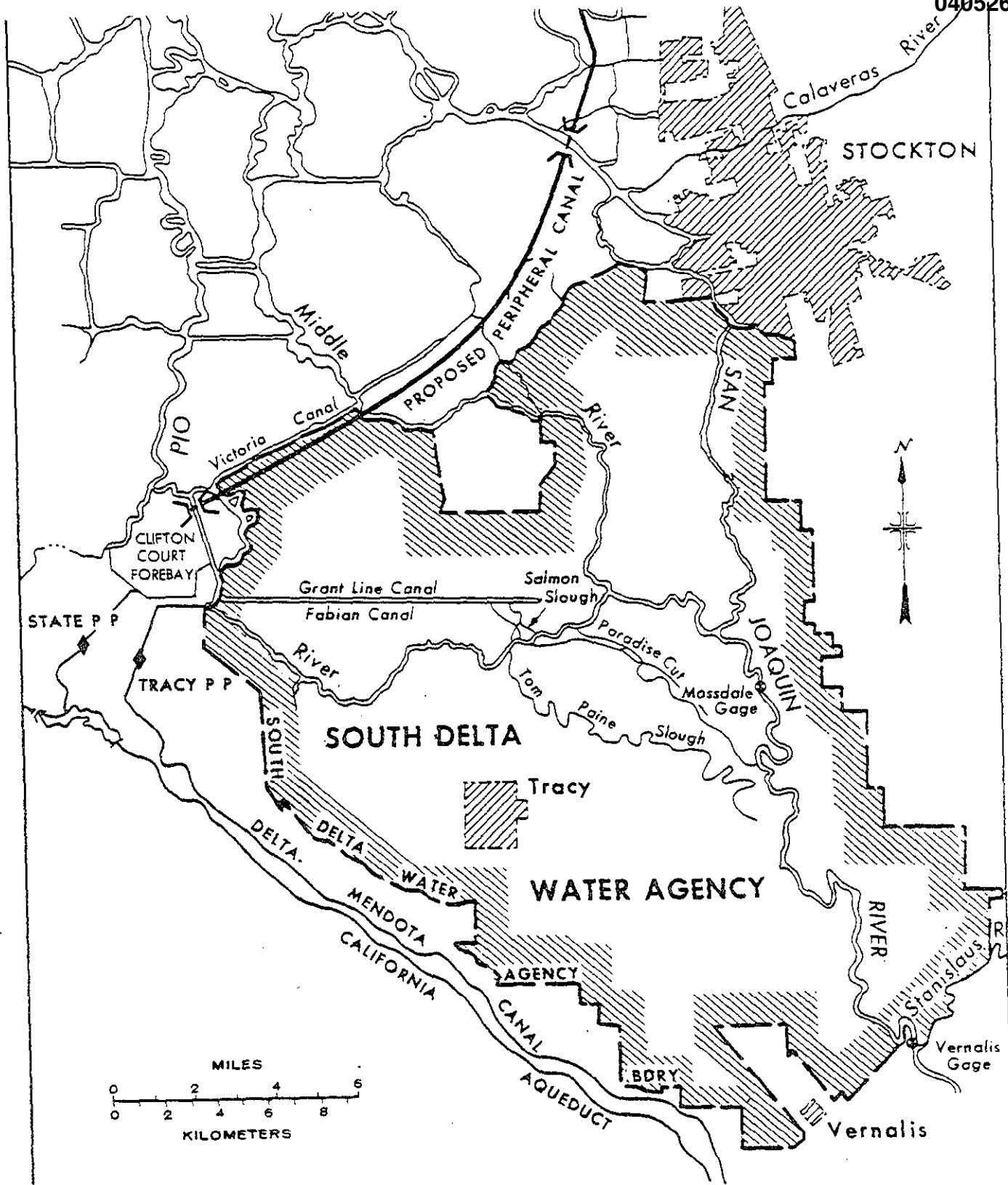

SOUTH DELTA WATER AGENCY

FIGURE III-2

Panoche, Los Banos, San Luis, Orestimba, and Del Puerto Creeks comprise the minor streams on the west side. These west side streams contribute very little to the runoff of the San Joaquin River. Numerous other small foothill channels carry water only during intense storms. During high runoff periods a distributary channel of Kings River (called James Bypass) discharges water into the San Joaquin River at Mendota. In addition, floodwater is diverted to the San Joaquin River from Big Dry Creek Reservoir near Fresno. Flows from rivers and creeks are significantly reduced by storage, diversions, and channel seepage losses as they cross the valley floor so that only a portion of the water at the foothill line reaches the San Joaquin River.

2. Southern Delta

The boundaries of the South Delta Water Agency (SDWA) are set forth in section 9.1 of the South Delta Water Agency Act (Cal. Stats. 1973, c. 1089, p. 2207). The area encompassed therein is located in the southeastern part of the Sacramento-San Joaquin Delta as illustrated in Figure III-2. It contains approximately 231 square miles or roughly 148,000 acres. Of this area, about 123,000 acres are devoted to agricultural uses and the remainder is comprised of waterways, levees, and lands devoted to residential, industrial and municipal uses. The area within SDWA is generally known as the Southern Delta.

The lands in the southern Delta are generally mineral soils with low permeability. The agricultural lands in the Southern Delta are fully developed, irrigated and highly productive. The agricultural lands are dependent primarily upon the in-channel water supply in the area for irrigation, and for irrigation purposes about 450,000 acre-feet per year are diverted from the channels.

There are about 75 miles of channels in the southern Delta and these are of great importance. They not only serve as water supply sources for irrigation,

but also as drainage canals for drainage water, important habitat and migration routes for fish, waterways for commercial shipping and recreational boating, and avenues for the passage of floodwaters.

3. Existing Water Resource Development

a. General

Development of the water resources of the San Joaquin River basin was initiated more than 120 years ago. This development ranges from small local diversions from the rivers and streams to large multiple-purpose reservoirs and extensive levee and channel improvements. Because of this development the flow regime of the San Joaquin River has significantly changed from that which would occur under natural conditions. The major reservoirs in the basin are tabulated below:

Major Reservoirs San Joaquin River Basin

<u>Name of Reservoir</u>	<u>Operating Agency</u>	<u>Year Completed</u>	<u>Purpose</u>	<u>Capacity (AF)</u>
Stanislaus River				
Union	PG&E	1902	P	2,000
Utica	PG&E	1908	P	2,400
Relief	PG&E	1910	P	15,600
Strawberry	PG&E	1916	P	18,300
Woodward	South San Joaquin I.D.	1918	I	36,000
*Melones	Oakdale & SSJ I.D.	1926	I,P	112,500
Spicer Meadows	PG&E	1929	P	4,100
Lyons	PG&E	1932	P	5,500
Beardsley	Oakdale & SSJ I.D.	1957	I,P	98,300
Donnells	Oakdale & SSJ I.D.	1958	I,P	64,700
Tulloch	Oakdale & SSJ I.D.	1958	I,P	68,200
New Melones	U.S.C.E.	1979	FC,I,P,P,F&W,WQ	2,400,000
Tuolumne River				
Modesto Reservoir	Modesto I.D.	1911	I	27,000
Turlock Lake	Turlock I.D.	1915	I	4,900
Lake Eleanor	City & Co. of S.F.	1918	M&I,P	26,100
Hetch Hetchy	City & Co. of S.F.	1923	M&I,P	360,000
Cherry Valley	City & Co. of S.F.	1956	M&I,P	268,000
**Don Pedro	Modesto & Turlock I.D.	1923	I,P	290,400
New Don Pedro	Modesto & Turlock I.D.	1971	FC,I,P,R	2,030,000

*Inundated by New Melones Reservoir.

**Inundated by New Don Pedro Reservoir.

Major Reservoirs
San Joaquin River Basin
(Cont'd)

<u>Name of Reservoir</u>	<u>Operating Agency</u>	<u>Year Completed</u>	<u>Purpose</u>	<u>Capacity (AF)</u>
Merced County Streams				
Yosemite Lake	Merced I.D.	1888	I	7,000
Mariposa	USCE	1948	FC	15,000
Owens	USCE	1949	FC	3,600
Burns	USCE	1950	FC	6,800
Bear	USCE	1954	FC	7,700
Merced River				
McSwain	Merced I.D.	1966	I,P,R	9,500
***Lake McClure	Merced I.D.	1926	I,P	280,900
New Exchequer	Merced I.D.	1967	FC,I,P,R	1,025,000
Chowchilla & Fresno Rivers				
Madera Lake	Madera Co.	1958	R	4,700
Hensley Lake	USCE	1975	FC,I,R	90,000
H.V. Eastman Lake	USCE	1975	FC,I,R	150,000
San Joaquin River				
Crane Valley	PG&E	1910	P	45,100
Huntington Lake	SCE	1917	P	89,200
Kerckhoff	PG&E	1920	P	4,300
Florence Lake	SCE	1926	P	64,400
Shaver Lake	SCE	1927	P	135,300
Millerton Lake	WPRS	1941	FC,I,M&I	520,500
Big Dry Creek	USCE	1948	FC	16,250
Redinger Lake	SCE	1951	P	35,500
Lake Thomas A. Edison	SCE	1954	P	125,000
Mammoth Pool	SCE	1960	P	123,000
Westside Streams				
Los Banos	WPRS/DWR	1966	I,M&I,P,R	34,600
Little Panoche	WPRS/DWR	1966	I,M&I,P,R	5,600
O'Neill Forebay	WPRS/DWR	1967	FC	56,400
San Luis	WPRS/DWR	1967	FC,R	2,041,000

*** Inundated by New Exchequer Reservoir

b. Irrigation Projects

Major irrigation canals consisting of the Delta-Mendota Canal and the California Aqueduct have been constructed to transport water from the

Sacramento-San Joaquin Delta to water deficient areas in the San Joaquin Valley, Tulare Lake Basin, and Southern California. These canals are located along the west side of the San Joaquin Valley and are shown on Figure III-1. Numerous irrigation distribution systems have been constructed throughout the valley floor area to convey irrigation water to the farms.

c. Delta Export Facilities

Central Valley Project

Tracy Pumping Plant. The Tracy Pumping Plant, located near Tracy at the southern edge of the Delta (Figure III-2) lifts water via an intake channel from Old River some 197 feet into the Delta-Mendota Canal. The six pumps at Tracy are capable of pumping a total of approximately 4,600 ft³/s. The plant has been operational since 1951. The pumping plant operates on demand and therefore diverts water from the Delta continuously regardless of tidal phase.

Delta-Mendota Canal. The Delta-Mendota Canal is a major canal of the Central Valley Project (CVP). It carries water south from the Tracy Pumping Plant along the west side of the San Joaquin Valley. In addition to water service along the canal, the canal is used both to transport water to the San Luis Unit of the CVP and to partially replace San Joaquin River water stored by Friant Dam and utilized in the Madera and Friant-Kern Canal systems. The canal and pumping plant began operation in 1951. The canal is 117 miles long and terminates at the San Joaquin River in the Mendota Pool near the city of Fresno. The conveyance capacity of the canal varies from 4,600 ft³/s at the intake to 3,200 ft³/s at its terminus.

State Water Project

Clifton Court Forebay. The Clifton Court Forebay (Figure III-2) is a 30,000 acre-foot reservoir. The forebay, completed in 1969, buffers the effects of aqueduct pumping on the Delta. It also provides forebay storage for the Delta Pumping Plant to permit a large part of the pumping to be done with offpeak power. Advantage is also taken of the high-tide elevations to admit water into the forebay.

Delta Pumping Plant. The unlined intake channel conveys water from Clifton Court Forebay to the Delta Pumping Plant. The Delta Pumping Plant lifts water from sea level to an elevation of 224 feet where it flows by gravity through the State Aqueduct to the San Luis Division. The pumping plant, completed in 1967, houses seven pumping units, providing an aggregate hydraulic capacity of 6,300 ft³/s. From the pump discharge lines, the concrete-lined State Aqueduct, with a capacity of 10,300 ft³/s, conveys water south to the service areas of the State Water Projects.

d. Interbasin Transfers

There are two major diversions from the San Joaquin Basin. The interbasin transfer from the Tuolumne River through the Hetch Hetchy aqueduct to the city of San Francisco began in October 1934. A record of these annual diversions from the Tuolumne Basin was obtained from the files of the city of San Francisco and are presented on Table III-2.

In 1950 diversions from the San Joaquin River through the Friant-Kern Canal to the Tulare Lake Basin were begun by Friant Division of the CVP. A year later, the CVP began to import water into the San Joaquin Basin from the Sacramento-San Joaquin Delta through the Delta-Mendota Canal. Records of these two diversions by the Service are published in the USGS Water Supply Papers.

TABLE III-2

HETCH HETCHY AQUEDUCT
DIVERSION FROM TUOLUMNE RIVER

<u>CALENDAR YEAR</u>	<u>ACRE-FEET</u>
1934	11,211
1935	38,843
1936	56,814
1937	7,236
1938	1,692
1939	53,233
1940	24,090
1941	18,965
1942	14,087
1943	25,333
1944	47,533
1945	60,241
1946	61,710
1947	69,356
1948	68,812
1949	67,443
1950	75,425
1951	81,450
1952	49,796
1953	94,492
1954	112,850
1955	124,699
1956	80,029
1957	123,619
1958	70,286
1959	167,325
1960	166,623
1961	17,438
1962	158,488
1963	127,020
1964	185,600
1965	164,738
1966	198,425
1967	182,170
1968	223,221
1969	197,844
1970	198,766
1971	213,277
1972	260,359
1973	205,556
1974	215,501
1975	228,551
1976	263,727
1977	222,734
1978	161,304

TABLE III-3

INTERBASIN TRANSFERS SAN JOAQUIN RIVER SYSTEM

	San Joaquin River at Friant		Friant-Kern Canal		Madera Canal		Delta-Mendota Canal at Tracy		Delta-Mendota Canal to Mendota Pool	
	1,000 AF		1,000 AF		1,000 AF		1,000 AF		1,000 AF	
	Annual	Apr-Sept	Annual	Apr-Sept	Annual	Apr-Sept	Annual	Apr-Sept	Annual	Apr-Sept
1938-39	1,077	616								
40	1,829	1,250								
41	2,589	1,255								
42	2,254	1,329								
43	2,068	1,281								
44	1,102	791			48	48				
45	1,885	1,364			110	106				
46	1,662	1,063			119	92				
47	1,155	816			102	76				
48	1,006	802			76	72				
49	1,068	838			152	150				
50	974	743	198	180	118	118				
51	1,216	588	368	345	142	140	164	164	139	139
52	2,084	1,570	462	431	179	179	167	141	122	99
53	351	184	741	592	193	179	784	714	668	615
54	262	138	811	717	212	207	1,004	852	825	720
55	107	57	805	674	219	199	1,131	945	927	780
56	1,225	462	1,322	976	239	226	726	592	519	429
57	149	54	990	793	242	229	1,181	968	920	761
58	1,180	1,067	1,145	952	244	238	663	548	447	367
59	79	57	809	536	208	169	1,341	1,066	1,029	814
60	96	67	582	429	144	124	1,389	1,089	1,009	786
61	100	57	442	324	103	91	1,489	1,189	1,021	817
62	75	46	1,370	1,151	277	268	1,357	1,144	991	837
63	85	58	1,513	1,300	270	262	1,344	1,037	966	744
64	70	48	838	543	228	187	1,667	1,240	1,066	7
65	63	40	1,631	1,051	324	285	1,472	1,075	995	736
66	62	45	1,066	628	442	173	1,599	1,259	1,060	819
67	1,269	1,185	1,413	1,047	389	351	1,258	865	572	340
68	58	41	967	503	170	114	1,997	1,476	1,032	787

A portion of the water imported through the Delta-Mendota Canal was delivered to the Mendota Pool in the San Joaquin River near Mendota to replace a portion of the water diverted from the basin at Friant Dam. Records of the amounts of water delivered to Mendota Pool were obtained from the Service files.

A listing of these interbasin transfers is presented on Table III-3.

4. Climate

The climate of the basin is characterized by wet, cool winters, dry, hot summers, and relatively wide variations in relative humidity. In the valley area relative humidity is very low in summer and high in winter. The characteristic of wet winters and dry summers is due principally to a seasonal shift in the location of a high pressure air mass ("Pacific high") that usually exists a thousand or so miles west of the mainland. In the summer the high blocks or deflects storms; in the winter it often moves southward and allows storms to reach the mainland.

a. Precipitation

Normal annual precipitation in the basin varies from 6 inches on the valley floor near Mendota to about 70 inches at the headwaters of the San Joaquin River. Most of the precipitation occurs during the period November through April. Precipitation is negligible during the summer months, particularly on the valley floor. The Sierra Nevada and Coast Ranges have a marked orographic effect on the precipitation. Precipitation increases with altitude, but basins on the east side of the Coast Ranges lie in a rain shadow and receive considerably less precipitation than do basins of similar altitude on the west side of the Sierra Nevada. Mean monthly and annual precipitation at several stations in the basin are tabulated below:

Average Monthly Precipitation (in.)

Station --	Dudleys	Merced	Sonora	So. Ent.	Stockton
		FS2	RS	Yosemite	WSO
Elev (ft)--	3000	169	1749	5120	22
Jan	7.05	2.24	5.69	8.23	2.91
Feb	5.87	1.92	4.88	7.09	2.11
Mar	5.74	1.74	4.92	6.39	1.96
Apr	3.87	1.41	3.19	4.50	1.37
May	1.28	.45	1.19	1.80	.42
Jun	0.44	.07	.33	.56	.07
Jul	.03	.01	.03	.08	.01
Aug	.05	.02	.05	.07	.03
Sep	.37	.11	.35	.57	.17
Oct	1.65	.55	1.49	2.03	.72
Nov	5.05	1.61	4.21	6.33	1.72
Dec	6.90	2.09	5.61	8.14	2.68
Mean Ann.	38.30	12.22	31.94	45.79	14.17

b. Snowfall

Winter precipitation usually falls as snow above the 5,000-foot elevation and as rain and/or snow at lower elevations. Snow cover below 5,000-feet is generally transient, and may accumulate and melt several times during the winter season. Normally the snow accumulates at higher elevations until about the first of April when the melt rates exceed snowfall. Surveys of the snowpack are conducted by the State of California starting in January of each year. Average April 1 water content at several snow courses is listed in the following tabulation*:

<u>Station</u>	<u>Basin</u>	<u>Elev (ft)</u>	<u>Ave. 1 April Water Content (in)</u>
Soda Cr. Flat	Stanislaus	7,800	22.0
Dana Meadows	Tuolumne	9,850	30.0
Snow Flat	Merced	8,700	42.0
Piute Pass	San Joaquin	11,300	35.0

*SOURCE: "Hydrology, lower San Joaquin River" office report Sacramento District, Corps of Engineers, December 1977.

5. Storm Characteristics

Winter storms affecting the area are cyclonic wave disturbances along the polar front and usually originate in the vicinity of the Aleutian Islands. The normal trajectory of the waves is toward the southeast; however, the storms producing the greatest amount of precipitation have maintained a more easterly trajectory across the Pacific Ocean. The Coast Range Mountains form a barrier that reduces the moisture in the airmass moving inland. Most of the water carried past this barrier is precipitated by orographic effect on the western slope of the Sierra Nevada.

Major storms over the area normally last from 2 to 4 days and consist of two or more waves of relatively intense precipitation with lesser rates between the waves. Warm storms that combine intense precipitation with temperatures above freezing level at high elevations produce major floods from the Sierra Mountains. Rainfall during some of these major storms has occurred up to about the 11,000-foot level.

6. Data Sources

a. Stream Gages

Streamflow and reservoir level records have been maintained by United States Geological Survey (USGS), the California Department of Water Resources (DWR) and others for varying periods dating from 1901. A summary of the principal stations of interest in this investigation is presented in Table III-4 and their locations are indicated in figure III-3.

b. Water Quality Stations

Water quality data for the San Joaquin River system are rather limited.

Although some data are available for tributary streams dating back to 1938, the records are sparse. The most reliable data are those collected by the USGS on a monthly frequency since 1951 (except for the Stanislaus River, on which sampling began in 1956). These generally include analyses for the principal cations and anions and determinations of TDS, EC, pH and Total Hardness. A record of 4-day sampling for chlorides in the San Joaquin River at Mossdale dates from 1929 through mid-1971. In recent years--since about 1959--continuous recordings of electrical conductivity have been made at selected stations in the Delta, including the San Joaquin River at Vernalis.

The locations of the principal water quality stations referenced in this report are indicated in figure III-4.

c. Unimpaired Flow Estimates

Development has affected the flow of all the major streams in the San Joaquin Basin. Estimates of the "unimpaired" flow of the San Joaquin River at Friant have been made by the Water and Power Resources Service for the period 1873-1978. Estimates for the other major streams in the basin were made by the Corps of Engineers (USCE). A list of the stations and the period of record is presented below:

<u>Station</u>	<u>Estimate By</u>	<u>Period of Record</u>
San Joaquin at Friant Dam	SERVICE	1873-1978
Merced River at Exchequer Dam	USCE	1906-1978
Tuolumne River at Don Pedro Dam	USCE	1901-1978
Stanislaus River at New Melones Dam	USCE	1901-1978

For the purposes of this report the unimpaired flow of the San Joaquin River at Vernalis was assumed to be the sum of the unimpaired flows at the four stations above.

Table III-4 STREAM GAGES IN THE SAN JOAQUIN RIVER SYSTEM

Station	Operating <u>1/</u> Agency	D.A. (sq.mi.)	Period of record
San Joaquin River			
Millerton Lake	USBR	1638	1941 to date
bel. Friant	USGS	1676	1907 to date
nr. Mendota	USBR	4310 <u>3/</u>	1939 to date
nr. Dos Palos <u>2/</u>	USBR	5630 <u>3/</u>	1940 to date
at Fremont Ford Bridge	DWR	7615 <u>3/</u>	1937 to date
nr. Newman	USGS	9520 <u>3/</u>	1912 to date
nr. Crows Landing	DWR	-	1965 to 1972
at Patterson Br.	DWR	9760 <u>3/</u>	1938 to 1966
			1969 to date
at Maze Rd. Br.	DWR	12400 <u>3/</u>	1943 to date
nr. Vernalis	USGS	13536 <u>3/</u>	1922 to date
Merced River			
Lake McClure	MID	1037	1926 to date
bel. Merced Falls Dam, nr. Snelling	USGS	1061	1901 to date
bel. Snelling	DWR	1096	1958 to date
at Cressey	DWR	1224	1941 to date
nr. Livingston	MID	1245	1922 to 1944
nr. Stevinson	USGS	1273	1940 to date
Tuolumne River			
Don Pedro Reservoir	USGS	1533	1923 to date
abv. LaGrange Dam nr. LaGrange	USGS	1532	1895 to 1970
bel. LaGrange Dam nr. LaGrange	USGS	1538	1970 to date
at Modesto	USGS	1884	1940 to date
at Tuolumne City	DWR	1896	1930 to date
Stanislaus River			
Melones Lake	WPRS	904	1926 to date
bel. Melones Powerhouse	USGS	905	1931 to 1967
Tulloch Reservoir	TRI-DAMS	980	1957 to date
bel. Goodwin Dam	USGS	986	1957 to date
at Ripon	USGS	1075	1940 to date
Westside Streams			
Panoche Cr. bel. Silver Cr.	USGS	293	1949 to 1953
			1958 to 1970
Orestimba Cr. nr. Newman	USGS	134	1932 to date
Del Puerto Cr. nr. Patterson	USGS	72.6	1958 to date
Los Banos Cr. nr. Los Banos	USGS	159	1958 to 1966

1/ USGS - United States Geological Survey, USBR - United States Bureau of Reclamation, USCE - United States Corps of Engineers, DWR - State of Calif., Dept. of Water Resources, MID - Merced Irrigation District

2/ Measures most of low flows and only part of flood peaks

3/ Includes Kings River basin

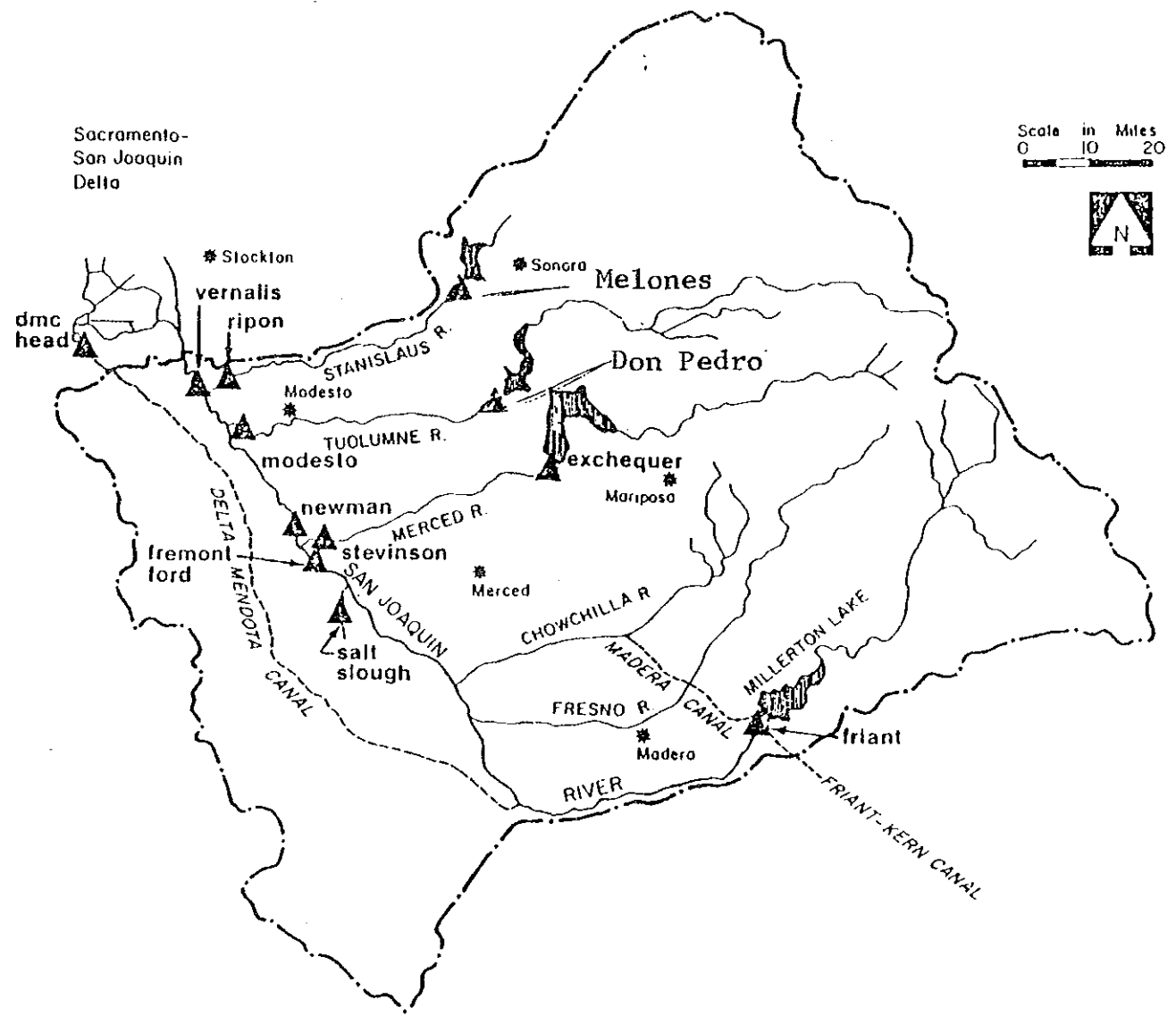

Figure III-3 SAN JOAQUIN RIVER BASIN STREAM FLOW GAGING STATIONS

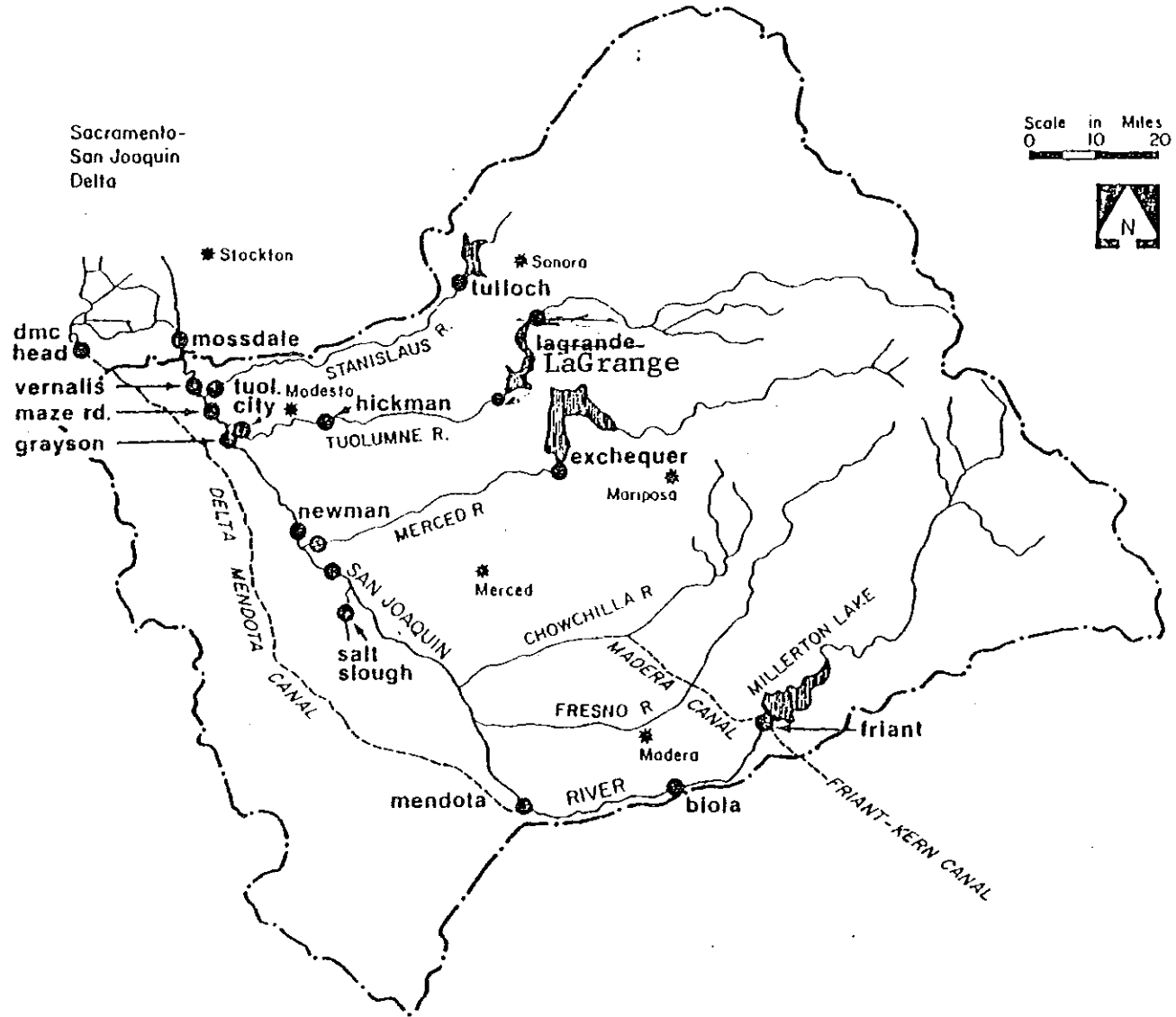

Figure III-4 SAN JOAQUIN RIVER BASIN WATER QUALITY SAMPLING STATIONS

7. Return Flows

There have been few direct measurements of drainage return flows, only occasional gagings associated with special studies. In this report return flows were estimated by water balance calculations between stream gages where the change in flow could be attributed to drainage accretions.

8. Water Levels

Data on water levels in the Delta channels were derived from continuous recorders operated by the Department of Water Resources. The location of water level stations used in this report are shown in Figure III-5.

9. Channel Depths

Data on channel depths were derived primarily from hydrographic charts of the U.S. Coastal and Geodetic Survey and special surveys conducted in 1974 and 1975 by the Department of Water Resources.

10. Other

Additional data on flows, water quality and water levels were derived from reports of special studies and Service files.

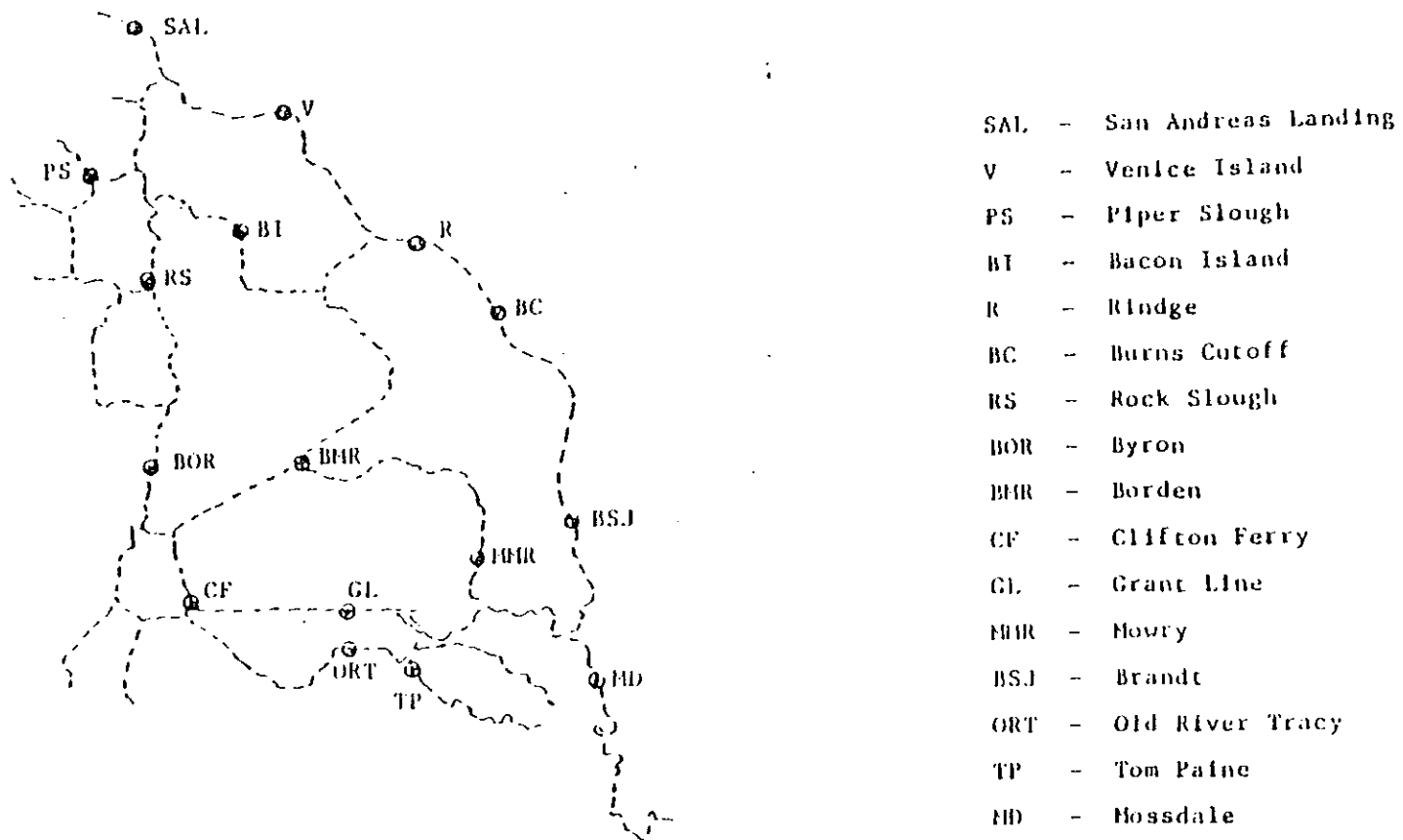

Figure III-5 WATER LEVEL STATIONS IN THE SOUTHERN DELTA

Source: California Department of Water Resources

CHAPTER IV
INVESTIGATION PROCEDURE

A. SELECTION OF HYDROLOGIC AND WATER QUALITY RECORD PERIODS

Since the primary objective of this investigation is to determine the effect of the Central Valley Project on the quantity and quality of the in-channel water supply in the Southern Delta, the period of record was selected to include representative periods both before and after the implementation of CVP operations in the San Joaquin Valley. The pre-1944 spanned 14 years, 1930-1943 inclusive. The post-1947 spanned 22 years, 1948-1969 inclusive. Data records were assembled for the period 1930-1969, although the records for 1944 through 1947, when the CVP was being brought "on-line," were generally excluded from analysis.

B. ESTIMATION OF UNIMPAIRED RUNOFF

For the purposes of this investigation "unimpaired runoff" means the natural runoff of the river basin, absent the influence of man. Generally, this quantity is estimated by determining the aggregate runoff of all gaged streams in the drainage area above the highest point of development and adding an amount estimated to correspond to accretions from precipitation (ungaged) at lower levels if the watershed were entirely undeveloped, i.e., in virgin condition.

However, for reasons of simplicity it was decided to exclude the estimate of valley floor accretions (the ungaged flow from developed lands) and utilize only the gaged runoff of the four principal streams above the major projects. This runoff, which was used to estimate the impact of post-1947 development and operation, is referred to in this report as "unimpaired" rimflow.

Unimpaired runoff at Friant, Exchequer, Don Pedro, and New Melones represent the rim station flows of the San Joaquin, Merced, Tuolumne, and Stanislaus Rivers, respectively. Vernalis unimpaired flow as referred to in this report is the sum of the four unimpaired rim station flows. This definition of Vernalis unimpaired flow is the commonly used form.

C. IDENTIFICATION OF KEY STATIONS FOR WATER BALANCE AND SALT BALANCE

The impacts of upstream development on the inflow to the Delta are measured mainly in the flow and quality of the San Joaquin River at Vernalis, hence data for this location are crucial to the investigation. Development of the CVP has occurred primarily in the upper portion of the San Joaquin River basin, at Friant, near Mendota and along the reach of the San Joaquin River above its confluence with the Merced River. Thus, the gaging station on the San Joaquin River near Newman, situated just below the mouth of the Merced, is important for the information it provides on the changes in runoff that may be attributed to the CVP. This runoff quantity has been corrected for the contribution of the Merced River and Merced Slough to produce a synthetic record of runoff of the upper San Joaquin River basin above the Merced River, which figures prominently in water balance computations. For the purposes of this report changes in runoff from the upper San Joaquin River basin, i.e., above the mouth of the Merced River, that have occurred since 1944 are attributed entirely to the CVP.

Other key stations for both the water quantity and water quality analysis, in addition to Vernalis, include stations on the eastside tributaries just upstream of their confluences with the main stem of the San Joaquin and the major westside tributary, Salt Slough for which good water quality data are available. Several stations along the Tuolumne River, at LaGrange, Hickman, and Tuolumne City serve to assess the contribution of the gas wells to the

river's salt burden. Upstream stations at Friant, Exchequer, LaGrange, and Tulloch provide water quality data that are useful for comparison with westside drainage quality and the quality of water in the main stem of the San Joaquin.

D. ESTIMATION OF WATER BALANCE

Changes in water balance in the San Joaquin River for the pre-1944 and post-1947 periods have been assessed by several different techniques as follows:

1. By comparison of average annual, seasonal and monthly runoff at key locations for similar hydrologic periods.
2. By comparison of double mass plots of annual and seasonal runoff for key locations; either in chronological sequence or in order of magnitude sequence. Data for double mass diagrams were fitted with regression equations, that were then used in determining flow reductions.

Since no two-years or other chronological periods are hydrologically identical, an effort was made to classify seasons, years, or groups of years according to the magnitude of unimpaired (rim) runoff. Considering the four-station runoff total** as an estimate of the unimpaired flow of the San Joaquin River at Vernalis, an analysis of the record 1906-1977 (72 years) showed that hydrologic years could be grouped conveniently into four general categories of about equal size as shown on Table IV-1.

Dry	(19 years)	less than 3,500,000 AC/yr
Below normal	(18 years)	3,500,000 to 5,600,000 AC/yr
Above normal	(20 years)	5,600,000 to 7,500,000 AC/yr
Wet	(15 years)	greater than 7,500,000 AC/yr

*During the 1920's a series of gas wells were drilled in the region of the lower Tuolumne River. These wells penetrated water bearing formations, including some with high salinity. When these wells were later abandoned, some that penetrated artesian strata continued to flow, adding significant amounts of salt to the Tuolumne River in the lower section below Hickman. The wells were sealed in 1976-1977 so that the accretions of salt to the Tuolumne River were reduced. Data are not yet available to determine the extent of the salt load reduction and its impact on the San Joaquin River.

**San Joaquin River at Friant, Merced River at Exchequer, Tuolumne River at Exchequer and Stanislaus River at Melones.

TABLE IV-1
UNIMPAIRED FLOW, SAN JOAQUIN RIVER AT
VERNALIS, 1906-1979

<u>Year</u>	<u>Flow</u> <u>1,000 AF</u>	<u>Year</u>	<u>Flow</u> <u>1,000 AF</u>	<u>Year</u>	<u>Flow</u> <u>1,000 AF</u>
1977	1,014	1918	4,587	1914	8,692
1924	1,504	1950	4,656	1909	8,971
1931	1,660	1971	4,870	1952	9,312
1976	1,928	1925	5,505	1956	9,679
1961	2,100	1923	5,512	1967	9,993
1934	2,288	<u>1970</u>	<u>5,587</u>	1938	11,248
1929	2,844	1962	5,618	1911	11,480
1939	2,909	1946	5,734	1907	11,824
1968	2,958	1921	5,901	1969	12,295
1960	2,960	1975	6,114	1906	12,427
1959	2,986	1963	6,250		
1913	2,995	1915	6,405		
1964	3,151	1935	6,418		
1930	3,254	1973	6,467		
1908	3,325	1936	6,495		
1933	3,356	1927	6,499		
1947	3,424	1937	6,530		
1912	3,458	1940	6,596		
<u>1926</u>	<u>3,493*</u>	1945	6,612		
1955	3,512	* 1932	6,622		
1972	3,571	1910	6,645		
1949	3,799	1917	6,662		
1944	3,933	1974	7,146		
1966	3,985	1951	7,262		
1919	4,096	1943	7,283		
1920	4,097	<u>1942</u>	<u>7,370</u>		
1948	4,218	1922	7,681		
1957	4,292	1941	7,945		
1954	4,313	1965	8,108		
1953	4,554	1916	8,229		
1928	4,365	1958	8,367		

* Bars divide the data according to year classifications, dry, below normal, above normal and wet.

This division puts approximately the same number of years during the 1906-1978 period into each category. Each category was not equally represented in the two study periods as the following table illustrates:

	<u>1906-1977</u>	<u>1906-1929</u>	<u>1930-1943</u>	<u>1948-1969</u>	<u>1970-1977</u>
Dry	19	6	5	5	2
Below normal	18	6	0	8	3
Above normal	20	5	7	3	3
Wet	15	7	2	6	0
Total	72	24	14	22	8

A similar breakdown of the runoff of the San Joaquin River at Friant indicated that this year classification system was consistent for the smaller tributary area as well.

Additional relationships were developed comparing flow of a station to flow at an adjacent station. These relationships are used throughout this report when specific dates are not designated. The data, graphs, and mathematical equations that are not included in the body of this report may be found in the files of the CVOCO offices of the Mid-Pacific Region of the Service.

"Other" flows are determined by changes in flow at adjacent stations not contributed by measured tributaries. "Other" flows for several reaches of the main stem of the San Joaquin River have been determined using this water balance method.

E. EVALUATION OF WATER QUALITY EFFECTS

1. Salt Balance

Data is available for the stations studied, to prepare salt load-flow relationships. These relationships are used throughout this report when specific dates are not indicated. The data, graphs, and mathematical equations that are not included in the body of this report may be found in the files of the Offices of the Mid-Pacific Region of the Service.

With the salt load known at key locations, any change in load between stations not caused by measured tributaries can be attributed to "other" sources. "Other" loads are determined using this method for several reaches along the main stem of the San Joaquin River.

2. Chemical Composition

Because the geologic, topographic and hydrologic characteristics of the east and west sides of the San Joaquin Valley are distinctly different, it was expected that detailed water quality analysis of waters derived from the several sources would serve to identify their separate and proportional contributions to the San Joaquin River salt burden. For this purpose USGS data on water quality for selected stations along the main stem of the San Joaquin River were compared to those for the principal tributaries and sources known to contribute drainage water to the system. Comparisons were made on the basis of the proportions of principal cations and anions, especially sulfate ion (SO_4^-) known to be derived from soils on the westside of the valley and characteristic of both wells and drainage waters from this area. Also, noncarbonate hardness and boron concentration, that tend to distinguish waters from the westside of the valley from those of the major Sierra streams, are used to "fingerprint" the composite drainage water of the San Joaquin River. Comparisons are also made with water imported into the westside of the Valley by the Delta-Mendota Canal.

F. ESTIMATION OF RETURN FLOWS

In the absence of direct measurement of return flows, it was necessary to estimate aggregate returns by either water balance methods or by a combination of water balance and salt balance computation. Details of individual drainage

contributions, known to exist along the San Joaquin and the lower reaches of major tributaries (DWR, 1960) are not determinable by either method. The question of the relative contributions of east and westside sources, however, was addressed by considering both chemical composition and water balance.

G. EVALUATION OF EXPORT PUMPING EFFECTS (CVP AND SWP)

1. On Channel Depths

For purposes of evaluating effects of CVP export on South Delta Channels, comparisons were made of channel cross sections and average depths, before the advent of the CVP and after. Data for this purpose were derived from USCGS and DWR sources.

2. On Water Levels

Water level effects were assessed in three ways; from actual records of tidal fluctuation during pumping, from the results of pumping tests designed to determine drawdown due to pumping, and by application of a mathematical model that simulates the hydrodynamic behavior of Delta channels during actual or hypothetical pumping episodes.

3. On Water Quality

Water quality effects of export pumping were not measurable directly, but were assessed in general terms from changes in circulation induced by pumping. Channel discharges, velocities and net circulations were determined from the results of simulations using the mathematical model.

4. Mathematical Modeling

The mathematical model employed as a tool in this investigation is a version of the hydrodynamic simulator developed by Water Resources Engineers, Inc. and employed by DWR and others in a variety of special studies of Delta hydraulics. It was adapted for this investigation, using detailed data on channel geometry and water levels provided by the DWR.

CHAPTER V

WATER QUANTITY EFFECTS OF UPSTREAM DEVELOPMENT

This section of the report discusses the effect of upstream development on lower San Joaquin River flows. It attempts to identify the impact of the CVP by assuming that all development on the upper San Joaquin River (that portion of the San Joaquin River upstream of the mouth of the Merced River) since 1947 is due to the CVP. While some development in addition to the CVP has occurred in the upper San Joaquin basin it is not extensive and for the purpose of this report, is considered negligible.

It is obvious from the records of San Joaquin River flows at Vernalis that development of water resources in the basin upstream has decreased the quantity of flow in the lower San Joaquin River. Figure V-1 shows the average reduction in runoff in the April-September period between two historic periods, 1930-1944 and 1952-1966. The figure demonstrates that the flow of the San Joaquin River at the Vernalis gage during the April-September period averaged 1,020,000 acre-feet less in the 1952-1966 period than in the 1930-1944 period when adjusted for the difference in unimpaired rim flow.

Figure V-2 similarly shows the average reduction in flows of the upper San Joaquin River during the April-September period. When adjusted for the difference in unimpaired rim flow, the average flow in the upper San Joaquin River has decreased by 444,600 acre-feet during the April-September period.

Although development has had a significant effect on the average flow in the lower San Joaquin River it is evident from the streamflow records of the San Joaquin basin rivers, that the magnitude of the annual unimpaired flow of the San Joaquin River is important in determining the impact of the CVP on the flow of the river into the southern Delta area.

AVG. ANNUAL DECREMENT IN APR-SEPT RUNOFF
 BETWEEN TWO HISTORIC PERIODS
 (Adjusted for difference in rim flow)

$$= \frac{16.15}{15} \times \frac{56.1}{59.4} \times 10^6 = 1,020,000 \text{ a.f.}$$

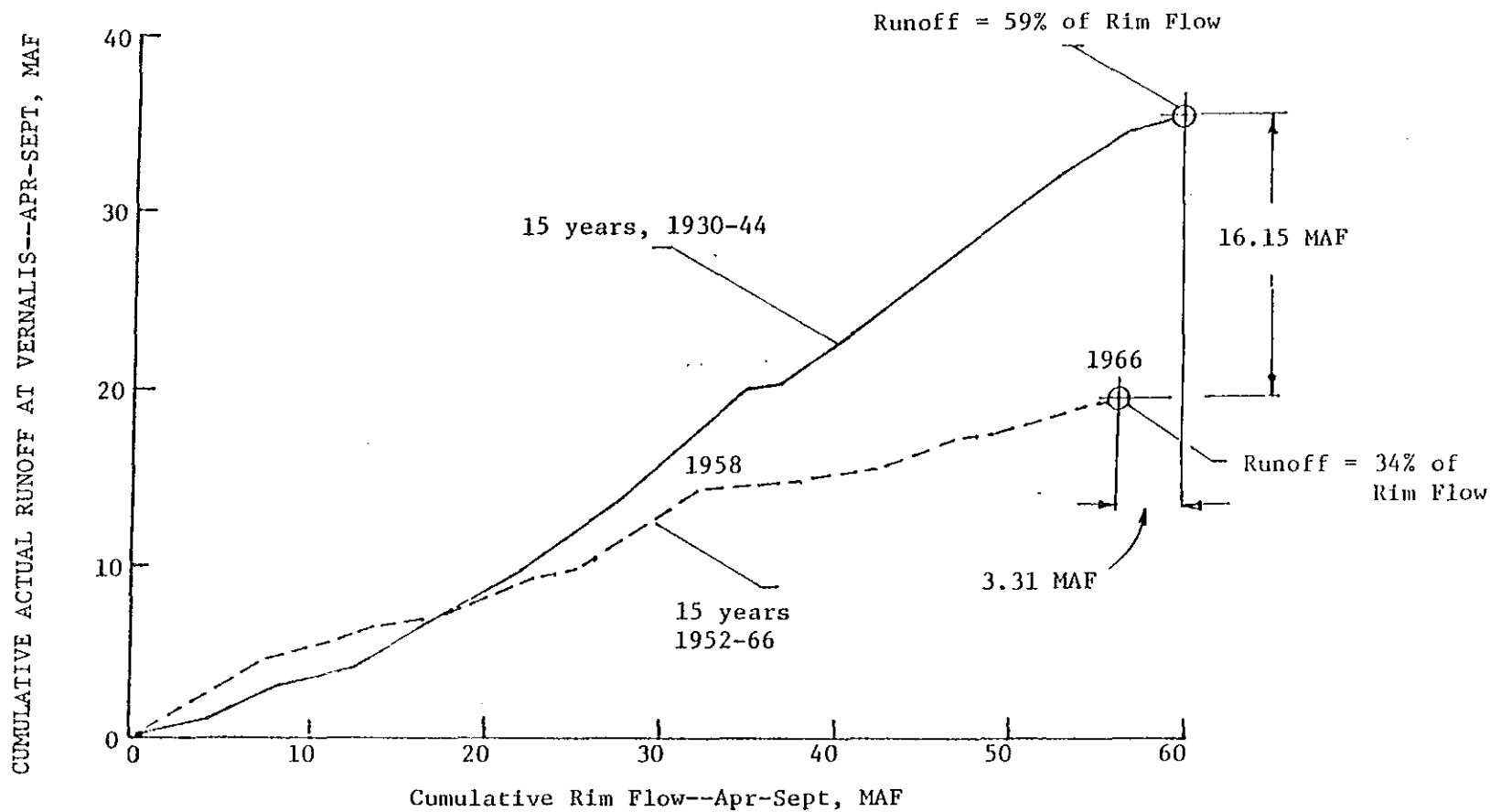

CUMULATIVE RUNOFF AT VERNALIS FOR APRIL-SEPTEMBER PERIOD
 PRE-CVP (1930-44) AND POST-CVP (1952-66)

AVG. ANNUAL DECREMENT IN APR-SEPT RUNOFF
 BETWEEN TWO HISTORIC PERIODS
 (Adjusted for difference in rim flow)

$$= \frac{7.05}{15} \times \frac{18.57}{19.63} \times 10^6 = 444,600 \text{ a.f.}$$

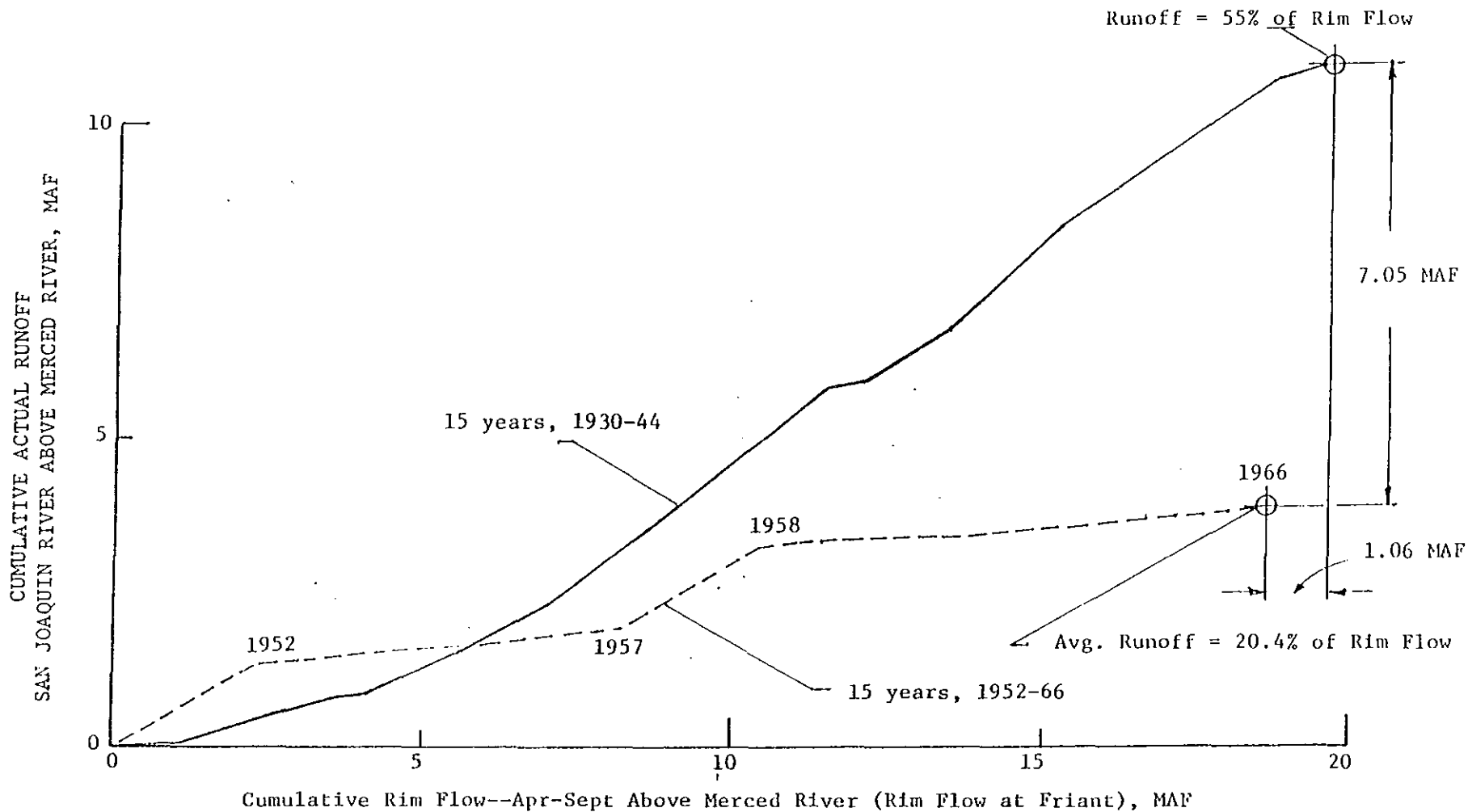

CUMULATIVE RUNOFF IN SAN JOAQUIN RIVER ABOVE MERCED RIVER DURING THE APRIL-SEPTEMBER PERIOD
 PRE-CVP (1930-44) AND POST-CVP (1952-66)

To evaluate more effectively the impact of the CVP in years of differing hydrology runoff, records for the period 1906-1977, inclusive, were studied to determine a logical year classification system. The analysis resulted in classification of hydrologic years into four groupings by magnitude of unimpaired flow as summarized in Table V-1.

Figures V-3 and V-4 show a comparison by year type of actual San Joaquin River flow near Vernalis to the sum of unimpaired rim station flow for the annual and April through September periods, respectively. Figure V-5 presents a comparison by year type of the actual flow of the upper San Joaquin River and the unimpaired flow of the San Joaquin River at Friant Dam for the April through September period. The importance of year type in determining the impact of the CVP can be seen by comparing figures V-3, V-4 and V-5. For example, while figures V-3 and V-4 show that there has been a reduction of flow at Vernalis in dry years, figure V-5 indicates that there has been relatively small changes in the flows of the upper San Joaquin River during the April through September period of dry years.

Since the type of year is important in determining the impact of the CVP on net runoff at Vernalis, the following discussion of impact treats each of the four-year types separately.

DRY YEARS

San Joaquin Basin Above Vernalis

There were five years in each of the pre-1944 and post-1947 periods for which the total rim station unimpaired flow was less than 3,500,000 acre-feet per year. Tables V-2, V-3, V-4, and V-5 summarize the hydrologic conditions for these 10 dry years.

Table V-1
Year Classifications for the San Joaquin River System

<u>Year Class</u>	<u>Unimpaired Flow</u> ¹ acre-feet/year
Dry	less than 3,500,000
Below Normal	3,500,000 - 5,600,000
Above Normal	5,600,000 - 7,500,000
Wet	greater than 7,500,000

¹ Sum of runoff of four major tributaries to the San Joaquin Basin.

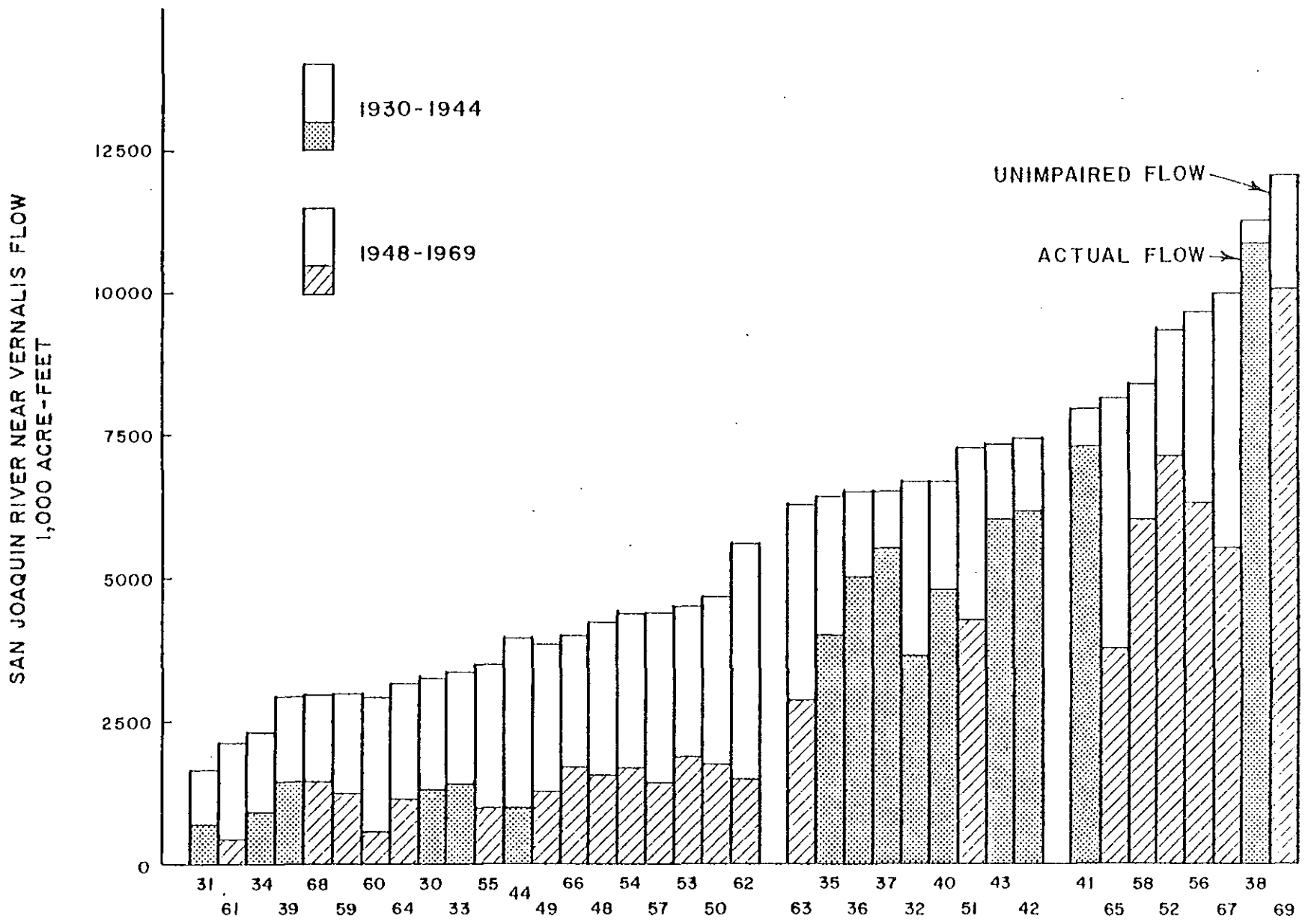

SAN JOAQUIN RIVER NEAR VERNALIS ANNUAL FLOW
PRE-1944 (1930-1944) AND POST 1947 (1948-1969)

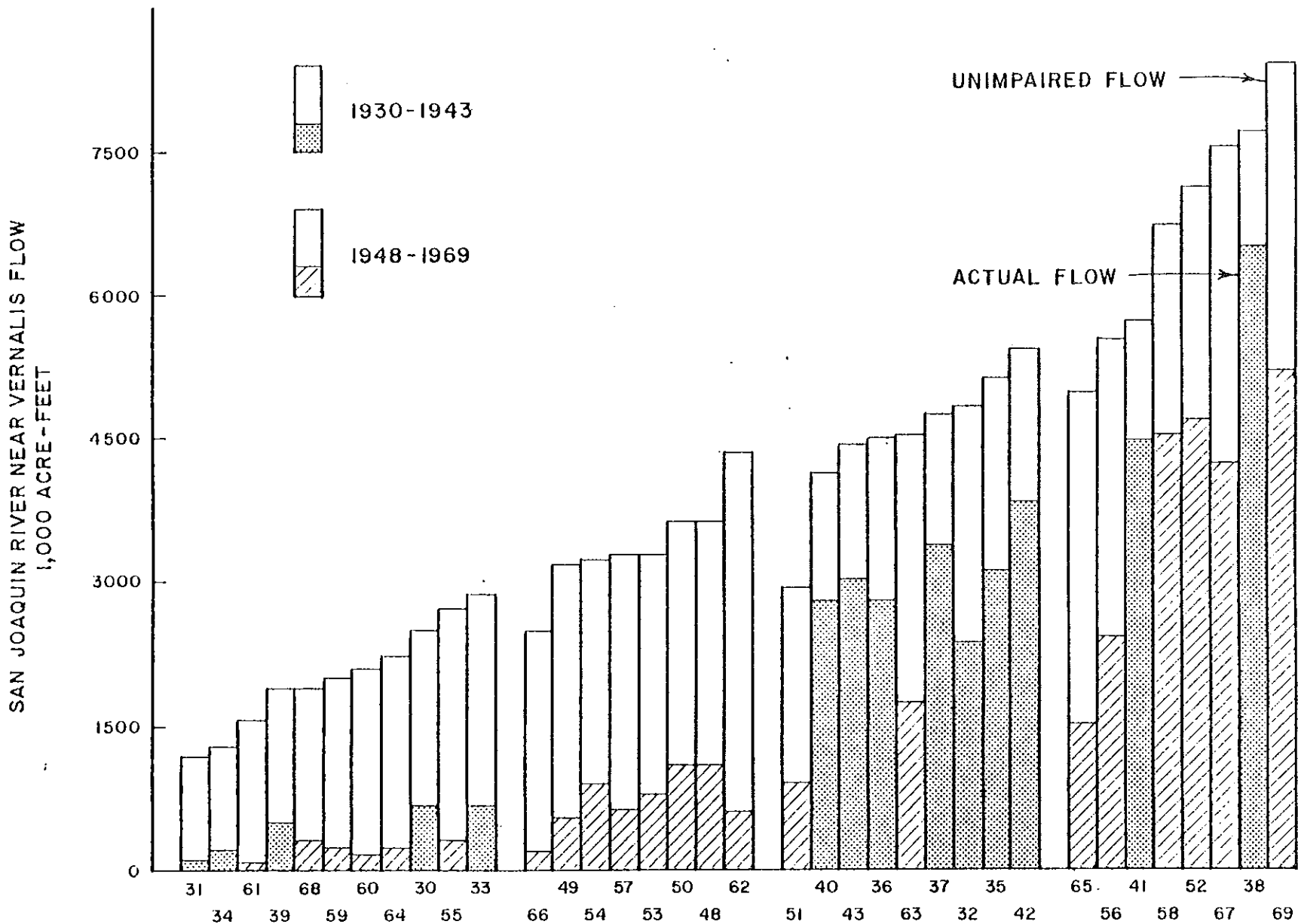

SAN JOAQUIN RIVER NEAR VERNALIS, APRIL-SEPT PERIOD
 PRE-1944 (1930-1943) AND POST 1947 (1948-1969)

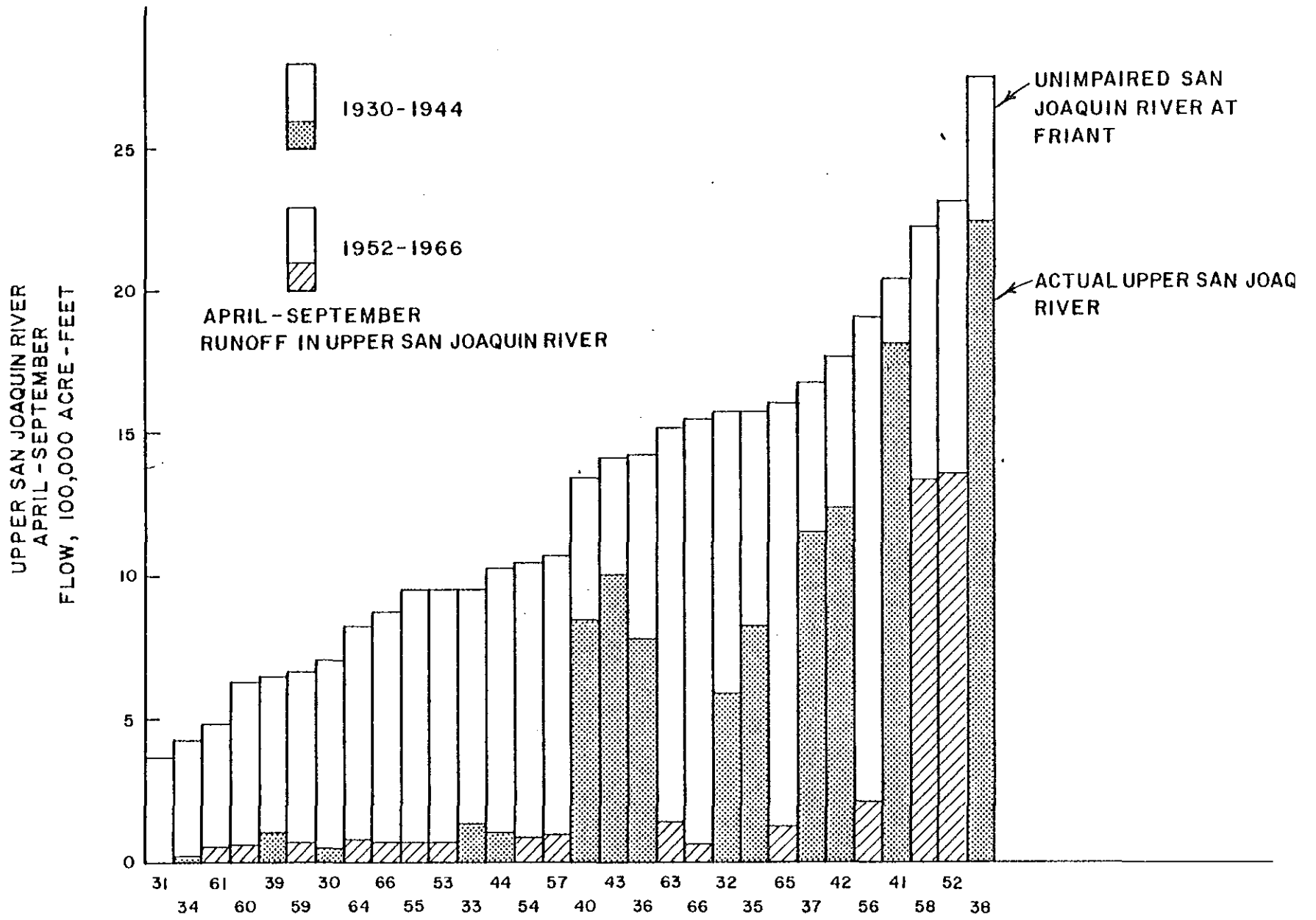

UPPER SAN JOAQUIN RIVER DURING APRIL-SEPT PERIOD
PRE-CVP (1930-44) AND POST-CVP (1952-66)

As the information presented on Table V-2 demonstrates, the annual loss of flow at Vernalis due to post-1947 upstream development as estimated by the double-mass diagram method described on page IV-3, is in the range of 254,000 to 688,000 acre-feet in dry years.

Table V-2 also shows that the city of San Francisco diversion from the Tuolumne River basin through Hetch Hetchy Aqueduct increased from an average of 10,000 acre-feet in pre-1944 dry years (1930, 31, 33, 34 and 39) to an average of 183,000 acre-feet in post-1947 dry years (1959, 60, 61, 64 and 68). CVP operations during post-1947 dry years resulted in importation of an average of 1,031,000 acre-feet through the Delta-Mendota Canal into the Mendota Pool and diversion of an average of 728,000 acre-feet through the Friant-Kern Canal and 171,000 acre-feet through the Madera Canal.

Table V-3 shows that during the April-September period, the estimated flow reduction in the San Joaquin River at Vernalis due to post-1947 development upstream from Vernalis ranged from 149,000 to 594,000 acre-feet in dry years. The table also shows that estimated loss due to the development in the upper San Joaquin basin ranged from 2,000 to 11,000 acre-feet in the April-September period of dry years.

A comparison of the unimpaired flow of the San Joaquin River at Vernalis and the actual flow at the Vernalis station was made as a check on the change in losses* estimated by the double mass diagram method. As shown on Table V-2, in the dry years the average net loss at Vernalis increased from 1,501,000 acre-feet in the pre-1944 years to 1,870,000 acre-feet in the post-1947 years. When the pre-1944 average is adjusted for the difference in average unimpaired flow between pre-1944 and post-1947 periods the average annual increase in

* The terms "loss" or "losses" refer to the difference between the upstream unimpaired flow and the actual flow at the point in question.

TABLE V-2

ESTIMATES OF ANNUAL WATER LOSSES AT VERNALIS IN DRY YEARS

1	2	3	4	5	6	7	8	9	10	11	12	13	14	15
Dry Years	Rim Station Unimpaired KAF	Vernalis Actual KAF	Net Loss @ Vernalis KAF	Estimated Loss @ Vernalis Due to Post 1947 Development Above Vernalis - KAF	Hetch Hetchy KAF	Friant Unimpaired KAF	San Joaquin @ Friant KAF	Actual Upper San Joaquin KAF	Net Loss @ Newman KAF	Estimated Loss at Vernalis Due to Post 1947 Development in Upper San Joaquin - KAF	Madera Canal Diversion KAF	Friant-Kern Canal Diversion KAF	Delta-Mendota Canal Delivery to Mendota Pool KAF	Net Central Valley Project Inter-Basin Transfer
1930	3,254	1,270	1,984			0	859	N.A.	109					
1931	1,660	677	983		0	480	N.A.	72	408					
1933	3,356	1,380	1,976		0	1,111	N.A.	295	816					
1934	2,288	927	1,361		0	691	N.A.	195	496					
1939	2,909	1,708	1,201		53	921	1,077	433	488					
Avg.	2,693	1,192	1,501		10	812		221	591					
1959	2,986	1,244	1,742	492	167	949	79	111	838	90	208	809	1,029	+220
1960	2,960	550	2,410	688	167	829	96	105	724	160	144	582	1,009	+427
1961	2,100	437	1,663	254	174	648	100	88	560	111	103	442	1,021	+579
1964	3,151	1,124	2,027	656	186	922	70	164	758	184	228	838	1,066	+220
1968	2,938	1,429	1,509	506	223	862	58	210	652	146	170	967	1,032	+ 65
Avg.	2,827	957	1,870	519	183	842	81	136	706	138	171	728	1,031	+303

33

Adjusted Loss San Joaquin Basin = $1870 - \left[1501 \times \frac{2827}{2693} \right] = 294$

Adjusted Loss Upper San Joaquin Basin = $706 - \left[591 \times \frac{842}{812} \right] = 93$

TABLE V-3

ESTIMATES OF APRIL TO SEPTEMBER WATER LOSSES AT VERNALIS

IN DRY YEARS

1	2	3	4	5	6	7	8	9	10	11	12	13	14	15
Dry Years	Vernalis Unimpaired KAF	Vernalis Actual KAF	Net Loss @ Vernalis KAF	Estimated Loss @ Vernalis Due to Post 1947 Development Above Vernalis - KAF		Friant Unimpaired KAF	San Joaquin @ Friant KAF	Actual Upper San Joaquin KAF	Net Loss Upper San Joaquin-KAF	Estimated Loss @ Vernalis Due to Post 1947 Development Upper San Joaquin - KAF	Madera Canal Diversion KAF	Friant - Kern Canal Diversion KAF	Delta-Mendota Canal Delivery to Mendota Pool KAF	Net Central Valley Project Inter-basin Transfer KAF
1930	2,490	672	1,818					706	N.A.					
1931	1,203	121	1,082			368	N.A.	0	368					
1933	2,856	647	2,209			945	N.A.	137	808					
1934	1,303	196	1,107			430	N.A.	16	414					
1939	1,909	483	1,426			641	616	100	541					
Avg.	1,952	424	1,528			618		60	558					
1959	1,995	219	1,776	297		664	57	56	608	11	169	536	814	+278
1960	2,108	138	1,970	535		632	67	39	593	2	124	428	786	+358
1961	1,562	82	1,480	149		487	57	38	449	4	91	324	817	+493
1964	2,216	231	1,985	594		816	48	67	749	10	187	543	817	+274
1968	1,918	309	1,609	510		583	41	77	506	2	114	503	787	+284
Avg.	1,959	196	1,764	417		636		55	581	6	137	467	804	+285

Adjusted Loss = 230*

= 7*

*Computed per example in Table V-2

TABLE V-4

ACTUAL AND UNIMPAIRED ANNUAL FLOWS AT RIM STATIONS IN DRY YEARS

Dry Years	STANISLAUS		TUOLUMNE		MERCED		SAN JOAQUIN	
	Unimpaired at Melones	Actual at Ripon	Unimpaired at Don Pedro	Actual at Modesto	Unimpaired at Modesto	Actual at Stevinson	Unimpaired at Friant	Actual Upper San Joaquin
	KAF	KAF	KAF	KAF	KAF	KAF	KAF	KAF
1930	732	474	1,151	527	513	89	859	109
1931	315	611	603	368	262	70	480	72
1933	609	304	1,119	504	516	158	1,111	295
1934	424	134	812	387	361	95	691	195
1939	526	286	985	551	477	224	921	433
AVG.	521	361	934	467	426	127	812	221
1959	584	241	997	627	455	115	949	111
1960	594	92	1,056	293	483	89	829	105
1961	404	81	736	223	312	57	648	88
1964	643	212	1,139	540	447	92	922	164
1968	640	268	1,010	553	426	205	862	210
AVG.	573	179	988	447	425	112	842	136
ADJUSTED LOSS		218*		47*		15*		93*
TOTAL SUB-BASIN LOSS = 373								

*Example:

Adjusted loss = Ave. loss in post-1947 years - Average loss in pre-1944 years x $\frac{\text{Average unimpaired flow for post-1947 years}}{\text{Average unimpaired flow for pre-1944 years}}$

$$(\text{Stanislaus Basin}) = (573-179) - \left[(521-361) \times \frac{573}{521} \right] = 218$$

TABLE V-5

ACTUAL AND UNIMPAIRED APRIL TO SEPTEMBER FLOWS AT RIM STATIONS IN DRY YEARS

Dry Years	STANISLAUS		TUOLUMNE		MERCED		SAN JOAQUIN	
	Unimpaired at Melones KAF	Actual at Ripon KAF	Unimpaired at Don Pedro KAF	Actual at Modesto KAF	Unimpaired at Modesto KAF	Actual at Stevinson KAF	Unimpaired at Friant KAF	Upper San Joaquin KAF
1930	524	324	869	246	391	50	706	45
1931	216	38	426	73	193	30	368	0
1933	528	203	953	219	430	58	945	137
1934	222	31	456	97	195	42	430	16
1939	354	104	614	142	300	60	641	100
AVG.	369	144	663	155	302	48	618	60
1959	364	52	661	86	307	47	664	56
1960	401	41	731	74	344	37	632	39
1961	301	26	544	53	231	17	487	38
1964	440	46	781	60	312	40	816	67
1968	400	66	652	77	284	51	583	77
AVG.	381	46	673	70	296	38	636	55
ADJUSTED LOSS		103		87		9		7
TOTAL SUB-BASIN LOSS = 206 KAF								

* Computed as per example in Table V-4

losses at the Vernalis gage was 294,000 acre-feet with 230,000 acre-feet occurring in the April-September period (see Table V-3).

A further check on change in losses occurring in the San Joaquin River basin was made by analyzing the losses of four subbasins. Tables V-4 and V-5 summarize the hydrologic data for the subbasins during the 10 dry years studied. The sum of the adjusted subbasin losses is 373,000 acre-feet for the annual period. During the April-September period the sum of the adjusted subbasin losses is 206,000 acre-feet (see Table V-5).

The table below summarizes the results of the three methods of analysis.

	<u>Estimated Loss At Vernalis, KAF</u>	
	<u>Annual</u>	<u>April-Sept</u>
Double mass diagram	519	417
Basin comparison	294	230
Subbasin comparison	373	206

Upper San Joaquin Basin

In the upper San Joaquin River basin post-1947 development affected the annual flows in dry years, but had no measurable effect on the flows during the April-September period. In the five pre-1944 dry years the actual annual flow of the upper San Joaquin River ranged from 72,000 to 433,000 acre-feet with an average of 221,000 acre-feet, while the unimpaired annual flows at Friant ranged from 480,000 to 1,110,000 acre-feet. Post-1947 dry-year flows in the upper San Joaquin River ranged from 88,000 to 210,000 acre-feet with an average of 136,000 acre-feet while unimpaired annual flows at Friant ranged from 647,000 to 949,000 acre-feet. There was an average decrease in the annual post-1947 flow in dry years in the upper San Joaquin River of about 138,000 acre-feet as estimated by the double mass diagram method (see Column 11, Table V-2).

With adjustment for the difference in unimpaired annual dry-year flow at Friant, the average decrease in flow from pre-1944 to post-1947 years in the upper San Joaquin River is about 133,000 acre-feet. This is about 60 percent of the pre-1944 flow in the upper San Joaquin River.

During the April-September period there was no significant change from the pre-1944 dry years to the post-1947 dry years in the upper San Joaquin River (see Column 11, Table V-3).

Estimated reduction in flow
in the upper San Joaquin River, KAF

<u>Method</u>	<u>Annual</u>	<u>April-Sept</u>
Double Mass Diagram	133	6
Basin Comparison	93	7

Figure V-6 shows a comparison of actual runoff at Vernalis during the April-September period for dry years in the pre-1944 and post-1947 periods. During four pre-1947 dry years of 1930, 31, 33 and 34 the flow at Vernalis averaged 68,150 acre-feet/month during the April-September period. This was about 40,000 acre-feet/month more than for the same period of the four post-1947 dry years of 1959, 60, 61 and 64.* The April-September decrement in runoff was about 241,000 acre-feet.

The same comparison in the upper San Joaquin River is made on figure V-7. In dry years the average flow in the upper San Joaquin River during the April-September period increased slightly in five of the six months within the period. In June the average flow decreased from 25,000 acre-feet to 8,300 acre-feet. This difference in average flow in June is attributed to an unusually high runoff in June 1933.

* The two sets of dry years were chosen for comparison so that the average unimpaired rim flows were nearly equal, e.g., 328,000 acre-feet/year for the pre-1944 years v. 327,000 acre-feet/year for the post-1947 years.

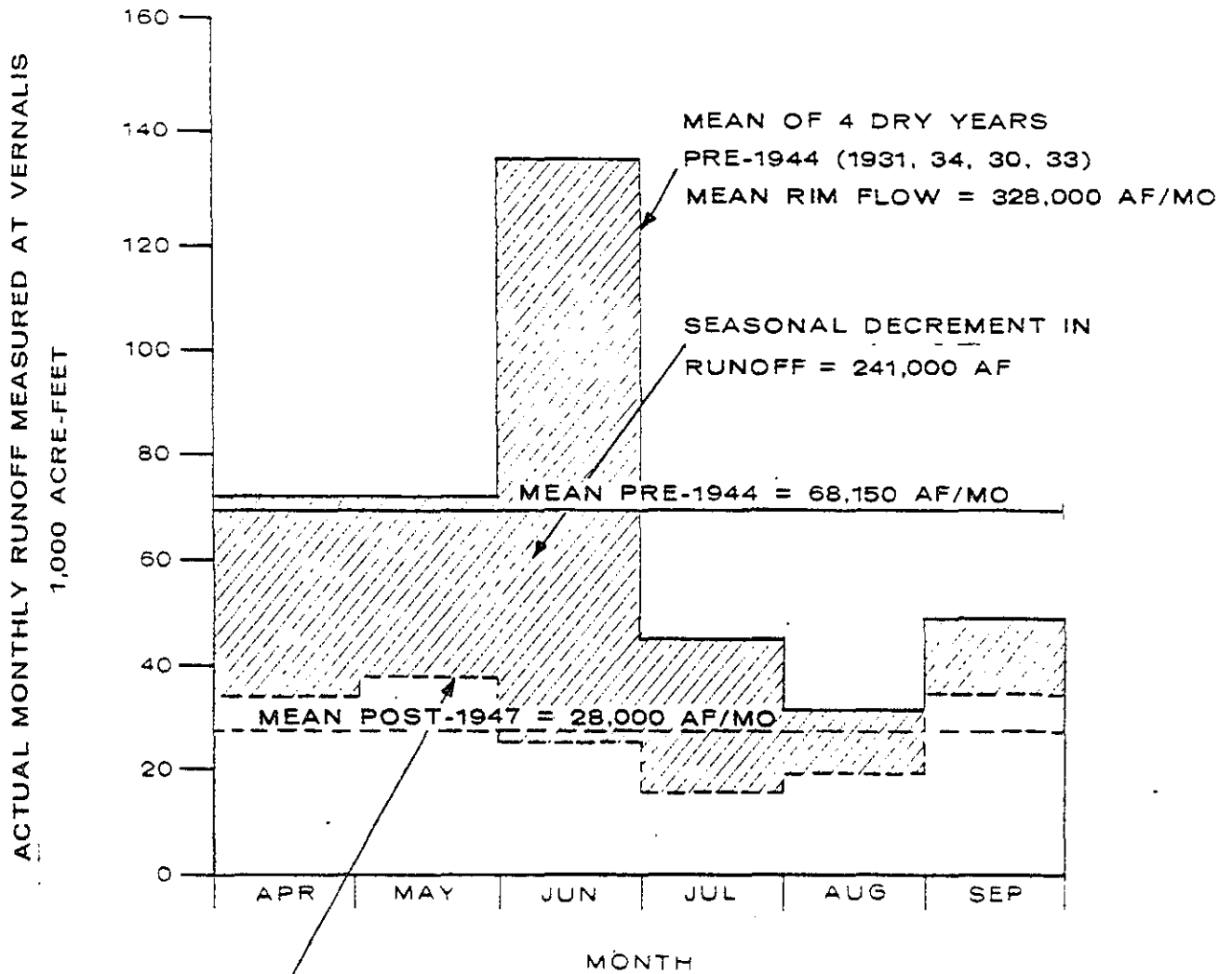

MEAN OF 4 DRY YEARS
POST-1947* (1961, 60, 59, 64)
MEAN RIM FLOW = 327,000 AF/MO

ACTUAL RUNOFF AT VERNALIS DURING APRIL-SEPTEMBER
PERIOD IN DRY YEARS
PRE-1944 (1931, 34, 30, 33) AND POST-1947 (1961, 60, 59, 64)
* NO ADJUSTMENT

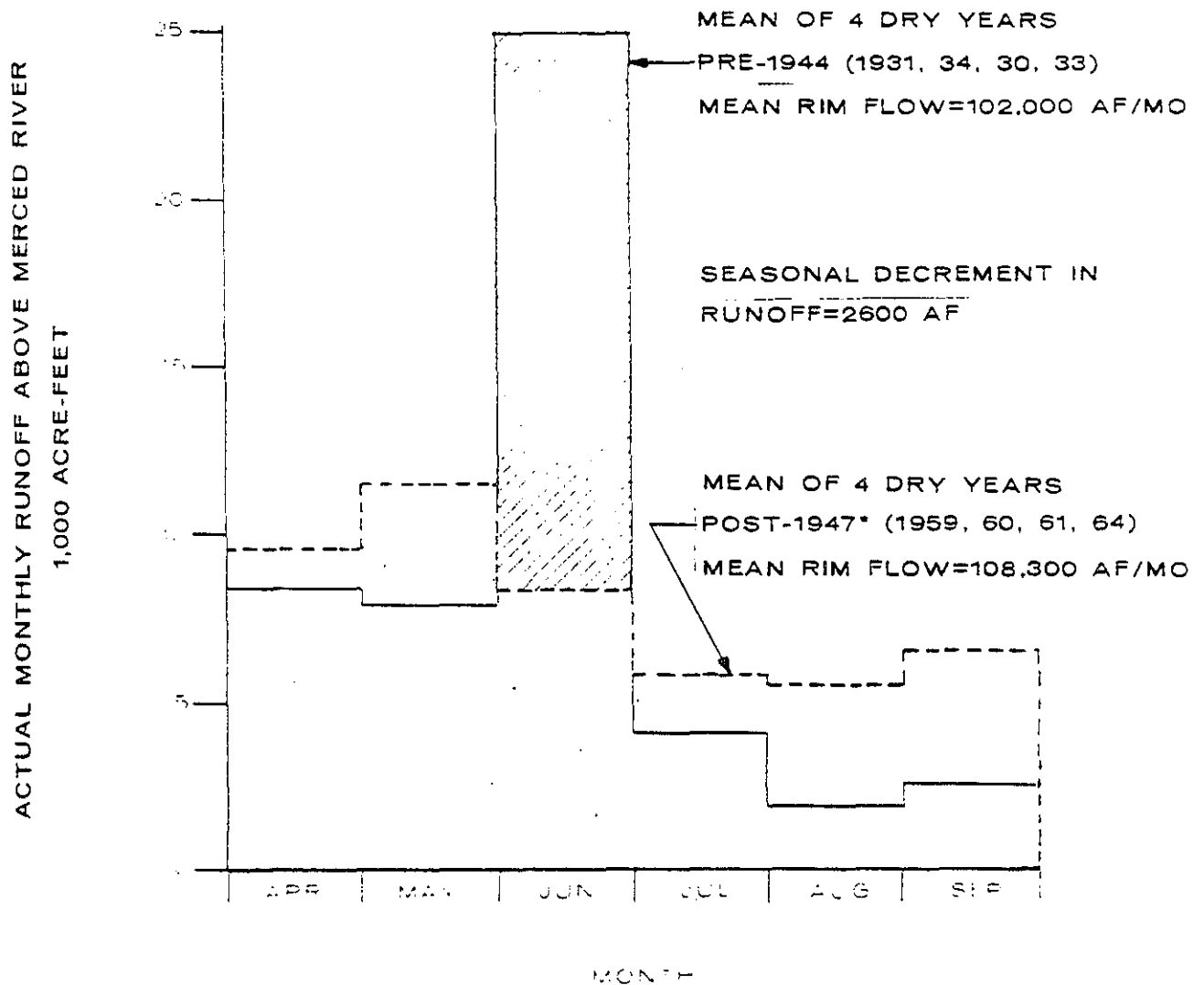

ACTUAL RUNOFF UPPER SAN JOAQUIN RIVER BASIN DURING APRIL-SEPTEMBER
PERIOD IN DRY YEARS

PRE-1944 (1930, 31, 33, 34) AND POST-1947 (1959, 60, 61, 64)

* ADJUSTED TO PRE-CVP BASE BY RATIO OF RIM FLOWS

When adjusted for the difference in unimpaired flow at Friant, the April-September period reduction in runoff during the post-1947 period is 2,600 acre-feet or about 400 acre-feet/month in the upper San Joaquin River.

Summary of Impacts - Dry Years

In summary, the data indicates that in dry years the impact of the CVP on the San Joaquin River at Vernalis was as follows:

- a. On an annual basis the estimated decrease in flow ranged from 93,000 to 133,000 acre-feet which is about 8 to 11 percent of the pre-1944 average dry-year annual flow at Vernalis.
- b. During the April-September period, the reduction in flow attributable to the CVP ranged from 2,600 to 7,000 acre-feet, which is about 0.6 to 1.6 percent of the pre-1944 average dry-year April-September flow at Vernalis.

BELOW NORMAL

The evaluation of the below normal years was the most difficult and probably the least accurate. While the four-year types were almost equally distributed in the 72-year period 1906-1977, there were no below normal years from 1930 through 1943. In contrast, over one-third or eight of the post-1947 years were classified as below normal. When available, information for the below normal years of 1923, 1925, and 1928 were included in Tables V-6, V-7, V-8, and V-9 for comparison purposes.

Based on the double-mass diagram method of calculation, the average annual reduction at Vernalis since 1947 during below normal years is estimated as 1,219,000 acre-feet. Most of the reduction, about 1,064,000 acre-feet, occurred during the April-September period. The average flow reduction due to CVP development on the upper San Joaquin River was about

TABLE V-6

ESTIMATES OF ANNUAL WATER LOSSES AT VERNALIS
IN BELOW NORMAL YEARS

1	2	3	4	5	6	7	8	9	10	11	12	13	14	15
Below Normal Year	Vernalis Unimpaired KAF	Vernalis Actual KAF	Net Loss @ Vernalis KAF	Estimated Loss @ Vernalis Due to Post 1947 Development Above Vernalis - KAF		Friant Unimpaired KAF	San Joaquin @ Friant KAF	Actual Upper San Joaquin KAF	Net Loss Upper San Joaquin KAF	Estimated Loss @ Vernalis Due to Post 1947 Development, Upper San Joaquin - KAF	Madera Canal Diversion KAF	Friant-Kern Canal Diversion KAF	Delta-Mendota Canal Delivery to Mendota Pool KAF	Net Central Valley Project Inter-Basin Transfer KAF
1923	5,512	N.A.				1,654	N.A.	N.A.						
1925	5,505	N.A.				1,439	N.A.	N.A.						
1928	4,365	N.A.				1,154	N.A.	228	926					
Avg. *														
1948	4,218	1,553	2,665	1,186		1,215	1,006	103	1,112	473	76	0	0	0
1949	3,799	1,247	2,552	1,044		1,164	1,068	119	1,045	578	152	0	0	0
1950	4,656	1,786	2,870	1,559		1,311	974	108	1,203	699	118	198	0	-198
1953	4,554	1,891	2,663	950		1,227	351	211	1,016	404	193	741	668	- 73
1954	4,315	1,717	2,598	1,370		1,314	262	179	1,135	569	212	811	824	+ 13
1955	3,512	975	2,537	1,195		1,161	107	145	1,016	448	219	805	927	+122
1957	4,292	1,442	2,850	1,400		1,327	149	205	1,122	547	242	990	919	- 71
1966	3,985	1,696	2,289	1,053		1,299	62	247	1,052	628	442	1,066	1,059	- 7
Avg.	4,166	1,538	2,628	1,219		1,252		165	1,088	543	207	833	879	- 3

*Note: Since there were no data for Vernalis flows in 1923, 1925, and 1928 no adjustments were possible for flow restrictions.

40

TABLE V-7

ESTIMATES OF APRIL TO SEPTEMBER WATER LOSSES AT VERNALIS
IN BELOW NORMAL YEARS

1	2	3	4	5	6	7	8	9	10	11	12	13	14	15
Below Normal Year	Vernalis Unimpaired KAF	Vernalis Actual KAF	Net Loss @ Vernalis KAF	Estimated Loss @ Vernalis Due to Post 1947 Development Above Vernalis - KAF		Friant Unimpaired KAF	San Joaquin @ Friant KAF	Actual Upper San Joaquin KAF	Net Loss Upper San Joaquin KAF	Estimated Loss @ Vernalis Due to Post 1947 Development Upper San Joaquin KAF	Madera Canal Diversion KAF	Friant-Kern Canal Diversion KAF	Delta-Mendota Canal Delivery to Mendota Pool KAF	Net Central Valley Project Inter-Basin Transfer KAF
1923	4,123	N.A.				1,303	N.A.	838	465					
1925	4,056	N.A.				1,163	N.A.	N.A.						
1928	2,675	N.A.				801	N.A.	200	601					
Avg.	3,618					1,052		519	533					
1948	3,652	1,093	2,559	1,202		1,077	801	67	1,010	383	72	0	0	0
1949	3,177	573	2,604	947		1,016	838	53	963	491	150	168	0	-168
1950	3,631	1,062	2,569	1,311		1,044	743	42	1,002	511	118	180	0	-180
1953	3,275	780	2,495	898		944	184	67	877	210	179	592	615	+ 23
1954	3,216	902	2,314	1,002		1,045	138	82	963	412	207	717	720	+ 3
1955	2,723	302	2,421	973		941	57	66	875	318	199	674	780	+106
1957	3,269	630	2,639	1,240		1,071	54	94	977	389	229	793	761	- 32
1966	2,492	246	2,246	942		870	45	57	813	373	173	628	819	+191
Avg.	3,180	699	2,481	1,064		1,001	358	66	935	386	166	579	739	- 8

*See note in Table V-6

TABLE V-8

ACTUAL AND UNIMPAIRED APRIL TO SEPTEMBER FLOWS AT RIM STATIONS IN BELOW NORMAL YEARS

Below Normal Years	STANISLAUS		TUOLUMNE		MERCED		SAN JOAQUIN	
	Unimpaired at Melones KAF	Actual at Ripon KAF	Unimpaired at Don Pedro KAF	Actual at Modesto KAF	Unimpaired at Modesto KAF	Actual at Stevinson KAF	Unimpaired at Friant KAF	Actual Upper San Joaquin KAF
1923	820	624	1,310	421	690	520	1,303	838
1925	855	690	1,381	914		N.A.		N.A.
1928	416	394	792	406	391	212	725	200
AVG.	697	569	1,161	580	540	366	1,052	519
1948	781	492	1,192	359	603	211	1,077	67
1949	615	286	1,035	141	511	113	1,016	53
1950	846	535	1,187	361	553	139	1,045	42
1953	736	374	1,141	266	455	67	944	67
1954	650	335	1,037	253	484	185	1,046	82
1955	513	138	851	86	418	48	941	66
1957	661	199	1,038	152	499	169	1,071	94
1966	429	47	784	79	409	39	870	57
AVG.	654	301	1,033	212	491	121	1,001	66
ADJUSTED LOSS*		233		304		212		428

*Computed as per example in Table V-4

TOTAL SUB-BASIN LOSS = 1,177

TABLE V-9

ACTUAL AND UNIMPAIRED ANNUAL FLOWS AT RIM STATIONS IN BELOW NORMAL YEARS

Below Normal Years	STANISLAUS		TUOLUMNE		MERCED		UPPER SAN JOAQUIN	
	Unimpaired at Melones KAF	Actual at Ripon KAF	Unimpaired at Don Pedro KAF	Actual at Modesto KAF	Unimpaired at Modesto KAF	Actual at Stevinson KAF	Unimpaired at Friant KAF	Actual Upper San Joaquin KAF
1923	1,130	947	1,786	833	942	786	1,654	N.A.
1925	1,224	1,111	1,932	1,096	910	N.A.	1,439	N.A.
1928	950	777	1,525	1,028	737	390	1,154	228*
AVG.	1,101	945	1,748	986	840	588		
1948	898	584	1,418	599	688	262	1,215	103
1949	745	433	1,252	1,035	638	195	1,164	119
1950	1,076	706	1,551	696	719	232	1,311	108
1953	967	581	1,534	728	626	243	1,227	211
1954	888	500	1,445	648	668	263	1,314	179
1955	681	311	1,136	369	534	109	1,161	145
1957	894	328	1,424	529	648	255	1,327	205
1966	703	429	1,315	734	669	211	1,299	247
AVG.	856	484	1,384	667	649	221	1,252	165
ADJUSTED LOSS*		273		115		233		

*Note: There is only a single observation for the below normal years (1928) hence it was not feasible to determine an adjusted loss for the Upper San Joaquin River basin.

543,000 acre-feet in below normal years (see Column 11, Table V-6). Approximately 386,000 acre-feet of this reduction occurred during the April-September period (see Column 11, Table V-7).

Although 1923, 1925 and 1928 are not within the study period, information from these years was used to check the results of the double-mass diagram method. The information from these 3 years on an annual basis was inadequate to give a good check. As a result, the annual evaluation of the subbasins gave unreasonable results. However, the data for the April-September period seemed to be reasonable and checked the double-mass diagram method quite well.

The loss at Vernalis during the April through September period due to post-1947 development (see Table V-7), estimated by the double mass diagram method is 1,064,000 acre-feet. The total subbasin reduction in flow was computed to be 1,177,000 acre-feet (Table V-8). Using the subbasin method of evaluation, the estimated reduction in the upper San Joaquin River was about 428,000 acre-feet. The percentage at Vernalis attributed to each subbasin is as follows:*

	Percent of total reduction in flow <u>April through September</u>
Stanislaus	20%
Tuolumne	26%
Merced	18%
San Joaquin River above Merced River (CVP)	36%

* Subbasin riverflows are measured upstream from the actual mouths of the Tuolumne and Stanislaus Rivers. There may be some net accretions or diversions between these gaging stations and the lower San Joaquin River which could affect the proportion of losses attributed to each subbasin.

Summary of Impacts - Below Normal Years

In summary, the data indicate that in below normal years the effect of the CVP on the San Joaquin River at Vernalis has been as follows:

- a. On an annual basis the estimated decrease in flow was 543,000 acre-feet, which is 26 percent of the calculated pre-1944 average below normal year flow at Vernalis.
- b. During the April-September period, the decrease in flow ranged from 386,000 to 428,000 acre-feet, which corresponds to 35-38 percent of the calculated pre-1944 April-September flow at Vernalis.

ABOVE NORMAL YEARS

Seven of the 14 pre-1944 years were above normal, while only three of the post-1947 years were in this classification. Tables V-10, V-11, V-12, V-13 and Figure V-8 present the hydrologic data for the above normal years.

As indicated in Table V-10 the average Vernalis unimpaired flow during the seven pre-1944 years was 6,763,000 acre-feet, about 485,000 acre-feet greater than the average for the three post-1947 above normal years. The actual flow at Vernalis during the pre-1944 years was 5,021,000 acre-feet for an average loss of 1,742,000 acre-feet or 25.7 percent of rim station unimpaired flow. Losses increased in the post-1947 period to 3,364,000 acre-feet or 47.3 percent of the rim station unimpaired flow. When adjusted for the difference in the unimpaired flows of the two periods, the increase in loss between the two periods is 1,721,000 acre-feet annually. (See column 4 and footnote, Table V-10.)

Using the same type of analysis, the average reduction in flow in the upper San Joaquin River (Table V-11) is estimated at 1,076,000 acre-feet in above normal years. This increase in flow reduction corresponds to 21 percent of the average above normal year flow at pre-1944 Vernalis.

TABLE V-10

ESTIMATES OF ANNUAL WATER LOSSES AT VERNALIS
IN ABOVE NORMAL YEARS

1	2	3	4	5	6	7	8	9	10	11	12	13	14	15
Above Normal Year	Vernalis Unimpaired KAF	Vernalis Actual KAF	Net Loss at Vernalis at Vernalis KAF	Estimated Loss @ Vernalis Due to Post 1947 Development Above Vernalis - KAF		Friant Unimpaired KAF	San Joaquin @ Friant KAF	Actual Upper San Joaquin KAF	Net Loss-Upper San Joaquin KAF	Estimated Loss @ Vernalis Due to Post 1947 Development Upper San Joaquin - KAF	Madera Canal Diversion KAF	Friant-Kern Canal Diversion KAF	Delta-Mendota Canal Delivery to Mendota Pool KAF	Net Central Valley Project Inter-Basin Transfer KAF
1932	6,622	3,660	2,962			2,047	N.A.	989	1,058					
1935	6,418	4,030	2,388			1,923	N.A.	1,076	847					
1936	6,495	4,985	1,510			1,853	N.A.	1,467	386					
1937	6,530	5,484	1,046			2,208	N.A.	2,059	149					
1940	6,596	4,768	1,828			1,881	1,829	1,485	396					
1942	7,398	6,160	1,238			2,254	2,254	2,127	127					
1943	7,283	6,060	1,223			2,054	2,068	2,125	- 71					
Avg.	6,763	5,021	1,742			2,031		1,618	413					
1951	7,262	4,738	2,524	710		1,859	1,216	750	1,109	718	142	368	139	-229
1962	5,618	1,487	4,131	1,891		1,924	75	268	1,656	720	277	1,370	991	-379
1963	6,250	2,813	3,437	1,598		1,945	83	316	1,629	867	271	1,513	966	-547
Avg.	6,377	3,013	3,364	1,400		1,909		445	1,464	768	230	1,084	699	-385

46

Adjusted Loss = 1,721*

= 1,076*

*Computed as per example in Table V-2

TABLE V-11

ESTIMATES OF APRIL TO SEPTEMBER WATER LOSSES AT VERNALIS
IN ABOVE NORMAL YEARS

Above Normal Years	Vernalis Unimpaired KAF	Vernalis Actual KAF	Net Loss @ Vernalis KAF	Estimated Loss @ Vernalis Due to Post 1947 Development Above Vernalis - KAF		Friant Unimpaired KAF	San Joaquin @ Friant KAF	Actual Upper San Joaquin KAF	Net Loss-Upper San Joaquin KAF	Estimated Loss @ Vernalis Due to Post 1947 Development Upper San Joaquin - KAF	Madera Canal Diversion KAF	Friant-Kern Canal Diversion KAF	Delta-Mendota Canal Delivery to Mendota Pool KAF	Net Central Valley Project Inter-Basin Transfer KAF
1932	4,829	2,388	2,441			1,578	N.A.	588	990					
1935	5,152	3,131	2,021			1,579	N.A.	816	763					
1936	4,489	2,801	1,688			1,410	N.A.	765	645					
1937	4,746	3,372	1,374			1,670	N.A.	1,144	526					
1940	4,107	2,827	1,280			1,336	1,250	836	500					
1942	5,461	3,834	1,627			1,762	1,329	1,222	540					
1943	4,417	3,020	1,397			1,407	1,281	1,011	396					
Avg.	4,743	3,053	1,690			1,534		911	623					
1951	2,909	919	1,990	1,783		960	588	74	886	308	140	345	139	- 206
1962	4,358	647	3,711	1,832		1,558	46	51	1,507	470	268	1,151	837	- 314
1963	4,560	1,753	2,807	1,581		1,515	58	159	1,356	542	262	1,300	744	- 556
Avg.	3,942	1,106	2,836	1,732		1,344		95	1,250	440	223	864	573	359

Adjusted Loss = 1,432*

= 704*

*Computed as per example in Table V-2

47

TABLE V-12

ACTUAL AND UNIMPAIRED ANNUAL FLOWS AT RIM STATIONS IN ABOVE NORMAL YEARS

Above Normal Years	STANISLAUS		TUOLUMNE		MERCED		SAN JOAQUIN	
	Unimpaired at Melones KAF	Actual at Ripon KAF	Unimpaired at Don Pedro KAF	Actual at Modesto KAF	Unimpaired at Modesto KAF	Actual at Stevinson KAF	Unimpaired at Friant KAF	Actual Upper San Joaquin KAF
1932	1,353	939	2,109	1,097	1,113	549	2,047	989
1935	1,214	974	2,110	1,251	1,171	735	1,923	1,076
1936	1,322	1,075	2,168	1,418	1,152	757	1,853	1,467
1937	1,109	869	1,998	1,383	1,215	828	2,208	2,059
1940	1,400	1,152	2,221	1,322	1,095	706	1,881	1,485
1942	1,485	1,247	2,373	1,786	1,287	965	2,254	2,127
1943	1,566	1,268	2,376	1,712	1,289	973	2,054	2,125
AVG.	1,350	1,075	2,194	1,424	1,189	788	2,031	1,618
1951	1,694	1,436	2,484	1,668	1,225	801	1,859	750
1962	995	407	1,773	365	928	380	1,924	268
1963	1,268	861	2,053	990	984	505	1,945	316
AVG.	1,319	901	2,103	1,008	1,046	562	1,909	445
ADJUSTED LOSS		149*		357*		131*		1,076*
							TOTAL SUB-BASIN LOSS = 1,713	

*Computed as per example in Table V-4

TABLE V-13

ACTUAL AND UNIMPAIRED APRIL TO SEPTEMBER FLOWS AT RIM STATIONS IN ABOVE NORMAL YEARS

Above Normal Years	STANISLAUS		TUOLUMNE		MERCED		SAN JOAQUIN		
	Unimpaired at Melones KAF	Actual at Ripon KAF	Unimpaired at Don Pedro KAF	Actual at Modesto KAF	Unimpaired at Modesto KAF	Actual at Stevinson KAF	Unimpaired at Friant KAF	Actual Upper San Joaquin KAF	
1932	996	674	1,515	770	740	310	1,578	588	
1935	1,014	791	1,647	1,040	912	580	1,579	816	
1936	884	671	1,452	795	743	481	1,410	765	
1937	827	622	1,441	868	808	531	1,670	1,144	
1940	799	615	1,315	714	657	475	1,336	836	
1942	1,063	826	1,705	1,133	931	675	1,762	1,222	
1943	872	623	1,400	792	738	498	1,407	1,011	
AVG.	922	689	1,496	873	790	507	1,534	911	
1951	545	286	957	350	443	193	964	74	
1962	794	256	1,337	109	670	202	1,558	51	
1963	876	616	1,477	505	692	376	1,515	159	
AVG.	738	386	1,257	321	602	257	1,344	95	
ADJUSTED LOSS		165*		412*		129*		700*	
							TOTAL SUB-BASIN LOSS = 1,406		

*Computed as per example in Table V-4

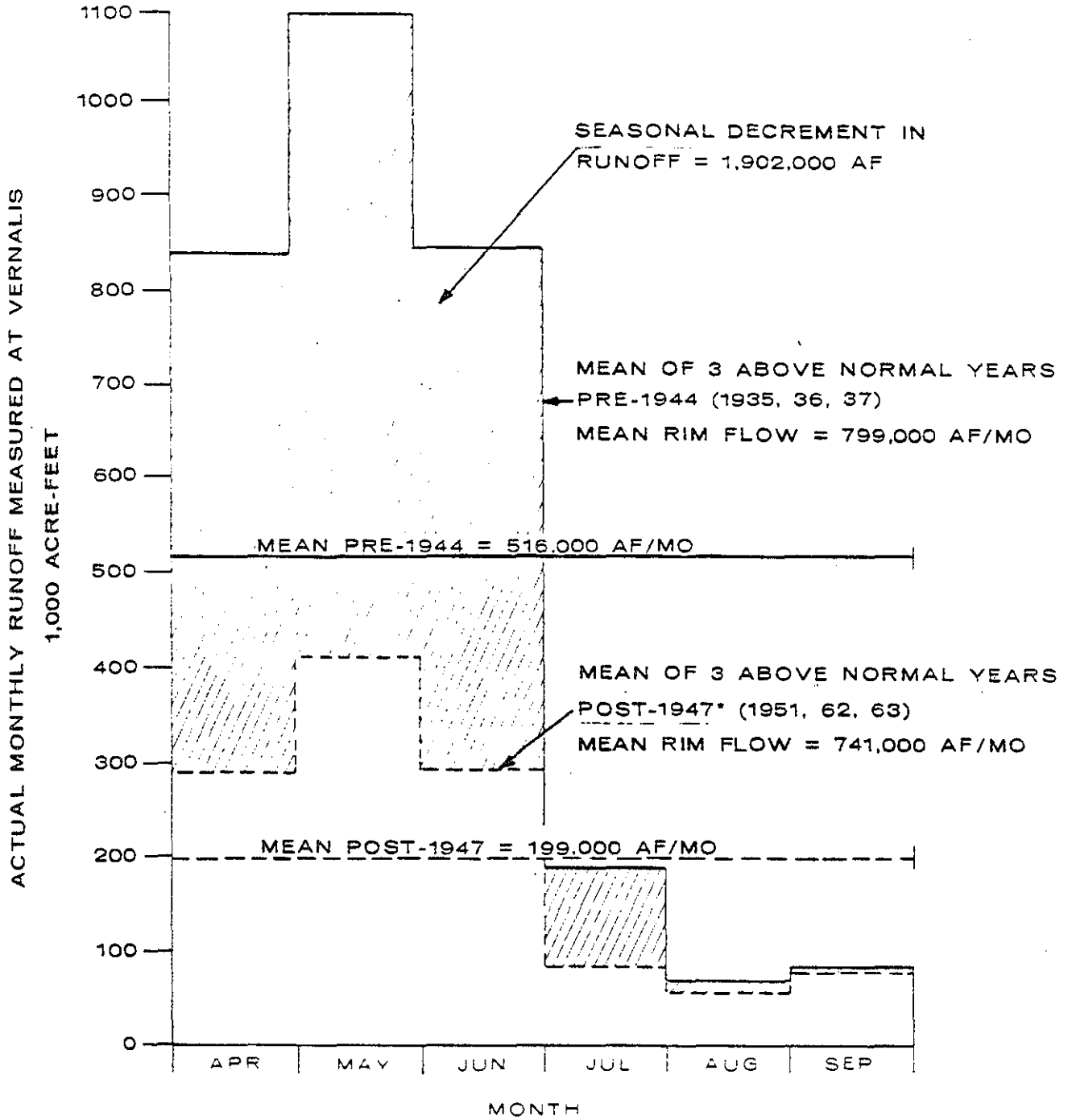

ACTUAL RUNOFF AT VERNALIS DURING APRIL-SEPTEMBER PERIOD IN ABOVE NORMAL YEARS PRE-1944 (1935, 36, 37) AND POST-1947 (1951, 62, 63)
* ADJUSTED TO PRE-1944 BASE BY RATIO OF RIM FLOWS

Estimation by the double mass diagram method indicates the average annual loss at Vernalis to be 1,400,000 acre-feet in above normal years with the contribution from above the upper San Joaquin River being 768,000 acre-feet.

The subbasin analysis for annual flows, summarized in Table V-12 produced the following results:

	<u>Increased Losses KAF</u>
Stanislaus	149,000
Tuolumne	357,000
Merced	131,000
San Joaquin	1,076,000
Total	1,713,000

In the evaluation of the April through September period of the above normal years (Tables V-11 and V-13), the basin analysis and the subbasin analysis were again in close agreement with the double mass diagram method producing appreciably different results. The table below summarizes results obtained by the three methods of analysis:

<u>Method</u>	<u>Estimated reduction flow at Vernalis, KAF</u>	
	<u>Annual</u>	<u>April-Sept</u>
Double mass diagram	1400	1732*
Basin comparison	1721	1400
Subbasin comparison	1713	1406
	<u>Estimated reduction in flow in the</u>	
	<u>Upper San Joaquin River, KAF</u>	
<u>Method</u>	<u>Annual</u>	<u>April-Sept</u>
Double mass diagram	768	440
Basin comparison	1076	704

* Analysis by the double mass diagram method gives a higher estimate for the April-September period than for the annual period. This anomaly results from the statistical treatment of the data, i.e., fitting data with a regression line.

As the above table indicates, the flow reduction at Vernalis due to post-1947 development averaged from 1,400,000 to 1,721,000 acre-feet with almost all the reduction occurring in the April through September period. The reduction at Vernalis due to development in the upper San Joaquin River basin is estimated to range from 768,000 to 1,076,000 acre-feet in above normal years. About 440,000 to 700,000 acre-feet of the reduction occurs in the April-September period. The following table indicates the percentage of the April-September reduction attributable to the various river basins.

Stanislaus	12 percent
Tuolumne	29 percent
Merced	9 percent
Upper San Joaquin	50 percent

Summary of Impacts - Above Normal Years

In summary, the data indicate that in above normal years the effect of the CVP on the San Joaquin River at Vernalis has been as follows:

- a. On an annual basis, the estimated decrease in flow ranged from 768,000 to 1,076,000 acre-feet, which corresponds to 15 - 21 percent of pre-1944 average above normal flows at Vernalis.
- b. During the April-September period, the estimated decrease in flow ranged from 440,000 to 704,000 acre-feet, which corresponds to 14 - 23 percent of pre-1944 average above normal flows at Vernalis during the period.

WET YEARS

Six of the post-1947 years and two of the pre-1944 years are classified as wet. Tables V-14, V-15, V-16, and V-17 present the hydrologic data for these years.

Analysis of wet year hydrologic data is somewhat complicated by the contribution of unmeasured flows to the valley floor. Consequently, the sum of rim station unimpaired flows is not necessarily a good estimate of available water. Nevertheless, for comparison purposes the same procedures were applied as for other year classes.

The unimpaired flow at Vernalis during pre-1944 wet years averaged 9,596,000 acre-feet; in the post-1947 wet years the average was 9,626,000 acre-feet. According to the double mass diagram method, substantial reduction in runoff resulted in the post-1947 period, averaging (after adjustment) about 2,609,000 acre-feet for the full year. In the April-September period the corresponding reduction in flow between pre-1944 and post-1947 years was about 1,740,000 acre-feet. (See Tables 14 and 15, calculation of adjusted losses.)

Analysis of the data for the upper San Joaquin basin by the double mass diagram method indicates average reduction in flow to the valley floor of 1,706,000 acre-feet for the annual period and 965,000 acre-feet during the April-September period.

Analysis by the subbasin comparison methods, as summarized in Tables V-16 and V-17, indicates relatively higher proportions of the reduction in flow attributed to development in the upper San Joaquin basin. On an annual basis the adjusted reduction was 2,916,000 acre-feet for the four subbasins, 2,014,000 acre-feet, or 69 percent of which is attributed to the CVP. In the April-September period the reduction in valley floor runoff was 1,760,000 acre-feet for the four subbasins, and 860,000 acre-feet, or 55 percent of which was attributed to the CVP.

TABLE V-14

ESTIMATES OF ANNUAL WATER LOSSES AT VERNALIS
IN WET YEARS

1	2	3	4	5	6	7	8	9	10	11	12	13	14	15
Wet Year	Vernalis Unimpaired KAF	Vernalis Actual KAF	Net Loss @ Vernalis KAF	Estimated Loss @ Vernalis Due to Post 1947 Development Above Vernalis - KAF		Friant Unimpaired KAF	San Joaquin @ Friant KAF	Actual Upper San Joaquin KAF	Net Loss - Upper San Joaquin KAF	Estimated Loss @ Vernalis Due to Post 1947 Development Upper San Joaquin - KAF	Madera Canal Diversion KAF	Friant-Kern Canal Diversion KAF	Delta-Mendota Canal Delivery to Mendota Pool KAF	Net Central Valley Project Inter-Basin Transfer KAF
1938	11,248	10,840	408			3,688	N.A.	4,992	-1,304					
1941	7,945	7,298	647			2,652	2,589	3,244	- 592					
Avg.	9,596	9,069	527			3,170		4,118	- 622					
1952	9,312	7,144	2,168	215		2,840	2,084	2,090	750	935	179	462	122	-340
1956	9,679	6,305	3,374	840		2,960	1,225	1,319	1,641	551	239	1,322	519	-803
1958	8,367	6,056	2,311	561		2,631	1,180	1,657	974	514	244	1,145	447	-698
1965	8,108	3,795	4,313	1,994		2,272	63	397	1,875	448	324	1,631	995	-636
1967	9,993	5,561	4,432	2,230		3,232	1,269	1,601	1,631	1,250	389	1,422	572	-841
1969	12,295	10,070	2,225			4,040	2,208	4,202	- 162	930	404	1,082	378	-704
Avg.	9,626	6,488	3,138	1,168		2,996		1,878	1,118	771	356	1,177	607	-607

Adjusted Loss = 2,608*

= 1,705*

*Computed as per example in Table V-2

ES

TABLE V-15

ACTUAL AND UNIMPAIRED ANNUAL FLOWS AT RIM STATIONS IN WET YEARS

Wet Years	STANISLAUS		TUOLUMNE		MERCED		SAN JOAQUIN	
	Unimpaired at Melones KAF	Actual at Ripon KAF	Unimpaired at Don Pedro KAF	Actual at Modesto KAF	Unimpaired at Modesto KAF	Actual at Stevinson KAF	Unimpaired at Friant KAF	Actual Upper San Joaquin KAF
1941	1,338	1,176	2,500	1,750	1,454	1,083	2,652	3,244
1938	2,045	1,836	3,435	2,595	2,080	1,690	3,688	4,992
AVG.	1,692	1,506	2,968	2,172	1,767	1,387	3,170	4,118
1952	1,919	1,529	2,989	2,116	1,563	1,141	2,840	2,090
1956	1,883	1,542	3,162	1,999	1,675	1,158	2,960	1,319
1958	1,678	1,180	2,649	1,855	1,409	1,058	2,631	1,657
1965	1,702	1,192	2,748	1,333	1,386	690	2,272	397
1967	1,932	1,355	3,113	1,751	1,716	718	3,232	1,601
1969	2,210	1,707	3,856	2,422	2,188	1,260	4,040	4,202
AVG.	1,887	1,418	3,086	1,913	1,656	1,004	2,996	1,878
ADJUSTED LOSS		261*		345*		296*		2,014*

TOTAL SUB-BASIN LOSS = 2,916

*Computed as per example in Table V-4

TABLE V-16

ESTIMATES OF APRIL TO SEPTEMBER WATER LOSSES AT VERNALIS
IN WET YEARS

Wet Years	Vernalis Unimpaired KAF	Vernalis Actual KAF	Net Loss @ Vernalis KAF	Estimated Loss @ Vernalis Due to Post 1947 Development Above Vernalis - KAF		Friant Unimpaired KAF	San Joaquin @ Friant KAF	Actual Upper San Joaquin KAF	Net Loss- Upper San Joaquin KAF	Estimated Loss @ Vernalis Due to Post 1947 Development Upper San Joaquin - KAF	Madera Canal Diversion KAF	Friant-Kern Canal Diversion KAF	Delta-Mendota Canal Delivery to Mendota Pool KAF	Net Central Valley Project Inter-Basin Transfer KAF
1938	7,668	6,494	1,174			2,744	N.A.	N.A.	500 ^E					
1941	5,718	4,444	1,274			2,035	1,855	1,810	225					
Avg.	6,693	5,469	1,224			2,389			362					
1952	7,124	4,678	2,446	431		2,315	1,570	1,354	961	416	179	431	99	- 322
1956	5,535	2,404	3,131	925		1,899	462	212	1,687	317	226	976	429	- 547
1958	6,691	4,448	2,243	561		2,216	1,067	1,330	886	379	237	952	367	- 585
1965	4,971	1,545	3,426	2,072		1,594	40	116	1,478	724	285	1,051	735	- 316
1967	7,527	4,192	3,335	1,503		2,548	1,185	1,370	1,178	913	351	1,047	340	- 707
1969	8,421	5,181	3,240	518		3,075	1,250	1,976	1,099	577	356	1,023	280	- 743
Avg.	6,712	3,741	2,970	1,002		2,275		1,060	1,215	554	272	913	375	- 537

Adjusted Loss = 1,742*

= 965*

*Computed as per example in Table V-2

TABLE V-17

ACTUAL AND UNIMPAIRED APRIL TO SEPTEMBER FLOWS AT RIM STATIONS IN WET YEARS

Wet Years	STANISLAUS		TUOLUMNE		MERCED		SAN JOAQUIN	
	Unimpaired at Melones KAF	Actual at Ripon KAF	Unimpaired at Don Pedro KAF	Actual at Modesto KAF	Unimpaired at Modesto KAF	Actual at Stevinson KAF	Unimpaired at Friant KAF	Actual Upper San Joaquin KAF
1941	953	804	1,746	1,096	984	750	2,035	1,810
1938	1,387	1,174	2,240	1,594	1,297	974	2,744	N.A.
AVG.	1,170	989	1,993	1,345	1,140	862		
1952	1,481	1,080	2,217	1,264	1,110	830	2,316	1,354
1956	1,007	733	1,727	808	902	536	1,899	212
1958	1,307	897	2,073	1,140	1,095	861	2,216	1,330
1965	977	514	1,593	468	807	331	1,594	116
1967	1,423	971	2,258	1,085	1,298	671	2,548	1,370
1969	1,426	868	2,518	1,225	1,401	718	3,076	1,976
AVG.	1,270	844	2,064	998	1,102	658	2,275	1,060
ADJUSTED LOSS		230*		395*		175*		960*

TOTAL SUB-BASIN LOSS = 1,760

*Computed as per example in Table V-4

FLOW DURATION ANALYSIS

Reductions in the flow of the San Joaquin River at Vernalis do not always of themselves adversely affect the southern Delta. Much of the flow reduction occurred in above normal and wet years, providing a necessary flood control function for the lower San Joaquin River. Some of the flow reduction occurs at times when the water is not required to maintain a minimum flow requirement at Vernalis. Therefore, it is useful to determine the frequency and duration of flows below certain thresholds. While specific requirements for the San Joaquin River at Vernalis have not been established, flow-duration curves provide useful information for impact assessment. Figures V-9, V-10, V-11, and V-12 graphically illustrate the percentage of the time the San Joaquin River flow at Vernalis is less than any given assumed level of flow. The example in Figure V-9 demonstrates how the flow-duration curves can be used to compare the pre-1944 and post-1947 conditions at Vernalis. For example, during the pre-1944 dry years the flow was less than $1,100 \text{ ft}^3/\text{s}$ 36 percent of the time. In the post-1947 dry years flow was less than $1,100 \text{ ft}^3/\text{s}$ 60 percent of the time.

Comparisons can be made for any flow value during all year types except below normal years. There were no pre-1944 below normal years in the study period.

It is not within the scope of this report to determine the level of San Joaquin River flow at Vernalis below which the impact on the southern Delta water supply becomes a damaging impact in relation to adequacy of downstream

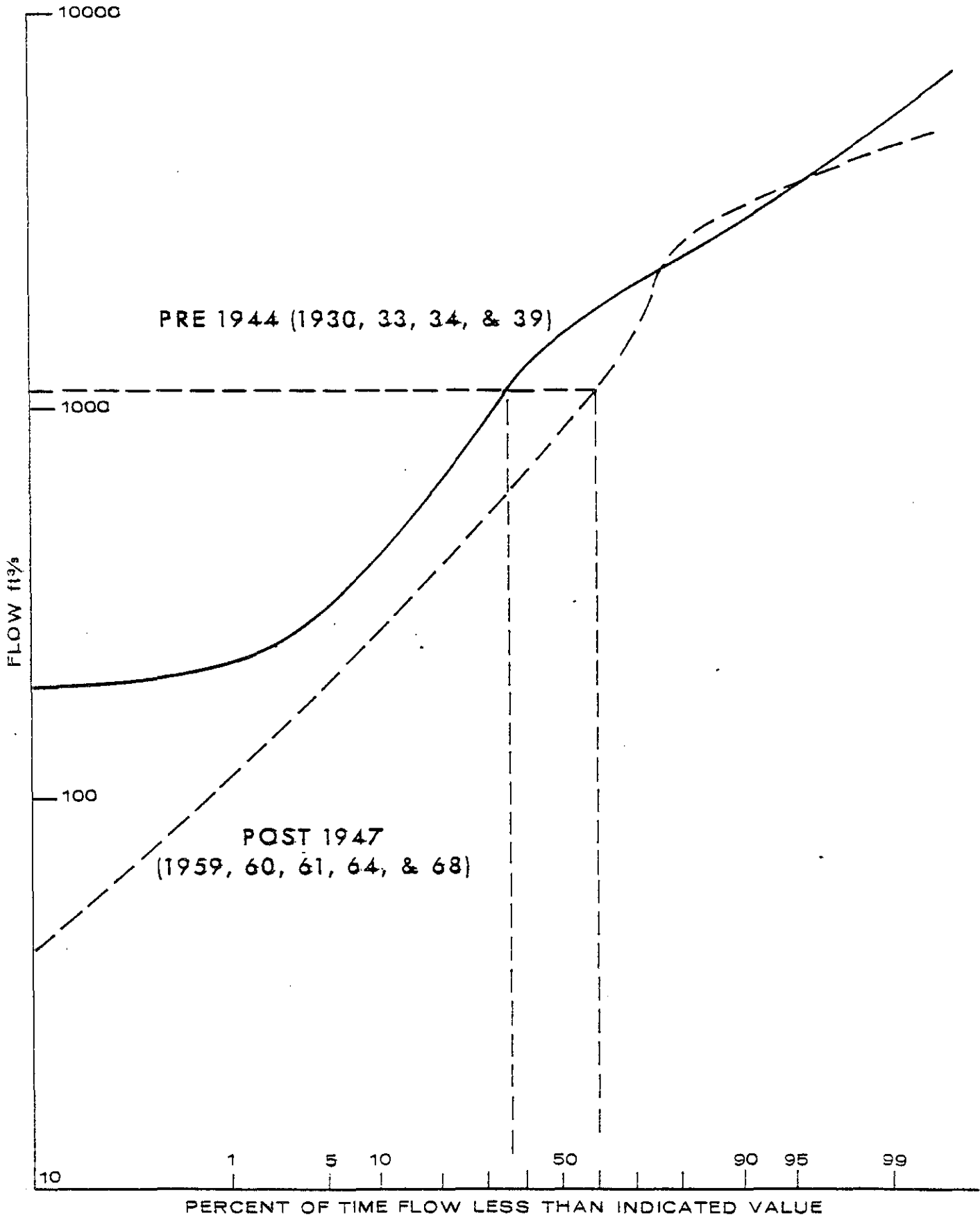

SAN JOAQUIN RIVER NEAR VERNALIS
DRY YEARS FLOW DURATION

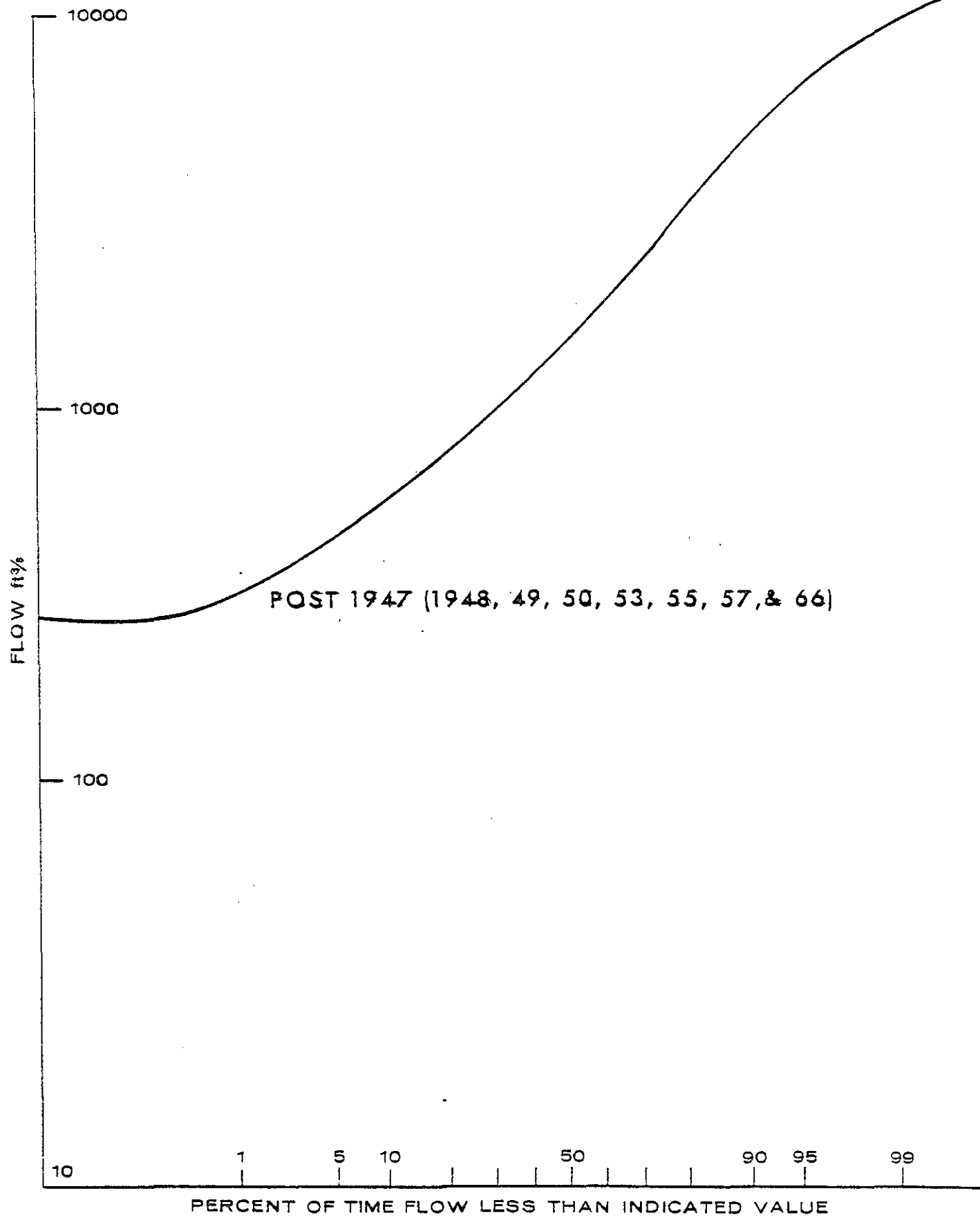

SAN JOAQUIN RIVER NEAR VERNALIS
BELOW NORMAL FLOW DURATION

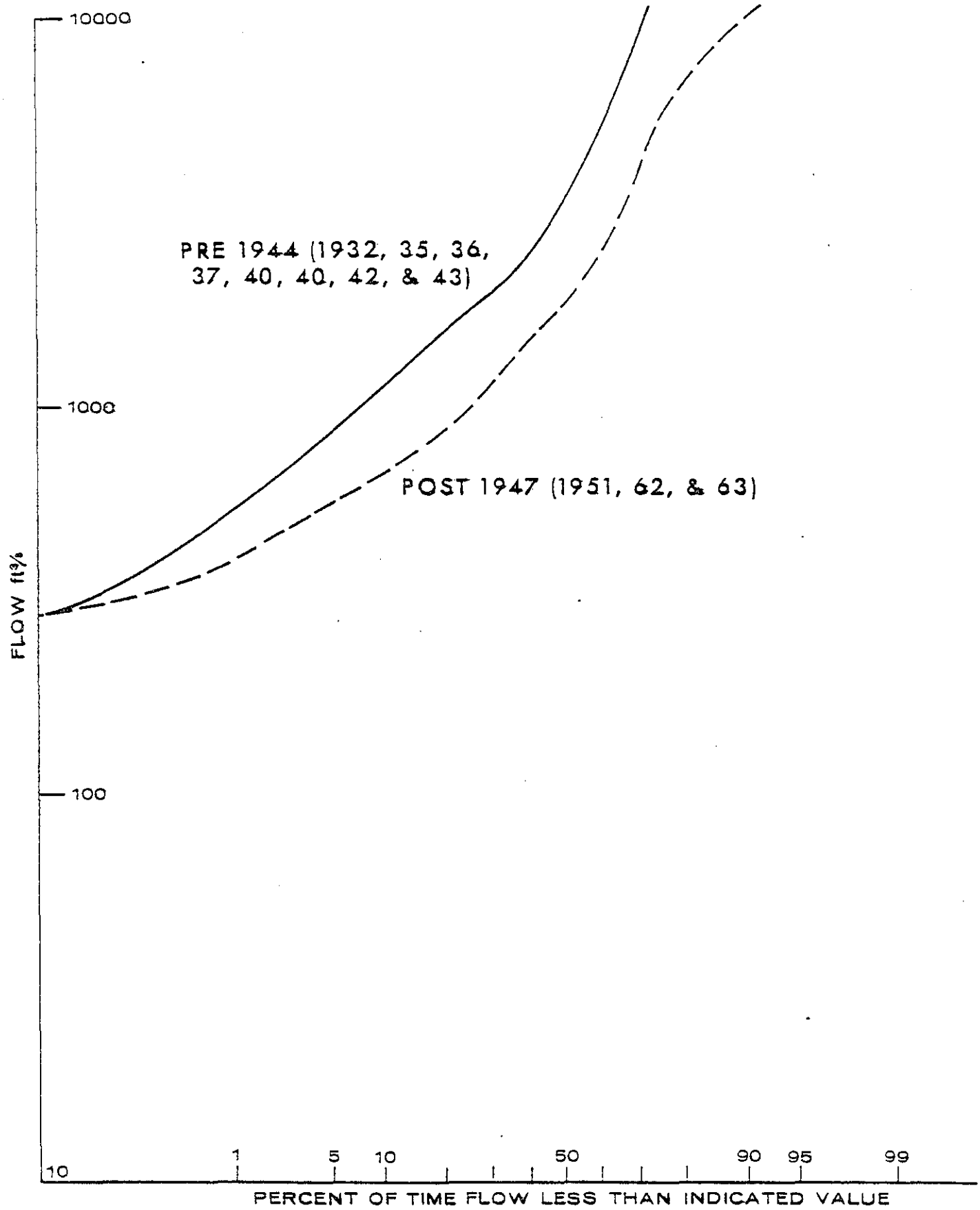

SAN JOAQUIN RIVER NEAR VERNALIS
ABOVE NORMAL YEARS FLOW DURATION

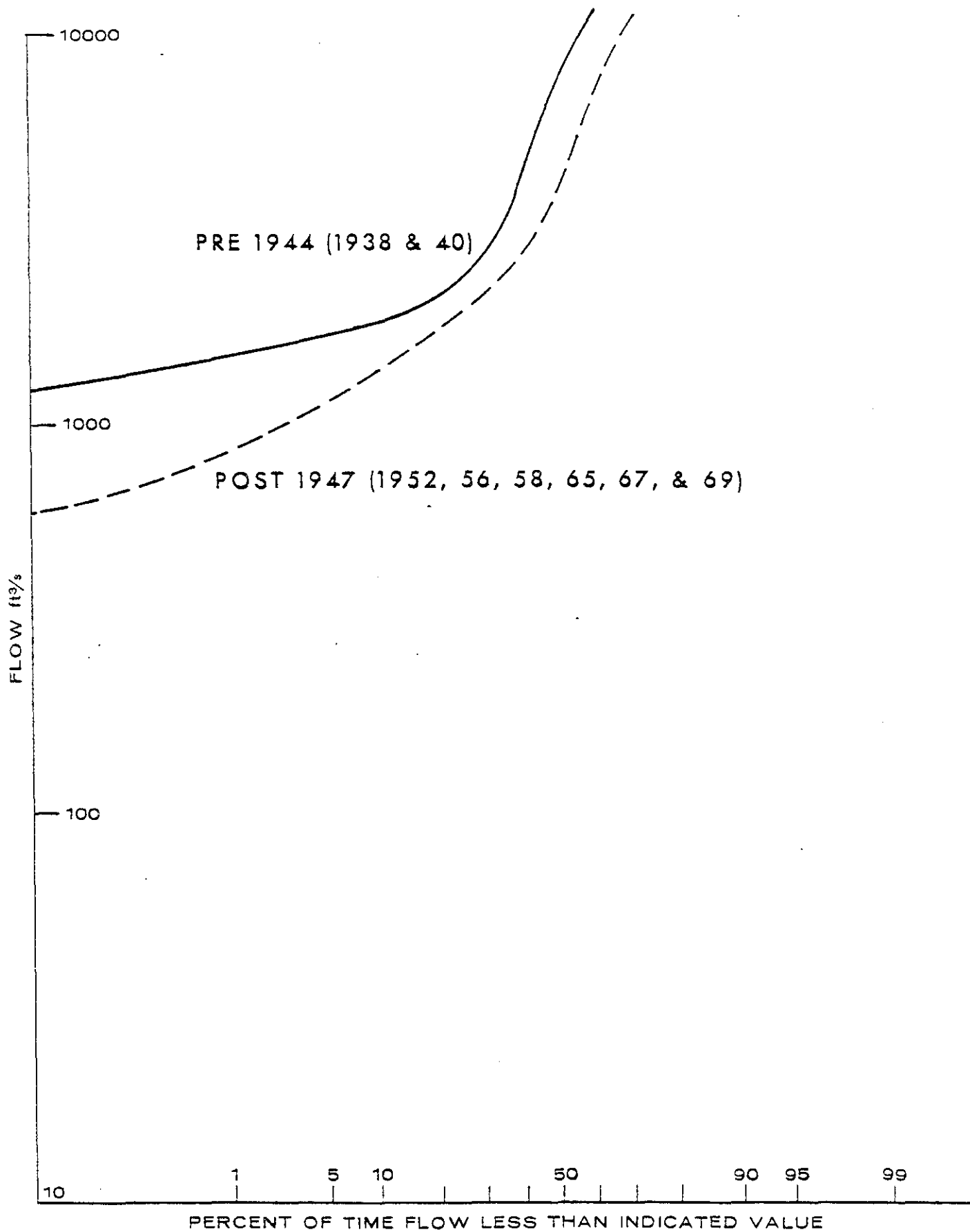

SAN JOAQUIN RIVER NEAR VERNALIS
WET YEARS FLOW DURATION

channel flow for removal of incoming salt load, or in relation to dilution of incoming salts, or in relation to adequate channel water depth for pump draft, etc. The flow required to prevent damage will depend, among other things, on the quality of the water.

However, the Service developed a procedure to estimate the flow reduction attributable to the CVP which might cause the flow of the San Joaquin River near Vernalis to drop below required minimums. Since the minimum flow requirements have not yet been established, the procedure was used to produce curves which relate total loss and minimum flow requirement. Curves representing dry, below normal, above normal and wet years for the October-March period, the April-September period and the annual total, are presented on Figures V-13, V-14 and V-15, respectively.

The procedure utilized generalized equations developed using the double-mass diagram method to estimate the flow at Vernalis at a pre-1944 level of development for the 1948 through 1969 period. A similar method was used to estimate the flow at Vernalis with pre-1944 development in the lower San Joaquin River basin and post-1947 development in the upper San Joaquin River basin for the same 1948 through 1969 period. The values calculated using the procedure were then compared to the actual flows recorded at Vernalis to determine the effect of total post-1944 development and the effect of CVP.

Table V-20 is an example of the results of computation. Column 1 is the actual flow recorded at Vernalis for the month of October of the indicated water year. The corresponding flow estimated for a pre-1944 level of development is listed in column 2. Column 3 is the estimated flow at Vernalis assuming pre-1944 level of development in the lower San Joaquin River basin and a post-1947 level of development in the upper San Joaquin River basin.

TABLE V-18

OCT		SAN JOAQUIN RIVER NEAR VERNALIS				
	(1)	(2)	(3)	(4)	(5)	
				DEVELOPMENT ABOVE MERCED RIVER		
YEAR	ACTUAL HISTORIC FLOW (KAF)	ESTIMATED FLOW PRE 1944 LEVEL OF DEVELOPMENT (KAF)	ESTIMATED FLOW WITH POST 1947 DEVELOPMENT ABOVE NEWMAN ONLY (KAF)	POST 1947 IMPACT (KAF)	CONTRIBUTION TO VERNALIS FLOW REDUCTION BELOW 1,500 ft ³ /s (KAF)	
1948	80.8	32.4	22.8	9.6	9.6	
1949	95.2	101.0	90.6	4.4		
1950	77.9	117.8	113.7	4.1	1.5	
1951	81.4	49.3	42.2	7.2	7.2	
1952	109.7	118.0	112.8	5.2		
1953	114.7	123.3	116.2	7.1		
1954	100.2	106.4	102.5	3.9		
1955	32.3	67.8	65.3	2.5	2.5	
1956	49.2	82.4	79.9	2.6	2.6	
1957	122.9	85.7	74.6	11.0		
1958	126.4	136.8	129.9	6.9		
1959	174.3	183.2	176.4	6.8		
1960	53.9	62.6	54.9	7.7	7.7	
1961	43.8	75.2	71.7	3.6	3.6	
1962	25.2	61.0	56.9	4.1	4.1	
1963	89.4	58.3	50.9	7.4	7.4	
1964	164.6	131.7	121.0	10.7		
1965	86.8	48.8	43.5	4.2	4.2	
1966	181.0	189.9	182.5	7.3		
1967	67.7	74.5	71.8	2.7	2.7	
1968	167.6	139.7	128.4	11.3		
1969	85.1	93.7	87.4	6.3	5.3	

COLUMNAR EXPLANATION:

$$(4) = (2) - (3)$$

$$\text{IF } (2) \text{ GREATER THAN } (6) : (5) = [(4) / \{(2) - (1)\}] * [(6) - (1)]$$

$$\text{IF } (2) \text{ LESS THAN } (6) : (5) = (2) - (3)$$

An estimate of the total flow reduction at Vernalis due to development in the upper San Joaquin basin was then made by subtracting column 3 from column 2. The actual historic flow at Vernalis is then compared to the Vernalis target flow, in the case of this example, 1,500 ft³/s or 92,200 acre-feet for the month. If column 2 is less than the target flow, the contribution to the Vernalis flow reduction by development in the upper San Joaquin River basin is estimated as column 2 - column 3. If column 2 is greater than the target flow, the contribution is computed as a percentage of the total reduction at Vernalis using the equation on table V-18.

The procedure was used to estimate the contribution to flow reduction below various target flows at Vernalis for the 1948-1969 period. Figures V-13, V-14, and V-15 show the curves prepared for the development in the upper San Joaquin River basin average contribution to the reduction of flow at Vernalis below the indicated target flow.

These curves provide a method of estimating CVP impact on flows below a target flow at Vernalis during various year types. For example, if the target flow at Vernalis during April-September was 1,500 ft³/s, the average CVP contribution to a flow reduction below the target flow as determined from Figure V-14 would be:

In wet years	1,000 acre-feet
In above normal years	20,000 acre-feet
In below normal years	13,000 acre-feet
In dry years	9,000 acre-feet

It is the position of SDWA that the damaging CVP impact on San Joaquin River flow at Vernalis is the difference between the actual flow at Vernalis at

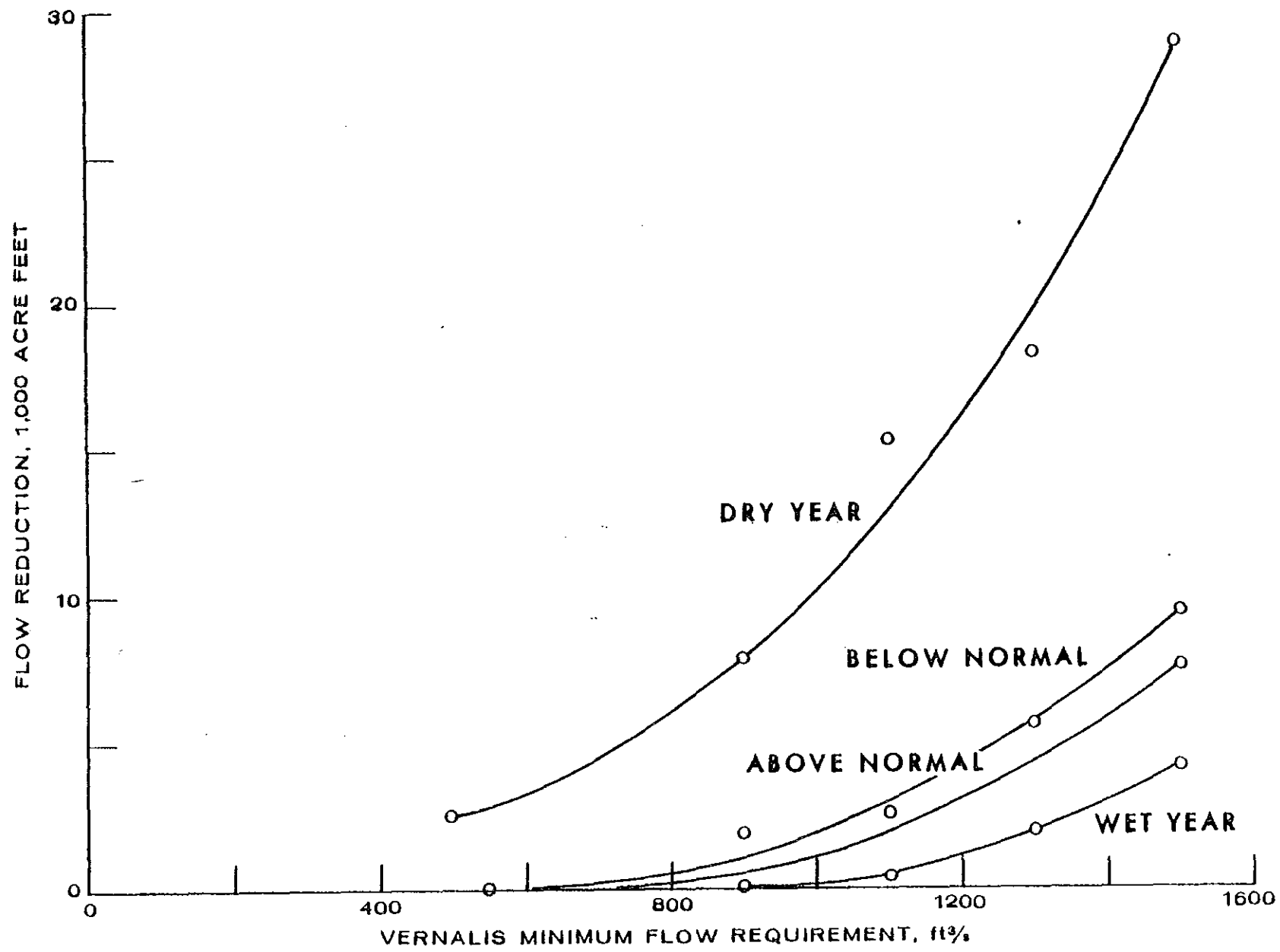

VERNALIS FLOW REQUIREMENT VS ESTIMATED CONTRIBUTION TO VERNALIS REDUCTION FROM FLOW REQUIREMENT DUE TO DEVELOPMENT IN UPPER SAN JOAQUIN

FIGURE V.

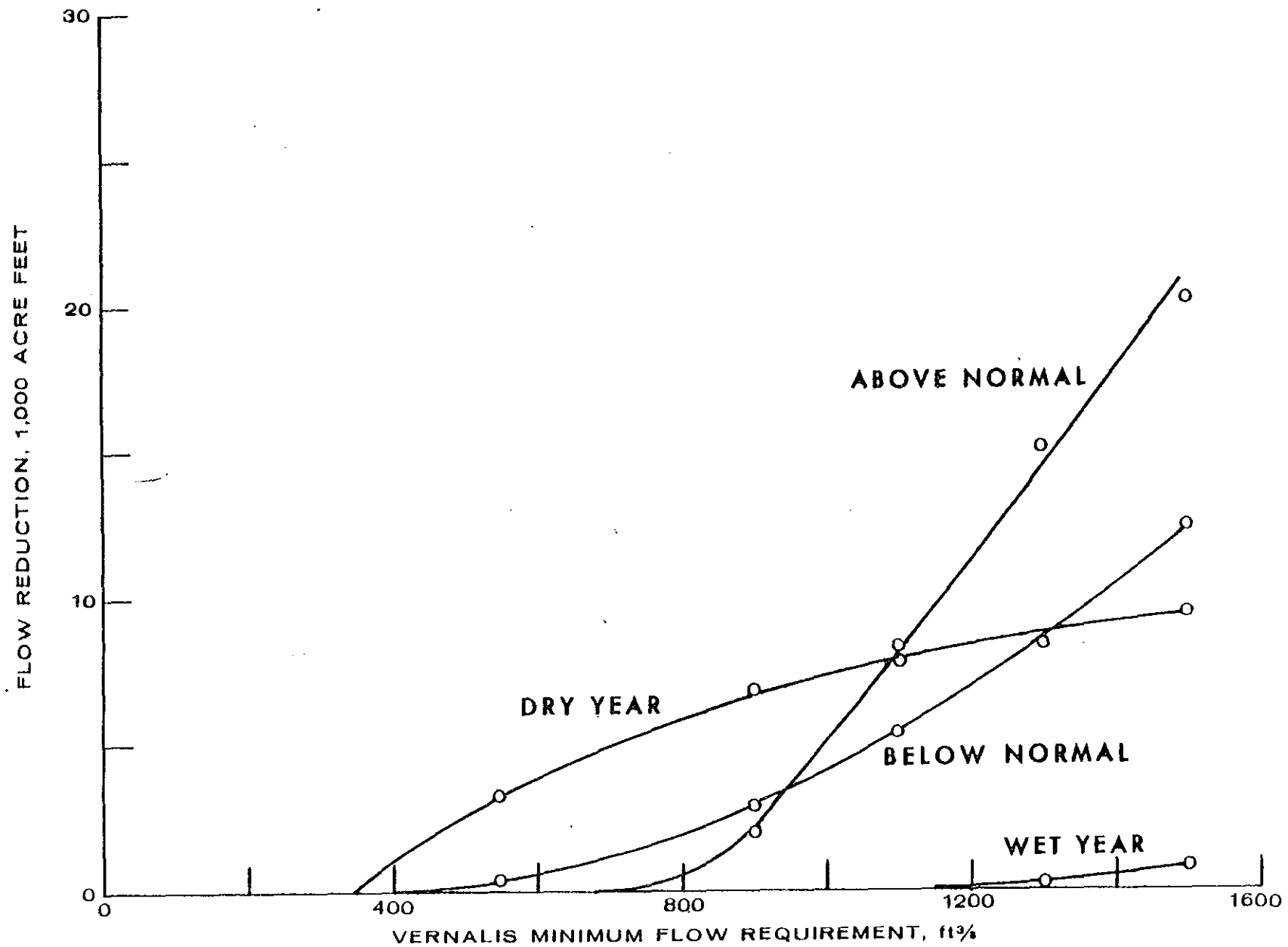

VERNALIS FLOW REQUIREMENT VS ESTIMATED CONTRIBUTION TO VERNALIS REDUCTION BELOW FLOW REQUIREMENT DUE TO DEVELOPMENT IN UPPER SAN JOAQUIN

FIGURE V.1

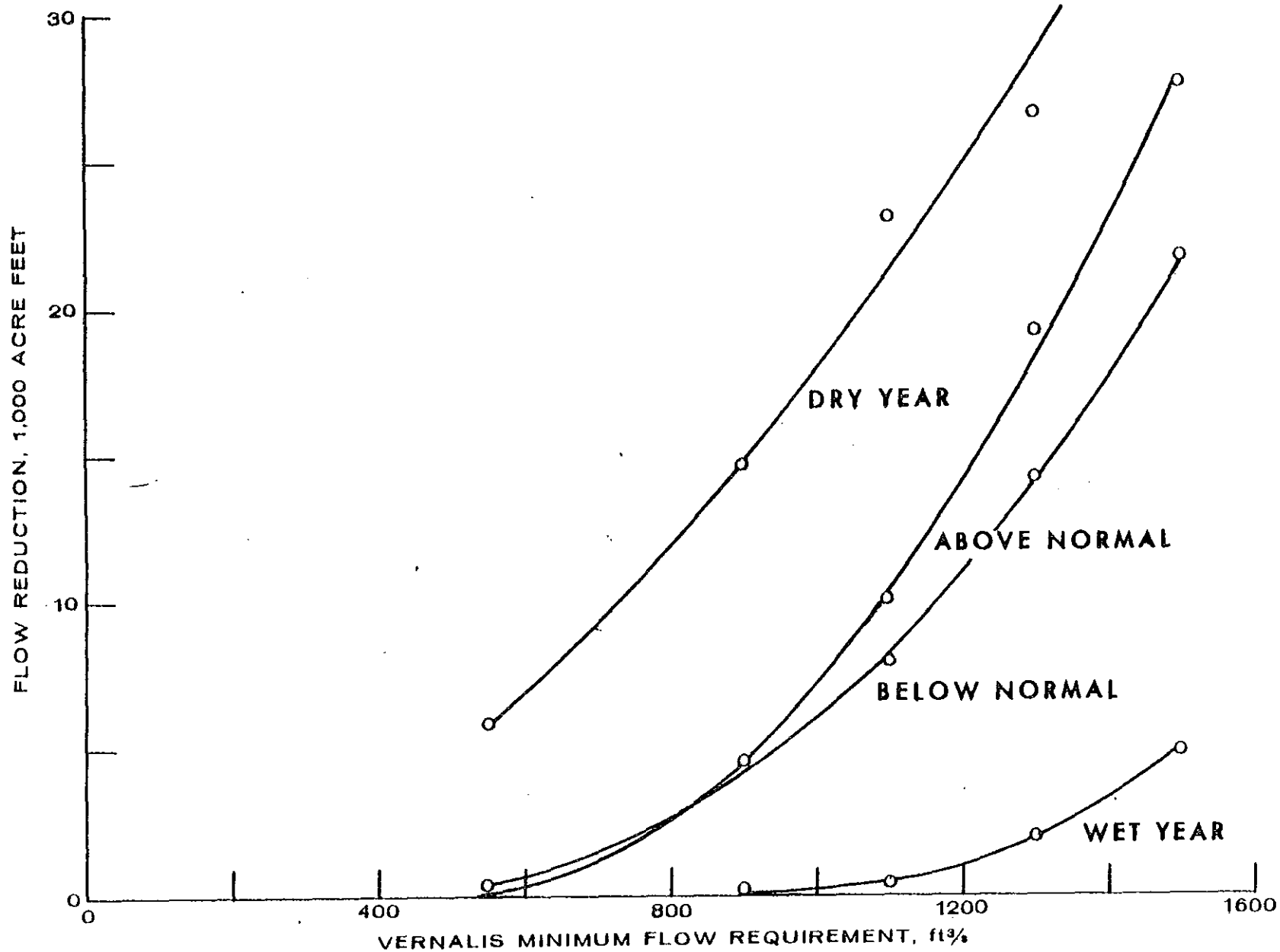

VERNALIS FLOW REQUIREMENT VS ESTIMATED CONTRIBUTION TO VERNALIS REDUCTION
BELOW FLOW REQUIREMENT DUE TO DEVELOPMENT IN UPPER SAN JOAQUIN

any time and the flow which would have occurred if the CVP did not exist in so far as these flows are below needed levels. The Service's analysis does not conform to this definition. There are times when the non-CVP developments actually increase Vernalis flows. At such times the Service's analysis uses part of that enhancement to offset the impact of the CVP flow decreases even when the remaining net flow is inadequate.

SUMMARY OF HYDROLOGIC DATA

Hydrologic data for the San Joaquin River at Vernalis for the periods 1930-1944 and 1947-1969 are summarized in Table V-19. Information presented includes unimpaired rim flows, actual flows at Vernalis, and losses, determined as the difference between unimpaired and actual flows. Averages are given for dry, below normal, above normal and wet years. Minima, medians, maxima, and average values are given for all years in each of the two periods, pre-1944 and post-1947. It will be noted that the former period includes 14 years, while the latter includes 22 years of record.

Table V-20 provides an additional summary of flow reduction in the 1948-1969 period that have resulted from development in the entire San Joaquin basin above Vernalis and in the upper San Joaquin basin. Averages of unimpaired and actual flows are given by year type for each basin in each of two calendar periods, annual and April-September. Net losses are also given.

Estimates of flow reduction due to post-1947 development were derived from the several determinations made by the double mass balance, basin comparison and subbasin comparison methods, details of which are given in Tables V-2 through V-17. In general, the values given in Table V-19 are the averages of the highest and lowest values computed by the three methods. For example, for

TABLE V-19

SUMMARY OF HYDROLOGIC DATA, 1930-1944 AND 1947-1969
SAN JOAQUIN RIVER NEAR VERNALIS

Pre-1944							Post-1947						
Unimpaired Rim		Actual		Losses			Unimpaired Rim		Actual		Losses		
Annual	Apr-Sept	Annual	Apr-Sept	Annual	Apr-Sept	Annual	Apr-Sept	Annual	Apr-Sept	Annual	Apr-Sept		
KAF	KAF	KAF	KAF	KAF	KAF	KAF	KAF	KAF	KAF	KAF	KAF		
<u>DRY</u>							<u>DRY</u>						
1931	1,660	1,203	677	121	983	1,082	1961	2,100	1,562	437	82	1,663	1,480
1934	2,288	1,303	927	196	1,361	1,107	1968	2,938	1,918	1,428	309	1,510	1,609
1939	2,909	1,909	1,708	483	1,201	1,426	1960	2,960	2,108	550	139	2,410	1,969
1930	3,254	2,490	1,268	672	1,986	1,818	1959	2,986	1,995	1,243	219	1,743	1,776
1933	3,356	2,856	1,376	647	1,980	2,209	1964	3,151	2,216	1,124	232	2,027	1,984
AVG.	(2,693)	(1,952)	(1,191)	(424)	(1,502)	(1,528)	AVG.	(2,827)	(1,960)	(957)	(196)	(1,870)	(1,764)
<u>BELOW NORMAL</u>							<u>BELOW NORMAL</u>						
No Pre-1944 years in the below normal year type.							1955	3,512	2,723	943	303	2,569	2,420
							1949	3,799	3,177	1,247	573	2,552	2,604
							1966	3,985	2,492	1,697	246	2,288	2,246
							1948	4,218	3,652	1,553	1,094	2,665	2,558
							1957	4,292	3,269	1,442	630	2,850	2,639
							1954	4,315	3,216	1,717	902	2,598	2,314
							1953	4,354	3,275	1,891	780	2,463	2,495
							1950	4,656	3,631	1,786	1,062	2,870	2,569
							AVG.	(4,141)	(3,179)	(1,534)	(699)	(2,607)	(2,480)
<u>ABOVE NORMAL</u>							<u>ABOVE NORMAL</u>						
1935	6,418	5,152	4,038	3,131	2,380	2,021	1962	5,618	4,358	1,487	848	4,131	3,510
1936	6,495	4,489	4,953	2,787	1,543	1,702	1963	6,250	4,560	2,812	1,752	3,438	2,808
1937	6,530	4,746	5,483	3,372	1,047	1,374	1951	7,262	2,906	4,738	919	2,524	1,987
1940	6,596	4,107	4,710	2,786	1,886	1,321							
1932	6,622	4,829	3,660	2,388	2,962	2,441							
1943	7,283	4,417	6,060	3,020	1,223	1,397							
1942	7,398	5,461	6,160	3,834	1,238	1,627							
AVG.	(6,763)	(4,743)	(5,009)	(3,045)	(1,754)	(1,698)	AVG.	(6,377)	(3,941)	(3,012)	(1,173)	(3,364)	(2,768)

TABLE V-10

SUMMARY OF HYDROLOGIC DATA, 1930-1944 AND 1947-1969
 SAN JOAQUIN RIVER NEAR VERNALIS (Continued)

	Pre-1944						Post-1947						
	Unimpaired Rim		Actual		Losses		Unimpaired Rim		Actual		Losses		
	Annual KAF	Apr-Sept KAF	Annual KAF	Apr-Sept KAF	Annual KAF	Apr-Sept KAF	Annual KAF	Apr-Sept KAF	Annual KAF	Apr-Sept KAF	Annual KAF	Apr-Sept KAF	
WET							WET						
1941	7,945	5,718	7,298	4,444	647	1,274	1965	8,108	4,971	3,796	1,545	4,312	3,7
1938	11,248	7,668	10,837	6,494	411	1,174	1958	8,367	6,691	6,056	4,449	2,311	2,242
							1952	9,312	7,123	7,143	4,685	2,169	2,438
							1956	9,679	5,534	6,304	2,404	3,375	3,130
							1967	9,993	7,527	5,560	4,192	4,433	3,335
							1969	12,295	8,540	10,073	5,181	2,222	3,269
AVG.	(9,597)	(6,693)	(9,067)	(5,469)	(529)	(1,224)	AVG.	(9,626)	(6,716)	(6,489)	(3,743)	(3,137)	(2,973)
<u>ALL YEARS</u>													
Min.	1,660	1,203	677	121	411	1,082		2,100	1,582	437	82	1,510	1,480
Med.	6,513	4,453	4,374	2,787	1,300	1,412		4,335	3,272	1,707	875	2,538	2,467
Max.	11,248	7,668	10,837	6,494	2,962	2,441		12,295	8,540	10,073	5,181	4,433	3,510
Avg.	(5,333)	(3,756)	(3,943)	(2,292)	(1,390)	(1,465)		(5,643)	(3,471)	(2,956)	(1,480)	(2,687)	(2,491)

Table V-20

SUMMARY OF FLOWS, LOSSES AND FLOW REDUCTIONS
SAN JOAQUIN RIVER NEAR VERNALIS
1948-1969

Year Type	Avg. Rim Station Unimpair KAF	Actual Flow KAF	ANNUAL				APRIL--SEPTEMBER					
			Net Loss KAF	Estimated Flow Reduction Due to Post-1947 Devel.			Station Unimpair KAF	Actual Flow KAF	Net Loss KAF	Estimated Flow Reduction Due to Post-1947 Devel.		
				KAF	% of Rim Station	% of Pre-1944				KAF	% of Rim Station	% of Pre-1944
Dry	2,827	957	1,870	410	14	34	1,960	196	1,764	320	16	75
Below Normal	4,141	1,534	2,607	1,220	29	33	3,179	699	2,480	1,060	33	52
Above Normal	6,377	3,012	3,364	1,560	24	31	3,941	1,173	2,768	1,580	40	52
Wet	9,626	6,489	3,137	1,890	20	21	6,716	3,743	2,973	1,370	20	25

UPPER SAN JOAQUIN RIVER BASIN
1948-1969

Year Type	San Joaquin @ Friant Unimpair KAF	Actual Flow KAF	ANNUAL				APRIL--SEPTEMBER					
			Net Loss KAF	Estimated Flow Reduction Due to Post-1947 Devel.			San Joaquin @ Friant Unimpair KAF	Actual Flow KAF	Net Loss KAF	Estimated Flow Reduction Due to Post-1947 Devel.		
				KAF	% of Friant	% of Pre-1944 @ Vern.				KAF	% of Friant	% of Pre-1944 @ Vern.
Dry	842	136	706	120	14	10	636	55	581	7	1.1	1.6
Below Normal	1,252	165	1,088	540	43	24	1,001	66	935	390	39	30
Above Normal	1,909	445	1,464	920	48	18	1,344	95	1,250	570	42	17
Wet	2,996	1,878	1,118	1,240	41	14	2,275	1,060	1,215	760	33	14

dry years at Vernalis an average annual flow reduction of 410,000 acre-feet* was determined from the average of 519,000 acre-feet estimated by the double mass balance method and 294,000 acre-feet estimated by adjustment of average basin losses to a common reference of unimpaired flow. (See table V-2.) Exceptions to this procedure are values given for below normal years which were taken as estimates computed by the double mass diagram method.

Additional information presented in Table V-18 is flow reduction expressed as percentage of the unimpaired rim station flow and the actual Vernalis flow, pre-1944.

SUMMARY

Reductions in runoff that have occurred in the San Joaquin River basin as a result of development subsequent to 1947 are summarized in Table V-21. Data presented in the table are derived from Table V-2 through V-17, which present estimates of water losses for each of the 4-year classifications computed for both the entire San Joaquin River basin and the upper San Joaquin River basin. Reductions in flow are determined as the difference in "losses" between the rim stations and Vernalis. Reductions attributable to the CVP are identified as equivalent to the difference in losses occurring in the upper San Joaquin River basin alone. For purposes of comparison, reductions are expressed both in terms of volume of runoff in the April-September and annual periods and as percentages of the flow that actually occurred at Vernalis.

The principal conclusions reached from the study of water quantity effects are as follows:

1. For the entire San Joaquin River basin, flows at Vernalis were reduced by post-1947 development,

* Rounded to nearest 10

- a. in dry years by amounts ranging from 300,000 to 500,000 acre-feet, about 75 percent of which reduction occurred in the April-September period,
 - b. in below normal years* by amounts exceeding 1,200,000 acre-feet, about 85 percent of which reduction occurred in the April-September period,
 - c. in above normal years by amounts exceeding 1,400,000 acre-feet, all of which occurred in the April-September period, and
 - d. in wet years by amounts ranging from 1,100,000 to 2,900,000 acre-feet, about 60-85 percent of which occurred in the April-September period.
2. For the upper San Joaquin River basin, where the impact is attributable to the CVP, flows at Vernalis were reduced by post-1947 development;
- a. in dry years by 90,000 to 130,000 acre-feet, a relatively small proportion of which (about 4 to 8 percent) occurred in the April-September period,
 - b. in below normal years* by more than 500,000 acre-feet, of which about three-quarters occurred during the April-September period,
 - c. in above normal years by 750,000 to 1 million acre-feet, about 60 percent of which occurred during the April-September period, and
 - d. in wet years by 750,000 to 2 million acre-feet, of which about half occurred during the April-September period.
3. The greatest impact of flow reductions at Vernalis occurred during the April-September period of below normal and above normal years when from 14-24

* Data are limited for these years. Refer to analysis below normal years on page V-18.

percent of the flow reduction at Vernalis (on a pre-1944 basis) was attributed to development by the CVP in the upper San Joaquin basin. The impact in dry years was small, less than 2 percent of the pre-1944 flow at Vernalis. In the April-September period of wet years, reductions were in the range of 10-18 percent of the pre-1944 flow at Vernalis.

Table V-21

SUMMARY OF REDUCTIONS IN RUNOFF OF SAN JOAQUIN RIVER AT VERNALIS FROM PRE-CVP TO POST-CVP

YEAR TYPE & PERIOD	EFFECT OF ALL POST-CVP UPSTREAM DEVELOPMENT ON RUNOFF AT VERNALIS		EFFECT OF CVP ON RUNOFF AT VERNALIS		
	Reduction in Runoff KAF ¹	Post 1947 Reduction as Percent of Pre-1944 Actual Runoff	Reduction in Runoff KAF ¹	Reduction at Vernalis as Percent of Pre-1944 Flow	Reduction at Vernalis as Percent of Post-1947 Flow
DRY					
April-Sept Full Year	206- 417 294- 519	49-67 ² 25-44	6- 7 93- 138	1.4- 1.6 8 - 12	3.0- 3.6 10 - 14
BELOW NORMAL					
April-Sept Full Year	1064-1177 1219	60-68 ² .44 ²	386- 428 543	22 - 24 ² - 20 ²	55 - 61 35
ABOVE NORMAL					
April-Sept Full Year	1406-1732 1400-1721	47-57 28-34	440- 704 768-1076	14 - 23 15 - 21	40 - 64 25 - 36
WET					
April-Sept Full Year	1002-1760 1168-2916	19-32 13-32	554- 965 771-2014	10 - 18 9 - 22	15 - 26 12 - 31
AVERAGE OF ALL YEARS ³					
April-Sept Full Year	920-1272 1020-1594	44-56 28-39	347- 526 544- 943	12 - 17 13 - 19	28 - 39 21 - 29

¹ Range of estimates by all methods of analysis. See Tables V-2 through V-17² Pre-CVP "actual" is assumed to be post-1947 actual plus pre-1944 to post-1947 loss³ Assumes that each year class occupies one-quarter of period

CHAPTER VI

WATER QUALITY EFFECTS OF UPSTREAM DEVELOPMENT

INTRODUCTION

There are several complications in analyzing the water quality changes due to upstream development. It is, therefore, necessary that the results of the analysis acknowledge a range of impacts on Southern Delta water quality. Part of the uncertainty in interpretation relates to insufficient and/or unreliable data, and part to differences in approach to the analysis. Each manner of investigation has an aspect of validity, but each must be weighed in light of its assumptions and available data.

Two factors affect water quality, flow and salt load. Chapter V has identified the changes in flow at Vernalis, and this chapter equates these changes in flow with an amount of degradation at Vernalis. This chapter also examines historic salt loads and concentrations at Vernalis to determine changes associated with development along the San Joaquin River and its tributaries. Sections A, B, C, and D of this chapter contain the development and results of several studies on different sets of data. Because of the length of the first four sections and the amount of material contained therein, Sections E and F consolidate the results and define the impacts of upstream development. A more detailed explanation of each section follows.

Section A of this chapter presents an analysis of the composition of the salts reaching Vernalis and relates this to composition of salts originating from identifiable sources, e.g., tributary streams, imported water and drainage returns from irrigated lands. These chemical analyses are then used as "finger-

prints" in an attempt to identify the principal sources and their relative contributions to the total salts reaching Vernalis. Also included in this section are the results of salt balance computations using this data for a single dry year, 1961.

Section B of this chapter addresses three questions pertaining to water quality at Vernalis. First, has there been a change in salt load at Vernalis? By comparing the TDS salt loads at Vernalis over the period of record, increasing or decreasing trends in loading can be identified. Second, regardless of any change in loading, has a change in TDS concentration occurred? A comparison of the TDS concentrations is used to determine if any degradation has taken place through the period of record. Third, has the source of salt changed? Salt balance computations, utilizing data from identified sources, are employed to judge whether in the years after 1950, the percent of Vernalis salt load contributed by these sources has changed. Section B deals with trends in the data in a qualitative rather than quantitative manner.

Section C of this chapter presents the record of quality degradation in the San Joaquin River as it enters the Delta near Vernalis. Due to limitations of the Vernalis data, two methods of estimating Vernalis quality are developed and used to synthesize an artificial record for periods when none exists. By constructing the complete set of TDS concentrations, similar hydrologic years before and after upstream development can be compared to estimate water quality degradation.

Section D of this chapter is a discussion of the Tuolumne River gas wells and their contribution to the quality problem. Because the Tuolumne River contributes a significant amount of the salt load at Vernalis, and the gas

wells are the source of much of the Tuolumne load, Section D deals with the water quality of discharges from these wells.

Section E of this chapter allows the reader who may not be interested in the development of the individual studies, to forego reading Sections A, B, C, and D. Section E summarizes the results of the four preceding sections and analyzes the impact of upstream development on quality degradation at Vernalis.

Section F of this chapter is a summary of quality impacts at Vernalis resulting from CVP development.

Various methods of analysis utilizing different data sets are presented in this chapter. Due to the type and availability of data, one method of analysis may not use the same chronological division of data as used by another method. For purposes of water quality, generally the period prior to 1950 is considered indicative of conditions in the lower San Joaquin River before CVP development. Each analysis refers to a period preceding a specific year or succeeding a specific year. Although the specific year may vary from analysis to analysis, the implication is that prevalues refer to that period used as a base condition and postvalues refer to that period in which some change has occurred to the lower San Joaquin River basin. Using this assumption, pre- and postvalues calculated by one method can be compared to pre- and postvalues computed by another method, regardless of actual period of record.

SECTION A. IDENTIFICATION OF SOURCES OF SALT BURDEN--CHEMICAL CHARACTERISTICS

Figure VI-1 is a schematic representation of the San Joaquin Valley System showing the location of stream gaging, water quality sampling stations and principal drainage accretions.

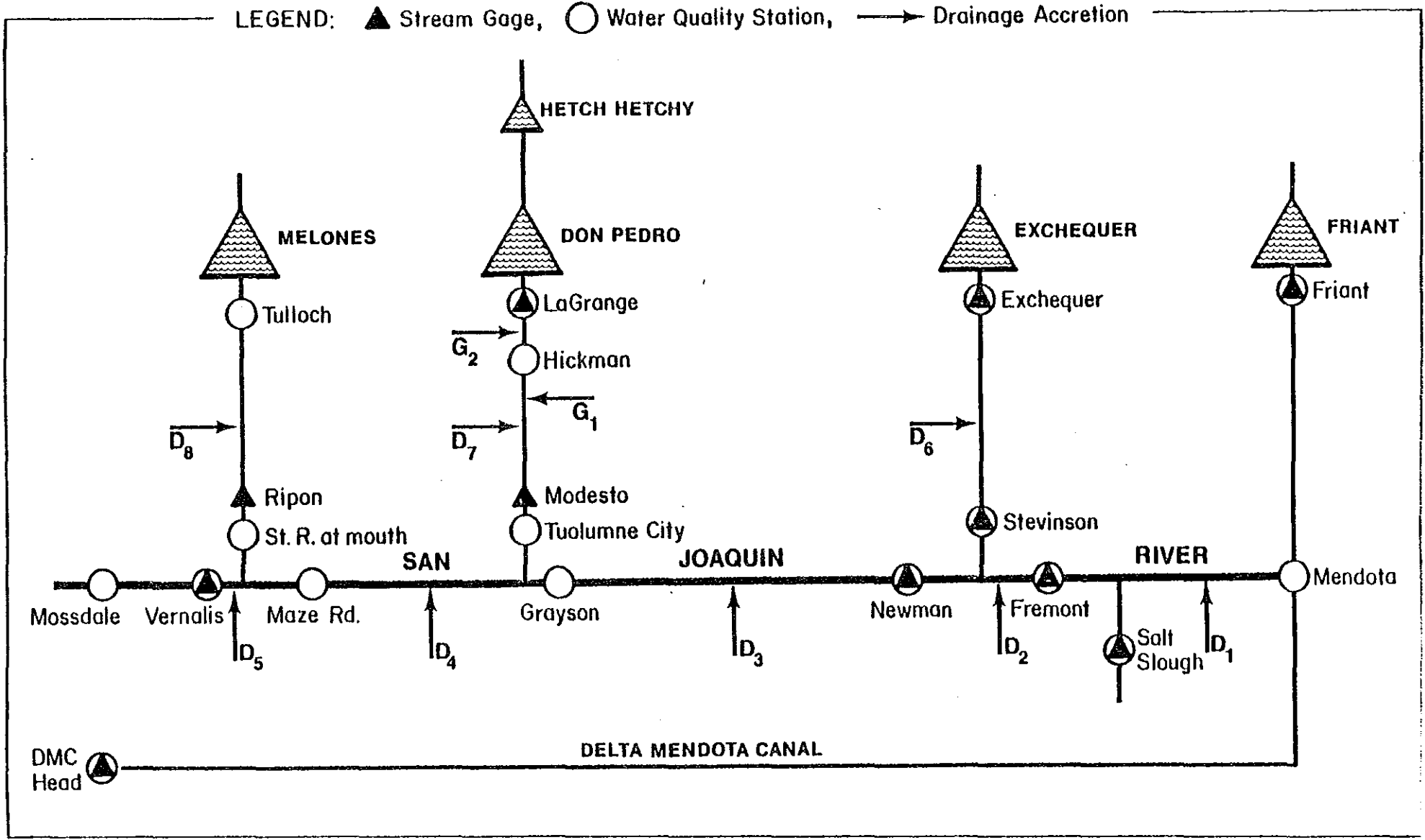

Figure VI-1 SAN JOAQUIN VALLEY SYSTEM

Stream gaging, water quality sampling stations and principal drainage accretions

Characteristics of High Sierra Streams

In order to provide a perspective of quality characteristics of San Joaquin flows, it is necessary to identify the distinguishing chemical properties of the principal sources of runoff. Table VI-1 gives a representative analysis of the four major tributaries at locations corresponding approximately to the location of rim flow gaging stations.

The quality of these high Sierra streams is generally characterized by low levels of total dissolved solids and of each of the principal mineral constituents, low electrical conductivity and a slightly alkaline pH. These waters are very soft, bicarbonate concentrations are relatively high compared to other constituents and sulfates are virtually nil. Carbonate does not occur at the pH of these waters. Chlorides are very low. Traces of iron and fluoride are occasionally noted. Boron is found in measurable concentrations (> 0.1 mg/L) in only a few samples. Iron is virtually absent. Distinguishing properties of high Sierra waters are the almost total lack of sulfates and noncarbonate hardness and extremely low boron concentrations.

Characteristics of Sierra Streams at Confluence with San Joaquin Main Stem

Table VI-2 illustrates the quality of the east side tributaries, together with the main stem of the San Joaquin near Mendota during the month of May 1961. Lower in the drainage system the Sierra streams show increased concentrations of most constituents, with relatively larger increases in Na^+ , K^+ , Cl^- and SO_4^- than of Ca^{++} , Mg^{++} and HCO_3^- . An exception is the Tuolumne River which has picked up an unusually large accretion of saline water from gas wells between Hickman and Modesto. In this case, large increases in Na^+ , K^+ and Cl^- are noted, with corresponding changes in TDS, hardness, SAR

Table VI-1. REPRESENTATIVE WATER QUALITY OF HIGH SIERRA STREAMS*

	San Joaquin at Friant	Merced @ Exchequer	Tuolumne @ La Grange	Stanislaus @ Tulloch
1. Date	6 Sep 61	6 Sep 61	12 Sep 61	8 Sep 61
2. Mean discharge (cfs)	146	143	2120	
3. Silica	10	9.3	4.8	8.9
4. Iron	0.0			
5. Calcium	3.6	12	2.5	5.6
6. Magnesium	1.6	2.4	0.5	2.8
7. Sodium	5.4	3.2	1.2	2.6
8. Potassium	0.7	0.7	0.4	0.3
9. Bicarbonate	24	48	12	35
10. Carbonate				
11. Sulfate	0.0	3.0	0.2	0.0
12. Chloride	6.0	3.2	-	1.2
13. Fluoride	0.1	0.1	0.1	0.1
14. Nitrate	0.4	0.8	0.4	0.3
15. Boron	0.1	0.0	0.0	0.0
16. TDS	40	59	16	39
17. Ca + Mg hardness	16	40	8	26
18. Non-carb. "	0	1	0	0
19. SAR	0.6	0.2	0.2	0.2
20. EC, umhos/cm	59	95	22	63
21. pH	7.3	7.6	6.7	7.3

* mg/L except as noted

Table VI-2. REPRESENTATIVE WATER QUALITY OF TRIBUTARIES
AT CONFLUENCE WITH SAN JOAQUIN *

	San Joaquin nr. Mendota	Merced nr. Stevinson	Tuolumne nr. Tuol.City	Stanislaus nr. mouth
1. Date	4 May 61	4 May 61	9 May 61	4 May 61
2. Mean discharge (cfs)		71	235	12
3. Silica	17	26	41	34
4. Iron	0.1	0.02	0.04	0.01
5. Calcium	17	22	53	30
6. Magnesium	9.0	7.1	16	12
7. Sodium	23	30	102	19
8. Potassium	0.9	2.0	8.0	2.1
9. Bicarbonate	84	132	147	182
10. Carbonate		0	0	
11. Sulfate	27	15	10	10
12. Chloride	26	20	207	9.0
13. Fluoride	0.2	0.1	0.0	0.1
14. Nitrate	0.9	3.4	3.1	0.6
15. Boron	0.2	0.1	0.0	0.1
16. TDS	162	191	512	207
17. Ca + Mg hardness	80	84	198	126
18. Non-carb. "	11	0	77	0
19. SAR	1.1	1.4	3.2	0.7
20. EC, μ mhos/cm	260	294	911	315
21. pH	7.5	7.8	7.8	7.7

* mg/L except as noted

and EC. However, if these concentrated sources of salinity are eliminated then the quality of the Tuolumne inflow would probably be little different from those of the other major tributaries. Note, for example, that the concentration of sulfate is virtually the same as for the Stanislaus and less than for either the Merced or the San Joaquin at Mendota.

Westside Drainage Water Quality

Drainage waters from the west side of the San Joaquin Valley are characterized by generally high concentrations of total dissolved solids, dominated by Na^+ , Cl^- and $\text{SO}_4^{=}$. TDS levels commonly range from 800 to over 1,200 mg/L and EC's may exceed 2,000 umhos/cm in some waters. Some surface drainage is of a quality similar to ground waters that have been used historically as principal sources for irrigation. Surface streams are ephemeral, with few exceptions, so there is a paucity of data on surface accretions from the west side of the valley. However, a fair indication of west side water quality is seen in observations of Salt Slough near Los Banos, some examples of which are described in table VI-3. It is noted that these waters are high in boron and sulfates; noncarbonate hardness is more than 40 percent of total hardness.

Quality Variations Along the Main Stem

A general picture of the pattern of quality along the main stem of the San Joaquin, in relation to the quality of its principal tributaries, is presented in figures VI-2 through VI-6.

Cation-Anion balance. Figure VI-2 shows the cation composition of the river and tributaries during the period May 3-9, 1966, and figure VI-3 shows the corresponding distribution of the principal anions.

Table VI-3. WATER QUALITY OF SALT SLOUGH*

1. Date	4 May 61	7 Sep 61	4 May 66
2. Mean discharge (cfs)	65	73	98
3. Silica	25	25	17
4. Iron	0.0		
5. Calcium	56	52	54
6. Magnesium	29	32	25
7. Sodium	146	157	123
8. Potassium	4.8	5.0	4.6
9. Bicarbonate	160	174	152
10. Carbonate	0	0	0
11. Sulfate	135	129	123
12. Chloride	220	232	172
13. Fluoride	0.5	0.3	
14. Nitrate	2.8	2.4	3.4
15. Boron	0.4	0.7	0.6
16. TDS	698	721	628
17. Ca + Mg hardness	260	260	236
18. Non-carb. "	129	117	111
19. SAR	3.9	4.2	3.5
20. EC, $\mu\text{mhos/cm}$	1210	1300	1060
21. pH	7.8	7.4	7.6

* mg/L except as noted

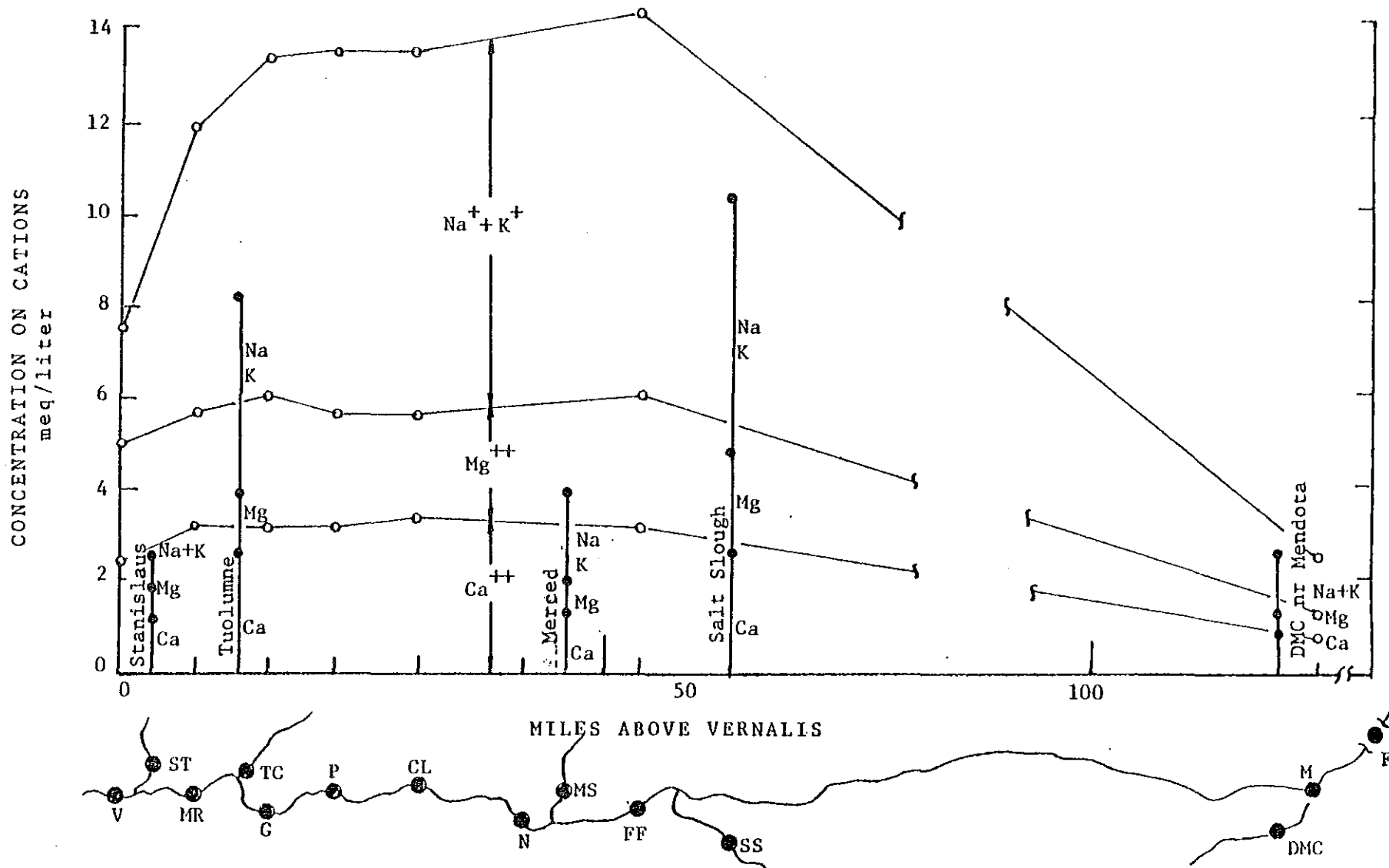

Figure VI-2 CONCENTRATIONS OF PRINCIPAL CATIONS IN THE SAN JOAQUIN RIVER AND ITS MAJOR TRIBUTARIES. PERIOD: 3-9 MAY 1966

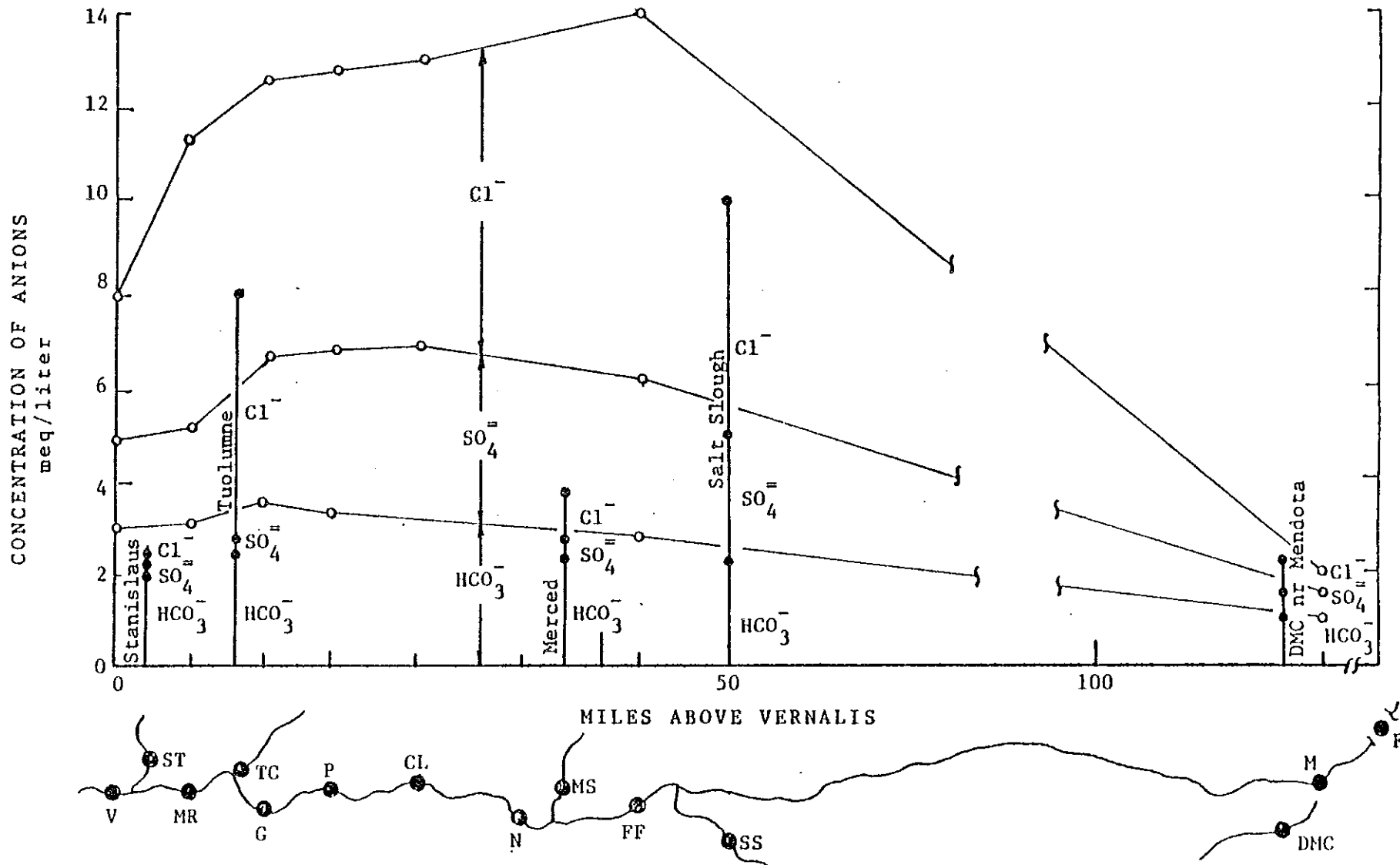

Figure VI-3 CONCENTRATIONS OF PRINCIPAL ANIONS IN THE SAN JOAQUIN RIVER AND ITS MAJOR TRIBUTARIES. PERIOD: 3-9 MAY 1966

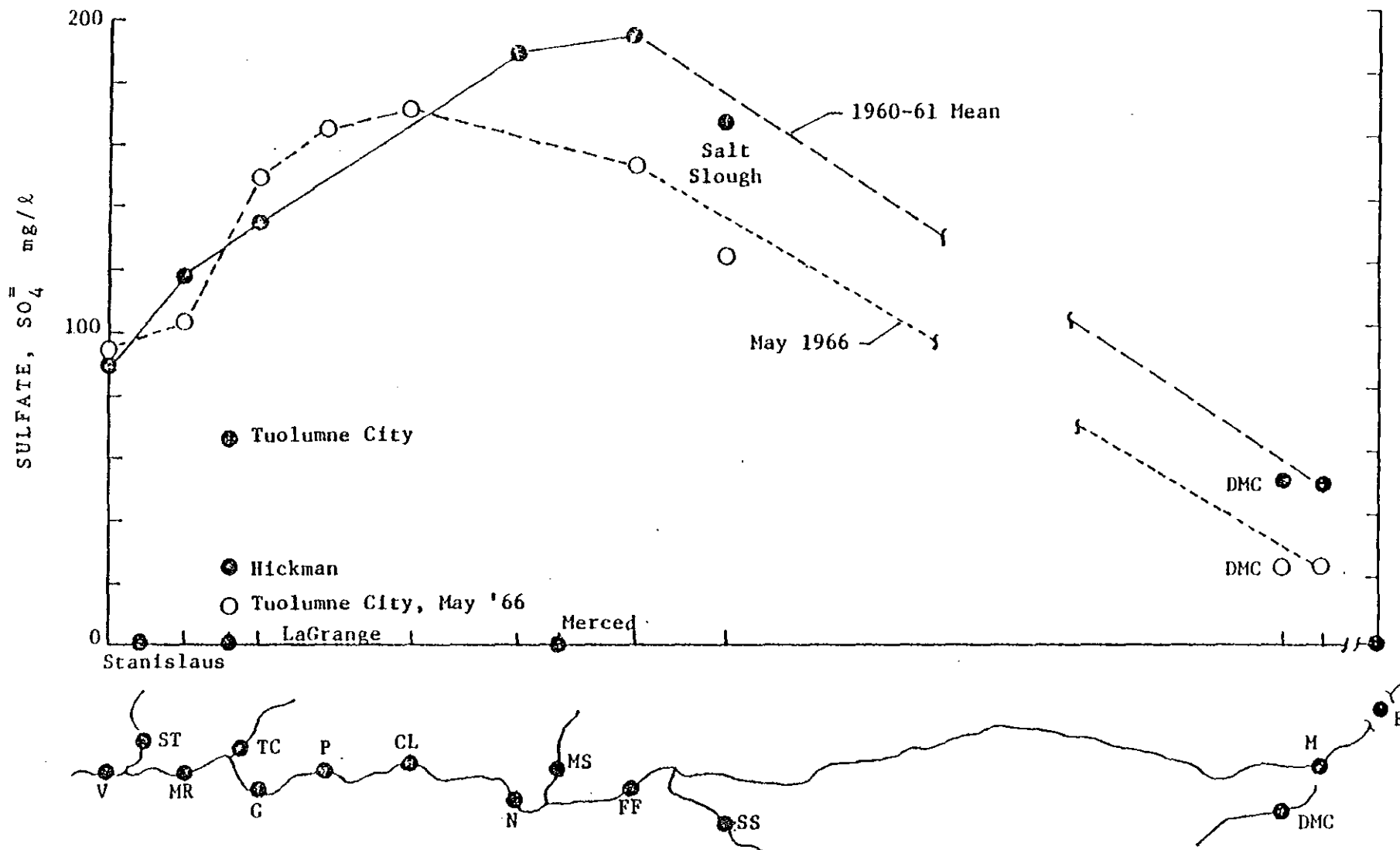

Figure VI- 4 SULFATE CONCENTRATION IN SAN JOAQUIN RIVER SYSTEM
1960-61 AND MAY 1966

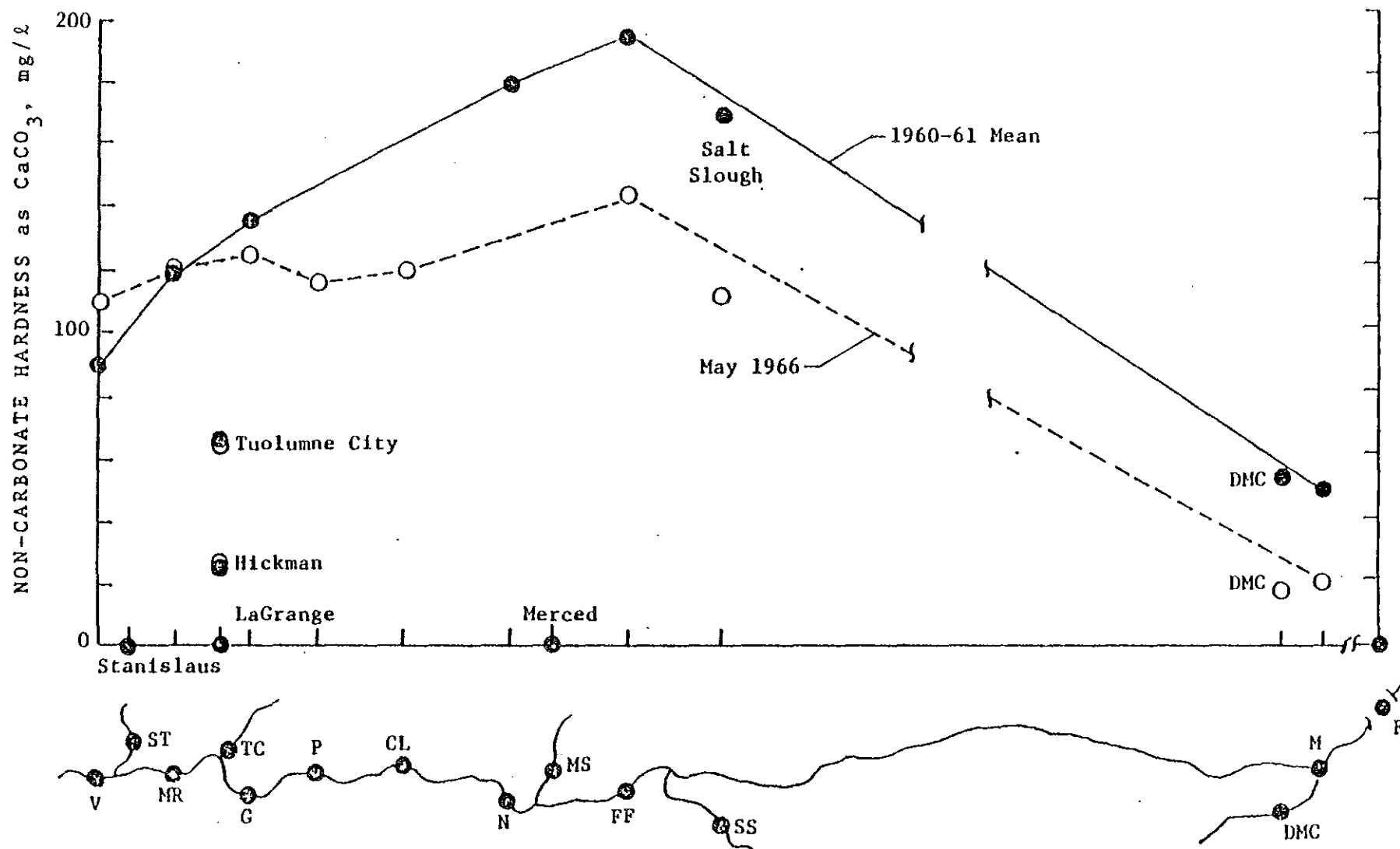

Figure VI- 5. NONCARBONATE HARDNESS IN SAN JOAQUIN RIVER SYSTEM
1960-61 AND MAY 1966

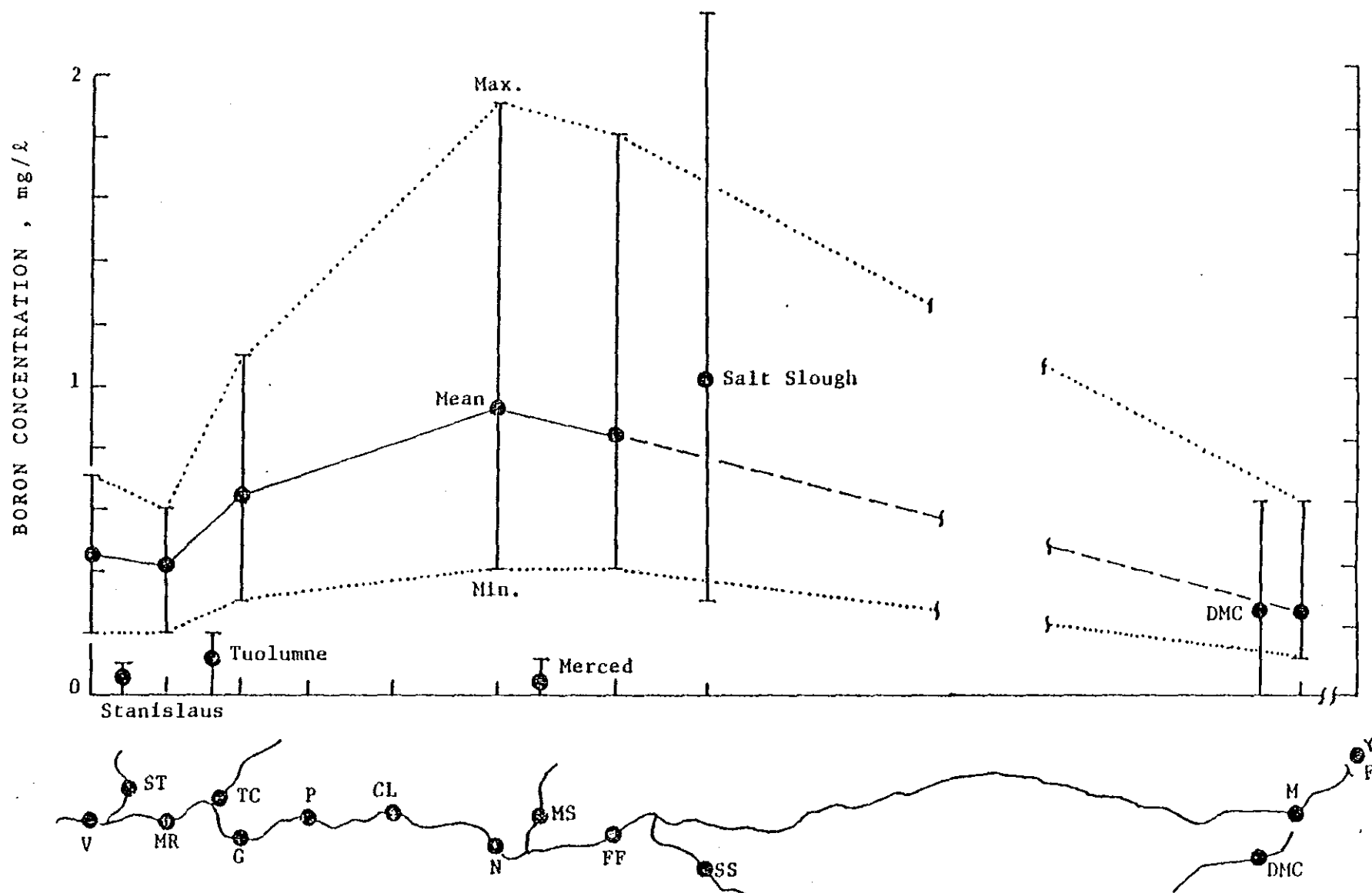

Figure VI-6 BORON CONCENTRATION IN SAN JOAQUIN RIVER SYSTEM
1960-61

Due to the lack of data in the reach between Mendota (Mile 129 above Vernalis) and Fremont Ford Bridge just downstream from the mouth of Salt Slough, it is not clear how the pattern develops over the upper 70 miles or so. Nevertheless, it is clear that the composition of San Joaquin River water at Fremont Ford Bridge (FF) corresponds closely to that of Salt Slough. If principal cations and anions are expressed as percentages of the sum of milliequivalents per liter, then the similarity of these waters becomes even more evident, as can be seen in the following example:

	San Joaquin River @ Fremont Ford 5-5-66 <u>Q = 175 ft³/s</u>	Salt Slough 5-4-66 <u>Q = 98 ft³/s</u>
Cations		
(percent of total)		
Ca ⁺⁺	22.5	26.4
Mg ⁺⁺	19.7	20.2
Na ⁺	56.7	52.2
K ⁺	1.1	1.2
	100.0	100.0
Anions		
(percent of total)		
HCO ₃ ⁻	22.2	25.2
CO ₃ ⁻	0	0
SO ₄ ⁻	22.9	25.8
Cl ⁻	54.9	49.0
	100.0	100.0

It should be noted that the additional drainage accretion to Fremont Ford is about 77 ft³/s (175 minus 98). The chemical composition of salts in this water must be very similar to that of Salt Slough since the chemical composition of the salts in the blended flows is so little different from that measured in the slough.

Referring once again to figures VI-2 and VI-3, it is noted that downstream of Fremont Ford the pattern remains more or less steady until the flow reaches the vicinity of the mouth of the Tuolumne. At this point an influx of water of superior overall quality, although high in Na^+ , K^+ and Cl^- , accelerates a general decline in salt concentration. The proportion of Cl^- to total anions increases notably while the proportion of $\text{SO}_4^{=}$ in the San Joaquin (more or less constant in the Tuolumne) decreases. A further striking improvement in San Joaquin quality is noted between Maze Road and Vernalis with the addition of flow (157 ft^3/s at Ripon) of very high quality.

Sulfates. Table VI-4 summarizes the principal anion composition of the San Joaquin System for the dry year 1960-61. Data shown represent averages of all observations over the year for all USGS stations at which samples were collected.

As noted previously, a distinctive difference in the quality of east side streams and the quality of the main stem below Mendota is the concentration of sulfate ion, $\text{SO}_4^{=}$. East side streams, with the exception of the Tuolumne below the gas wells, contain very little sulfate while the main stem and the principal west side tributary, Salt Slough, are very rich in this anion. The pattern along the river, shown in figure VI-4, highlights these differences, showing clearly that for this period, at least (when flows were generally very low) the river water quality, in terms of chemical composition of salts, was similar to drainage from the west side. Some lowering of $\text{SO}_4^{=}$ concentrations appears to occur below Newman, possibly due to return flows from the irrigated areas on the eastern side of the valley. However, sulfates are sustained at high levels along most of the river from Fremont Ford to Vernalis.

Table VI- 4. CONCENTRATIONS OF PRINCIPAL ANIONS,
SAN JOAQUIN RIVER SYSTEM, 1960-61

USGS No.	Station Location	No. of Obs. ¹	Principal Anions, mg/L			
			HCO ₃ ⁻	SO ₄ ⁼	Cl ⁻	% SO ₄ ²
2510	SJR below Friant	12	22.3	0.5	5.1	1.8
2540	SJR nr Mendota	13	97.7	36.3	98.0	15.7
2580	Fresno R.	8	51.5	0.0	28.4	0.0
2590	Chowchilla R.	7	102.0	3.0	64.4	2.0
2603	Bear Cr.	11	139.4	6.0	5.7	6.9
2610	Salt Slough	12	201.3	242.3	280.5	33.1
2615	SJR, Fremont Fd.	15	208.9	233.8	345.3	31.4
2700	Merced @ Exch.	12	50.1	2.5	4.2	6.7
2725	Merced @ Stev.	11	145.5	13.5	22.1	7.7
2740	SJR nr Newman	13	221.6	252.0	318.4	32.0
2747	SJR nr Grayson	12	229.2	159.3	244.7	26.4
2880	Tuol @ LaGrange	11	14.1	0.6	1.1	4.5
2898	Tuol nr Hickman	11	83.9	2.8	81.1	1.2
2902	Tuol nr Tuol City	11	130.4	9.4	204.0	2.4
2905	SJR @ Maze Rd	12	178.7	87.7	241.6	16.3
2999.98	Stan @ Tulloch	12	35.0	1.0	1.0	1.4
3034	Stan nr mouth	10	151.5	10.0	9.1	5.0
3035	SJR nr Vernalis	39	151.0	81.0	176.0	19.9
3042	SJR nr Mossdale	13	163.2	65.3	192.3	14.0
3048	SJR, Garwood Br.	12	144.6	45.0	145.6	13.1
3127	Old R. nr Tracy	12	167.4	86.5	198.6	17.9
3129.9	DMC above PP	10	101.6	23.5	100.6	12.8
3130.1	DMC below PP	28	94.0	39.0	89.0	17.6
3130.5	DMC nr Mendota	13	110.5	36.0	110.6	15.6
3132	Grantline Canal	12	149.1	65.5	182.2	15.0
3132.5	Old R. @ Cl.Ct.	12	103.5	21.0	103.9	12.3

¹ Corresponds to maximum, usually for HCO₃⁻ and Cl⁻; SO₄⁼ analyses were made less frequently

² Percentage based only on samples analyzed for all three anions, since SO₄⁼ analyses were made less frequently

A similar pattern is seen for a set of data taken during the period May 3-9, 1966, although in this case the sulfate concentration of the Tuolumne River at Tuolumne City was very much lower than for 1960-61, a fact that probably accounts for the sharp drop in $\text{SO}_4^{=}$ between Grayson and Maze Roads.

Noncarbonate hardness. Noncarbonate hardness, a measure of hardness attributed to the chloride and sulfate compounds with calcium and magnesium, also reveals a distinctive difference between east side streams and the main stem plus Salt Slough. This is illustrated in the data of table VI-5 and figure VI-5. Once again the main stem quality, in terms of chemical composition of salts, is closely identified with drainage returns from the west side, i.e., Salt Slough, while the east side streams are virtually devoid of NCH (the exception being the lower reach of the Tuolumne where the gas wells add calcium and magnesium sulfate). Even the DMC carries a relatively high NCH, a condition that is also reflected in the quality of water in the San Joaquin River near Mendota since the DMC is the principal source of water in the main stem at this location.

Boron. Boron concentrations in east side streams are generally very low, while this is a common constituent of west side waters and also of the main stem during periods of low runoff. Data on boron concentrations for 1960-61 are summarized in table VI-6 and figure VI-6.

In these examples, boron concentrations are noted to vary widely with location along the main stem, but at all locations the concentrations are substantially greater than for any of the east side streams. Even the DMC delivers water with more than double the boron concentrations of the highest east side source (Tuolumne River). Maximum boron concentrations in the east side streams are no greater than the least values recorded for the main stem from Fremont Ford to Vernalis.

Table VI-5. TOTAL AND NONCARBONATE HARDNESS
SAN JOAQUIN RIVER SYSTEM, 1960-61

USGS No.	Station Location	No. of Obs.	Hardness as CaCO ₃ , mg/L		
			Ca + Mg	NHC	% @ NHC
2510	SJR below Friant	12	17.0	0.5	2.9
2540	SJR nr Mendota	13	128.1	47.9	37.4
2580	Fresno R.	8	43.8	4.3	9.8
2590	Chowchilla R.	7	101.8	18.3	18.0
2603	Bear Cr.	11	112.2	1.6	1.4
2610	Salt Slough	12	332.9	167.8	50.4
2615	SJR, Fremont Fd.	15	366.3	194.3	53.0
2700	Merced @ Exch.	12	44.4	3.8	8.5
2725	Merced @ Stev.	11	93.6	0.0	0.0
2740	SJR nr Newman	13	370.8	188.6	50.9
2747	SJR nr Grayson	12	327.2	135.5	41.4
2880	Tuol @ LaGrange	11	10.9	0.5	4.8
2898	Tuol nr Hickman	11	94.2	25.5	27.1
2902	Tuol nr Tuol City	11	173.9	66.5	38.2
2905	SJR @ Maze Rd	12	265.9	118.2	44.5
2999.98	Stan @ Tulloch	12	28.2	0.9	3.2
3034	Stan nr mouth	10	110.9	0.0	0.0
3035	SJR nr Vernalis	39	210.0	88.0	41.9
3042	SJR nr Mossdale	13	229.4	95.1	41.5
3048	SJR, Garwood Br.	12	178.1	60.2	33.8
3127	Old R. nr Tracy	12	247.5	110.3	44.6
3129.9	DMC above PP	10	131.8	48.3	36.6
3130.1	DMC below PP	28	115.0	38.0	33.0
3130.5	DMC nr Mendota	13	143.8	52.7	36.6
3132	Grantline Canal	12	206.8	84.3	40.8
3132.5	Old R. @ Cl.Ct.	12	132.2	55.8	42.2

Table VI-6. BORON CONCENTRATION, SAN JOAQUIN RIVER SYSTEM

USGS No.	Station Location	No. of Obs.	Boron Concentration, $\mu\text{g/L}$			
			Min.	Max.	Mean	Median
2510	SJR below Friant	12	0.0	0.1	0.03	0.0
2540	SJR nr Mendota	13	0.0	0.6	0.23	0.2
2580	Fresno R.	8	0.0	0.2	0.05	0.0
2590	Chowchilla R.	7	0.0	0.1	0.04	0.0
2603	Bear Cr.	11	0.0	0.1	0.02	0.0
2610	Salt Slough	12	0.3	2.2	1.00	0.75
2615	SJR, Fremont Fd.	15	0.4	1.8	0.83	0.70
2700	Merced @ Exch.	12	0.0	0.1	0.03	0.0
2725	Merced @ Stev.	11	0.0	0.1	0.03	0.0
2740	SJR nr Newman	13	0.4	1.9	0.92	0.8
2747	SJR nr Grayson	12	0.3	1.1	0.63	0.6
2880	Tuol @ LaGrange	11	0.0	0.1	0.04	0.0
2898	Tuol nr Hickman	11	0.0	0.1	0.05	0.0
2902	Tuol nr Tuol City	11	0.0	0.2	0.11	0.1
2905	SJR @ Maze Rd	12	0.2	0.6	0.42	0.4
2999.98	Stam @ Tulloch	12	0.0	0.1	0.02	0.0
3034	Stam nr mouth	10	0.0	0.1	0.04	0.0
3035	SJR nr Vernalis	39	0.2	0.7	0.44	0.4
3042	SJR nr Mossdale	13	0.0	0.5	0.28	0.3
3048	SJR, Garwood Br.	12	0.0	0.5	0.26	0.3
3127	Old R. nr Tracy	12	0.0	0.7	0.39	0.4
3129.9	DMC above PP	10	0.1	0.6	0.21	0.1
3130.1	DMC below PP	28	0.1	0.8	0.22	0.1
3130.5	DMC nr Mendota	13	0.1	0.6	0.22	0.1
3132	Gran-line Canal	12	0.0	0.5	0.27	0.4
3132.5	Old E. @ Cl.Ct.	12	0.0	0.5	0.14	0.1

Summary. These data were developed to facilitate identification of the locations and relative strengths of the major contributions to the salt burden carried by the San Joaquin River from the vicinity of the Mendota Pool to Vernalis.

In general, the data on quality constituents show the following:

1. There are distinctive differences between the qualities of east side streams and the quality of water carried by the San Joaquin River along its main stem. East side streams are generally of high quality from source to mouth (an exception being the lower reaches of the Tuolumne River). They are lower in TDS, lower in boron and uniquely deficient in sulfate and noncarbonate hardness compared to the San Joaquin River into which they discharge.
2. In the 1960's there is comparatively little difference between the quality and chemical composition of salts in drainage returns from the west side of the valley and the quality of water carried in the San Joaquin River from Mendota to Vernalis. West side drainage is high in TDS, chlorides, sodium, sulfate, noncarbonate hardness and boron, all of these properties being identified with soils of the area.
3. The quality of water and chemical composition of salts in the San Joaquin from Mendota to Vernalis is similar to the quality of west side accretions to the river. The effect of the flow from east side tributaries has been largely one of dilution of increased salt loads carried by the river.
4. The lower Tuolumne River received substantial accretions of salt (primarily in the form of sodium chloride) during the period studied as a result of drainage from abandoned gas wells. However,

even in 1961, the average annual quality of the Tuolumne at its mouth near Tuolumne City was superior to that in the main stem of the San Joaquin above the confluence of the two rivers (Note: Recently, an attempt to reduce the salt load of the Tuolumne River was initiated by sealing of the wells, although the effectiveness of this control measure has not yet been assessed quantitatively.)

While the properties of the salts carried by the San Joaquin River during periods of low flow appear to be dominated by west side accretions, to a degree that they are hardly indistinguishable, it is not possible on the basis of quality alone to determine the relative contribution of the several sources without considering the flow itself. This leads to the second phase of the quality problem--salt load--the product of flow times concentration.

SECTION B. SALT BALANCE OBSERVATIONS AT VERNALIS

The water quality at Vernalis may be affected by a change in salt load. Generally, an increase in load can be expected to cause quality degradation. (The exception would be an increase in load accompanied by an increase in flow.) An increase in load can be the result of importation of salts, either applied to the soil in the form of fertilizers, soil conditioners, etc., or as in the case of the DMC, with water diverted from the Delta. These salts along with those occurring naturally in the soil are carried in return flows to the San Joaquin River and may increase the total yearly salt load at Vernalis.

A second means of changing the salt load is through a shift of load with time. In such a case, the salt burden may be temporarily detained in the basin during one period but released subsequently with return flow. This mechanism

may not change the total annual salt load, merely redistribute it with respect to time, or delay its occurrence at the lower limit of the basin.

This section attempts to determine if additional salts have been introduced into the system, if a change in salt load pattern has occurred, or both.

Historical Trends of Salt Load at Vernalis

In figures VI-7 through VI-10 are presented the monthly average salt loads (tons per month) actually occurring at Vernalis during several decades since the 1940's* plotted as functions of the unimpaired ("rimflow") runoff at Vernalis (1,000's acre-feet) for each of four different months--October, January, April and July. Regression lines of a power function form

$$\text{TDS} = \text{Constant (KAF)}^n$$

where

TDS = tons per month

KAF = unimpaired Vernalis runoff, 1,000 acre-feet

n = exponent

that best fit the data are also shown.

In general, the data tend to indicate that the salt load has increased through the decades. It is noted that the lines represent "best fits" for a decade of data (up to 10 data points) and, hence, in some cases the correlations are not very strong, 0.5 or less. The curves do not necessarily describe the cause-effect relationship between salt load at Vernalis and the unimpaired runoff. Apparently, in those cases where correlations are poor

* Data were not considered sufficient to permit computation of monthly averages for the 1930's.

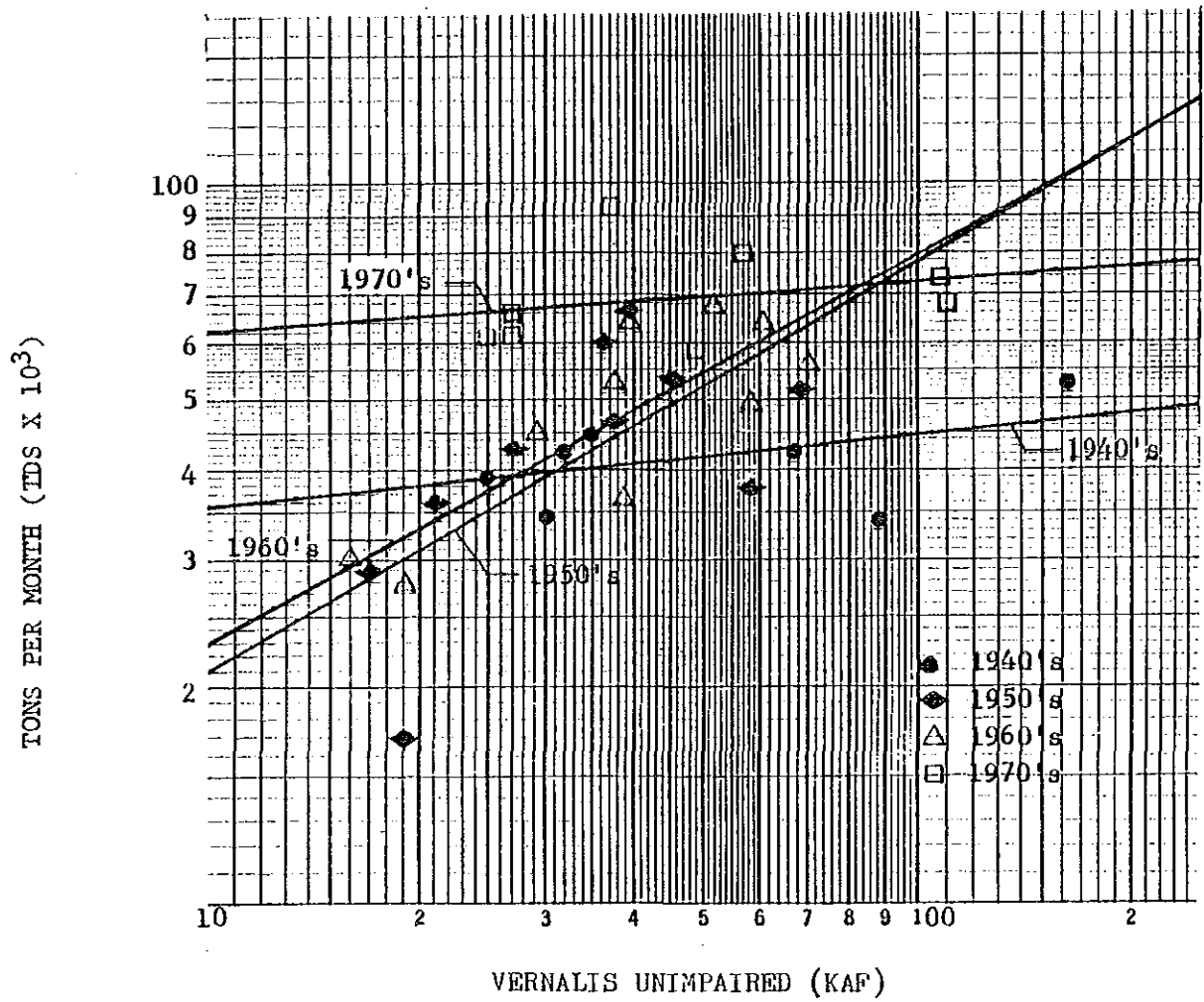

Figure VI-7 AVERAGE MONTHLY SALT LOAD (TDS) AS A FUNCTION OF UNIMPAIRED RUNOFF AT VERNALIS - OCTOBER

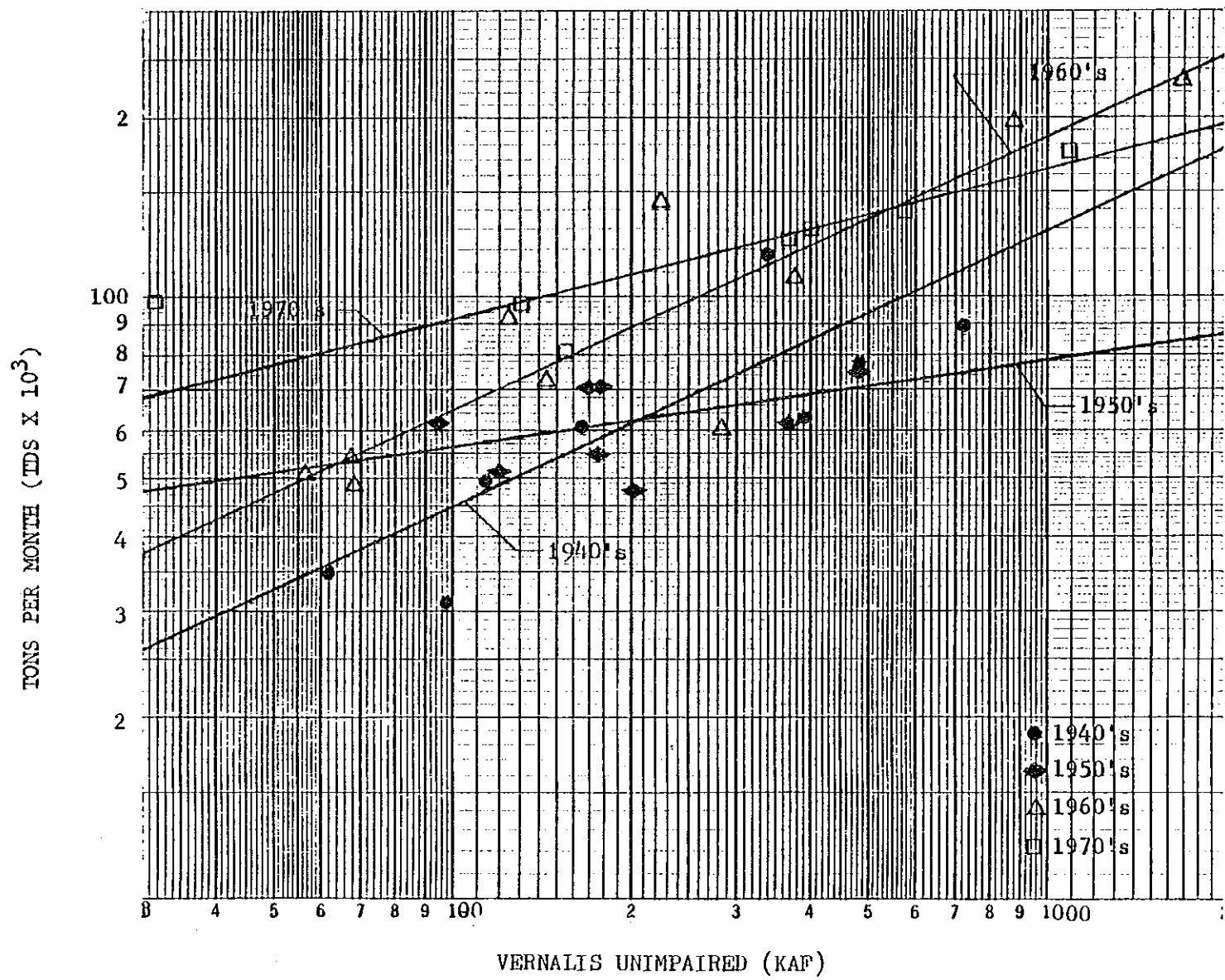

Figure VI-2

AVERAGE MONTHLY SALT LOAD (TDS) AS A FUNCTION OF UNIMPAIRED RUNOFF AT VERNALIS - JANUARY

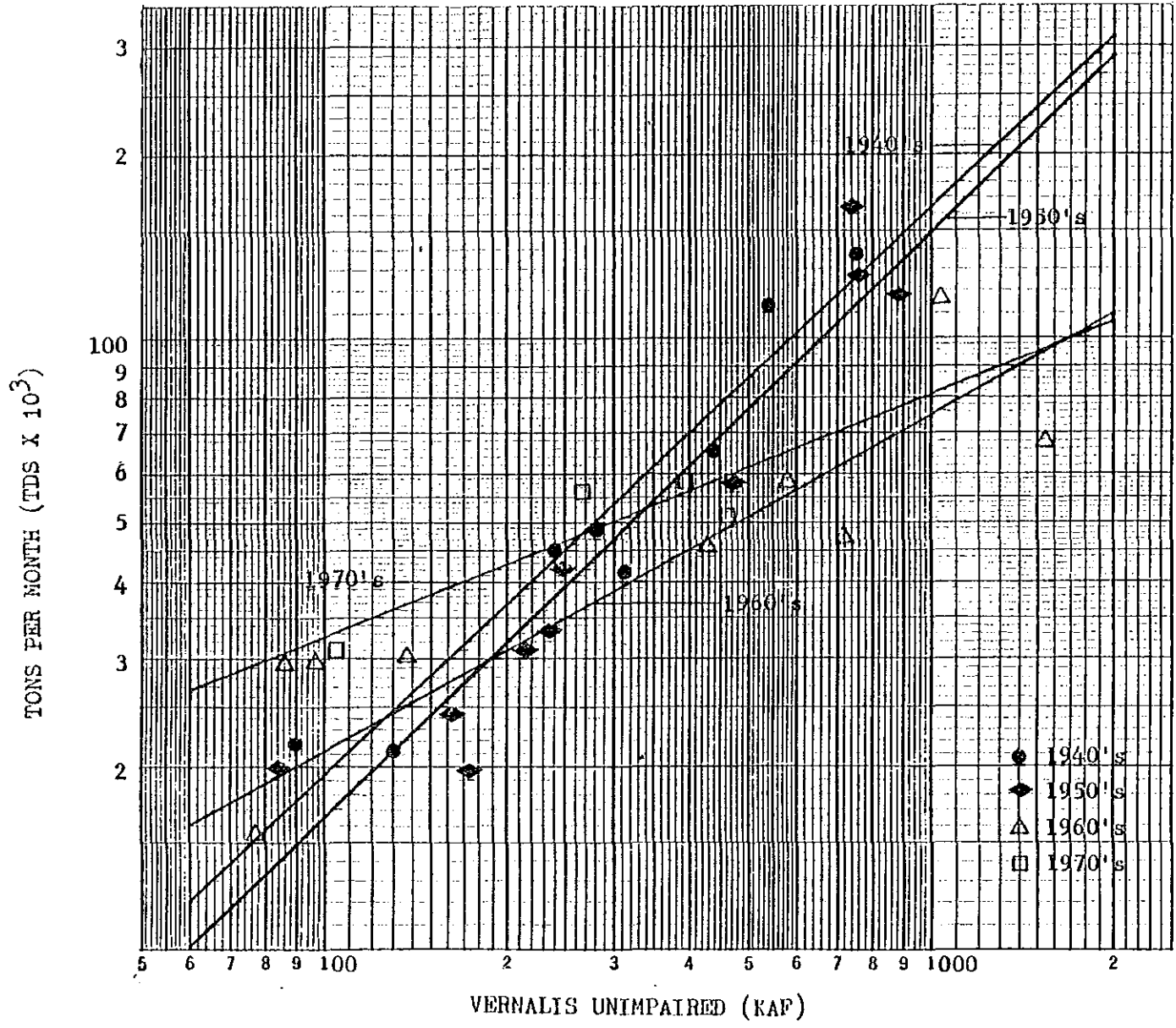

Figure VI-10 AVERAGE MONTHLY SALT LOAD (TDS) AS A FUNCTION OF UNIMPAIRED RUNOFF AT VERNALIS - JULY

other mechanisms than those assumed are needed to explain the observed increases in salt load that have occurred at Vernalis over the period since the 1940's.

Historical Trends in Salt Concentration at Vernalis

The Water and Power Resources Service has established a continuous EC recorder at the Vernalis stream gage and records are available, with some minor gaps, almost continuously for the period since September 1952. These are generally in the form of EC measurements from recorders, averaged over the daily cycle and converted to TDS and chlorides by conversion equations periodically updated by comparison of EC measurements with laboratory determinations of TDS and Cl^- . The most recent equations employed by the Water and Power Resources Service for Vernalis are:

$$\begin{aligned} \text{TDS} &= 0.62 \text{ EC} + 18.0 & (1) \\ 0 &< \text{EC} < 2000 \end{aligned}$$

$$\begin{aligned} \text{Cl}^- &= 0.15 \text{ EC} - 5.0 & (2a) \\ 0 &< \text{EC} < 500 \end{aligned}$$

$$\begin{aligned} \text{Cl}^- &= 0.202 \text{ EC} - 31.0 & (2b) \\ 500 &< \text{EC} < 2000 \end{aligned}$$

By relating TDS to Cl^- for constant EC, there result the following relationships between these two quality constituents:

$$\begin{aligned} \text{TDS} &= 3.07 (\text{Cl}^-) + 113 & (3) \\ 70 &< \text{Cl}^- \end{aligned}$$

$$\begin{aligned} \text{TDS} &= 4.13 (\text{Cl}^-) + 38.7 & (4) \\ 0 &< \text{Cl}^- < 70 \end{aligned}$$

Using the above equations, and what chloride data are available for the 1930's and 1940's, figures VI-11, VI-12, VI-13, and VI-14 were developed. Also shown in these figures are the actual TDS data for the 1950's and 1960's.

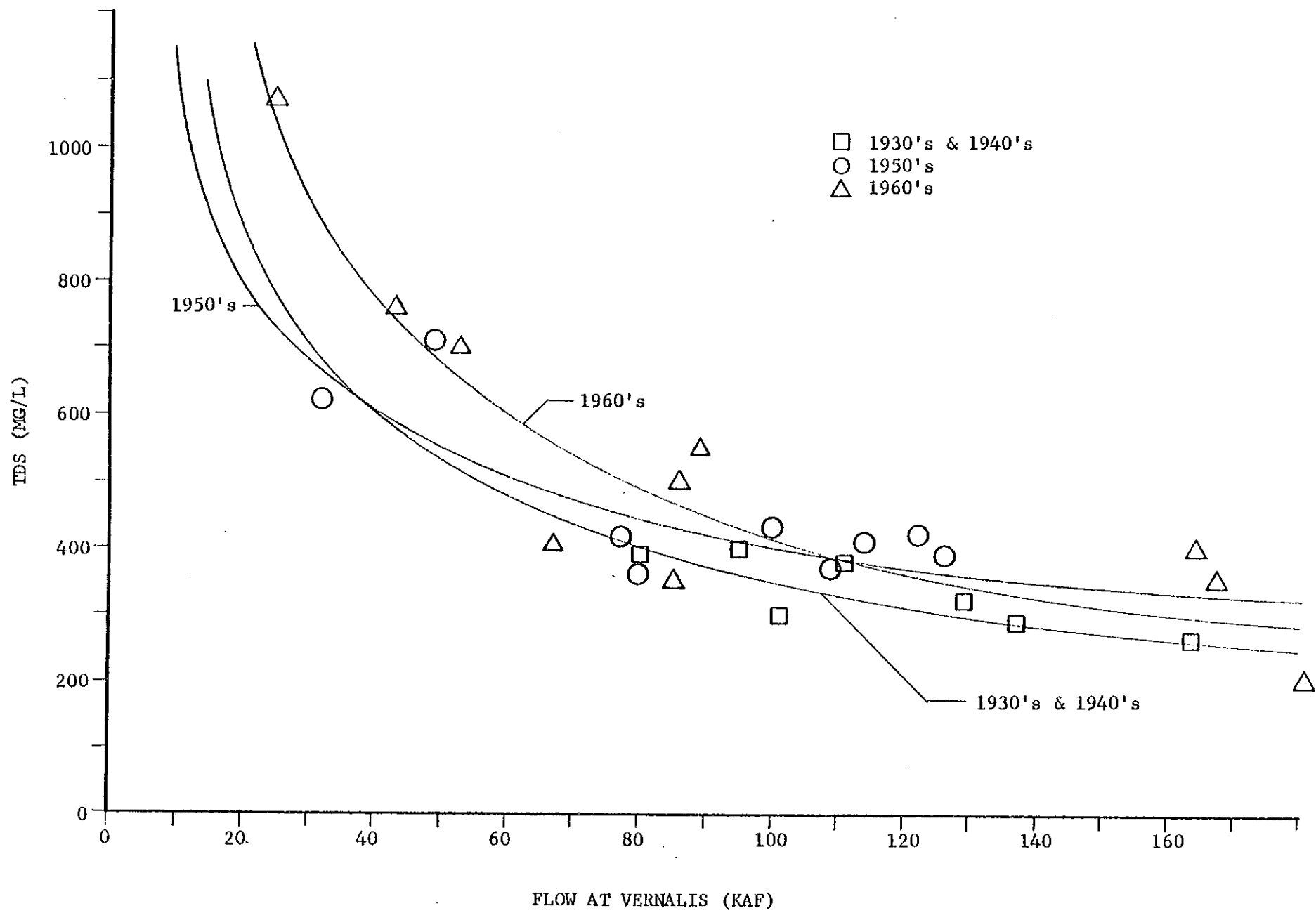

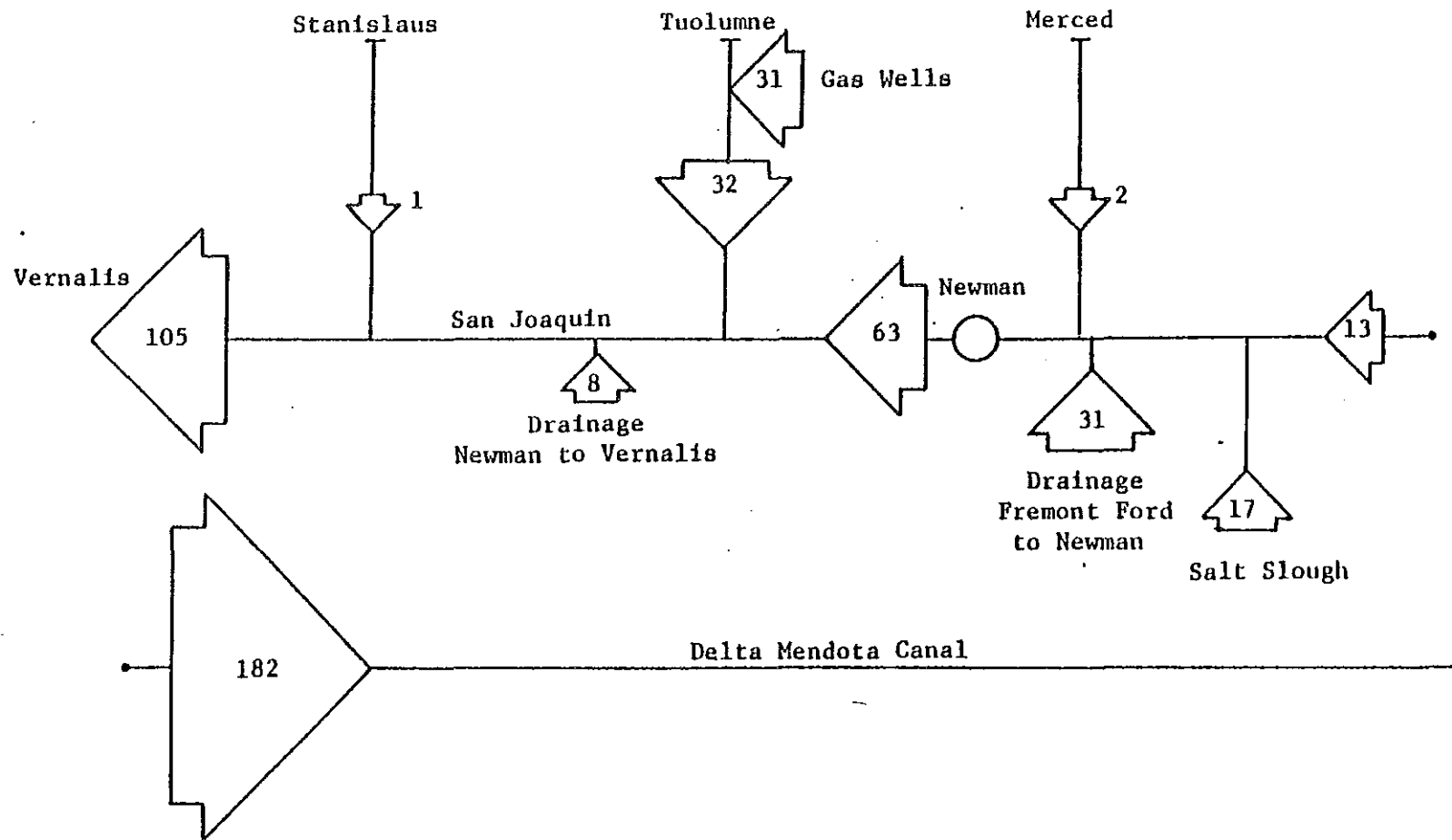

Figure VI-18 CHLORIDE SALT BALANCE--SAN JOAQUIN RIVER SYSTEM, 1960-61

(Numbers indicate salt load in thousand tons per year)

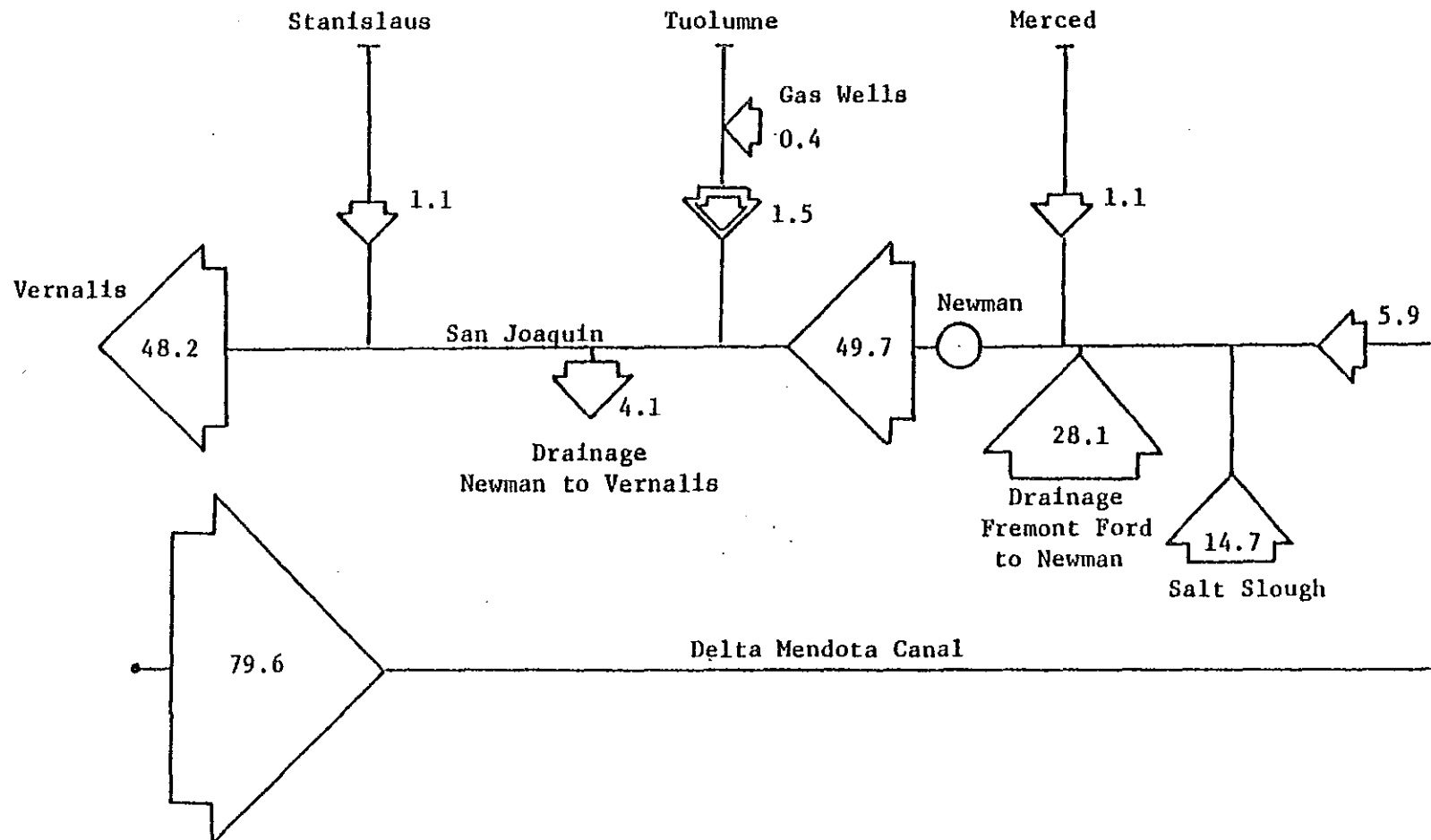

Figure VI-19 SULFATE SALT BALANCE FOR SAN JOAQUIN RIVER SYSTEM, 1960-61

(Numbers indicate salt load in thousand tons per year)

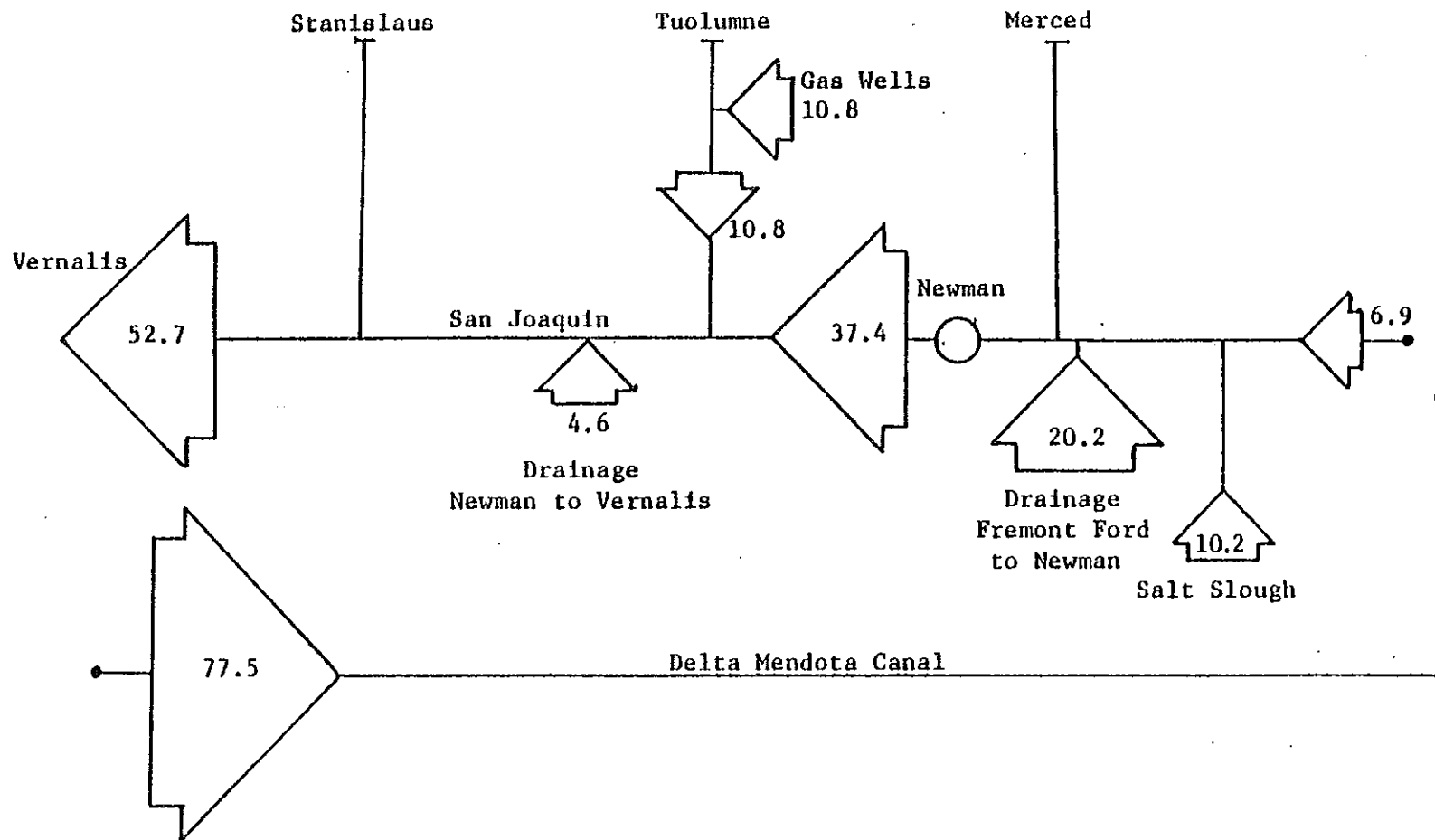

Figure VI-20 NONCARBONATE HARDNESS SALT BALANCE
 SAN JOAQUIN RIVER SYSTEM, 1960-61
 (Numbers indicate salt load in thousand tons per year)

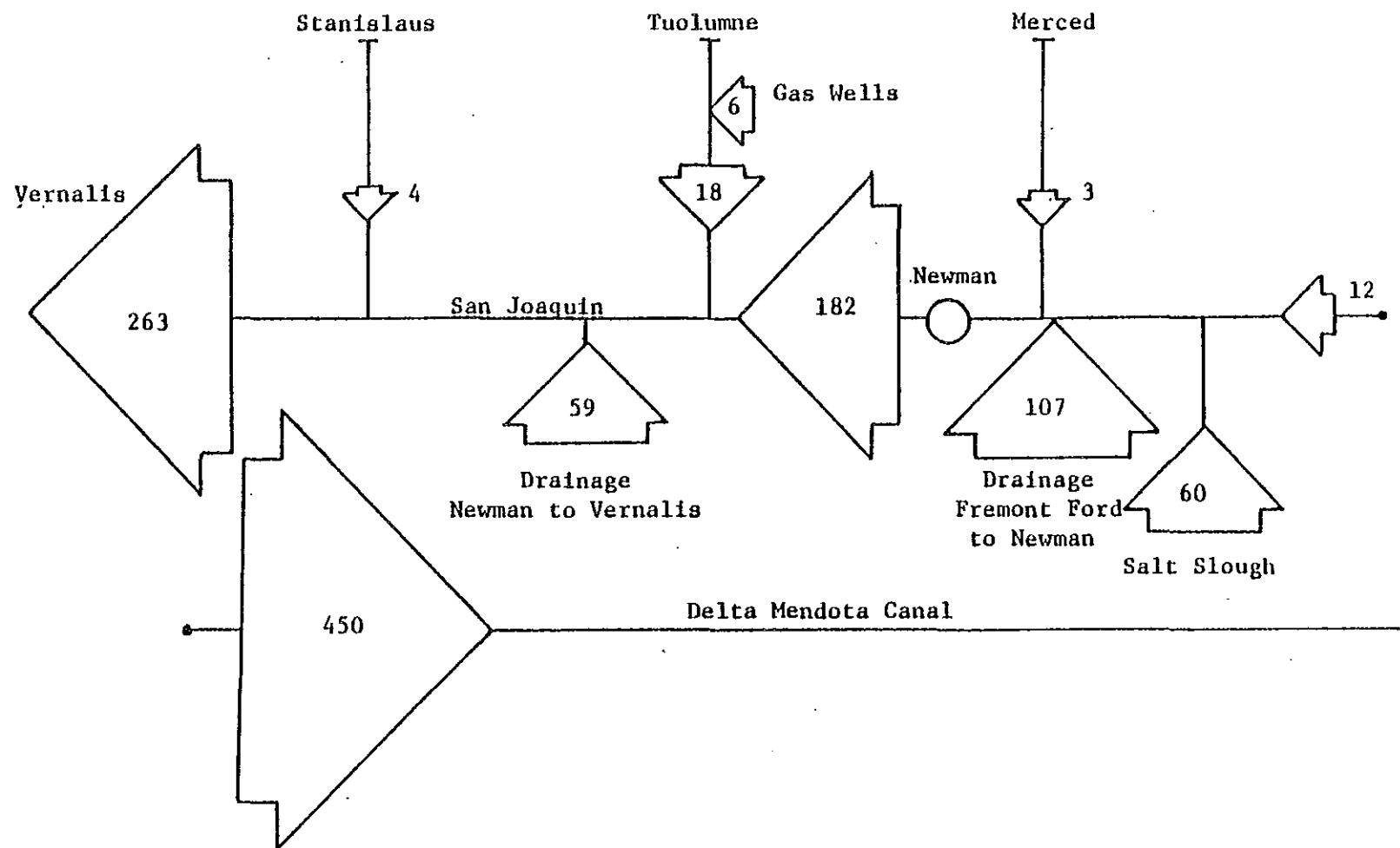

Figure VI- 21 BORON SALT BALANCE--SAN JOAQUIN RIVER SYSTEM, 1960-61

(Numbers indicate salt load in tons per year)

Generally, during periods of lower flows, the 1950's and 1960's have a higher TDS value. These concentration versus flow curves are also of the power function form.

Salt (Chloride) Balances by River Reaches

Like the station at Vernalis, most water quality stations along the San Joaquin River and its tributaries provided only spotty information prior to 1952. Of the data available for earlier years, the record of chloride concentration is the most complete for the greatest number stations. Therefore, these data were used to develop relationships of chloride load versus flow at various water quality stations.

Curves were plotted of total monthly flow at the station versus total monthly chloride load. Preliminary work indicated that seasonal similarities in the data existed, and to simplify the task of verifying data for all months, only October, January, April, and July curves were formulated. Because of the shortage of data prior to 1952, all years prior to 1950 were considered as pre-CVP. Since the Delta-Mendota Canal did not go into operation until after 1950, no major source of imported salt existed to influence the analysis. For Vernalis one additional data point was included to insure that the curves did not exceed known limits. This additional point represented an extreme low flow condition for the San Joaquin River at Vernalis, when the TDS would likely correspond to drainage return flows. For this analysis a flow of 0.5 KAF and a TDS of 1,000 mg/L were assumed. Thus, when used as predictors the curves would not produce estimates of TDS higher than about 1,000 mg/L, the maximum observed during the 1977 drought.

Figures VI-15 and VI-16 are examples of chloride load versus flow curves for the month of July on the Tuolumne River at Tuolumne City. The actual data

FLOW VS. SALT LOAD ON TUOLUMNE RIVER PRE CVP JULY

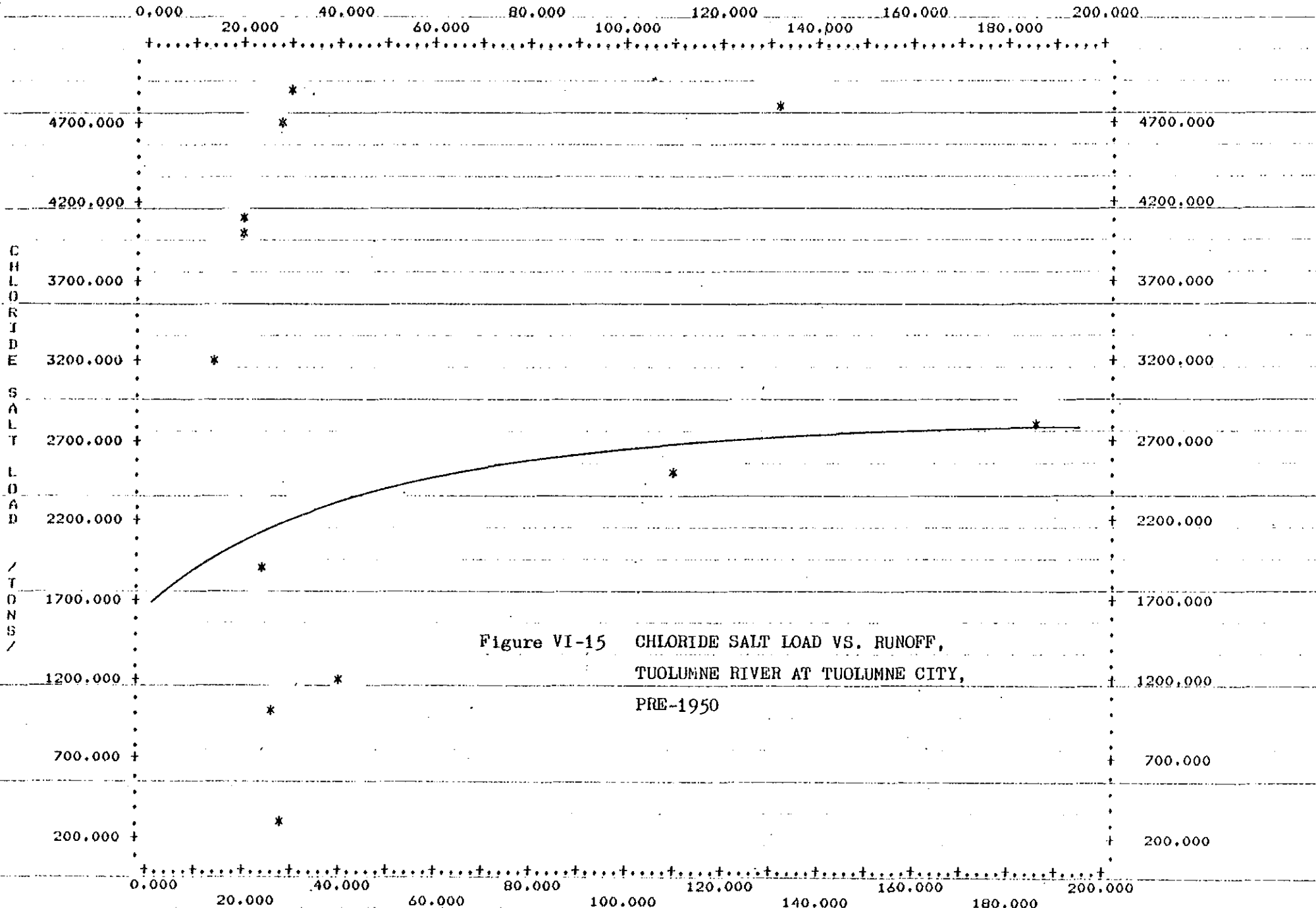

Figure VI-15 CHLORIDE SALT LOAD VS. RUNOFF,
TUOLUMNE RIVER AT TUOLUMNE CITY,
PRE-1950

FLOW VS. SALT LOAD ON TUOLUMNE RIVER POST CVP JULY

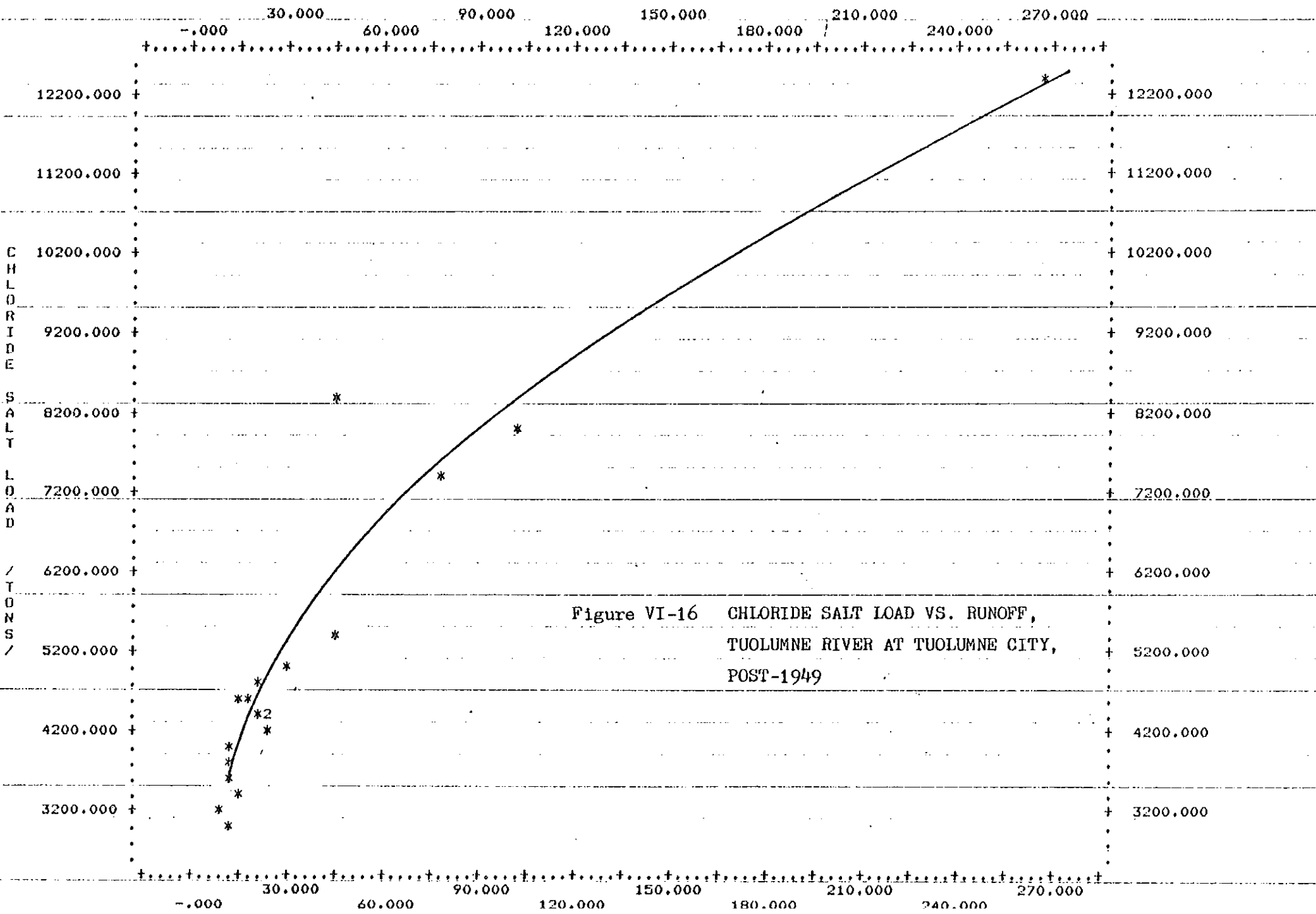

Figure VI-16 CHLORIDE SALT LOAD VS. RUNOFF,
TUOLUMNE RIVER AT TUOLUMNE CITY,
POST-1949

points used to define the curves are shown on the figures. Additional curves are in appendix 2. Table VI-7 summarizes the characteristics of regression curves of chloride load versus flow for each month of both the pre-1950 and post-1949 periods of analysis for the station at Vernalis.

Using the chloride load-flow curves thus developed, it is possible to perform a salt balance for any given flow at Vernalis.

Salt (Chloride) Balances by Representative Months

Chloride balances (concentration x flow x 1.36), expressed as tons per month, were calculated for the months of October, January, April, and July for a series of river reaches from above Newman to Vernalis. A typical summary of the calculation is presented in figure VI-17 where data are presented for both pre-1950 and post-1949 project periods. The principal tributary streams and stations along the main stem are identified between Newman and Vernalis. "Other" in the figure refers to accretions or subtractions occurring between stations at which both flow and chloride data were sufficient to make the salt balance calculation. Additional calculations are found in appendix 3.

In order to illustrate the changes in salt burden by year type, the data have been grouped, as in the case of water balance calculations, by reference to the Vernalis "unimpaired" flow. Average values of unimpaired flows at Vernalis by year type were calculated. Estimated actual flows at Vernalis were calculated using the average of actual Vernalis flows for a particular period and year type.

As a means of checking the appropriateness of results based on the average of actual flows, and only four representative months, each year of record was evaluated for all months using regression curves and actual flows at Vernalis. An average "actual" load was then calculated for each year type and period. Results for comparison are in table VI-8.

TABLE VI - 7
 CHLORIDE LOAD VS. FLOW COEFFICIENTS AT VERNALIS
 1930 - 1950

MONTH	C1	C2	# OF PAIRS*	R
OCTOBER	.3416451758E+03	.7238303788	7	.993
NOVEMBER	.3393044927E+03	.6880766404	6	.987
DECEMBER	.3639052910E+03	.6787756342	7	.972
JANUARY	.3928349175E+03	.6231583178	10	.965
FEBRUARY	.5368474514E+03	.5675747831	9	.914
MARCH	.4968879101E+03	.6035477710	10	.951
APRIL	.3866605718E+03	.5624873484	9	.942
MAY	.3805863844E+03	.5399998219	9	.920
JUNE	.6355065225E+03	.5175446121	9	.849
JULY	.6038658134E+03	.6219848451	8	.900
AUGUST	.3874538954E+03	.7410226741	8	.991
SEPTEMBER	.3500905302E+03	.7524035817	8	.989

* # OF PAIRS DOES NOT INCLUDE RESTRICTION POINT (.5,200)

$$Y = C1 * (X)^{C2}$$

80/05/16.

11.17.58.

OCTOBER

39.7 KAF UNIMPAIRED AT VERNALIS

DRY YEAR

FLOW (KAF)		STATION	CHLORIDES			
PRE-1950	POST-1949		PRE-1950 (TONS)	PRE-1950 (PCT)	POST-1949 (TONS)	POST-1949 (PCT)
24.	20.	NEWMAN	3040.	30.	4170.	29.
16.	16.	OTHER	1960.		2820.	
39.	36.	GRAYSON	5000.	49.	6990.	49.
55.	51.	TUOLUMNE	3830.	37.	5050.	35.
5.	9.	OTHER	1210.		2540.	
99.	96.	MAZE ROAD	10040.	98.	14570.	102.
14.	17.	STANISLAUS	260.	3.	200.	1.
-3.	7.	OTHER	-40.		-470.	
110.	120.	VERNALIS	10260.	100.	14290.	100.

: TOT. OTHERS : 3130. : 31. : 4890. : 34. :
 : NMN. + OTH. : 6170. : 60. : 9060. : 63. :

QUALITY PPM (CL) / (TDS)

PRE PPM = 69. / 324.
 POST PPM = 88. / 383.
 DEGRADATION = 19. / 59.

Figure VI-17 SAMPLE OF COMPUTER PRINTOUT,
 SALT BALANCE COMPUTATION

* NOTE:

PCT COLUMN IS PERCENT OF VERNALIS.

Table VI-8
UNIMPAIRED FLOW OF THE SAN JOAQUIN RIVER
AT VERNALIS

Average Vernalis unimpaired flow				
	October	January	April	July
Dry year	39.7	110.5	601.4	101.4
Below normal	49.3	167.3	794.9	224.9
Above normal	42.4	352.5	1055.7	425.1
Wet year	29.8	695.7	1169.0	921.0
Estimated actual Vernalis flow				
<u>Pre-years*</u>				
Dry year	110	150	86	46
Below normal	101	119	113	64
Above normal	98	279	805	235
Wet year	107	410	1175	730
<u>Post-years**</u>				
Dry year	120	133	44	18
Below normal	104	202	150	46
Above normal	65	263	264	72
Wet year	87	714	1000	300

* 1930-1949

** 1950-1969

The salt load estimated for Vernalis by month and year classification is summarized in table VI-9. In this summary, the salt load varies with time and year classification. Salt loads tended, of course, to be sensitive both to runoff and concentration. In the pre-1950 period, for example, the greater loads occurred in the wetter years, and generally in the month of July.

In the post-1949 period, salt loads are estimated to be generally higher in all months except July. The average annual salt burden at Vernalis appears to have remained unchanged in wet years and increased by 35 percent in below normal years. The total average annual load in dry years has increased by about 18 percent. In the April-September period, salt loads were unchanged from pre to post dry years; increased in below normal years; decreased in above normal years and decreased slightly in wet years. This can probably be explained by lower flows and loads in the summer months. These estimates are based on "actual loads" as identified in table VI-9.

Salt Balances for a Dry Year

Additional insight to salt balance estimation is provided by an evaluation of the salt load distribution along the San Joaquin River for the dry year 1961, as illustrated by figures VI-18 through VI-21.

In figure VI-18 is shown a schematic representation of the average amounts (thousand tons per year) of chlorides delivered over the year by each of the several discrete sources, previously identified in figure VI-1, "The San Joaquin Valley System." The figure shows the dominance of the salt load at Vernalis by the principal drainage accretions in the upper San Joaquin River. It also shows, in the case of this particular constituent,* the important contribution of the Tuolumne gas wells. According to this analysis of the load

* The principal salt emitted by the gas wells is sodium chloride.

TABLE VI-9. CHLORIDE SALT LOAD AT VERNALIS (TONS)

	Dry years				Below normal years			
	Average flow*		Actual load**		Average flow*		Actual load**	
	Pre	Post	Pre	Post	Pre	Post	Pre	Post
Oct	10,260	14,290	10,191	12,703	9,650	12,920	9,631	12,663
Jan	8,920	10,420	8,784	10,284	7,720	12,730	7,650	12,320
Apr	4,740	6,030	4,496	5,754	5,520	11,080	5,502	10,329
Jul	6,530	4,540	6,254	4,434	8,020	7,700	7,877	7,500
Apr- Sept	33,810	31,710	33,580	33,106	40,620	56,340	46,482	54,595
Year	91,350	105,840	88,712	104,428	92,730	133,290	98,701	133,617
	Above Normal Years				Wet Years			
	Average Flow*		Actual load**		Average Flow*		Actual load**	
	Pre	Post	Pre	Post	Pre	Post	Pre	Post
Oct	9,440	9,280	9,238	9,051	10,060	11,400	10,051	11,291
Jan	13,130	14,450	12,926	12,611	16,690	23,320	16,666	21,689
Apr	16,660	14,670	16,434	13,934	20,620	28,410	20,569	27,638
Jul	18,020	9,910	17,498	9,766	36,470	22,130	36,236	21,378
Apr- Sept	104,040	73,740	90,217	71,332	171,270	151,620	136,420	127,626
Year	171,750	144,930	177,146	181,840	251,520	255,780	258,249	258,216

* Load based on regression of average flow for month.

** Load based on average of loads from regression of all flows for month.

NOTE: "Pre" refers to years 1930-1949
 "Post" refers to years 1950-1969

of chlorides that reaches Vernalis, about 60 percent of the load originates above the mouth of the Merced River, 30 percent with the gas wells and 10 percent from other sources, including the two east side tributaries and local drainage between Newman and Vernalis. About 30 percent of the total originates upstream of Fremont Ford (Salt Slough plus sources upstream to Mendota) and 30 percent enters in the comparatively short reach between Fremont Ford and Newman (less than 10 miles).

Figures VI-19 through VI-21 give a somewhat clearer picture of the relative contribution of the other drainage sources, exclusive of the unique influence of the Tuolumne gas wells. Since the wells are low in sulfate and the principal irrigated lands on the west side of the valley are high in this constituent, the sulfate balance depicted in figure VI-19 identifies a very large contribution from the drainage above the mouth of the Merced River. Very little sulfate load is contributed by either the east side streams or the gas wells. In this particular example, it appears that there is even a net export of sulfate to irrigated lands below Newman, not an unlikely occurrence in a dry year of max-irrigation water use and reuse. According to these analyses, about 57 percent of the sulfate load of the upper San Joaquin River (that apparently accounts for virtually all that arrives at Vernalis) originates between Fremont Ford and Newman, and about 30 percent comes from Salt Slough.

A very similar picture is presented by figure VI-20, for noncarbonate hardness (the equivalent of hardness originating from such salts as calcium and magnesium sulfate). It is noted in this case, however, that the gas wells do contribute about 20 percent of the total to Vernalis, while 71 percent originates in the upper San Joaquin River. The east side streams have virtually no noncarbonate hardness.

Finally, a boron balance is shown in figure VI-21 (note that values are in tons per year, not thousand tons, as in the previous examples). Again, although some boron is found in most waters tributary to the valley floor, the dominant sources are in the upper San Joaquin River basin about 69 percent of that which eventually passes Vernalis. In this case, local drainage between Newman and Vernalis contributes about 22 percent of the total.

It should be noted that for reference purposes, since it is a part of the valley system, the Delta-Mendota Canal's contribution is indicated in the figures. The imported salt load to the San Joaquin Valley is noted to range from 147 to 173 percent of that leaving at Vernalis for this dry year, 1961.

Summary of Salt Balance Calculations

Salt balances have been performed for two purposes: (1) to identify trends in load that have occurred with time, e.g., between the pre-1944 and post-1947 periods, and (2) to determine the relative contribution of the various sources of salt, including the contribution of the Tuolumne gas wells.

The salt load at Vernalis has changed between the pre-1944 and post-1947 periods, the amount varying with the year classification. Based on chloride data that extend back to the 30's, it appears that loads in the dry years increased 18 percent and below normal year loads increased 35 percent. Little or no load change is apparent in above normal and wet years. In the dry and below normal years the biggest increase in load occurred in April when spring runoff is probably flushing the basin of some accumulated salts. Consistent with this observation, loads in July have also decreased in dry and below normal years apparently due to a reduction in runoff. In general it appears that in drier years, salts are accumulated in the basin during low flow summer and early fall months and then released during the high flow winter and spring

months. Because a net increase in load has occurred, it seems likely that sources of salt are adding to the annual burden at Vernalis in dry and below normal years. Without reference to year classification, and comparing the 1950's and 1960's to the average of the 1930-49 period, it is noted further that the greater proportion of the post-1949 increase seems to have occurred in the more recent decade, i.e., the trend toward an increased salt burden is itself increasing, despite an apparent continuing decline in the total runoff at Vernalis.

A summary comparison of relative increase in salt burden at Vernalis by year classification is presented in table VI-10.

The relative contributions of various sources to the salt load at Vernalis were determined by performing water balances and mass balances for selected sections of the San Joaquin River system. Depending on the constituent selected and the particular hydrology used, the relative contribution of each source to the load at Vernalis can be expected to vary somewhat. For the dry year 1960-61 a breakdown in the percentage contribution from the various sources in the San Joaquin system is as shown in table VI-11.

Some highlights of this 1961 salt balance analysis are as follows:

1. About one-half of the salt load carried in the San Joaquin River at Newman originates in the reach between Mendota and Newman.
(Based on chloride balance.)
2. About 20 percent of the salt load that passes Newman is contributed between Mendota and Salt Slough.
3. Salt Slough is a major contributor to salt load accounting for one-third to one-half of the load at Newman.
4. The salt load that enters the San Joaquin River above Newman is equivalent to 60 to 100 percent of that observed at Vernalis.

Table VI-10
 PERCENTAGE CHANGE IN SALT LOAD (CHLORIDES)
 AT VERNALIS BETWEEN PRE-1950 AND POST-1949 AS A
 FUNCTION OF TIME OF YEAR AND YEAR CLASSIFICATION

Year Class	P E R C E N T C H A N G E *				
	M O N T H				Year
	October	January	April	July	
Dry	25	17	28	-29	18
Below normal	31	61	88	-5	35
Above normal	-2	-2	-15	-44	3
Wet	12	30	34	-41	0

* ((Salt load post-1949/salt load pre-1949)-1) x 100.

TABLE VI-11. PERCENTAGE CONTRIBUTION OF SOURCES
TO SALT LOAD ESTIMATES AT VERNALIS

Source	Percent of Total at Vernalis			
	Constituent*			
	Cl	SO ₄	NC	B
Mendota to Salt Slough	12.3	12.2	13.0	4.5
Salt Slough	16.2	30.5	19.4	22.8
Merced River	2.0	2.2	0	1.1
Drainage:				
Fremont Ford to Newman	29.5	58.3	38.4	40.7
San Joaquin at Newman	60.0	103.2	70.8	69.2
Tuolumne River above gas wells	1.0	1.9	0	4.6
Tuolumne River Gas Wells	29.5	1.0	20.5	2.3
Tuolumne River	30.5	2.9	20.5	6.9
Drainage:				
Newman to Vernalis	7.5	-8.4	8.7	22.4
Stanislaus River	2.0	2.3	0	1.5
San Joaquin River at Vernalis	100.0	100.0	100.0	100.0

* Cl = chlorides; SO₄ = sulfates; NC = noncarbonate hardness; B = boron

5. Of the chloride salt load carried by the river at Vernalis, less than 6 percent was contributed by the three major tributaries--the Merced, the Tuolumne (excluding the gas wells) and the Stanislaus.
6. The Tuolumne gas wells contributed chloride salt load equal to about 30 percent of the total at Vernalis, but only about 1 percent of the sulfates.
7. The sulfates entering the system above Newman exceeded the total load at Vernalis, i.e., the area above Newman accounted for virtually all of the downstream sulfate load.

SECTION C. WATER QUALITY CHANGES AT VERNALIS

This section deals with the effects any changes in flow or load may have had on Vernalis water quality. Due to the sparse data available prior to 1953, two different methods were developed to predict the quality in the years prior to 1953. The first of these methods utilizes a very complete record of chloride values taken at Mossdale, to predict the pre-1953 TDS at Vernalis. The second method utilizes the flow versus load equations developed for salt balance computations and the relationship between chlorides and TDS at Vernalis to estimate TDS for the pre-1950 and post-1949 periods based on Vernalis flow. Results of both methods are discussed and where results are substantially different comparisons are made.

Estimation based on Mossdale Data

Because of the sparse data prior to 1953, one means of determining the Vernalis quality was developed based on chloride observations at Mossdale on the San Joaquin River approximately 16 river miles downstream of Vernalis. These observations, made as a part of the Department of Water Resources' extensive 4-day sampling program, cover a period from June 1929 through March

1971, overlapping for about 17 full years the Service monitoring of EC at Vernalis. The data developed in the DWR program, however, represent grab samples collected at 4-day intervals (about 8 times per month in most months) at or near conditions of slack water (approximately 1.5 hours after high tide). Thus, they tend to reflect the highest levels of chloride that would likely be observed as a result of tidal action at the Mossdale station.

Significant reversals in tide occur at Mossdale where the tidal range is normally about 2.5 to 3 feet. The Vernalis gage, on the other hand, is above tidal influence at most levels of riverflow.

The special value of the Mossdale data which are summarized in table VI-12, is that they cover periods both before and after the construction of the CVP and therefore can be used to predict changes that have occurred from 1930 through 1967, the period selected for the present study of CVP impacts on water quality in the San Joaquin River system.

However, because the station at Vernalis is about 16 miles upstream of Mossdale, it is necessary to demonstrate that there is a relationship between observations taken at the two locations. This is accomplished by correlation of the mean monthly TDS at Vernalis (table VI-13) with the mean monthly slack water chloride values (8 grab samples) at Mossdale (table VI-12), as shown in figure VI-22. Data shown are for the period April through September, as defined for use in this investigation, and cover the period 1953 through 1970, except for a few months for which no data existed.

As may be clearly seen from the array of data in figure VI-22, the correlation between TDS (Vernalis) and chlorides (Mossdale) is strong. This is not unexpected due to the proximity of the two stations and the apparent lack of intervening processes that could lead to a disproportionate balance between

TABLE VI-12. MEAN MONTHLY SHLORIDES AT MOSSDALE¹, MG/LITER
 BASED ON DWR 4-DAY GRAB SAMPLE PROGRAM

	<u>O</u>	<u>N</u>	<u>D</u>	<u>J</u>	<u>F</u>	<u>M</u>	<u>A</u>	<u>M</u>	<u>J</u>	<u>J</u>	<u>A</u>	<u>S</u>
1929									74	120	108	56
1930	61	74	84	60	71	67	47	46	40	71	68	58
1931	65	73	61	71	70	124	114	95	93	100	90	80
1932	80	94	71	20	10	34	18	12	10	30	104	80
1933	63	47	58	54	47	89	113	89	19	75	102	77
1934	67	70	-	-	-	-	-	-	128	94	108	138
1935	168	66	49	18	24	29	17	14	18	53	103	78
1936	54	61	39	72	23	14	20	12	15	74	105	81
1937	58	59	47	38	69	14	15	10	12	79	108	78
1938	61	76	34	34	17	28	33	20	21	19	45	106
1939	71	69	55	56	37	33	83	76	84	113	119	100
1940	103	103	93	76	76	38	48	31	32	76	94	108
1941	114	69	86	48	39	48	46	39	36	50	-	-
1942	-	-	-	19	16	29	32	15	9	13	90	68
1943	56	80	38	-	-	-	-	-	-	-	-	-
1944	-	-	-	-	-	-	-	38	49	91	109	103
1945	71	58	58	47	25	21	24	18	15	56	84	69
1946	50	54	45	26	40	63	28	13	50	96	107	97
1947	87	65	42	64	84	74	103	60	115	146	159	101
1948	95	81	93	94	181	186	86	25	21	85	126	103
1949	90	116	106	96	111	37	64	34	78	155	165	149
1950	120	95	100	90	41	79	31	30	44	145	153	129
1951	121	69	15	33	33	51	101	44	64	154	159	133
1952	108	112	66	26	20	23	20	25	12	72	104	90
1953	96	88	51	38	66	143	131	60	32	92	145	122
1954	102	100	101	104	91	59	29	27	135	174	181	172
1955	139	119	100	67	89	126	154	130	93	185	180	175
1956	163	151	70	10	26	57	42	16	13	84	100	96
1957	92	82	76	104	135	87	137	90	62	139	160	134
1958	78	73	74	96	56	35	27	14	16	86	110	88
1959	74	51	68	100	96	136	181	169	212	225	217	183
1960	174	140	129	133	138	245	204	192	220	173	223	247
1961	184	141	121	131	175	258	264	242	261	197	165	278
1962	277	207	207	220	117	56	96	69	57	194	204	169
1963	151	116	84	112	44	120	22	21	36	-	-	-
1964	-	64	61	83	142	212	212	217	182	261	296	179
1965	-	-	-	30	33	45	23	45	60	130	141	-
1966	103	56	-	80	86	140	-	195	229	247	251	218
1967	135	144	65	98	43	65	18	15	12	37	104	97
1968	72	55	57	90	103	76	153	176	214	220	186	166
1969	127	129	79	43	21	24	18	13	12	49	106	61
1970	43	45	55	46	34	63	133	81	70	143	142	126
1971	131	-	50	45	63	81	-	-	-	-	-	-

¹Average of up to 8 observations taken at roughly 4-day intervals at approximately one and one-half hours after high tide at Mossdale Bridge

TABLE VI-13. MEAN MONTHLY TOTAL DISSOLVED SOLIDS AT VERNALIS *

Year	O	N	D	J	F	M	A	M	J	J	A	S
1953				124	201	400	463	207	128	300	425	373
53-54	317	334	342	365	328	220	124	136	443	539	540	515
54-55	378	354	285	223	254	341	474	388	264	449	464	476
55-56	439	403	302	NR	NR	214	148	69	81	279	295	318
56-57	312	295	254	381	464	330	417	331	203	455	479	451
57-58	316	271	282	346	249	202	149	97	89	289	417	315
58-59	280	198	258	366	331	428	546	538	589	634	620	557
59-60	502	446	428	461	482	654	585	582	673	710	640	682
60-61	520	460	402	447	591	715	846	715	794	936	941	807
61-62	805	661	690	713	440	238	325	237	183	516	565	496
62-63	415	370	267	413	145	395	108	93	125	369	477	405
63-64	287	238	201	301	458	578	562	564	571	756	774	615
64-65	472	340	281	163	189	247	150	194	169	422	494	401
65-66	258	243	243	332	346	NR	NR	598	662	729	727	698
66-67	485	469	260	402	222	264	123	104	86	162	365	354
67-68	299	222	240	367	401	325	486	576	659	665	599	568
68-69	458	481	329	198	129	146	118	86	84	221	363	249

*Average of continuous EC recording converted to TDS by relationships of the form $TDS = C_1 \times EC + C_2$

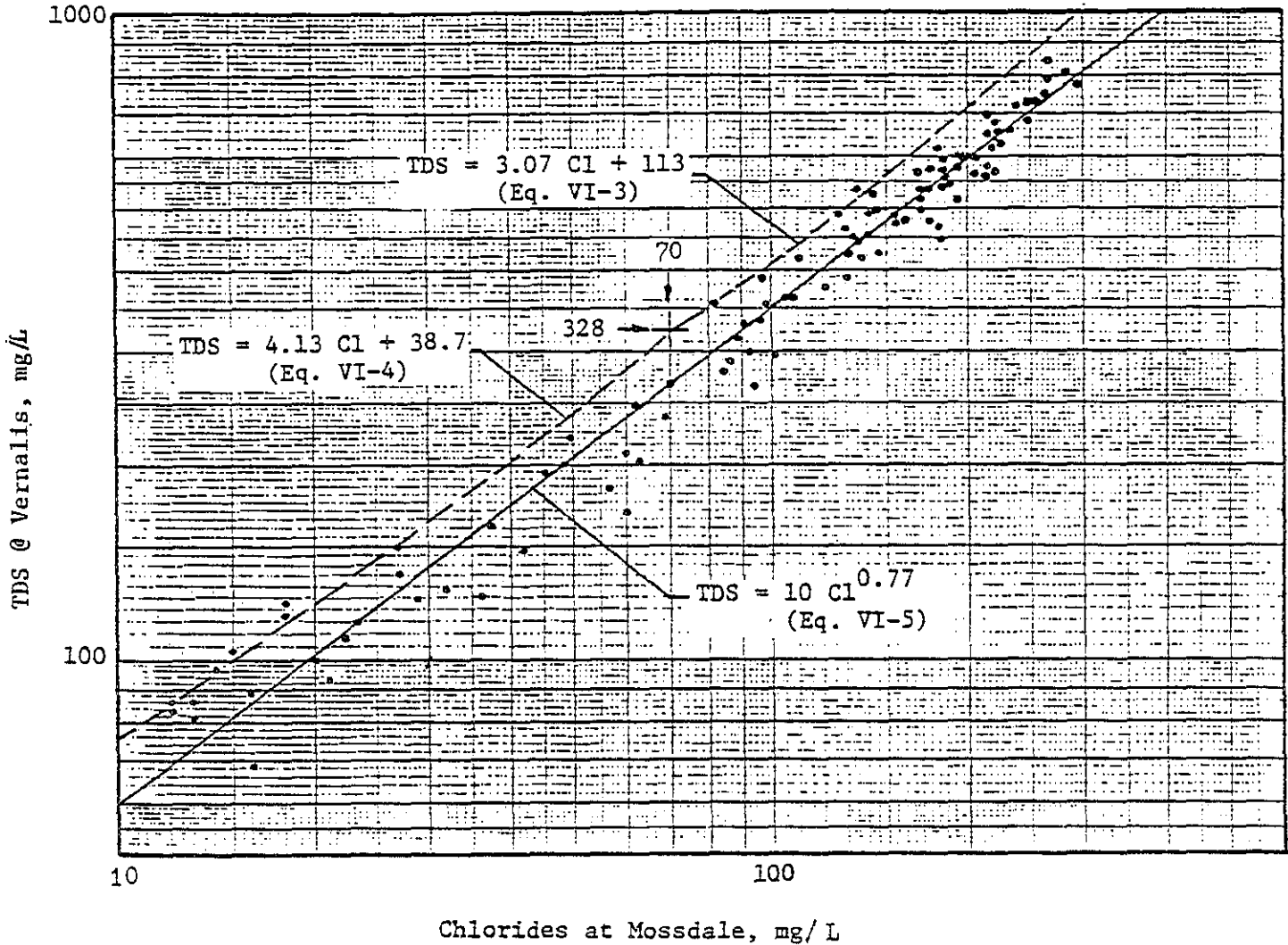

Figure VI-22 RELATIONSHIP BETWEEN TOTAL DISSOLVED SOLIDS AT VERNALIS AND CHLORIDES AT MOSSDALE

Data are for April-Sept, 1953-1970
 Monthly mean concentrations, mg/L

chlorides and total salts over the historic period considered. The relationship between these quality constituents is given best by the equation:

$$\text{TDS} = 10 (\text{Cl}^-)^{0.77} \quad (5)$$

where

TDS = total dissolved solids, mg/L

Cl^- = chlorides, mg/L

With the aid of this equation, it is now possible to relate the 4-day chloride data at Mossdale with the corresponding values of TDS at Vernalis and vice versa, recognizing of course that the chloride values are for average high tide, slack water conditions, while the TDS values are averages over the 24-hour daily period.

Historical Changes in TDS at Vernalis

The pattern of TDS change that has occurred at Vernalis is illustrated in figure VI-23 which shows in the lower section the chlorides history actually observed at Mossdale and in the upper section the parallel pattern of TDS at Vernalis estimated by means of Equation 5. To supplement the information on TDS at Vernalis provided in table VI-13, the earlier record of TDS based on the Mossdale experience and the predictor Equation 5 is summarized in table VI-14 covering the hydrologic years 1930 through December 1953. Together, tables VI-13 and VI-14 provide a continuous record of water quality experience at Vernalis from 1930 through 1969.

This water quality experience can be summarized in several ways.

Graphical summary. The graphical history of water quality at Vernalis is illustrated by average monthly TDS in figure VI-23, which shows the long term as well as the seasonal variability. The long-term changes are depicted by the 3-year moving average line presented in the plot of monthly TDS's at Vernalis. The short-term seasonal variations are evident in the month-by-month fluctuations.

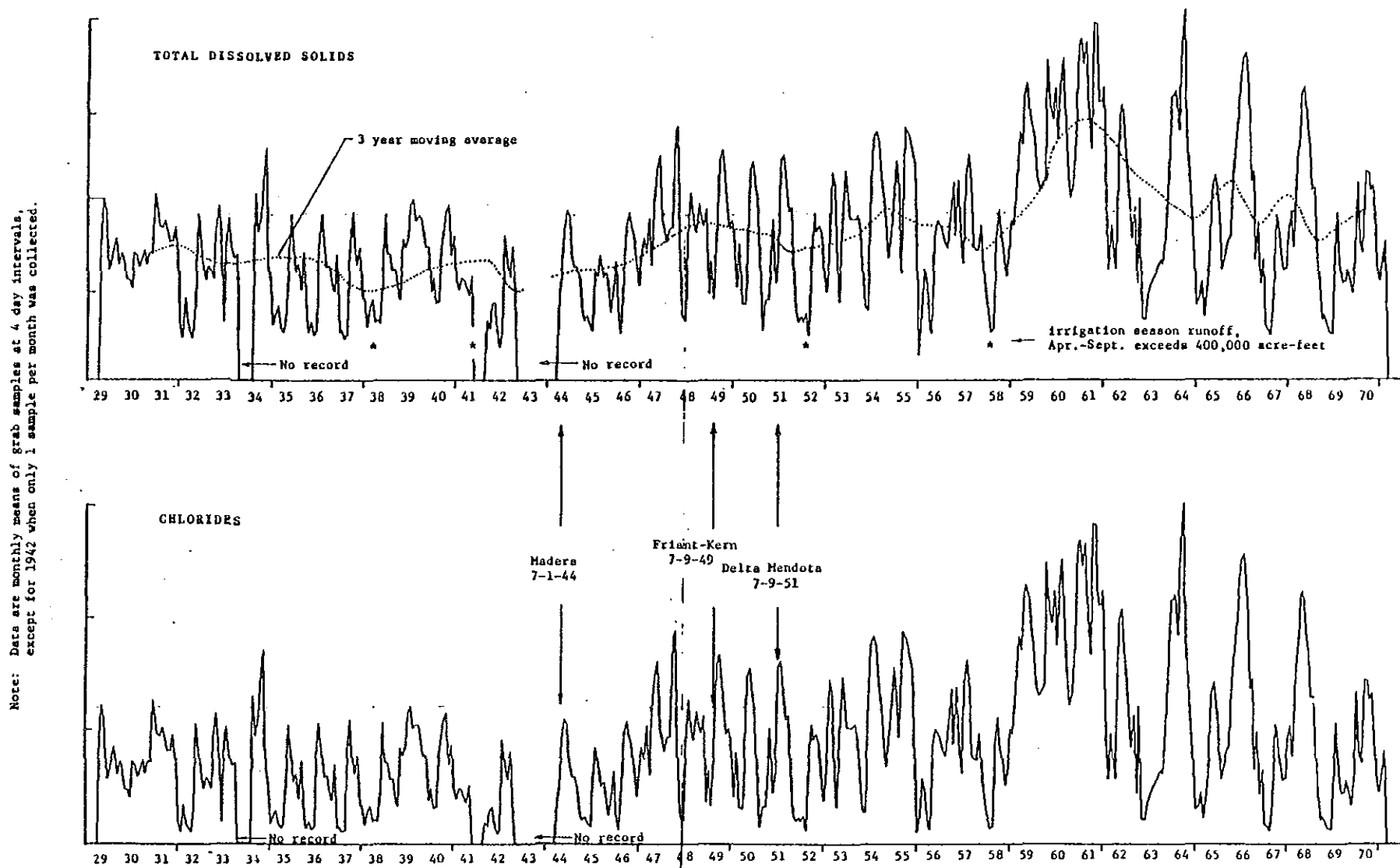

Figure VI-23 OBSERVED CHLORIDES AT MOSSDALE AND ESTIMATED TOTAL DISSOLVED SOLIDS AT VERNALIS 1929-1971

Table-VI-14. MEAN MONTHLY TOTAL DISSOLVED SOLIDS AT VERNALIS[†], mg/liter
 Based on TDS (Vernalis): Chloride (Mossdale) Correlation
 for period 1953-1970

Year	O	N	D	J	F	M	A	M	J	J	A	S
1929-30	237	275	303	234	266	255	194	191	171	266	258	228
30-31	249	272	234	266	263	409	383	333	328	347	320	292
31-32	292	331	266	100	59	151	93	68	59	137	357	292
32-33	243	194	228	216	194	317	381	317	97	278	352	283
33-34	254	263	-	-	-	-	-	-	419	301	368	444
34-35	517	251	200	93	116	134	89	76	93	213	355	286
35-36	216	237	168	269	112	76	100	68	80	275	360	295
36-37	228	231	194	165	261	76	80	59	68	289	367	286
37-38	237	281	151	151	89	130	148	100	104	97	187	363
38-39	266	260	219	222	158	148	300	280	303	381	396	347
39-40	355	355	328	281	281	165	197	141	144	281	330	368
40-41	384	261	309	197	168	197	191	168	158	203	-	-
41-42	-	-	-	97	85	134	144	80	54	72	320	258
42-43	222	292	165	-	-	-	-	-	-	-	-	-
43-44	-	-	-	-	-	-	-	165	200	322	370	355
44-45	266	228	228	194	119	104	116	93	80	222	303	261
45-46	203	216	187	123	171	243	130	72	203	336	365	338
46-47	311	249	178	246	303	275	355	234	386	464	496	349
47-48	333	295	328	331	548	559	309	119	104	306	414	355
48-49	320	389	362	336	376	161	246	151	286	486	510	471
49-50	399	333	347	320	175	289	141	137	184	462	481	422
50-51	402	261	80	148	148	206	349	184	246	483	496	432
51-52	368	378	252	123	100	112	100	119	68	269	357	310
52-53	336	314	206	165	252	457	426	234	144	325	462	404

*Estimated from the equation: $TDS (Vern) = 10[Cl(Moss)]^{0.77}$

Extreme values--maximum monthly TDS. Maximum monthly TDS values by year over the period 1930-1966 are depicted in the graph of figure VI-24. The figure summarizes the extremes in quality and flow during each year of record as tabulated in table VI-15. The triangles in the lower portion of the graph indicate the most critical quality (i.e., maximum TDS) occurrences in each of the indicated years within the period 1930-1944. The solid circles, largely occupying the upper portion of the graph, correspond to the critical occurrences in each of the years, 1952-1966. 1943-1951 are not plotted for reasons of clarity, although they generally are distributed in the region bounded by TDS values of 303 to 510 mg/L as will be seen in table VI-15.

Since a comparison of the pre-1944 and post-1947 conditions is germane, it may be noted further that the means and ranges corresponding to the two data sets* are as given in table VI-16 following.

Mean monthly values of TDS by decades. Using the average monthly values of TDS from tables VI-13 and VI-14 covering the period 1930 through 1969, it is possible to summarize the general trends of changes that have occurred for each month of the year. These trends are given by the mean 10-year values for each of the decades of the 1930's, 1940's, 1950's, and 1960's in table VI-17.

In a few cases, only 8 or 9 observations are included in the averages. These are noted by the asterisks ** and *. Also given in the table for later reference are the corresponding values of the mean monthly runoff by months (KAF) at Vernalis in the San Joaquin River.

* It will be recalled that the mean annual unimpaired (rimflow) runoffs during the season April through September for these two periods, pre-1944 and post-1947, are comparable, the post-1947 period being slightly drier by approximately 5.6 percent.

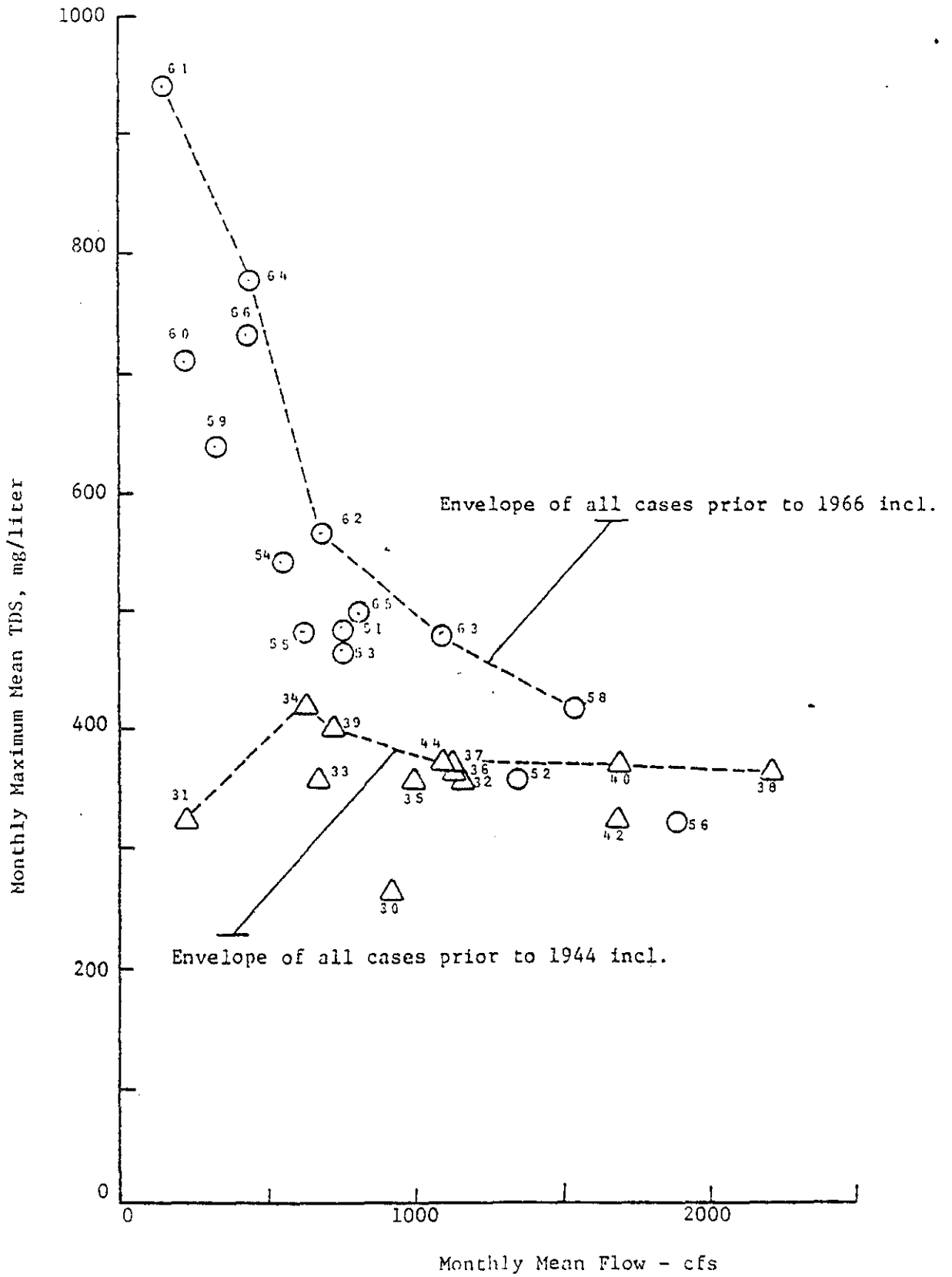

Figure VI- 24 WATER QUALITY AND FLOW EXTREMES AT VERNALIS
1930 - 1966

Table VI-15. EXTREME VALUES OF TDS AND FLOW AT VERNALIS, 1930-1966

Year	Maximum	Minimum	
	Monthly Mean TDS*	Monthly Mean Flow	
	MG/L	AF x 1000	CFS
1930	266	56.6	922
1931	320	14.0	228
1932	357	71.3	1161
1933	352	41.0	668
1934	419	37.3	628
1935	355	61.2	996
1936	360	69.0	1124
1937	367	69.4	1130
1938	363	132.0	2222
1939	396	44.0	717
1940	368	100.4	1690
1941	no data	114.0	1919
1942	320	103.6	1687
1943	no data	94.8	1544
1944	370	67.1	1093
1945	303	109.4	1782
1946	365	75.2	1263
1947	496	35.0	570
1948	414	44.6	726
1949	510	37.0	602
1950	481	38.2	622
1951	496	46.7	760
1952	357	83.3	1357
1953	462	46.0	749
1954	540	33.6	547
1955	476	36.3	611
1956	318	112.2	1887
1957	479	46.3	754
1958	417	94.4	1537
1959	634	19.2	313
1960	710	13.7	223
1961	941	9.3	151
1962	565	42.7	695
1963	477	67.4	1098
1964	774	27.1	441
1965	494	75.0	804
1966	729	27.0	439

*Extreme values occurred within the period June-Sept. Flow values correspond to the month in which maximum TDS occurred, 1930-1953 values based on Mossdale data.

TABLE VI-16. SUMMARY OF EXTREME WATER QUALITY CONDITION
APRIL - SEPTEMBER PERIOD

	1930-1944*	1952-1966
CRITICAL WATER QUALITY		
Monthly Mean TDS Mg/L		
Maximum for period	419	941
Mean for period	355	558
Minimum for period	266	318
LOW FLOW CONDITIONS		
Average daily flow ft ³ /s corresponding to critical TDS		
Maximum	628	151
Mean	1182	774
Minimum	2222	1887

* Based on Mossdale data.

TABLE VI-17. MEAN MONTHLY RUNOFF AND TDS
AT VERNALIS BY DECADES
1930-1969

Month	1930's ***		1940's ***		1950's		1960's	
	R KAF	TDS mg/L	R KAF	TDS mg/L	R KAF	TDS mg/L	R KAF	TDS mg/L
Oct	99	274	110	299**	102	355	98	460
Nov	107	260	129	258**	154	314	117	393
Dec	152	218*	194	261**	344	261	197	334
Jan	200	191*	299	225**	262	271*	294	379
Feb	455	169*	391	256**	280	256*	401	340
Mar	530	188*	505	230**	342	280	385	396*
Apr	503	196*	502	211**	429	287	397	368*
May	678	166*	639	136*	451	223	404	375
Jun	620	172	675	179*	376	231	393	401
Jul	204	258	191	299*	101	418	139	549
Aug	66	332	75	389	56	461	58	595
Sep	70	312	85	344	72	420	76	528
Mean	282.5	228	316.3	257	247.4	315	238.3	427

* Only 9 observations in 10 year period

** Only 8 observations in 10 year period

***Based on Mossdale data

Note: Although 10 runoff observations were recorded for each 10-year period, the values shown are averages for the same series for which TDS values are given.

Figure VI-25 shows graphically the trend of mean monthly TDS at Vernalis on a seasonal basis by decades, from the 1930's through the 1960's.

Relationship Between Mean Runoff and Mean TDS

Data presented in table VI-17 permit illustration of the changes in runoff and corresponding TDS values that have occurred during each of the decades since the 1930's. The relationships between these quantities are shown graphically in figures VI-26A, B, C, and D. The individual data points are identified by a number corresponding to the month of the year. Coordinates for each point were determined as the average monthly TDS and average monthly runoff without regard for year type (i.e., dry, below normal, above normal, wet).

Using figure VI-26A as illustrative of a normal pre-1950 cycle, it is noted that during the year the lowest runoff-highest TDS month is August (which is the case, incidentally, for all four decades). In succeeding months the TDS gradually drops as the average flow increases, although not in a linear fashion. The curve connecting the monthly points follows in a fairly smooth sequence through the winter and into the spring when the best quality is identified with the greatest monthly runoff (point 5 corresponding to May, the month of maximum runoff in the pre-1950 period). Thereafter the flow declines as the TDS level rises gradually, but at generally higher levels through the summer months. A somewhat similar pattern is seen for the 1940's (see figure 26B), although in this case the early spring months seem to reflect somewhat higher TDS levels. The range of flows and TDS are comparable to the 1930's. In the 1950's (see figure 26C) some of the same characteristics are noted although flows are less and TDS values higher. Also, less variation in TDS in relation to flow is noted during the winter and early spring months. In the 1960's (see figure 26D), the pattern is shifted decidedly upward and toward the left,

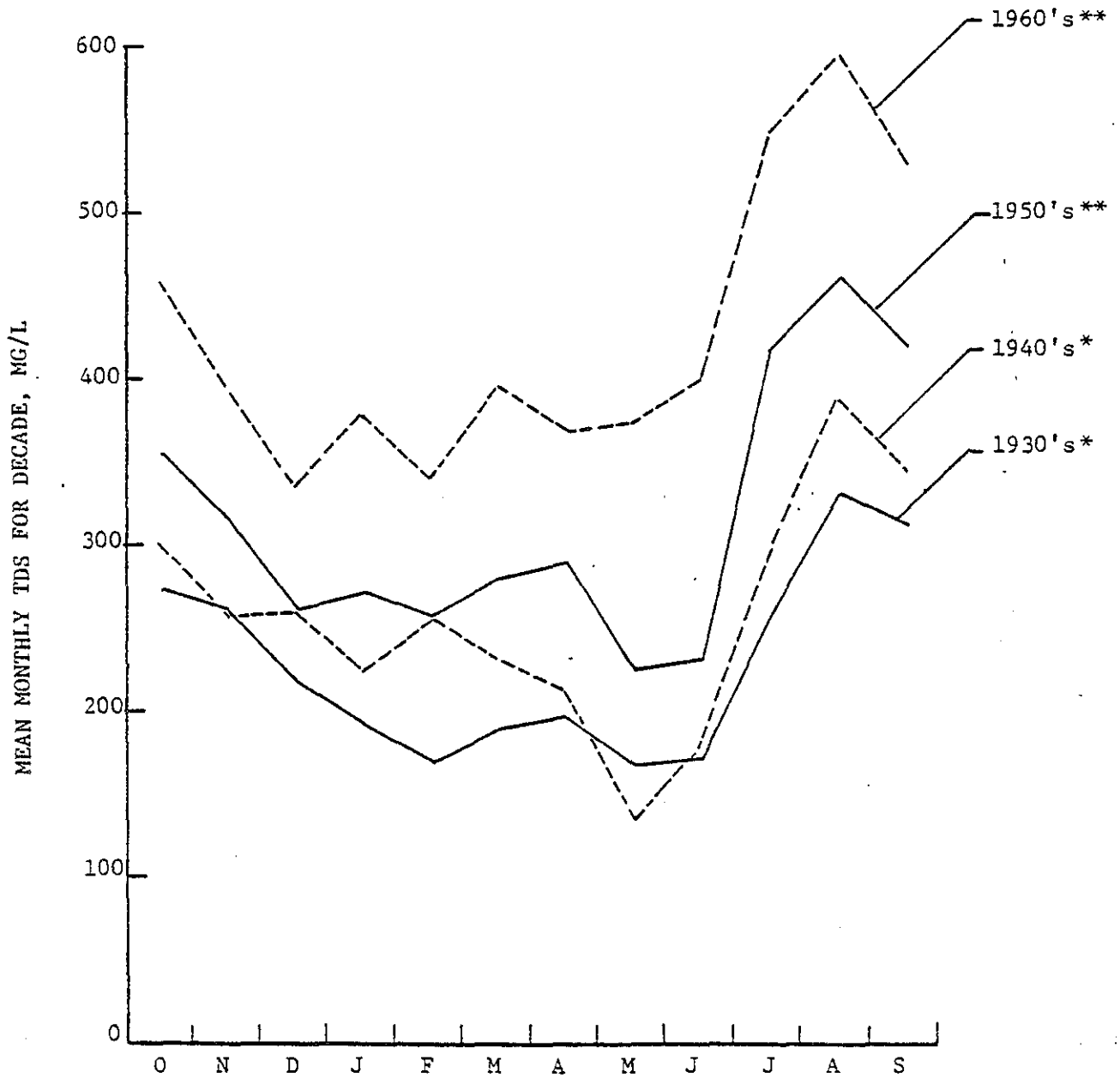

Figure VI-25 MEAN MONTHLY TDS AT VERNALIS BY DECADES
1930-1969
*Based on Mossdale chloride data
**Based on actual observations

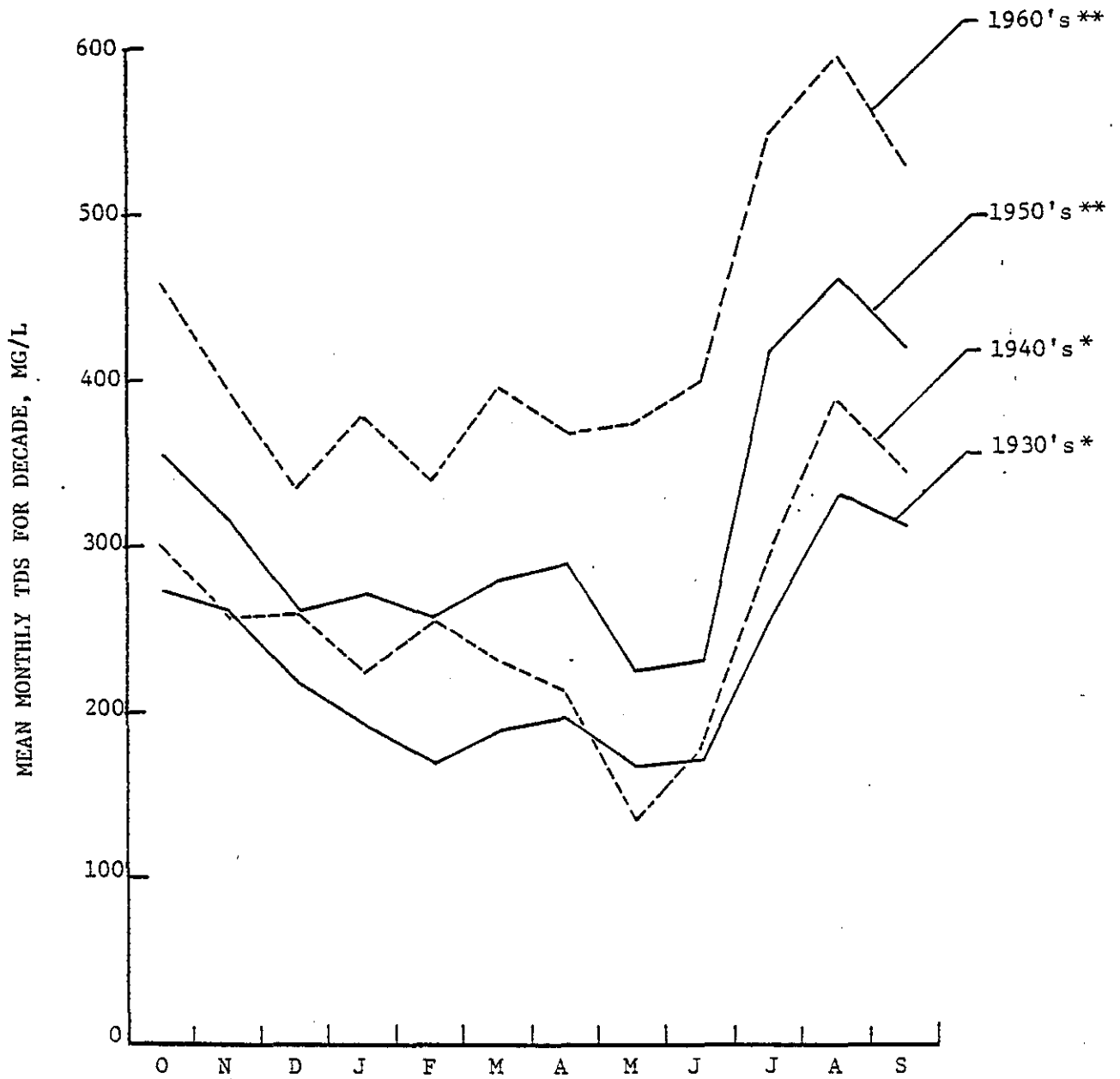
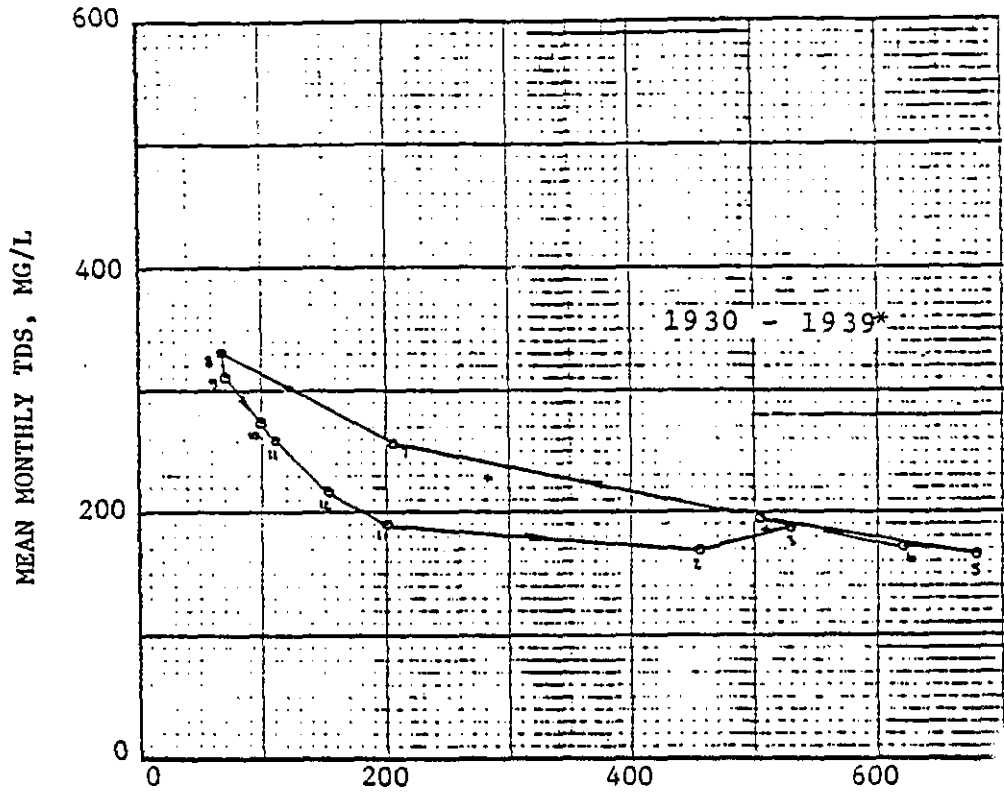
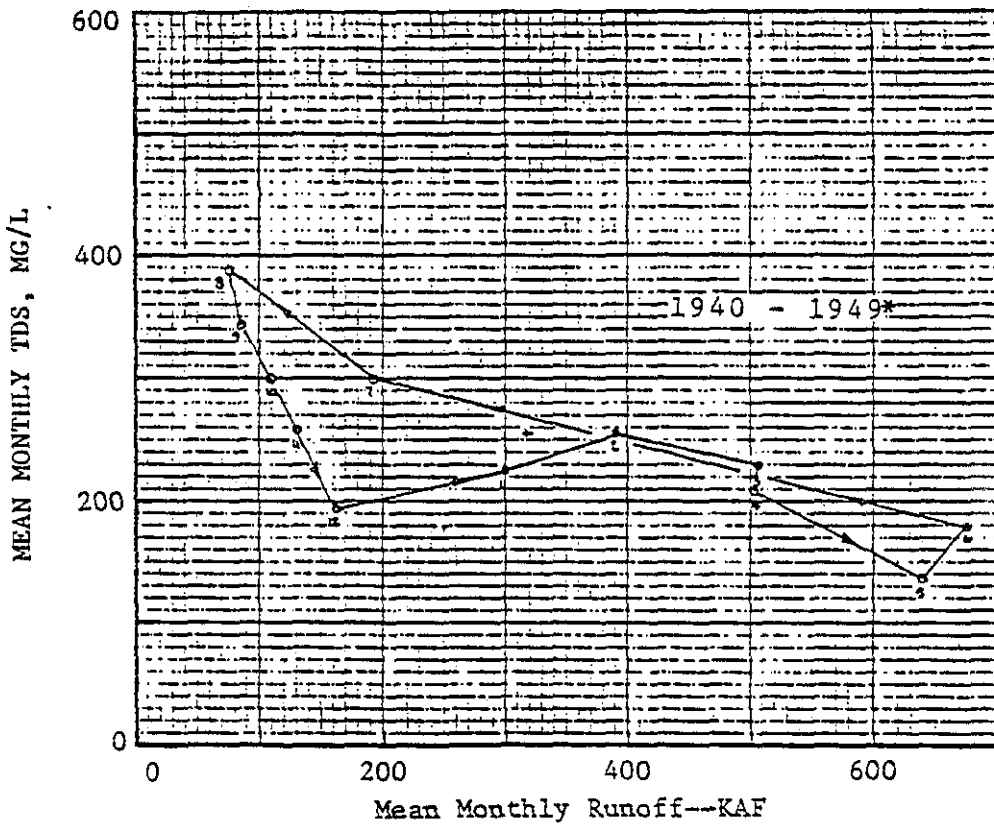

Figure VI-25 MEAN MONTHLY TDS AT VERNALIS BY DECADES
 1930-1969
 *Based on Mossdale chloride data
 **Based on actual observations



A



B

Figure VI-26 MEAN MONTHLY TDS (MG/L) VS. MEAN MONTHLY RUNOFF (KAF) FOR FOUR DECADES, 1930-1969

* Based on Mossdale data.

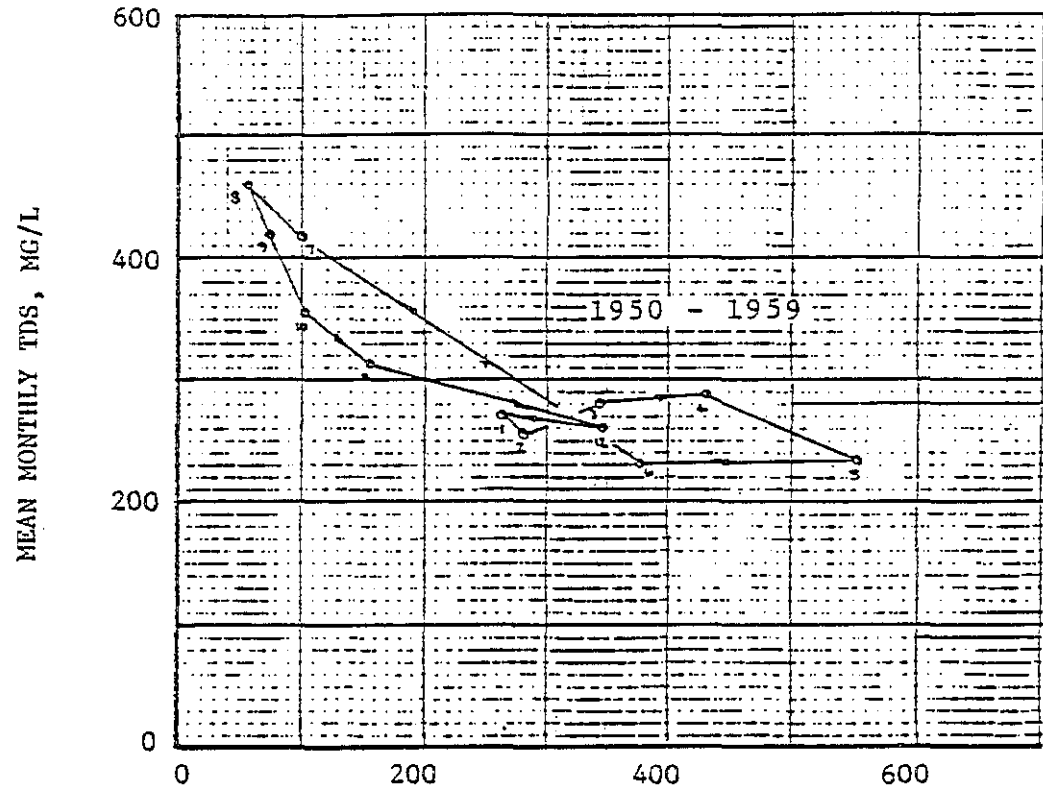

C

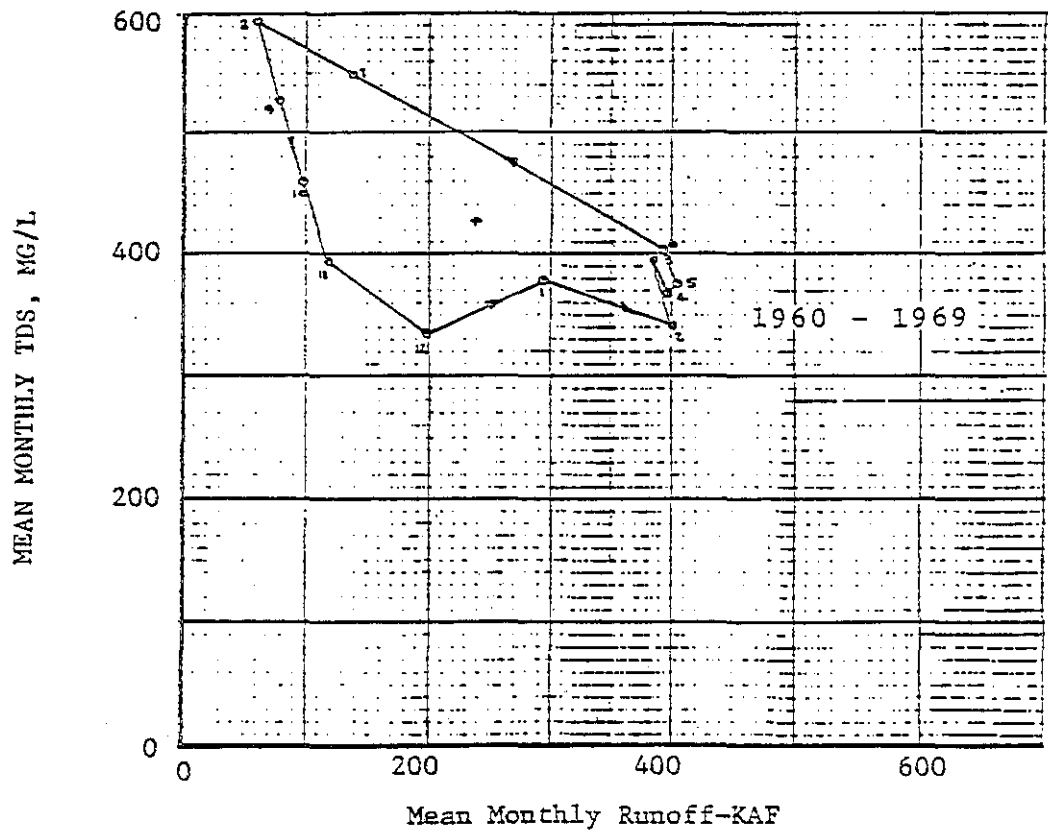

D

Figure VI-26 (Continued)

indicating substantial increases in salt load for the same levels of flow, and a generally decreased runoff, especially during the late winter and spring months (February through June). In all cases it is of interest to note:

1. The lowest runoff and poorest quality occurred in August.
2. The greatest runoff occurred in May or June (three times in May, one time in June).
3. A regular pattern of improving quality with increasing flow is identified with the period September through December.
4. Late spring and early summer months always show a tendency toward increased TDS as the flow decreases approaching the maximum in August.

Estimation Based on Chloride Load-Flow Relationships

To broaden the approach to prediction of pre-1953 water quality conditions at Vernalis on the San Joaquin River, an alternative method of analysis was developed. This method utilized chloride observations derived from monthly grab samplings at Vernalis for the period subsequent to 1938*. These data were combined with mean monthly flows to determine mean monthly chloride loads that, in turn, were correlated with Vernalis runoff to produce linear regressions of the power function form. Correlations were made for each month of record for the periods 1938 through 1949 and 1950 through 1969, respectively. Because these regression lines were fitted to a limited set of data (from six to ten data points in the 1938 to 1949 period) they were generally limited to the range of the data used, e.g., they were not considered reliable for very

* With the exception of some months during World War II when no samplings were made.

low flows, where they tended to give TDS predictions larger than had been observed historically. To correct for this limitation a new set of regression equations, the coefficients for which are summarized in table VI-7 for the Vernalis station, were prepared using an additional hypothetical chloride load-flow point corresponding to a TDS of 1,000 mg/L and a monthly flow of 0.5 KAF. Including this value in the data set had the effect of precluding TDS concentrations in excess of 1,000 mg/L*.

Although plots similar to figures VI-15 and VI-16 express quality in tons of chlorides, the chloride concentration in p/m is given by the following formula:

$$p/m = \frac{\text{Load}}{\text{Flow} \times 1.36}$$

where,

p/m = parts per million Cl⁻
 Load = chloride load in tons
 Flow = 1,000's of acre-feet

Table VI-18 tabulates the mean monthly TDS values for the years 1930-1953 based on the chloride load flow regressions.

The extreme water quality conditions at Vernalis for the years 1930-66 are presented in table VI-19. A comparison of the pre-project years with post-project years is presented in table VI-20. These tables indicate that extreme water quality conditions at Vernalis are poorer for the post-project years, in terms of higher TDS concentrations and lower daily flows.

Applying the regression curves to the pre-1950 and 1950-1952 years and using actual data for the post-1952 years, table VI-21 can be used to compare the mean monthly water quality at Vernalis for the four decades being studied.

* Approximately the maximum mean monthly TDS during the 1977 drought.

TABLE VI-18. MEAN MONTHLY TOTAL DISSOLVED SOLIDS AT VERNALIS, MG/LITER,
 BASED ON CHLORIDE LOAD-FLOW REGRESSIONS FOR PERIOD 1930-1949

Year	Oct	Nov	Dec	Jan	Feb	Mar	Apr	May	Jun	Jul	Aug	Sept
1930	338	309	310	241	267	245	168	159	204	378	421	376
1931	327	286	278	253	274	344	334	292	429	616	555	494
1932	417	359	314	199	140	196	138	95	111	238	403	396
1933	327	275	279	233	217	275	224	189	159	390	447	391
1934	333	291	261	211	241	277	270	253	364	523	501	456
1935	372	306	292	194	205	208	99	87	110	305	415	380
1936	312	273	256	200	135	141	103	86	123	293	405	383
1937	318	273	249	200	135	145	100	82	110	286	405	378
1938	318	272	211	166	112	111	89	76	86	179	333	349
1939	293	229	232	187	194	262	171	164	309	434	441	399
1940	335	296	293	187	150	140	97	90	124	335	402	366
1941	330	282	245	159	133	127	95	81	99	206	362	366
1942	306	260	217	152	134	164	102	87	99	217	376	358
1943	305	260	222	170	133	124	94	89	121	326	383	366
1944	310	273	262	213	218	197	176	132	188	378	407	388
1945	329	256	231	191	141	161	114	90	122	270	373	355
1946	290	234	207	147	171	214	128	92	154	362	399	374
1947	321	252	234	211	235	253	204	164	315	481	461	396
1948	343	280	287	262	342	384	209	122	134	372	441	395
1949	332	294	298	244	286	219	182	136	231	472	456	426
1950	420	351	351	288	269	343	192	174	169	506	566	514
1951	415	211	166	144	180	219	258	156	203	468	538	505
1952	390	342	293	153	174	181	117	92	93	298	464	458
1953	386	323	280	179	265	414	329	216	171	385	538	498

TABLE VI-18. MEAN MONTHLY TOTAL DISSOLVED SOLIDS AT VERNALIS, MG/LITER,
 BASED ON CHLORIDE LOAD-FLOW REGRESSIONS FOR PERIOD 1930-1949

Year	Oct	Nov	Dec	Jan	Feb	Mar	Apr	May	Jun	Jul	Aug	Sept
1930	338	309	310	241	267	245	168	159	204	378	421	376
1931	327	286	278	253	274	344	334	292	429	616	555	494
1932	417	359	314	199	140	196	138	95	111	238	403	396
1933	327	275	279	233	217	275	224	189	159	390	447	391
1934	333	291	261	211	241	277	270	253	364	523	501	456
1935	372	306	292	194	205	208	99	87	110	305	415	380
1936	312	273	256	200	135	141	103	86	123	293	405	383
1937	318	273	249	200	135	145	100	82	110	286	405	378
1938	318	272	211	166	112	111	89	76	86	179	333	349
1939	293	229	232	187	194	262	171	164	309	434	441	399
1940	335	296	293	187	150	140	97	90	124	335	402	366
1941	330	282	245	159	133	127	95	81	99	206	362	366
1942	306	260	217	152	134	164	102	87	99	217	376	358
1943	305	260	222	170	133	124	94	89	121	326	383	366
1944	310	273	262	213	218	197	176	132	188	378	407	388
1945	329	256	231	191	141	161	114	90	122	270	373	355
1946	290	234	207	147	171	214	128	92	154	362	399	374
1947	321	252	234	211	235	253	204	164	315	481	461	396
1948	343	280	287	262	342	384	209	122	134	372	441	395
1949	332	294	298	244	286	219	182	136	231	472	456	426
1950	420	351	351	288	269	343	192	174	169	506	566	514
1951	415	211	166	144	180	219	258	156	203	468	538	505
1952	390	342	293	153	174	181	117	92	93	298	464	458
1953	386	323	280	179	265	414	329	216	171	385	538	498

TABLE VI-19. EXTREME VALUES OF TDS AND FLOW
AT VERNALIS 1930-1966

<u>Year</u>	<u>Maximum</u>	<u>Minimum</u>	
	<u>monthly mean TDS*</u> mg/L	<u>monthly mean flow</u> KAF	<u>ft³/s</u>
1930	421	56.6	921
1931	616	14.0	228
1932	403	71.3	1160
1933	447	41.0	667
1934	523	23.6	384
1935	415	61.2	995
1936	405	69.0	1122
1937	405	69.4	1129
1938	349	132.4	2225
1939	441	44.0	716
1940	402	72.9	1186
1941	366	100.3	1686
1942	376	103.6	1685
1943	383	94.8	1542
1944	407	67.1	1091
1945	373	109.4	1779
1946	399	75.3	1225
1947	481	32.4	527
1948	441	44.6	725
1949	472	34.6	563
1950	566	38.2	621
1951	538	46.7	760
1952	464	83.3	1355
1953	538	46.0	748
1954	540	33.6	547
1955	476	36.3	611
1956	318	112.2	1887
1957	479	46.3	754
1958	417	94.4	1537
1959	634	19.2	313
1960	710	13.7	223
1961	941	9.3	151
1962	565	42.7	695
1963	477	67.4	1098
1964	774	27.1	441
1965	494	75.0	804
1966	729	27.0	439

*Extreme values occurred within the period June-September. Flow values correspond to the month in which maximum TDS occurred. 1930-53 values based on load-flow regressions.

TABLE VI-18. MEAN MONTHLY TOTAL DISSOLVED SOLIDS AT VERNALIS, MG/LITER,
BASED ON CHLORIDE LOAD-FLOW REGRESSIONS FOR PERIOD 1930-1949

Year	Oct	Nov	Dec	Jan	Feb	Mar	Apr	May	Jun	Jul	Aug	Sept
1930	338	309	310	241	267	245	168	159	204	378	421	376
1931	327	286	278	253	274	344	334	292	429	616	555	494
1932	417	359	314	199	140	196	138	95	111	238	403	396
1933	327	275	279	233	217	275	224	189	159	390	447	391
1934	333	291	261	211	241	277	270	253	364	523	501	456
1935	372	306	292	194	205	208	99	87	110	305	415	380
1936	312	273	256	200	135	141	103	86	123	293	405	383
1937	318	273	249	200	135	145	100	82	110	286	405	378
1938	318	272	211	166	112	111	89	76	86	179	333	349
1939	293	229	232	187	194	262	171	164	309	434	441	399
1940	335	296	293	187	150	140	97	90	124	335	402	366
1941	330	282	245	159	133	127	95	81	99	206	362	366
1942	306	260	217	152	134	164	102	87	99	217	376	358
1943	305	260	222	170	133	124	94	89	121	326	383	366
1944	310	273	262	213	218	197	176	132	188	378	407	388
1945	329	256	231	191	141	161	114	90	122	270	373	355
1946	290	234	207	147	171	214	128	92	154	362	399	374
1947	321	252	234	211	235	253	204	164	315	481	461	396
1948	343	280	287	262	342	384	209	122	134	372	441	395
1949	332	294	298	244	286	219	182	136	231	472	456	426
1950	420	351	351	288	269	343	192	174	169	506	566	514
1951	415	211	166	144	180	219	258	156	203	468	538	505
1952	390	342	293	153	174	181	117	92	93	298	464	458
1953	386	323	280	179	265	414	329	216	171	385	538	498

TABLE VI-19. EXTREME VALUES OF TDS AND FLOW
AT VERNALIS 1930-1966

Year	Maximum	Minimum	
	monthly mean TDS*	monthly mean flow	
	mg/L	KAF	ft ³ /s
1930	421	56.6	921
1931	616	14.0	228
1932	403	71.3	1160
1933	447	41.0	667
1934	523	23.6	384
1935	415	61.2	995
1936	405	69.0	1122
1937	405	69.4	1129
1938	349	132.4	2225
1939	441	44.0	716
1940	402	72.9	1186
1941	366	100.3	1686
1942	376	103.6	1685
1943	383	94.8	1542
1944	407	67.1	1091
1945	373	109.4	1779
1946	399	75.3	1225
1947	481	32.4	527
1948	441	44.6	725
1949	472	34.6	563
1950	566	38.2	621
1951	538	46.7	760
1952	464	83.3	1355
1953	538	46.0	748
1954	540	33.6	547
1955	476	36.3	611
1956	318	112.2	1887
1957	479	46.3	754
1958	417	94.4	1537
1959	634	19.2	313
1960	710	13.7	223
1961	941	9.3	151
1962	565	42.7	695
1963	477	67.4	1098
1964	774	27.1	441
1965	494	75.0	804
1966	729	27.0	439

*Extreme values occurred within the period June-September. Flow values correspond to the month in which maximum TDS occurred. 1930-53 values based on load-flow regressions.

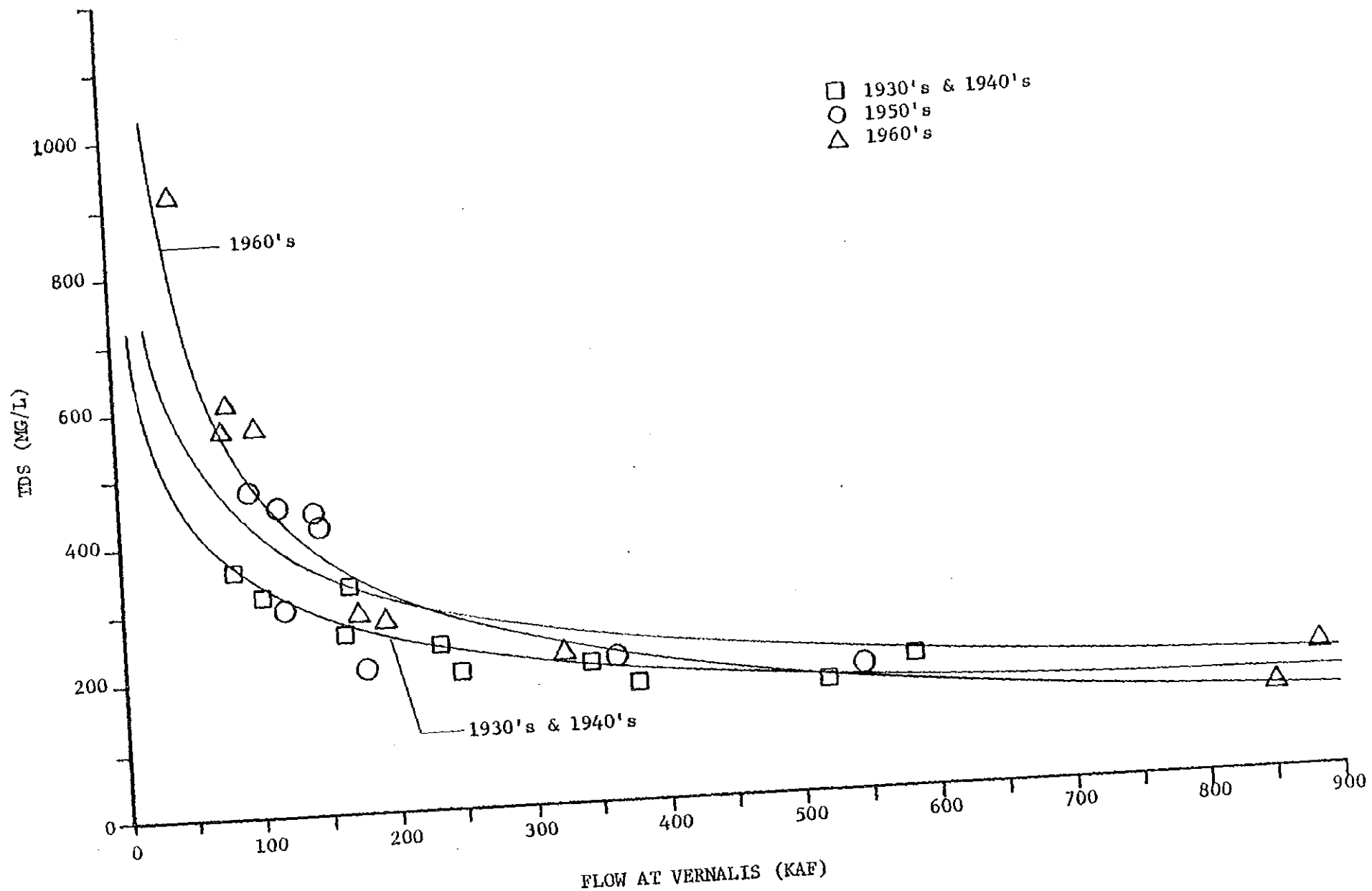
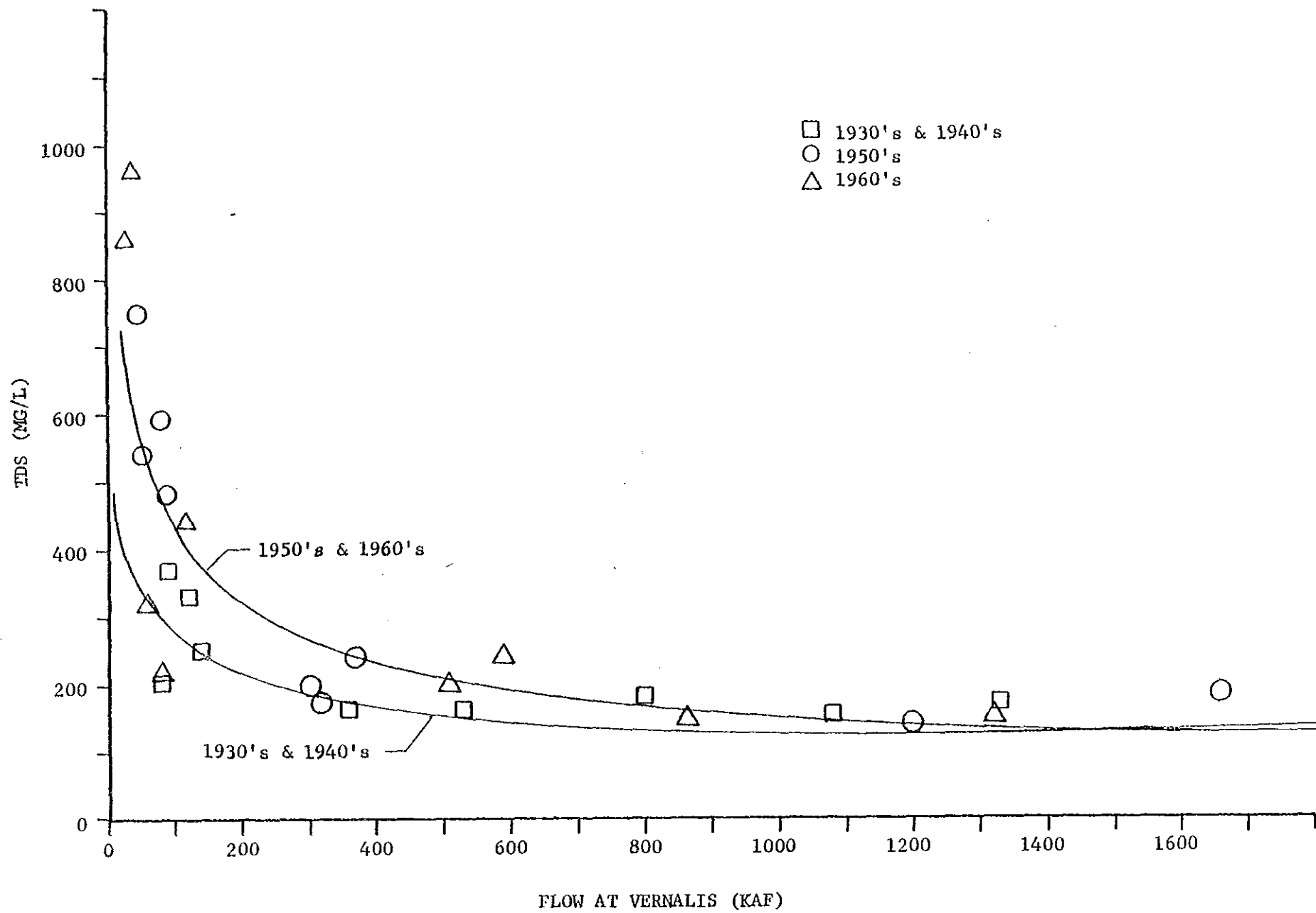
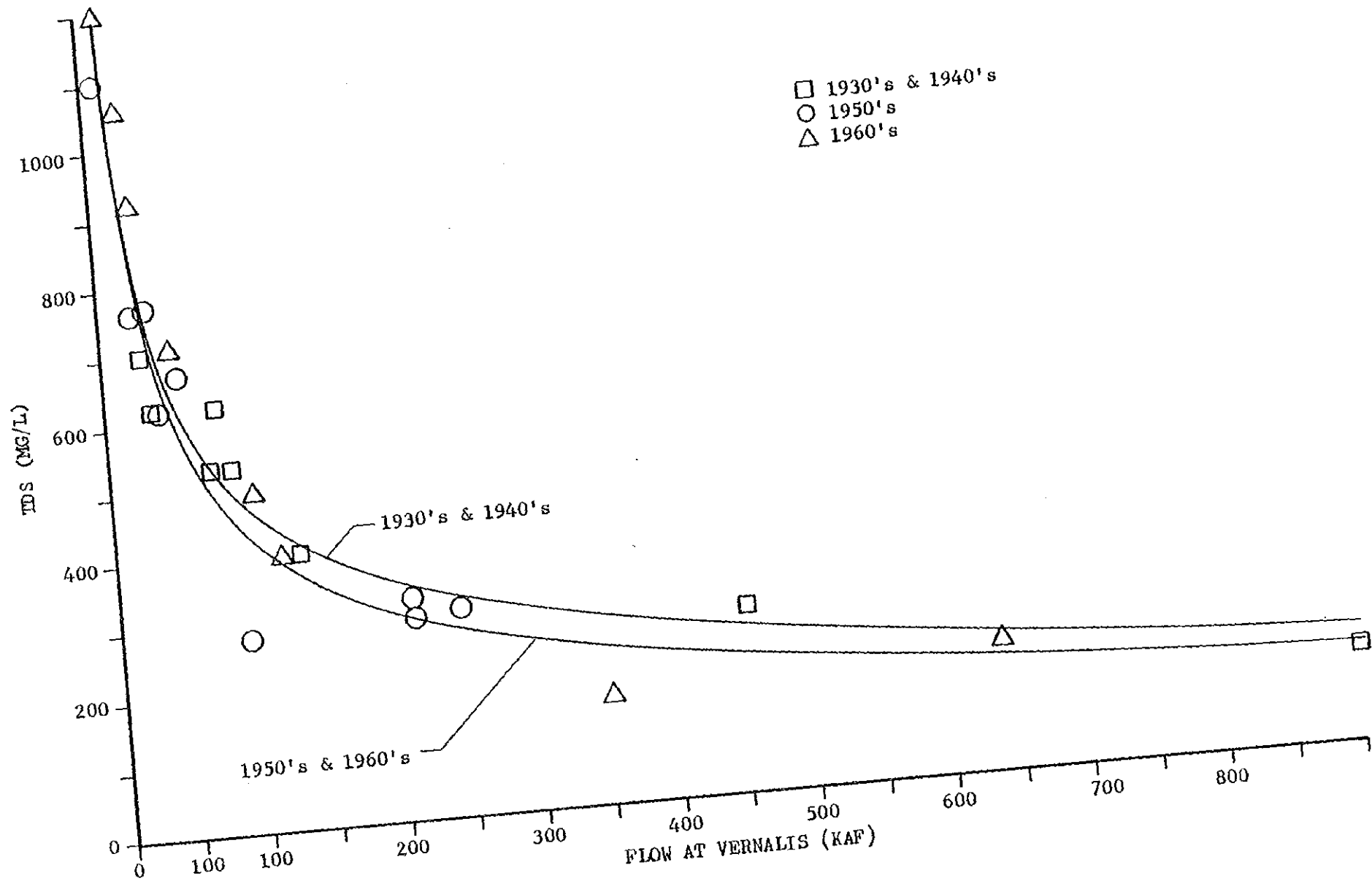

Figure VI-12 QUALITY-FLOW RELATIONSHIPS
SAN JOAQUIN RIVER AT VERNALIS - JANUARY





QUALITY-FLOW RELATIONSHIPS
 FLOW AT VERNALIS - JULY

TABLE VI-20. SUMMARY OF EXTREME WATER QUALITY CONDITION
APRIL - SEPTEMBER PERIOD

	1930-1944*	1952-1966
CRITICAL WATER QUALITY		
Monthly mean TDS mg/L		
Maximum for period	616	941
Mean for period	424	558
Minimum for period	349	318
LOW FLOW CONDITIONS		
Average daily flow ft ³ /s corresponding to critical TDS		
Maximum	228	151
Mean	1107	774
Minimum	2225	1887

* Based on load-flow regression curves.

TABLE VI-21. MEAN MONTHLY RUNOFF AND TDS AT VERNALIS
BY DECADES 1930-1969

Month	1930's***		1940's***		1950's		1960's	
	R KAF	TDS mg/L	R KAF	TDS mg/L	R KAF	TDS mg/L	R KAF	TDS mg/L
Oct	99	336	115	320	102	355	98	460
Nov	107	287	129	269	154	314	117	393
Dec	152	268	200	250	344	261	197	334
Jan	197	208	291	194	262	271*	294	379
Feb	420	192	401	194	280	256*	401	340
Mar	488	220	564	209	342	280	385	396*
Apr	457	170	518	140	429	287	397	368*
May	613	148	667	108	451	223	404	375
Jun	620	201	590	159	376	231	393	401
Jul	204	364	185	342	101	418	139	549
Aug	66	433	75	406	56	461	58	595
Sept	70	400	85	379	72	420	76	528
Mean	291	269	318	248	247	315	238	427

* Only 9 observations in 10 year period

** Only 8 observations in 10 year period

*** Based on load-flow regression curves

NOTE: Although 10 runoff observations were recorded for each 10-year period, the values shown are averages for the same series for which TDS values are given.

monthly water quality at Vernalis for the four decades being studied. Figure VI-27 presents graphically the same data. It is apparent that during the 1950's and 1960's water quality at Vernalis has experienced some degradation. Particularly notable is the decade of the 1960's in which mean monthly water quality is poorer in all months to the extent of several hundred mg/L TDS in some months.

Data presented in table VI-21 illustrate the changes in runoff and corresponding TDS values that have occurred during each of the decades since the 1930's. The relationships between these quantities are shown graphically in figures VI-28A and B, for the 1930's and 1940's. The 1950's and 1960's data are the same as those used in the Mossdale discussion (see figures VI-26C & D). Individual data points are identified by a number corresponding to the month of the year. Coordinates for each point were determined as the average monthly TDS and average monthly runoff without regard for year type (i.e., dry, below normal, above normal, wet).

As an illustration of a pre-1950 cycle, figure VI-28A shows that the lowest runoff - highest TDS month is August. With succeeding months the TDS drops as the flow increases until May when the best quality is identified with a high average runoff. In June, runoff is about that of May; however, the TDS concentration begins to increase. July and August both show a reduction of runoff and an increase in TDS concentration with the greatest changes occurring in July. A similar pattern is exhibited in the 1940's with some slight changes in the March through June period. A description of the 1950's and 1960's is contained in the discussion of results based on the Mossdale chloride data. In each of the decades the following statements are valid for average conditions:

1. The lowest runoff and poorest quality occurred in August.
2. The greatest runoff occurred in May or June.

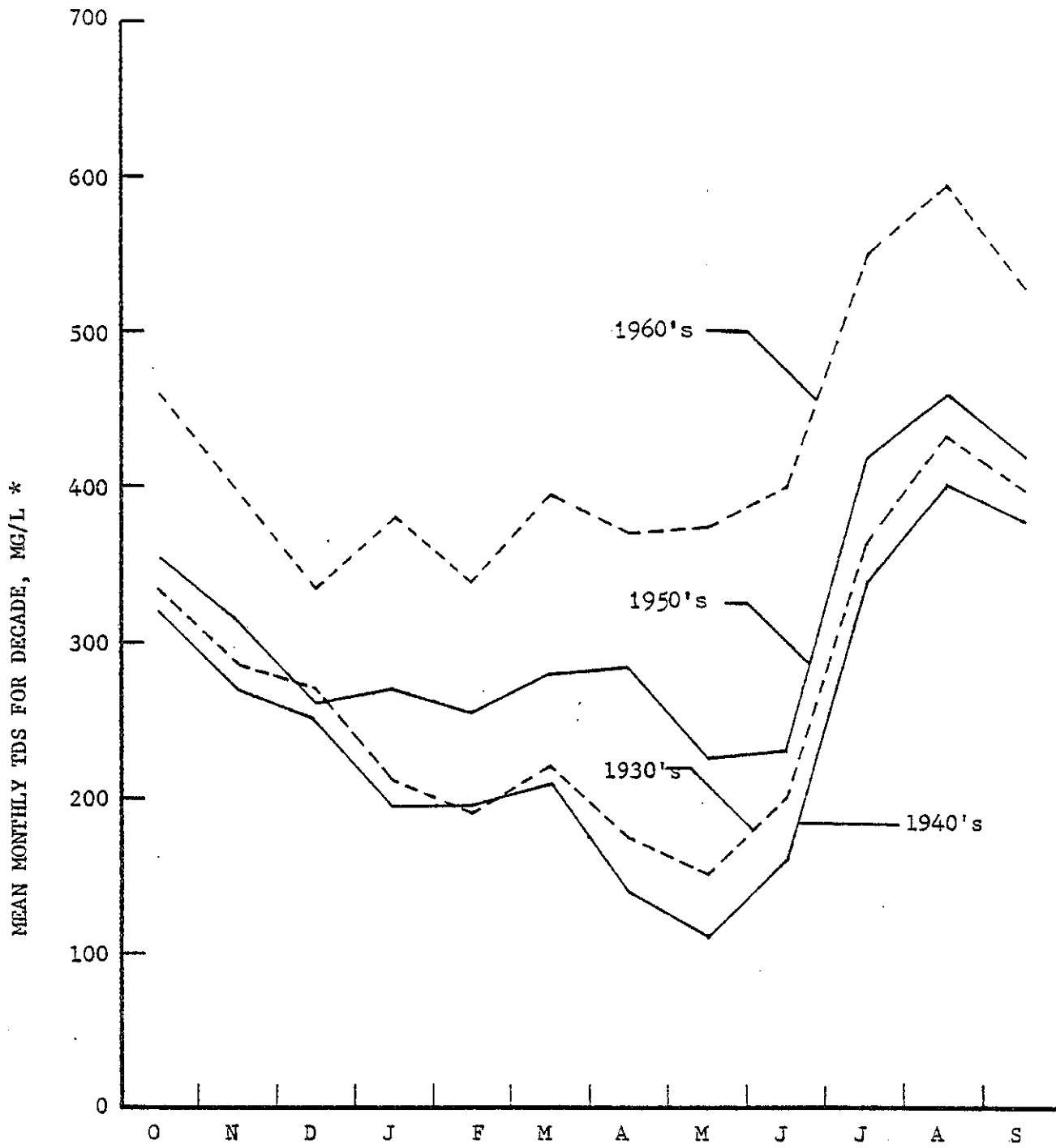
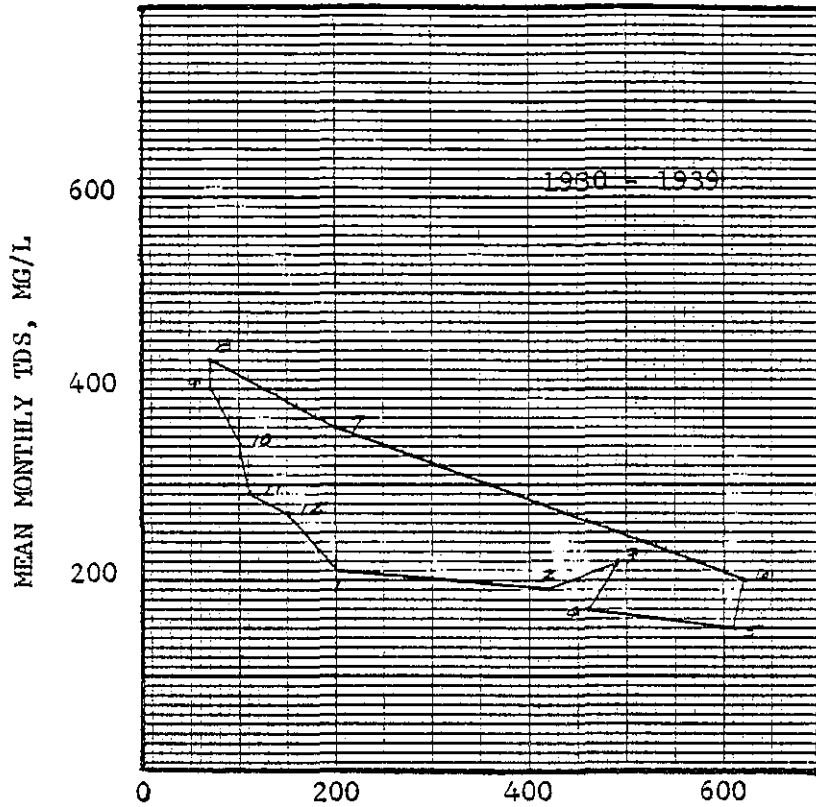
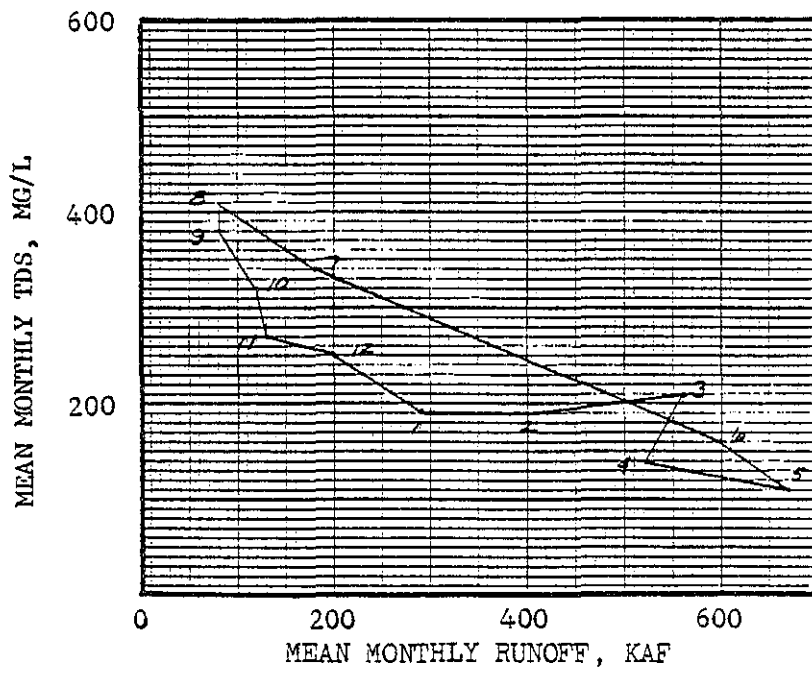

Figure VI-27 MEAN MONTHLY TDS AT VERNALIS BY DECADES 1930-1969

* Estimated by chloride load-flow regressions for 30's and 40's.



A



B

Figure VI-28 MEAN MONTHLY TDS (mg/L) VS. MEAN MONTHLY RUNOFF (KAF) FOR TWO DECADES, 1930-1949, BASED ON CHLORIDE LOAD-FLOW RELATIONSHIPS

3. A regular pattern of improving quality with increasing flow is identified with the period September through December.

4. Late spring and early summer months show a tendency toward increased TDS as the flow decreases approaching a maximum in August.

SECTION D. EFFECT OF TUOLUMNE GAS WELLS

Since the 1920's and until very recently, a group of about 10 exploratory gas wells, located along the Tuolumne River in the reach from Hickman to the mouth, have been contributing flows of very saline water to the river. The salt contribution of these wells, which has been estimated to range from 7,000 to 10,000 tons per month of TDS, is reflected in an overall increase in the salinity of the Tuolumne River, which depends upon the discharge from upstream sources not affected by the wells and to a lesser extent upon local returns of irrigation drainage water. In turn, because the Tuolumne contributes to the San Joaquin flow, there is an impact of these gas wells on the quality of water reaching Vernalis. It is not known whether there has been a significant change in the salt output of the wells over the period studied, i.e., from 1930 through 1966, but in 1977 concerted efforts were made to seal the wells and thus reduce the contribution of salts to the river. The effectiveness of these efforts has not yet been assessed.

The variation in salt concentration (represented by electrical conductivity, EC) in the Tuolumne River in relation to flow is summarized for three different locations in figure VI-29. The actual data shown are for the period 1960-1965, inclusive, and correspond to grab samples collected by the USGS at the several locations (approximately 1 sample per month). Curves of hyperbolic form are plotted to represent the data, indicating generally that as flows in the river increase (the gas wells flows are considered nearly constant over the

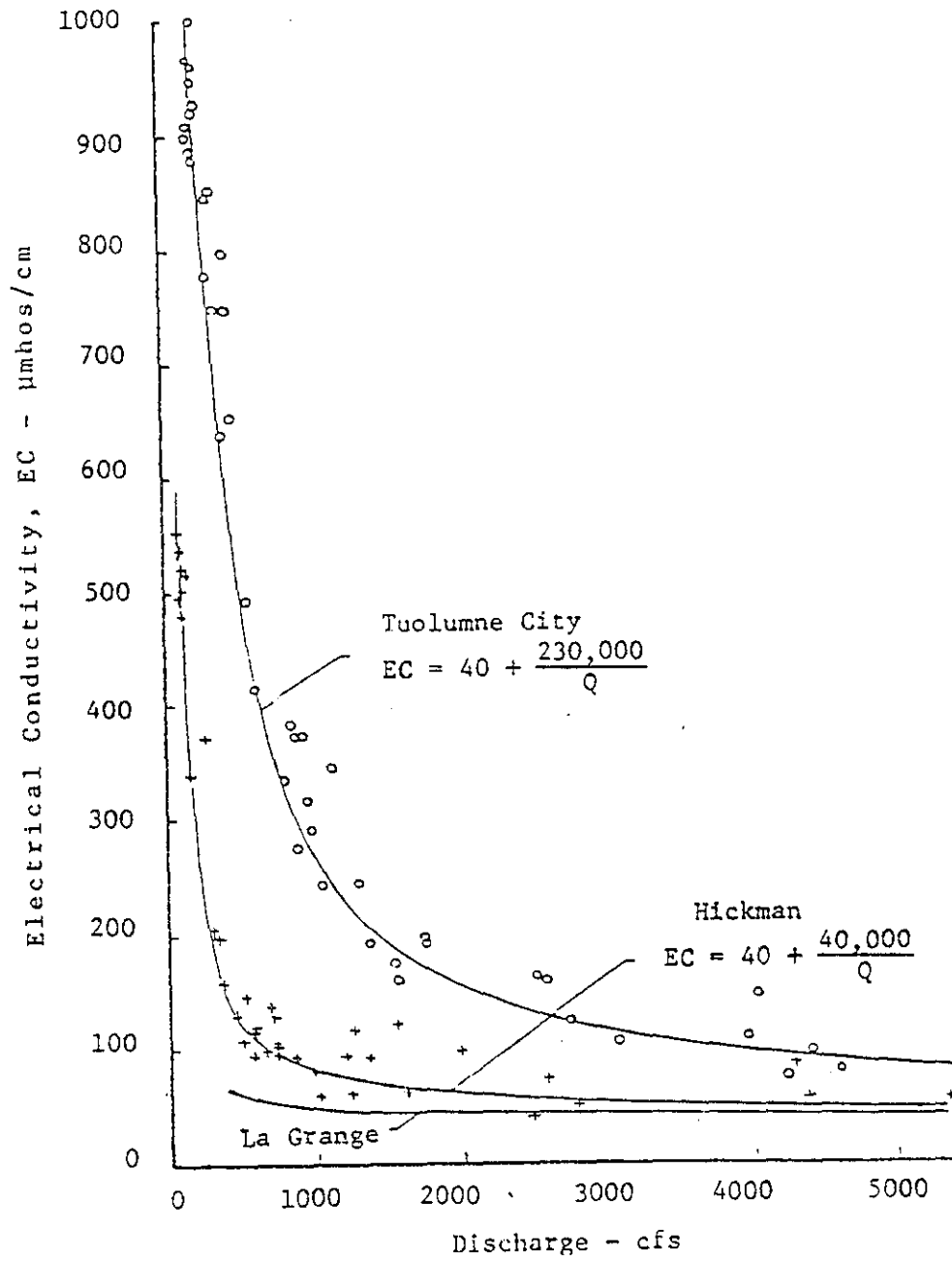

Figure VI- 29 QUALITY-FLOW RELATIONSHIPS
 TUOLUMNE RIVER

year) the quality improves, but at very low flows the quality may be dominated by the gas well salt load. Assuming a constant accretion of salt (tons per month), it is estimated that about one-sixth of the salt is contributed by two wells above Hickman and the remaining five-sixths by the several wells between Hickman and Tuolumne City, near the river's mouth. This analysis, which presumes a constant strength of the wells, indicates a total load as high as 10,800 tons TDS per month, although estimates by the Central Valley Regional Water Quality Control Board, based on direct sampling and analysis of the well water, indicate smaller loads--about 6,000 tons per month. Differences between these estimates may be attributed, in part, to the effects of drainage returns in the lower reach of the river. These are reflected, however, by the total salt load estimated at Tuolumne City (see figures VI-18 to 21).

Analysis of chloride data for the period 1938 through 1969, for four seasonal periods (November-January, February-April, May-July, and August-October) indicate similar relationships between chloride concentration and flow in the Tuolumne to those depicted in figure VI-29 for EC versus flow. Results of this analysis, which characterizes Cl^- versus flow in the form of

$$Cl^- = C_1 (\text{Flow})^{C_2} \quad (\text{VI-6})$$

where

Cl^- = monthly average concentration of chlorides, mg/L

Flow = average monthly runoff, cfs

C_1, C_2 = constants

are summarized in table VI-22.

The coefficients given correspond to the statistical "best fit" lines of the relationship presumed in equation VI-6. The coefficient of correlation, R, indicates the reliability of the equation in predicting the values actually observed, $R = 1.0$, corresponding to a perfect fit.

year) the quality improves, but at very low flows the quality may be dominated by the gas well salt load. Assuming a constant accretion of salt (tons per month), it is estimated that about one-sixth of the salt is contributed by two wells above Hickman and the remaining five-sixths by the several wells between Hickman and Tuolumne City, near the river's mouth. This analysis, which presumes a constant strength of the wells, indicates a total load as high as 10,800 tons TDS per month, although estimates by the Central Valley Regional Water Quality Control Board, based on direct sampling and analysis of the well water, indicate smaller loads--about 6,000 tons per month. Differences between these estimates may be attributed, in part, to the effects of drainage returns in the lower reach of the river. These are reflected, however, by the total salt load estimated at Tuolumne City (see figures VI-18 to 21).

Analysis of chloride data for the period 1938 through 1969, for four seasonal periods (November-January, February-April, May-July, and August-October) indicate similar relationships between chloride concentration and flow in the Tuolumne to those depicted in figure VI-29 for EC versus flow. Results of this analysis, which characterizes Cl versus flow in the form of

$$\text{Cl}^- = C_1 (\text{Flow})^{C_2} \quad (\text{VI-6})$$

where

Cl^- = monthly average concentration of chlorides, mg/L

Flow = average monthly runoff, cfs

C_1, C_2 = constants

are summarized in table VI-22.

The coefficients given correspond to the statistical "best fit" lines of the relationship presumed in equation VI-6. The coefficient of correlation, R, indicates the reliability of the equation in predicting the values actually observed, R = 1.0, corresponding to a perfect fit.

A summary of predicted values of chlorides for various levels of flow, corresponding to each of the seasonal and chronological periods, studied, is presented in table VI-23. Estimates are also shown for electrical conductivity (EC) based on the relationship

$$EC = 8.82 (Cl^-)^{0.88} \quad (VI-7)$$

where

EC = electrical conductivity, umhos/cm @ 25 °C

Cl = chlorides, mg/L

which was derived from USGS data for the period 1960-65. For purposes of graphical comparison, the resulting EC versus flow relationships are shown in figure VI-30, together with the 1960-1965 data for Tuolumne City, shown also in figure VI-29.

SECTION E. IMPACT OF UPSTREAM DEVELOPMENT ON QUALITY DEGRADATION OF THE SAN JOAQUIN RIVER SYSTEM

The preceding sections of this chapter have dealt with the changes that have occurred historically in the San Joaquin River system, dating from about 1930 and extending through the 1960's. Data has been presented to indicate the changes in quality that have been experienced at the lower extremity of the system, near Vernalis and at Mossdale 16 miles downstream and within the South Delta Water Agency. Data on the composition and quantity of salt accretion to the river system from various sources from Mendota downstream to Vernalis have been described. Finally, two methods of estimating the missing quality data for the early years of the study have been developed. For the benefit of the reader who may have elected not to read sections A, B, C, and D, a summary of each section is included here.

Table VI-23. PREDICTED CHLORIDE CONCENTRATIONS IN THE TUOLUMNE RIVER
AT TUOLUMNE CITY, AUGUST THROUGH OCTOBER, FOR SEVERAL
CHRONOLOGICAL PERIODS

Flow cfs	CHRONOLOGICAL PERIOD					
	1938-49		1950-59		1960-69	
	Cl*	EC**	Cl	EC	Cl	EC
250	164	784	189	889	194	909
500	87	449	114	570	109	548
1000	46	258	68	361	61	329
2000	25	148	41	232	34	196
3000	17	107	30	176	25	147
5000	11	73	21	129	16	101

* From regression equation, Aug-Oct, Table VI-22, mg/L

** By correlation Cl vs EC, equation VI-7, $\mu\text{mhos/cm}$ @ 25°C

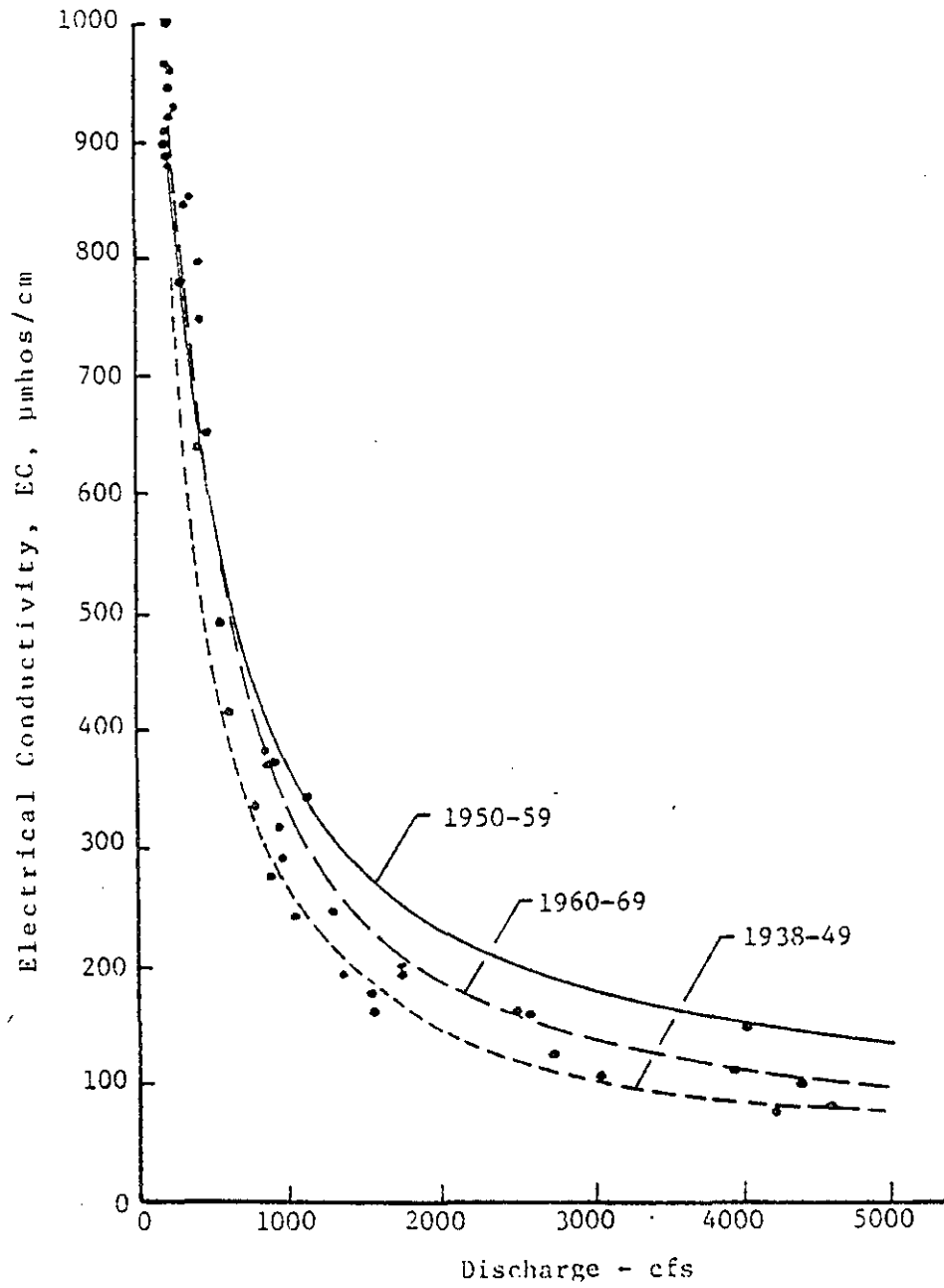

Figure VI-30 QUALITY-FLOW RELATIONSHIPS
TUOLUMNE RIVER, 1938-1969 (August-October)

Data shown are for period 1960-65, regression lines are described in Table VI-22

Data for Section A were developed to facilitate identification of the locations and the relative strengths of major contributions to the salt burden carried by the San Joaquin River from the vicinity of the Mendota Pool to Vernalis. This study of quality constituents was used in an effort to "fingerprint" the waters of various sources. In general, the data on quality constituents show the following:

1. There are distinctive differences between the qualities of eastside streams and the quality of water carried by the San Joaquin River along its main stem.
2. In the 1960's there is comparatively little difference between the quality and chemical composition of salts in drainage returns from the westside of the valley and the quality of water carried in the San Joaquin River from Mendota to Vernalis. Westside drainage is high in TDS, chlorides, sodium, sulfate, noncarbonate hardness, and boron, all of these properties being identified with soils of the area.
3. The effect of the flow from eastside tributaries has been largely one of dilution of salt loads carried by the river.

The properties of the salts carried by the San Joaquin River during periods of low flow appear to be dominated by westside accretions during the 1960's to a degree that they are hardly indistinguishable. To determine the relative contribution of several sources, the salt balance computations of Section B were performed.

Section B data were examined to determine trends in TDS salt load and TDS concentration at Vernalis. A study of monthly TDS load v. monthly Vernalis

unimpaired rimflow was performed for the four months of October, January, April, and July. By grouping the data into subsets by decades, the results indicate that in general, the salt load has increased at Vernalis. Lines describing the "best fit" of the data oftentimes do not correlate very strongly but, the indication is that the salt loads have probably increased, while the magnitude of the load is not strongly dependent on unimpaired rimflow (see figures VI-7 through VI-10).

A second study contained in Section B compares the TDS concentrations at Vernalis for various actual flows. Again, the data was divided into subsets by decades and "best fit" curves derived (see figures VI-11 through VI-14). Only the four representative months were studied, but the data supports a trend of higher TDS concentrations in the 1950's and 1960's than occurred in the 1940's and 1930's. An exception to this general statement is the month of July although no ready explanation is available for this difference from the other three months. The purpose of these first two studies was not to gain a quantitative description, but merely a qualitative insight to the situation at Vernalis.

The third portion of Section B, the salt balance computations, is used to determine the relative contribution of the several sources by combining the effects of flow and concentration. For comparison purposes, the years were grouped into water year classifications e.g., dry, below normal, above normal, and wet. Post-1947 results were then compared to pre-1944 years of the same type, much the same as was done in the water balance computations of Chapter 5.

The salt load at Vernalis has changed between the pre-1944 and post-1947 periods, the amount varying with the year classification. It appears that

annual loads in the dry years increased 18 percent and below normal year annual loads increased 35 percent. Little or no annual load change is evident in above normal and wet years. In the dry and below normal years the biggest increase in load occurred in April when spring runoff is probably flushing the basin of some accumulated salts. Consistent with this observation, loads in July have decreased in dry and below normal years apparently due to a reduction in runoff. In general, it appears that in drier years, salts are accumulated in the basin during low flow summer and early fall months and then released during the high flow winter and spring months. Because a net increase in load has occurred, it seems likely that sources of salt are adding to the annual burden at Vernalis in dry and below normal years.

In order to evaluate the changes in TDS concentration that have occurred at Vernalis, a complete record of monthly values is necessary. Due to gaps in the Vernalis data two methods of estimating the missing values were developed in Section C. The first of these methods estimates Vernalis TDS based on a correlation with Mossdale chloride data. The second method estimates the Vernalis TDS based on actual flow at Vernalis. Results of the two methods vary slightly but generally compare favorably. For average conditions, the following statements are valid:

1. The lowest runoff and poorest quality occurred in August.
2. The greatest runoff occurred in May or June.
3. A regular pattern of improving quality with increasing flow is identified with the period September through December.
4. Late spring and early summer months show a tendency toward increased TDS as the flow decreases approaching a maximum in August.

The Tuolumne gas wells are a significant source of salt. The exploratory wells have been contributing highly saline flows since the 1920's estimated to be as much as 7,000 to 10,000 tons per month of TDS. The study contained in Section D indicates that no significant change has occurred in the contribution of the wells through the 1960's.

An attempt to seal the wells was instituted in 1977 but insufficient data are available to evaluate the effectiveness of the effort.

The remainder of Section E is a discussion of impacts on water quality at Vernalis utilizing the results of the preceding sections. Because the impacts are based on the 1930's and 1940's period, and two methods were used to estimate the data for those years, two sets of results will be discussed, one based on Mosssdale chloride data and one based on Vernalis chloride load-flow data.

The changes in quality that have occurred at Vernalis have been most notable during the drier years of record, especially during the spring and summer months of such years. Using the Mosssdale data, extreme values of monthly average TDS followed a more or less regular pattern in the period prior to about 1944, ranging roughly between 300 and 400 mg/L, only slightly affected by the magnitude of runoff during the month (refer to figure VI-24). Since the predictions from regression curves are based on runoff, the magnitude of estimated TDS at Vernalis is affected by the flow and the lower envelope shown in figure VI-24 is modified upward.

The analysis of Mosssdale data indicates that if there were any highly saline return flows during the 1930's-1940's period, they diminished in flow during dry periods in comparable degree to the reduction in flow of high

quality waters. Chloride load-flow regression data indicate that, in the 1930's and 1940's, the quality of Vernalis water deteriorated with a reduction in flow, more or less as it did in the 1950's and 1960's, however, not as dramatically. For the years prior to 1950, the average difference in maximum monthly TDS estimated by both methods is 17 percent. Load-flow regression TDS values are, in most years, higher than Mossdale values, ranging from -10 percent in 1939, a dry year, to +93 percent in 1931, a dry year.

In the period subsequent to 1951, in distinct contrast, data indicates that a change occurred that was manifested by occasional very high levels of TDS correlatable to a high degree with a diminished flow in the river. Concentrations rose to 700 mg/L and above in several instances and exceeded 900 mg/L in 1961. This phenomenon was most evident in the late summer months--in almost every instance July or August proved to be the critical month--but it can be seen in the data of more recent years to be associated with the late spring and early summer periods when upstream diversions were most likely to influence the runoff reaching Vernalis.

A comparison of the four decades--the 1930's through the 1960's (see table VI-17)--indicates that the quality at Vernalis deteriorated at an accelerating rate relative to the decline in runoff. While the period (1930-1949) produced approximately the same annual average unimpaired runoff as the 1950-1969 period, the quality-flow relationship shifted markedly after the end of the earlier period. The average monthly runoff at Vernalis, which was about 300,000 acre-feet in the 1930's and 1940's, dropped by about 19 percent--to 243,000 acre-feet in the 1950's and 1960's (an average difference of 684,000 acre-feet per year). Over the same time span the average monthly TDS (over the

entire year based on Mossdale chlorides for the 1930-1949 period) increased 53 percent--from about 243 mg/L to 371 mg/L. Comparing the 1950's and 1960's to the earlier two decades, the TDS increases are about 30 percent and 76 percent of the 1930-1949 average, respectively.

For a constant salt load it may be expected that a decrease in runoff at Vernalis would result in an increase in TDS. Comparing the average monthly TDS (over the entire year), load-flow regressions show a 1950-1969 increase of 43 percent--from 259 mg/L to 371 mg/L. For the 1950's alone, the percentage increase is about 22 percent and for the 1960's, 65 percent.

From these same data it is possible to estimate the proportionate degradation that occurred as a result of reduction of flow and as a result of added salt load in the system. Using the Mossdale data for the decades of the 1930's and 1940's as a base of reference (mean monthly runoff = 299.4 KAF and mean TDS = 242.5 mg/L), and assuming, first, no change in salt load, we find that due to runoff reduction alone in the 1950's we could expect an increase in TDS of about 40.5 mg/L. The difference in this increase and that which actually occurred, 72.5 mg/L, is 32.0 mg/L and must be attributed to an increase in salt burden carried by the river. Thus, according to this analysis, in this first decade after the CVP went into operation, about 56 percent of the increase in average TDS was caused simply by a reduction in flow from upstream sources; the remaining 44 percent was a result of increased salt burden, perhaps associated with an expansion of irrigated lands in the basin. Similarly, in the 1960's (compared to the 1930's and 1940's) about 27 percent of the average increase in TDS ($184.5 \times 0.27 = 50.0$) can be accounted for by a reduction in flow and 73 percent attributed to increased salt burden. It is of interest to note here

that the absolute change apparently caused by reduction in flow changed relatively little from the 1950's to the 1960's (from 41 to 50 mg/L) while that charged to an increase in salt burden increased about four times (from 33 to 134.5 mg/L). This is consistent with other analyses that indicate a progressive buildup in salt load in the San Joaquin system.*

Based on the load-flow regressions data for the 1930's and 1940's, the proportionate degradation that has occurred due to decreased flow and increased load is also calculated.*

1930' & 1940's average load = 747,740 tons**

1950's reduction due to flow = (50) (690) = 34,500 tons

1950's TDS increase due to flow = $\frac{747,740 - 34,500}{2,969} - 204 = 36 \text{ mg/L TDS}$

1950's TDS increase due to load = (277 - 36) - (204) = 37 mg/L TDS

1960's reduction due to flow = (50) x (700) = 35,000 tons

1960's TDS increase due to flow = $\frac{747,740 - 35,000}{2,959} - 204 = 37 \text{ mg/L TDS}$

1960's TDS increase due to load = (393 - 37) - (204) = 152 mg/L TDS

According to this analysis, in the 1950's a quality degradation of 36 mg/L TDS is due to a reduction in flow. The calculations show a slight degradation of 37 mg/L TDS due to load, or about 50 percent. The degradation due to load change is significantly greater in the 1960's, 152 mg/L TDS, while the degradation due to reduced flow, 37 mg/L TDS, is about the same as for the 1950's.

* It is assumed in this analysis that water lost from the system would have a TDS of about 50 mg/L.

** Obtained by summation of average monthly saltloads for the period 1930-1949.

The chronological shifts in TDS concentration and salt loads, calculated by the Mossdale method, are depicted graphically in figures VI-31 and VI-32, in which the changes that have occurred (see table VI-17) in the 1950's and 1960's are related to the average of the earlier period. The relative concentration is noted to be greater than unity throughout the year in both decades, the maximum occurring in late spring and early summer. The rate of increase over time, indicated by the spacing between the curves, is seen as increasing in all months from the 1950's through the 1960's, with the greatest rate differences occurring in May and June.

Changes in salt load, i.e., the product of runoff and concentration, are indicated in figure VI-32 to have changed relatively little between the 1950's and the 1930's-1940's period. However, the salt load at Vernalis for the 1960's increased substantially in all months of the year, by amounts 40 percent or greater than for the period of the 1930's and 1940's, despite the fact that flows in this period were substantially reduced by upstream development. The average for the 12-month period of the 1960's was about 152 percent of the 1930's-1940's level. For the 1950's, the average was about 110 percent.

Chronological shifts in TDS concentration and salt loads as determined by the load-flow regressions are presented in figures VI-33 and VI-34. Monthly changes that have occurred in the 1950's and 1960's (see table VI-21) are related to the average of the 1930's and 1940's. Relative concentrations are greater than unity for all months in the 1950's and 1960's. The greatest rate of increase over time for both the 1950's and 1960's is seen in April and May.

The changes in salt load, i.e., the product of runoff and concentration, are indicated in figure VI-34. The 1950's show some change in load over the

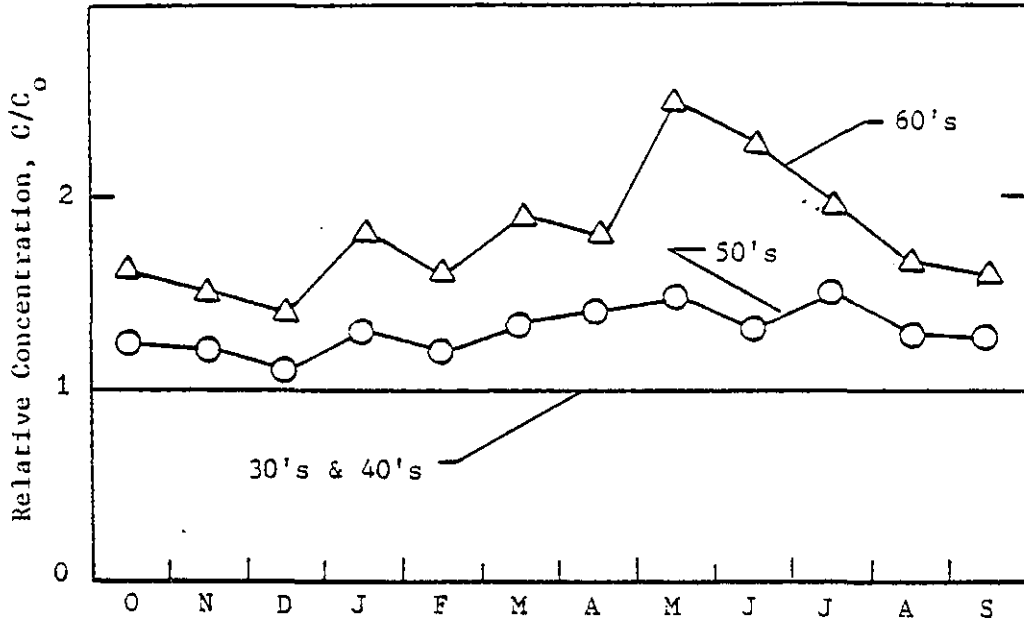

Figure VI-31 RELATIVE TDS CONCENTRATION AT VERNALIS BY DECADES, 1930-1969

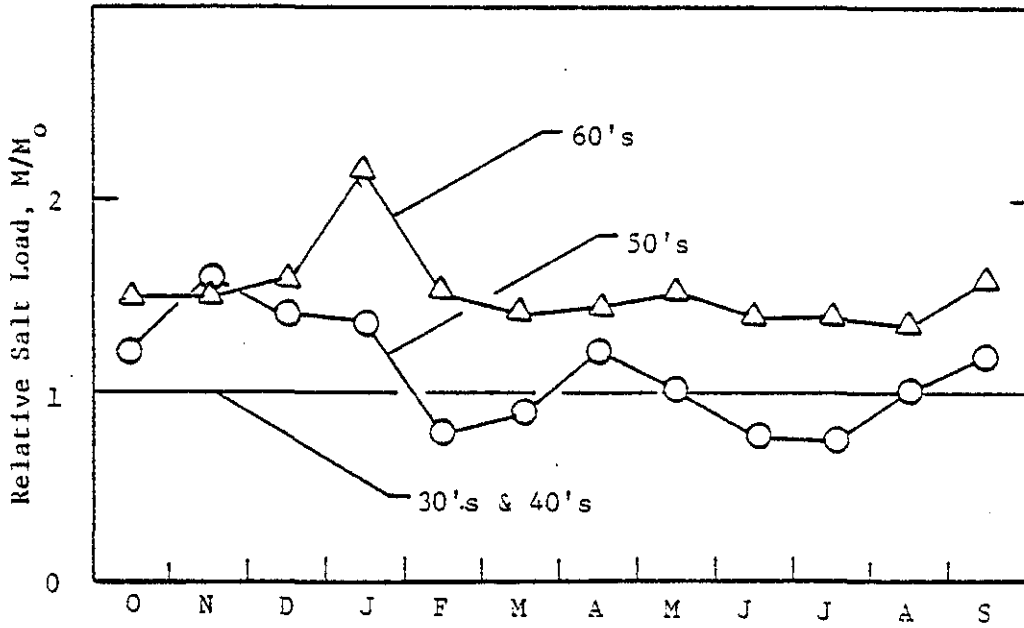

Figure VI-32 RELATIVE TDS SALT LOAD AT VERNALIS BY DECADES, 1930-1969

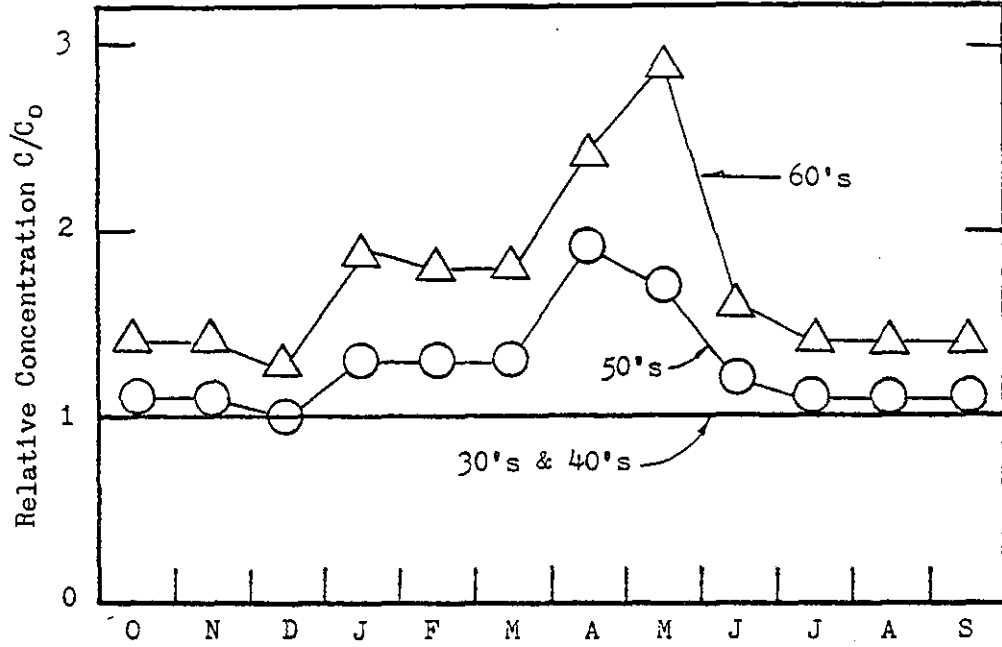

Figure VI-33 RELATIVE TDS CONCENTRATION AT VERNALIS BY DECADES, 1930-1969*

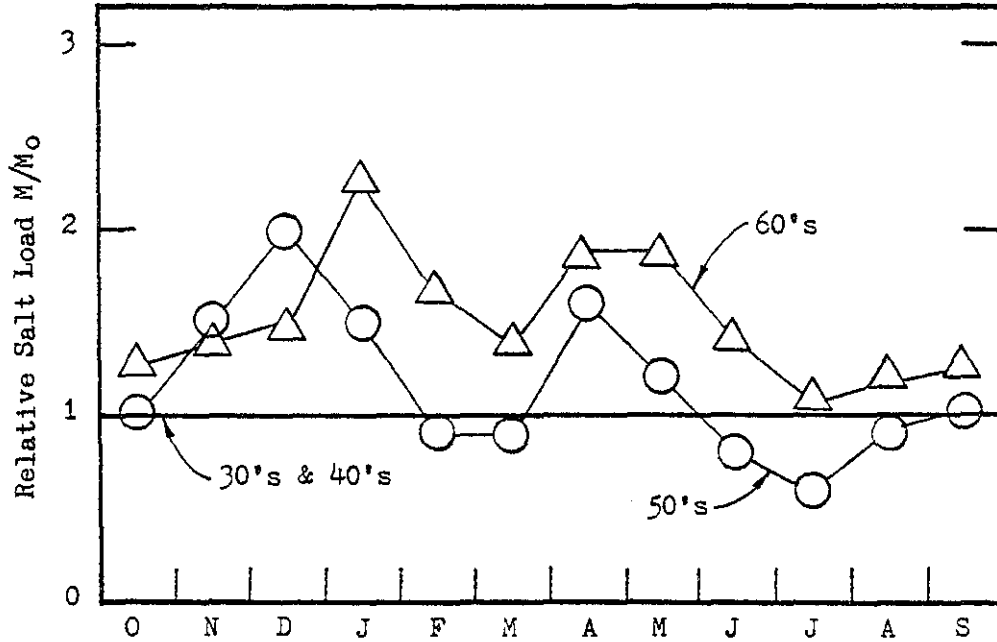

Figure VI-34 RELATIVE SALT LOAD AT VERNALIS BY DECADES, 1930-1969*

*Based on chloride load-flow relationships.

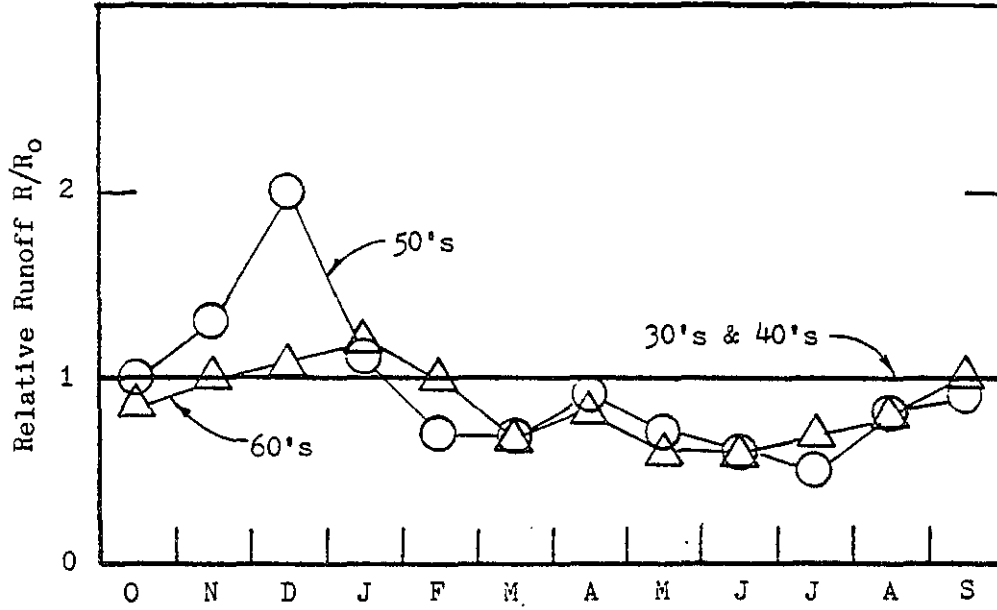

Figure VI-35 RELATIVE RUNOFF AT VERNALIS BY DECADES, 1930-1969

year, and a substantial chronological shift is evident. Loads are greater in the months of November, December, January, and April. The months of February, March, June, July, and August, show relative loads less than unity. For the 12-month period, loads in the 1950's were about 116 percent of the 1930's-1940's period. During the 1960's salt loads were much higher than those of the 1930's and 1940's. For the January through May period the monthly loads were as much as 240 percent of the 1930's and 1940's. Overall the salt loads for the 1960's were about 153 percent of the pre-1950 years. Figure VI-35 depicts the relative runoff at Vernalis in the same manner as figure VI-33 and VI-34. Both the 1950's and 1960's have relative runoffs generally less than unity. Exceptions are the months of November, December, and January; however, these increases are offset by reductions in the remaining months. The 1960's relative flow was about the same as the 1950's, while at the same time the relative load was greater than the 1950's. This supports the calculations indicating that an additional salt burden has been placed on the system.

Comparisons of quality changes by year classification is possible from the Mossdale data presented in tables VI-13, 14 and 15. These are summarized in tables VI-24 and VI-25, for the April through September period, and for the extremes of high TDS and corresponding flows experienced in each of the study years. Data are presented as averages for each of the several year classifications. It is noted that because of the scarcity of "Below Normal" years in the 1930-1944 period and "Above Normal" years in the 1952-1966 period averages are presented also for "Below and Above Normal" year classifications.

The summary of Mossdale results shown in table VI-24 for the April through September period shows clearly the impact of post-1952 upstream development of

TABLE VI-24. MEAN TDS AND RUNOFF AT VERNALIS BY YEAR CLASSIFICATION, APRIL-SEPTEMBER PERIOD,

Year Class	Mean TDS		Mean Period Runoff	
	MG/L		AF x 1000	
	Pre*	Post**	Pre	Post
Dry	314	677	424	168
Below Normal	282	419	788	735
Above Normal	190	325	3046	1201
Combined: Below & Above Normal	203	396	2764	851
Wet	180	209	5469	3845
All Years	227	434	2344	1268

* 1930-1944, data from Table VI-14, based on Mossdale chlorides.

** 1952-1966, data from Tables VI-13 and VI-14.

TABLE VI-25. EXTREME VALUES OF HIGH TDS AND LOW FLOWS
AT VERNALIS BY YEAR CLASSIFICATION

Year Class	Maximum Monthly Mean TDS		Minimum Monthly Mean Flow	
	MG/L		AF x 1000	
	Pre*	Post**	Pre	Post
Dry	351	765	38.6	17.3
Below Normal	370	530	67.1	44.0
Above Normal	355	521	81.4	55.0
Combined: Below & Above Normal	357	528	79.6	46.8
Wet	363	364	123.0	96.6
All Years	354.8	558.2	71.7	48.9

* 1930-1944, data from Table VI-15, based on Mossdale chlorides

** 1952-1966, data from Table VI-15

the San Joaquin Basin's water resources on both the quantity and quality of water reaching Vernalis. This effect is especially notable in the dry years, where a reduction of about 60 percent in the average April through September runoff corresponds to approximately 115 percent increase in average TDS--from 314 mg/L pre-1944 period to 677 mg/L post-1952 period. In the below and above normal years, the impact is similar, a reduction in average runoff of about 69 percent corresponds to an average increase in TDS of roughly 95 percent. In wet years, although flow reductions were substantial--about 30 percent of pre-1944 levels--the quality changes were minor, as would be expected. Considering all years, a reduction in runoff of 41 percent (959,000 acre-feet for the April-September period) corresponded to a 84 percent increase in TDS concentration in the runoff at Vernalis.

Comparisons of quality changes by year classification for the pre-1944 period and post-1952 period using load-flow regression data are presented in tables VI-26 and VI-27. Data summarized in those tables are found in tables VI-13, 18, and 19. The impact of upstream development is apparent in reduced flows and increased TDS concentration at Vernalis for all year types. Like results from the Mossdale method, the estimated April-September flow reductions are about 60 percent in the drier years and about 30 percent in the wet years. The loadflow regressions give an average TDS increase in dry years of 93 percent, in below and above normal years 69 percent, and in wet years 8 percent. Considering all years together, the degradation of quality amounted to an increase of 63 percent coupled with a 46 percent reduction in flow for the April-September period.

The same comparisons using the extreme TDS month is summarized in table VI-27.

TABLE VI-26. MEAN TDS AND RUNOFF AT VERNALIS BY YEAR CLASSIFICATION, APRIL-SEPTEMBER PERIOD

Year class	Mean TDS		Mean period runoff,	
	mg/L		KAF	
	Pre*	Post**	Pre	Post
Dry	350	677	424	168
Below normal	278	419	788	735
Above normal	228	325	3046	1201
Combined Below normal & above normal	234	396	2764	851
Wet	194	209	5469	3845
All years	267	434	2344	1394

* 1930-1944, data from table VI-18 based on flow-load regression data.

** 1952-1966, data from table VI-13 and VI-14.

TABLE VI-27. EXTREME VALUES OF HIGH TDS AND LOW FLOW
AT VERNALIS BY YEAR CLASSIFICATION

Year Class	Maximum monthly mean TDS mg/L		Minimum monthly mean flow AF x 1000	
	Pre*	Post**	Pre	Post
	Dry	490	765	35.8
Below normal	407	530	67.1	44.0
Above normal	398	521	77.5	55.0
Combined above & below normal	399	528	76.2	46.8
Wet	358	364	116.4	96.6
All years	424	561	68.1	48.9

* 1930-1944, data from table VI-19, based on load-flow regression data.

** 1952-1966, data from table VI-15.