

“Ohio’s Environmental Training Center”



Water Distribution Systems Workshop

— November 6, 2019 —

Columbus, OH

OTCO-B13306-OM 1.00 CTH's





Complete Utility Locating System using Tracer Wire Training

**Locating Theories, Procedures, Equipment
Tracer Wire Specification, Products & Procedures**

KEVIN WAUGH

MANUFACTURER REP COPPERHEAD INDUSTRIES LLC

The Theory of Locating

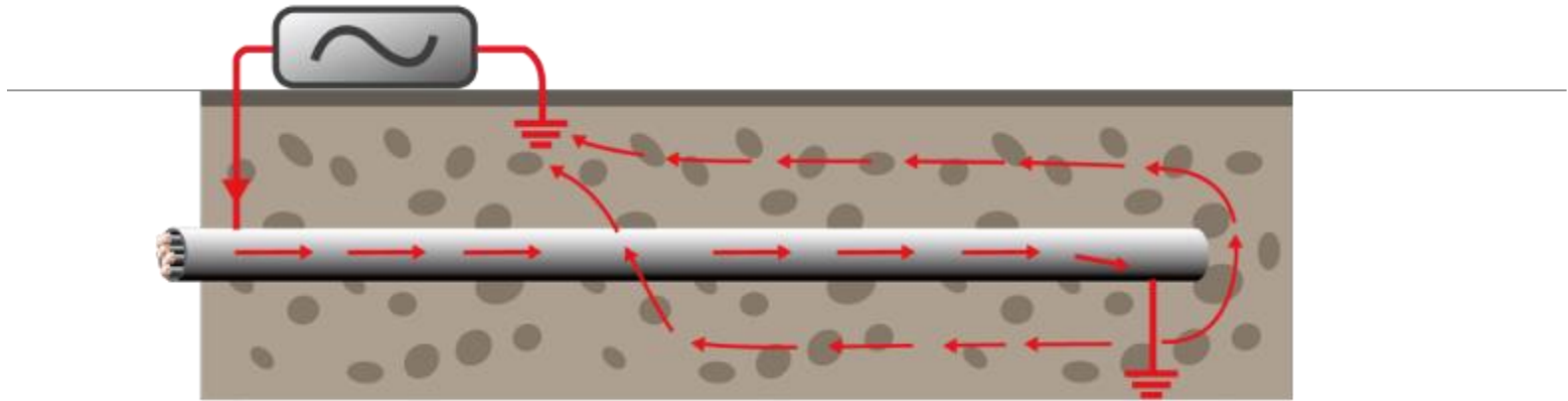

- Signals are created by the current flowing from the transmitter, along the conductor and back to the transmitter, ***but only when a ground, or complete circuit exists***
- The current typically uses the earth/moist soils to complete the circuit, from where the signal goes to ground back to the ground rod at the transmitter.

Locators do **NOT** locate buried cables or pipes
They **DETECT** electromagnetic **SIGNALS**
radiating from conductive cables or pipes

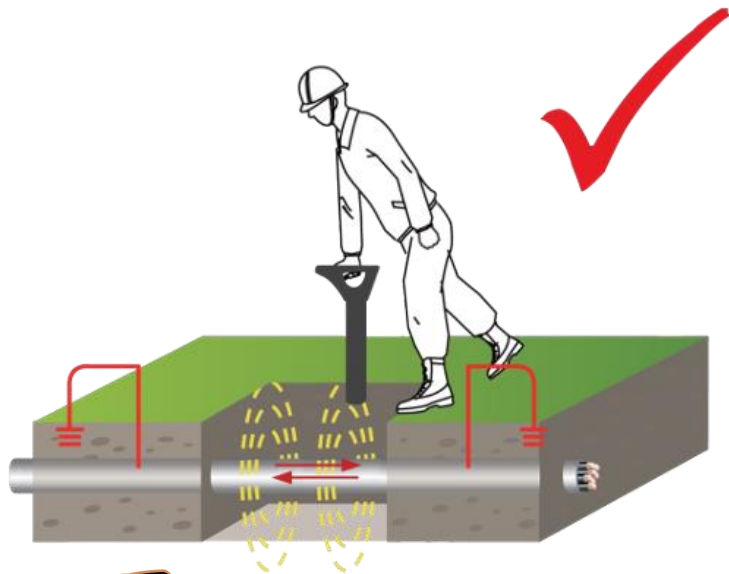

Locating Styles

- **Passive Locating** – Signal passively exists from a variety of sources and can be located using only the receiver

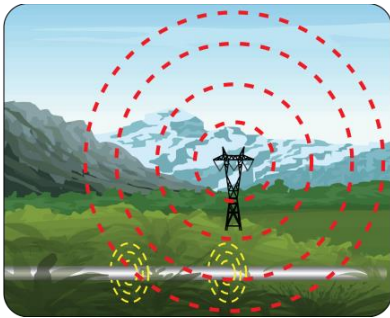

VS.

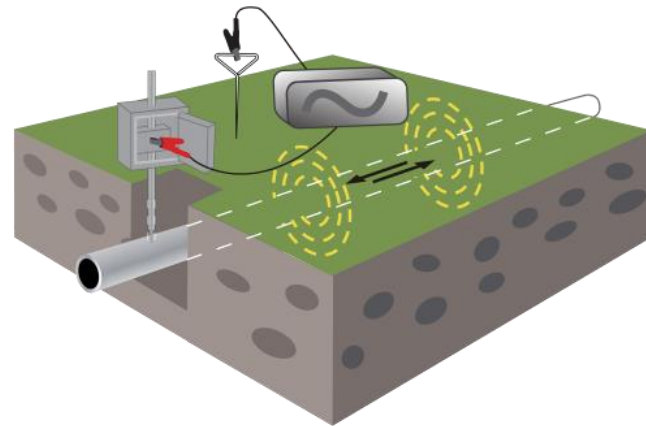

- **Active Locating** – Signal produced by transmitter and located using the receiver

3 Ways to Apply Active Locating Signal

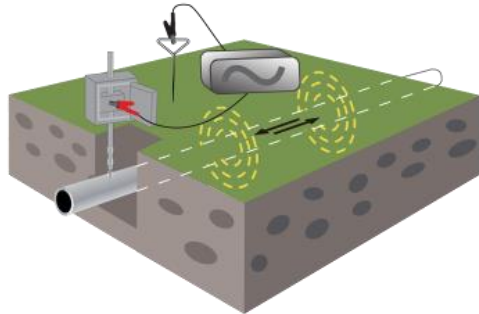

Direct connection – one cable to the target line, the other to ground.

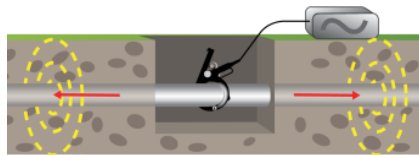

Clamp – induces a signal onto a cable, or pipe, without making a direct connection.

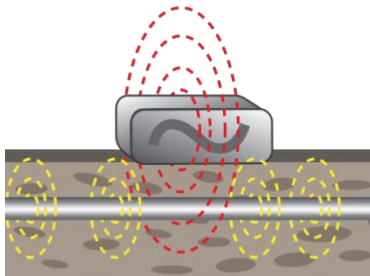

Induction – induces a signal onto a cable or pipe, by placing the transmitter on the surface over the target line.

Active Signal Frequency

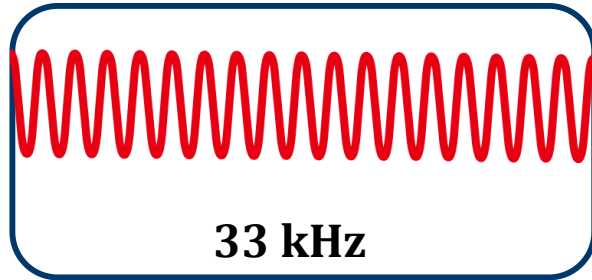

- High frequency (32.8 kHz)
 - Direct connection, clamp & induction
 - Shortest distance
 - Highest distortion and/or bleed-off

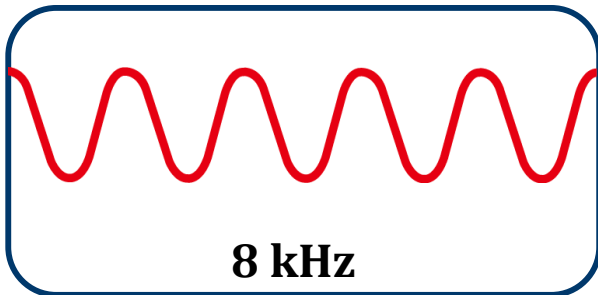

- Medium frequency (8.19 kHz)
 - Direct connection & clamp
 - Reasonable distance
 - Increased distortion and/or bleed-off

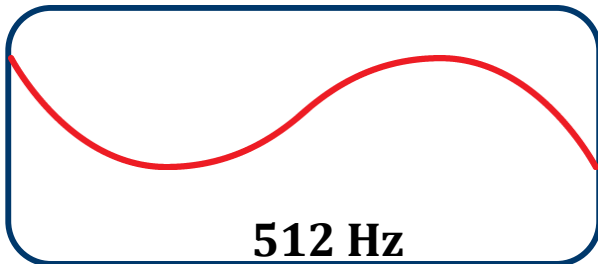

- Low frequency (512 Hz)
 - Direct connection
 - Longest distance
 - Lowest distortion and/or bleed-off



The Locating Signal

- Produced by the flow of the alternating current (AC) which creates an electromagnetic field that radiates from the line and is known as the signal.

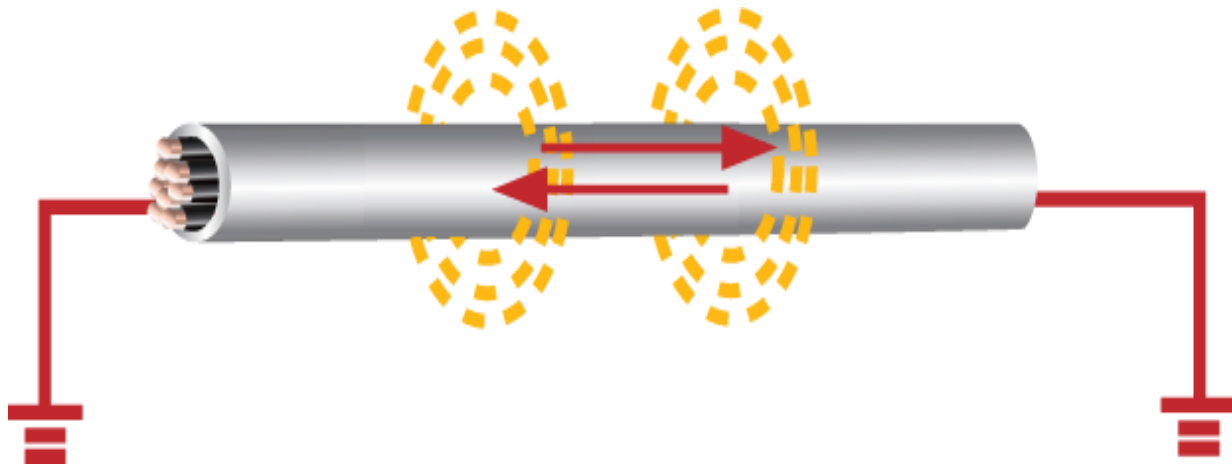

A Complete Tracer Wire System Should Include:

- ✓ **Locating Device**
- ✓ **Clear Tracer Wire Specifications**
- ✓ **AIS Certified CCS Tracer Wire**
- ✓ **Testing Stations**
- ✓ **Grounding Anodes**
- ✓ **Proper Locking Connectors**

**Copperhead's Complete Tracer Wire System
and its accessories deliver EVERY TIME!**



ViperMag Locator



A Complete Tracer Wire System Should Include:

- ✓ **Locating Device**
- ✓ **Clear Tracer Wire Specifications**

**Copperhead's Complete Tracer Wire System
and its accessories deliver EVERY TIME!**



How did the Tracer Wire Specification come to be?

- When designing a water or sewer system, how seriously is the design or specification of tracer wire taken?
Unfortunately, not nearly as much as the rest of the system.
- Most city/utility specifications call out the fire hydrant specifications down to the thread count on the nozzles, water pressure & color, but tracer wire has been taken far too lightly with very broad specifications.

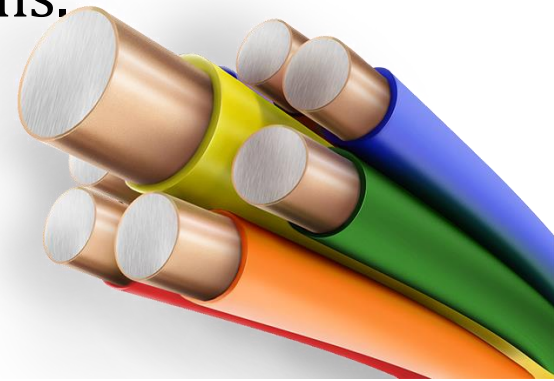

Typical Tracer Wire Spec

4. Provide tracer wire for underground PVC piping as specified herein, unless otherwise noted.
 - a. No. 12 solid strand insulated tracer wire shall be used and shall be blue in color.
 - a. Installation shall be as shown in the details and as specified below.

Metallic tracer, constructed of USE 12 gauge metallic wire with blue colored insulation, shall be taped to PVC water main before placement. The tracer shall be connected to all valve boxes, hydrants and wrapped around all appurtenances.



Evolution of the specification process

Specifications **should** cover the:

“Complete Tracer Wire System”:

- Wire type
 - Open Cut, Directional Drilling or Pipe Bursting
- Proper connections, Splice or Service
- Access points or Test stations
- Grounding of all dead ends
- Procedures for Installation & Testing
 - [Copperhead Specification](#)

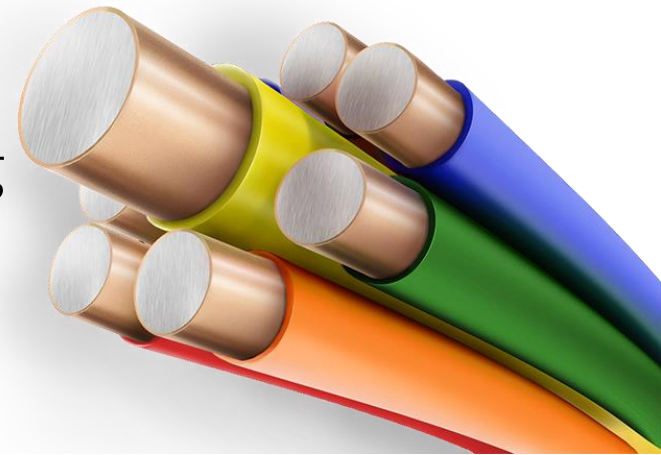

Plan Your Layout

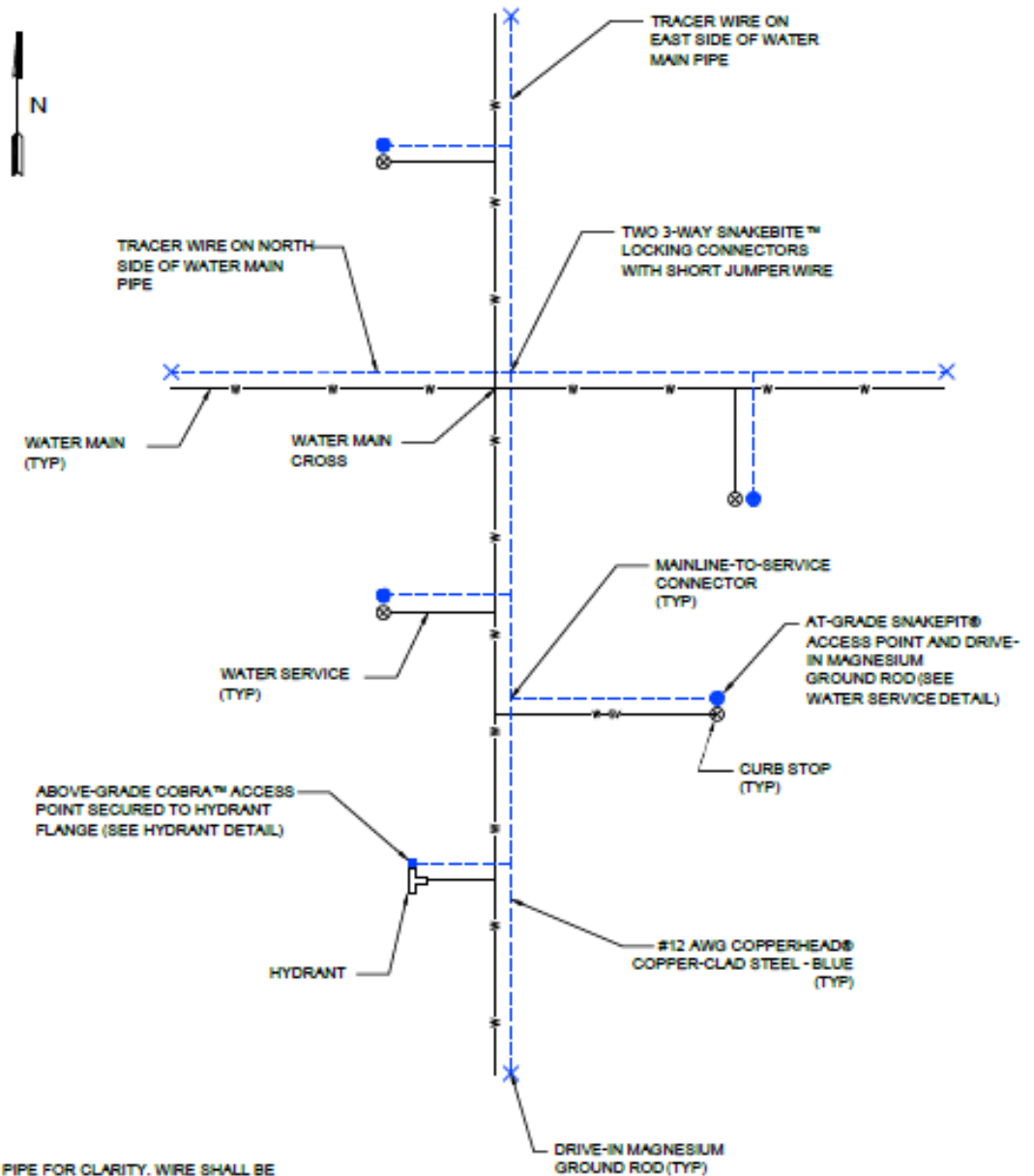

NOTES:
 WIRE SHOWN AWAY FROM PIPE FOR CLARITY. WIRE SHALL BE INSTALLED ON THE BOTTOM SIDE OF THE PIPE BELOW THE SPRING LINE. THE WIRE SHALL BE FASTENED TO THE PIPE WITH TAPE OR PLASTIC TIES AT 5' INTERVALS.



What Should be Specified?

- Placement of the wire in regards to pipe
 - The tracer wire should be placed in the same orientation to all installed pipe.
 - Install the tracer wire on the bottom half of the pipe, between 3 & 9 o'clock.
 - Be consistent (East or West sd.)

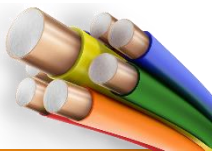

What Should be Specified?

Termination method for tracer wire access & grounding

- The best tracer wire system is no different than the building electrical wiring we're sitting in now
- Proper grounding/terminating of the wire will ensure the quality of the signal
- Use termination/access boxes to bring the tracer wire above ground
- Ensure proper signal strength by:
 - Grounding all dead ends of the wire by using a 1.5# magnesium anode

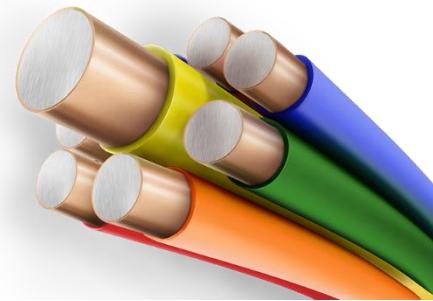
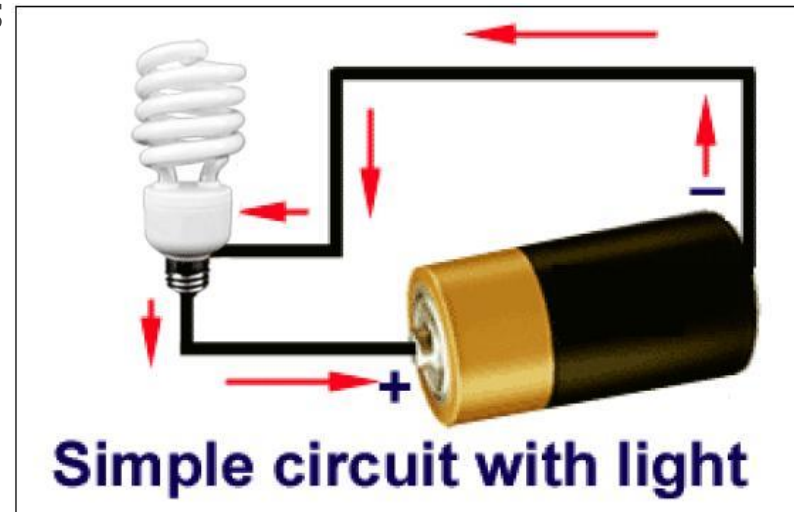

1) Transmitter



Good splice/connector

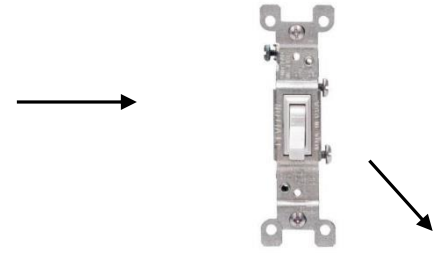

2) Splice



3) Ground

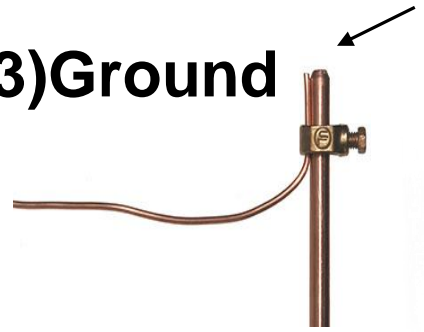

What Should be Specified?

- **Important Step:** Testing of a new system
 - Make sure the contractor, engineer/inspector and city operator performs a locate in common company
 - At the time that rough grade has been established
 - Prior to final acceptance of the project
 - Conductivity testing is not allowed
 - Conductive property of wire does not mean there is **continuity**.

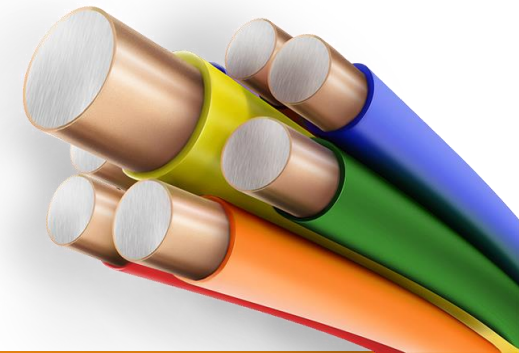

A Complete Tracer Wire System Should Include:

- ✓ **Locating Device**
- ✓ **Clear Tracer Wire Specifications**
- ✓ **AIS Certified CCS Tracer Wire**

**Copperhead's Complete Tracer Wire System
and its accessories deliver EVERY TIME!**



What should be specified?

- Wire Size or Gauge (AWG) what should I use?
 - **Myth:** The bigger the wire the stronger the signal.
 - **Fact:** Larger diameter wire is specified for strength, not signal carrying abilities
- Breakage is the common failure during installation

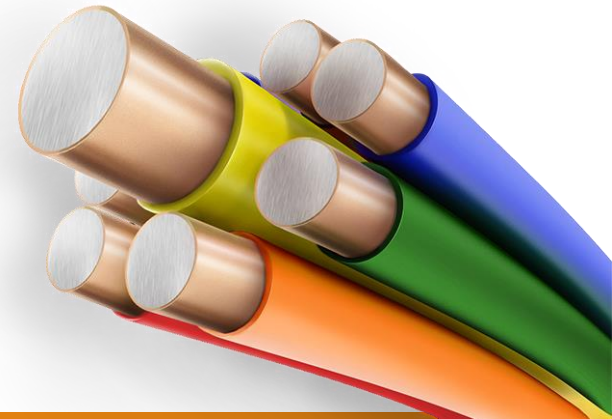

What Should be Specified?

- Specification includes 3 different applications:
 - Open Trench/direct bury
 - High Strength (HS)
 - Directional Boring
 - SoloShot Extra High Strength (EHS)
 - Pipe Bursting
 - SoloShot Xtreme (PBX)

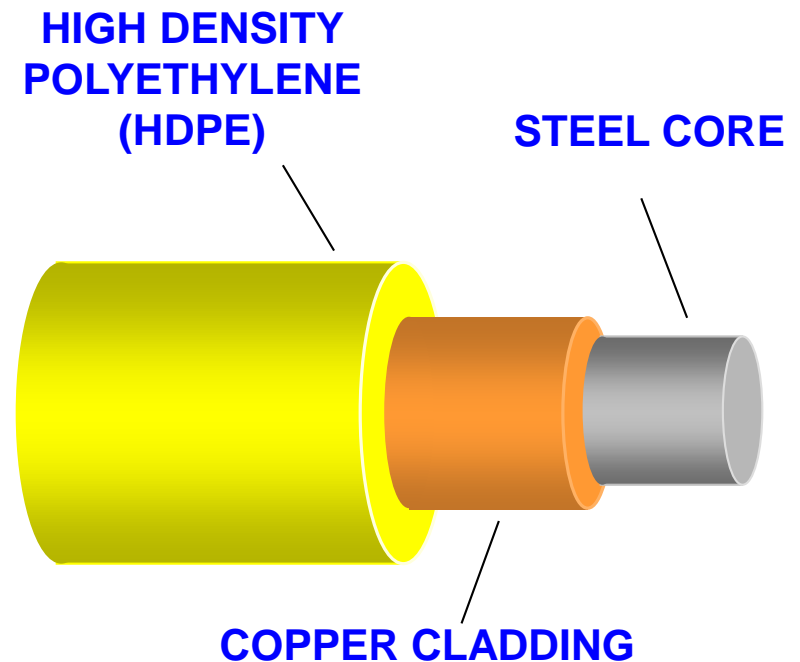

What should be specified?

Jacket Color

- Color is simple, follow the APWA uniform color code, without exception, just like the paint used for marking

| APWA UNIFORM COLOR CODE | |
|-------------------------|--|
| WHITE | WHITE - Proposed Excavation |
| PINK | PINK - Temporary Survey Markings |
| RED | RED - Electric Power Lines, Cables, Conduit and Lighting Cables |
| YELLOW | YELLOW - Gas, Oil, Steam, Petroleum or Gaseous Materials |
| ORANGE | ORANGE - Communication, Alarm or Signal Lines, Cables or Conduit |
| BLUE | BLUE - Potable Water |
| PURPLE | PURPLE - Reclaimed Water, Irrigation and Slurry Lines |
| GREEN | GREEN - Sewers and Drain Lines |

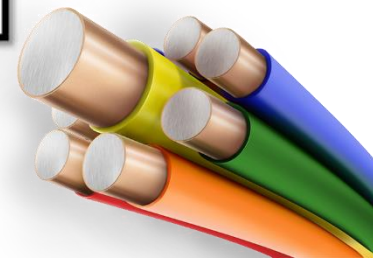

What Should be Specified?

- Wire Type - Copper Clad Steel (CCS)
 - CCS works so well, there's no need for stranded or solid copper.
 - High Strength CCS was introduced to the market in 2004 specifically for tracer wire applications.
 - Benefits include:
 - 2X the strength of solid copper
 - Equal conductivity to solid copper
 - As low as 25-50% of the price of copper

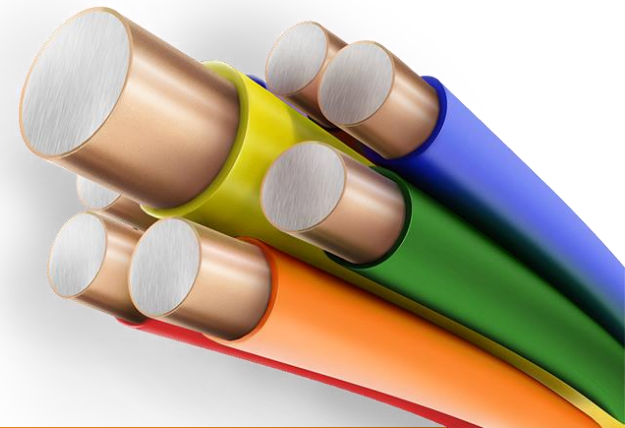

Copper Clad Steel History

- CCS was first produced in Rankin, PA, in 1915.
- Through the years, it has been used in various markets. Telecommunications, CATV, telephone, and utility grounding applications are a few of the industrial applications.
- Commercially this product is used in various goods such as antenna wire, chain link fencing, trolley cable, ground rods and mats, vacuum cleaner hoses, electronic pins and connectors, guy strand, detonation wire (TNT), and it is even used in revetment mats to stop erosion on riverbanks.

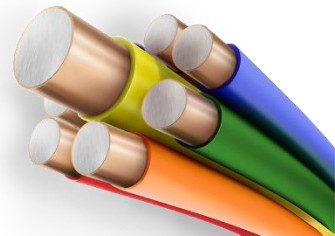

What Should be Specified?

Wire Insulation type

- Many different jackets or coatings exist
- For direct burial use only:
 - High Density Polyethylene (HDPE) or
 - High Molecular Weight Polyethylene (HMWPE)
- Nylon or THHN (Nylon/PVC) is most common at big-box stores and is not designed for direct burial

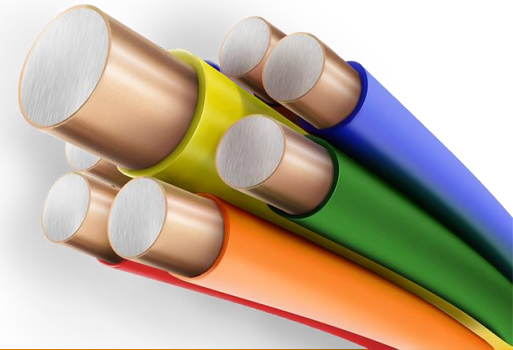

Open Cut Specification

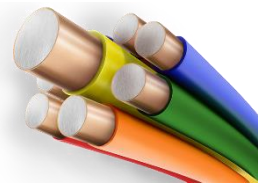

Direction Drilling/ Boring Specification

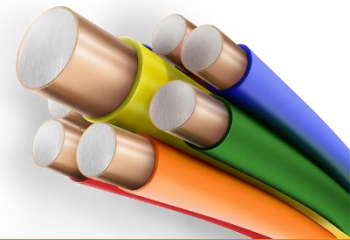

Pipe Bursting Specification

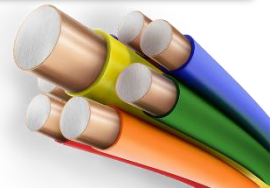

CCS Advantages

- More durable, longer lasting performance
- Twice the breaking strength of solid copper
- Reduced material cost
- More stable, longer term pricing
- Reduced threat of theft due to lack of after-market value
- Lighter weight, resulting in reduced shipping and handling costs
- Fewer breaks during installation, fewer breaks over time

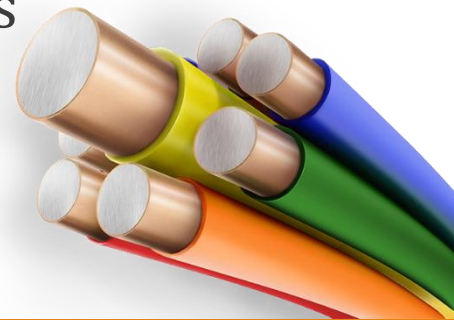

1055 High-Strength Steel



Highly Conductive Oxygen Free Copper

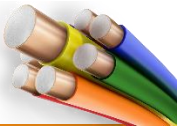

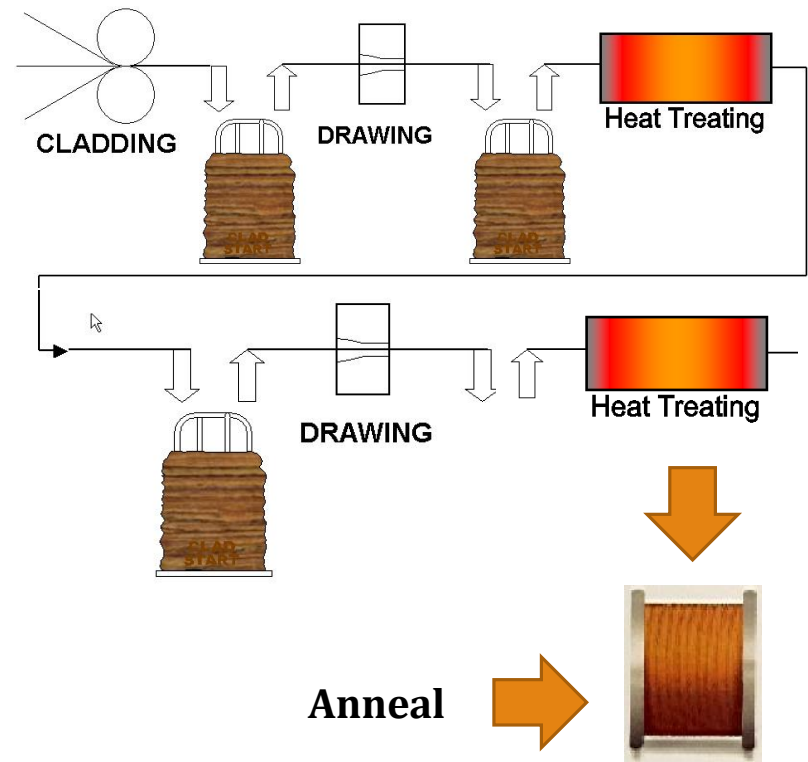
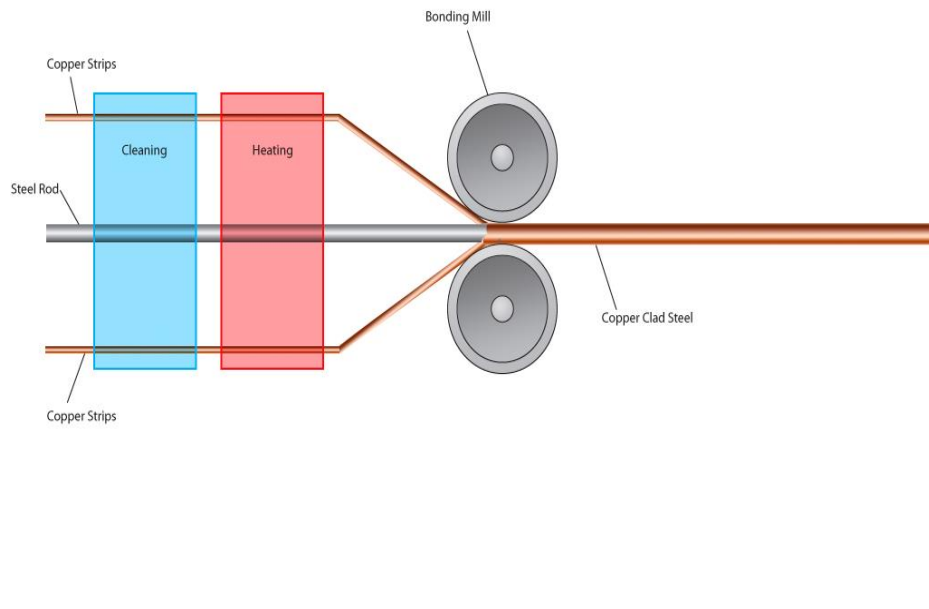

CCS Cladding Process

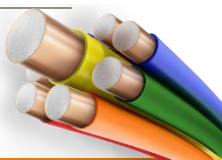

Corrosion



- Testing at Copperweld has been monitored by a comprehensive five year corrosion study by South West Research in San Antonio, Texas and the collected results audited by CC Technologies.
- Based on the test results Copperhead wire will meet and exceed utility requirements for tracer wire. The copper cladding remains completely functional with minimal corrosion.
- It should be noted that the force required to expose the steel in CCS far exceeds the force required to completely sever solid copper wire.



Bad Cladding of CCS

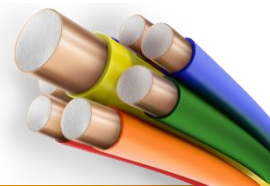
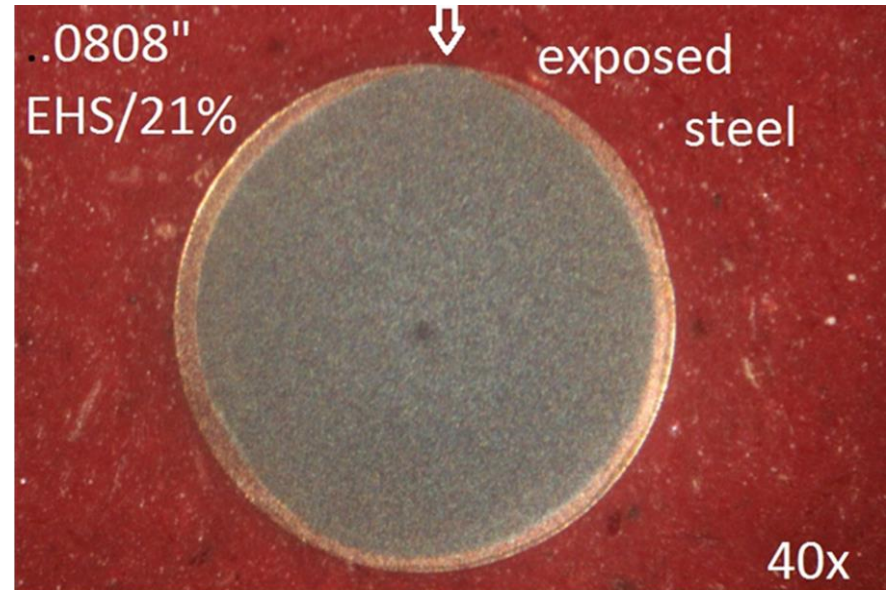
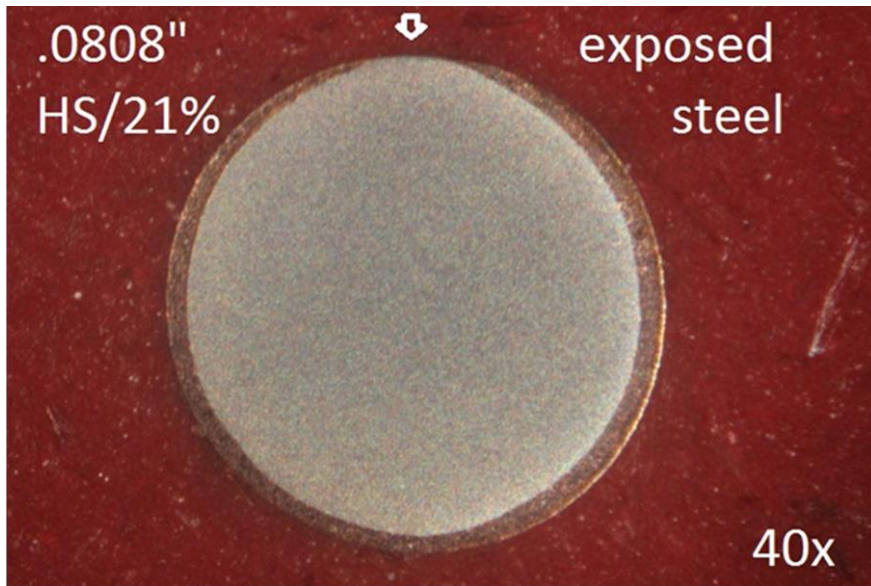

Bad Cladding results in corrosion and lost signal

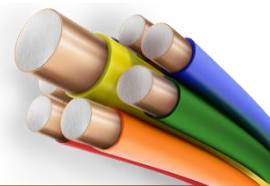
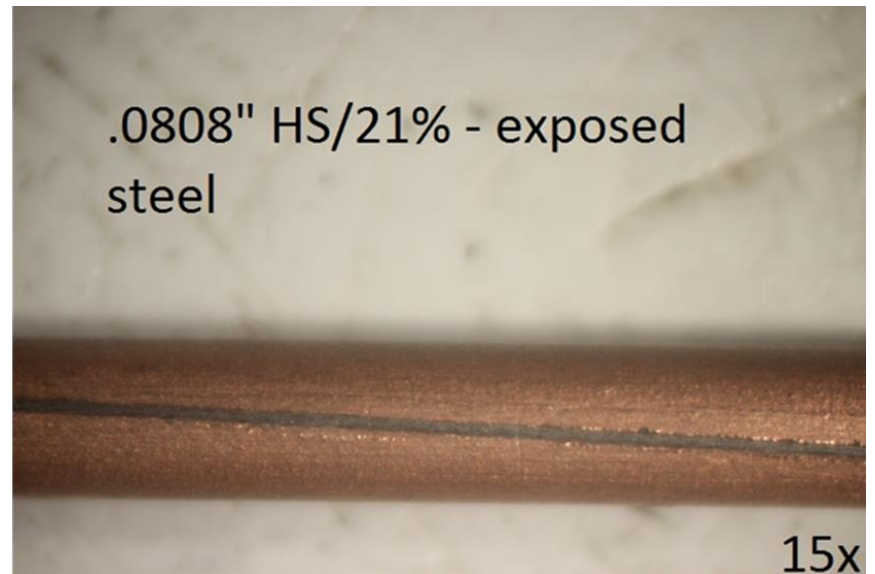

A Complete Tracer Wire System Should Include:

- ✓ **Locating Device**
- ✓ **Clear Tracer Wire Specifications**
- ✓ **AIS Certified CCS Tracer Wire**
- ✓ **Testing Stations**

**Copperhead's Complete Tracer Wire System
and its accessories deliver EVERY TIME!**



Grade level access box - SnakePit

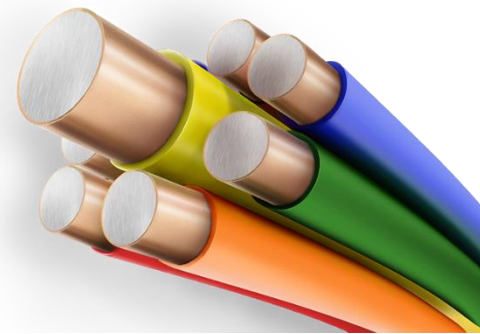

Grade level access box - SnakePit

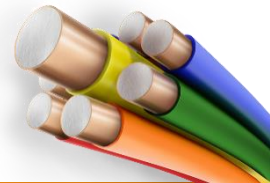
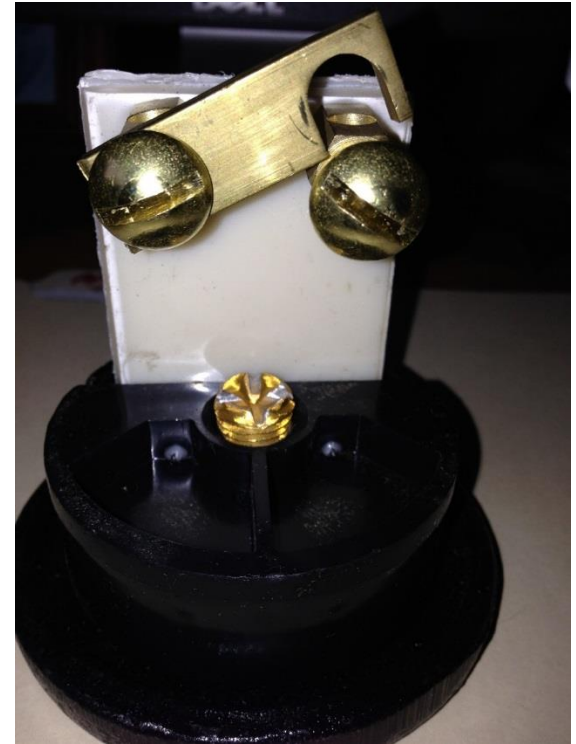



TWO-TERMINAL SWITCHABLE LID FOR SNAKEPIT® ACCESS POINTS (LID ONLY)

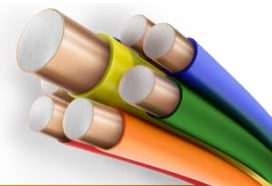
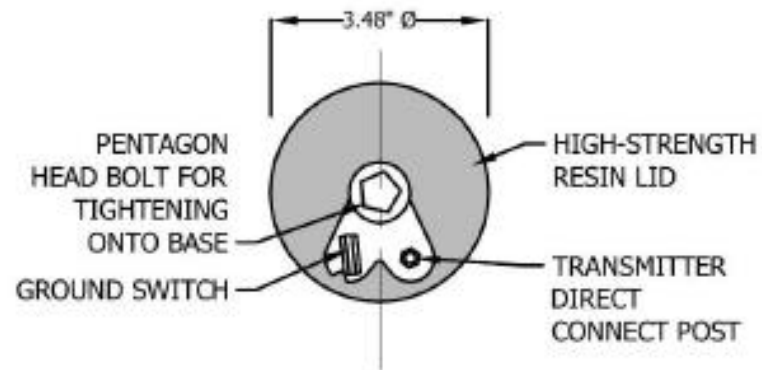
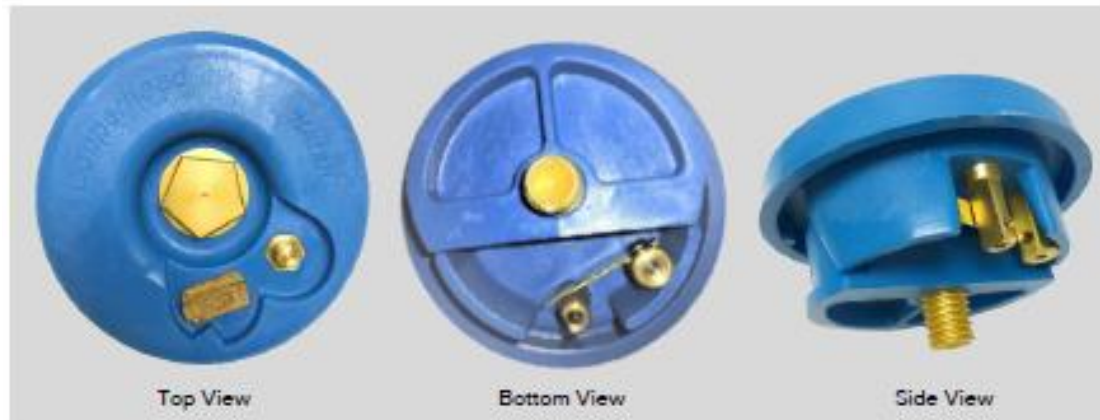

Above grade access box - Cobra



Why Cobra works well up North



A Complete Tracer Wire System Should Include:

- ✓ **Locating Device**
- ✓ **Clear Tracer Wire Specifications**
- ✓ **AIS Certified CCS Tracer Wire**
- ✓ **Testing Stations**
- ✓ **Grounding Anodes**

**Copperhead's Complete Tracer Wire System
and its accessories deliver EVERY TIME!**



Failure to Properly Ground



- Locate signal can be applied at any service. Current will not want to flow up other services if the dead-end of the tracer wire does not provide a good path to ground.
- There are two main methods for locating these other services;
 - Move the transmitter to each service, or
 - add a jumper wire at the dead-ends to give the signal a path to ground

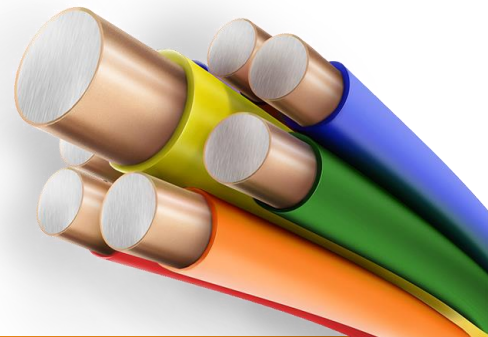

Grounding Anodes

- Attach (1.5#) Magnesium grounding anode to the tracer wire will properly ground it.
- Connect the anode to the tracer wire at all dead-ends, but with grade level access.
- When disconnected from the tracer wire, the ground wire provides an excellent ground for the locating transmitter.

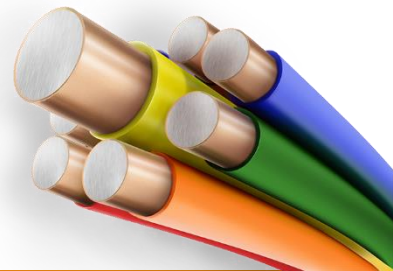
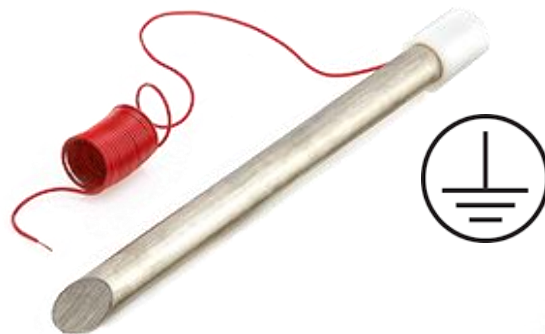

A Complete Tracer Wire System Should Include:

- ✓ **Locating Device**
- ✓ **Clear Tracer Wire Specifications**
- ✓ **AIS Certified CCS Tracer Wire**
- ✓ **Testing Stations**
- ✓ **Grounding Anodes**
- ✓ **Proper Locking Connectors**

**Copperhead's Complete Tracer Wire System
and its accessories deliver EVERY TIME!**



What Should be Specified?

- Proper Connections
 - Even if you have the best tracer wire in the ground, it's only as good as the connections.
 - Connectors:
 - Protect from moisture and corrosion
 - Are essential for proper conductivity and longevity
 - Specified moisture displacement connectors:
 - **3-way connectors**
 - **Mainline to Lateral connectors**

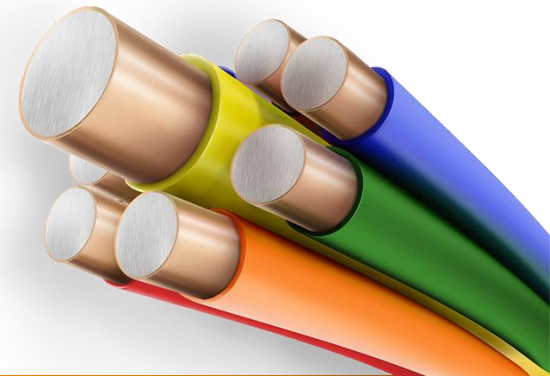

Mainline to Lateral Connector - Specified

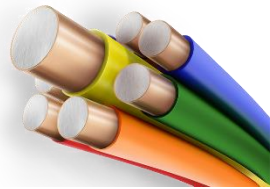



SNAKEBITE™

LOCKING CONNECTOR



**NO Wire Stripping needed.
Simply insert wires, twist and lock.**

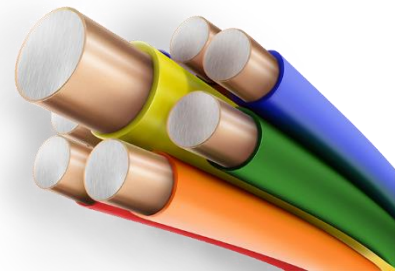

Never again access a tracer wire within the roadway

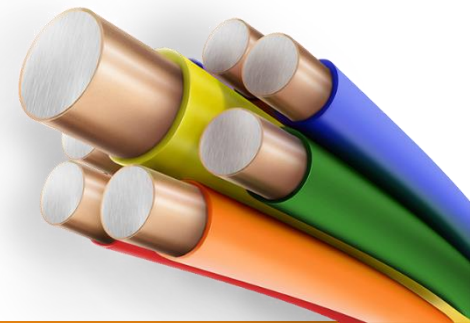

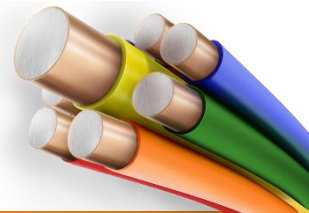

Tracer wire installations gone bad...



Tracer wire installations gone bad...

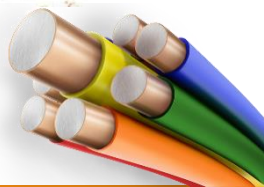

Tracer wire installations gone bad...

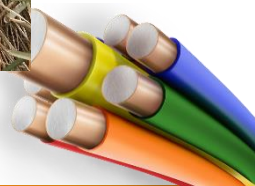

Tracer wire installations gone bad...

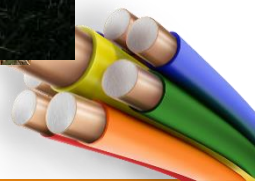

Tracer wire installations gone bad...

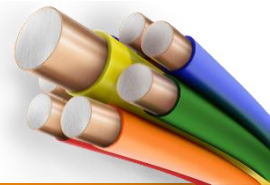

Tracer wire installations gone bad...

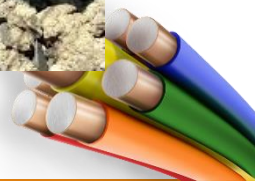

Tracer wire installations gone bad...

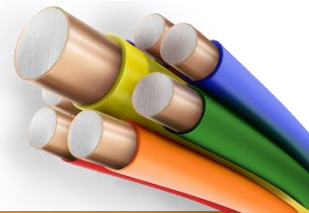

Tracer wire installations gone bad...

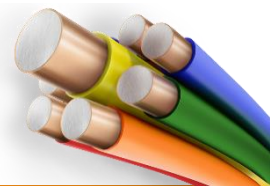

Tracer wire installations gone bad...

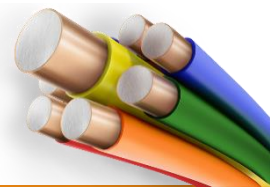
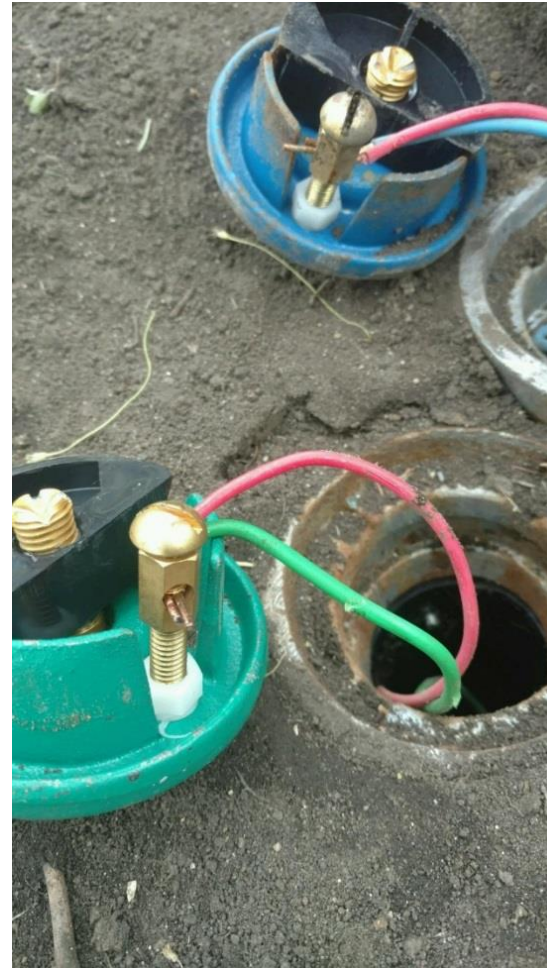

Tracer wire installations gone bad...

Another project that was supposed to be following the Tracer Wire Specification

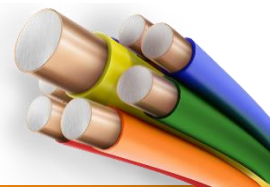

Other items for discussion

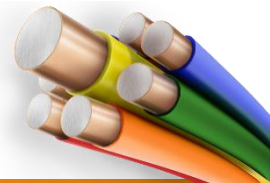

Proper attachment of wire to pulling head

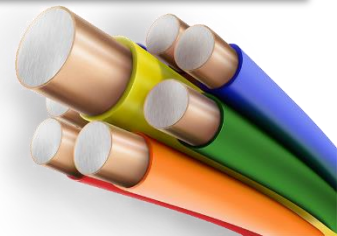

Results of not being properly attached to bursting head

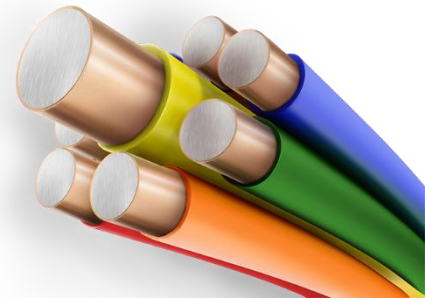
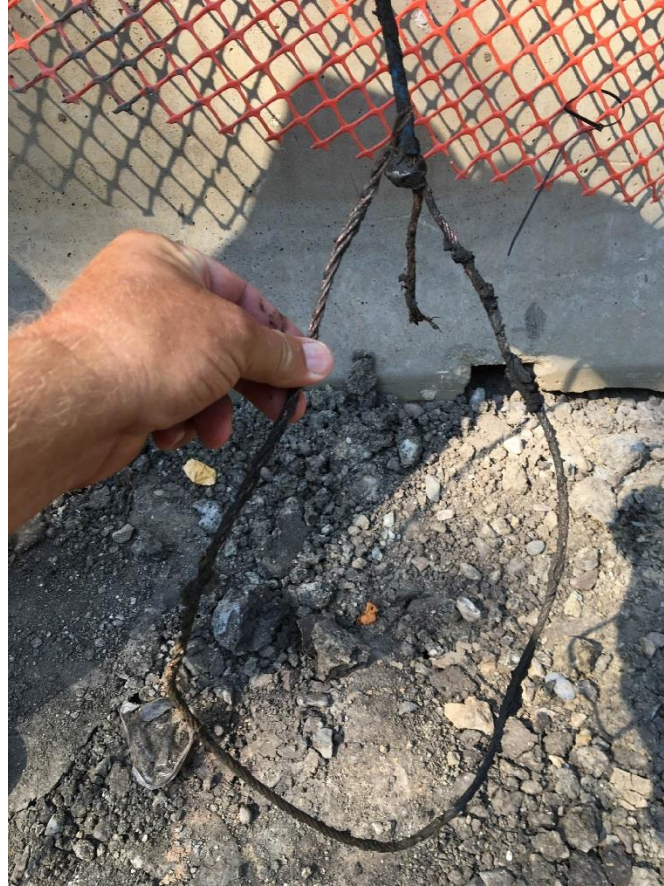

Directional Drill Cross Bore

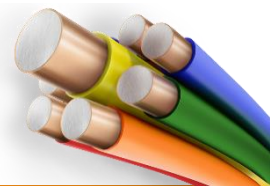

Boom!

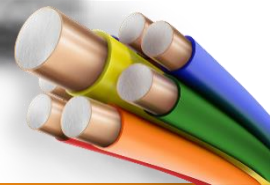

I didn't do it!

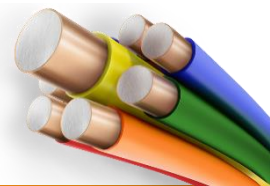

Questions???

Kevin Waugh
Manufacturer Representative,
Copperhead Industries, LLC
kevin@utility-solutions.com
Mobile 740-972-6359

