

Neptune Equipment

www.neptuneequipment.com



NEPTUNE
TECHNOLOGY GROUP INC.

Take Control.



AMI & AMR Systems
Understanding the Benefits to
Improving Customer Service

Presenter:
Ray Schwarz

AWWA State of the Industry Report



Top 5 Issues:

- Infrastructure
 - Cost of replacement of aging infrastructure. Older areas.
- Regulatory factors
 - Cost to implement new, tougher regulations. Rural areas.
- Business factors
 - Ability to fund needed repairs.
 - Imbalance between rates and cost to produce.
- Water supply & protection
 - Arid and high growth areas.
- Workforce
 - “Almost 40% of utility workers will become eligible for retirement in the next 5 years.” (*Public Utilities Fortnightly*, July 2006)

AMR Market Drivers

- Meter reading cost and time
- Meter reading safety and liability insurance
- Hard-to-Read meters
- Aging infrastructure
 - Main maintenance
 - Fire hydrant maintenance
 - Distribution System Tampering
- Customer Service
 - Eliminate estimated reads
 - High water bill complaints
- Increase Cash Flow
 - Shorten billing cycle



Water Losses

Leaks on
Distribution
Mains

Unauthorized
Consumption

High Water Bill
Complaints

Leakage on customer
side of the meter



Daily Production – Daily Metered

Distribution Leak Monitoring – R450/AMR Permalog

Abnormal Consumption – daily or hourly usage profile

End User Leaks – E-Coder

Daily Tools to Analyze your System

AMR/AMI Terminology

- **AMR** – (Automatic Meter Reading) automated process that collects readings from customers' meters without directly accessing the meter and can export reads to a remote central location
- **AMI** (Advanced Metering Infrastructure) automated process that collects readings and ***other data***, typically without going to the meter site, often two-way communication to facilitate data transfer
- **Ancillary devices**
 - Actuators - using the AMI communication network to operate equipment (e.g., customer shut-off valves)
 - Sensors – using AMI communication to process information from monitors other than meters (e.g., leak detectors, water pressure monitoring, water temperature)
- **Intelligent meters** – Reading devices with internal data storage/analysis capabilities to provide information/alerts to supersede or supplement readings
- **Interval Reads** - providing multiple period water usage data at predetermined or remotely configurable time intervals with individual collection transmissions

An Understanding between AMR and AMI

- **AMR – Automatic Meter Reading**

- AMR technologies include handheld, mobile and network technologies based on (wired and wireless), radio frequency (RF), or powerline transmission. The primary purpose is to gather **meter reading data** coming from the meter to collection in a **one-way or 1 ½-way** communication method.

- **AMI – Advance Metering Infrastructure**

- A **smart meter** is usually an electric meter that records consumption of electric energy in intervals of an hour or less and communicates that information at least daily back to the Utility for monitoring and billing purposes. Smart meters enable **two-way communication** between the meter and the central system.

Utilities may receive *meter reading data* but also *daily monitoring, data reporting and programming information*.

Often associated as the “Smart Grid” technology

Reading System Overview

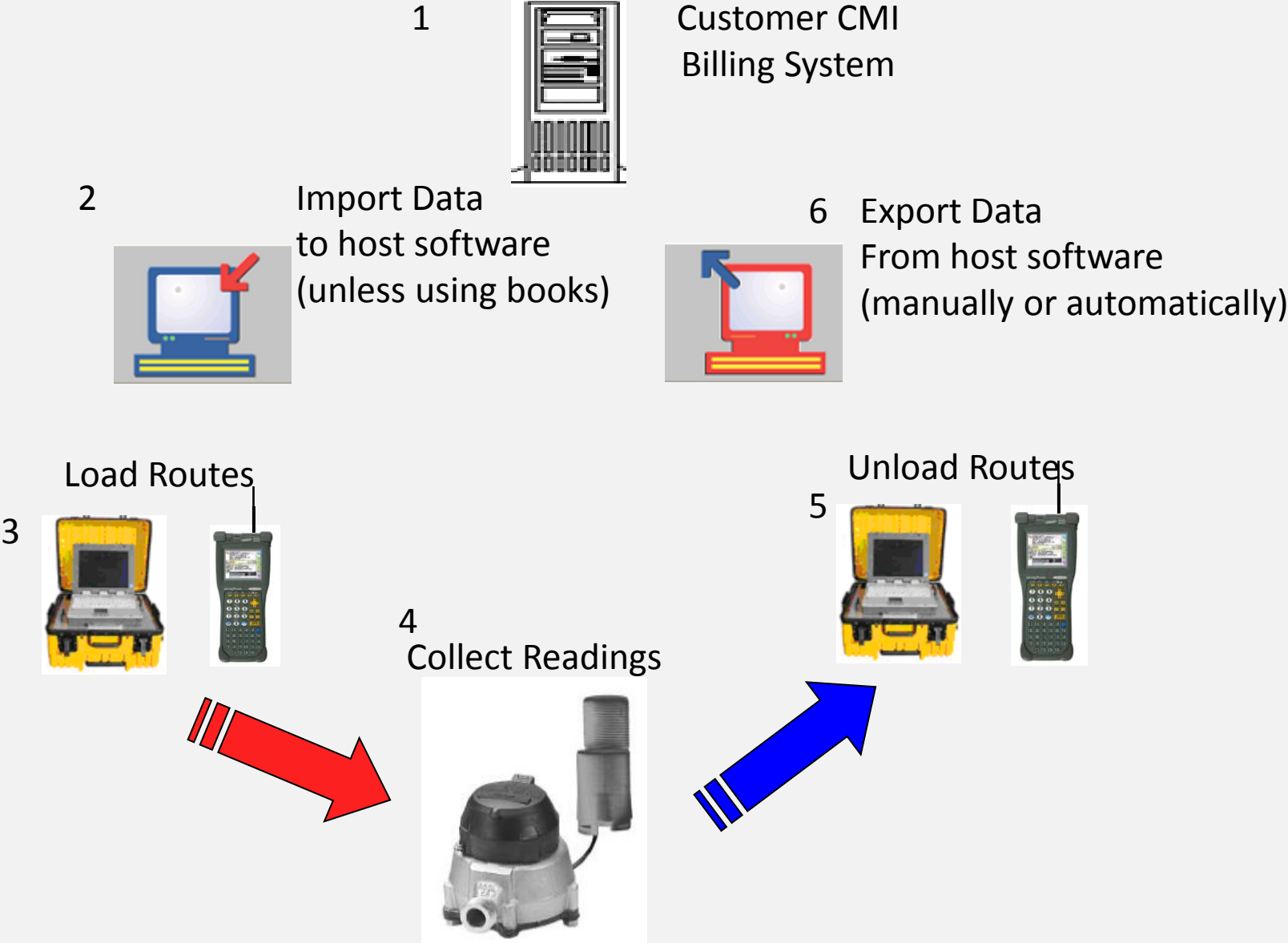

The Evolution of AMR

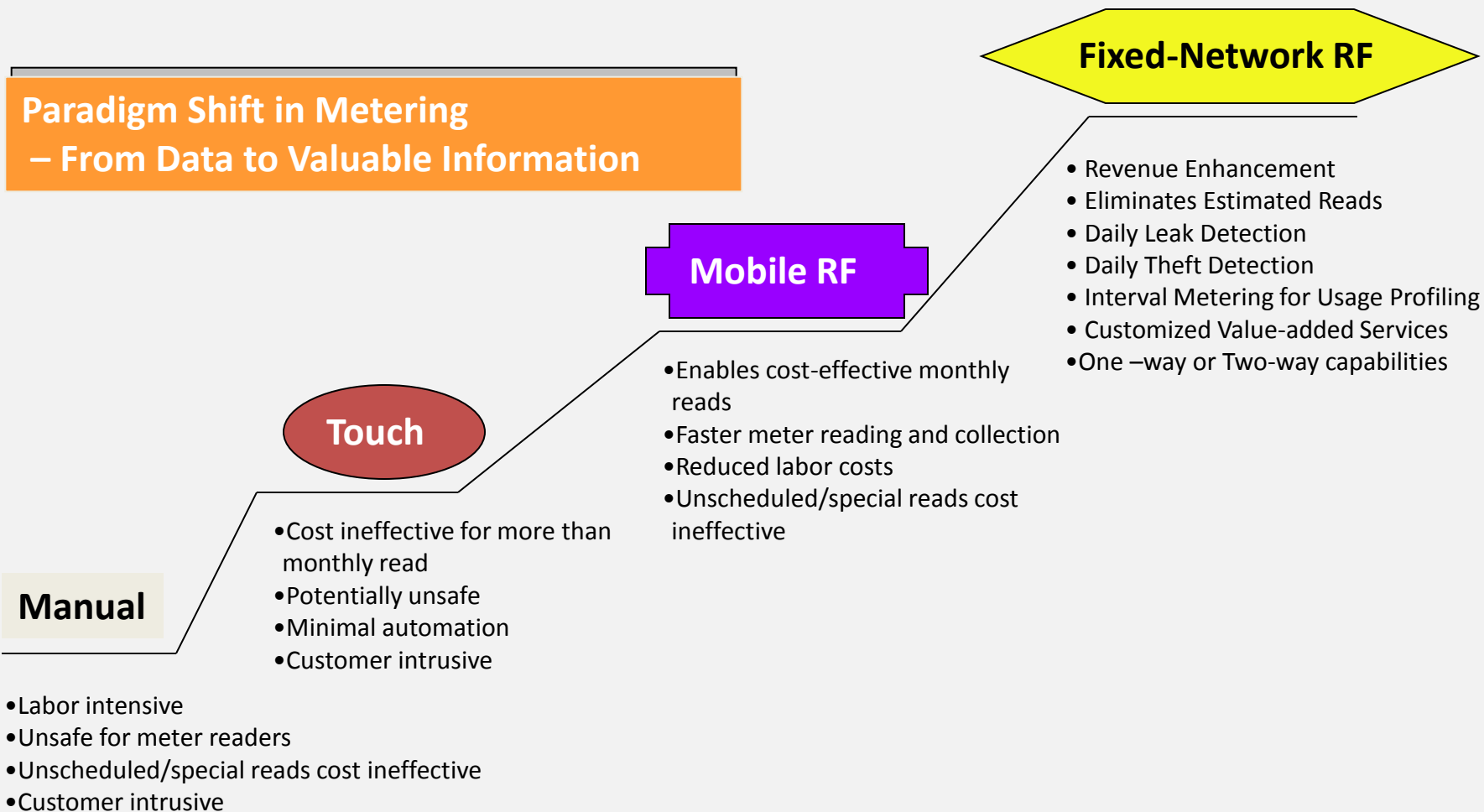

The Evolution of AMR



Why Improve Meter Reading Method?

Meter Reader Safety

- Fewer Dog bites
- Weather related conditions
- Fewer Injuries - Fall on ice
- Less need to be driving throughout the community
- Access issues
- Challenging locations of the meters
- Customer Service
 - eliminate inaccurate reads
 - avoid estimates
- Efficiency
 - increased number of reads per day lowers meter reading costs



Do We Remember Last Winter



AMI & AMR Provides Two Major Benefits

- Meter Reading Improvement

- Better Data

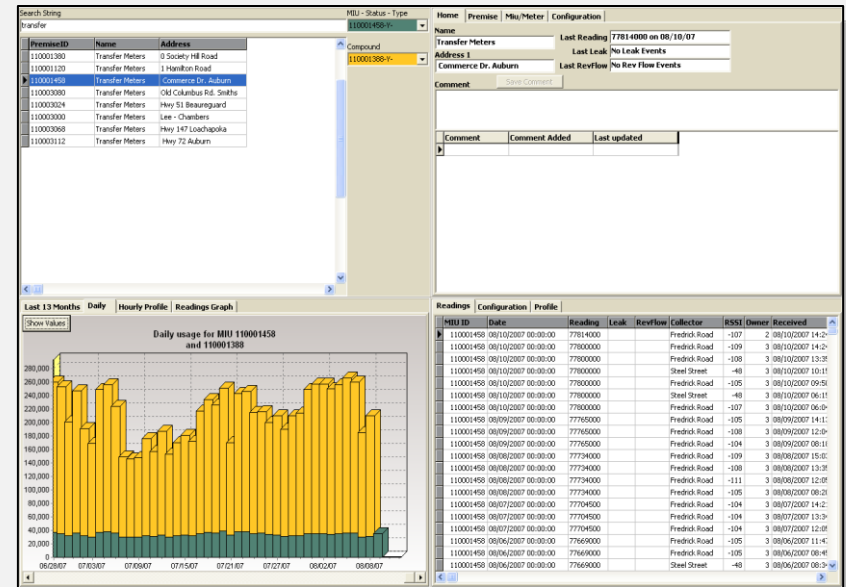
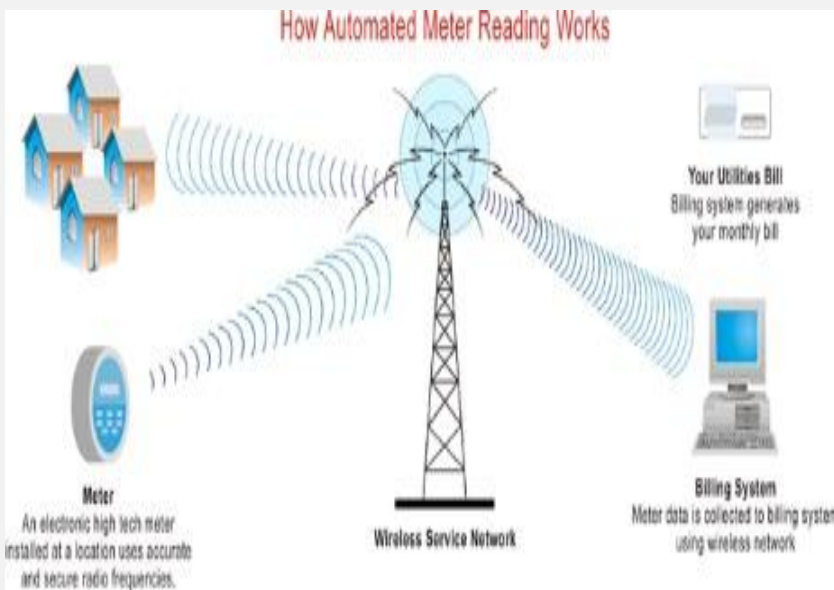

Improving Water System Operations

- Meter selection and accuracy
- Non Revenue Water Evaluation (DMA)
- System Leak Monitoring
- System Backflow
- Water Quality Monitoring

Fixed Network



AMI 2-way FixedBase System Architecture

- Tower Based
- 450-470MHz Licensed Band
- Full 2-way (Host to MIU)
- Multiple Backhaul Options
- Server Based or Hosted

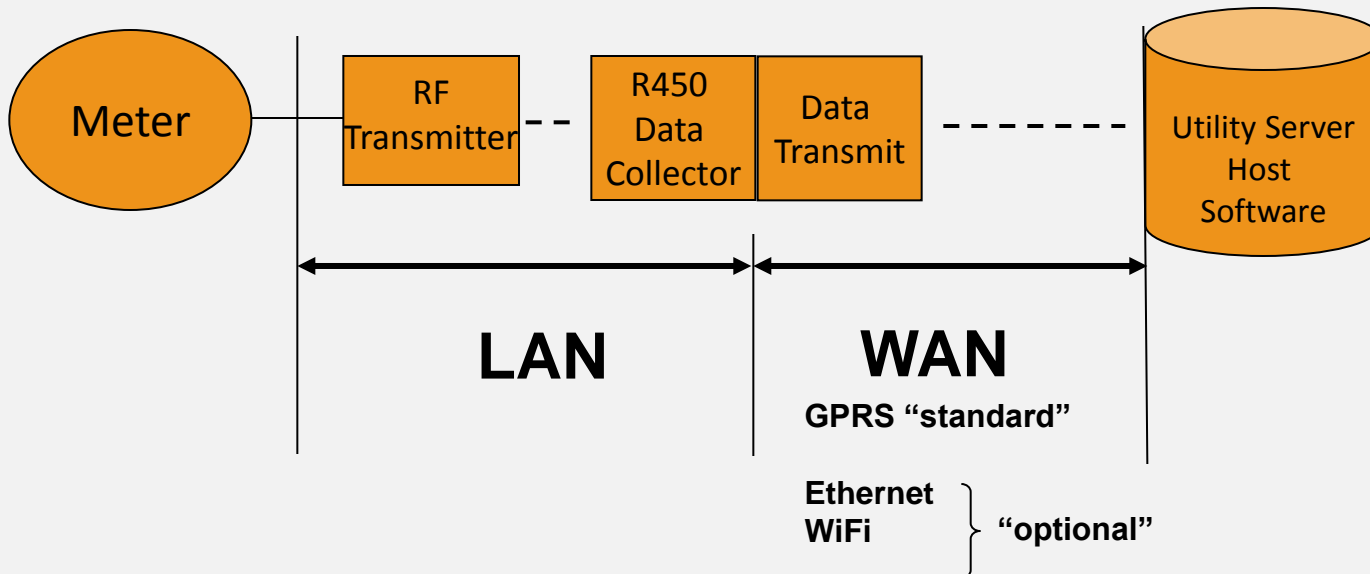

Benefits of AMR/AMI



Leak Detection

Daily reception of E-Coder® leak intermittent and continuous leak flags



Customer Service

Easily accessed and daily reading data allows utilities to improve customer service and resolve billing disputes



Off-Cycle Reads

Daily readings from the Gateway are available to support off-cycle readings without rolling a truck, saving time and money



Reverse Flow Monitoring

Daily access to E-CoderPLUS flags provides continuous reverse flow monitoring 24 hours per day



Tamper Detection

Advanced E-CoderPLUS tamper detection provided daily to the Gateway



Usage Profile Analysis

Data received by the R900® Gateway allows a utility to provide more data to industrial/commercial customers so that those customers can manage usage

Types of AMI Systems

- **Tower Base**

Collector antennas placed strategically throughout the reading area for total collection

Normally located on water towers, tall buildings, and antenna towers



AMI FixedBase - RF Collector

- Tower-based system
 - ≥ 150 feet preferred antenna height
 - Collectors can be located on rooftops of buildings, or telephone poles (lower heights reduces cell size)
- Antenna is mounted on the top of the tower
- Data collector is mounted at the base of the tower
- 110 VAC power requirement
- GPRS modem standard (Ethernet, Wi-Fi backhauls are optional)

Benefits

- **Reduced number of collectors**
- **Ease of access to equipment**
- **Lower maintenance costs**



Types of AMI Systems

- **Mesh Network**

Relaying data information from one unit to another to relay the readings to the host computer.

The individual units gather their own data but also pass other data

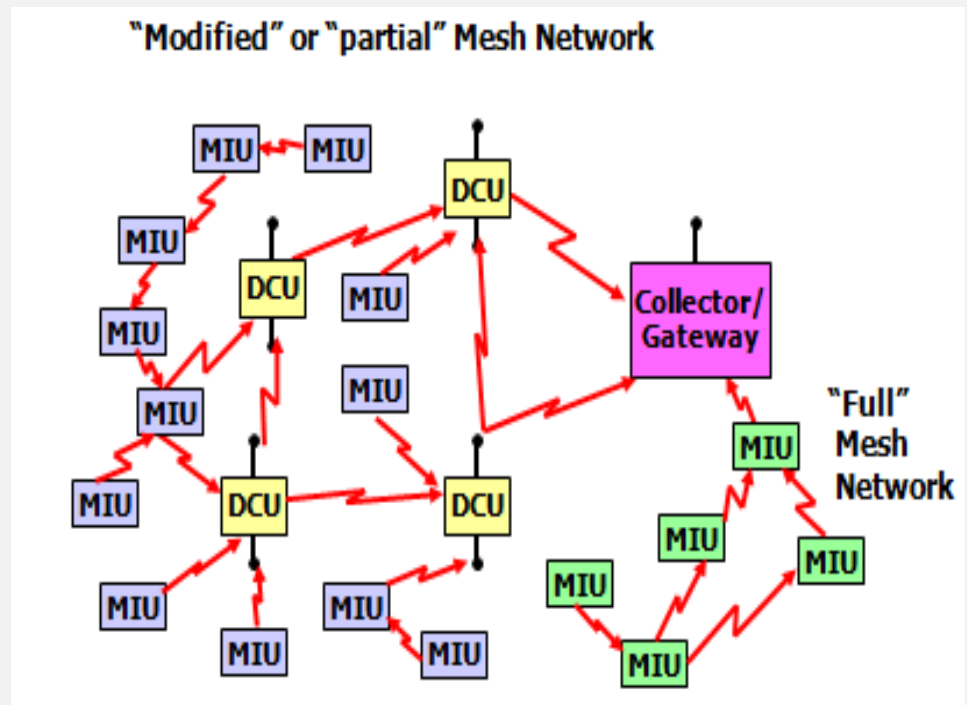

AMIFixed Network RF AMR

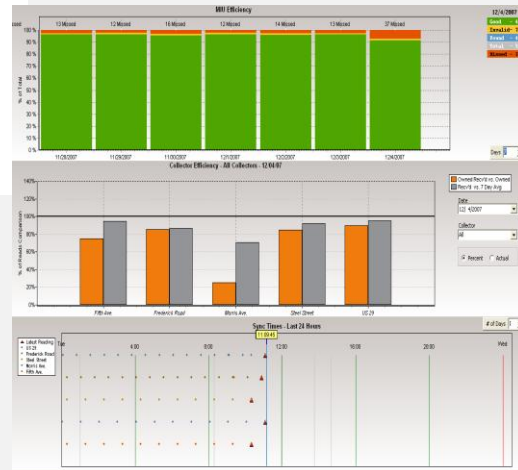

- Enhanced meter reading efficiency and safety
- Eliminates estimated reads
- Ease of unscheduled / special reads
- Daily leak / theft detection
- Usage profiling
- Customized value-added services
- Real-time use of smart encoder features
- Reverse flow alarm for system security initiatives
- Can spot and correct meter and system issues before billing

Up to 24
Reads per meter
per day

2,000-30,000 reads per day

1,000-2,000 reads per day

175-450 reads per day

100-175 reads per day

Smart Encoders

- Higher Resolution
 - Leak Detection
 - Reverse flow Detection
 - Tamper Detection
 - Data Logging
-
- Actionable Information
 - Improved Customer Service
 - More Information to you



Leak Detection without High Resolution

Usage Profile

- Undetected leak standard with 6-digit resolution

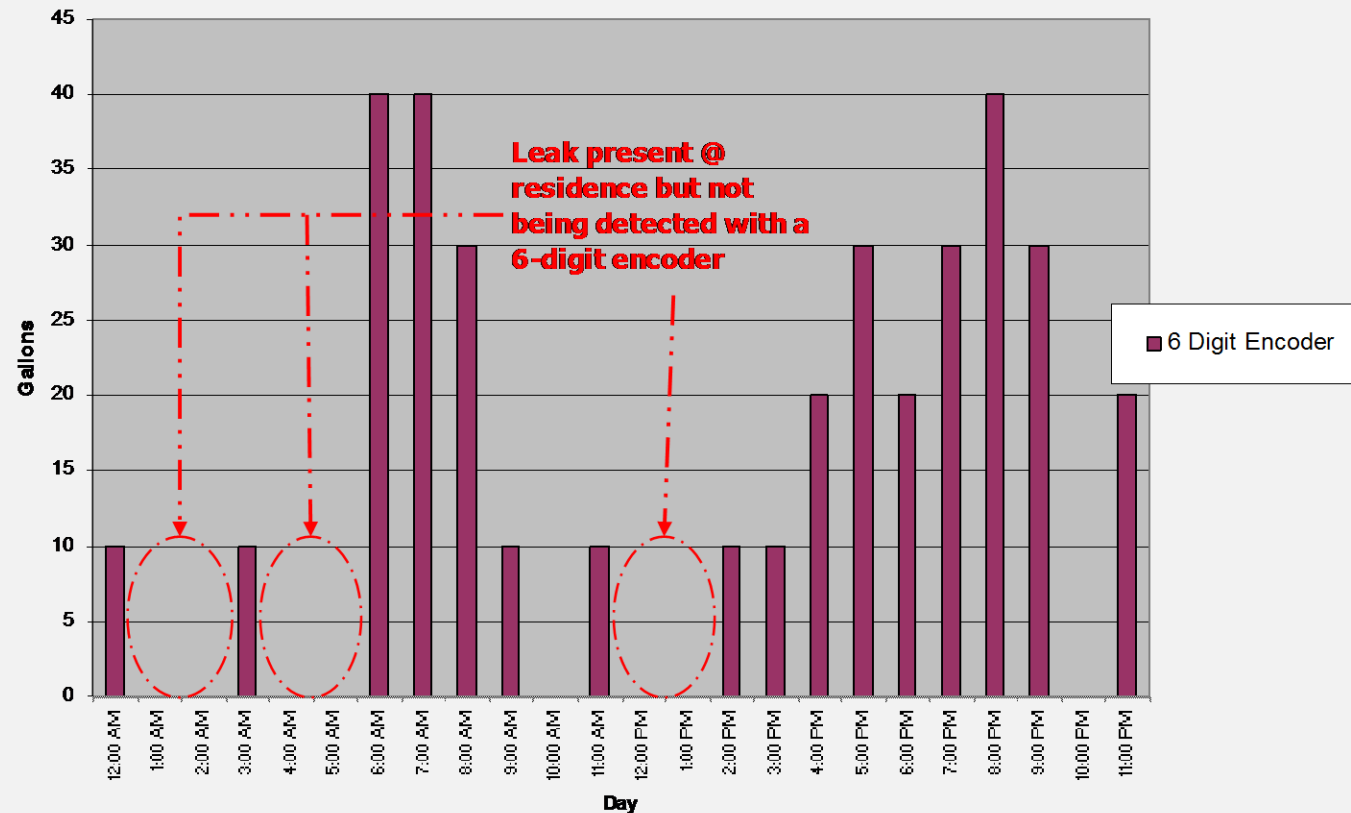

E-Coder 8-digit Resolution

- **8 Digit Resolution = 1/100 GPM**
- **True Leak Detection Demands High Resolution:**

- *Old Technology Cannot Get Below 1 GPM.*
- *That Is a Pretty Big Leak!*

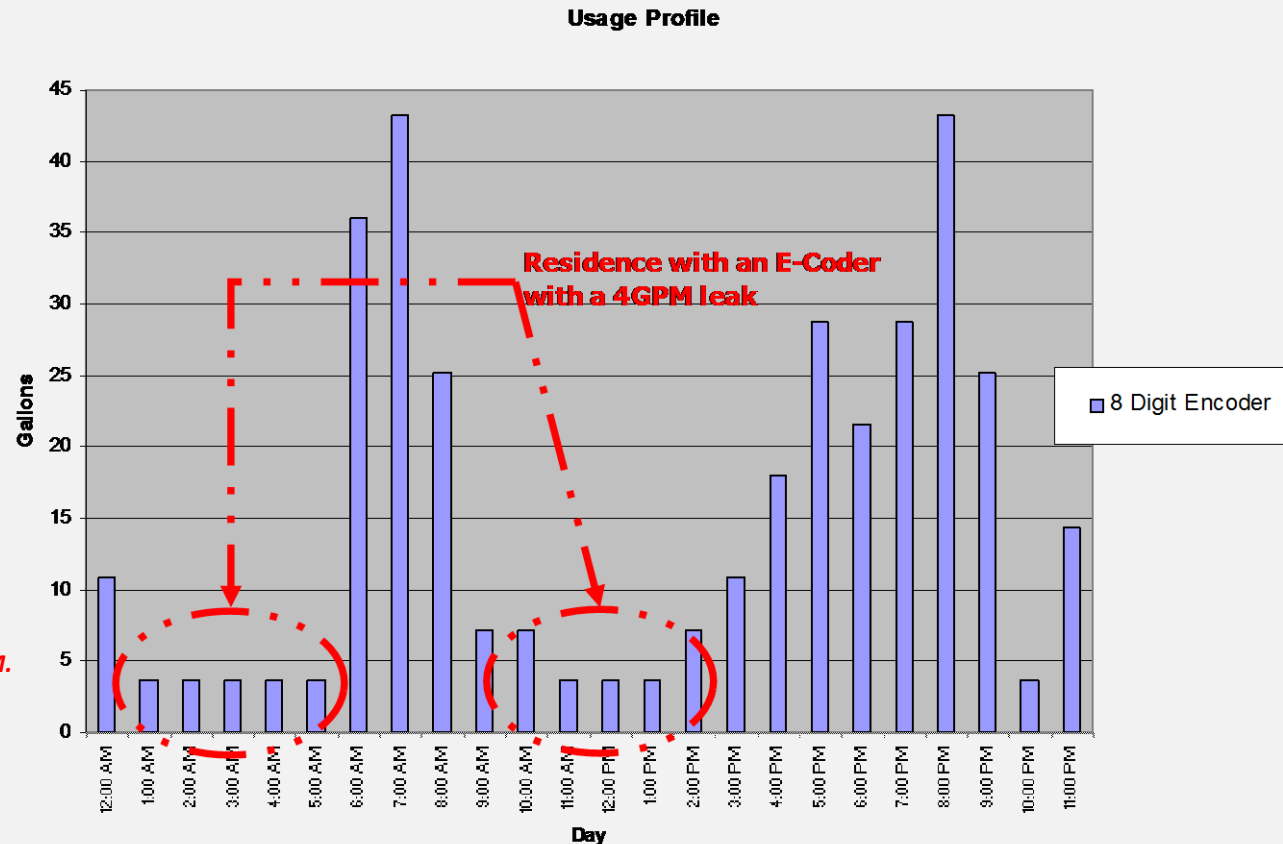

The Need for High Resolution

Meter Application	Conventional Encoder		Solid State E-Coder	
	Visual	Remote	Visual	Remote
Residential (5/8" – 1" T-10)	0.1 cubic foot	1 cubic foot	0.001 cubic feet	0.01 cubic feet
Light C&I (1½" & 2" T-10; 1½" – 4" HTP)	1 cubic foot	10 cubic feet	0.01 cubic feet	0.1 cubic feet
Large C&I (6" – 20" HPT, HPPIII, & TF)	10 cubic feet	100 cubic feet	0.1 cubic feet	1 cubic foot

High Resolution = High Value

Smart Encoder: Value Throughout the Utility

General Management

- Accurate bills
- Proactive water leak notification
- Financial accountability
- Resource conservation

Customer Service

- Improved operational efficiency
- High water bill complaint resolution

Finance

- Increased cash flow
- Reduced unaccounted-for-water
- Improved bottom line

Meter Reading Department

- Encoder technology
- Guaranteed accurate readings

Maintenance

- Service order reduction – leaks, tamper, backflow
- Enhanced trouble-shooting tools

AMI Can Help Track and Identify Non-Revenue Water

DM A HOURLY METER DATA UTILITY 2

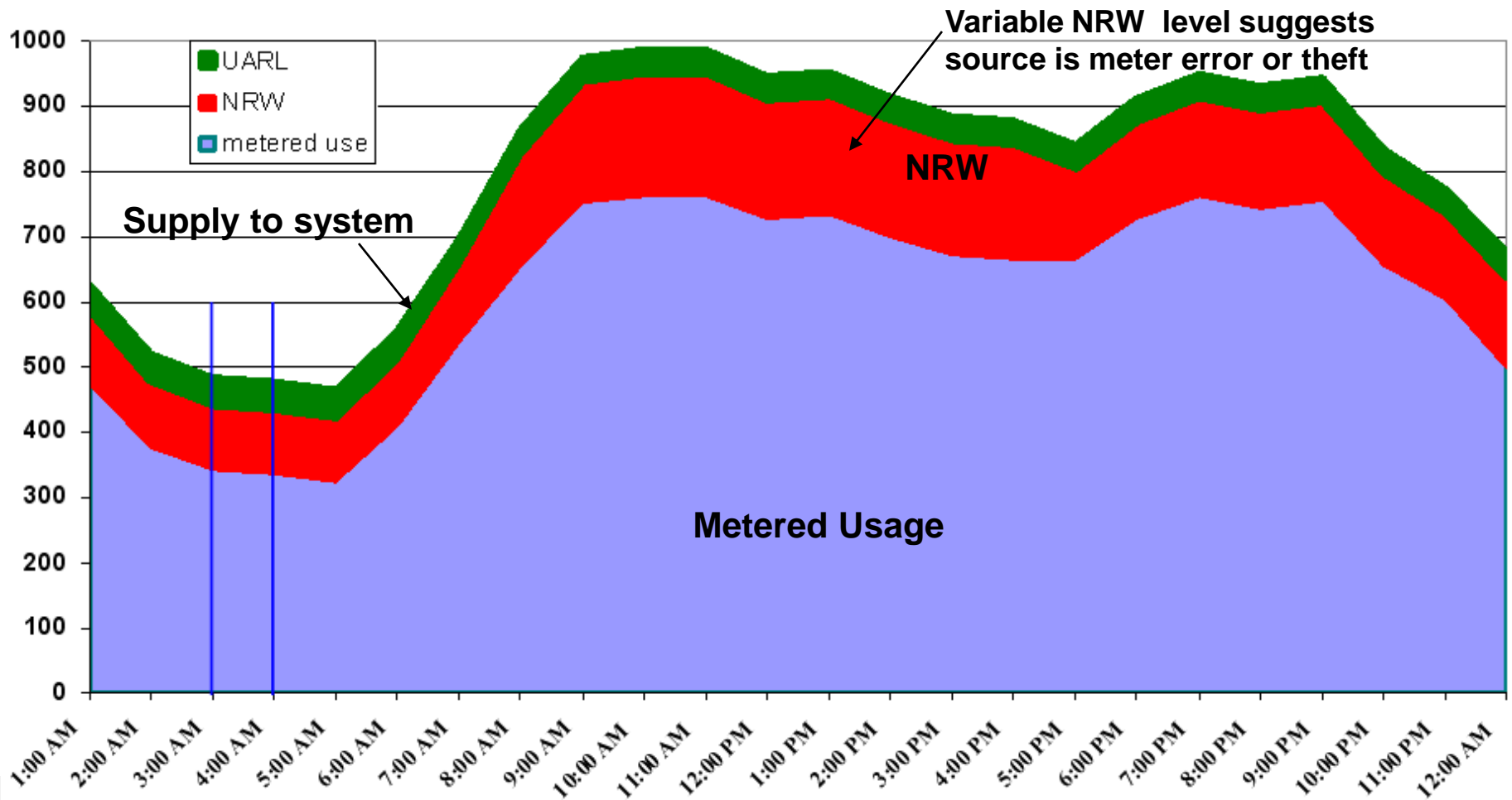

Utility View - Example Group Detail

Consumption of every meter in the system compared to the water Pumped from the Water Plant

Water Pumped – Total Water Used = Unaccountable Water (non-billed water)



Daily Reading

System Characteristic	AMI System Functionality	
Time Synchronization	<ul style="list-style-type: none">• All MIUs synchronized with the host system time.• All MIUs take their meter reading at midnight.	

System Health Screen

- “At-a-glance” view of the efficiency of the system
 - MIU efficiency
 - Collector efficiency
 - Orange bar represents “Owned” MIUs (MIUs the collector is receiving the strongest signal strength from)
 - Grey bar represents all of the MIUs the Collector has received transmissions from
 - Collector sync times

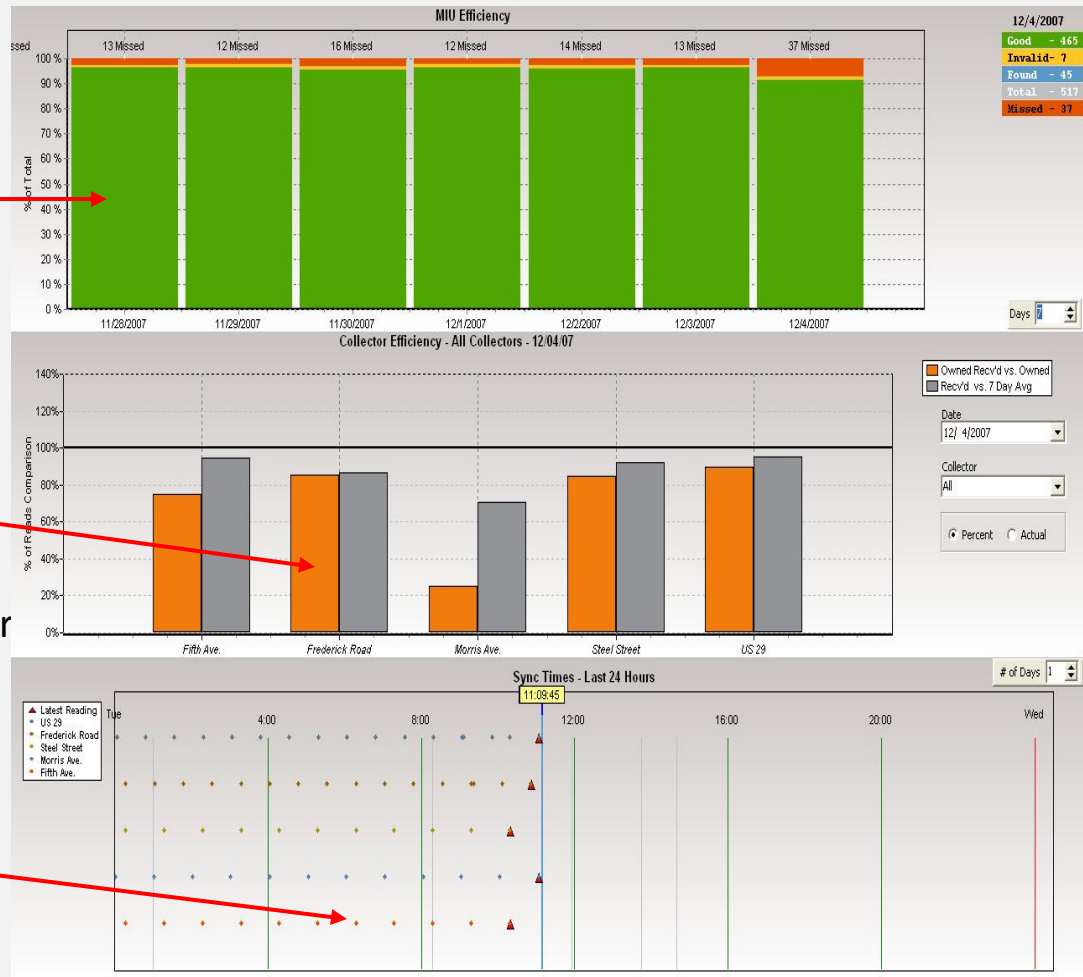

System Health Screen

- “At-a-glance” troubleshooting
- Missed Reads 103
- Collector down
- Collector failed to sync with Host at 2:00PM Monday

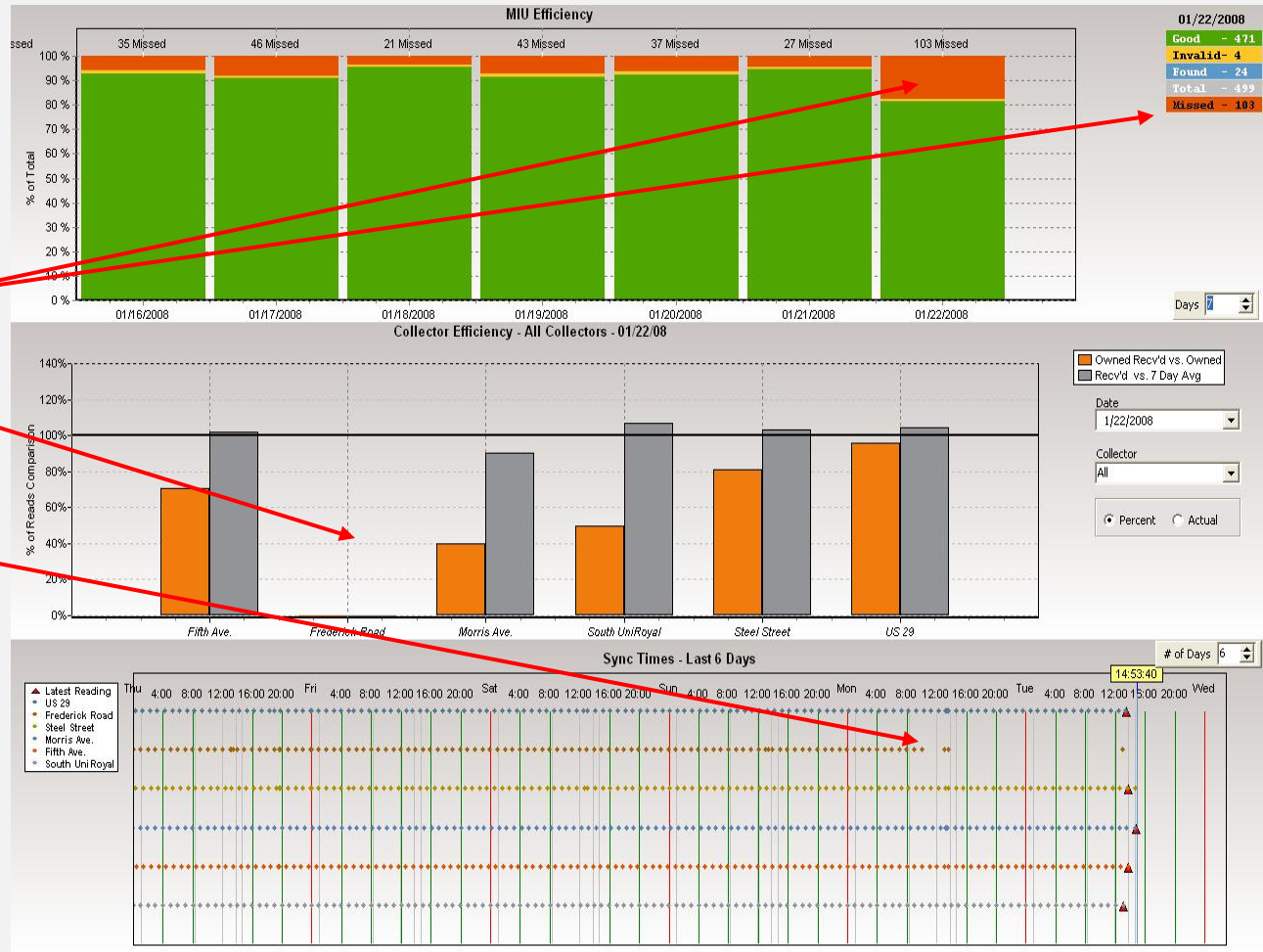

AMI Host Software – Customer Service Screen

- Group prefix – “transfer” pulls up all transfer meters

- Usage graph – Daily profile

The screenshot displays the AMI Host Software Customer Service interface. It is divided into several sections:

- Search String:** "transfer".
- MIU - Status - Type:** 110003914-Y-H.
- Table:** A list of meters with columns for PremiseID, Name, and Address. The meter with PremiseID 110003068 is selected.
- Configuration Panel:** A detailed view of the selected meter's configuration, including MIU ID (110003914), MIU Type (PIT), MIU Hardware, MIU Firmware, MIU Install Date (07/09/2007), MIU Owner (1), Comment, MIU Active (Y), Meter Number, Meter Type (Hi), Meter Manufacturer, Meter Install Date (07/09/2007), Register Manufacturer, Register Multiplier (10), Register Install Date (07/09/2007), Register Unit of Measure, and Register Number Of Dials (6).
- Usage Graph:** A bar chart titled "Daily usage for MIU 110003914" showing daily usage from 10/22/07 to 12/02/07. The y-axis ranges from 0 to 1,200,000. A red arrow points to a specific bar in the graph.
- Readings Table:** A table showing a list of readings with columns for MIU ID, Date, Reading, Leak, RevFlow, Collector, RSSI, Owner, and Received. The table shows multiple readings for the selected meter over time.

How Does Daily Meter Readings Benefit Customer Service?

- Example
- 10,000 meter Utility
- Hourly Readings – ***Every Day***
- Currently reading monthly – 120,000 reading/per year

- With AMR Customer Service will have hourly meter reading data
- One customer - 8,760 meter readings/per year
- All customers - 87,600,000 meter readings/per year

24-Hour Usage/Consumption Profile

- Hourly usage is presented in graphical form

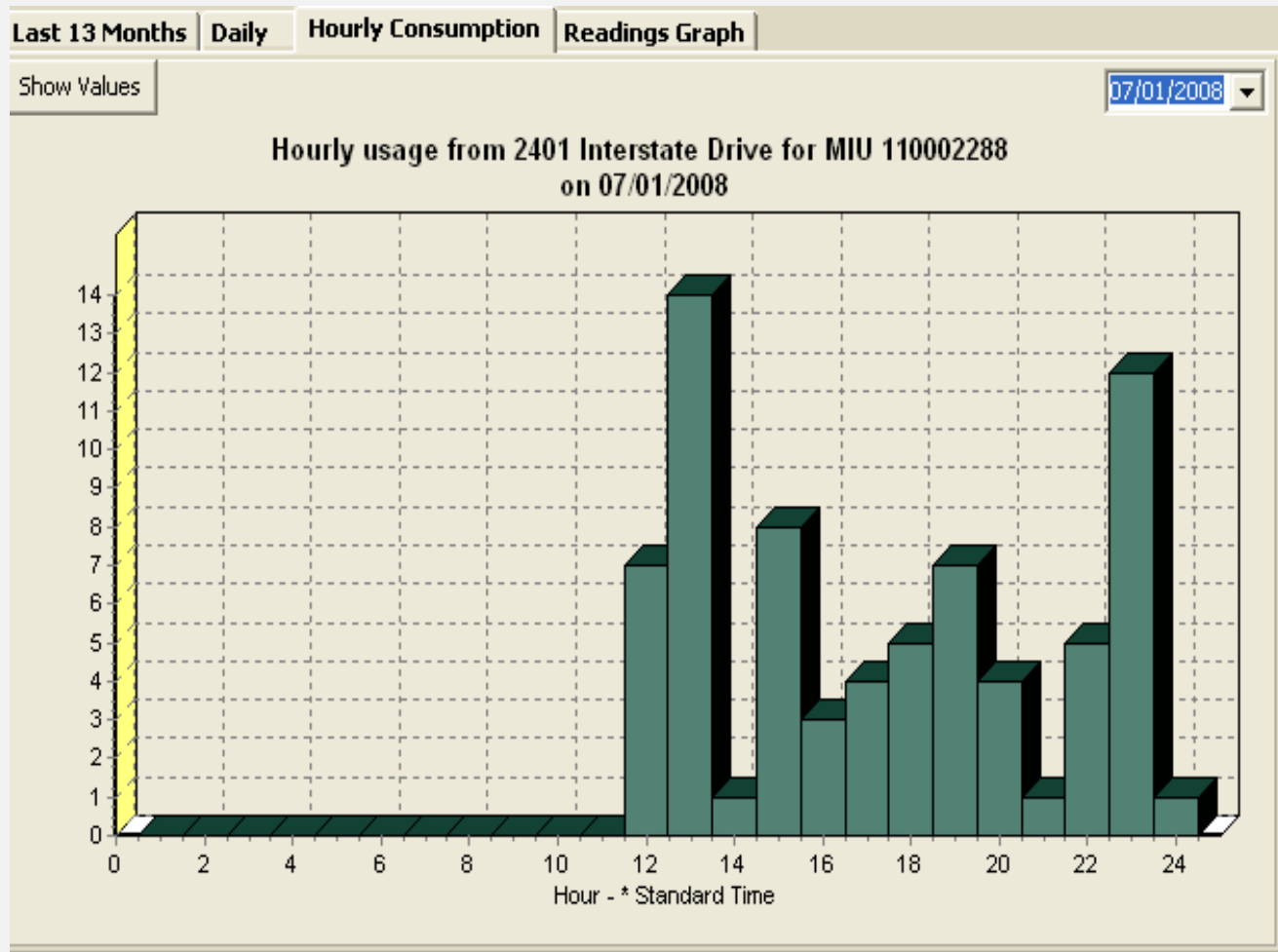

24-Hour Usage/Consumption Profile

- Hourly usage data is also presented as consumption totals in a table by hour

Readings		Daily Consumption	Hourly Consumption							Alarms	Configuration
	Date	Consumption	Hour 1	Hour 2	Hour 3	Hour 4	Hour 5	Hour 6	Hour 7		
▶	07/14/2008	101000	0	3000	6000	7000	8000	2000	0	^	
	07/13/2008	165000	820	0	820	0	820	4140	5800		
	07/12/2008	165000	820	0	820	0	820	4140	5800		
	07/12/2008	165000	820	0	820	0	820	4140	5800		
	07/12/2008	93000	0	0	930	0	0	0	0		
	07/11/2008	244000	19420	14560	21850	6060	8490	7280	25490		
	07/10/2008	244000	19420	14560	21850	6060	8490	7280	25490		
	07/10/2008	208000	14650	4500	4500	6760	1120	13520	12400		
	07/09/2008	206000	5670	5670	3400	1130	6810	5670	1130		
	07/08/2008	477000	72810	72810	72810	72810	72810	12550	2510		
	07/07/2008	1675000	67000	67000	67000	67000	75370	75370	75370		
	07/06/2008	1586000	64080	64080	64080	64080	64080	64080	64080		
	07/05/2008	1578000	71360	71360	71360	63430	63430	63430	63430		
	07/04/2008	1627000	73210	65080	65080	65080	65080	65080	65080		
	07/03/2008	1627000	73210	65080	65080	65080	65080	65080	65080		
	07/03/2008	1627000	73210	65080	65080	65080	65080	65080	65080		
	07/01/2008	1624000	65940	65940	65940	74190	74190	82430	74190		
	06/30/2008	1675000	66330	74630	74630	82920	91210	82920	74630		
	06/29/2008	1693000	70720	70720	79560	79560	4420	88400	79560	▼	

Mapping

- Identify areas of concern or interest such as:

- Leak
- Reverse Flow
- Zero Consumption
- Soft-Disconnect
- Not Heard From
- Major Reverse Flows

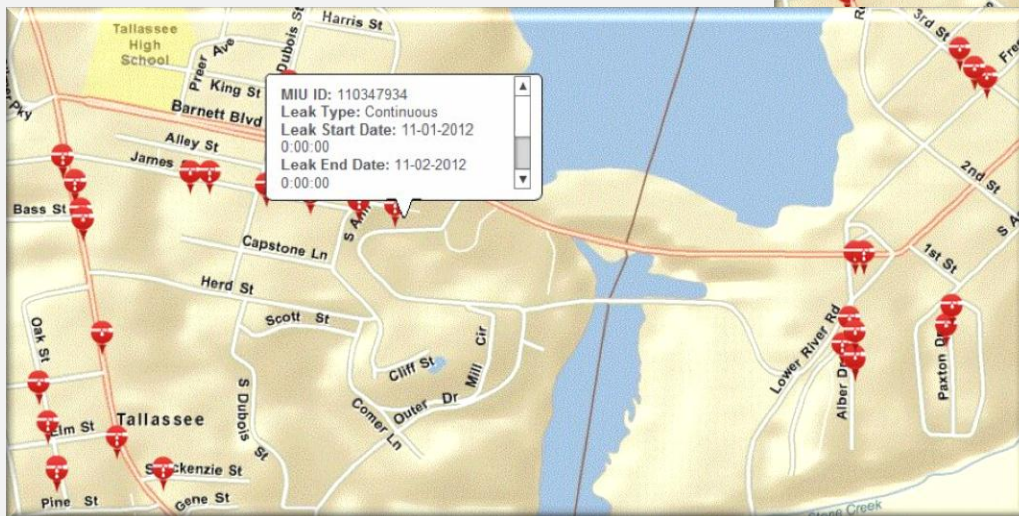
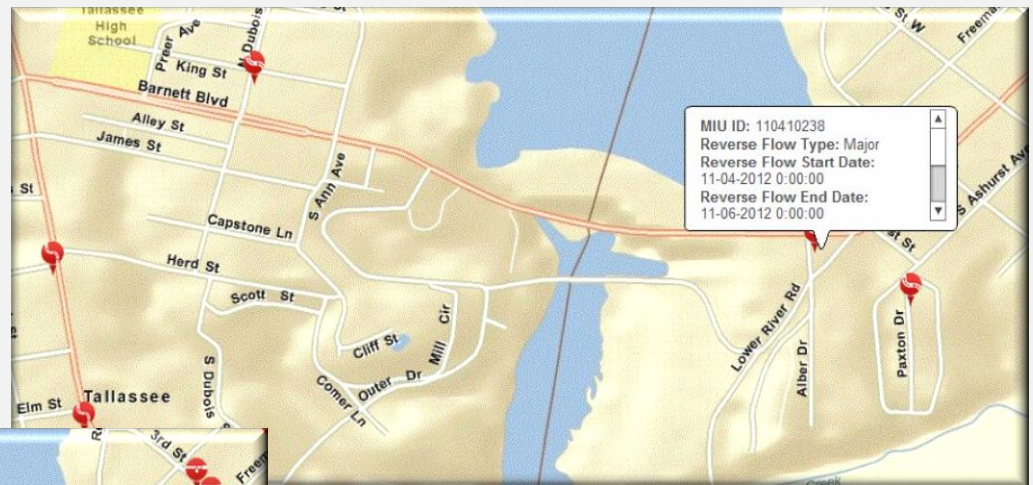

- Missed
- Inactive with Usage
- Collector Types
- Collector Status
- All Endpoints
- Continuous Leaks

Customer Service Web Interface

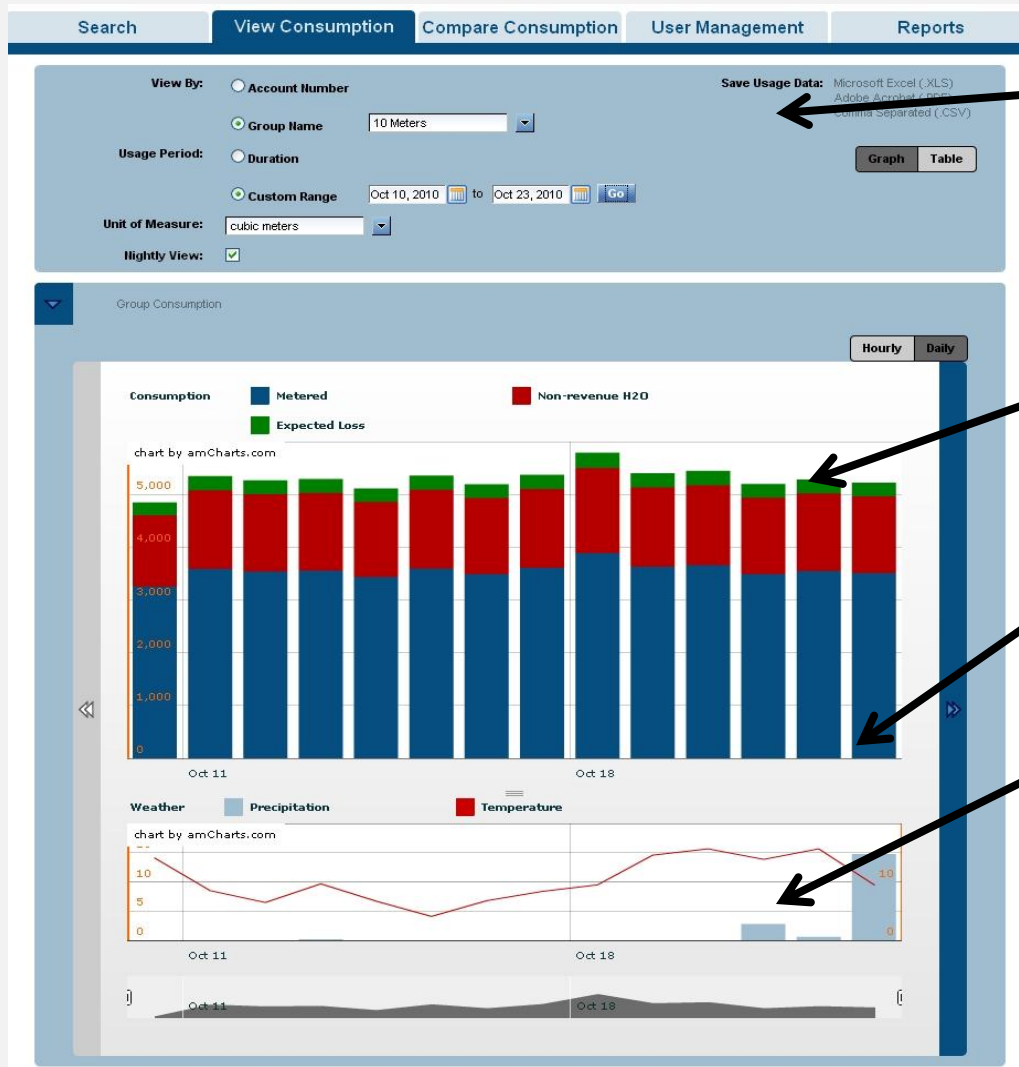

Data Controls

Data Detail

Temperature and Precipitation

Long-term View

Customer Service Web Interface – Customer Example

- Customer leak starts
- E-Coder® intermittent leak alert triggered
- E-Coder continuous leak alert triggered
- Customer repairs leak
- E-Coder intermittent leak alert triggered
- Usage back to normal

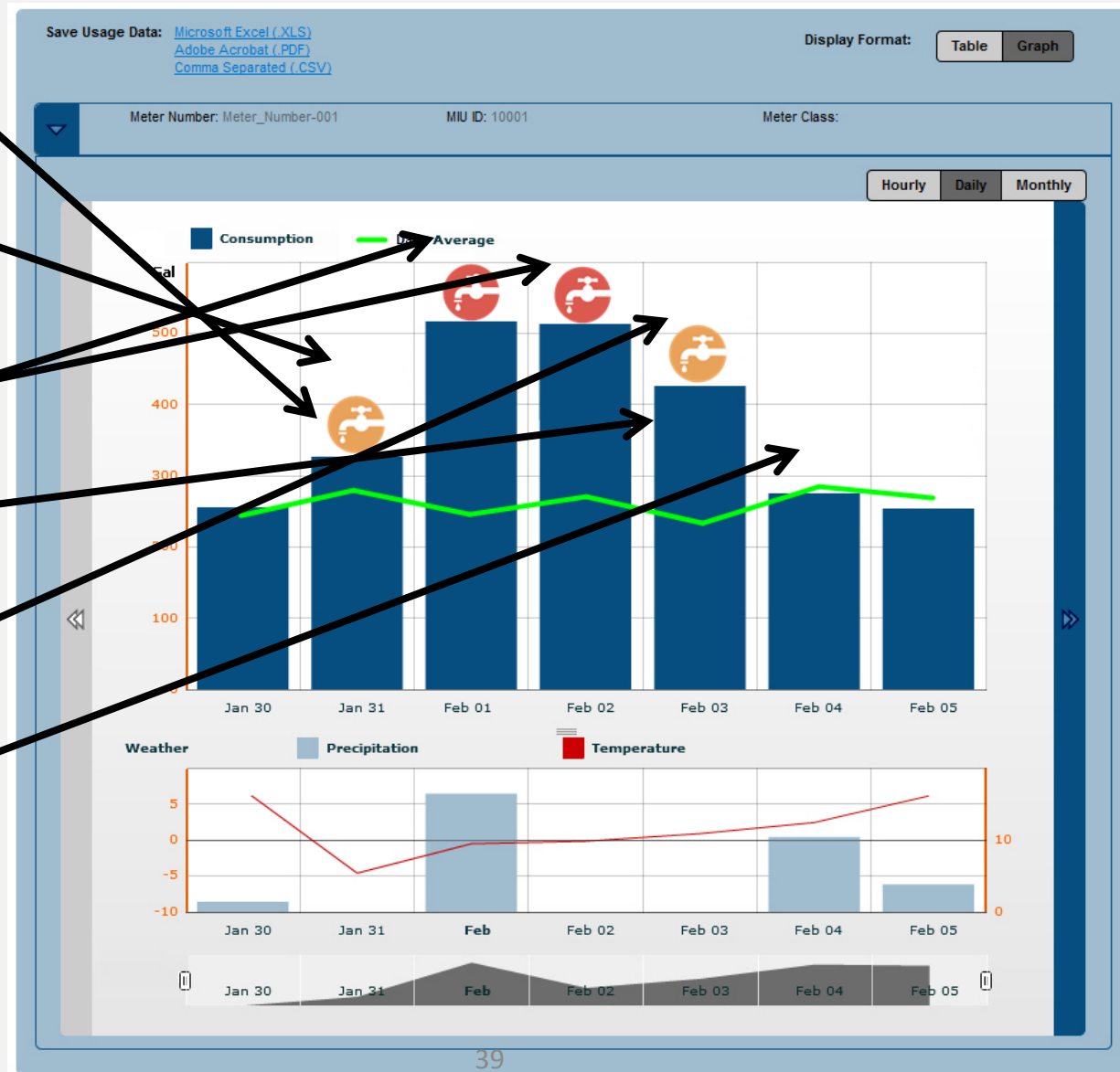

Is AMR Right for You?



Things to Consider

- Evaluate what type of system works best in for YOUR Utility
- Review a long-range plan with various departments (Distribution, Customer Service, IT)
- Determine if you want to use the existing assets (meters & existing mobile RF) or replace everything
- Compare the system offerings (Not all are the same)
- Communicate with other Utilities who have systems installed
- Determine if you have personnel to evaluate the additional data

Roundtable

- What type of meter do you use?
- How old is the system?
- Describe the meter reading process
- Describe the billing process
- What is your greatest challenge?
- Has Funding projects been a challenge?
- What have you done that has worked particularly well?
- What questions do you have for other utilities?

QUESTIONS?

Ray Schwarz- Sales Manager
Neptune Equipment Company

330 283-3828

rschwarz@neptuneequipment.com