

Mixing & Agitation:

Pulsed Air Mixing Technology
Increases Operating Efficiency
& Reduces Maintenance Costs

Overview

What is 'Pulsed Air Mixing'?

How does Pulsed Air Mixing
Technology work?

Features & Benefits of the Pulsed Air
Mixing Process

Hardware & Equipment

Pulsed Air Mixing Application Montage

What is 'Pulsed Air Mixing'?

a.k.a 'large bubble mixing'

“Pulsed air mixing” is a *process* developed and patented by Richard E. Parks of Pulsair Systems, Inc.

The process is ‘*the sequential release of compressed air or gas at the bottom of a tank, vessel, basin, etc., for the purpose of creating circulation and mixing*’.

How does Pulsed Air Mixing Technology work?

Measured amounts of high pressure air/gas are injected ["pulsed"] under flat round discs called accumulator plates installed on the tank bottom.

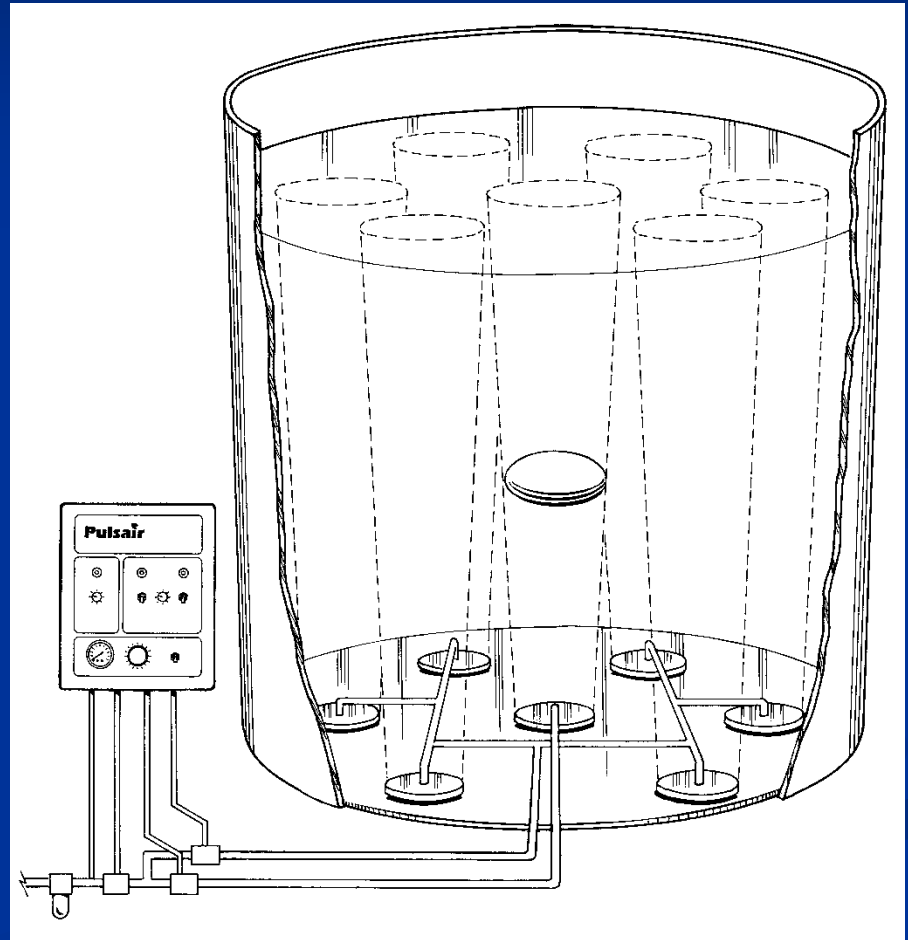

“The Bubble” – Part 1

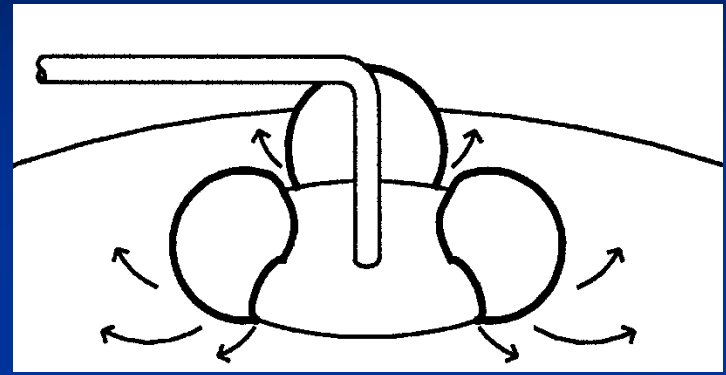
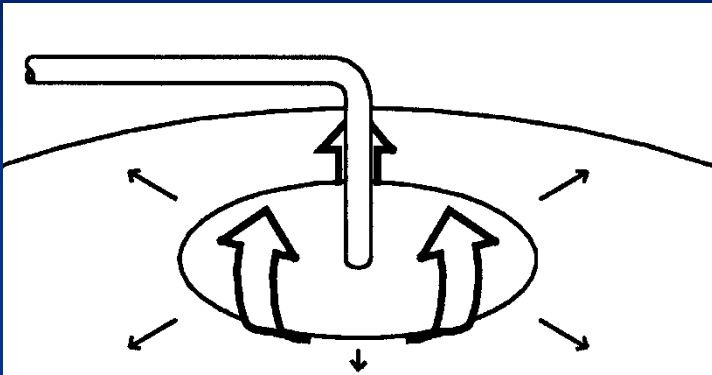

This sudden release of air/gas shocks the liquid, setting the molecules in motion.

As the air/gas “squeezes” out between the plate & tank floor, it sweeps out the heavier liquids & solids.

“The Bubble” – Part 2

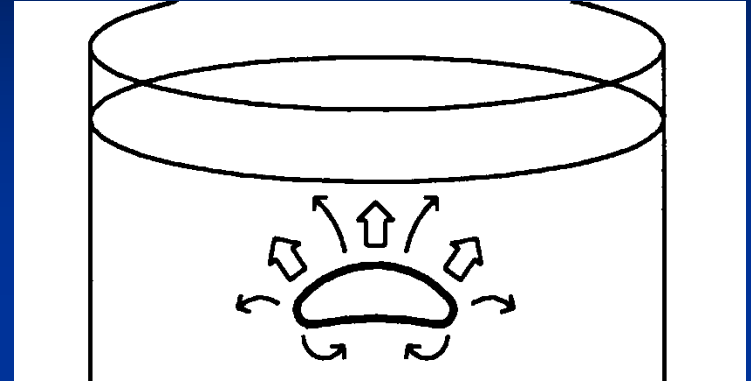
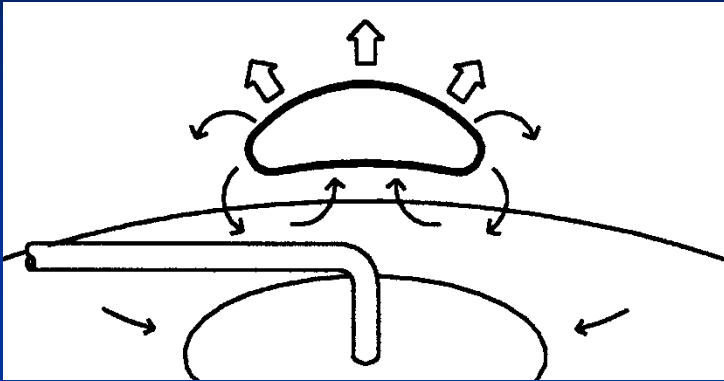

Immediately the air/gas “accumulates” above the plate into a single very large oval shaped bubble.

As the bubble rises to the surface, a vacuum is created that pulls the heavier bottom liquids and solids up with it.

“The Bubble” – Part 3

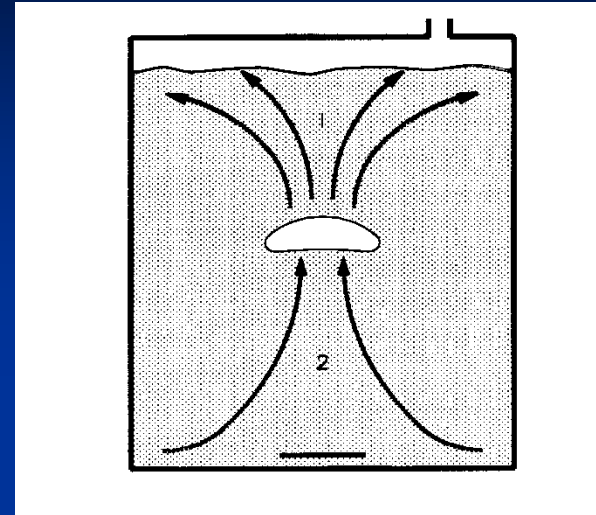
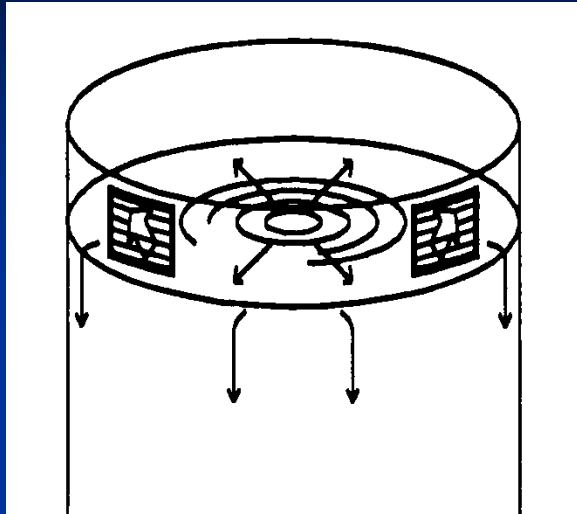

As the bubble rises it also pushes the liquid above it up and out toward the tank perimeter.

The liquid moves toward the sides of the tank and travels down the tank wall to the bottom.

“The Bubble” - Part 4

The process of sequentially releasing the bubbles at timed intervals creates immediate vertical circulation.

By strategically locating the pulse points and accumulator plates on the tank floor, virtually 100% of the tank's contents are involved.

The extremely low surface area/volume ratio and short residence time prevents any meaningful transfer between bubble and liquid, and vice versa.

Managed Compressed Air

- I. Pulse Rate** – pulse frequency, or number of pulses per minute – set at the controller
- II. Injection Time** – pulse duration, or how long the injection valve is open during the pulse – set at the controller
- III. Injection Pressure** – the pressure in psi of the pulse when it goes into the tank – set at the regulator inside the valve cabinet

Managed Compressed Air

Pulse Rate – relates to ‘mixer speed’, or the speed of rotation of the liquid; there should never be more than one bubble in the liquid column at a time

For viscous materials, the pulse rate should be slower because the bubble takes longer to rise through the liquid

A faster pulse rate can mix the tank faster, but consumes more air

Managed Compressed Air

Injection Time – relates to pipe length between the injection valve & plate(s), & the number of plates in a manifold

For very long pipe runs or multiple plates in a manifold, the injection time can be increased

In general, the shortest injection time that gets the job done should be used. Longer times consume more air & destroy the integrity of the bubble

Managed Compressed Air

Injection Pressure – relates to the power or energy of each pulse

For heavy slurry materials or high viscosity liquids, use a higher injection pressure

For light materials, a lower injection pressure should be used

Higher injection pressures consume more air

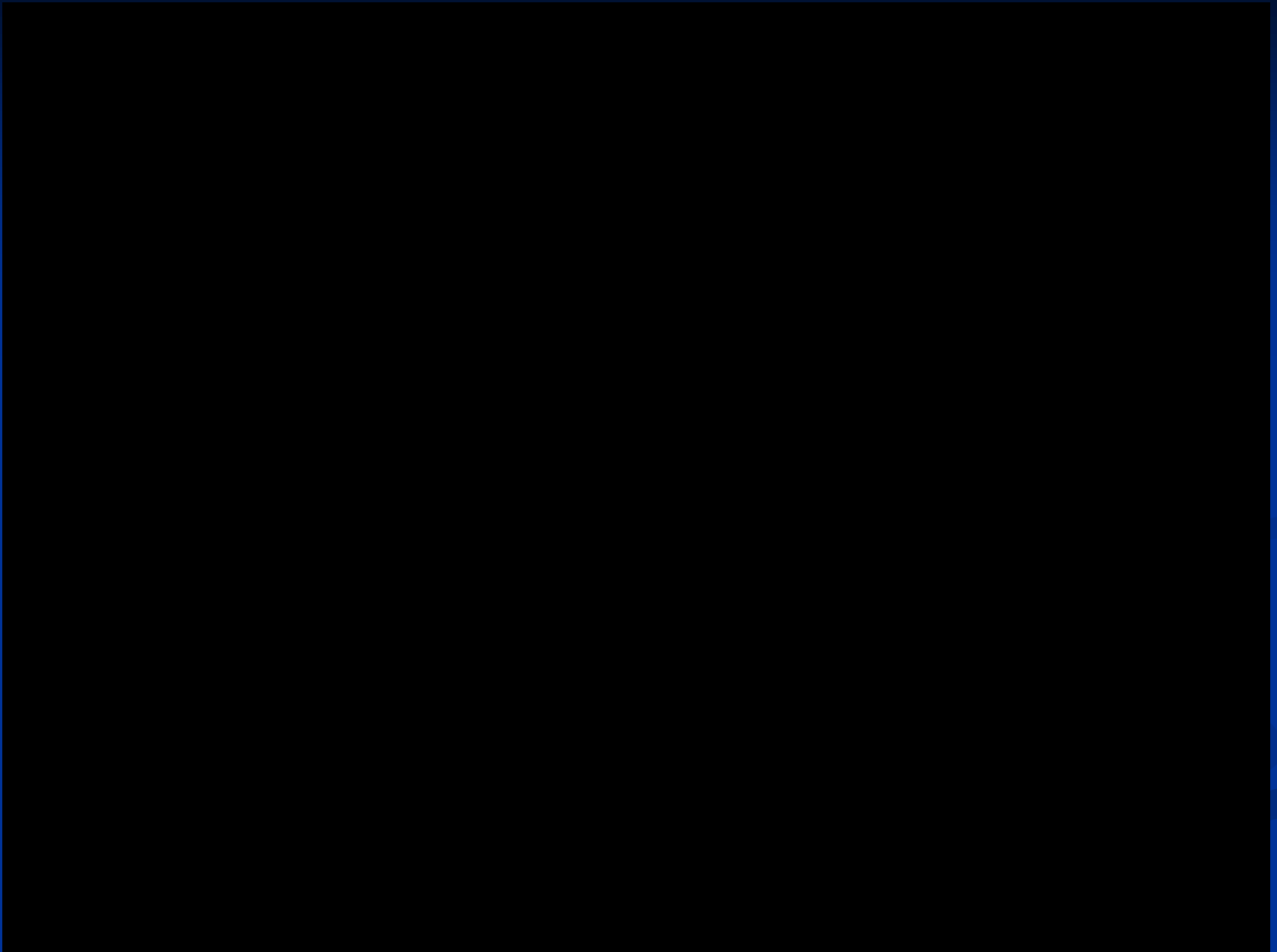

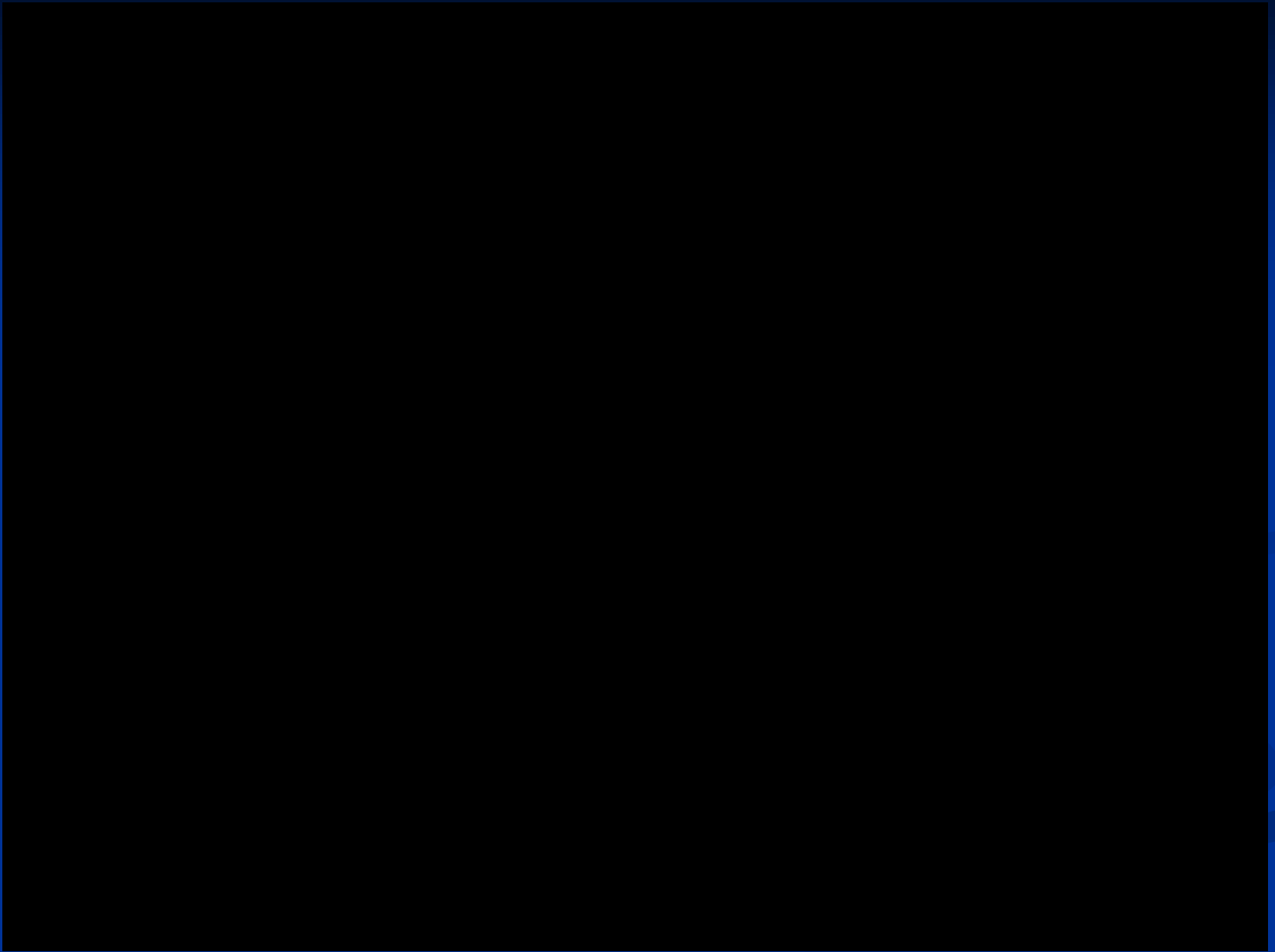

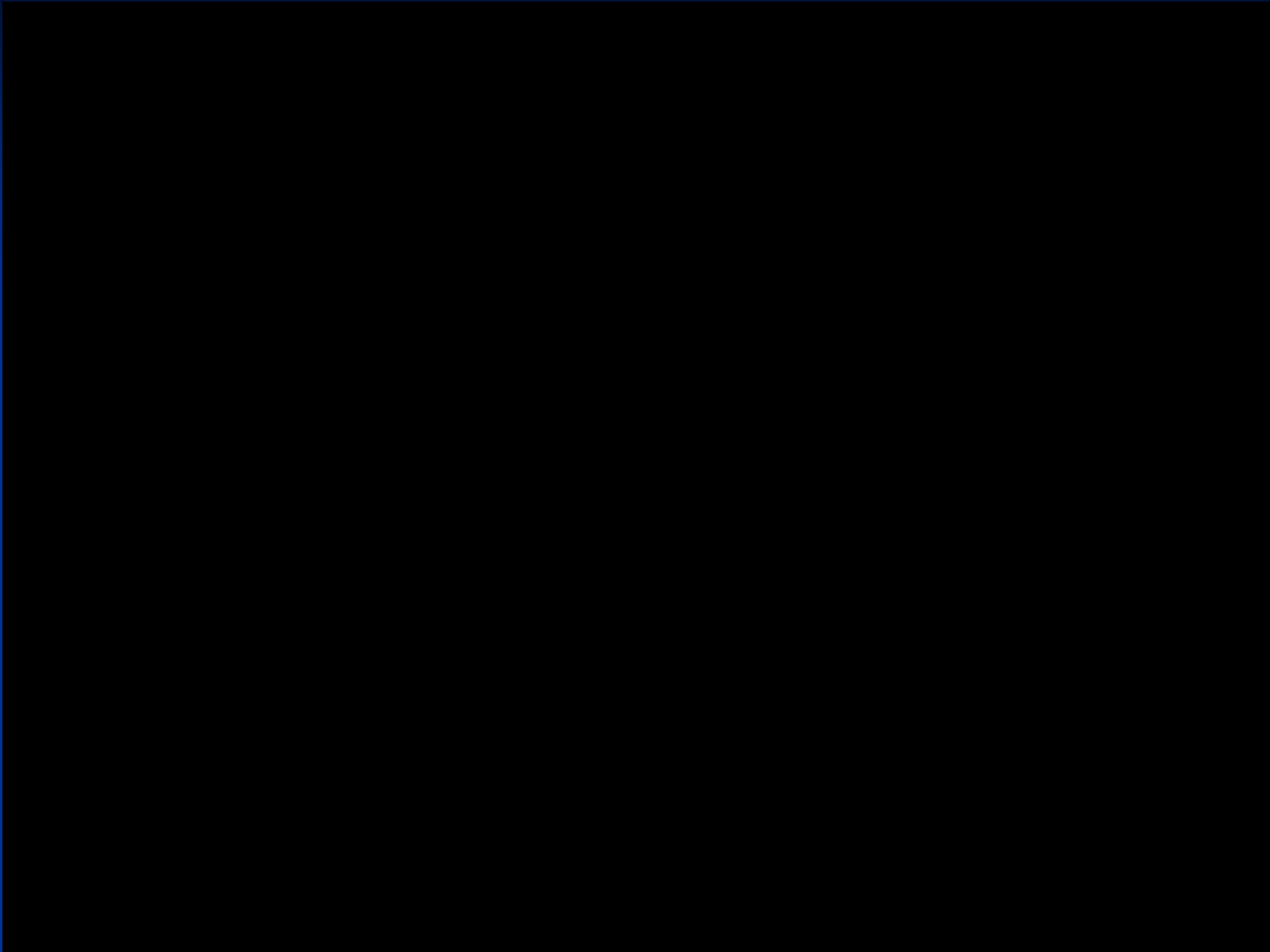

**What are the features of the
Pulsed Air Mixing process?**

Why use it?

Features of Pulsed Air Mixing

- It is not limited by tank shape, configuration, or size.
- Large diameter tanks, square, rectangular, or horizontal tanks are no problem for the Pulsed Air Mixing process.

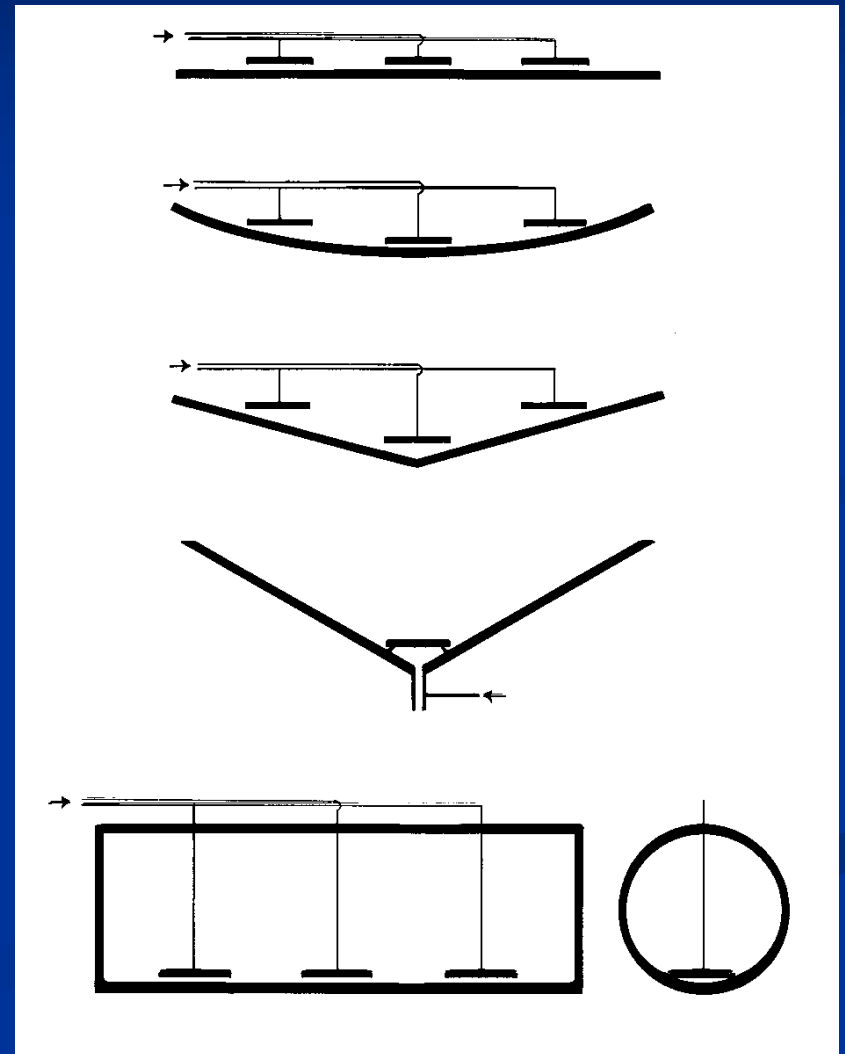

Features of Pulsed Air Mixing

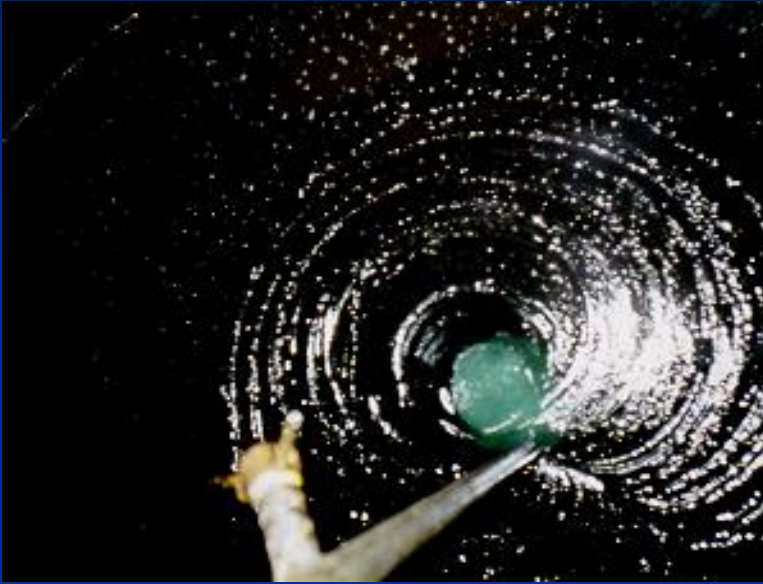

- It can mix a wide range of liquid viscosities, specific gravities, and slurries.
- The photo on the left is tar sludge
- The photo on the right is a high solids slurry

Features of Pulsed Air Mixing

- It operates without seals, gears, motors, shafts, or impellers.
- It is a “variable speed” mixing system.
- NO moving parts inside the tank or vessel.
- Operates on nitrogen without modification
- It is a “variable horsepower” mixing system.

Additional Features

- By harnessing gravity, it is a highly efficient mixing system.
- The larger the tank, the higher the efficiency of the Pulsed Air Mixing process.
- Pulsed Air Mixing is very low shear.
- Shear sensitive products, such as complex polymers and food products, can be mixed without fear of degradation.

What are the benefits of Pulsed Air Mixing?

- Significant process improvement
- Improvements in operating efficiency
- Reduction in maintenance costs

Process Improvement

■ **Faster mixing**

- 30% - 50% faster than mechanical mixing
- 75% - 90% faster than conventional air mixing, sparging, or recirculation

■ **Better mixing**

- “Bottom up” mixing pattern is more thorough, involving 100% of the tank’s contents
- Sequential mix pattern provides better uniformity

Operating Efficiency

- **Uses less compressed air/gas**
 - Typically 40 to 60 times less air/gas than sparging
- **Uses less energy**
 - 25%-75% less energy than mechanical mixing
 - 10HP [5-30 SCFM] can mix a 1 million gallon tank
- **Mixes at any liquid depth**
 - No minimum liquid depth is required as with mechanical mixers

Continue..

- Able to adjust to a wide range of varying conditions in the same tank, providing more consistent results
- Easy to retrofit into existing tanks & basins – no “T” beams, support bracing, or baffles are required

How does Pulsed Air Mixing reduce maintenance costs?

- **NO moving parts inside the tank or basin**
 - Nothing to wear out or break
 - Only the product moves inside the tank
- **Very little maintenance required**
 - Periodic filter changes and injection valve maintenance
 - All components are **OUTSIDE** the tank
 - No seals, shafts, gears, or motors to leak or maintain
- **Keeps tank floors & basin bottoms clean**

Hardware & Equipment

Typical Components

- Controller
- Electro-pneumatic Interface – EPI
- Filter & regulator
- Injection valves
- Accumulator Plate(s)
- Compressed air/gas source

Control system

Example: Pulsair PPC-1000

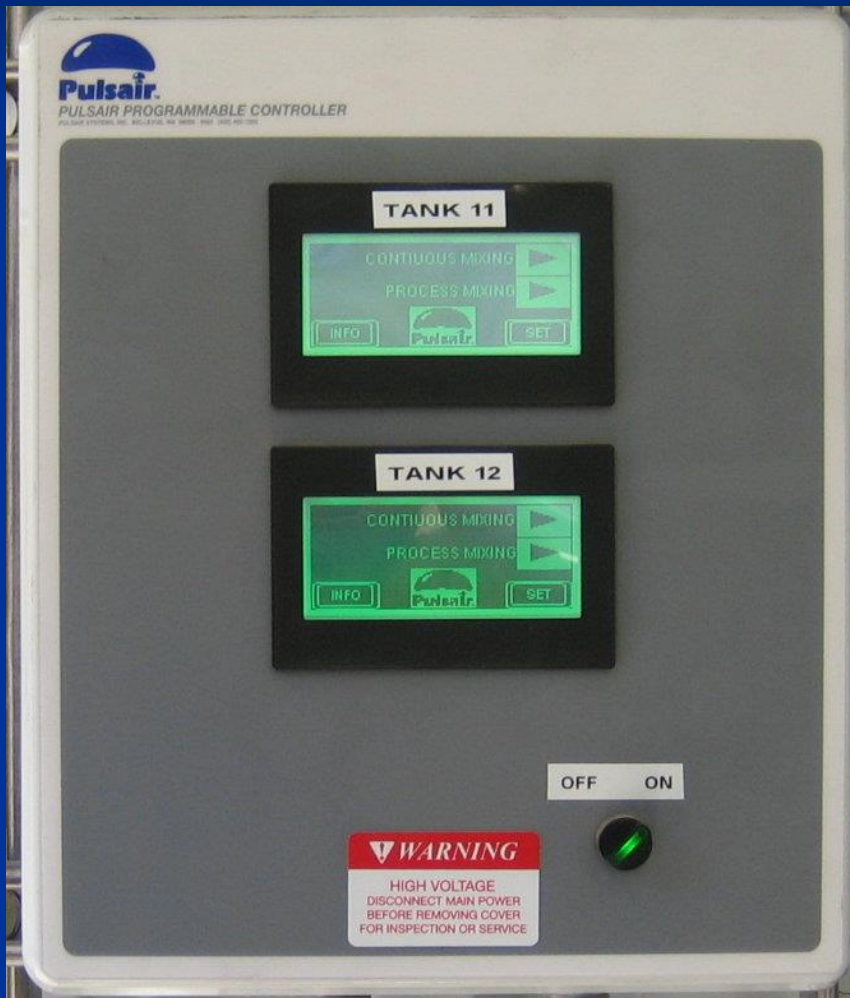

- Operates on 110VAC & less than 10 watts – output signals are 24VDC
- Operates up to two tanks, but controls an unlimited number of injection valves
- Easy to use touchscreen
- Designed to integrate with existing plant PLCs

Control System

Example: Pulsair PPC-2000 & 3000



- Fully programmable PLC based system
- Designed for multiple tank control & virtually unlimited number of injection valves
- Integrates easily with plant PLCs, DCS, or SCADA systems
- Utilizes GOT [touchscreen] for data entry

EPI

**Injection
Valves**



Regulator

Filter



Electro-Pneumatic Interface - EPI



The EPI converts electrical signals from the controller to pneumatic signals that operate the injection valves

CC-Link - EPI

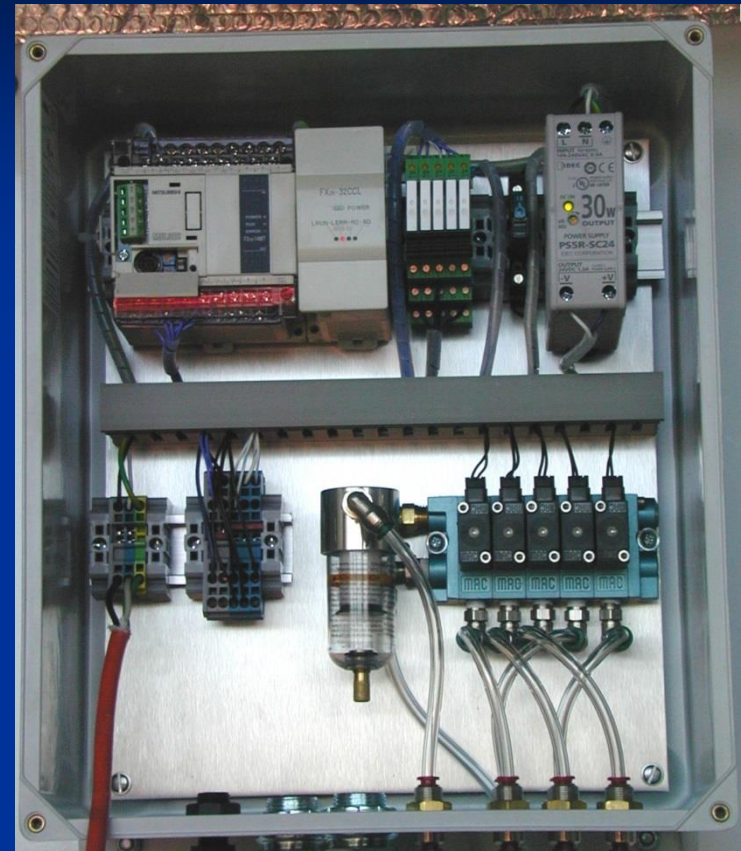

Pulsair EPI with CC-Link network module. Used with multiple tanks/many valves and long distances between valve cabinets.

Filter & Regulator



Large filters & regulators are used to keep up with the high *momentary* demand of the injection valves

Injection Valves



Injection Valves vary in size depending on the tank size, accumulator plate size, & number of accumulator plates

MAC 67 series valves have a modular design so they can be easily removed for cleaning & maintenance

Injection Valves

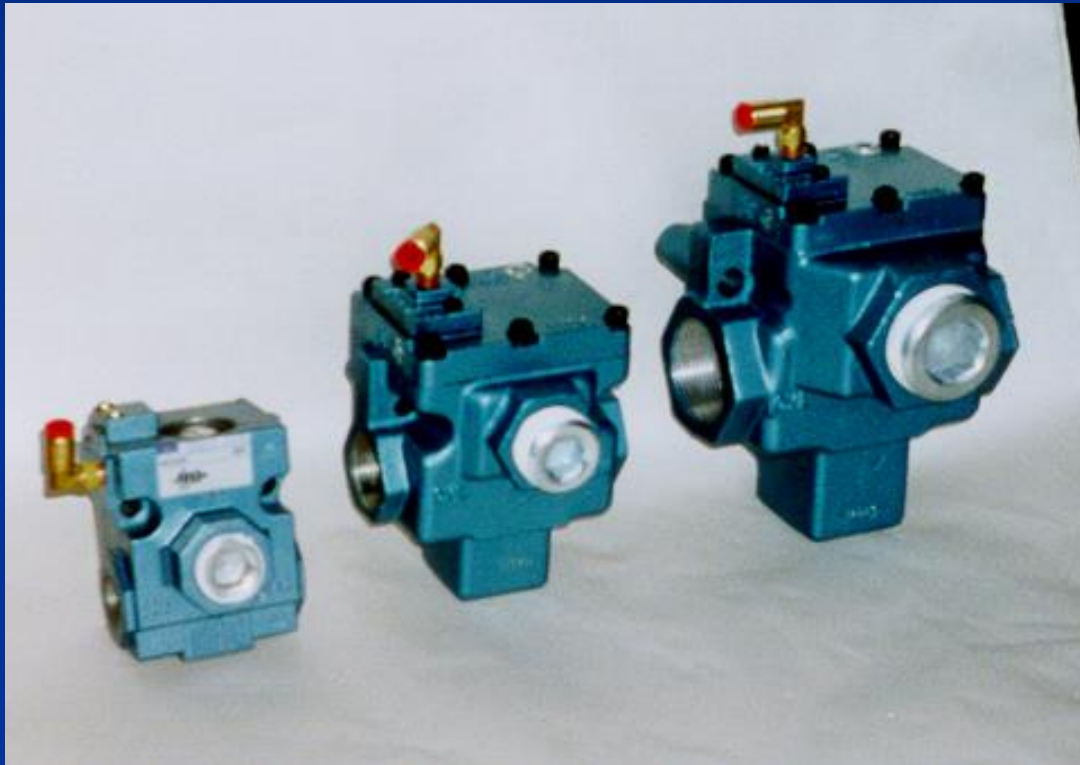

MAC 56, 57, & 58
Series valves are
also used for their
rugged design, fast
response, & long
life

Accumulator Plates



Plate for flat
bottom carbon
or stainless steel
tanks

Plates typically are
welded to the
tank floor

PVC plates are used for corrosive liquids, & for polyethylene or FRP tanks. Plates can be bolted or secured with epoxy.

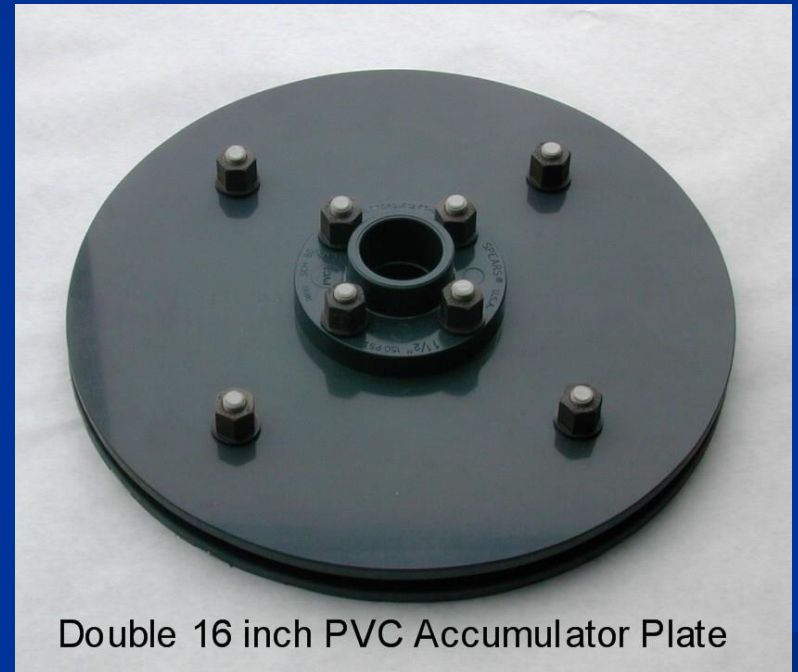
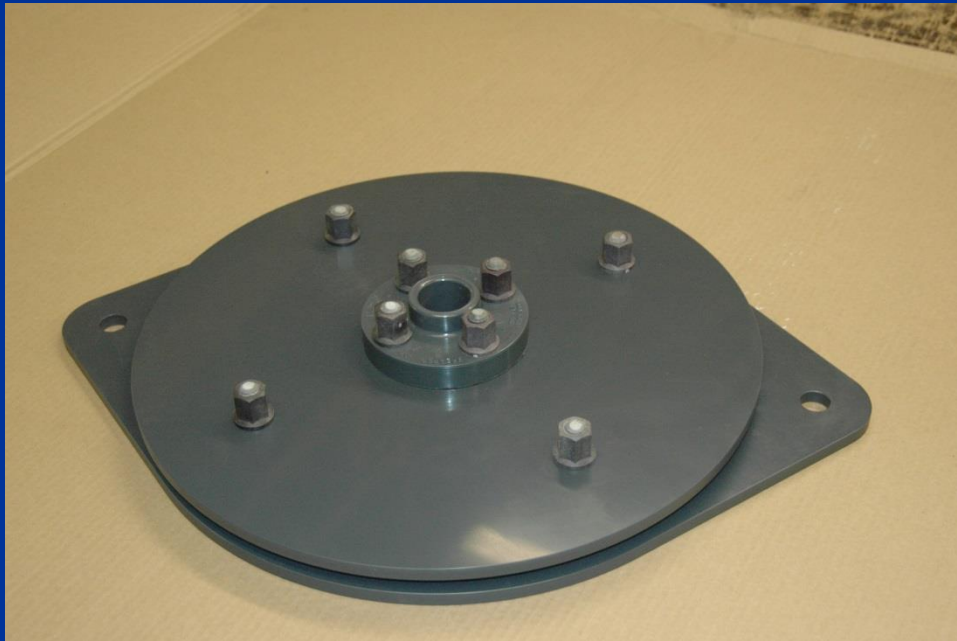

Double 16 inch PVC Accumulator Plate

Plates designed for sanitary or NSF applications are available





Carbon steel plates & piping on the floor of a 10ft diameter lube blending tank.



Accumulator plates on the floor of a 100ft diameter fuel storage tank

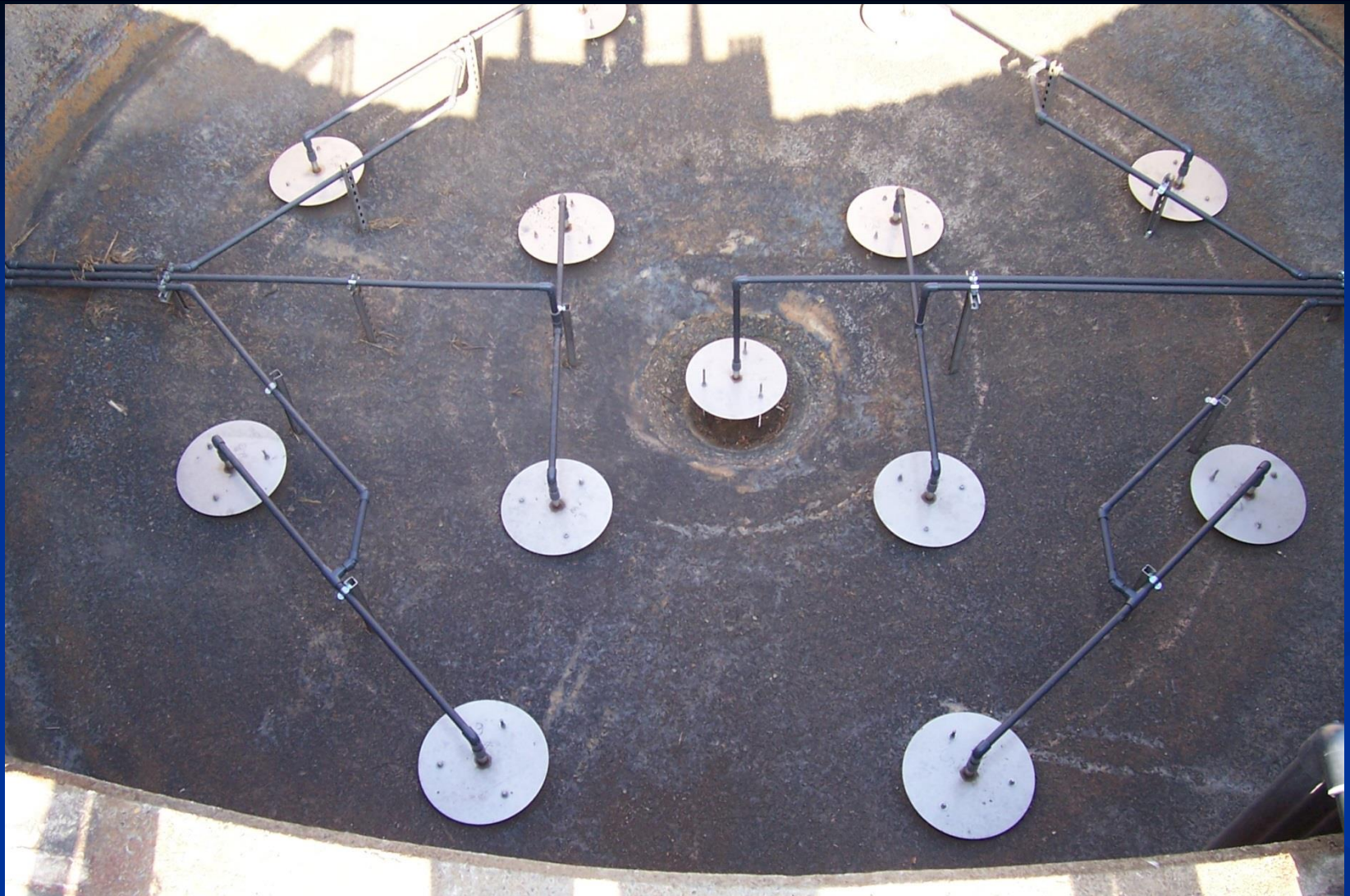

SS plates bolted to the concrete floor of a 28ft diameter
sludge tank



SS accumulator plates bolted to the floor of a 125ft diameter sludge tank



PVC “double” plates secured with epoxy to the floor of an FRP tank.



SS “double” plates bolted to the floor of an anoxic zone in an aeration basin

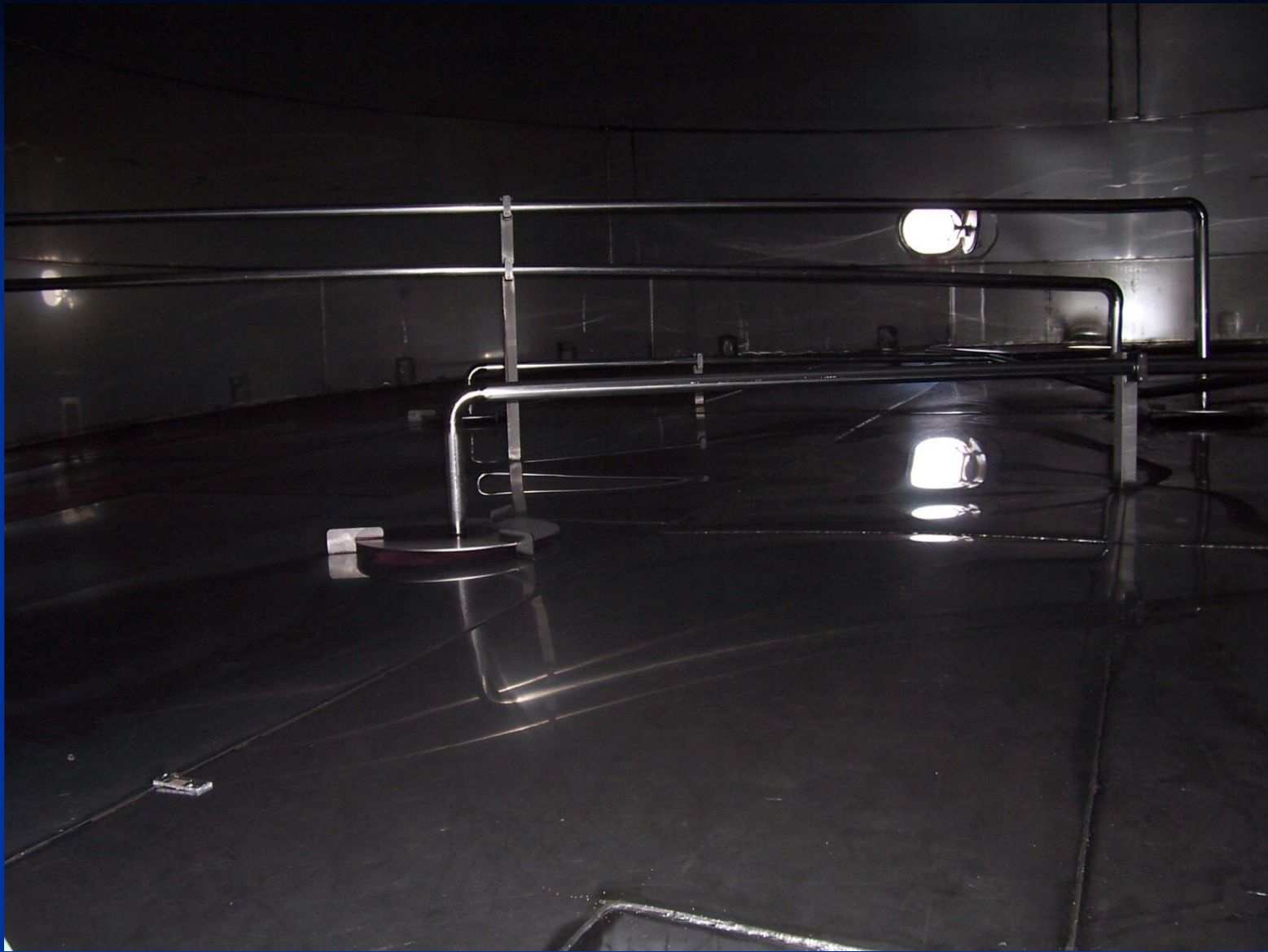

SS plates welded to the floor of a 100,000 gallon wine
blend tank

Valve Enclosure Installation



Hardware enclosures are mounted close to the tank to minimize piping runs & improve performance

On the left, the enclosures are mounted on top of the tank; on the right they are at ground level



SS secondary enclosures mounted above anoxic zones at a municipal WWTP



Controllers can be mounted at almost any location that is convenient for operating the tank or tanks





The controller can be mounted inside the valve enclosure with the F/R & injection valves.

Compressed Air/Gas Source



A Word About Compressed Air

- Wet dirty air is the ‘enemy’ of a Pulsed Air Mixing system. All [Pulsair] systems are equipped with a main airline filter. Engineered systems include a 5-micron particulate filter in the EPI. This is sufficient for many applications.
- However, in areas of high humidity or high moisture, *a dryer should be installed upstream of the Pulsed Air Mixer.*
- Damage to a Pulsair mixer from wet dirty air is NOT covered under the warranty.

Applications

Pulsed Air Mixing application Montage

Wastewater Treatment

Industrial

Municipal

Industrial Wastewater Battery Recycling



- Tank is 30ft diameter X 20ft high, 105,000 gallons
- Application is solids suspension & pH equalization of wastewater
- System controller is in a nearby building
- Valve enclosure is adjacent to the tank

Industrial Wastewater Landfill in NJ



- Tank is 14ft diameter X 26ft high, 30,000 gallons
- Application is pH equalization of influent ground water prior to treatment
- System controller is in a nearby building
- Valve enclosure is on top of the tank

Industrial Wastewater Hides & Tannery Processing Plant



- Application is treatment of primary sludge from hides & tannery processing
- Two adjacent 32ft diameter X 20ft high concrete tanks
- Sludge contains 3" X 3" pieces to fines
- Pulsed Air Mixing replaced an eductor system that left several *feet* of solids on the floor of each tank

Industrial Wastewater Slurry Mixing



- Quarry wastewater
- Three tanks are 15ft diam X 20ft high, slurry is ~50% solids
- Pulsed Air Mixing system replaced a 60HP top entry mechanical mixer in each tank
- The Pulsed system uses ~20HP of compressed air for all three tanks & there is no in-tank maintenance...with better mixing

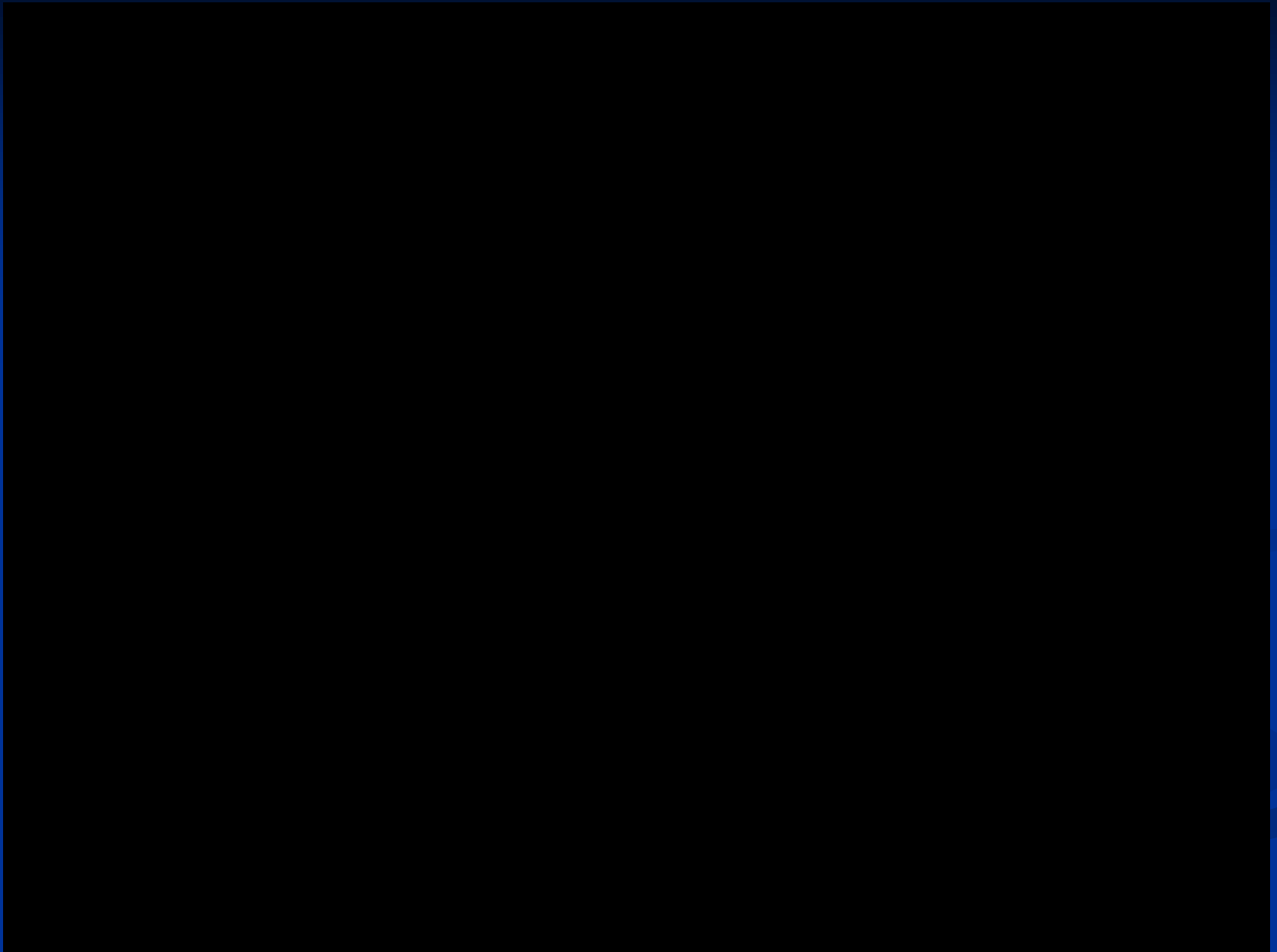

10/10/2010

Municipal Wastewater Sodium Hypochlorite

- A city in NC
- Two adjacent FRP hypochlorite tanks
- Pulsed Air mixes the tanks to prevent stratification & crystallization
- Two additional cities in NC also do hypochlorite mixing



Municipal Wastewater Activated Sludge



- A city in NC
- Two 42ft diameter concrete sludge tanks
- Sludge contains 3.5% solids
- Results: lower odor, lower chemical/polymer use, lower energy costs, & better, more consistent mixing compared to mechanical mixers

Municipal Wastewater Sludge Mixing

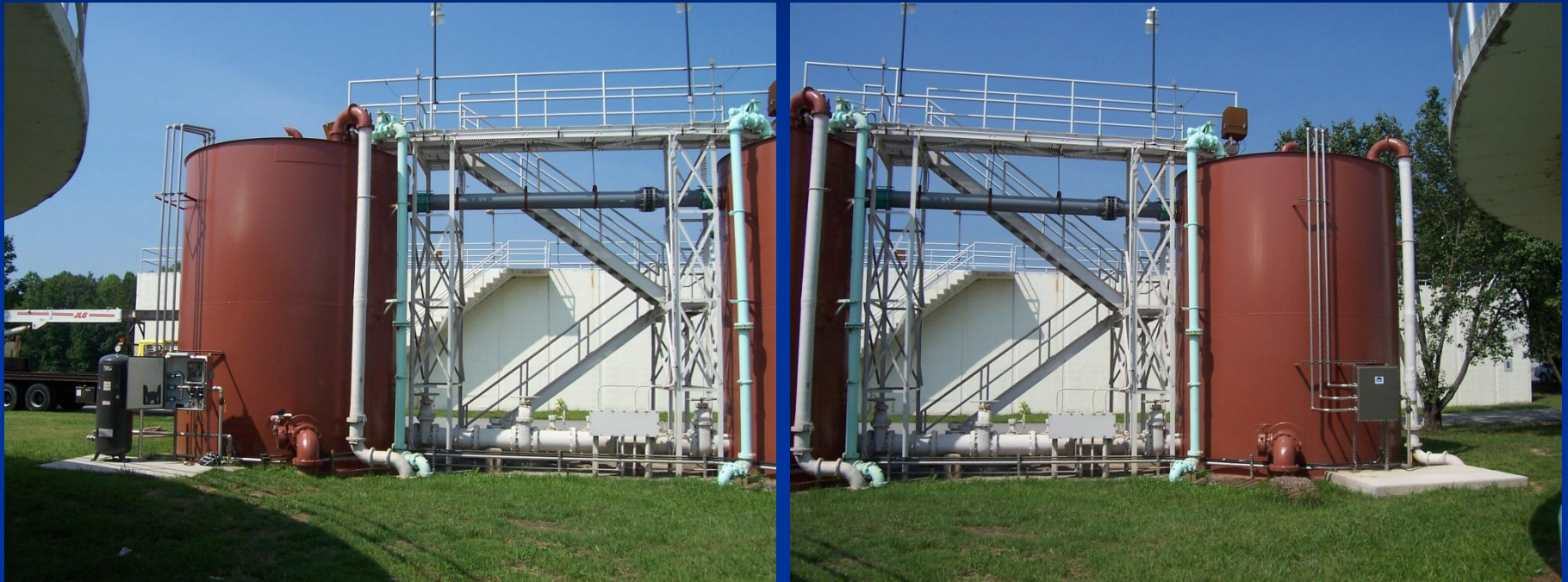

Two adjacent municipal sludge tanks

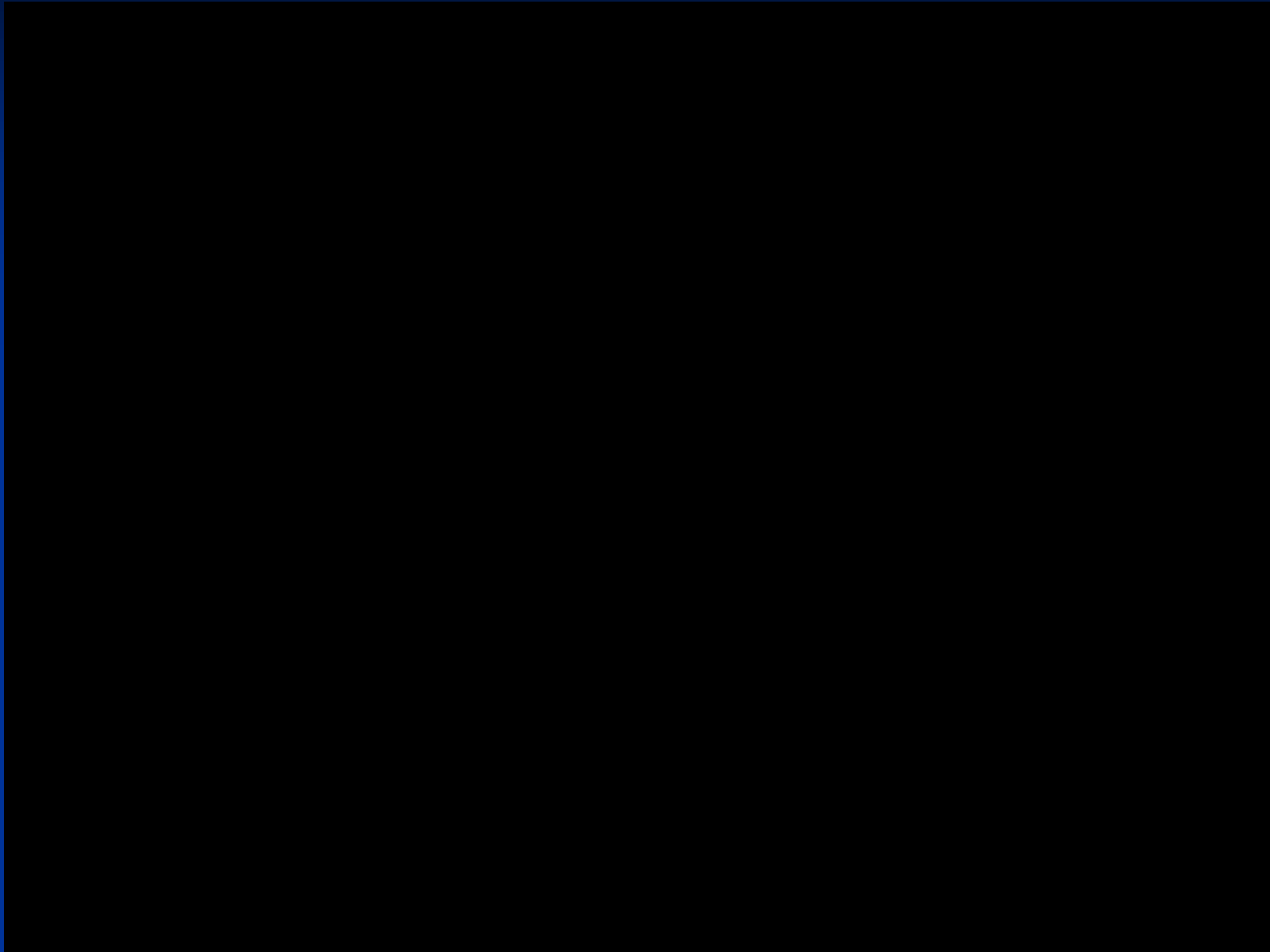

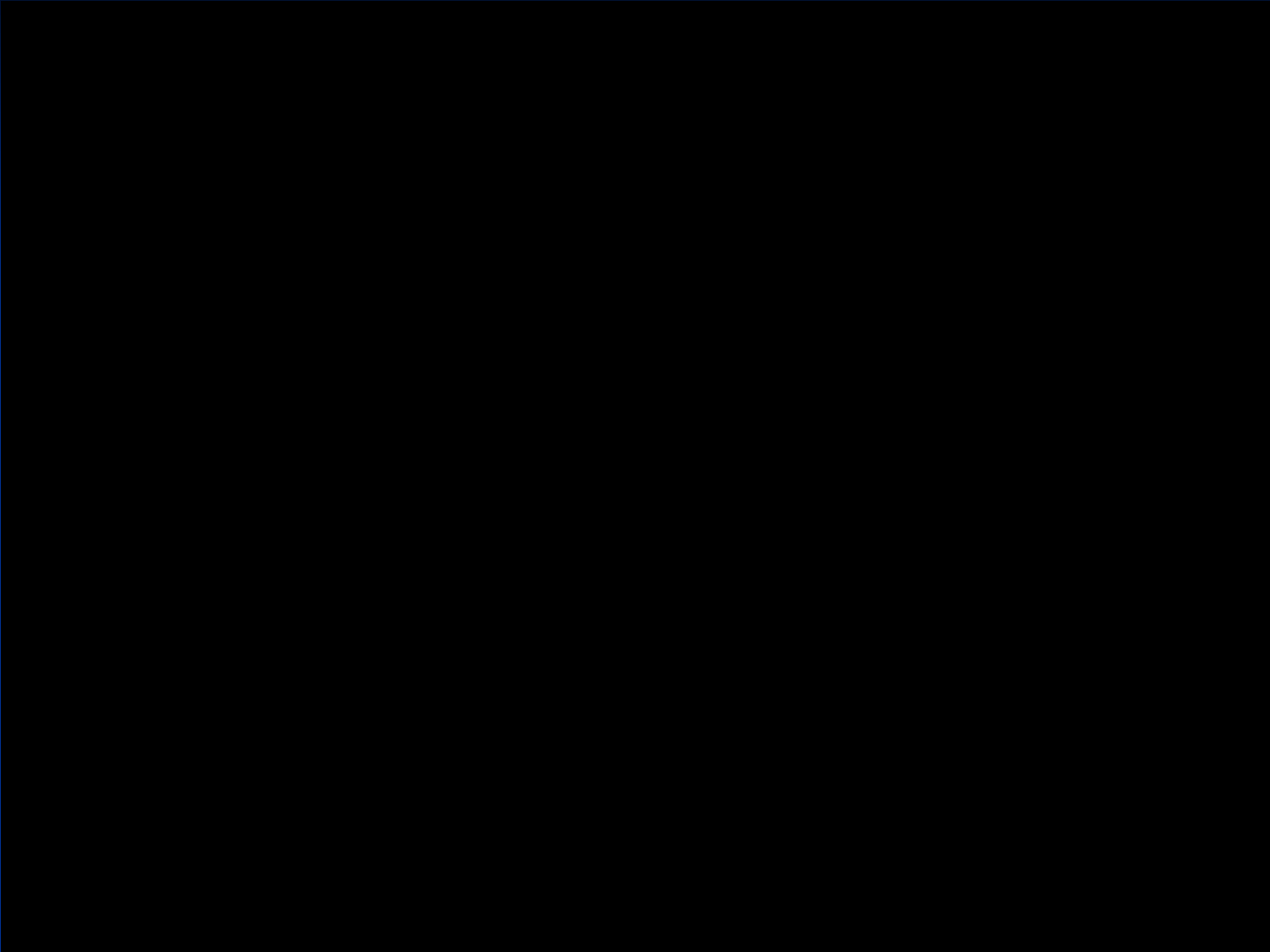

Municipal Wastewater Anoxic Zone Mixing



- Two identical circular aeration basins with 4 mixing zones [3 anoxic] in each, plus a wet well
- One 40HP compressor provides air for all nine mixing areas



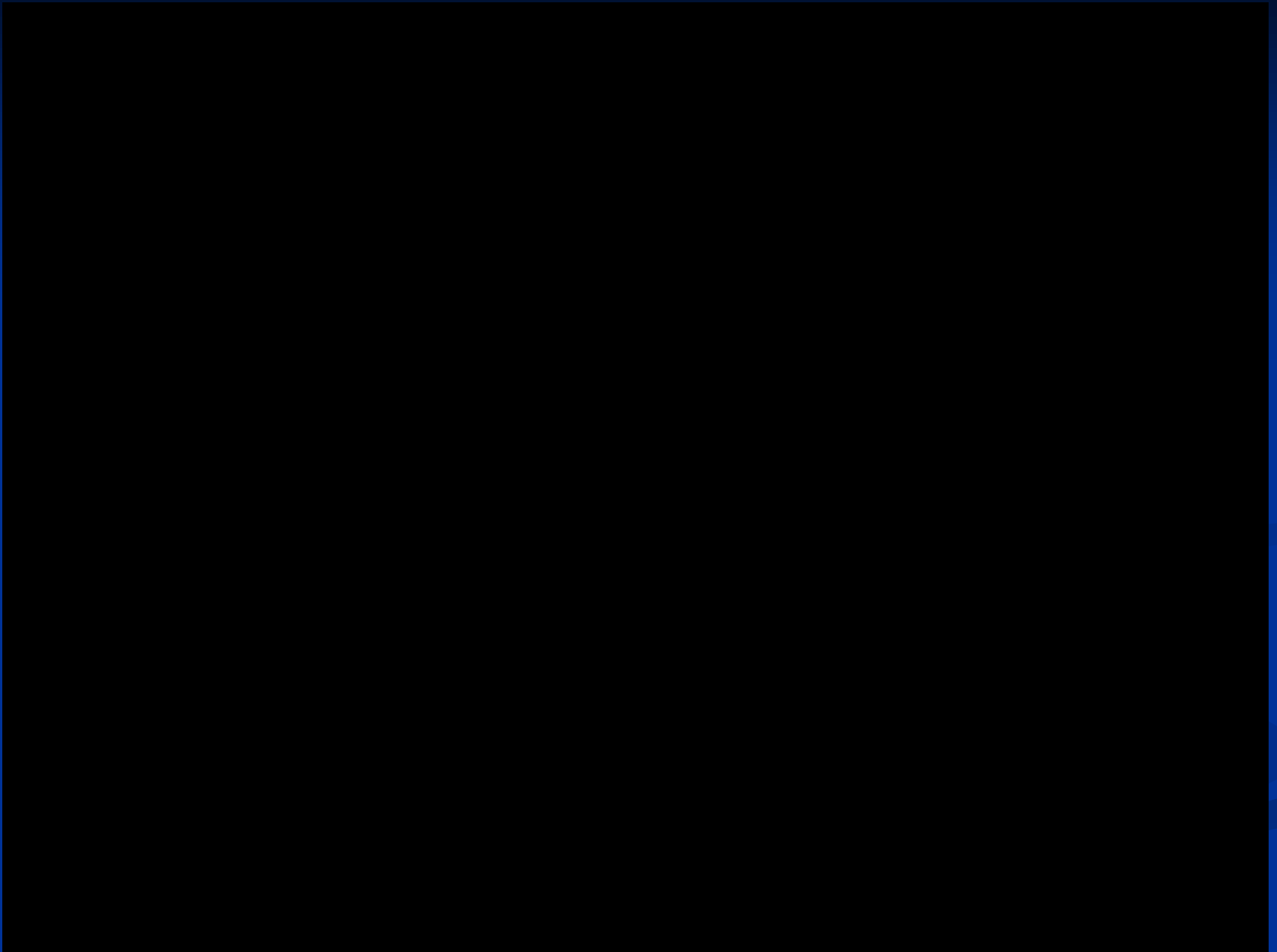



Pulsed Air system for mixing a lift station

Potable Water Pulsed Air Features & Benefits

Features of Pulsed Air Mixing



Pulsair components for Potable Water meet NSF/ANSI 61 requirements & are NSF Certified

Features of Pulsed Air Mixing



Pulsed Air mixers are not limited by tank shape, configuration, or size.

Pulsed Air can mix large ground reservoir tanks, standpipes, elevated pedestal, and hydrospheres.

What are the benefits of Pulsed Air Mixing for Potable Water Tanks?

- Pulsed Air is the fastest potable water mixing system in the world
 - Mixes multi-million gallon tanks in minutes, not days
 - Can quickly respond to unforeseen events that require immediate mixing
- **Mixes 100% of the tank's contents without deadzones**
 - Mixes water that is out of reach of discharge pumps – e.g. at the very bottom of the tank
 - Eliminates the need for deep cycling

What are the benefits of Pulsed Air Mixing for Potable Water Tanks?

- **Eliminates Thermal Stratification**
 - Vertical flow pattern breaks up stagnant layers
 - Colder water is pulled up from the bottom & into the tank, achieving uniform water temperature
- **Helps prevent the formation of THMs & other BDPs**
 - Thermal stratification & thermoclines are eliminated, reducing the formation of THMs
 - Disinfection chemicals are uniformly maintained throughout the tank & the need for disinfection boosting is reduced

What are the benefits of Pulsed Air Mixing for Potable Water Tanks?

- **Prevents ice formation**
 - The vertical circulation & increased agitation at the water surface greatly reduces the formation of ice or freezing in tank
- **Zero in tank maintenance**
- **Efficient intermittent mixing reduces energy consumption**

Questions & Answers –
Open Discussion

PULSAIR SYSTEMS, INC.

P.O. Box 562

Bellevue, WA 98009-0562

800.582.7792

www.pulsair.com