

Stray & Galvanaic Corrosion Attack on Water & Wastewater Systems



Presented By:
James T Lary
Corrpro
1055 W. Smith Rd.
Medina, OH 44256
Tel. 330-241-6615
email: jlary@corrpro.com
<http://www.corrpro.com>

corrpro[®]



Corrosion



Temporary Fix ?

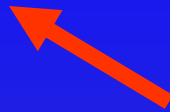

Corrosion - A Natural Process

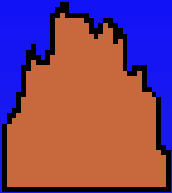

IRON OXIDE

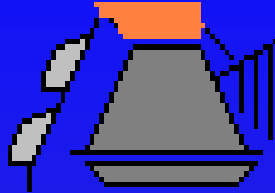

REFINING

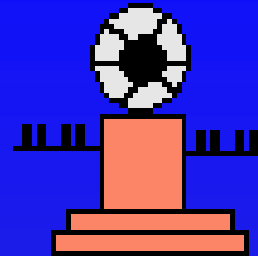

MILLING



IRON, STEEL, PCCP

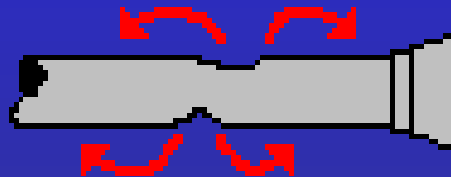

CORROSION

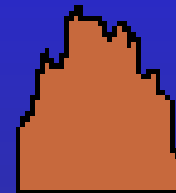

IRON OXIDE

Galvanic Corrosion Cell on Buried Piping

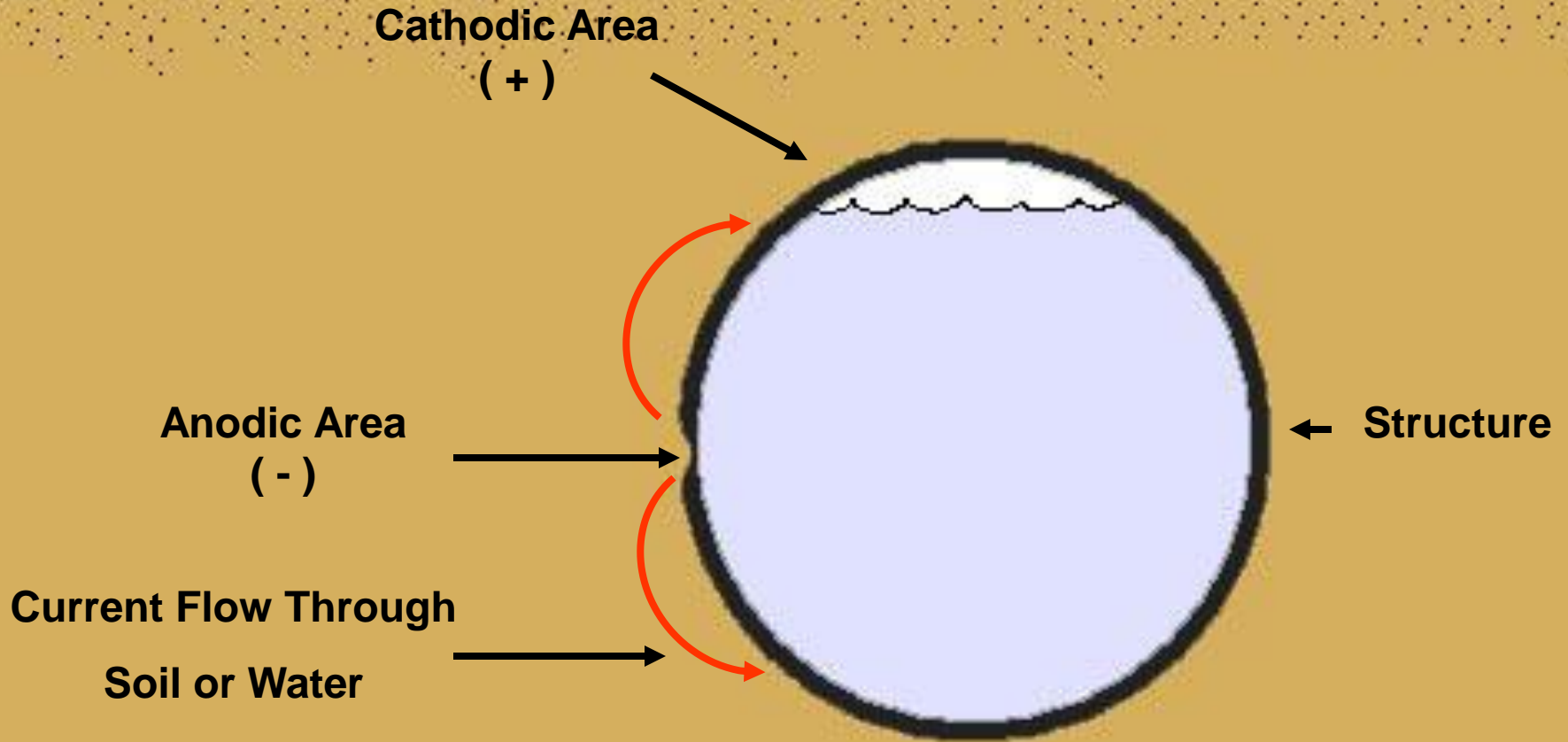

Corrosion of Metallic Structure

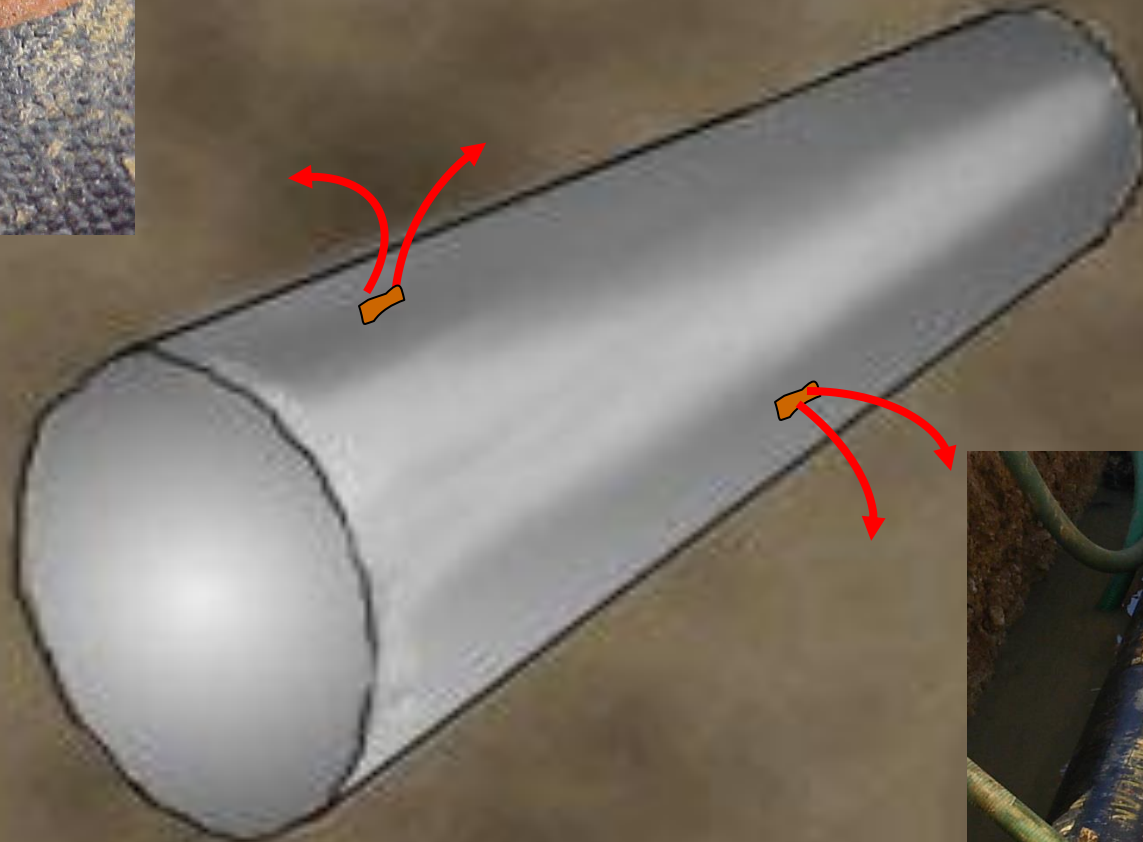



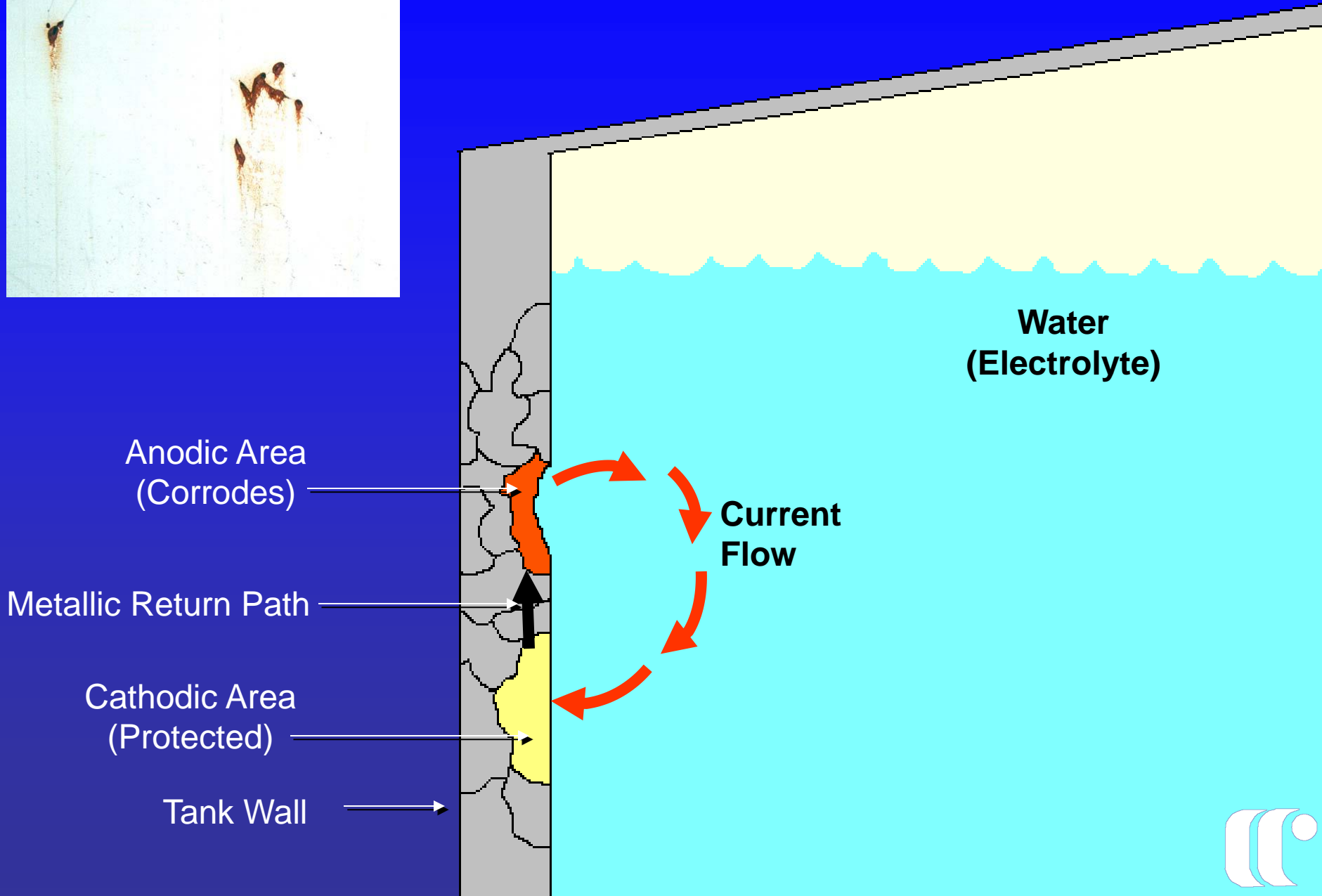



History of Iron Pipe

Cast Iron

- Introduced to North America during the 1800's and installed till the 1970's.
- Early on, statically cast process produced a thick walled, heavy pipe.
- No longer produced in North America.

Ductile Iron

- Introduced in 1955 as an improvement to cast iron.
- Centrifugal casting process produces a thinner walled, lighter pipe which is stronger and more ductile than cast iron.



Cast (Grey) Iron Failures



Graphitization leaves pipe brittle and weakened.

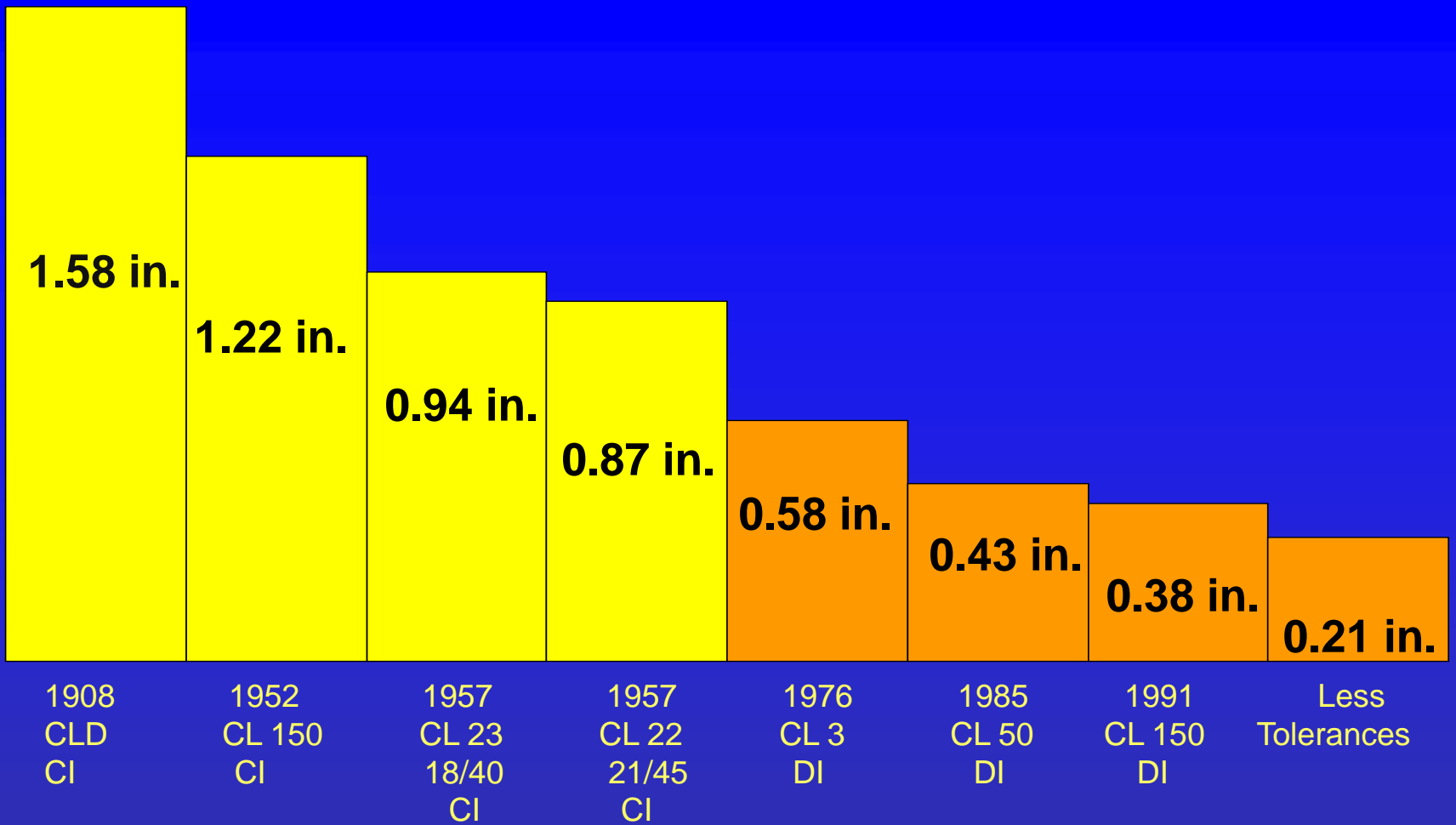

Actual size of AWWA Specification Thickness Reductions for 36-inch Diameter Cast and Ductile Iron Pipe - 1908 to Present (150 PSI Operating pressure)

Ductile Iron



Pitting (concentrated) corrosion attack on ductile iron pipe.

Adverse Conditions for Metallic Pipe

- ***High Chlorides***
- ***Low Soil/Water Resistivity***
- ***High Sulfates***
- ***Acidic Soils***
- ***Wet/Dry Fluctuations***
- ***Bimetallic Couplings***
- ***Stray Current Interference***



Dissimilar Soils

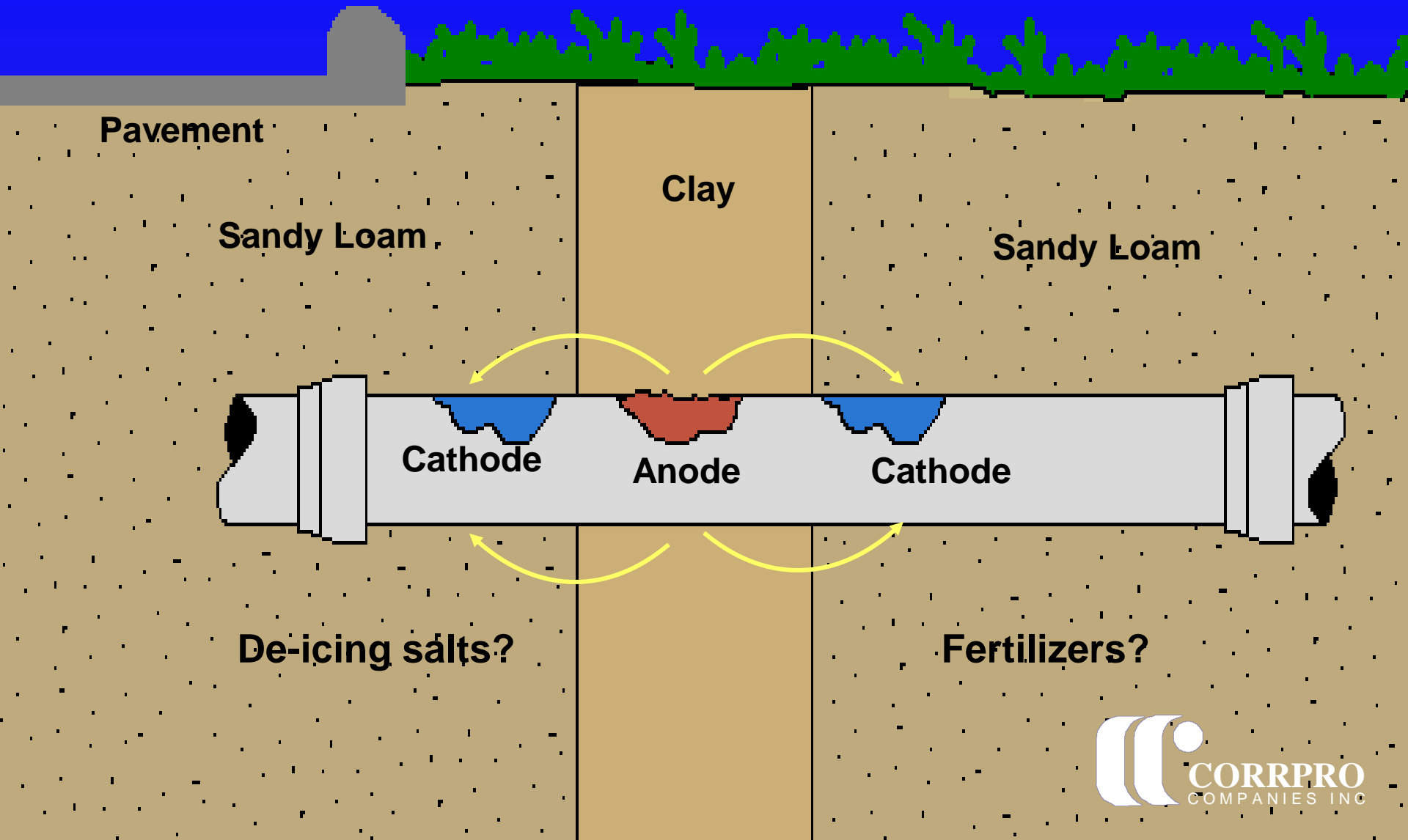

Corrosion Caused by Differential Aeration

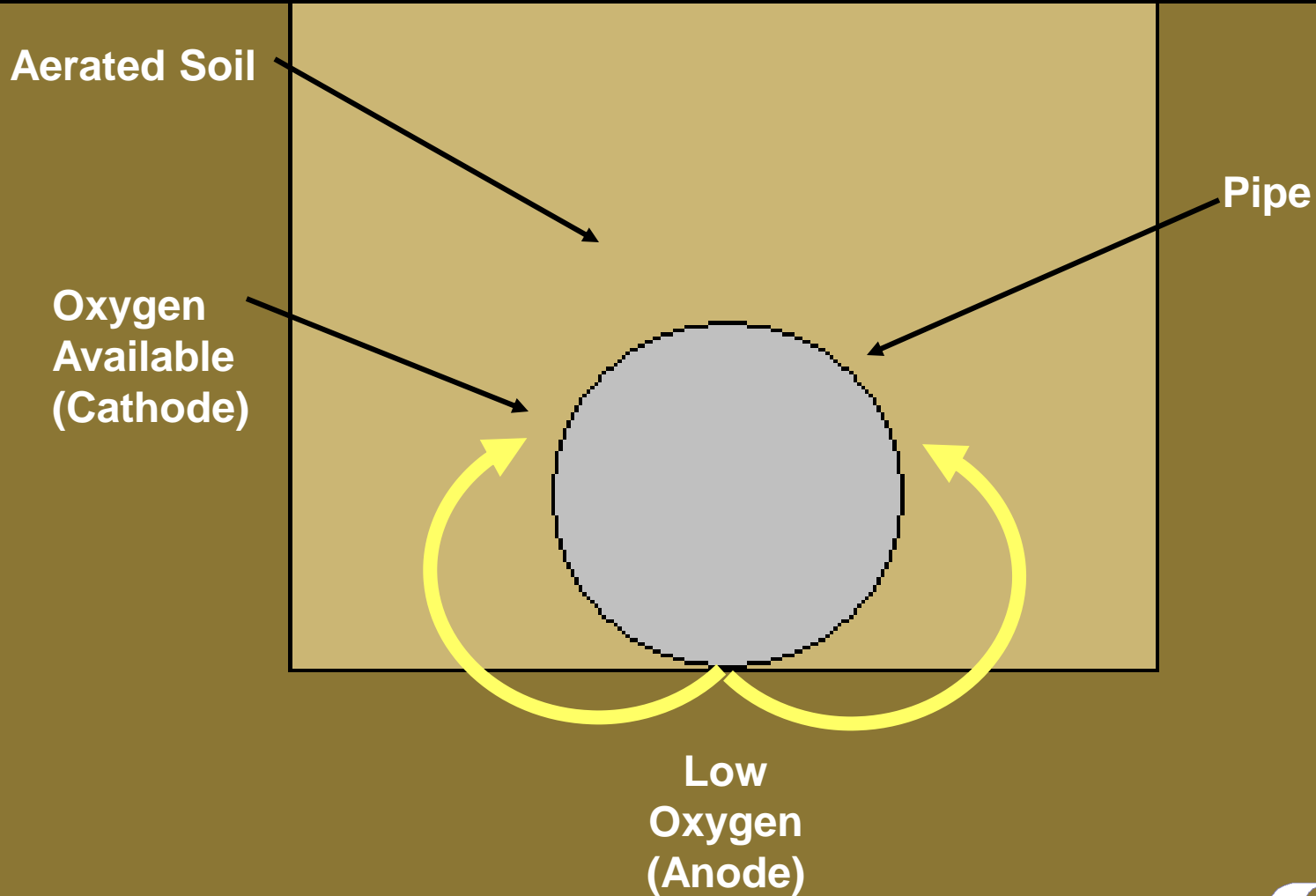

Dissimilar Surface Conditions

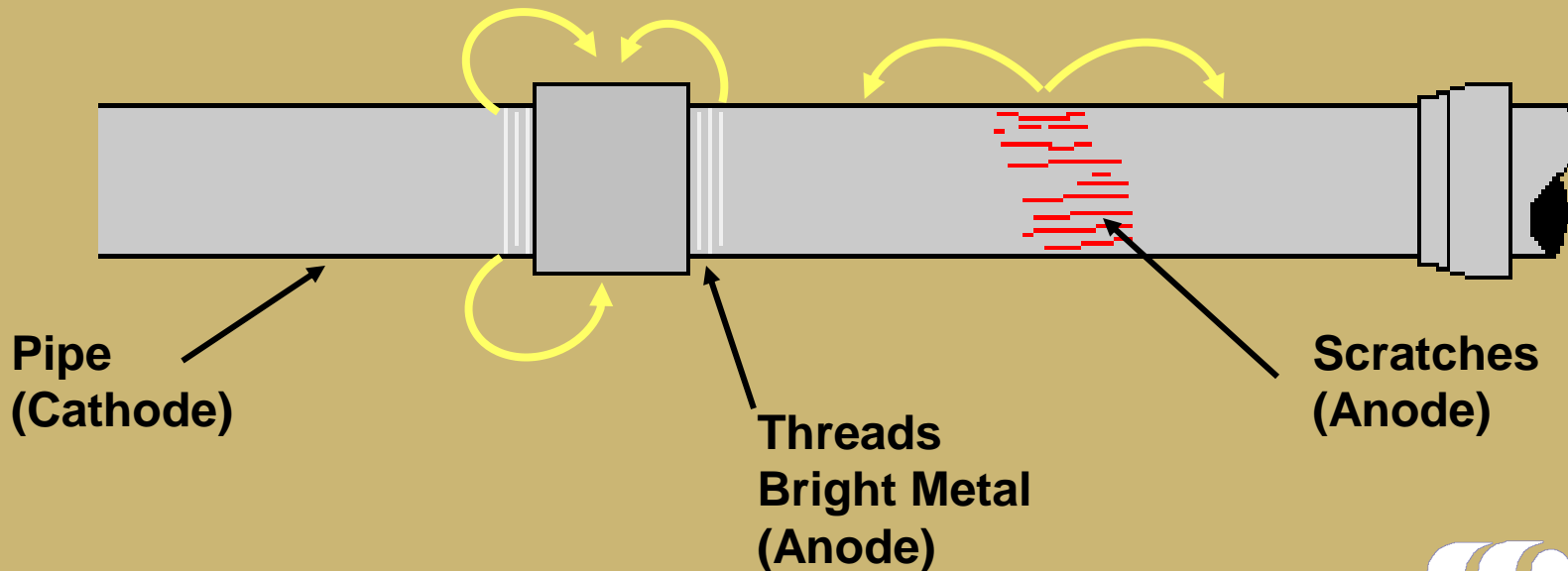

Gate Valve Corrosion



Lower Stress Area
(Cathode)

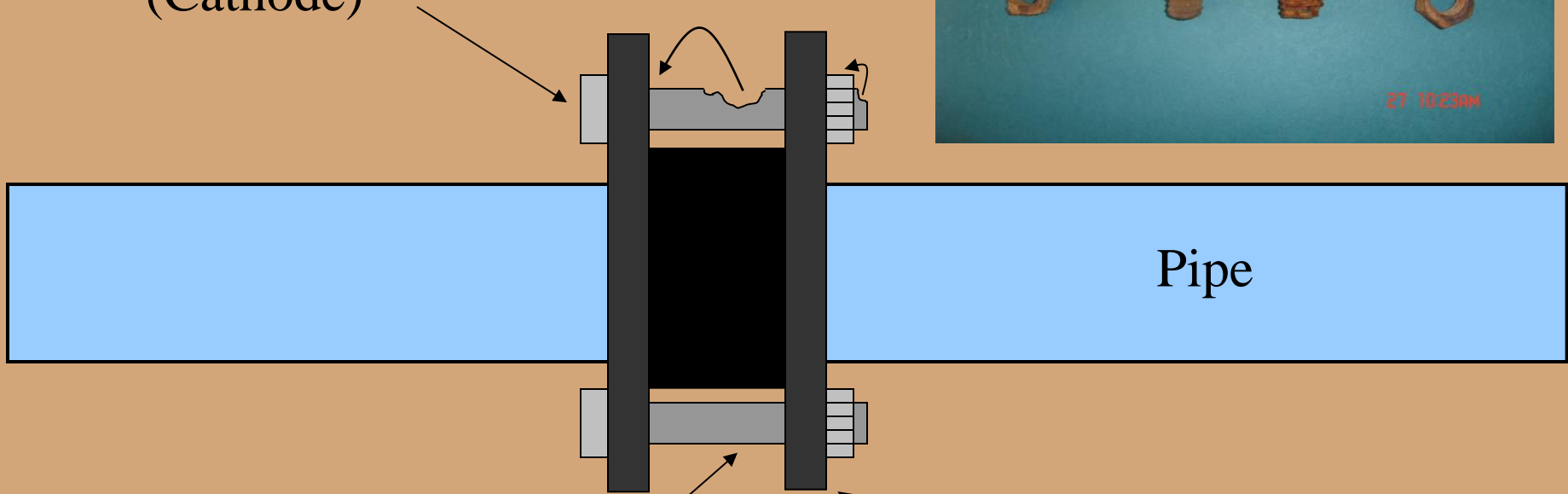

Threaded Bolt
Higher Stress Area
(Anode)

Metallic Coupling

Stress Corrosion





Meter Vault Corrosion

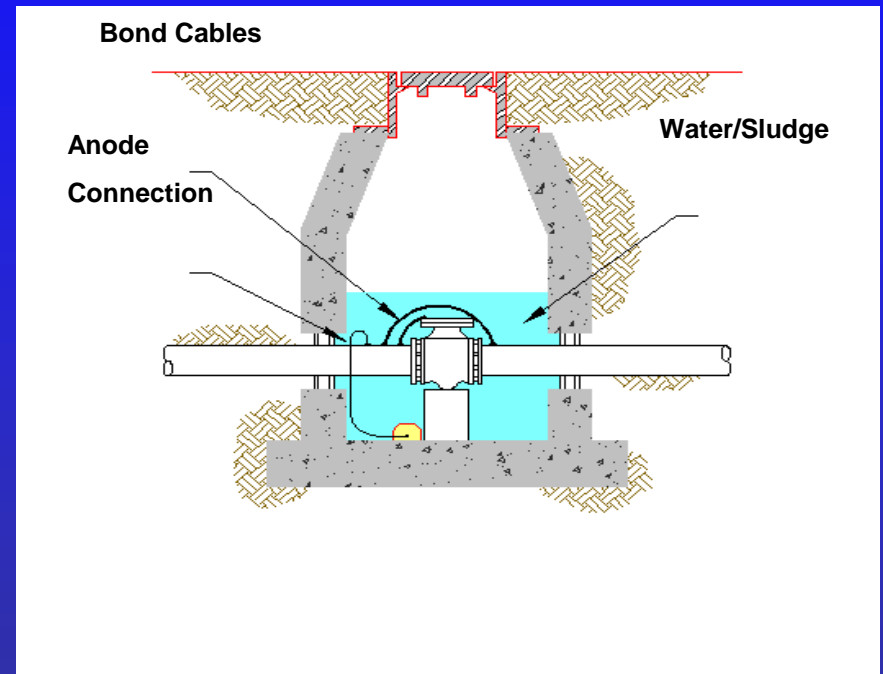

Meter Vault with Anode

Stainless Steel Corrosion



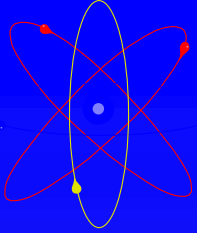

PRACTICAL GALVANIC SERIES

Material	Potential*
Pure Magnesium	-1.75
Zinc	-1.10
Aluminum Alloy	-1.00
Cadmium	-0.80
Mild Steel (New)	-0.70
Mild Steel (Old)	-0.50
Cast/Ductile Iron	-0.50
Stainless Steel	-0.50 to + 0.10
Copper, Brass, Bronze	-0.20
Gold	+0.20
Carbon, Graphite, Coke	+0.30

* Potentials With Respect to Saturated Cu-CuSO₄ Electrode

Coupling to Dissimilar Metals

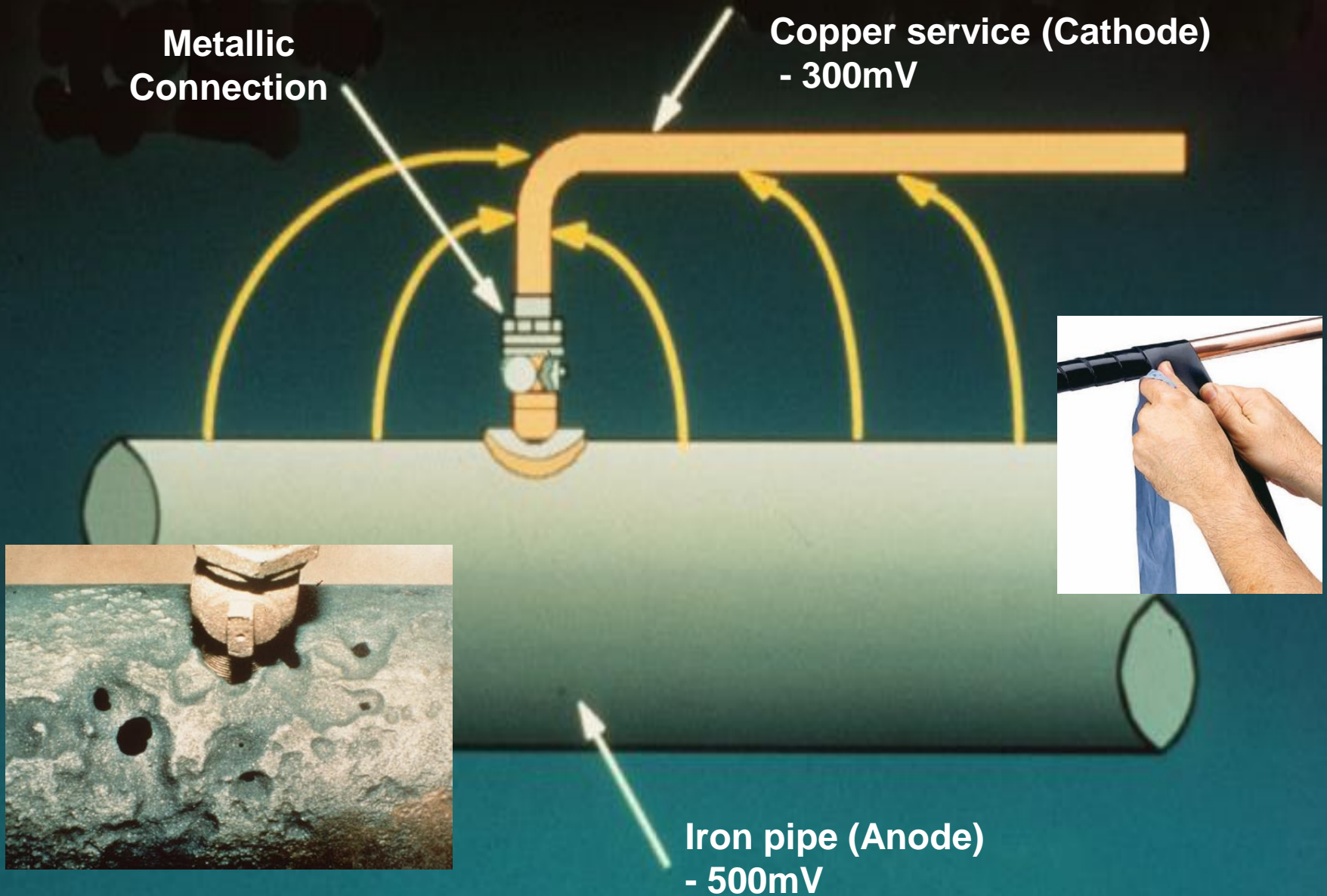

Stray Current

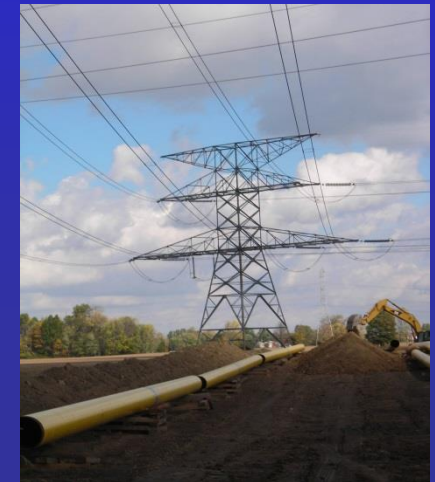

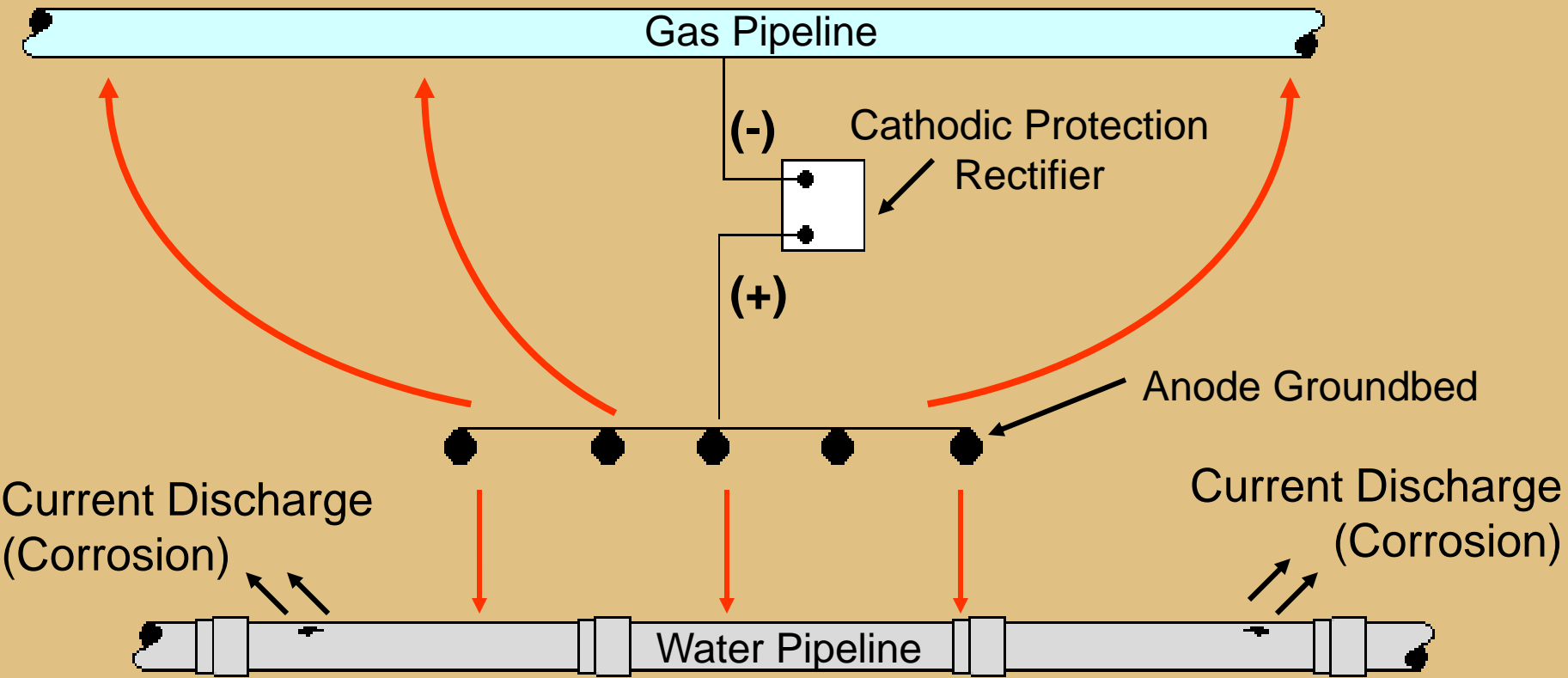

Stray Current Due to Impressed Current Cathodic Protection System



Impressed Current CP System on Oil/Gas Lines can Create Stray Current Problem on Water Lines



corrpro[®]

An Aegion[™]
Company

Stray Current

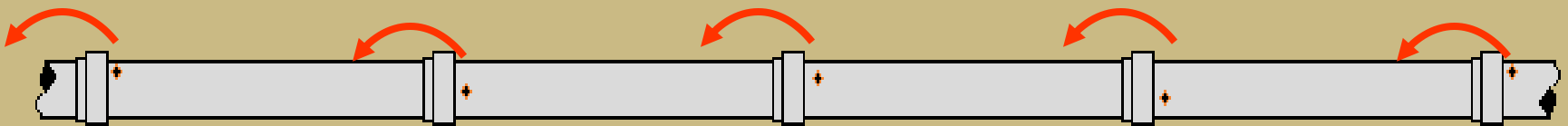
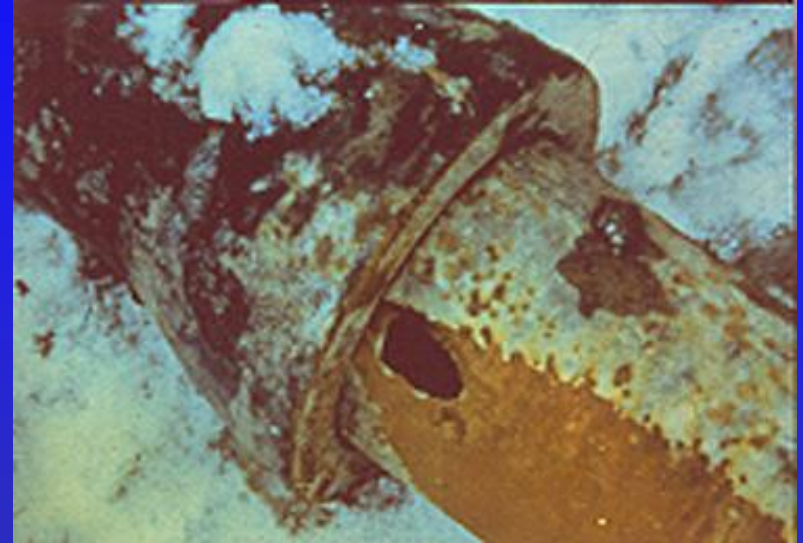

Bonding Across a Bell and Spigot or Slip-joint

Thermite brazed connection coated with bitumous compound

Copper wire with direct burial insulation

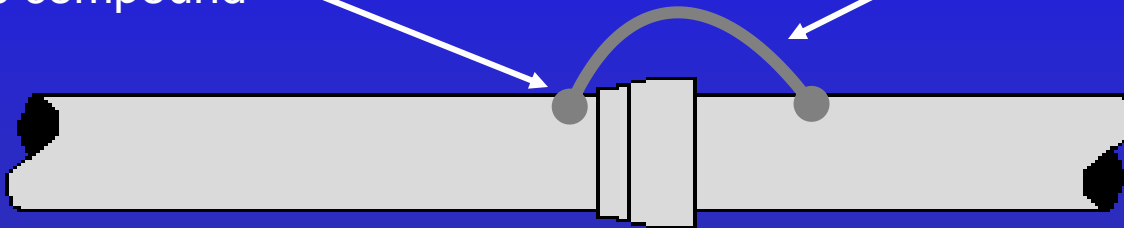

Computerized Potential Logging Survey

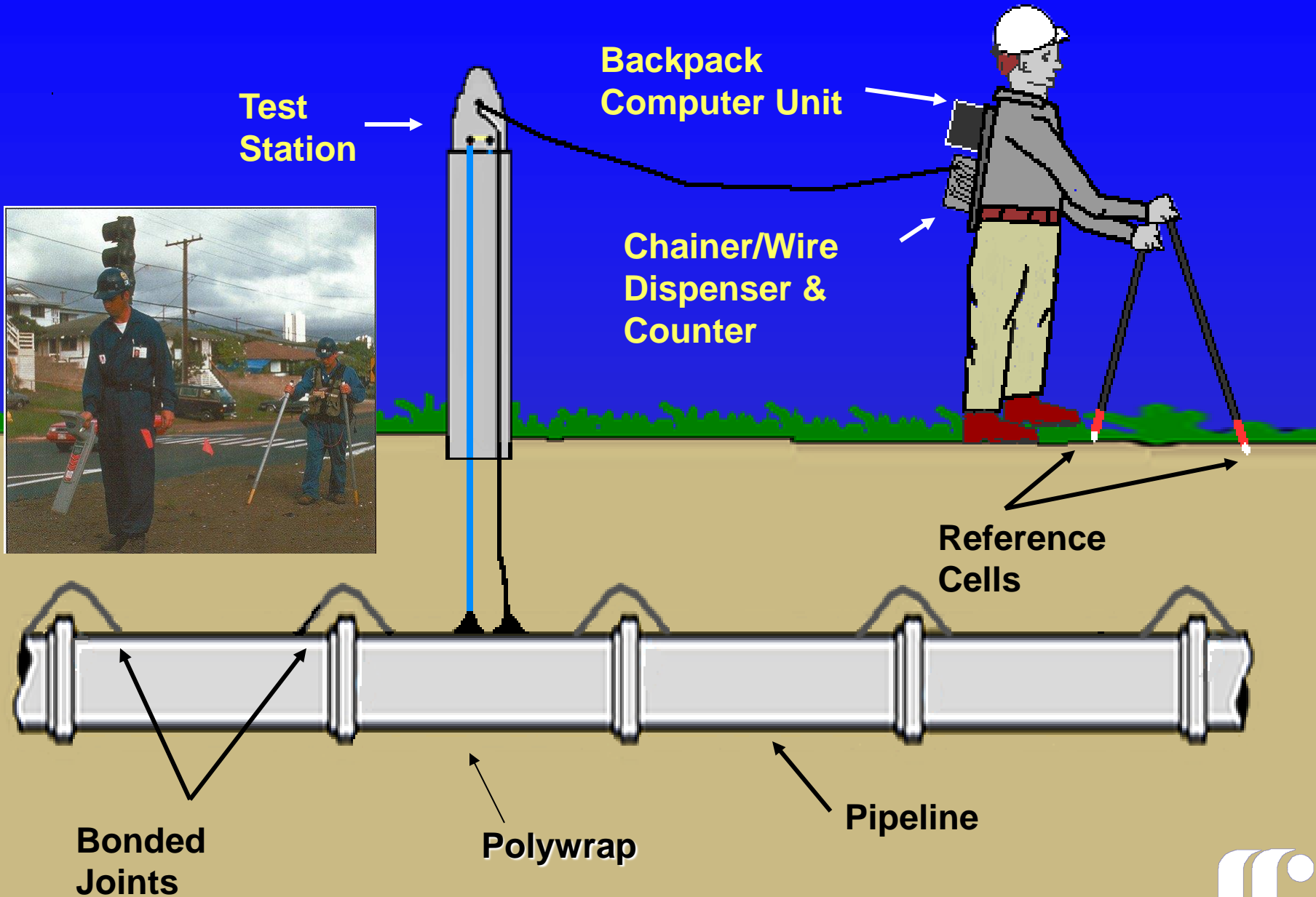

AC Mitigation



Proper Handling & Installation of Polyethylene Ductile Iron Pipe



Polyethylene Encasement of Ductile Iron Pipe



- Follow DIPRA installation procedures
- Clean pipe before installing polywrap
- Repair tears or damage to encasement
- Engage an inspector to oversee installation

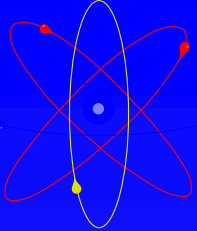

PRACTICAL GALVANIC SERIES

Material	Potential*
Pure Magnesium	-1.75
Zinc	-1.10
Aluminum Alloy	-1.00
Cadmium	-0.80
Mild Steel (New)	-0.70
Mild Steel (Old)	-0.50
Cast/Ductile Iron	-0.50
Stainless Steel	-0.50 to + 0.10
Copper, Brass, Bronze	-0.20
Gold	+0.20
Carbon, Graphite, Coke	+0.30



* Potentials With Respect to Saturated Cu-CuSO₄ Electrode

Cathode
(Protected)

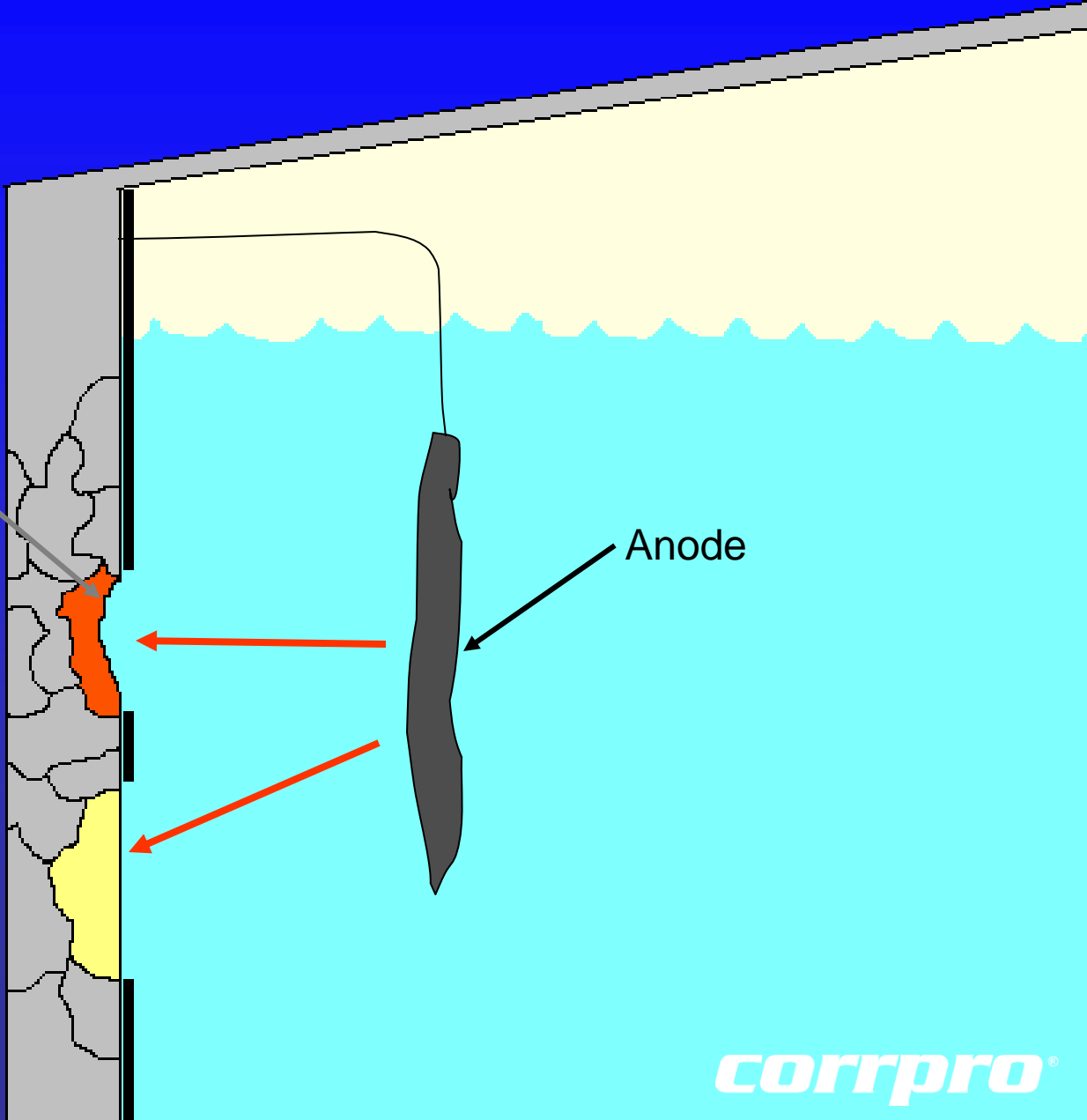
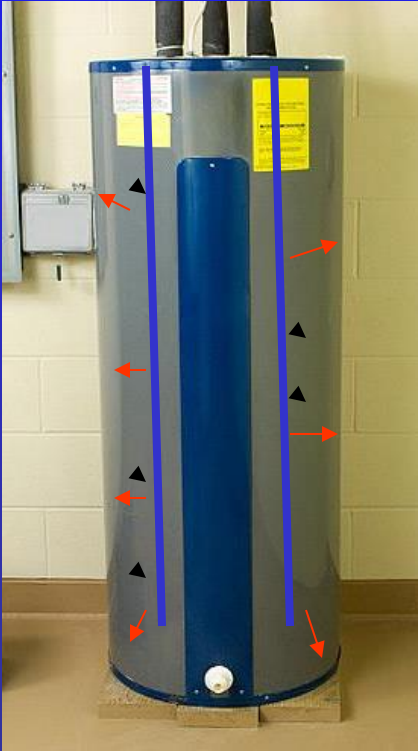

Galvanic Anode

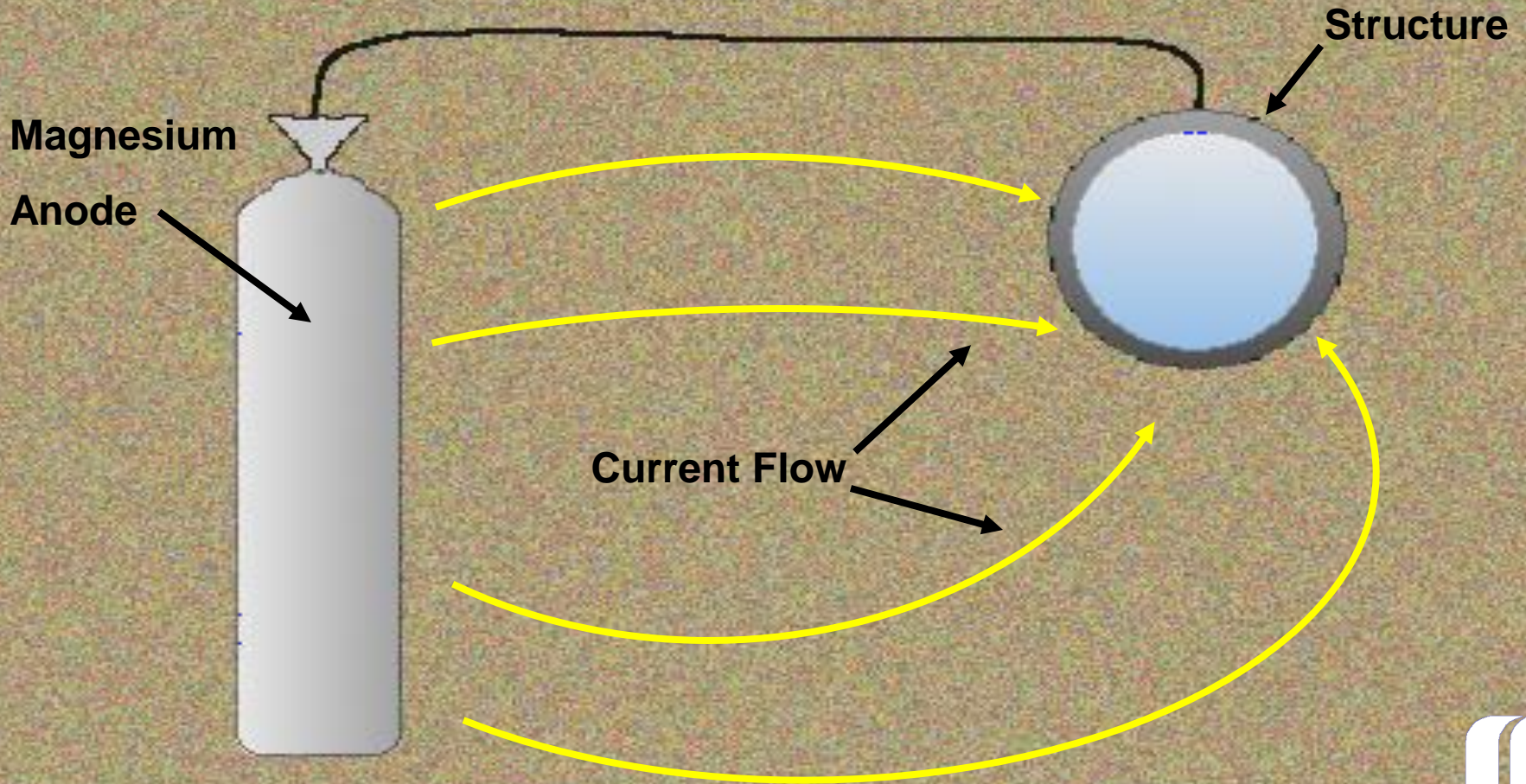

Anode Installation

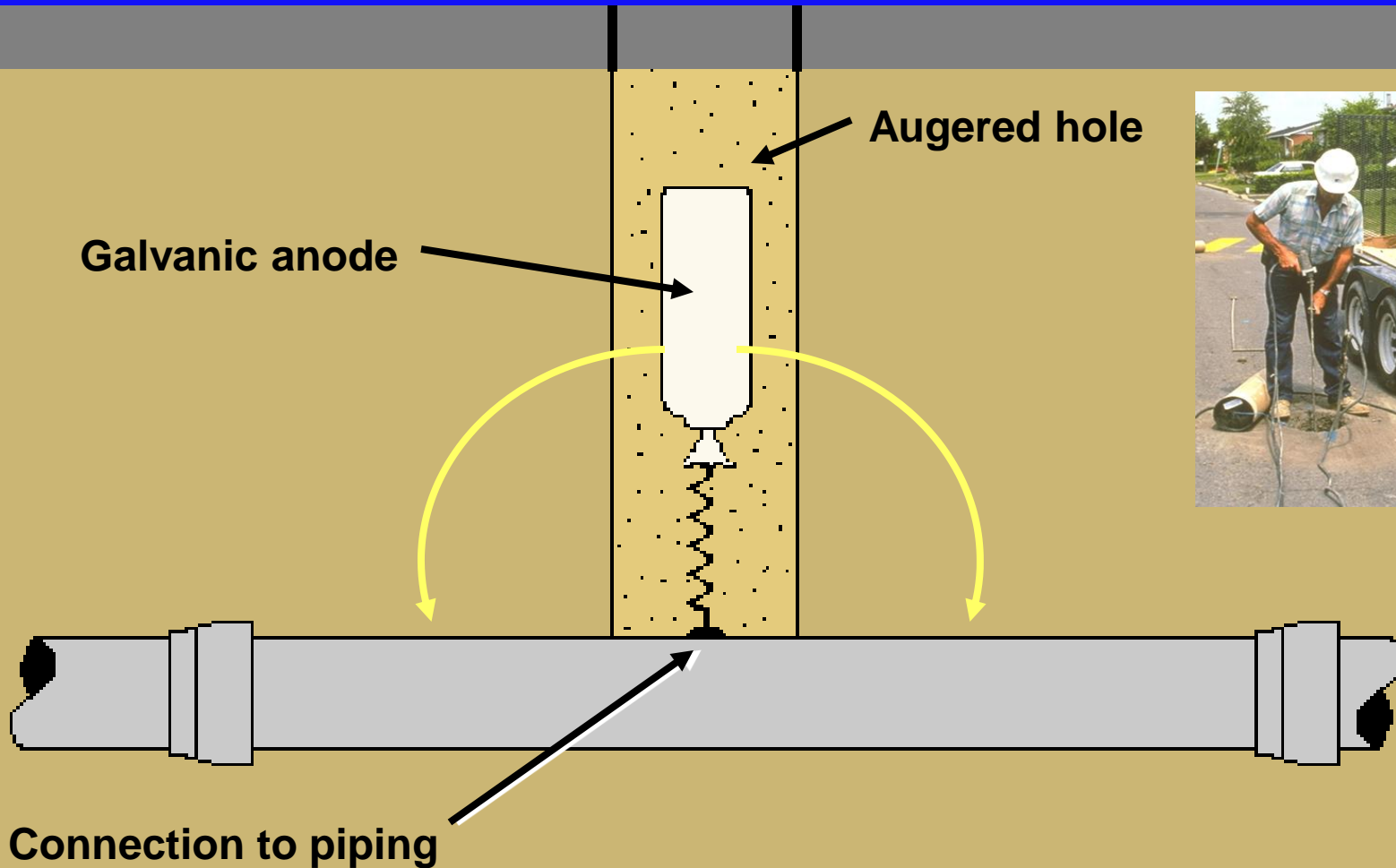

Cathodic Protection Test Station

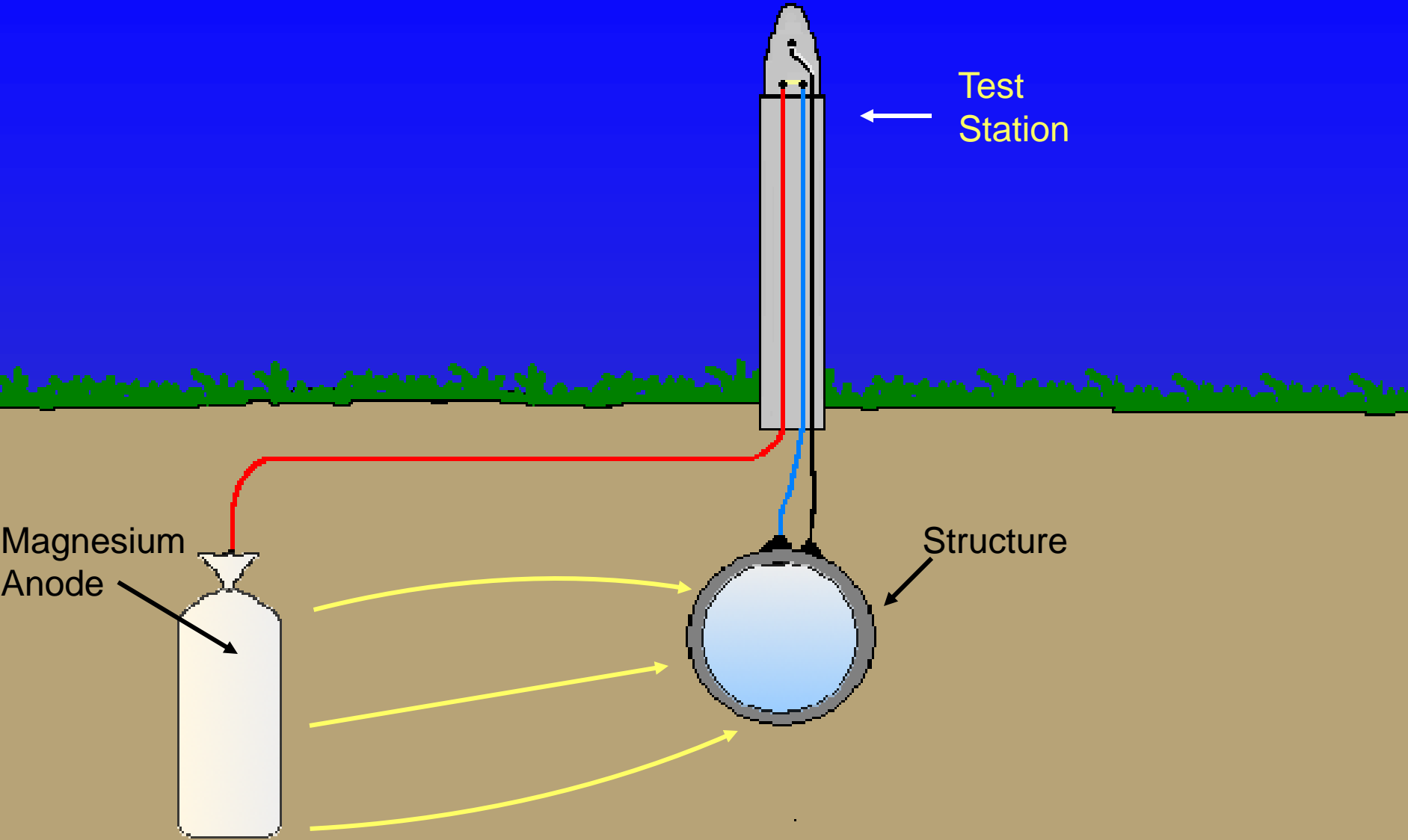

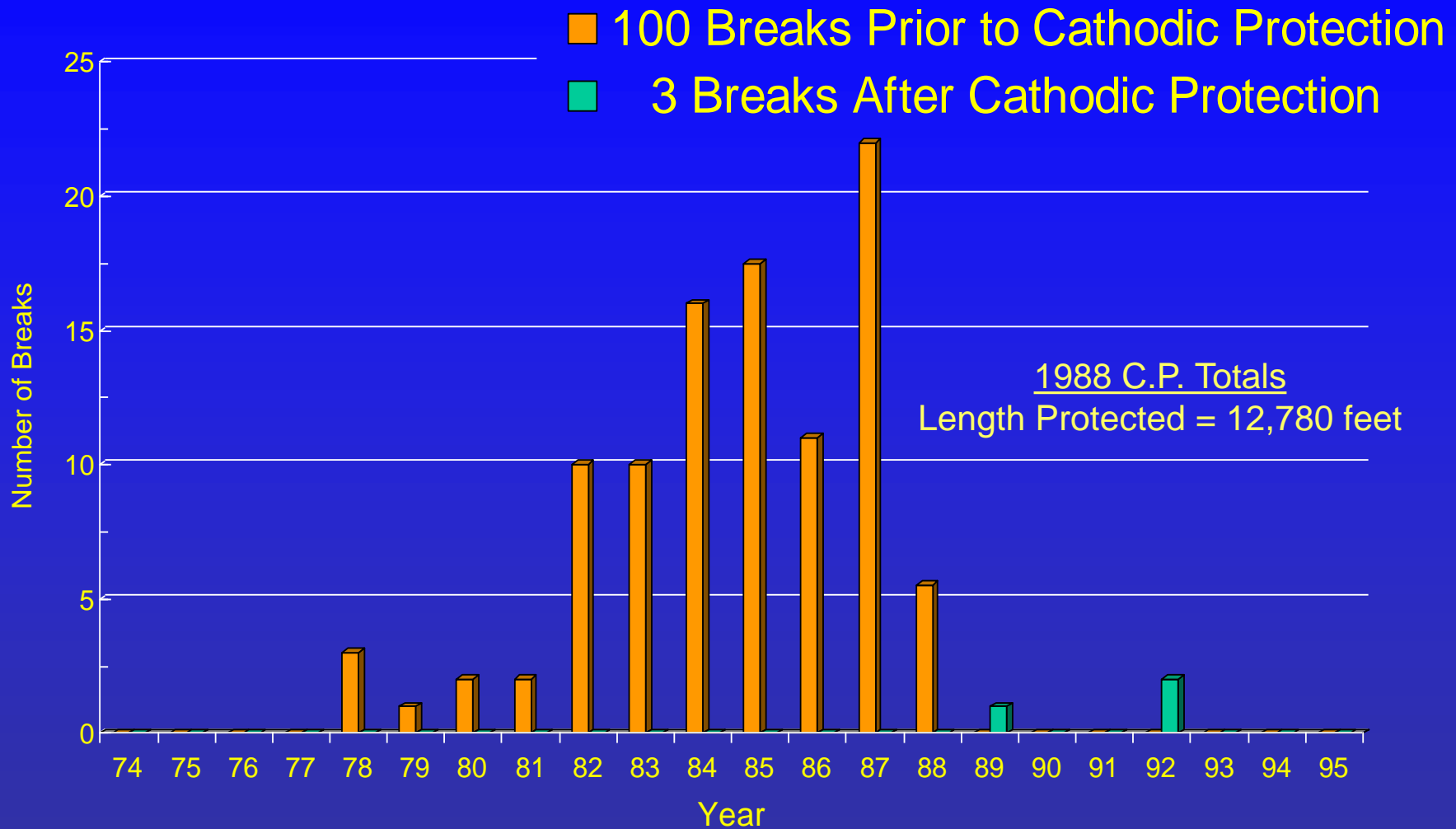

Break Records for Water Mains Cathodically Protected in 1988

Temporary Fix ?



Repair of Break Should Include Anode Installation



Incomplete



Complete

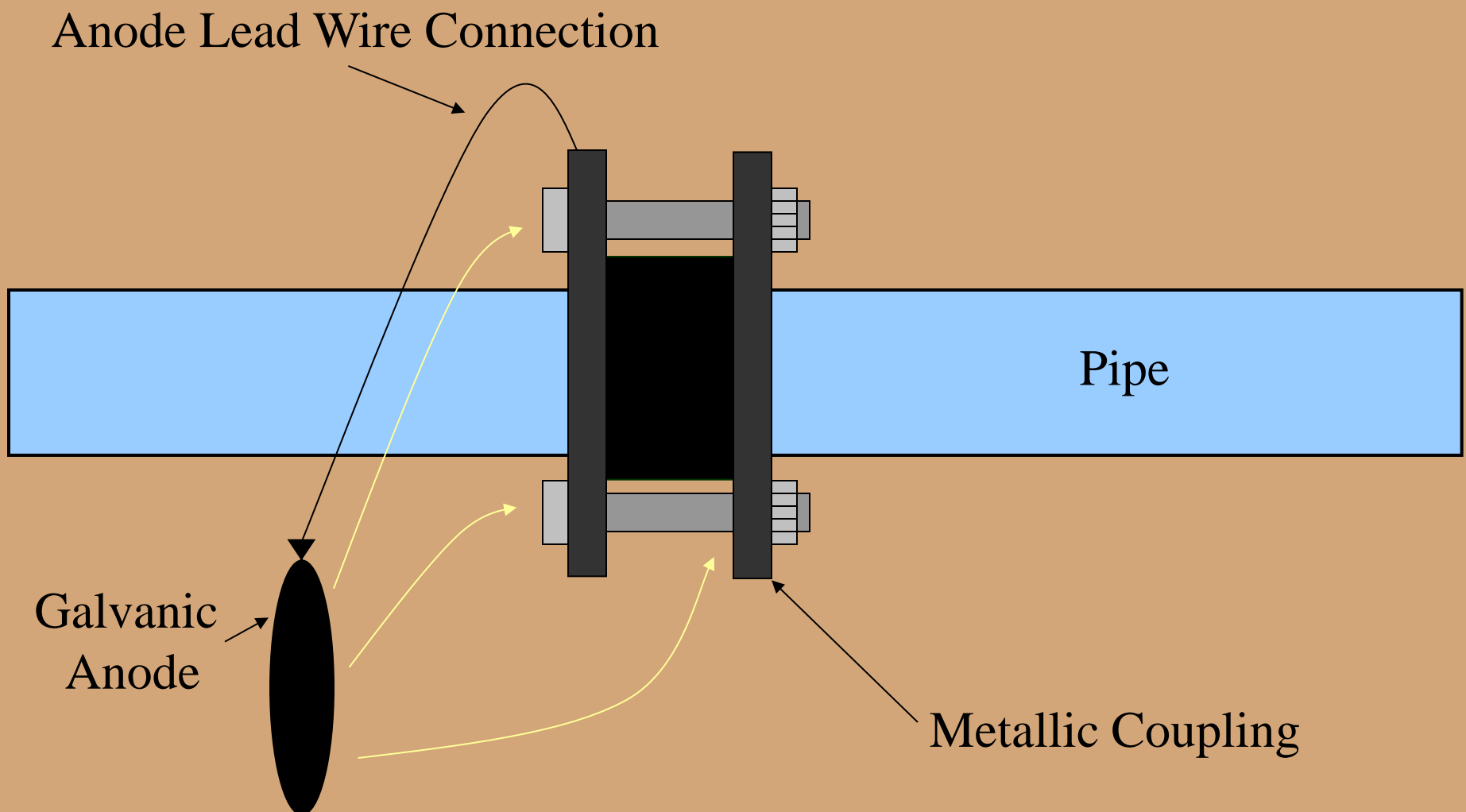

Anode Lead Wire Connection

Pipe

Galvanic Anode

Metallic Coupling

Cathodic Protection of Metallic Fitting

Anode Installed on Metallic Fitting



Pumping Stations



Depleted & Refurbished Cathodic Protection for Lift Stations

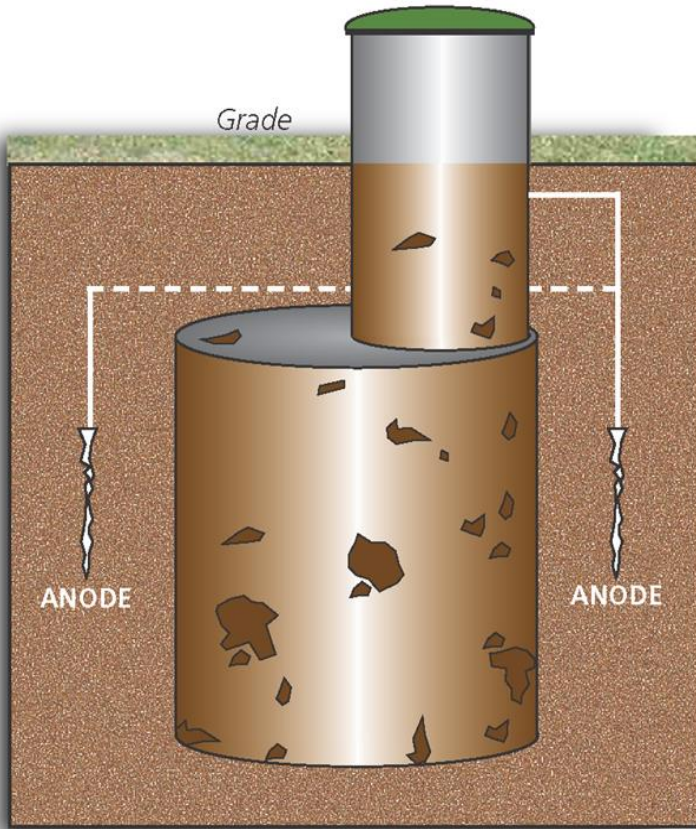

Depleted cathodic protection system allows corrosion to occur.

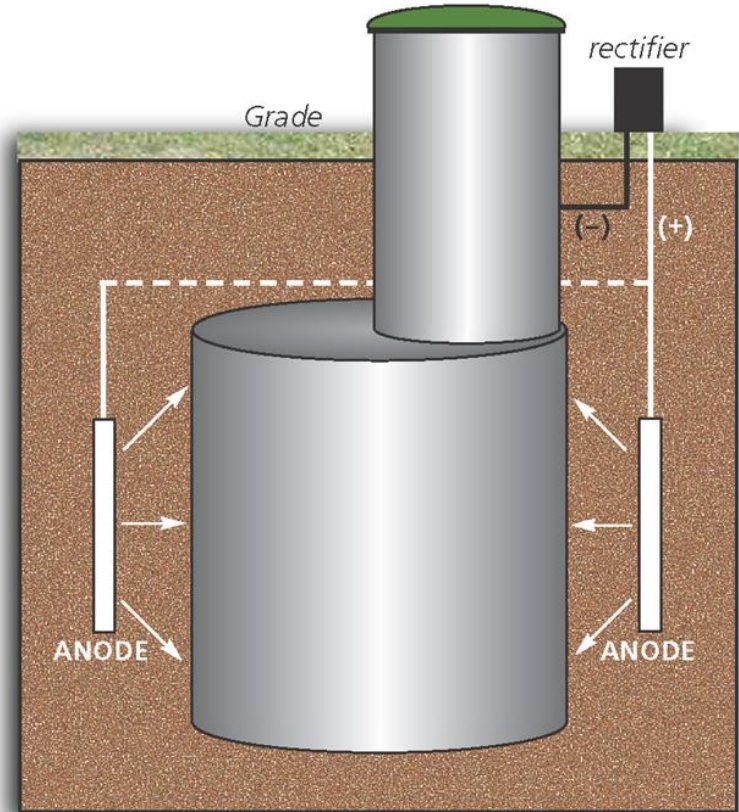

Effective cathodic protection system prevents corrosion and extends life of lift station.



For New or Refurbished Tanks



corrpro[®]

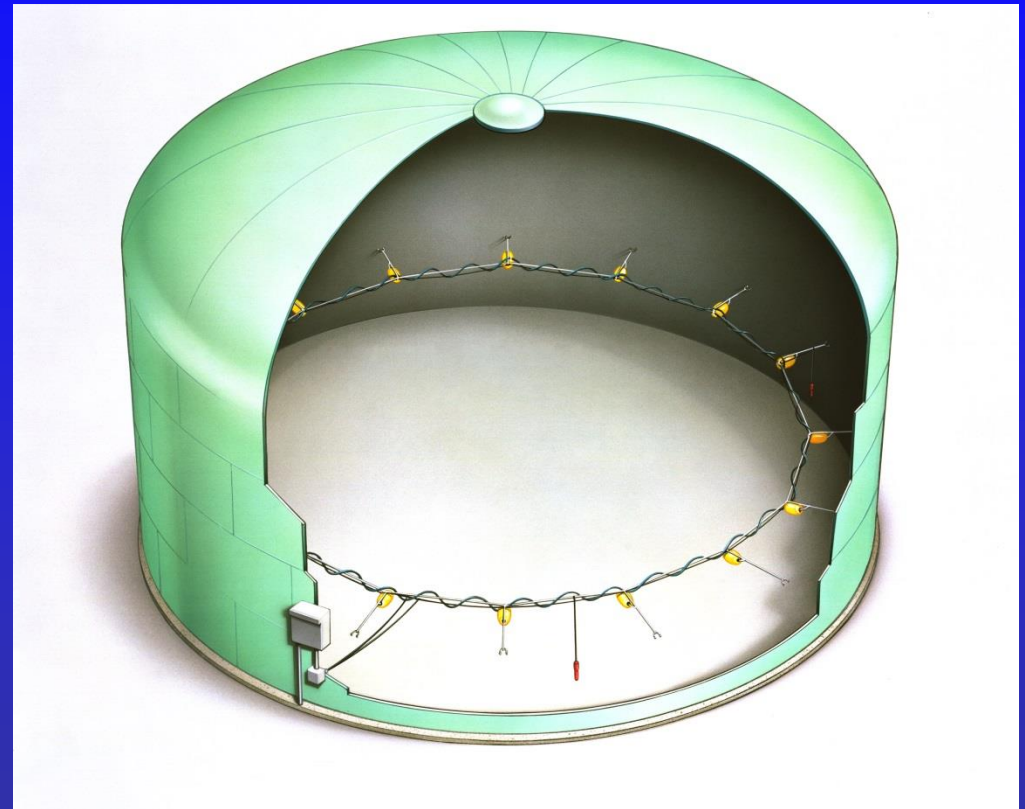
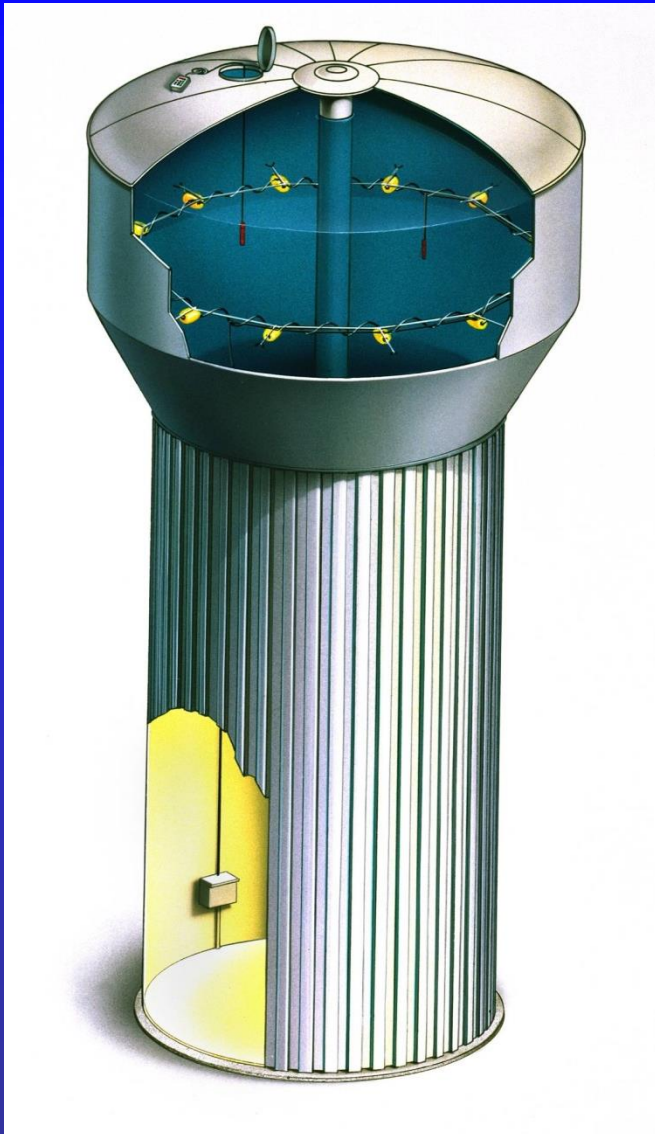

CP Benefits: - Triple life of coating
- Reduce maintenance cost

Suspended Horizontal Anode System

Top View Diagram

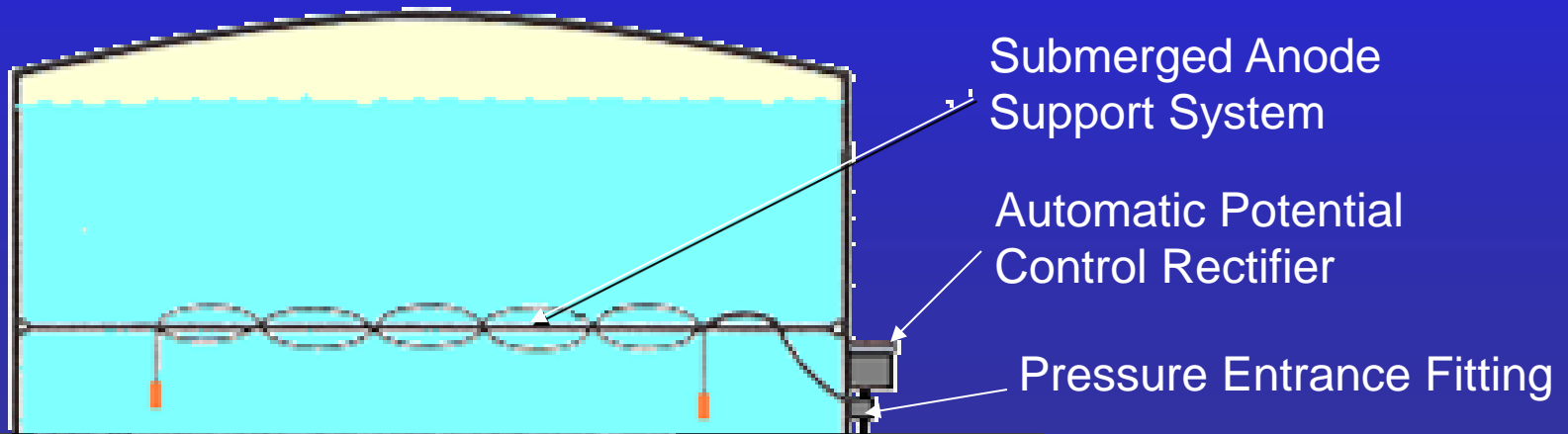
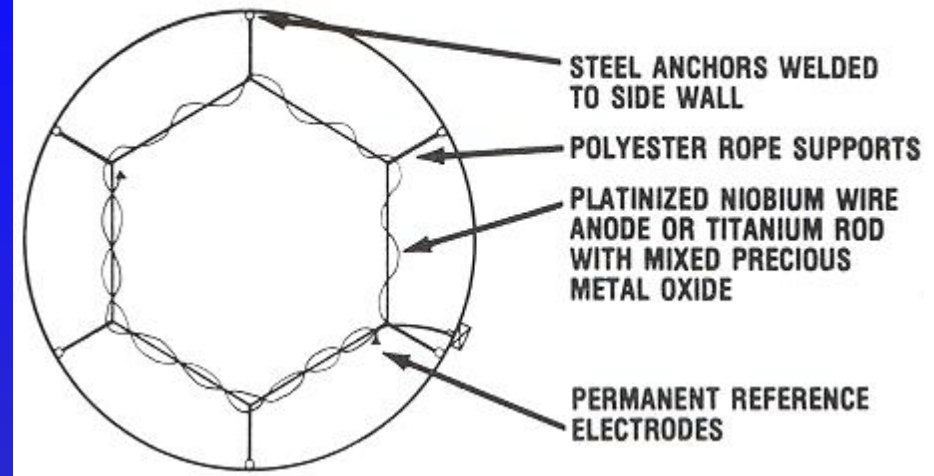

Corrosion of Clarifier Center Well



Annual Maintenance



Internal Corrosion of Force Mains....



**Solids
Buildup**

Force Main Inspections



36" Above Ground Crossing

- Failure of force main at above ground crossing
- Crown of pipe attacked by hydrogen sulfide gas



24" Ductile Iron Force Main



- Internal failure following loss of internal mortar lining
- Failure was along top of pipe due to formation of hydrogen sulfide gas



Dual 26" Force Mains



- Internal failures at bottom of pipe
- Failure following loss of internal mortar lining
- Failures concentrated at low areas (dips) in pipeline alignment
- Cause is corrosion under accumulated solids

Rehabilitation Options



Investigative Structure (Existing)

Corrosion Assessment

- Review of General Characteristics of Water System
 - Age
 - Material Type
 - Wall Thickness
 - Construction Practices
- Review Break / Leak History
- Field Survey
 - Soil Conditions (Resistivity, Moisture Content, Chemical Analysis)
 - Electrical Test
- Data Analysis & Risk Management
- Priority Index (Identification of Opportunities to Reduce Replacement / Repair Costs)



New Piping

PHASE I

- Obtain drawings of proposed route
- Conduct independent field investigation:
 - a) Soil resistivity study
 - b) Identify foreign pipeline crossing
 - d) Identify AC potential influence
 - e) Collect soil samples (moisture content, chlorides, pH, sulfate ions concentration, conductivity)
- Stray current investigation



Corrosion Protection Design Phase II

Prepare Bid Quality Specifications for:

- Coatings or Polyethylene Encasement
- Test Stations (Monitor Corrosion Rates)
- Bonded Joints
- Stray DC/AC Mitigation
- Cathodic Protection
- Combination of Multiple Items

- Review Submittals/Onsite Periodic Inspection

Summary

- ◆ **Reducing corrosion rates on existing water distribution piping will result in a reduction of the number of breaks and also extend the operational life.**
- ◆ **Corrosion control measures should be considered during the design stage for any new metallic piping and storage tank installations.**

**Traffic
Disruptions**



Water Loss



**Fire
Protection**



**Legal &
Environmental
Claims**

Damages



QUESTIONS ?

**James T Lary
Corrpro Companies, Inc.
1055 W Smith Rd.
Medina, Ohio 44256
330-241-6615
email jlary@corrpro.com**

corrpro[®]

Impressed Current CP System on Oil/Gas Lines can Create Stray Current Problem on Water Lines





Transformer Rectifier



Internal & External Corrosion of Force Mains....

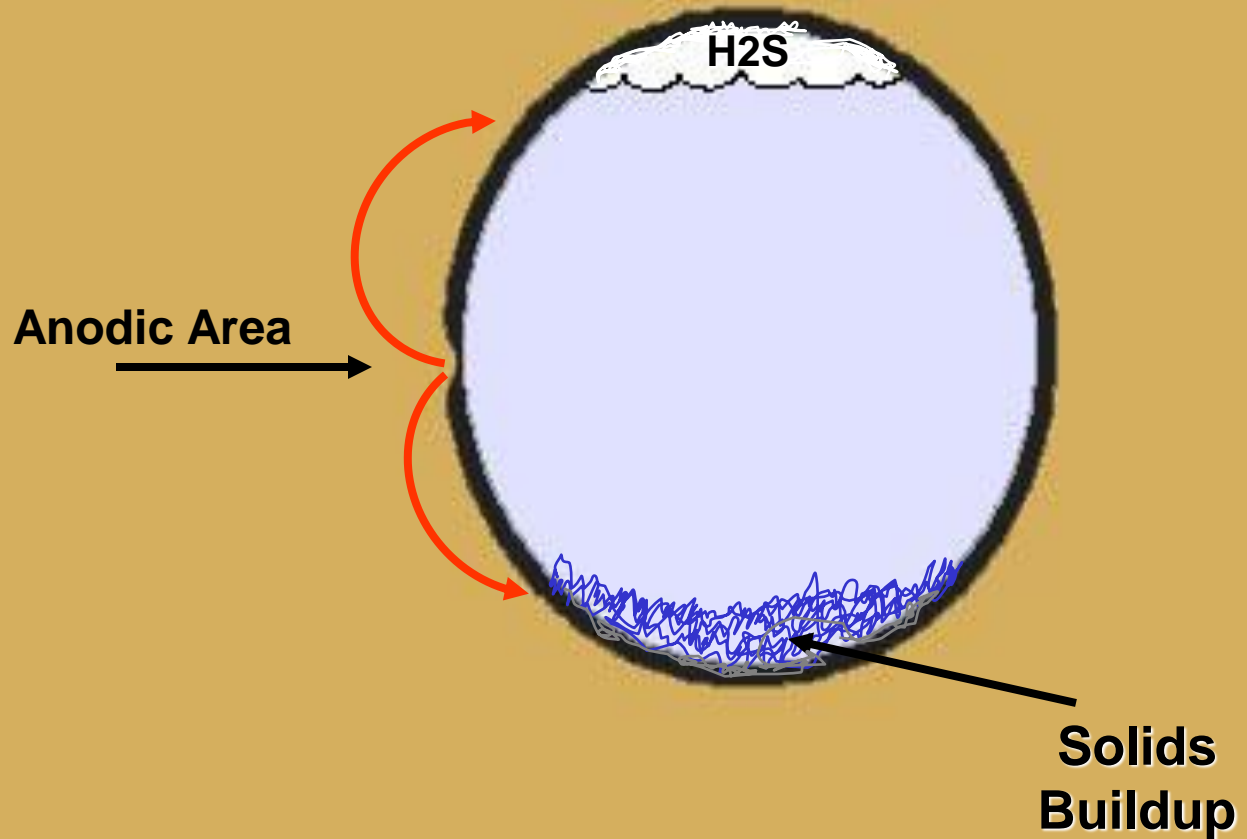

36" Above Ground Crossing

- Failure of force main at above ground crossing
- Crown of pipe attacked by hydrogen sulfide gas



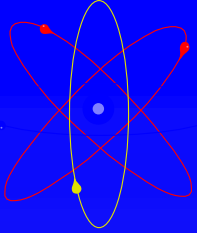

PRACTICAL GALVANIC SERIES

Material	Potential*
Pure Magnesium	-1.75
Zinc	-1.10
Aluminum Alloy	-1.00
Cadmium	-0.80
Mild Steel (New)	-0.70
Mild Steel (Old)	-0.50
Cast/Ductile Iron	-0.50
Stainless Steel	-0.50 to + 0.10
Copper, Brass, Bronze	-0.20
Gold	+0.20
Carbon, Graphite, Coke	+0.30

* Potentials With Respect to Saturated Cu-CuSO₄ Electrode

Thermit Weld to Pipe

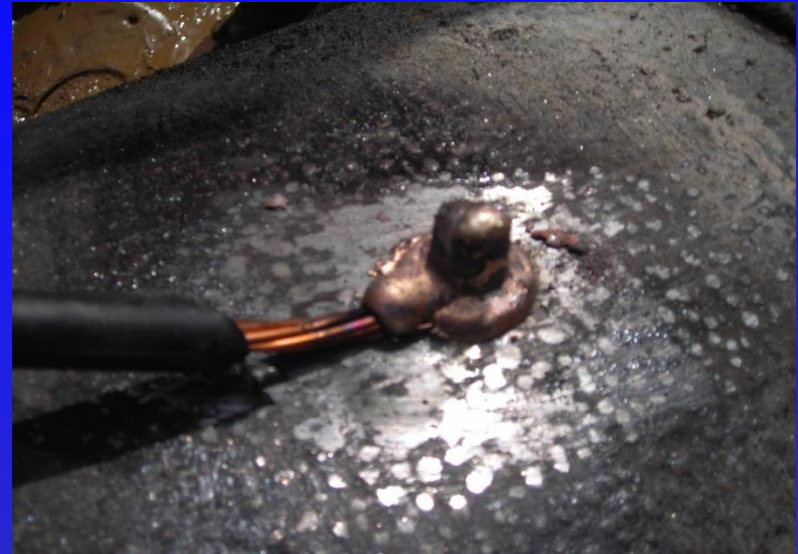



Access to Pipe

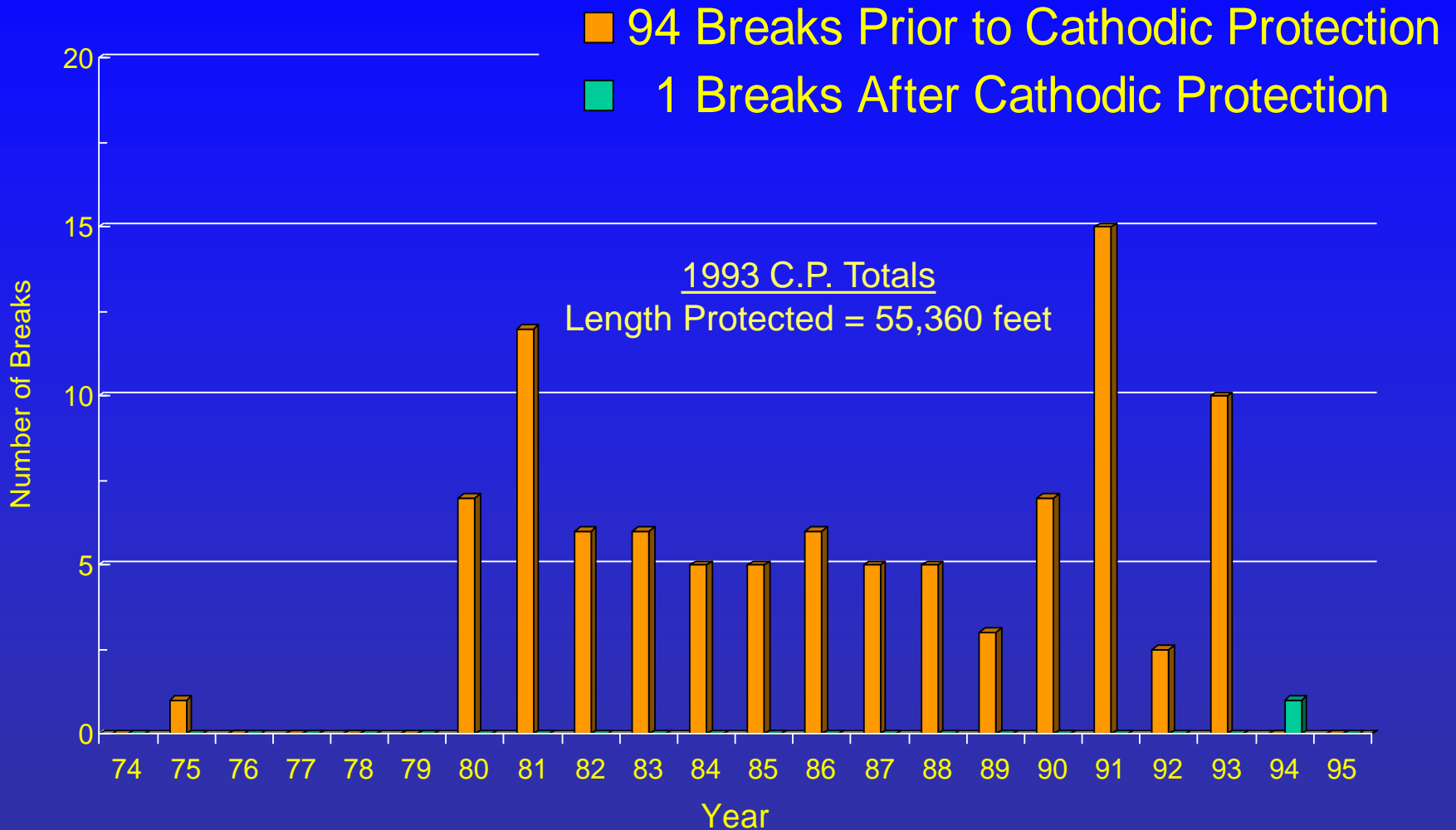

Break Records for Water Mains Cathodically Protected in 1993

Water Leak Repair Kit



Includes:

Installation instructions.

One day onsite technical assistance.

Cathodic protection components/connection materials suitable for 10 repairs.

Design Decision Model

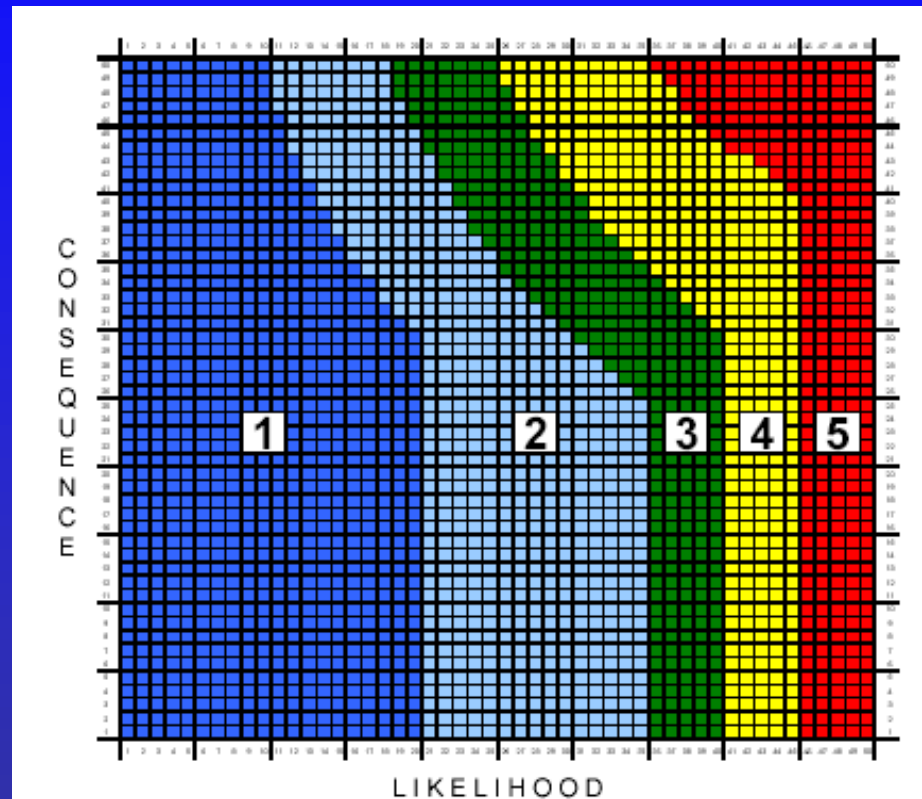

For Ductile Iron Pipe

Insituform



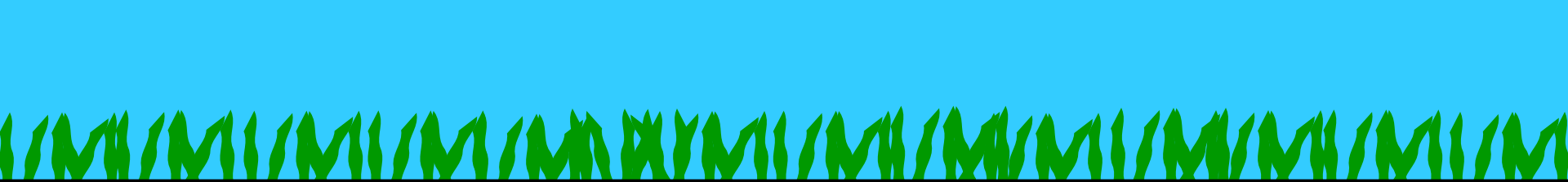

Anode Lead Wire Connection

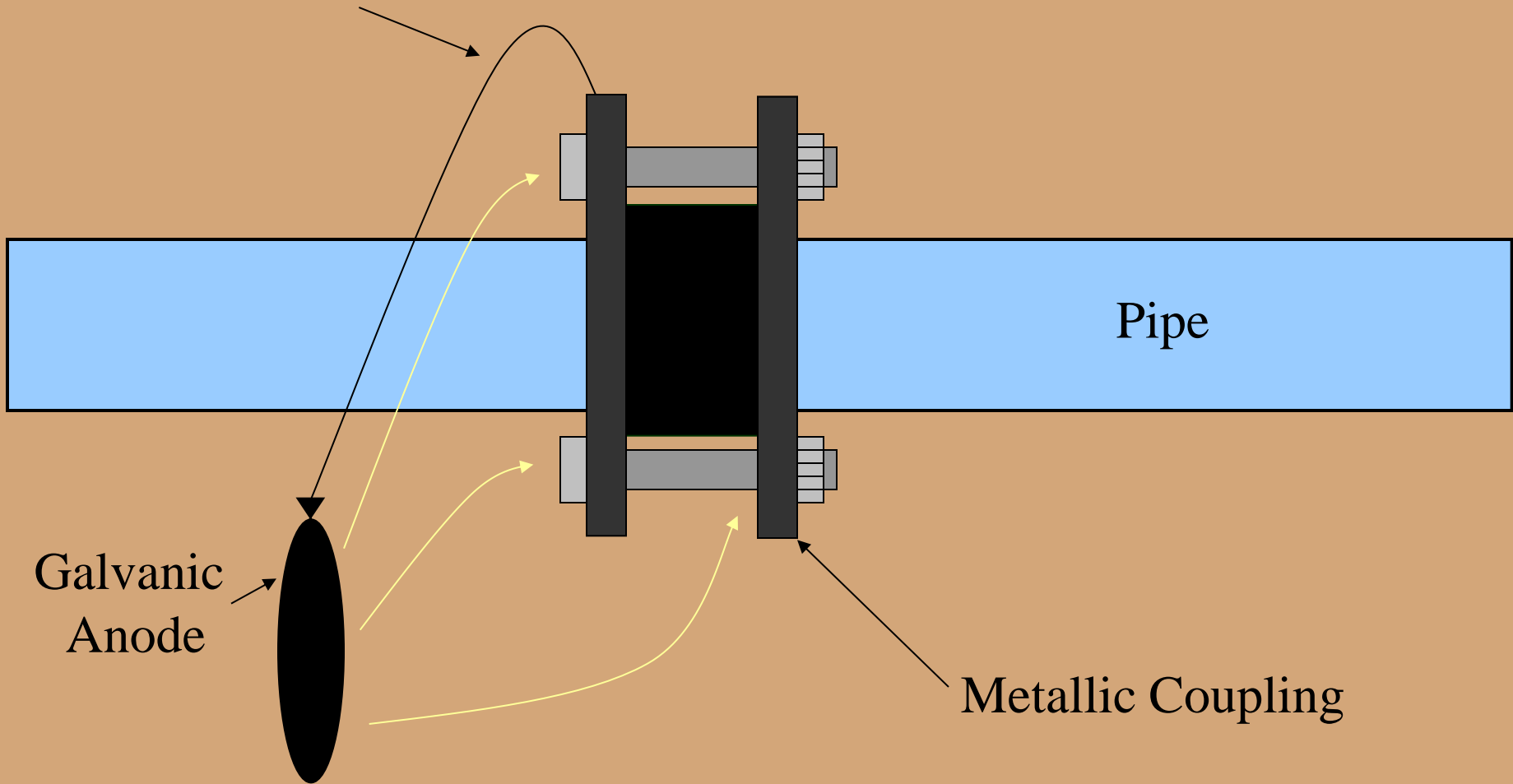

Galvanic Anode

Pipe

Metallic Coupling

Cathodic Protection of Metallic Fitting

Computerized Potential Logging Survey

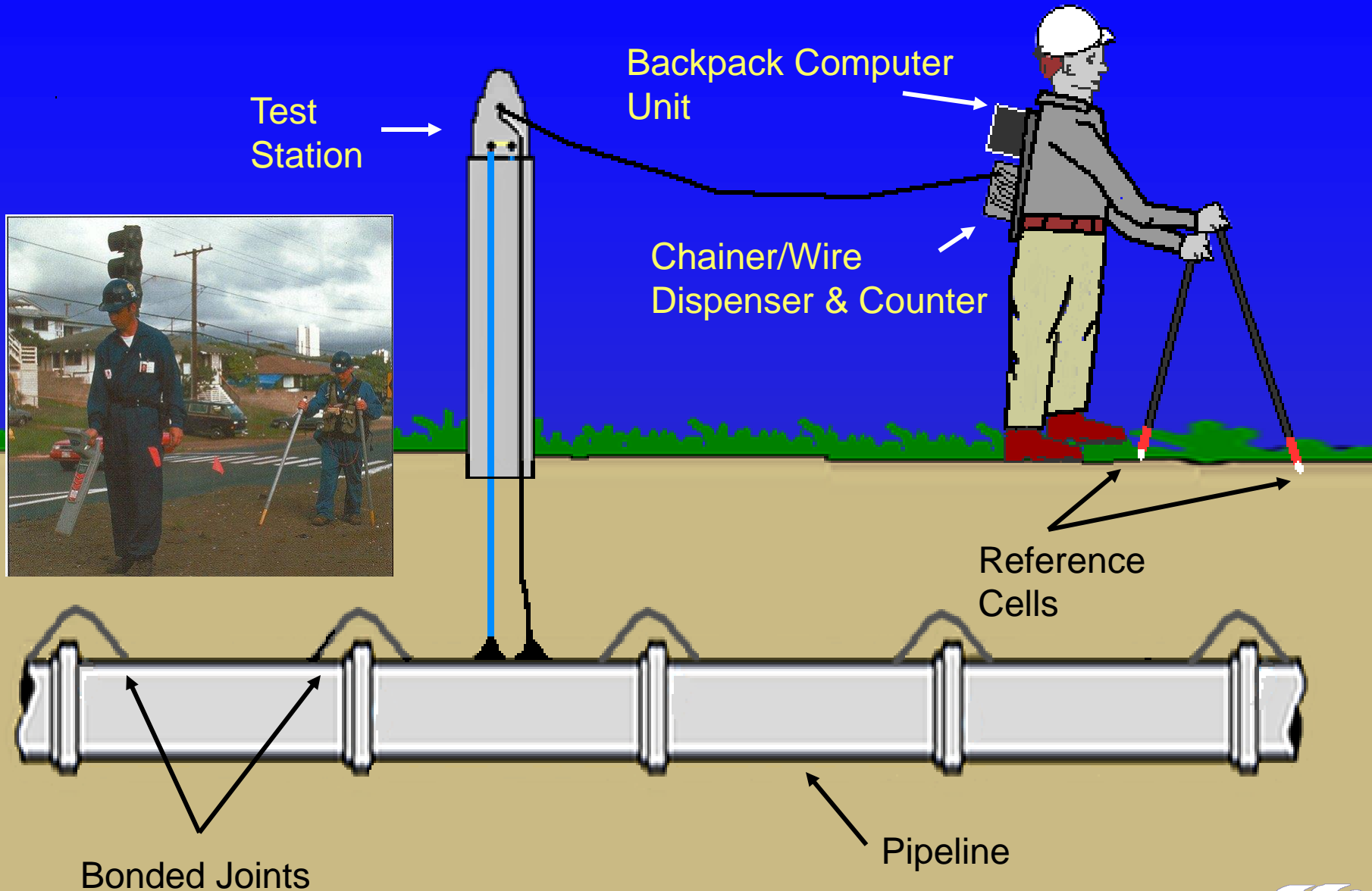

Corrosion of Metallic Structure

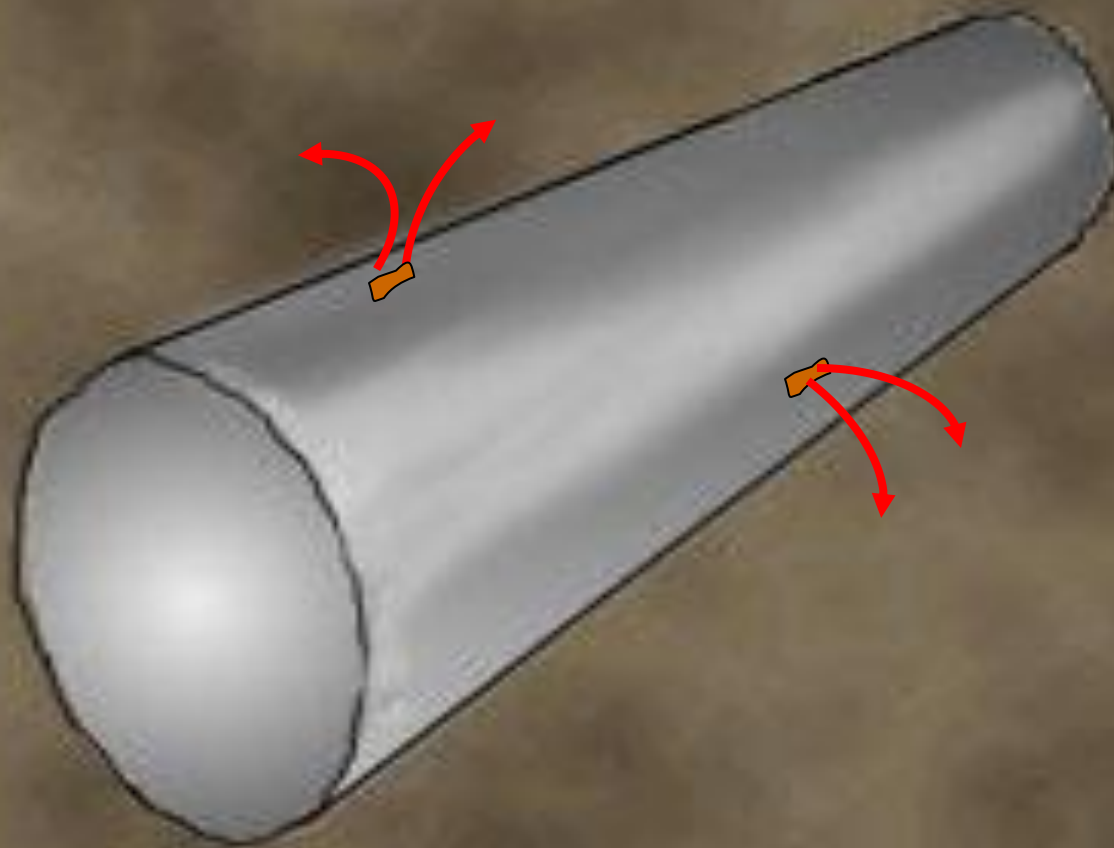

Vertically Suspended High Silicon Cast Iron Anode String

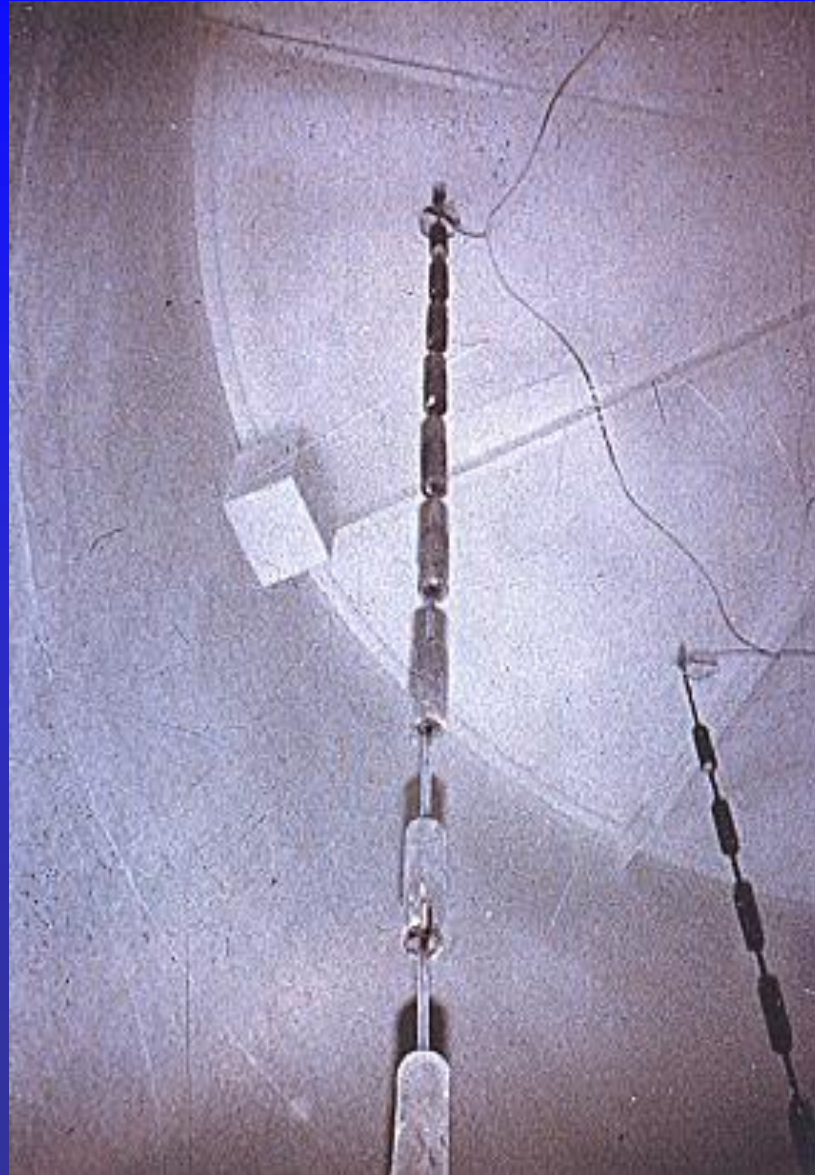

Design Decision Model

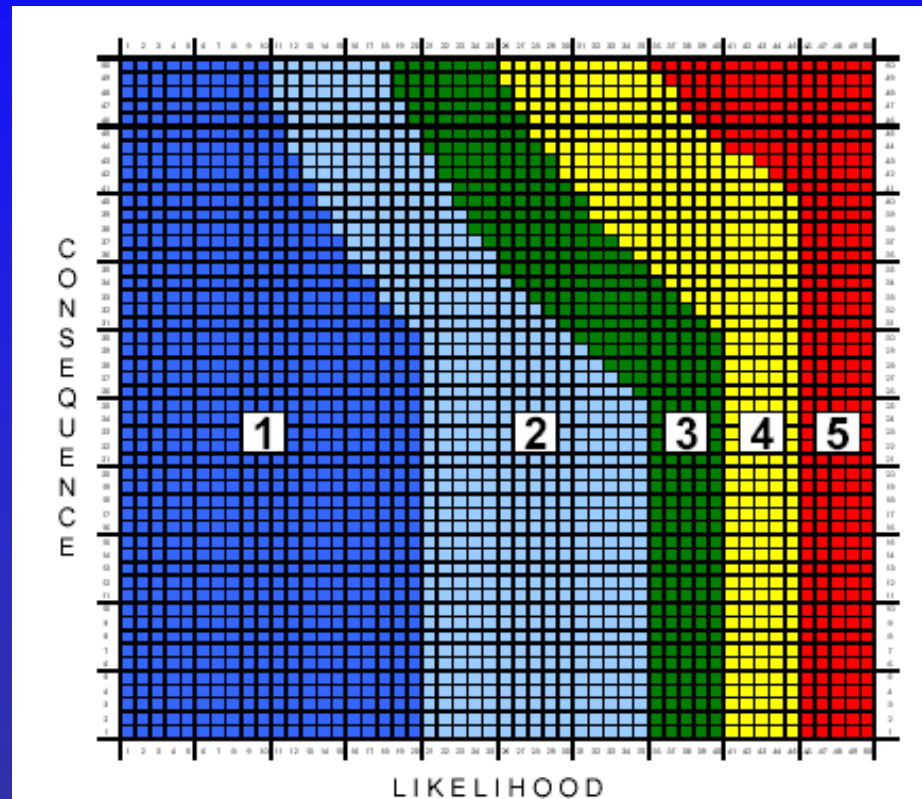

For Ductile Iron Pipe



27 10:23AM

Horizontally Submerged Cathodic Protection System in Water Storage Tank



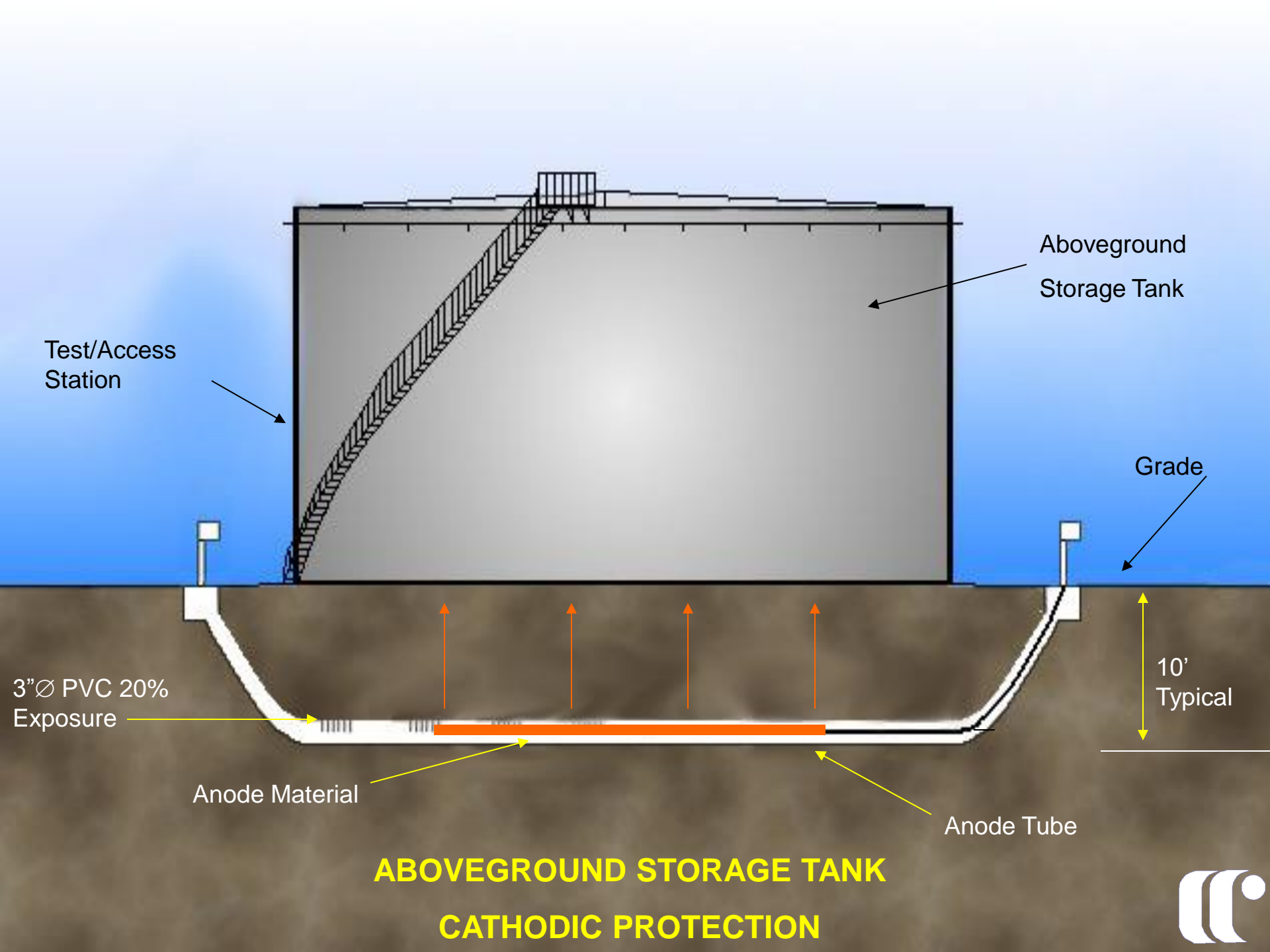

The estimated annual cost to repair water piping breaks in North America alone is estimated to be*:

\$1.5 Billion

& based on 250,000 breaks at a repair cost of \$5,875.00 U.S.D. each

**Budget Estimate for Complete
Cathodic Protection System for
1MMG Water Tank**

\$12,000

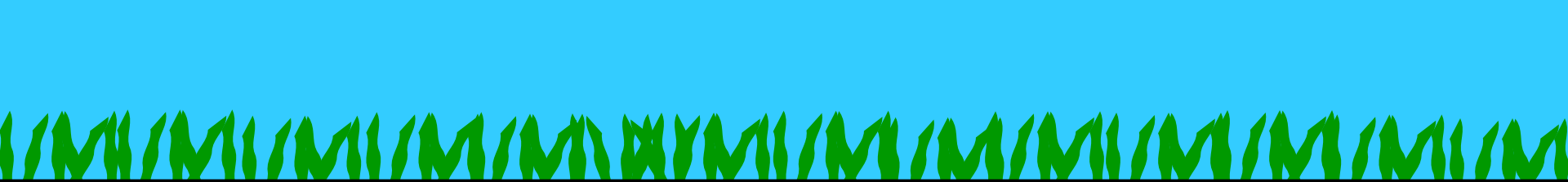

Lower Stress Area
(Cathode)

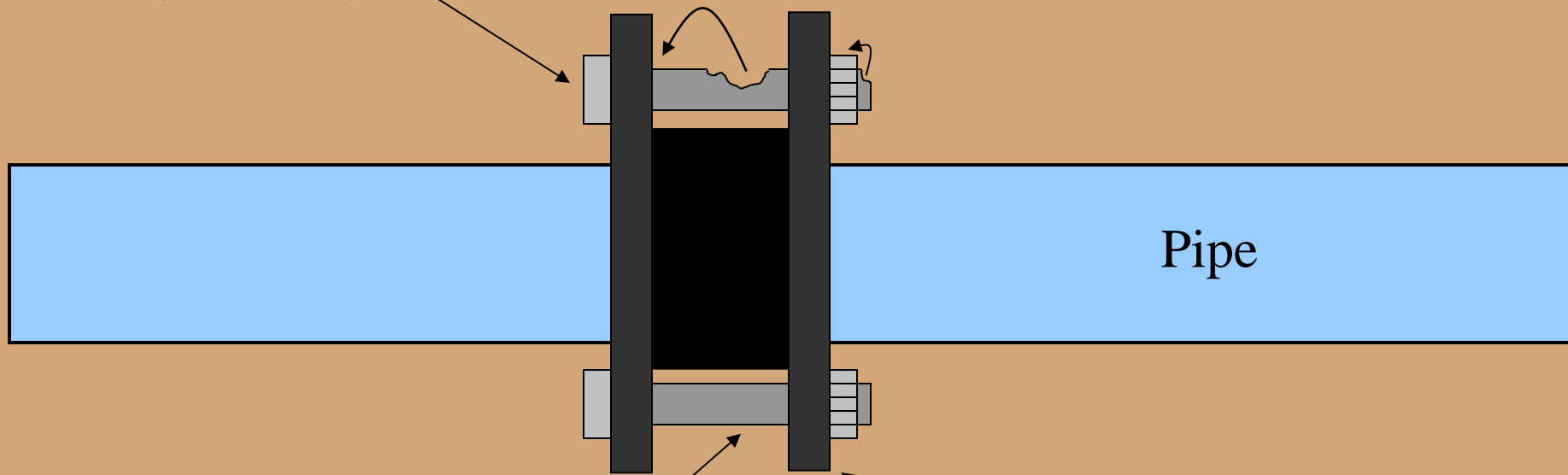
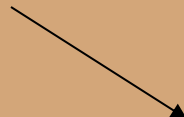

Pipe

Threaded Bolt
Higher Stress Area
(Anode)

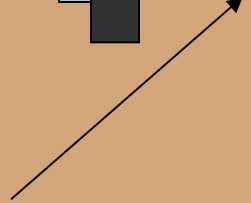

Metallic Coupling

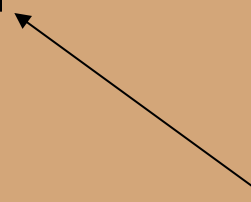

Stress Corrosion

Insituform



Corrosion Can be Defined as Either:

▶ Practical

Tendency of a Metal to Revert
to its Native State

▶ Scientific

Electrochemical Degradation
of Metal as a Result of a Reaction
with its Environment

Yard Piping Deep Anode Groundbed Impressed Current System

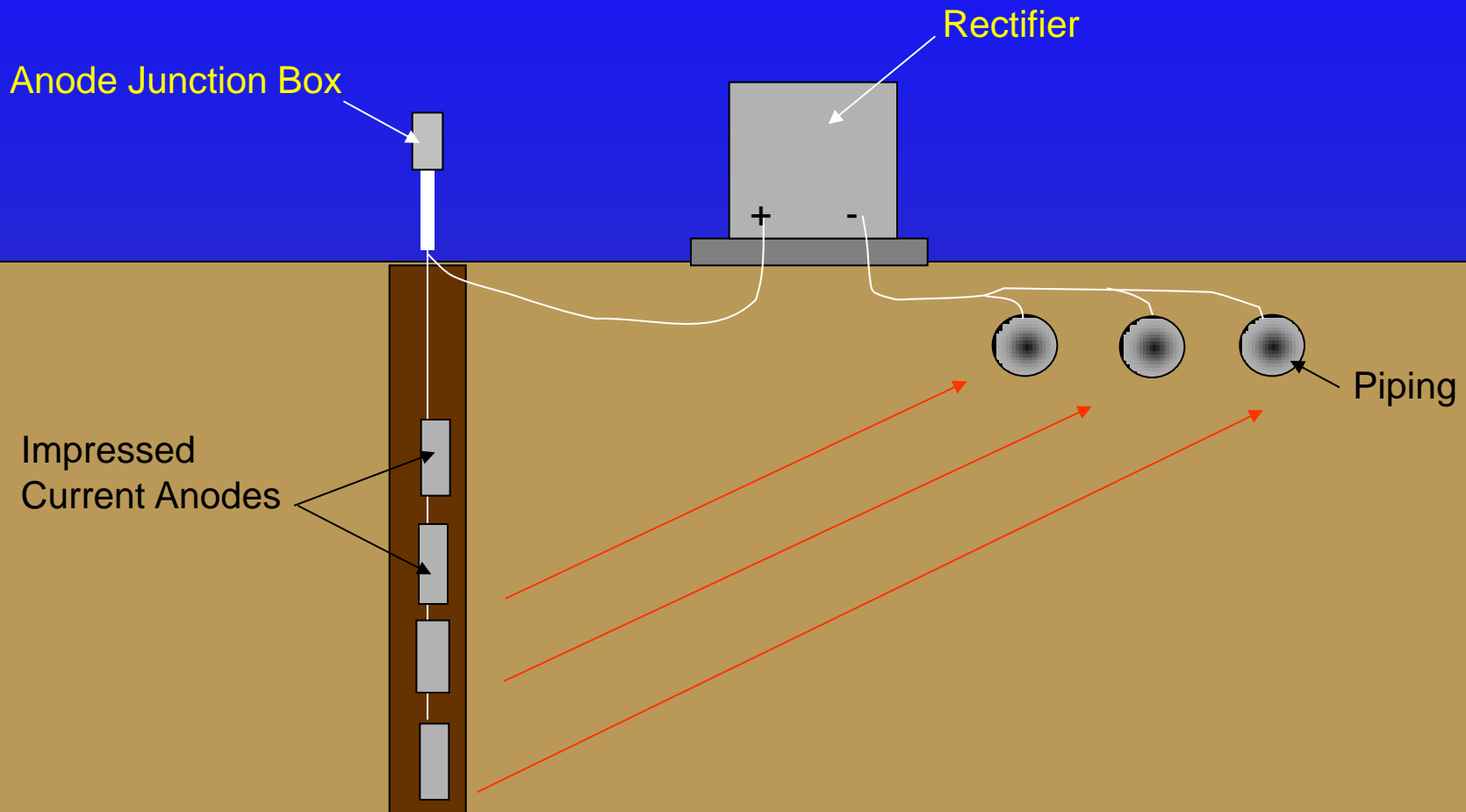

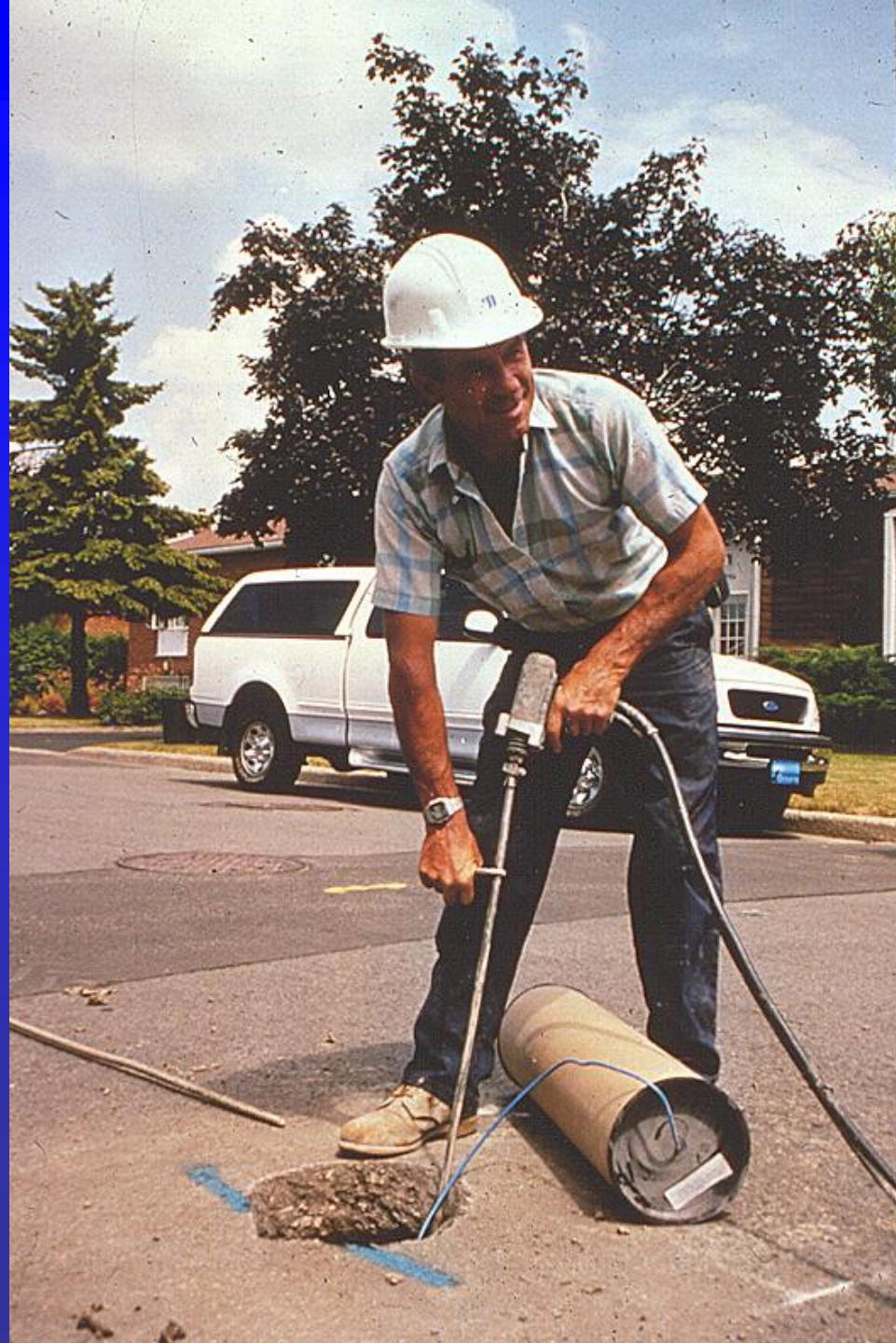



Factory Installed Cathodic Protection Systems

Bi-Metallic Corrosion Between Carbon Steel Tank & Stainless Steel Ladder



Corrosion Control for Water System Piping Results in Reduction of Water Loss

Presented By:

James T Lary

Corrpro Companies, Inc

1090 Enterprise Dr.

Medina, OH 44256

Tel. 330-723-5082 (x1215)

email: jlary@corrpro.com

<http://www.corrpro.com>



Repair of Break Should Include Anode Installation



Incomplete



Complete



Annual Cathodic Protection Survey



Corrosion Control for Water & Wastewater Systems

Presented By:

***James T Lary
Corrpro Companies, Inc
1090 Enterprise Dr.
Medina, OH 44256
Tel. 330-723-5082 (x1215)
email: jlary@corrpro.com
<http://www.corrpro.com>***





Corrosion is the leading contributor to cast and ductile iron water system breaks!



Bolt & Nut Corrosion



Inspection of CP System



Basic Corrosion Cell

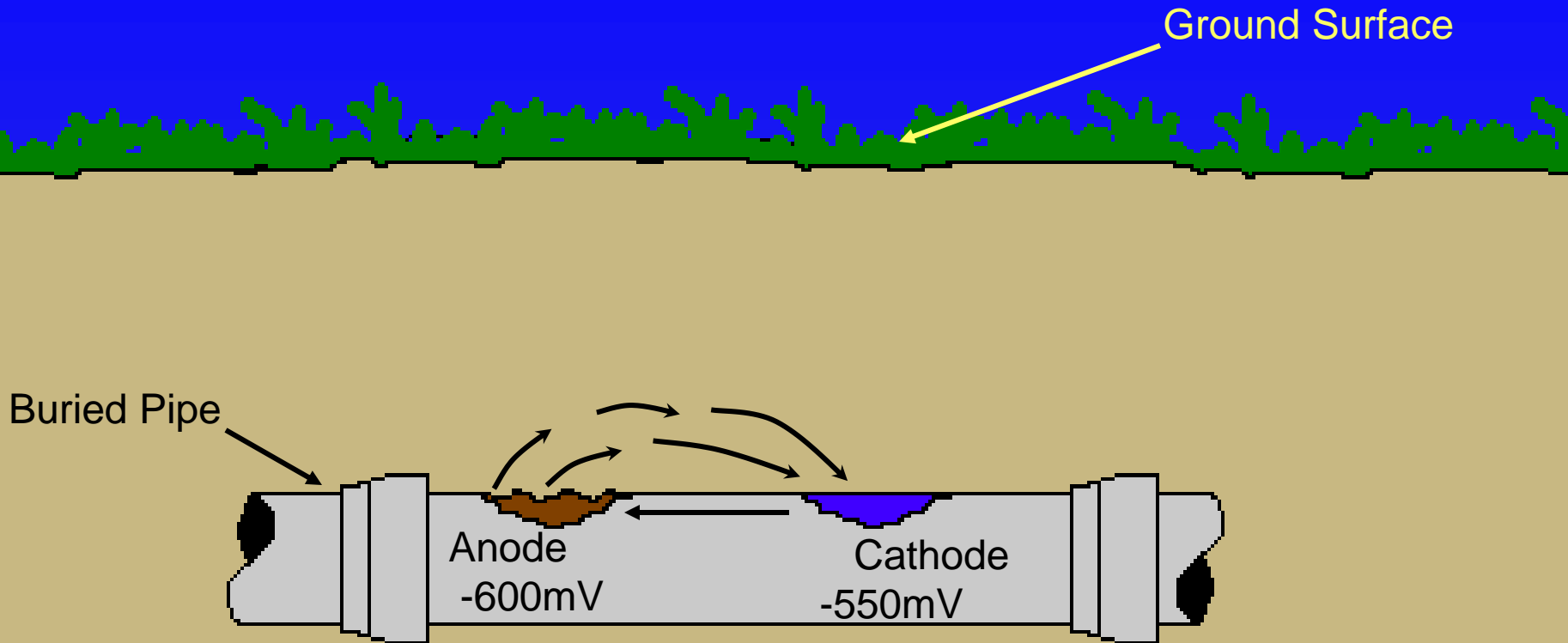

- 1) Anode
- 2) Cathode
- 3) Electrolyte
- 4) Electrical Connection

Structures

- ***Piping (Distribution/Transmission)***
- ***Metallic Fittings***
- ***Water Storage Tanks***
- ***Clarifier Units***
- ***Lift Stations***

Corrosion Can be Defined as Either:

▶ Practical

Tendency of a Metal to Revert to its Native State

▶ Scientific

Electrochemical Degradation of Metal as a Result of a Reaction with its Environment

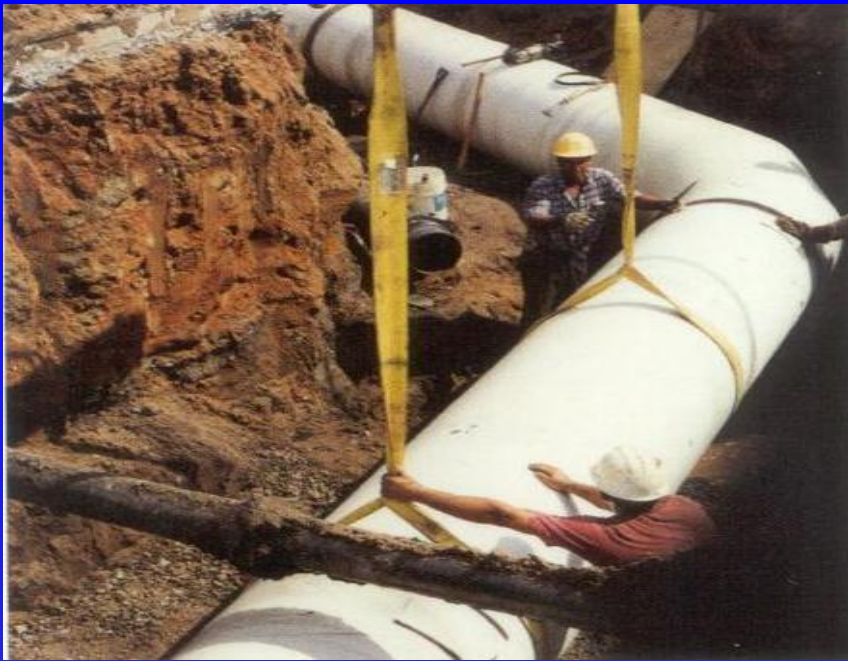

Copper Service Connections



Anode Installation Prevents Corrosion on Copper Service Line

Non metallic or
Polyethylene Encased
Ductile Iron Main

Anode Connection to Line

Anode



Stainless Steel Bowl Shaft

Bronze Shaft Spacers (Cathode)

Mild Steel Column Pipe (Anode - Corrodes)

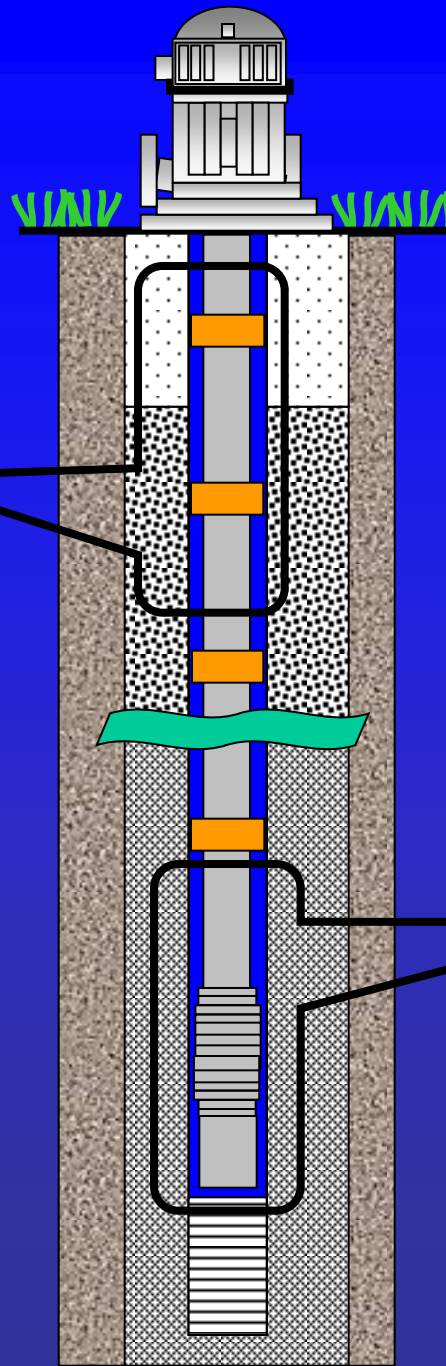
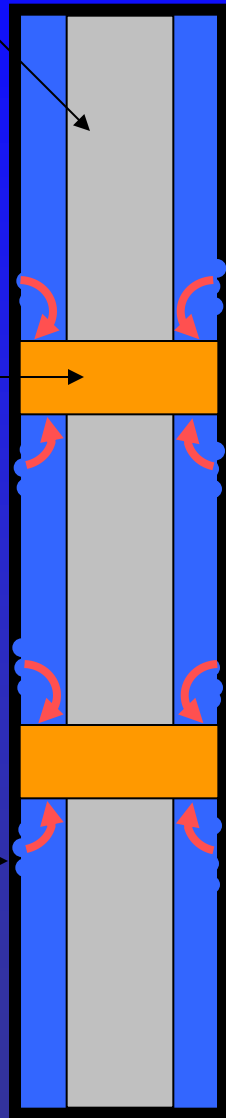

Bowl Shaft (Stainless Steel) Cathode

Crown (Steel) Anode

Crown Bearing (Bronze) Cathode

Discharge Case (Cast Iron) Anode

Impeller (Bronze) Cathode

Bowls (Cast Iron) Anode

Suction Case (Cast Iron) Anode

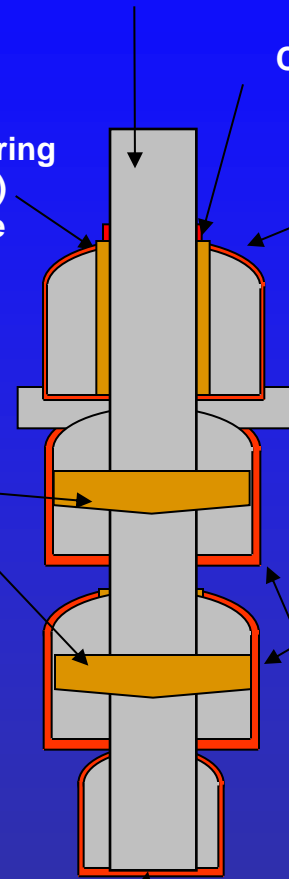

Water Wells



Stainless Steel Corrosion



Polyethylene Encasement



- Follow manufacture's and AWWA recommendations to insure proper installation of polyethylene encasement.
- In extremely corrosive areas, additional methods (bonding of joints, cathodic protection, may be required).





History of Iron Pipe

Cast Iron

- Introduced to North America during the 1800's and installed till the 1970's.
- Early on, statically cast process produced a thick walled, heavy pipe.
- No longer produced in North America.

Ductile Iron

- Introduced in 1955 as an improvement to cast iron.
- Centrifugal casting process produces a thinner walled, lighter pipe which is stronger and more ductile than cast iron.

Dissimilar Soils

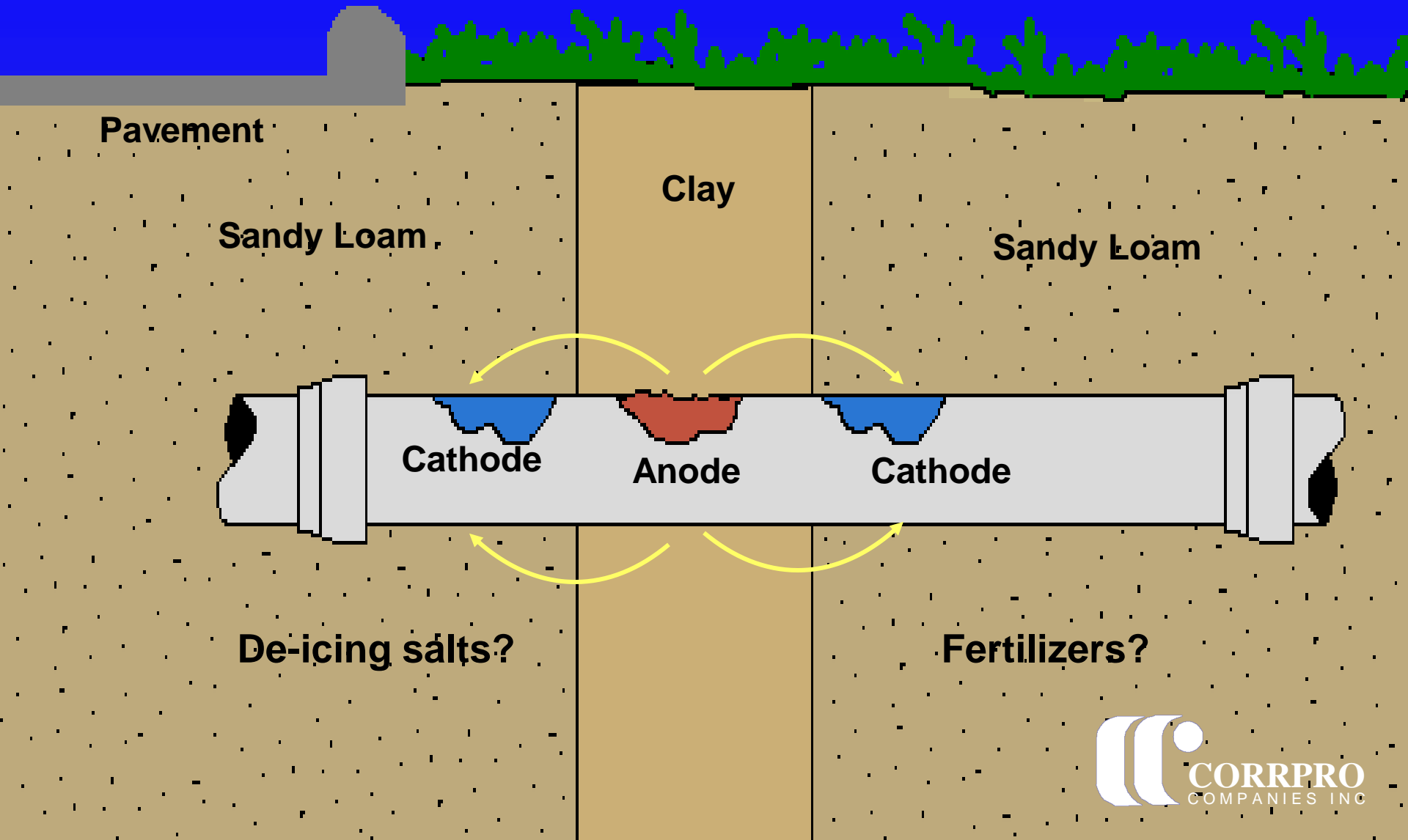

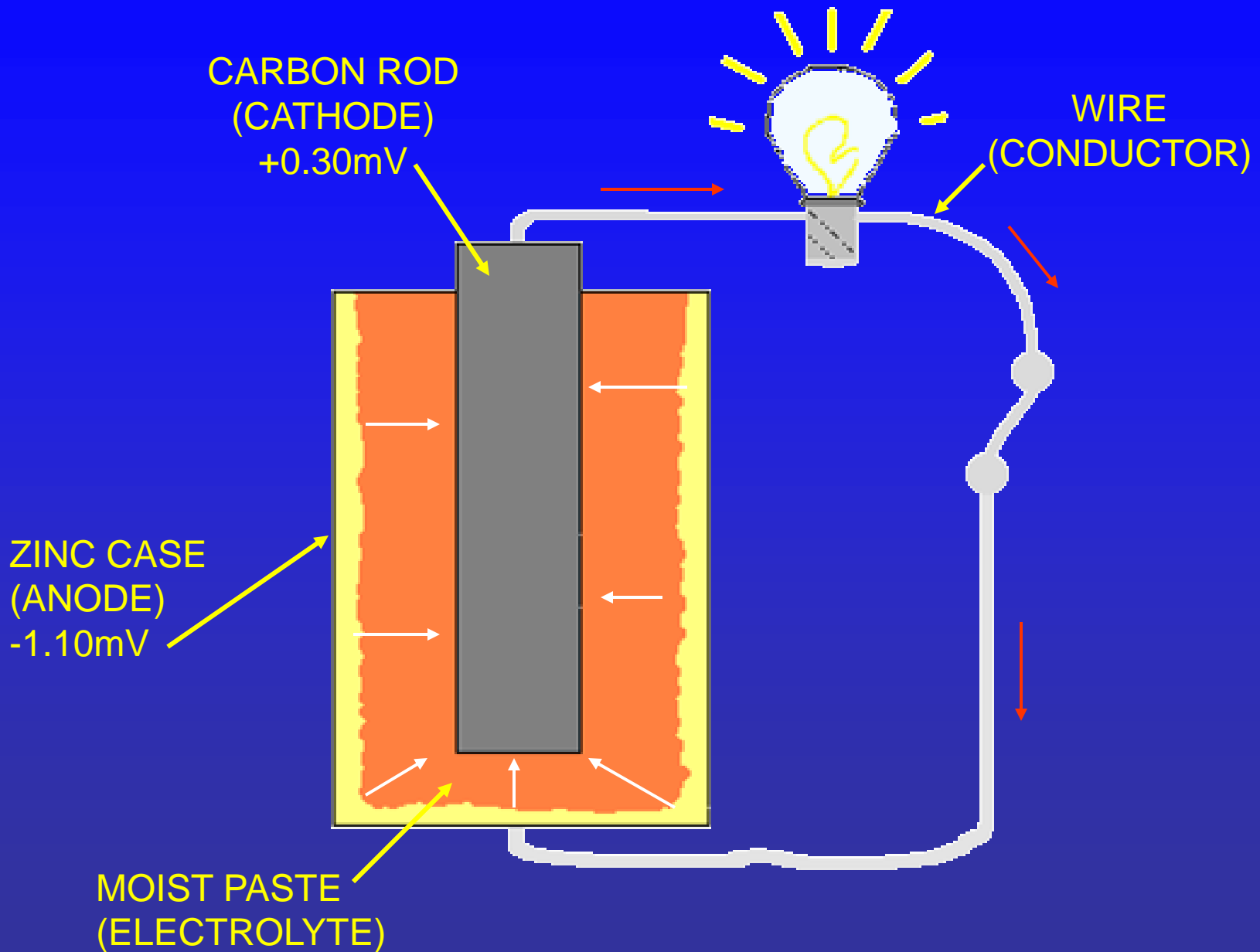



Corrosion of iron when coupled to copper service line.

Corrosion Pitting



Dissimilar Surface Conditions

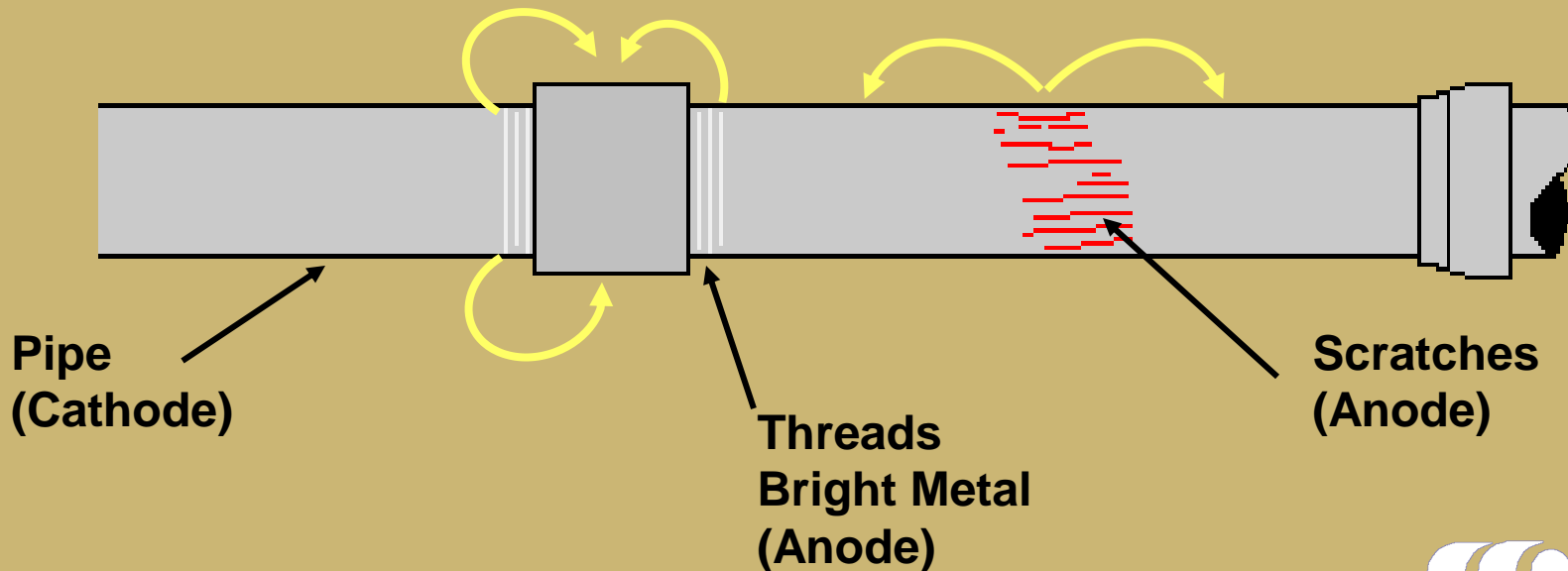

Corrosion Caused by Differential Aeration

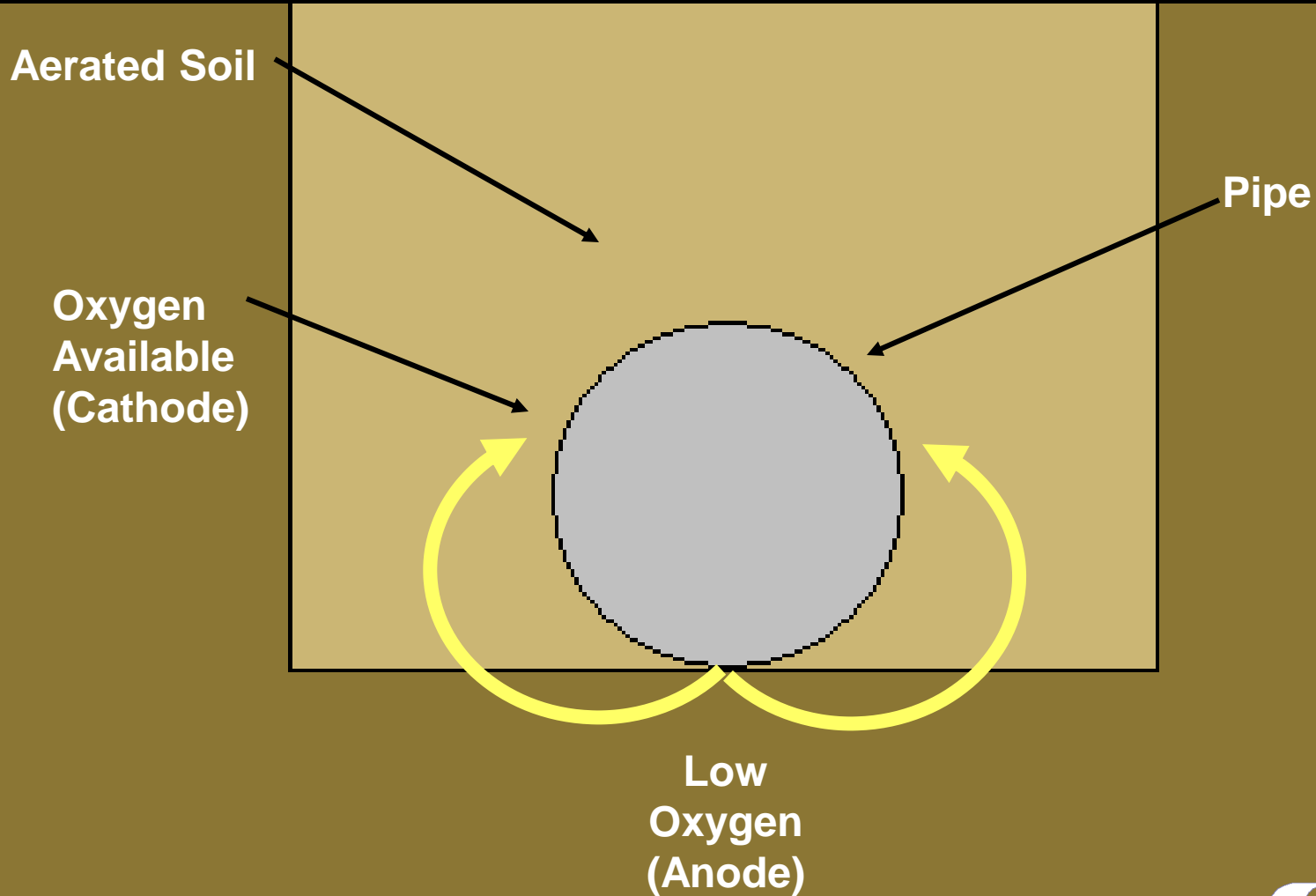

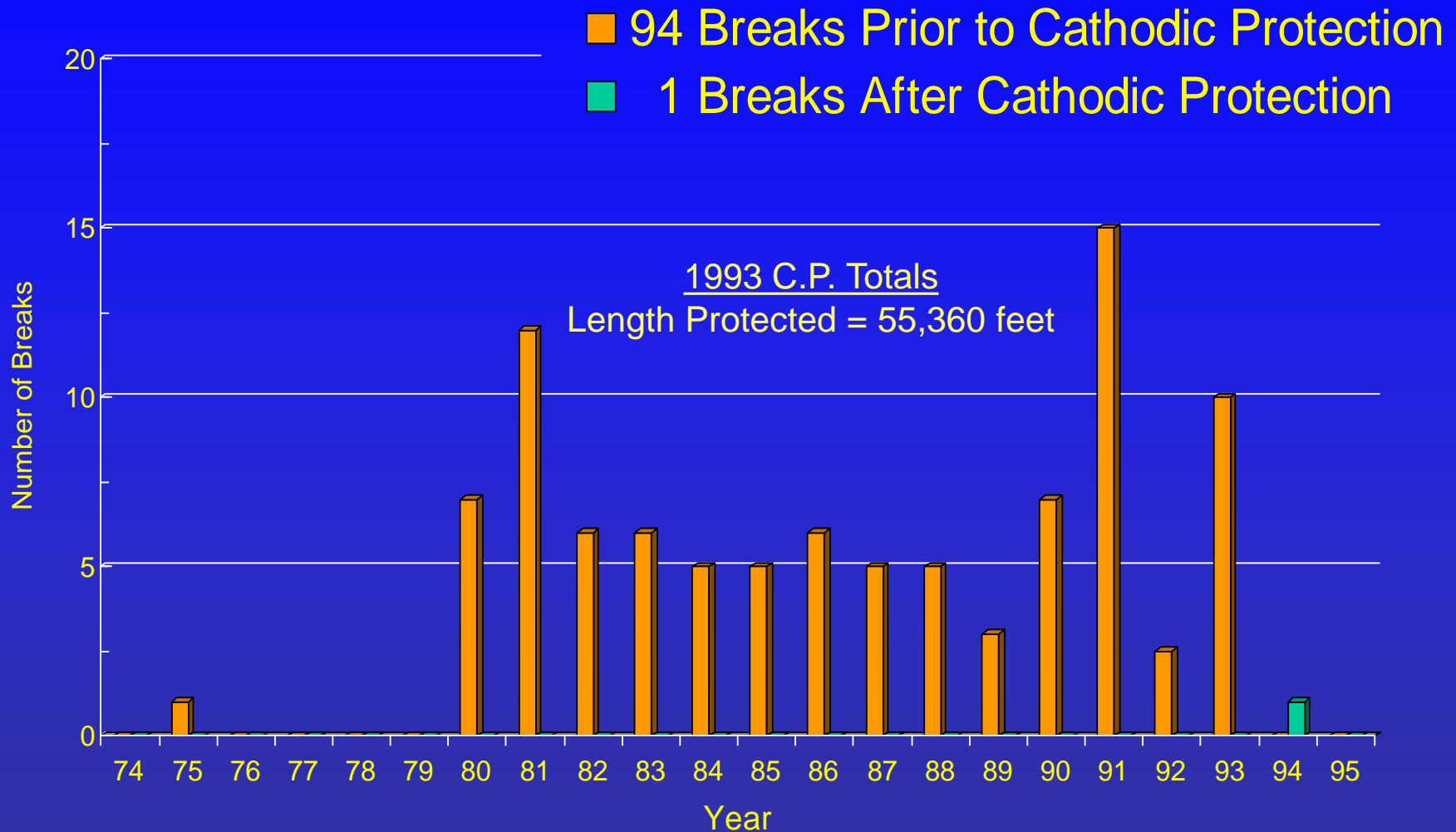

Break Records for Water Mains Cathodically Protected in 1993

**Traffic
Disruptions**



Water Loss



**Fire
Protection**

Damages



**Legal &
Environmental
Claims**





Corrosion on damaged polyethylene encased pipe.



Corrosion of pre-stressed concrete cylinder pipe (P.C.C.P.).

Suspended Vertical Anode System

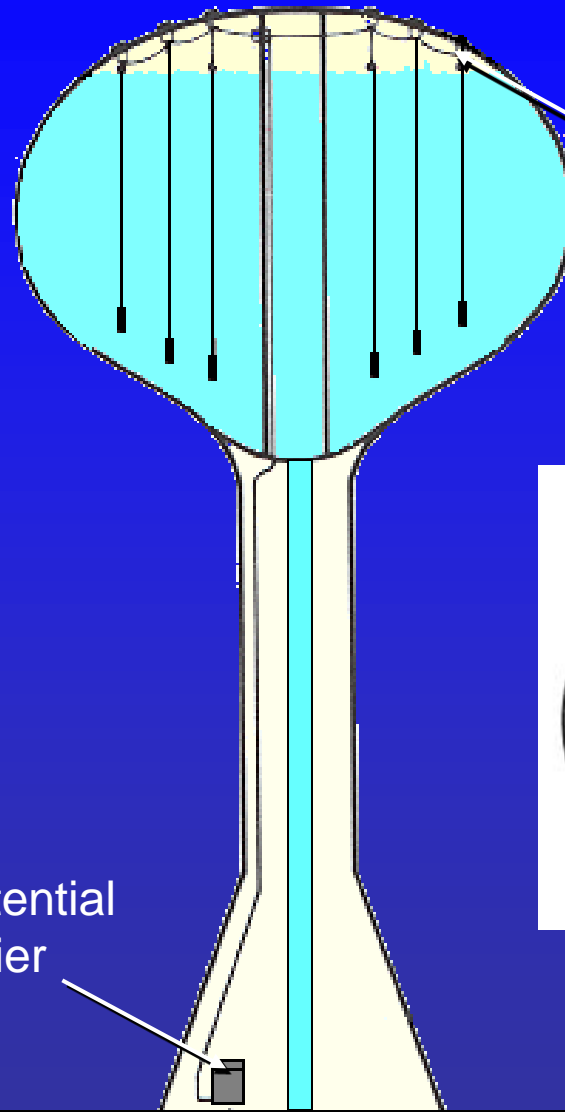

Support System Bolted to Roof for Bowl Anodes and Reference Electrodes

Automatic Potential Control Rectifier

Top View Diagram

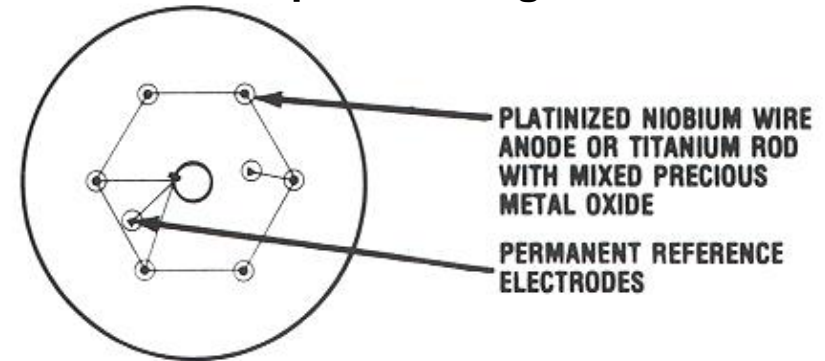





Corrosion



PCCP Failure



Stray Current by DC Operated Transit Systems

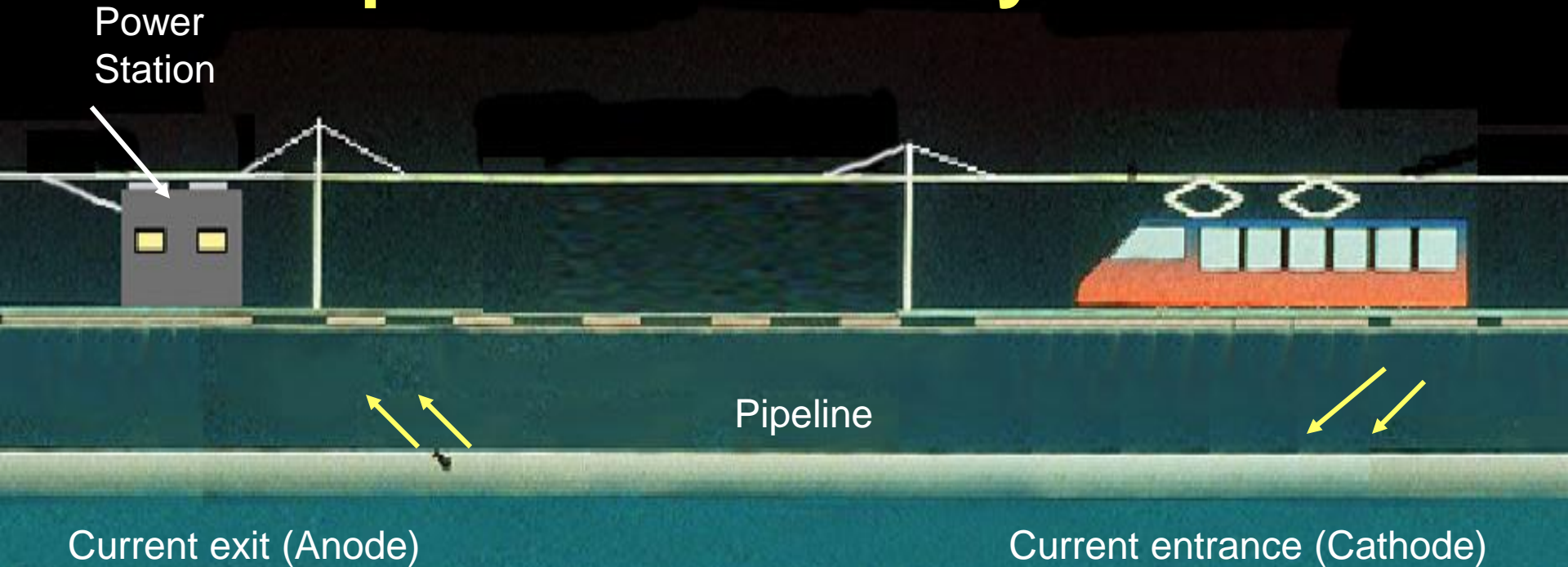



Pre-stressed Concrete Cylinder Pipe (PCCP)

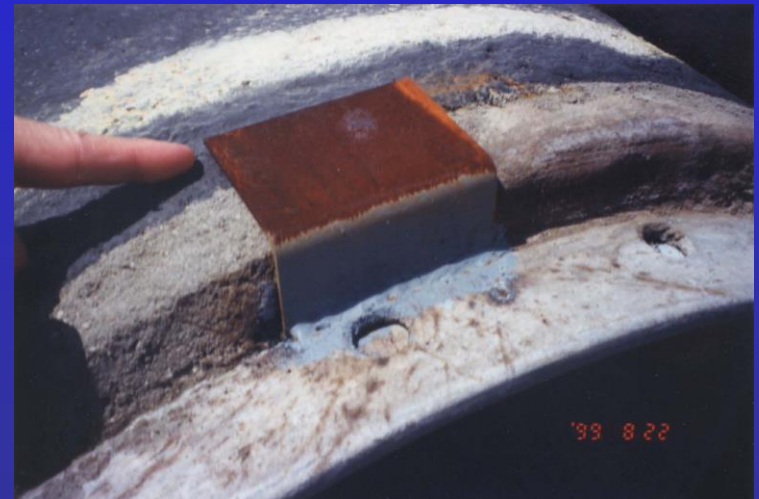

Give Me a Break Fundamentals of Pipeline Corrosion



***Presented By:
James T Lary
Corrpro***

***1090 Enterprise Dr.
Medina, OH 44256
Tel. 330-723-5082 (x1215)
email: jlary@corrpro.com
<http://www.corrpro.com>***

corrpro®

Corrosion Control & Cathodic Protection of Water & Wastewater Systems



Presented By:
James T Lary
Corrpro
1090 Enterprise Dr.
Medina, OH 44256
Tel. 330-723-5082 (x1215)
email: jlary@corrpro.com
<http://www.corrpro.com>



Coating Flaws (Holidays)



Pipeline Inspection Report

Inspector name _____ Date _____ Address of pipeline inspection _____ Leak? Yes _____ No _____ File Number: _____

- 1) Type of Pipe: cast iron _____ ductile iron _____ carbon steel _____ copper _____ carbon steel _____ non metallic _____ other _____
- 2) Diameter of pipe _____" Pipeline Name _____ Service Type: Water _____ Wastewater _____ Estimated date of pipe installation _____ Depth of pipe _____'
- 3) Type of Pipe: Distribution _____ Transmission _____ Service _____ Hydrant _____ Mechanical joint _____ Fasteners _____ Other _____ Unknown _____
- 4) Type of Coating: Polyethylene Encased _____ Shop applied coating _____ No Coating _____ Tape Wrap _____ Unable to determine _____
- 5) External Pipe Condition: Very Good _____ Good _____ Poor _____ comments: _____

6) Is corrosion pitting evident? _____ Yes _____ No Number of Pits _____ Typical Size of Pits _____ Quantity of pits: _____

7) Is graphitization evident (longitudinal or circumferential breaks) _____ Yes _____ No

8) Is the pipe installed in (check off appropriate items): Industrial area _____ Residential area _____ Rural area _____ Near street or road _____
Near creek or waterway _____ In reclaimed land _____ Near oil or gas pipelines _____ Near high voltage lines _____.

8) Describe soil conditions where inspection occurred: wet _____ dry _____ clay soil _____ rocky soil _____ cinders _____ other _____

9) Where soil samples obtained, sealed and analyzed for chlorides, moisture content, pH, sulfides, resistivity? If yes results were: _____

10) Were previous repairs made on the pipeline (leak clamps, etc) Yes _____ No _____. Was new pipe installed _____ Yes _____ No.

11) Was a repair clamp installed on the pipe during inspection _____ Yes _____ No

12) Was a galvanic anode installed as part of the inspection process? _____ Yes _____ No, if yes size and quantity

13) Please relay additional comments: _____

14) Plan of Action _____

15) Insert digital photos below:





CIS Survey

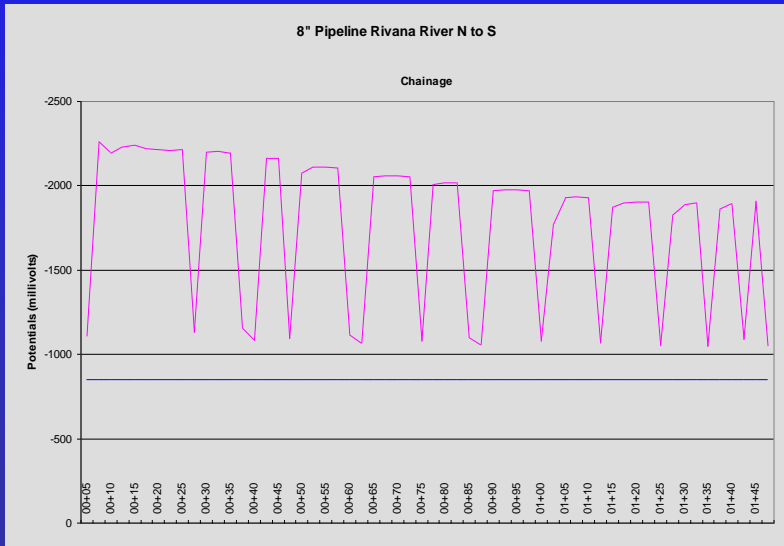

Close Interval Data
Interrupted Survey

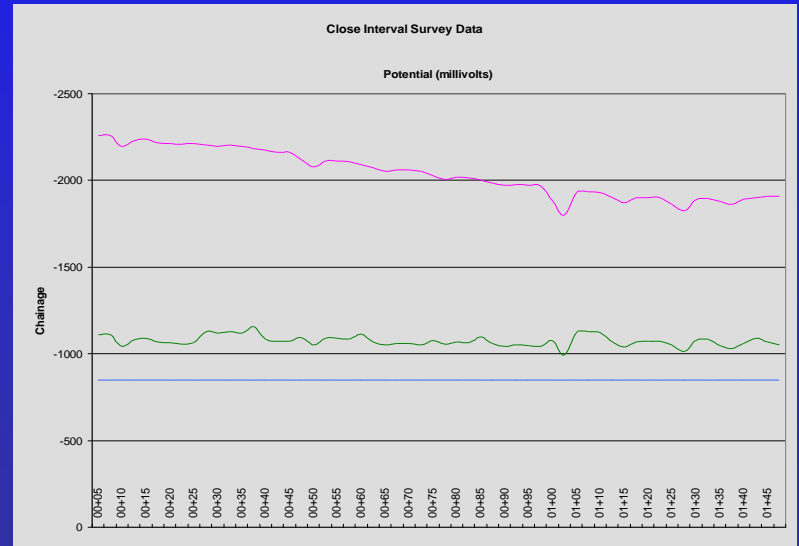

Close Interval Data
PG/WFA Survey

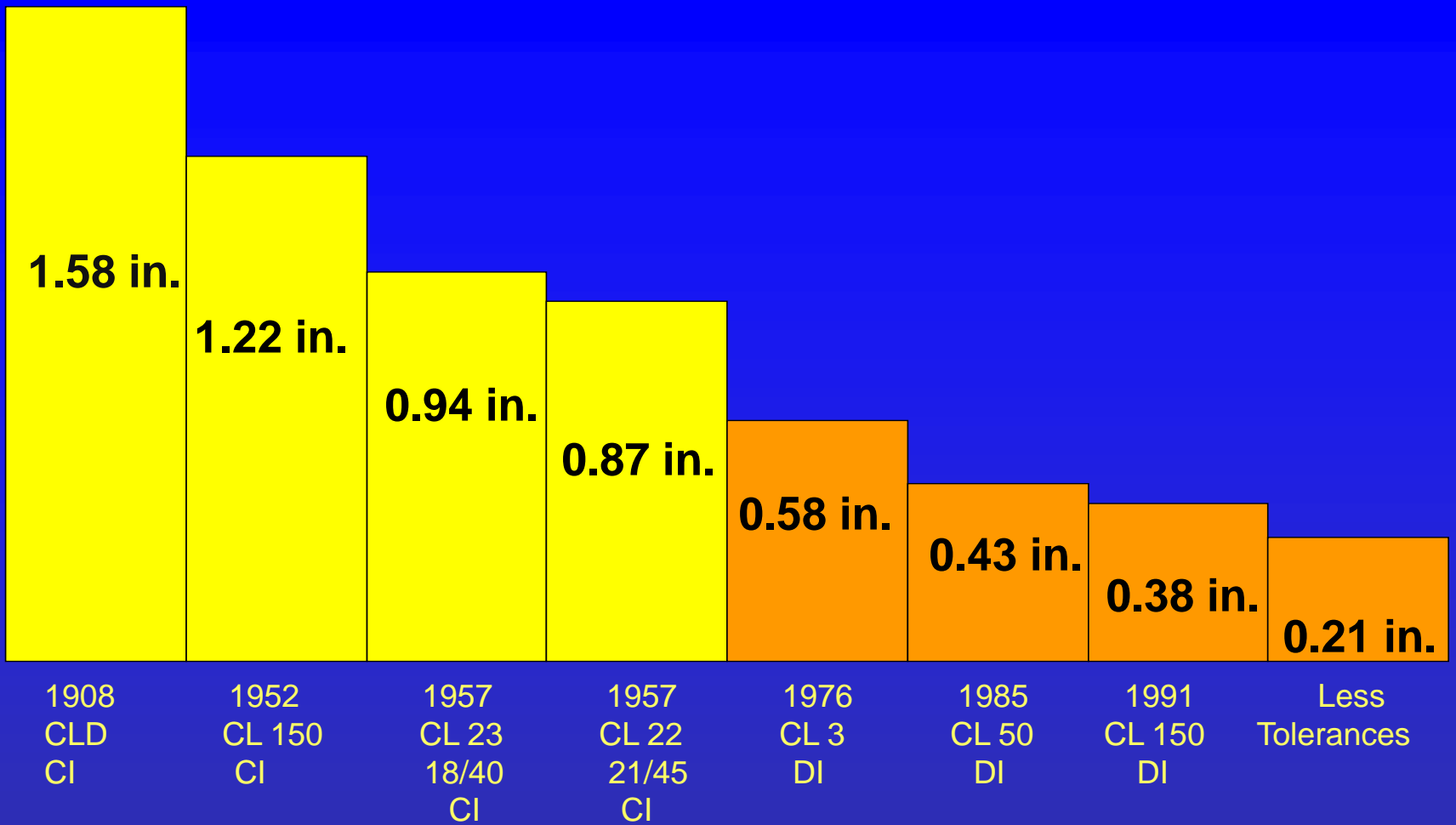

Actual size of AWWA Specification Thickness Reductions for 36-inch Diameter Cast and Ductile Iron Pipe - 1908 to Present (150 PSI Operating pressure)

Dissimilar Surface Conditions

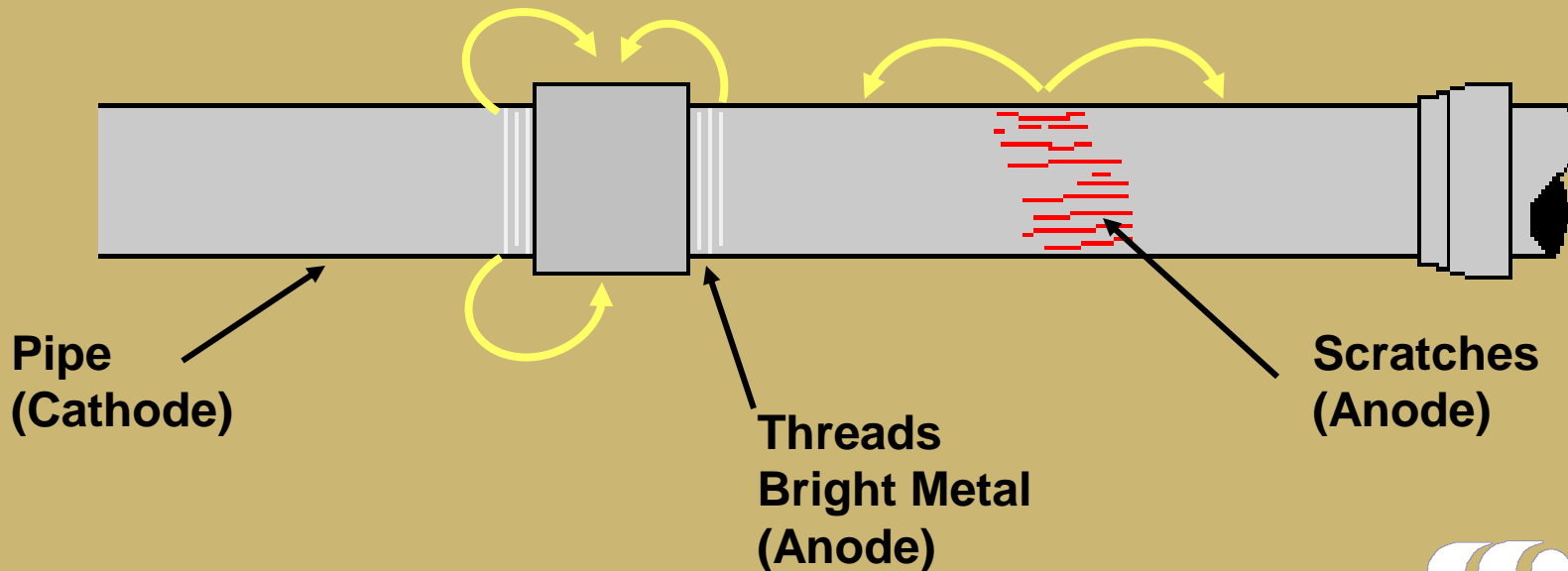

Corrosion Caused by Differential Aeration

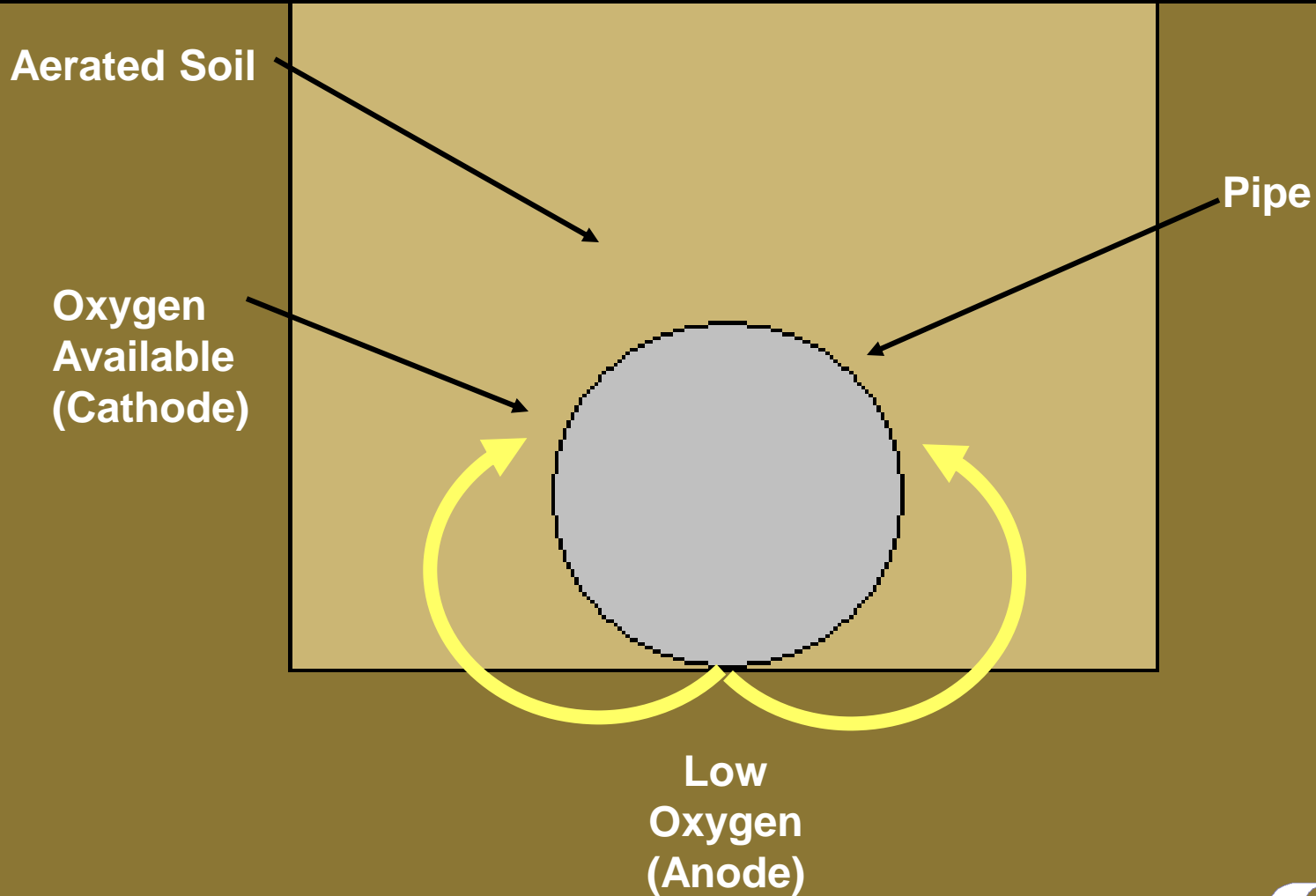

Coating Flaws (Holidays)



Meter Vaults



(Keep dry if possible)

Water Wells



Galvanic Anode on Polyethylene Encased Ductile Iron Pipe

