

The logo features the letters 'GEO' in a bold, blue, sans-serif font with a 3D effect. The letter 'O' is a large circle containing a smaller, gold-colored number '2'. The background is a dark, textured surface with a repeating diamond pattern and scattered blue and gold geometric shapes like triangles and lines.

# GEO<sup>2</sup>

OPERATORS MANUAL



# ⚠ WARNING

## ADHERE STRICTLY TO THESE AND ALL OTHER SAFETY INSTRUCTIONS AND GUIDELINES!

- 01. PLEASE READ AND UNDERSTAND ALL INSTRUCTION MANUALS BEFORE USE.**
- 02. The Eclipse Geo2 is not a toy. PAINTBALL SAFETY RULES MUST BE FOLLOWED AT ALL TIMES.**
- Careless or improper use, including failure to follow instructions and warnings within this User Manual and attached to the Geo2 could cause death or serious injury.
- Do not remove or deface any warnings attached to the Geo2.
- Paintball industry standard eye/face/ear and head protection designed specifically to stop paintballs and meeting ASTM standard F1776 (USA) or CE standard (Europe) must be worn by user and any person within range. Proper protection must be worn during assembly, cleaning and maintenance.
- Never shoot at a person who is not wearing proper protection.
- Never look directly into the barrel of the marker. Accidental discharge into the eyes may cause permanent injury or death. Never look into the barrel or breech area of the Geo2 whilst the marker is switched on and able to fire.
- Keep the Geo2 switched off until ready to shoot.
- Treat every marker as if it is loaded and ready to fire.
- The electronic on/off is the markers safety, always switch off the marker when not in use.
- Always fit a barrel-blocking device to the Geo2 when not in use.
- Always remove all paintballs from the Geo2 when not in use on the field of play.
- Never point the Geo2 at anything you do not intend to shoot.
- Do not shoot at persons at close range.
- Do not field strip or remove any parts while the marker is pressurised.
- Do not pressurise the Geo2 without the bolt system correctly installed, as high-pressure gas will be emitted.
- Do not fire the Geo2 without the bolt system correctly installed.
- Never put your finger or any foreign objects into the paintball feed tube of the Geo2.
- Never allow pressurised gas to come into contact with any part of your body.
- Always remove the first stage regulator and relieve all residual gas pressure from the Geo2 before disassembly.
- Always remove the first stage regulator and relieve all residual gas pressure from the Geo2 for transport and storage.
- Always follow guidelines given with your first stage regulator for safe transportation and storage.

# ⚠️ WARNING

## ADHERE STRICTLY TO THESE AND ALL OTHER SAFETY INSTRUCTIONS AND GUIDELINES!

23. Always store the Geo2 in a secure place.
24. Persons under 18 years of age must have adult supervision when using or handling the Geo2.
25. Observe all local and national laws, regulations and guidelines.
26. Use only professional paintball fields where codes of safety are strictly enforced.
27. Use compressed air/nitrogen only. **DO NOT** use any other compressed gas or pressurised liquid including CO<sub>2</sub>.
28. Always follow instructions, warnings and guidelines given with any first stage regulator you use with the Geo2.
29. Use 0.68 calibre paintballs only.
30. Always measure your markers velocity before playing paintball, using a suitable chronograph.
31. Never shoot at velocities in excess of 300 feet (91.44 meters) per second, or at velocities greater than local or national laws allow.
32. Any installations, modifications or repairs should be carried out by a qualified individual at a licensed and insured paintball facility.



**THIS USERS MANUAL IS IN ENGLISH.**  
It contains important safety guidelines and Instructions. Should you be unsure at any stage, or unable to understand the contents within this manual you must seek expert advice.

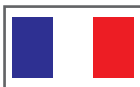

**LE MODE D'EMPLOI EST EN ANGLAIS.**  
Il contient des instructions et mesures de sécurité importantes. En cas de doute, ou s'il vous est impossible de comprendre le contenu du mode d'emploi, demandez conseil à un expert.



**ESTE MANUAL DE USUARIOS (OPERARIOS) USARIOS ESTÁ EN INGLÉS.**

Contiene importantes normas de seguridad e instrucciones. Si no está seguro de algún punto o no entiende los contenidos de este manual debe consultar con un experto.



**DIESE BEDIENUNGS - UND BENUTZERANLEITUNG IST IN ENGLISCH.**

Sie enthält wichtige Sicherheitsrichtlinien und -bestimmungen. Sollten Sie sich in irgendeiner Weise unsicher sein, oder den Inhalte dies Heftes nicht verstehen, lassen Sie sich bitte von einen Experten beraten.

**NOTE: THIS USER MANUAL MUST ACCOMPANY THE PRODUCT IN THE EVENT OF RESALE OR NEW OWNERSHIP. SHOULD YOU BE UNSURE AT ANY STAGE YOU MUST SEEK EXPERT ADVICE! (SEE SERVICE CENTRES PAGE 69-71)**



## 6 ORIENTATION

Names the component parts of the Geo2 Marker. This section is essential reading for everyone.

- 6 > KNOW YOUR GEO2
- 7 > ECLIPSE SHAFT4 BARREL
- 8 > SL3 INLINE REGULATOR
- 9 > GEO2 BOLT SYSTEM
- 10 > GEO2 SOLENOID ASSEMBLY
- 11 > THE GEO2 NAVIGATION CONSOLE
- 12 > OPERATIONAL OVERVIEW

## 13 QUICK SET-UP

Details on how to get up and running quickly with your Geo2. This section is essential reading for everyone.

- 13 > INSTALLING A 9V BATTERY
- 14 > SWITCHING ON THE GEO2
  - > SWITCHING OFF THE GEO2
  - > FIRING THE GEO2
  - > THE GEO2 CIRCUIT BOARD
- 15 > USING THE BREAK BEAM SENSOR SYSTEM

## 16 USING YOUR GEO2

More detailed information on how to use and interact with the Geo2 via its user interface.

- 16 > SETTING UP
  - > INSTALLING A PRESET AIR SYSTEM
- 17 > INSTALLING AN ADJUSTABLE AIR SYSTEM
- 18 > T-SLOT MOUNTING SYSTEM
  - > MACROLINE HOSE AND ELBOWS
- 19 > ATTACHING A LOADER
- 20 > SETTING THE TRIGGER
- 22 > ADJUSTING THE VELOCITY
  - > ADJUSTING THE LPR PRESSURE
- 23 > USER INTERFACE
  - > RUN SCREEN LAYOUT
- 24 > THE BBSS INDICATOR
  - > THE AUX OUT INDICATOR
- 25 > THE SOUND INDICATOR
  - > THE TRIGGER DETECTION INDICATOR

- 26 > THE LOCK INDICATOR
  - > THE BATTERY LEVEL INDICATOR
  - > THE GAME TIMER
  - > THE SHOT COUNTER
- 27 > THE ACTUAL RATE OF FIRE
  - > THE PEAK RATE OF FIRE
  - > THE MENU SYSTEM

## 28 MENU TREE

A quick reference guide to the user interface.

## 32 ADVANCED SET-UP

In depth information on setting up the Geo2.

- 32 > ACCESSING THE MENU SYSTEM
  - > MOVING AROUND THE MENUS
  - > ALTERING PARAMETERS
- 33 > THE MAIN MENU
- 34 > PRESET -The Preset Menu
  - > LOAD -The Load Preset Parameter
  - > SAVE -The Save Preset Parameter
- 35 > FIRE MODE -The Fire Mode Parameter
  - > ROF CAP -The Rate of Fire Cap Parameter
  - > BS ON ROF -The Maximum Rate of Fire Parameter
  - > BS OFF ROF -Rate of Fire With BBSS Off Parameter
- 36 > RAMP SETUP -The Ramp Set-up Menu
  - > TYPE -The Ramp Type Parameter
  - > RATE -The Linear Ramp Rate Parameter
- 37 > SEMI SHOTS -The Ramp Start Parameter
  - > KICK IN -The Ramp Kick-In Parameter
  - > SUSTAIN -The Sustain Rate Parameter
  - > RESTART -The Ramp Restart Parameter
  - > TIMING -The Timing Menu
- 38 > DWELL -The Dwell parameter
  - > FSD COMP -The First Shot Drop-off Compensation Parameter
  - > FSD DLY -The First Shot Drop-off Delay Parameter
  - > FILTER -The Filter Menu
- 39 > DEBOUNCE -The Debounce Parameter
  - > EMPTY -The Breech Empty Time Parameter
  - > FULL -The Breech Full Time Parameter

- > **PULL TM** -The Trigger Pull Time Parameter
- > **RELEASE TM** -The Trigger Release Time Parameter
- > **PULL PT** -The Trigger Pull Point Parameter
- > **RELEASE PT** -The Trigger Release Point Parameter
- 40 > BASIC TRIGGER FILTER SET-UP**
  - > **ADVANCED TRIGGER FILTER SET-UP**
  - > **HARDWARE** -The Hardware Menu
- 41 > TRIGGER** -The Trigger Parameter
  - > **SOUND** -The Sound Parameter
  - > **TONES** -The Tones Parameter
  - > **BACKLIGHT** -The Backlight Parameter
  - > **RED LEVEL** -The Backlight Red Level Parameter
- 42 > GRN LEVEL** -The Backlight Green Level Parameter
  - > **BLU LEVEL** -The Backlight Blue Level Parameter
  - > **AUX OUT** -The AUX Out Parameter
  - > **DBL-CLICK** -The Double Clicking Parameter
  - > **AUTO OFF** -The Auto Off Parameter
- 43 > TRAINING** -The Training Parameter
- 44 > SHOT COUNT** -The Shot Count Menu
  - > **GAUGE** -The Gauge Parameter
  - > **GAUGE MAX** -The Gauge Max Parameter
- 45 > TIMER** -The Game Timer Menu
  - > **GAME** -The Game Timer Parameter
  - > **ALARM** -The Alarm Parameter
  - > **START** -The Start Parameter

## 46 MAINTENANCE

A guide to performing routine maintenance.

- 46 > CLEANING THE BREAK BEAM SENSOR SYSTEM**
- 48 > CLEANING THE INLINE REGULATOR**
- 50 > ADVANCED INLINE REGULATOR MAINTENANCE**
- 51 > MAINTAINING THE BOLT SYSTEM**
- 54 > ADVANCED BOLT SYSTEM MAINTENANCE**
- 55 > REMOVING THE FRAME**
- 56 > ATTACHING THE FRAME**
- 58 > THE GEO2 SOLENOID ASSEMBLY**
- 61 > THE GEO2 TRIGGER ASSEMBLY**
- 63 > THE GEO2 ON/OFF PURGE SYSTEM**

## 65 THE ECLIPSE E-PORTAL

Information on the Eclipse E-Portal upgrade for Geo2.

## 66 FAULT FINDING

Information on how to resolve any problems that might arise with your Geo2.

## 69 SERVICE CENTRES

Information on the location of your nearest Geo2 Service Centre.

## 72 PARTS LIST

A table of components that make up the Geo2.

## WARRANTY CARD

Tear-out product registration card to be completed and returned. Alternatively register online at [www.planeteclipse.com](http://www.planeteclipse.com)

## 77 SPARES

Available upgrade / repair kits for your Geo2.

## 78 INDEX

Geo2 Manual Index

## QUICK GUIDE

<b>CONTENTS</b>
ORIENTATION
QUICK SET-UP
USING YOUR GEO2
MENU TREE
ADVANCED SET-UP
MAINTENANCE
E-PORTAL
FAULT FINDING
SERVICE CENTRES
PARTS LIST
SPARES & ACCESSORIES
INDEX



# ECLIPSE SHAFT4 BARREL

The Eclipse Geo2 comes as standard with an Eclipse Shaft 4 barrel.<sup>1</sup>

The barrel screws into the body of the Geo2 using a right hand thread meaning that if you hold the Geo2 pointing away from you the barrel screws into the body in a counter-clockwise direction.<sup>2</sup>

The barrel comprises of two parts, a barrel back **A** and a barrel front **B**. The two parts are joined together with a left hand thread meaning that if you hold the barrel, with the back nearest you, the front unscrews in a counter-clockwise direction. The bore size of the barrel back is engraved at the end of the barrel back **C**.<sup>3</sup>

On the barrel back there is a 016 NBR 70 o-ring **D** which prevents the barrel from vibrating loose from the Geo2 body when the marker is fired. There is also a 015 NBR 70 o-ring on the tip of the barrel back **E** helps with alignment when the two sections are screwed together.

Replace and lubricate these o-rings with Eclipse Grease as necessary.

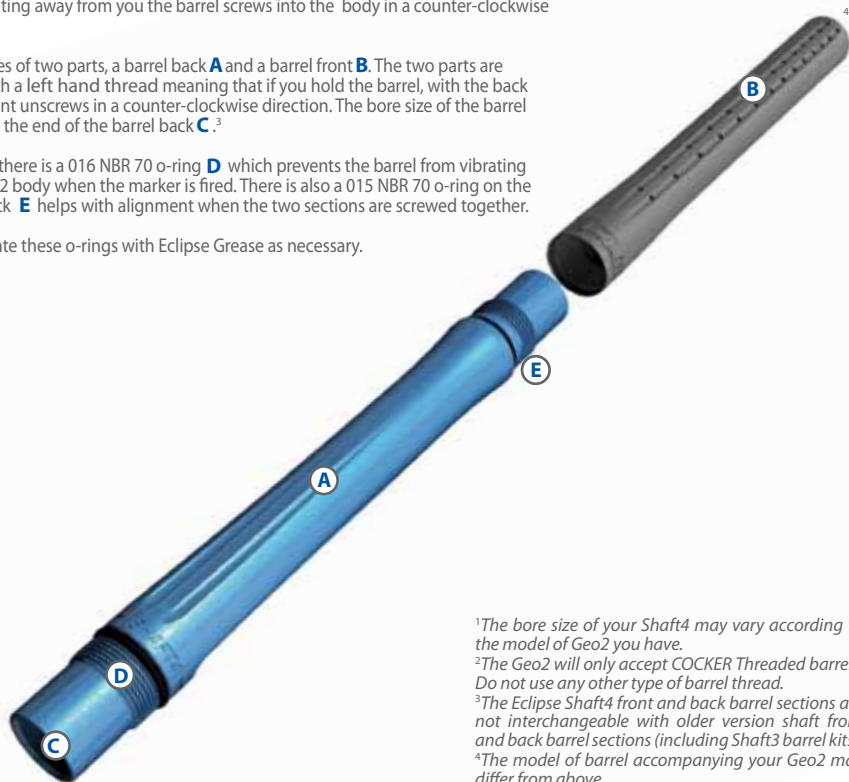

<sup>1</sup>The bore size of your Shaft4 may vary according to the model of Geo2 you have.

<sup>2</sup>The Geo2 will only accept COCKER Threaded barrels. Do not use any other type of barrel thread.

<sup>3</sup>The Eclipse Shaft4 front and back barrel sections are not interchangeable with older version shaft front and back barrel sections (including Shaft3 barrel kits).

<sup>4</sup>The model of barrel accompanying your Geo2 may differ from above.

## QUICK GUIDE

### CONTENTS

#### ORIENTATION

#### QUICK SET-UP

#### USING YOUR GEO2

#### MENU TREE

#### ADVANCED SET-UP

#### MAINTENANCE

#### E-PORTAL

#### FAULT FINDING

#### SERVICE CENTRES

#### PARTS LIST

#### SPARES & ACCESSORIES

#### INDEX

# ORIENTATION

## 7.



# SL3 INLINE REGULATOR

**⚠ WARNING** //

**WARNING: DO NOT REMOVE THE INLINE PURGE CONTROL VALVE.**  
THE PURGE CONTROL VALVE DOES NOT NEED TO BE REMOVED DURING REGULAR MAINTENANCE.  
FAILURE TO COMPLY WITH THIS WARNING MAY CAUSE THE MARKER TO FIRE A SHOT THAT COULD RESULT IN SERIOUS INJURY OR DEATH.

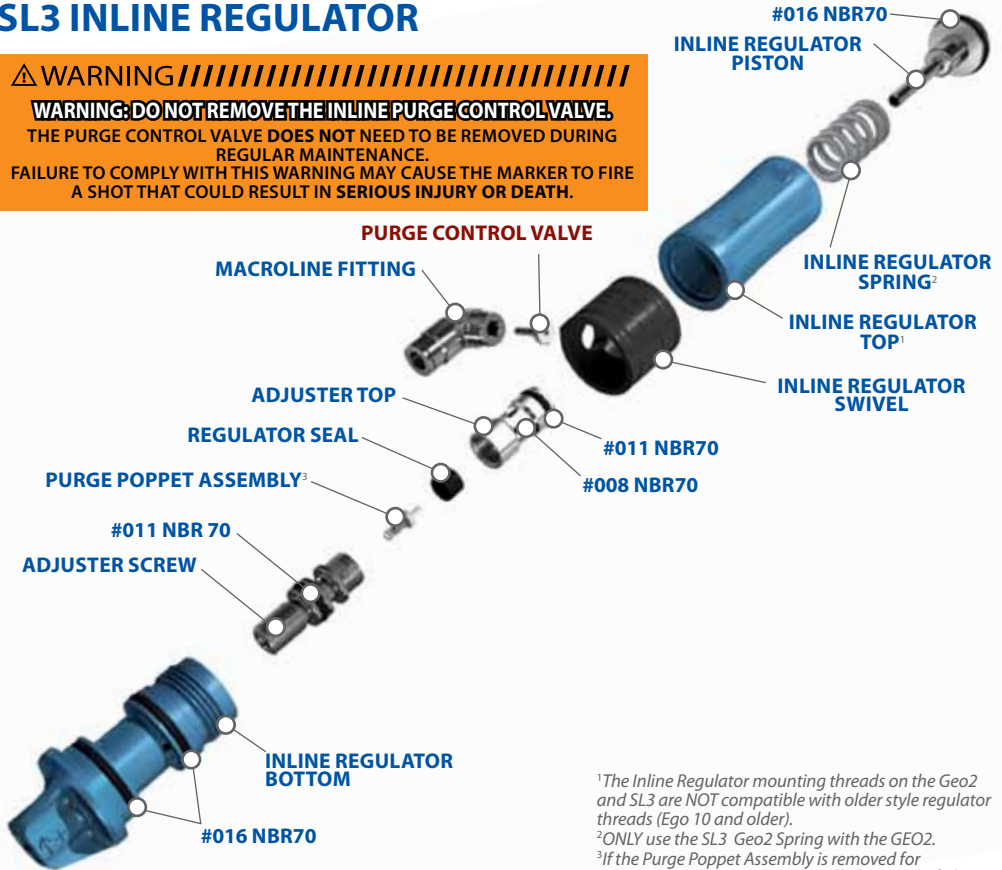

<sup>1</sup>The Inline Regulator mounting threads on the Geo2 and SL3 are NOT compatible with older style regulator threads (Ego 10 and older).  
<sup>2</sup>ONLY use the SL3 Geo2 Spring with the GEO2.  
<sup>3</sup>If the Purge Poppet Assembly is removed for maintenance ensure it is re-installed correctly, failure to do so may seriously damage the Geo2 solenoid.

ORIENTATION



# GEO2 BOLT SYSTEM<sup>1</sup>

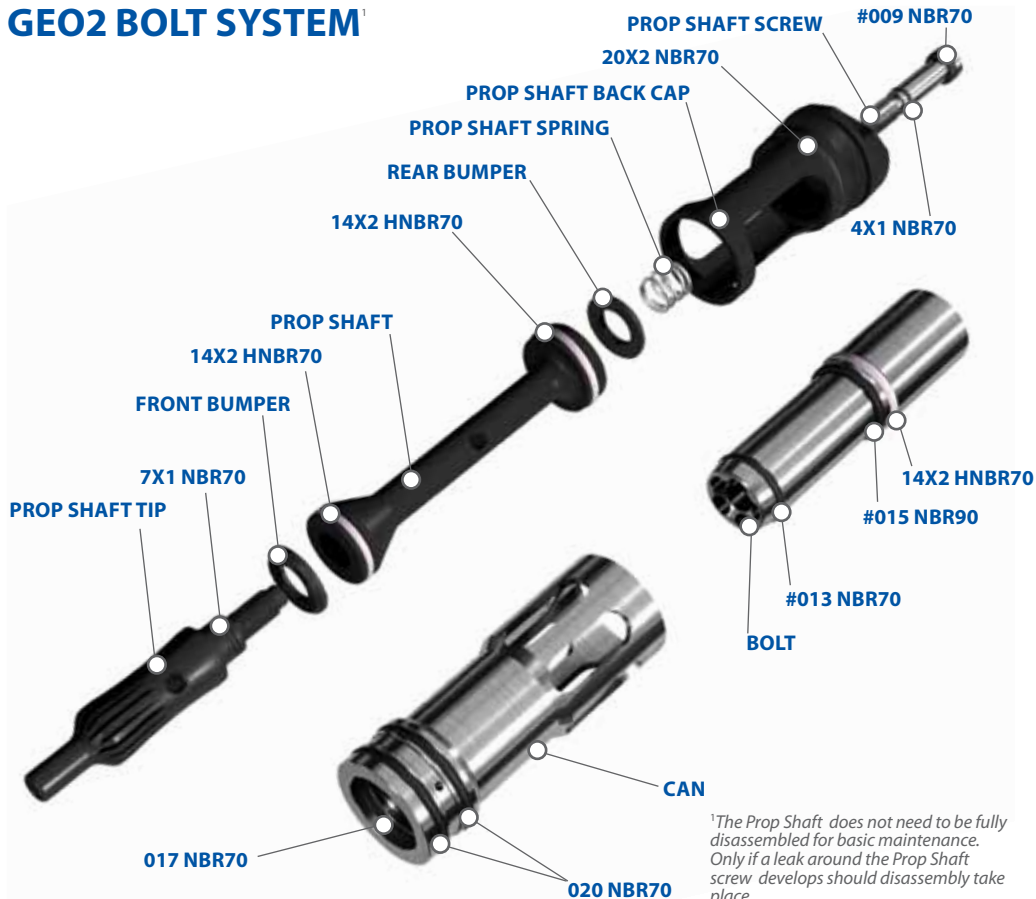

<sup>1</sup>The Prop Shaft does not need to be fully disassembled for basic maintenance. Only if a leak around the Prop Shaft screw develops should disassembly take place.

## QUICK GUIDE

CONTENTS

[ORIENTATION](#)

[QUICK SET-UP](#)

[USING YOUR GEO2](#)

[MENU TREE](#)

[ADVANCED SET-UP](#)

[MAINTENANCE](#)

[E-PORTAL](#)

[FAULT FINDING](#)

[SERVICE CENTRES](#)

[PARTS LIST](#)

[SPARES & ACCESSORIES](#)

[INDEX](#)

# ORIENTATION



## GEO2 SOLENOID ASSEMBLY

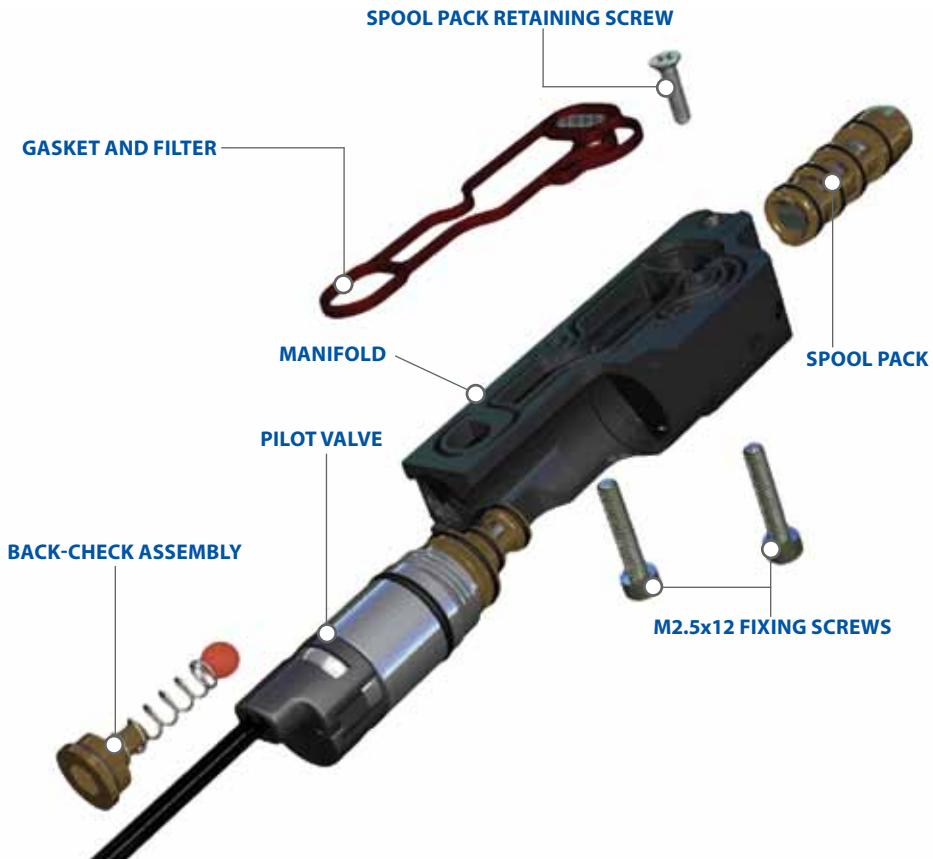

**ORIENTATION**

**10.**

# THE GEO2 NAVIGATION CONSOLE

At the rear of the Geo2 grip frame you will find the navigation console (FIGURE 0.1) which is used for:

- > **TURNING THE GEO2 ON AND OFF USING THE BUTTON** ⌂
- > **SCROLLING THROUGH MENUS WITH THE ▲ AND ▼ BUTTONS**
- > **SELECTING PARAMETERS TO EDIT USING THE ⌂ BUTTON**
- > **EDITING PARAMETERS USING THE ▲ AND ▼ BUTTONS**
- > **TURNING THE GEO2 BREAK BEAM SENSOR SYSTEM ON AND OFF USING THE ▲ BUTTON (PUSH AND HOLD)**
- > **RESETTING RECORDED VALUES USING THE ▼ BUTTON (PUSH AND HOLD)**
- > **CONTROLLING THE GAME TIMER WITH THE ▼ BUTTON (QUICK PUSH AND RELEASE)**
- > **SCROLLING THROUGH THE VARIOUS RUN SCREENS USING THE ▲ BUTTON (QUICK PUSH AND RELEASE)**



FIG 0.1

⚠ WARNING: //

**WARNING: THE BACKLIGHT ON THE LCD DISPLAY TURNS OFF AFTER A PERIOD OF TIME. WHEN THIS HAPPENS THE MARKER IS STILL ON AND ABLE TO FIRE. TO ADJUST THE LCD BACKLIGHT SEE PAGE 41-42**

## QUICK GUIDE

### CONTENTS

ORIENTATION
QUICK SET-UP
USING YOUR GEO2
MENU TREE
ADVANCED SET-UP
MAINTENANCE
E-PORTAL
FAULT FINDING
SERVICE CENTRES
PARTS LIST
SPARES & ACCESSORIES
INDEX



## OPERATIONAL OVERVIEW

Below is a brief overview of what happens when you fire your Geo2. The location of parts discussed in the text below can be found on page 72-73.

Assuming the Geo2 is gassed up and turned on **FIGURE 1.1** shows the marker in its idle position. The Firing Chamber is full of compressed air, the Prop Shaft is pushed back into the Back Cap by this compressed air. The Bolt is held back by the air in the Can. Both the Firing Chamber and the Can are supplied with air via the Solenoid Valve.

Providing a ball is in the breach and the Trigger is pulled, a signal is sent to the Solenoid which stops the supply of air to the Firing Chamber and allows the air in the Can to be exhausted. This removes the force holding the Bolt in its rear position and the Bolt is propelled forwards (**FIGURE 1.2**).

As the Bolt passes the Front Prop Shaft o-ring the Firing Chamber seal is broken and the air in the Firing Chamber vents down the Bolt, in turn propelling a ball (**FIGURE 1.3**).

As air is vented from the Firing Chamber the force pushing the Prop Shaft back is overcome by the Spring tension in the Back Cap. The Spring pushes the Prop Shaft forward. The front 14x2 o-ring on the Prop Shaft enters the bolt and seals off the Firing Chamber (**FIGURE 1.4**).

The length of time the Bolt remains in this forward position is dependant on Dwell. When the Solenoid has completed its Dwell time, air is routed back into the Can and pushes the Bolt back towards its rear position. Simultaneously the Firing Chamber is re-filled through the Solenoid Valve to the operating pressure set by the user via the Inline Regulator, and the Prop Shaft is pushed into its rear position by the air pressure inside the Valve Chamber. (**FIGURE 1.5**).



# INSTALLING A 9V BATTERY

Ensure that the Geo2 is switched off. Lay the marker on a flat surface in front of you with the feed tube furthest away and with the barrel pointing to the right.

Use a 5/64" (2mm) hex wrench to remove the three countersunk screws that hold the rubber grip onto the frame. Peel the grip to the right to expose the circuit board within the frame.

Remove the fitted battery by sliding your thumb or finger into the recess below the battery and levering the battery out of the frame (**SEE FIGURE 2.1**).

DO NOT pull on the top of the battery to remove it as this can cause the battery terminals to bend and will result in a poor electrical connection.

Fit a 9-volt alkaline battery (type PP3, 6LR61 or MN1604) into the recess with the battery terminals away from you. The positive terminal should be on the right hand side, nearest to the front side of the frame (**SEE FIGURE 2.2**).<sup>1</sup>

Ensure that all of the wires are within the recess of the frame and away from the trigger micro-switch and Opto sensors so as not to interfere with their operation and replace the rubber grip and replace the three countersunk screws.

**DO NOT OVER-TIGHTEN THE SCREWS.**

<sup>1</sup>Do not use rechargeable batteries or low quality batteries.



FIG 2.1



FIG 2.2

## QUICK GUIDE

CONTENTS

ORIENTATION

QUICK SET-UP

USING YOUR GEO2

MENU TREE

ADVANCED SET-UP

MAINTENANCE

E-PORTAL

FAULT FINDING

SERVICE CENTRES

PARTS LIST

SPARES & ACCESSORIES



INDEX

QUICK SET-UP

13.



## SWITCHING ON THE GEO2

To switch on the Geo2 press the  button twice in quick succession, referred to elsewhere in this manual as 'double-clicking'. The Geo2 can also be switched on by pushing and holding the  button (**FIGURE 3.1**).

## SWITCHING OFF THE GEO2

Press and hold the  button until the display shows **TURN OFF**. Release the  button and re-press it to turn off the Geo2. Alternatively double click the  button to enter the menu tree then press  to turn off the Geo2.<sup>1</sup>

## FIRING THE GEO2

Pull the trigger to fire the Geo2. The entire firing sequence is controlled electronically by the Geo2 circuit board, enabling any user to easily achieve high rates of fire.

## THE GEO2 CIRCUIT BOARD

There are four sockets on the Geo2 circuit board; the BBSS connector (**A**), the Geo2 solenoid connector (**B**), the auxiliary socket to which third party products such as loaders and RF transmitters can be connected using the relevant wiring harness (**C**) and the Expansion Board Socket which connects the Eclipse E-Portal USB Daughter Board to the Geo2 (**D**) (**SEE FIGURE 3.2**).<sup>2,3</sup>

<sup>1</sup>The double clicking feature is user selectable, factory default is set to on. It can be turned off using the Double Click parameter in the Hardware Menu (see page 42).

<sup>2</sup>The Auxiliary socket is turned on and off manually via the AUX OUT parameter in the hardware menu on page 42.

<sup>3</sup>Eclipse E-Portal sold separately.



**FIG 3.1**

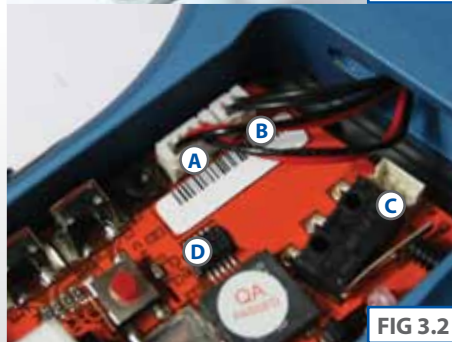

**FIG 3.2**

# USING THE BREAK BEAM SENSOR SYSTEM

The break beam sensor system, referred to elsewhere in this manual as 'BBSS' is used to detect when a paintball is ready to fire from the Geo2. If no paintball is ready then the BBSS will inhibit the Geo2 from firing. This prevents the Geo2 from 'chopping' paintballs that are not fully loaded into the marker.

To switch off the BBSS, press and hold the ▲ button for 0.5 seconds (SEE FIGURE 3.3).

The BBSS indicator on the top right of the LCD will change from ☉ (enabled) to ☾ (disabled).

To switch the BBSS back on, press and hold the ▲ button for 0.5 second. The indicator will change back to ☉.

When the BBSS is enabled, the indicator will change depending upon whether the system has detected a ball or not. When no ball has been detected the indicator looks like this ☉ when a ball has been detected the icon changes to look like this ☉.

Additional features of the Geo2's Break Beam Sensor System are covered in full on page 24 of this user manual.

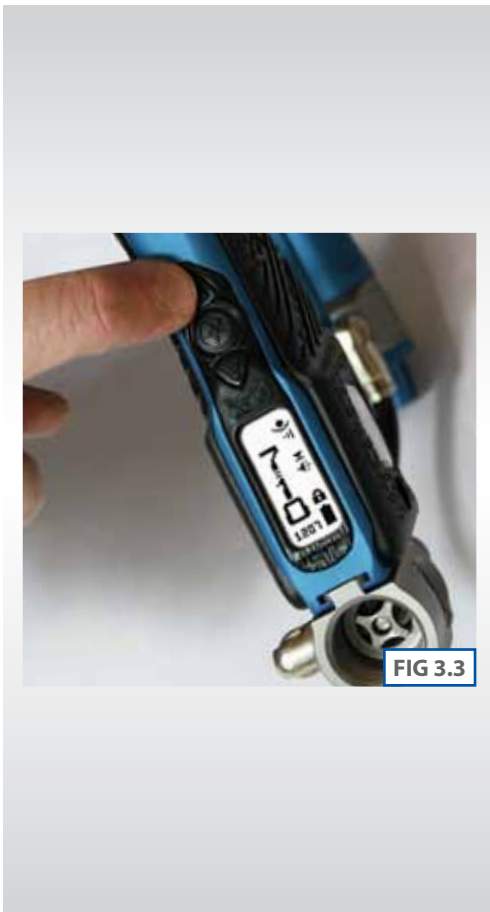

FIG 3.3

<sup>1</sup>When the Geo2 is turned on, the Break Beam Sensor System is automatically enabled.

## QUICK GUIDE

CONTENTS

ORIENTATION

QUICK SET-UP

USING YOUR GEO2

MENU TREE

ADVANCED SET-UP

MAINTENANCE

E-PORTAL

FAULT FINDING

SERVICE CENTRES

PARTS LIST

SPARES & ACCESSORIES

INDEX

# QUICK SET-UP



## SETTING UP YOUR GEO2

Before you can begin to use your Geo2, you will need to attach an air system and a paintball loader.

### INSTALLING A PRESET AIR SYSTEM

**⚠ WARNING** //

**WARNING: THE GEO2 CANNOT BE USED WITH CO<sub>2</sub>, IT CAN ONLY BE POWERED BY COMPRESSED AIR OR NITROGEN.**

**⚠ WARNING** //

**WARNING: ALWAYS RELIEVE ALL RESIDUAL GAS PRESSURE FROM THE GEO2 BEFORE UNSCREWING THE PRESET AIR SYSTEM.**

**⚠ WARNING** //

**WARNING: MAKE SURE THE MARKER IS TURNED OFF AND THAT NO PAINTBALLS ARE IN THE MARKER OR LOADER BEFORE INSTALLING AN AIR SYSTEM.**

Every Geo2 comes complete with an Eclipse On/Off Purge System (OOPS) which provides a direct connection for a preset air system. Before screwing the air system into the OOPS ensure that the On/Off knob is wound out approximately half way (**SEE FIGURE 4.1**). Be careful not to unscrew the On/Off knob too far as it will come completely off the OOPS. If this happens, replace the On/Off knob by screwing it back onto the OOPS body in a clockwise direction.<sup>1</sup>

Screw the preset air system into the OOPS (**SEE FIGURE 4.2**) so that the bottle screws in all the way and is tight. Slowly turn the On/Off knob in a clockwise direction allowing the OOPS to depress the pin of the preset air system causing the Geo2 to become pressurised, providing that there is sufficient air in your tank (**SEE FIGURE 4.3**).

You have now installed a preset air system onto your Geo2.

<sup>1</sup>High, mid and low pressure output preset air systems can be used with the Geo2.



FIG 4.1



FIG 4.2



FIG 4.3



# INSTALLING AN ADJUSTABLE AIR SYSTEM

## ⚠ WARNING //

**WARNING: MAKE SURE THE MARKER IS TURNED OFF AND THAT NO PAINTBALLS ARE IN THE MARKER OR LOADER BEFORE INSTALLING AN AIR SYSTEM.**

## ⚠ WARNING //

**BEFORE ATTACHING ANY FIXED AIR SYSTEM, PLACE ATTACHING SCREW IN THE AIR SYSTEMS DESIGNATED SLIDE RAIL AND MEASURE PROTRUDING SCREW LENGTH. SCREW LENGTH MUST NOT PROTRUDE MORE THAN 10MM/0.40" OTHERWISE THE GEO2 CIRCUIT BOARD MAY BE DAMAGED**

Firstly disconnect the macroline hosing from the elbow attached to the OOPS at the base of the grip frame (SEE FIGURE 4.4).

Using a 3/32" hex key turn the two screws on the bottom of the OOPS in a counter clockwise direction so that the OOPS can be removed from the rail by sliding it backwards (SEE FIGURE 4.5).

As well as the integrated slide rail at the base of the Geo2's grip frame, there are also two 10-32 UNF threaded screw holes which will accept all standard bottom line screws (SEE FIGURE 4.6).

Attach the air system of your choice, taking care to ensure that you use the correct length and size of hosing to accommodate your requirements.



FIG 4.4



FIG 4.5



FIG 4.6

## QUICK GUIDE

CONTENTS

ORIENTATION

QUICK SET-UP

USING YOUR GEO2

MENU TREE

ADVANCED SET-UP

MAINTENANCE

E-PORTAL

FAULT FINDING

SERVICE CENTRES

PARTS LIST

SPARES & ACCESSORIES

INDEX

# USING YOUR GEO2



## T-SLOT MOUNTING SYSTEM

The Geo2 utilises a T-slot arrangement to mount the OOPS to the bottom of the frame. The T-slot is an improvement over the dovetail mounting system found on most paintball markers, and is much more able to withstand the rigours of modern tournament paintball.

For backwards compatibility there are industry standard mounting holes in the base of the frame for mounting third party air source adaptors (ASAs).



## MACROLINE HOISING AND ELBOWS

To aid the longevity of your macroline hosing, it is very important to remove it from (and install it back into) the fittings in the correct manner:

Pull back the collet section of the macroline fitting and keep the collet depressed.

Pull the macroline hose out of the macroline fitting and release the collet.

Before installing the macroline hose into the macroline fitting ensure that the end has been trimmed correctly to ensure a tight fit in the fitting.



**⚠ WARNING** //

**IF YOU EVER REMOVE THE MACROLINE HOSE FROM THE FITTING, ALWAYS CHECK THE CONDITION OF YOUR MACROLINE HOISING AND IF IT IS WORN OR THE WRONG LENGTH REPLACE IT IMMEDIATELY.**

# ATTACHING A LOADER

**⚠ WARNING**////////////////////

**WARNING: DO NOT OVER TIGHTEN THE CLAMPING FEED NECK AS THIS MAY DAMAGE THE LOADER OR FEED NECK ITSELF.**

Using a 5/32" hex key or your fingers, turn the sprocket screw of the clamping feed neck counter clockwise (SEE FIGURE 5.1).

Release the clamping lever on the feed neck (SEE FIGURE 5.2) and test to see if your loader can easily be pushed into the top of the feed neck. If the loader cannot easily be pushed into the feed neck, loosen the sprocket screw of the clamping feed neck a little more by turning it counter clockwise using a 5/32" hex key or your fingers (SEE FIGURE 5.1).

When you have managed to push your loader into the clamping feed neck, close the clamp to secure it firmly in place (SEE FIGURE 5.3). If the loader is loose then you will need to release the clamp, tighten the sprocket screw slightly by turning it clockwise with a 5/32" hex key or your fingers and close the clamp. Repeat this process as necessary to secure your loader in place.

You have now attached a loader to your Geo2. Once you have filled your loader and air tank you will then be ready to begin using your Geo2.



FIG 5.1



FIG 5.2



FIG 5.3

## QUICK GUIDE

CONTENTS

ORIENTATION

QUICK SET-UP

USING YOUR GEO2

MENU TREE

ADVANCED SET-UP

MAINTENANCE

E-PORTAL

FAULT FINDING

SERVICE CENTRES

PARTS LIST

SPARES & ACCESSORIES

INDEX

# USING YOUR GEO2



## SETTING THE TRIGGER

The Geo2 provides the user with the option to use either a micro-switch or an Opto sensor as the means for detecting trigger pulls. Before you begin to adjust and set your trigger, you must first select the method of trigger detection that you wish to use by entering the Main menu and making your selection from the *HARDWARE* menu (see page 40).

There are five adjustment points on the trigger – the **front stop trigger screw**, the **rear stop trigger screw**, the **magnet return strength screw**, the **micro switch activation screw** and the **spring return strength screw**.

As standard each Geo2 comes with a factory set trigger travel of approximately 2mm in total length; one millimeter of travel before the firing point and one millimeter of travel after the firing point, and the trigger detection method set to Opto.

The **front stop trigger screw** is used to set the amount of trigger travel prior to the marker firing. Turn this screw clockwise to reduce the amount of travel. Do not turn the screw too far or the trigger will be pushed past the firing point and the marker will not work. Turn this screw counter clockwise to increase the amount of trigger travel (SEE FIGURE 6.1).

The **rear stop trigger screw** is used to set the amount of travel after the marker has fired. Turn this screw clockwise to reduce the amount of travel. Do not turn the screw too far or the trigger will be prevented from reaching its firing point and the marker will not work. Turn this screw counter clockwise to increase the amount of travel (SEE FIGURE 6.2).



The **magnet return strength screw** is used to adjust the amount of force with which the trigger is returned to its rest position by the magnet. Turn the screw clockwise to increase the amount of force. Do not turn the screw too far or it will negate the position of the front stop trigger screw. Turn the screw counter clockwise to reduce the amount of force. Do not turn the screw too far or there will not be enough force to return the trigger (SEE FIGURE 6.3).



## (CONTINUED)

The **micro switch activation screw** is used to adjust the point in the trigger pull at which the micro-switch is activated. Turn the screw clockwise to decrease the amount of trigger travel to the activation point. Turn the screw counter clockwise to increase the amount of trigger travel to the activation point (SEE FIGURE 6.4).

The **spring return strength screw** can only be adjusted by first removing the frame from the marker body, as per the instructions in the Maintenance section on page 55. The spring return strength screw is used to adjust the spring strength that returns the trigger to its resting position. Turn the screw clockwise to increase the amount of spring return strength in the trigger pull. Turn this screw counter clockwise to reduce the amount of spring return strength in the trigger pull. Do not turn the screw too far counter clockwise or there will not be enough force to return the trigger consistently (SEE FIGURE 6.5).

When setting the trigger it is important to ensure that the electronic trigger detection is working correctly. When the trigger is fully depressed the trigger detection indicator (TDI) should point upwards    .

When the trigger is fully released the TDI should point downwards    .

For more information, see understanding the trigger detection indicator (TDI) on page 25 and The *FILTER* menu on page 38.

### FIGURE 6.6 KEY

- A** Spring
- B** Spring Return Strength Screw
- C** Trigger Pin Retaining Screw
- D** Front Stop Trigger Screw
- E** Magnet Return Strength Screw
- F** Micro Switch Activation Screw
- G** Rear Stop Trigger Screw

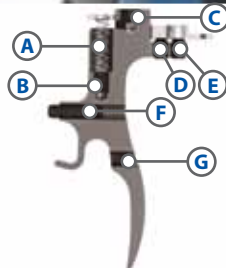

## QUICK GUIDE

CONTENTS

ORIENTATION

QUICK SET-UP

USING YOUR GEO2

MENU TREE

ADVANCED SET-UP

MAINTENANCE

E-PORTAL

FAULT FINDING

SERVICE CENTRES

PARTS LIST

SPARES & ACCESSORIES

INDEX

# USING YOUR GEO2

21.



## USING YOUR GEO2

22.

### ADJUSTING THE VELOCITY

When using your Geo2, you may wish to change the velocity at which your Geo2 is firing. This is done by inserting a 1/8" hex key into the adjuster screw at the bottom of your Geo2 Inline Regulator and adjusting it accordingly (**SEE FIGURE 7.1**). By turning this adjuster screw clockwise you decrease the output pressure of the Inline Regulator and consequently the velocity, by turning the adjuster screw counter clockwise you increase the output pressure of the Inline Regulator and consequently the velocity. On the bottom of the Inline Regulator there are engraved arrows to illustrate which direction to turn the hex key to make the relevant adjustment.<sup>1</sup>

<sup>1</sup>After each adjustment fire two clearing shots to gain an accurate velocity reading. Never exceed 300fps.



FIG 7.1

# USER INTERFACE

The Geo2 has a simple user interface through which all aspects of its electronic control system can be monitored and adjusted by means of the three pushbuttons and graphical LCD which comprise the navigation console.

## RUN SCREEN LAYOUT

The root of the user interface is the run screen. This screen is the one most often displayed and provides the user with essential feedback on the state of the Geo2. A typical run screen is shown on the right.<sup>1</sup>

On the left of the screen is a display option that is user selectable from by briefly pressing the  button on the navigation console.

- > A GAME TIMER
- > A SHOT COUNTER
- > AN ACTUAL RATE OF FIRE INDICATOR
- > A PEAK RATE OF FIRE INDICATOR

On the right of the screen are a number of icons, each of which provides graphical indication on different parts of the Geo2 control electronics:

**BREAK BEAM SENSOR SYSTEM INDICATOR**

**AUX OUT INDICATOR**

**TRIGGER DETECTION INDICATOR**

**SOUND INDICATOR**

**USER SELECTABLE DISPLAY OPTION**

**LOCK INDICATOR**

**BATTERY LEVEL INDICATOR**

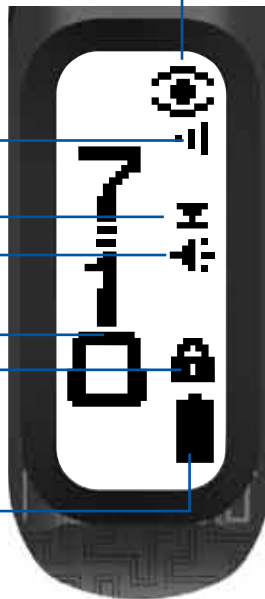

<sup>1</sup>The layout of the run screen is correct at time of printing. However newer versions of the Geo2 software may have a different layout of the run screen from what is printed in this manual. You may find some icons have been added or removed entirely. If you are unsure about any icons which do not feature in the manual contact your local dealer/service centre or Planet Eclipse directly.

## QUICK GUIDE

CONTENTS

ORIENTATION

QUICK SET-UP

USING YOUR GEO2

MENU TREE

ADVANCED SET-UP

MAINTENANCE

E-PORTAL

FAULT FINDING

SERVICE CENTRES

PARTS LIST

SPARES & ACCESSORIES

INDEX



## THE BREAK BEAM SENSOR SYSTEM INDICATOR (BBSS)

The BBSS is able to switch itself off in the event of a blockage or contamination preventing it from functioning correctly. In this instance, the BBSS will switch itself back on once the blockage is cleared and the correct operation can be resumed.

The BBSS indicator on the main screen is used to indicate the eight possible states of the BBSS as follows:



### BBSS ENABLED AND BALL DETECTED

The Geo2 can be fired at the maximum rate of fire determined by the chosen firing mode.



### BBSS ENABLED NO BALL DETECTED

The Geo2 cannot be fired.



### BBSS DISABLED

The Geo2 can be fired at a maximum rate of fire as set by the *BS OFF ROF* parameter (see page 35).



### BBSS FAULT DETECTED

The system is disabled. The Geo2 can only be fired at a maximum rate of 2bps less than the maximum rate of fire, up to a maximum of 10 bps.



### BBSS FAULT HAS BEEN CLEARED AND BALL DETECTED

The sensor has been re-enabled. A ball is detected and the Geo2 can be fired at the maximum rate of fire determined by the chosen firing mode.



### BBSS FAULT HAS BEEN CLEARED AND NO BALL DETECTED

The sensor is enabled. No ball is detected so the Geo2 cannot be fired. To reset the BBSS icon, use the  button to switch off the BBSS and then back on again.



### BBSS ENABLED IN TRAINING MODE

The BBSS has been over-ridden as the user has selected training mode. As the user has chosen to leave the BBSS on, the achievable rate of fire is limited by the firing mode.



### BBSS DISABLED IN TRAINING MODE

The BBSS has been over-ridden as the user has selected training mode. As the user has chosen to turn the BBSS off, the achievable rate of fire is limited by the *BS OFF ROF* parameter (see page 35).

## THE AUX OUT INDICATOR

The auxiliary socket on the Geo2 circuit board allows third party products such as loaders or RF transmitters to be interfaced to the Geo2.

The AUX out indicator is turned on and off via the *AUX OUT* parameter (see page 42).

There are two possible conditions that can be indicated:



### AUX OUT ENABLED

The AUX OUT is enabled. Each time the circuit board detects a valid trigger pull a signal will be sent to the AUX connector on the circuit board.



### AUX OUT DISABLED

The AUX OUT is disabled. No signal will be sent to the AUX connector on the circuit board.



# THE SOUND INDICATOR

The sound indicator on the run screen is used to convey if the *SOUND* parameter in the *HARDWARE* menu (page 41) is switched on or off.

There are two possible conditions that can be indicated:



## SOUND ENABLED

The *SOUND* parameter is enabled. The Geo2 will make sounds when switched on and off and when the game timer alarms or times out.



## SOUND DISABLED

The *SOUND* parameter is disabled. The Geo2 will not make any sounds.

# THE TRIGGER DETECTION INDICATOR (TDI)

In order for the trigger to be successfully operated it must first be released and then pulled. The trigger detection indicator (TDI) is used to indicate each of the possible trigger states.



## OPTO SENSOR SELECTED, READING 0%

The Geo2 is configured to use the Opto sensor to detect trigger pulls. The Opto sensor is currently reading 0%, i.e. the trigger is fully released.



## OPTO SENSOR SELECTED, READING BELOW RELEASE POINT

The Geo2 is configured to use the Opto sensor to detect trigger pulls. The Opto sensor is currently reading below the Opto release point, i.e. the trigger is considered 'released'.



## OPTO SENSOR SELECTED, READING MID-RANGE

The Geo2 is configured to use the Opto sensor to detect trigger pulls. The Opto sensor is currently reading somewhere between the Opto release point and the Opto pull point, i.e. the trigger is half depressed.



## OPTO SENSOR SELECTED, READING ABOVE PULL POINT

The Geo2 is configured to use the Opto sensor to detect trigger pulls. The Opto sensor is currently reading above the Opto pull point, i.e. the trigger is considered 'pulled'.



## OPTO SENSOR SELECTED, READING 100%

The Geo2 is configured to use the Opto sensor to detect trigger pulls. The Opto sensor is currently reading 100%, i.e. the trigger is fully depressed.



## MICRO-SWITCH SELECTED, NOT ACTUATED

The Geo2 is configured to use the micro-switch to detect trigger pulls. The micro-switch is not currently actuated, i.e. the trigger is released.



## MICRO-SWITCH SELECTED, ACTUATED

The Geo2 is configured to use the micro-switch to detect trigger pulls. The micro-switch is currently actuated, i.e. the trigger is pulled.

From the factory the Geo2 will have the Opto sensor enabled. The micro-switch option can be selected by referring to the *HARDWARE* menu (see page 41).

## QUICK GUIDE

CONTENTS

ORIENTATION

QUICK SET-UP

USING YOUR GEO2

MENU TREE

ADVANCED SET-UP

MAINTENANCE

E-PORTAL

FAULT FINDING

SERVICE CENTRES

PARTS LIST

SPARES & ACCESSORIES

INDEX



## THE LOCK INDICATOR

The Geo2 has a tournament lock which prevents the user from making changes to any parameter that affects the way in which the Geo2 shoots, without the need for tools. This feature is necessary in order to make the Geo2 legal for tournament play.

When the lock is enabled the lock indicator will show a closed padlock .

When the lock is disabled the lock indicator will show an open padlock .

To enable or disable the tournament lock see *Accessing the Menu System* on page 32.

## THE BATTERY LEVEL INDICATOR

The battery level indicator is used to show the state of the battery within the Geo2. When the battery is fresh the indicator will show a 'full' battery  and as the battery is drained, so the indicator will show the battery emptying. When the battery reaches a point at which the Geo2 will no longer function reliably, the indicator will start to flash. At this point the battery must be changed immediately.

As well as displaying the voltage level of the battery, the indicator also warns if the battery being used has an incorrect voltage to operate the electronics reliably. The icon for a battery with an incorrect voltage output is . If this icon is shown the battery must be replaced immediately.

## THE GAME TIMER

When the game timer is shown on the run screen then it can be started by pressing the  button and the timer will start to count down. The game timer can also be configured to start on a trigger press with the *START* parameter (see page 45).

When the game timer reaches the *ALARM TIME* the game timer will start to flash and the audible alarm will sound every second, provided that the *SOUND* parameter is on.

When the game timer reaches 00:00, *GAME OVER* will be displayed and the audible alarm will sound continually, provided that the *SOUND* parameter is set to 'ON'.

To stop the game timer at any time press and hold the  button for 0.5 seconds.

To reset the game timer to its preset start time, push and hold the  button for 1 second. The game timer will also be reset whenever the Geo2 is switched off.

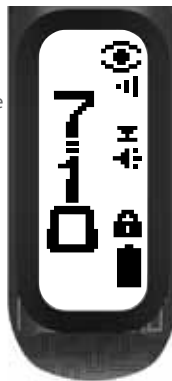

## THE SHOT COUNTER

The shot counter will increment every time that the Geo2 solenoid is activated, regardless of whether the shot counter is displayed or not. When the shot counter is displayed on the run screen it can be reset to 0 by pressing and holding the  button for 0.5 seconds.

There is also an optional shot gauge that can be displayed on this run screen. The gauge counts down from a user adjustable number. To alter the gauge settings see pages 44.

The gauge is reset whenever the Geo2 is switched off or the  button is pressed.



## THE ACTUAL RATE OF FIRE

When the actual ROF is selected for display the run screen will look something like the screen to the right. The value displayed in the top left of the screen represents the number of full cycles completed in a second - the actual rate of fire over that second. The value below it is the maximum actual rate of fire that has been achieved. The graph below this number shows the actual rates of fire achieved over time where each bar represents the amount of pulls in that second. To reset the maximum, press and hold the  button for 1 second.



## THE PEAK RATE OF FIRE

When the peak ROF is selected for display the run screen will look something like the screen to the right, which differs from the display of the actual ROF by the inclusion of the indicator 'PK'. The value displayed in the top left of the screen represents the maximum rate of fire that has been recorded over the last second. The value below it is the maximum peak rate of fire that has been achieved. The graph below this number shows the peak rates of fire achieved over time. To reset this maximum, press and hold the  button for 0.5 seconds.



The peak ROF is typically higher than the actual ROF as it is much easier to fire two shots in quick succession than it is to maintain a string over a longer period of time.

## THE MENU SYSTEM

Behind the run screen is a structured menu system comprised of two layers of menus. Each menu contains a number of menu items and each menu item can either be a parameter or a branch to another menu. Branches have an animated graphic on the right of the display, whereas parameters have their current value.

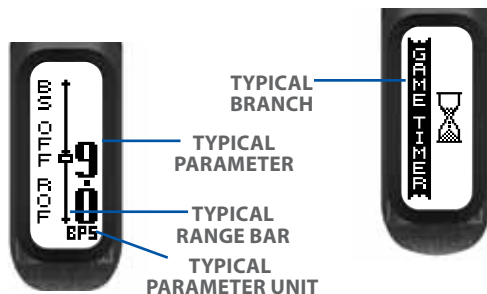

On parameter screens a range bar will be displayed where there is a large scale of adjustability in that parameter. The current parameter value is displayed as a box on the range bar which is used to indicate the range of adjustability in the parameter value.

At the bottom of the parameter screen the unit for that parameter will be displayed. Some parameters will not have units, such as on or off parameters. For a detailed list of which parameters have units, and what they stand for, please see the Menu Tree on pages 28-31.

## QUICK GUIDE

CONTENTS

ORIENTATION

QUICK SET-UP

USING YOUR GEO2

MENU TREE

ADVANCED SET-UP

MAINTENANCE

E-PORTAL

FAULT FINDING

SERVICE CENTRES

PARTS LIST

SPARES & ACCESSORIES

INDEX

# MAIN MENU

## MAIN MENU

— TURN OFF		Turn off the Geo2
— PRESET		
—  LOAD	USER 1 USER 2 FACTORY NPPL PSP 10 PSP 12 MS 10 CANCEL	Load the USER1 settings Load the USER 2 settings Load the default factory settings (semi-automatic) Load NPPL 2008 compliant settings Load the PSP 10 balls per second (BPS) compliant settings Load the PSP 12 balls per second (BPS) compliant settings Load Millennium Series 2010 compliant settings Cancel the load operation
—  SAVE	USER 1 USER 2 CANCEL	Save the current settings as the USER 1 settings Save the current settings as the USER 2 settings Cancel the save operation
— BACK		Return to Main menu
—  FIRE MODE	SEMI RAMP CANCEL	Select semi-automatic mode of fire Select ramping mode of fire Cancel the mode selection
—  ROF CAP	ON OFF CANCEL	Rate of fire cap on Rate of fire cap off Cancel selection
—  BS ON ROF*	4.0 - 30.0 BPS	Maximum with breech sensor on (ROF CAP dependant)
—  BS OFF ROF	4.0 - 15.0 BPS	Maximum rate of fire with breech sensor off

The symbol indicates parameters that are locked when the tournament lock is on. See *Accessing the Menu System* on page 32 for instruction on releasing the tournament lock.

Parameters followed by a \* are part of the smart menu system and will only be displayed depending on your chosen settings. (E.g. The BS ON ROF parameter will only become available if the ROF CAP parameter is set to on).

# MAIN MENU

## RAMP SETUP\* (FIRE MODE DEPENDANT)

<b>TYPE</b>	STEP LINEAR CANCEL	Step ramping Linear ramping Cancel selection
<b>RATE*</b>	0 - 100%	Percentage linear ramp rate (TYPE dependant)
<b>SEMI SHOTS</b>	3 - 9	Number of shots before ramping can start
<b>KICK IN</b>	3.3 - 10.0 PPS	Rate at which trigger has to be pulled in pulls per second (PPS) before ramping can start
<b>SUSTAIN</b>	3.3 - 10.0 PPS	Rate at which trigger has to be pulled in pulls per second (PPS) in order to maintain ramping
<b>RESTART</b>	0.0 - 1.0 S	Time in seconds after last trigger pull during which ramp can be restarted
<b>BACK</b>		Return to Main menu

## TIMING

<b>DWELL</b>	0.0 - 25.0 ms	Solenoid energise time in milliseconds (ms) for each shot
<b>FSD COMP</b>	0.0 - 5.0 ms	First shot drop-off compensation time in milliseconds (ms)
<b>FSD DELAY</b>	00:00 - 04:00	First shot drop-off delay
<b>BACK</b>		Return to Main menu

## FILTER

<b>DEBOUNCE</b>	Level 9 Level x Level 1 Cancel	Use trigger debounce level 9 (less bounce) Use trigger debounce level 8 - 2 Use trigger debounce level 1 (more bounce) Cancel debounce selection
<b>EMPTY</b>	1.0 - 20.0 ms	Time in milliseconds (ms) that the breach must remain empty before the BBSS can look for a paintball

## QUICK GUIDE

CONTENTS

ORIENTATION

QUICK SET-UP

USING YOUR GEO2

MENU TREE

ADVANCED SET-UP

MAINTENANCE

E-PORTAL

FAULT FINDING

SERVICE CENTRES

PARTS LIST

SPARES & ACCESSORIES

INDEX

# MENU TREE

29.



## MAIN MENU

<b>🔒 FULL</b>	1.0 - 20.0 ms	Time in milliseconds (ms) that a paintball must be in the breech for the Geo2 to be ready to fire
<b>🔒 PULL TM</b>	3.0 - 25.0 ms	Time in milliseconds (ms) that the trigger must be pulled for a shot to be fired
<b>🔒 RELEASE TM</b>	3.0 - 25.0 ms	Time in milliseconds (ms) that the trigger must be released before a pull can be recorded
<b>🔒 PULL PT*</b>	51 - 99%	Percentage at which the trigger Opto sensor pull point is set (TRIGGER dependant)
<b>🔒 RELEASE PT*</b>	1 - 49%	Percentage at which the trigger Opto sensor release point is set (TRIGGER dependant)
<b>BACK</b>		Return to Main menu

### HARDWARE

<b>🔒 TRIGGER</b>	Opto Switch Cancel	Use Opto sensor to detect trigger operation Use micro-switch to detect trigger operation Cancel trigger detection method selection
<b>SOUND</b>	Off On Cancel	Turn off audible indicator Turn on audible indicator Cancel audible indicator selection
<b>TONES*</b>	Off On Cancel	Turn off audible tone when any button is pressed (SOUND dependant) Turn on audible tone when any button is pressed (SOUND dependant) Cancel audible tone selection
<b>BACKLIGHT</b>	00:00 - 00:20	Time in seconds that the backlight comes on for (00:00 = no backlight)
<b>RED LEVEL*</b>	0 - 100%	Percentage of red light in backlight (BACKLIGHT dependant)
<b>GRN LEVEL*</b>	0 - 100%	Percentage of green light in backlight (BACKLIGHT dependant)
<b>BLU LEVEL*</b>	0 - 100%	Percentage of blue light in backlight (BACKLIGHT dependant)
<b>AUX OUT</b>	Off On Cancel	AUX socket output off AUX socket output on Cancel AUX socket selection
<b>AUTO OFF</b>	05:00 - 60:00	Time in hours and minutes after which the Geo2 automatically powers off

# MAIN MENU

DBL CLICK	NONE	Double click is disabled entirely
	POWER UP	Double click for power up only
BACK	ALL	Double click is fully enabled
	CANCEL	Cancel the DBL click selection
TRAINING	Off	Training mode disabled
	On	Training mode enabled
	Cancel	Cancel training mode selection
SHOT COUNT		
GAUGE	OFF	Shot gauge off
	ON	Shot gauge on
	CANCEL	Cancel selection
GAUGE MAX*	100-2000 SHOTS	Shot gauge maximum (reset value) (GAUGE dependant)
BACK		Return to Main menu
GAME TIMER		
GAME	00:00 - 60:00	Countdown game timer start time in minutes
ALARM	00:00 - 60:00	Alarm activation time in minutes
START	Button	▼ Button starts the game timer
	Trigger	Trigger pull starts the game timer
	Cancel	Cancel game timer start selection
BACK		Return to Main menu
EXIT		

The arrangement of menus and sub menus displayed in the above menu tree may not be replicated in your marker due to any software updates that may have taken place since printing.

## QUICK GUIDE

CONTENTS

ORIENTATION

QUICK SET-UP

USING YOUR GEO2

**MENU TREE**

ADVANCED SET-UP

MAINTENANCE

E-PORTAL

FAULT FINDING

SERVICE CENTRES

PARTS LIST

SPARES & ACCESSORIES

INDEX

# MENU TREE



## ACCESSING THE MENU SYSTEM

To access the Main menu from the run screen double-click the **⊕** button and the first item on the Main menu will be displayed. Alternatively, push and hold the **⊕** button for 2 seconds.

Some of the parameters in the menu system can have a tournament lock applied to them. This lock can be toggled on and off by pressing to tournament lock button on the circuit board ( see A in fig 8.1).

If you try to select a parameter that is locked, the locked display will show on the screen.



## MOVING AROUND THE MENUS

Press and release the **▼** button to display the next item on the menu. When the last menu item is displayed, pressing the **▼** button will display the first item. Press and release the **▲** button to display the previous item on the menu. When the first menu item is displayed, pressing the **▲** button will display the last item. When the displayed item is a branch, as indicated by an animation on the right of the screen, press the **⊕** button to move to another menu.

## ALTERING PARAMETERS

**⚠ WARNING** //

**WARNING: THE MARKER CAN BE FIRED WHILE NAVIGATING ALL MENUS AND PARAMETERS.**

When the displayed item is a parameter, as indicated by a parameter value on the right of the screen, pressing the **⊕** button will activate the *EDIT* mode which allows the parameter value to be altered. When *EDIT* mode is active, the black box surrounding the text disappears. There are two types of parameter, numeric parameters and choice parameters.



A numeric parameter has a numeric value whereas a choice parameter is one that has a small number of distinct choices. Altering parameter values is essentially the same for both types of parameter.

To alter a numeric parameter, first activate the *EDIT* mode. Press the **▲** button to increase the parameter value one step at a time. Press and hold the **▲** button to increase the parameter value rapidly. When the value reaches it's maximum it will revert to it's minimum value. Press the **▼** button to decrease the parameter value one step at a time. Press and hold the **▼** button to decrease the parameter value rapidly. When the value reaches it's minimum it will revert to it's maximum value. When the required parameter value is displayed press the **⊕** button to accept the value and end the *EDIT* mode.

To alter a choice parameter, first activate the *EDIT* mode. Press the **▼** button to display the next choice in the list. When the last choice is displayed, pressing **▼** will display the first choice in the list. Press the **▲** button to display the previous choice in the list. When the first choice is displayed, pressing the **▲** button will display the last choice in the list. When the required choice is displayed press the **⊕** button to accept the choice and end the *EDIT* mode. If the displayed choice is cancel then pressing the **⊕** button will end the *EDIT* mode and restore the parameter to the value that is was prior to editing.



# THE MAIN MENU

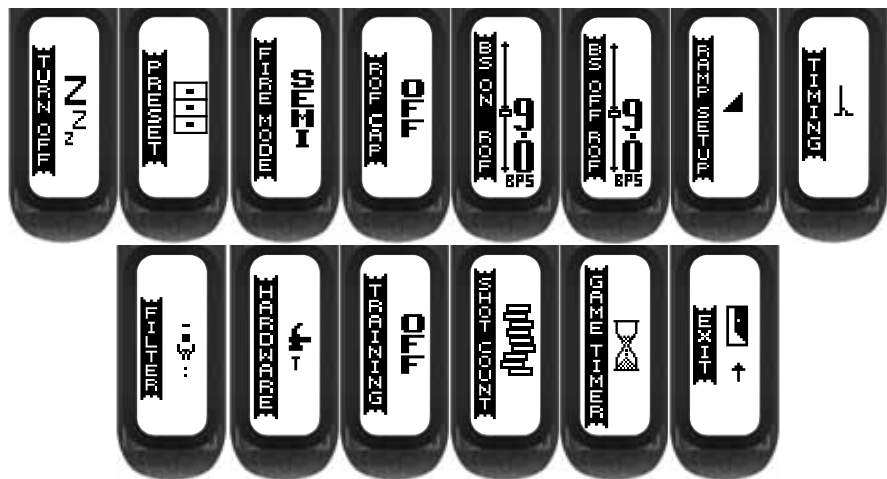

The Main menu contains both individual editable parameters and sub-menus which contain editable parameters. Some of these parameters affect the way the Geo2 shoots and are tournament locked as standard from the factory.<sup>1</sup>

<sup>1</sup>The layout of the Main menu is correct at time of printing. However Newer versions of the Geo2 software may have a different layout of the Main menu, sub-menus and parameters from what is printed in this manual. You may find some parameters have been added or removed entirely. If you are unsure about any parameters which do not feature in the manual contact your local dealer/service centre or Planet Eclipse directly.

## QUICK GUIDE

CONTENTS

ORIENTATION

QUICK SET-UP

USING YOUR GEO2

MENU TREE

ADVANCED SET-UP

MAINTENANCE

E-PORTAL

FAULT FINDING

SERVICE CENTRES

PARTS LIST

SPARES & ACCESSORIES

INDEX

# ADVANCED SET-UP



## PRESET THE PRESET MENU

In order to simplify the set up of the Geo2 a number of preset configurations are available for selection. Choosing one of these presets will cause all of the necessary parameters to be set in such a way as to make the Geo2 comply with the rules governing a particular paintball league<sup>1</sup>. It is also possible for the user to save up to two preset configurations of their own.

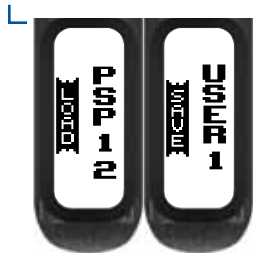

## LOAD THE LOAD PRESET PARAMETER

This parameter is used to load the required preset configuration and has the following choices:

- > **USER 1:** Load a set of custom firing mode parameters that have been previously saved by the user.
- > **USER 2:** Load a set of custom firing mode parameters that have been previously saved by the user.
- > **FACTORY:** Reset every parameter to the factory set default. The Geo2 leaves the factory set in this way.



> **NPPL:** Load a set of parameters that configures the Geo2 to comply with the 2008 NPPL rules governing firing modes.<sup>1,2</sup>

> **PSP 10:** Load a set of parameters that configures the Geo2 to comply with the PSP rules governing firing modes in lower divisions (10bps).<sup>1,2</sup>

> **PSP 12:** Load a set of parameters that configures the Geo2 to comply with the PSP rules governing firing modes in higher divisions (12bps).<sup>1,2</sup>

> **MS10:** Load a set of parameters that configures the Geo2 to comply with the 2010 Millennium Series rules governing firing modes.<sup>1,2</sup>

> **CANCEL:** Editing is cancelled and the parameter remains unchanged.

## SAVE THE SAVE PRESET PARAMETER

This parameter is used to save the current set of parameters as a user defined custom preset configuration.

This parameter has the following choices:

- > **USER 1:** Save the current parameters as the preset 'USER 1'.
- > **USER 2:** Save the current parameters as the preset 'USER 2'.
- > **CANCEL:** Editing is cancelled and the parameter remains unchanged.



<sup>1</sup>Some presets and fire modes may only be available in certain countries and on some models of the Geo2.

<sup>2</sup>All presets are correct at time of printing. It is the users responsibility to ensure that the loaded preset complies with the event rules the marker is intended to be used in.

## FIRE MODE

### THE FIRING MODE PARAMETER

This parameter is used to select the firing mode of the Geo2 and has the following choices:

> **SEMI:** This is the default and in this firing mode the Geo2 will fire one shot for every trigger pull.

> **RAMP:** In this firing mode, the rate of fire is increased above the rate at which the trigger is pulled once certain criteria have been met. These criteria are set by the parameters on the *RAMP SETUP* menu.<sup>1</sup>

> **CANCEL:** Editing is cancelled and the parameter is unchanged.

## ROF CAP

### THE RATE OF FIRE CAP PARAMETER

The *ROF CAP* parameter is used to specify whether or not the Geo2 should have a limited, or capped rate of fire. When the *ROF CAP* is enabled, the maximum achievable rate of fire is set by the *BS ON ROF* parameter. Choices for the *ROF CAP* parameter are:

> **OFF:** Rate of fire only limited by the loader.

> **ON:** Rate of fire limited to the *BS ON ROF* parameter value.

> **CANCEL:** Cancel editing and leave the parameter unchanged.



## BS ON ROF

### THE MAXIMUM RATE OF FIRE PARAMETER

The *BS ON ROF* parameter is used to set the maximum achievable rate of fire from the Geo2. The value of this parameter can be adjusted between 4.0 and 30.0 balls per second in 0.1bps increments.

The *BS ON ROF* parameter will only be displayed if you have set the *ROF CAP* parameter to 'ON'.

## BS OFF ROF

### THE RATE OF FIRE WHEN BBSS IS OFF PARAMETER

The *BS OFF ROF* parameter is used to control how fast the Geo2 cycles when the Break Beam Sensor System is disabled. This parameter can be set between 4.0 and 15.0 balls per second and should always be set to the slowest speed of the loading system in use.



## QUICK GUIDE

CONTENTS

ORIENTATION

QUICK SET-UP

USING YOUR GEO2

MENU TREE

ADVANCED SET-UP

MAINTENANCE

E-PORTAL

FAULT FINDING

SERVICE CENTRES

PARTS LIST

SPARES & ACCESSORIES

INDEX

# ADVANCED SET-UP

<sup>1</sup>Some presets and fire modes may only be available in certain countries and on some models of the Geo2.

<sup>2</sup>Always calibrate your Geo2 ROF CAP parameters to the local field BPS meter as readings may vary from meter to meter.



## RAMP SETUP

### THE RAMP SETTINGS MENU

This menu is only available when ramping has been selected with the *FIRE MODE* parameter and comprises a list of parameters that control the way in which the Geo2 ramps, as shown below.

L

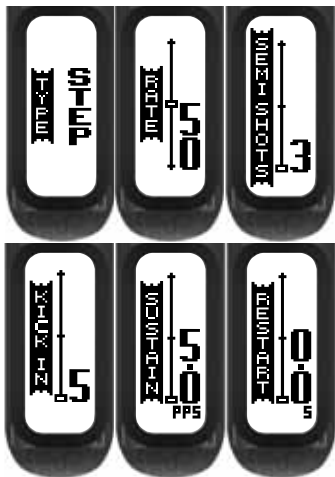

## TYPE

### THE RAMP TYPE PARAMETER

This parameter is used to select the ramping style and has the following choices (see opposite):



> **STEP:** Step ramping will cause the Geo2 to shoot in semi-automatic until a number of trigger pulls, set by *SEMI SHOTS*, have been made at a minimum pull rate, set by *KICK IN*. At this point the rate of fire will step up to the maximum rate of fire as set by *BS ON ROF* (or the maximum loader speed if the *ROF CAP* parameter is set to off). Ramping is maintained as long as the user continues to pull the trigger at a required rate set by *SUSTAIN*.

> **LINEAR:** Linear ramping will cause the Geo2 to shoot in semi-automatic until a number of trigger pulls, set by *SEMI SHOTS*, have been made at a minimum pull rate, set by *KICK IN*. At this point the rate of fire will equal the rate of trigger pulls increased by the percentage specified by *RATE* up to a maximum rate of fire as set by *BS ON ROF*, if the *ROF CAP* is on. Ramping is maintained as long as the user continues to pull the trigger at a required rate set by *SUSTAIN*.

> **CANCEL:** Editing is cancelled and no changes are made to the parameter.

## RATE

### THE LINEAR RAMP RATE PARAMETER

The parameter is only available when *LINEAR* ramping is selected and is used to set the percentage increase in rate of fire over rate of trigger pulls.

For example, if the user is pulling the trigger at a rate of 10 pulls per second and the *RATE* parameter is set to 50% then the rate of fire is 10 plus 50% extra which is 15 balls per second.

This parameter can be set between 0 and 100% in 10% increments.



## SEMI SHOTS

### THE SEMI SHOTS MENU

The parameter sets the number of shots in semi-automatic that are required at the *KICK IN* rate before ramping will start. The parameter can be set between 3 and 9 pulls in 1 pull increments.



## KICK IN

### THE KICK-IN PARAMETER

This parameter sets the minimum rate at which the user has to pull the trigger in order to start ramping. This parameter can be set between 3.3 and 10.0 pulls per second in 0.1 pulls per second increments.



## SUSTAIN

### THE SUSTAIN RATE PARAMETER

Once the Geo2 is ramping the user has to continue to pull the trigger at a minimum rate in order to maintain the ramping. This parameter sets this rate and can be between 3.3 and 10.0 pulls per second in 0.1 pulls per second increments.



## RESTART

### THE RAMP RESTART PARAMETER

The *RESTART* parameter defines the amount of time after the last trigger pull during which the ramp can be restarted with a single trigger pull. If a trigger pull occurs after the *RESTART* time has expired, then the other ramp start conditions have to be met before ramping will restart. This parameter can be set between 0.0 and 1.0 seconds in 0.1 second increments.



## TIMING

### THE TIMING MENU

The parameters on the *TIMING* menu all relate to the control of the solenoid valve (see overleaf).

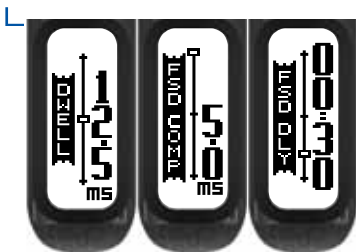

## QUICK GUIDE

CONTENTS

ORIENTATION

QUICK SET-UP

USING YOUR GEO2

MENU TREE

ADVANCED SET-UP

MAINTENANCE

E-PORTAL

FAULT FINDING

SERVICE CENTRES

PARTS LIST

SPARES & ACCESSORIES

INDEX

# ADVANCED SET-UP



## DWELL THE DWELL PARAMETER

The *DWELL* parameter sets the amount of time that the solenoid is energized and therefore the amount of gas that is released with each shot of the Geo2. Setting this parameter too low will result in low velocity shots and/or excessive shot to shot velocity fluctuations. Setting the parameter too high will simply waste gas and make the Geo2 louder. The *DWELL* can be set between 0.0 and 25.0 milliseconds. The factory default setting can normally be reduced after a few thousand shots as the Geo2 'beds-in'.



## FSD COMP THE FIRST SHOT DROP-OFF COMPENSATION PARAMETER

First shot drop off is a reduction in velocity of the first shot fired after an extended period of not firing and is caused by the stiction between dynamic o-rings and the surfaces that they are in contact with. In order to compensate for first shot drop-off this parameter can be set to add extra time to the *DWELL* parameter for the first shot. This parameter can be set between 0.0 and 5.0 milliseconds.



## FSD DLY THE FIRST SHOT DROP-OFF DELAY PARAMETER

The time that has to elapse before the FSD COMP is applied to a shot following a previous shot. This parameter can be set between 00:00 and 04:00 minutes.



## FILTER THE FILTER MENU

The parameters on the *FILTER* menu are all used to tune the Geo2's software filters which prevent the Geo2 from firing unless all of the necessary conditions are met. The factory default settings will be suitable for most set-ups, however certain loader and trigger set-ups may require modification of one or more of these parameters.



## DEBOUNCE

### THE DEBOUNCE PARAMETER

The *DEBOUNCE* parameter is used to combat any trigger bounce that might occur in the Geo2 and can be set between level 1 and level 9 in one level increments.

> **LEVEL 9:** Level 9 providing the most filtering (least 'bouncy').

> **LEVEL 1:** Level 1 providing the least filtering (most 'bouncy').

> **CANCEL:** Cancel editing and leave the parameter unchanged.



## EMPTY

### THE BREECH EMPTY TIME PARAMETER

In order for the BBSS to function correctly it must first detect that the bolt is fully retracted and the breech is empty, and then detect that a paintball is loaded into the breech before the Geo2 is allowed to fire. The parameter can be set between 1.0 and 20.0ms in 0.5ms increments.

## FULL

### THE BREECH FULL TIME PARAMETER

Tumbling paintballs can take time to settle in the breech before they can be successfully fired. This parameter is used to set the amount of time that a paintball has to be in the breech before the Geo2 is allowed to fire. This parameter can be set between 1.0 and 20 milliseconds in 0.5ms increments.



## PULL TM

### THE TRIGGER PULL TIME PARAMETER

The *PULL TM* parameter is used to set the minimum amount of time that the trigger must be pulled before it is recognised as a valid trigger pull. This parameter can be set between 3.0 and 20.0 milliseconds in 0.5 increments.



## RELEASE TM

### THE TRIGGER RELEASE TIME PARAMETER

The *RELEASE TM* parameter is used to set the minimum amount of time that the trigger must be released before it is recognised as a valid trigger release. This parameter can be set between 3.0 and 25.0 milliseconds in 0.1 millisecond increments.

## PULL PT

### THE TRIGGER PULL POINT PARAMETER

The *PULL PT* parameter is only available if OPTO has been selected in the *HARDWARE* menu. *PULL PT* defines the point at which the trigger is considered pulled and is adjustable between 51% and 99% in 1% increments.



## RELEASE PT

### THE TRIGGER RELEASE POINT PARAMETER

The *RELEASE PT* parameter is only available if OPTO has been selected in the *HARDWARE* menu. *RELEASE PT* defines the point at which the trigger is considered released and is adjustable between 1% and 49% in 1% increments.



## QUICK GUIDE

CONTENTS

ORIENTATION

QUICK SET-UP

USING YOUR GEO2

MENU TREE

ADVANCED SET-UP

MAINTENANCE

E-PORTAL

FAULT FINDING

SERVICE CENTRES

PARTS LIST

SPARES & ACCESSORIES

INDEX



## BASIC TRIGGER FILTER SET-UP

95% of trigger bounce problems can be eliminated by utilizing one of the nine fixed *DEBOUNCE* choices (LEVEL 1-9). In attempting to eliminate trigger bounce it is advisable to try the nine fixed *DEBOUNCE* choices before attempting any advanced set up of the trigger filters.

## ADVANCED TRIGGER FILTER SET-UP

In order to optimize the trigger filters it is necessary to have the *PULL PT* parameter set as high as possible and the *RELEASE PT* parameter set as low as possible:

1. Select the *PULL PT* parameter. Observe that the graphical bar rises and falls as the trigger is pulled and released. The actual value of the graphical bar is displayed in the top right of the display.
2. Set the Rear Stop Trigger Screw as required, ensuring that the bar is as close to 100% as possible when the trigger is fully depressed against the set screw. It is advisable to allow for some extra travel in the trigger pull once the bar has reached its maximum value.
3. Adjust the *PULL PT* parameter so that when the trigger is fully depressed the bar settles above the indicator on the left hand side of the screen (see page 39).
4. Select the *RELEASE PT* parameter. Observe that the graphical bar rises and falls as the trigger is pulled and released. The actual value of the graphical bar is displayed in top right of the display.
5. Set the Front Stop Trigger Screw as required, ensuring that the bar is as close to 0% as possible when the trigger is fully released against the set screw. It is advisable to allow for some extra travel in the trigger release once the bar has reached its minimum value.

6. Adjust the *RELEASE PT* parameter so that when the trigger is fully released the bar settles beneath the indicator on the left hand side of the screen (see page 39).

7. Set the Magnet Return Strength Screw and the Spring Return Strength Screw as required, making both the spring tension and the return force as strong as possible without compromising the "feel" of the trigger.

## HARDWARE THE HARDWARE MENU

The *HARDWARE* menu comprises parameters that control low level functionality of the Geo2 electronic hardware.





## TRIGGER

### THE TRIGGER DETECTION PARAMETER

The Geo2 is fitted with a dual trigger pull detection system. A non-contact Opto-electronic trigger sensor arrangement is used to detect trigger movement whilst a micro-switch is used to provide a more traditional tactile feedback for the trigger. The **TRIGGER** parameter is used to select which system is used. The choices available are as follows:

- > **OPTO**: Select the Opto sensor for trigger pull detection.
- > **SWITCH**: Select the micro-switch for trigger pull detection.
- > **CANCEL**: Cancel editing and leave the parameter unchanged.



## SOUND

### THE SOUND PARAMETER

The Geo2 board is capable of emitting a variety of sounds to audibly signal when certain functions have been performed, including, but not limited to, powering up, powering off, changing the BBSS mode and resetting various counters and timers. This parameter determines if this feature is switched on or off, switching it on will cause more drain on the battery. The choices available for this parameter are:

- > **OFF**: Sounds switched off.
- > **ON**: Sounds switched on.
- > **CANCEL**: Cancel editing and leave the parameter unchanged.



## TONES

### THE TONES PARAMETER

This parameter determines if the Geo2 emits a tone each time any of the pushbuttons on the navigation console are activated. As part of the smart menu system the **TONES** parameter will only be shown in the **HARDWARE** menu if the **SOUND** parameter is switched 'ON'. The choices available for this parameter are:

- > **OFF**: Tones switched off.
- > **ON**: Tones switched on.
- > **CANCEL**: Cancel editing and leave the parameter



## BACKLIGHT

### THE LCD BACKLIGHT TIME PARAMETER

The time the LCD backlight remains on after a pushbutton is pushed. The parameter can be set between 0 and 20 seconds.

If the time is set to 00:00 then the light will not be displayed.

## RED LEVEL

### THE LCD BACKLIGHT RED LEVEL PARAMETER

The percentage of red light emitted from the LCD backlight.



## QUICK GUIDE

CONTENTS

ORIENTATION

QUICK SET-UP

USING YOUR GEO2

MENU TREE

ADVANCED SET-UP

MAINTENANCE

E-PORTAL

FAULT FINDING

SERVICE CENTRES

PARTS LIST

SPARES & ACCESSORIES

INDEX

# ADVANCED SET-UP



## GRN LEVEL

### THE LCD BACKLIGHT GREEN LEVEL PARAMETER

The percentage of green light emitted from the LCD backlight.



## BLU LEVEL

### THE LCD BACKLIGHT BLUE LEVEL PARAMETER

The percentage of blue light emitted from the LCD backlight.

## AUX OUT

### THE AUX OUT PARAMETER

This parameter turns on and off the AUX socket on the PCB. The choices available for this parameter are:

>**OFF:** AUX socket switched off.

>**ON:** AUX socket switched on.

>**CANCEL:** Cancel editing and leave the parameter unchanged.



## DBL CLICK

### THE DOUBLE CLICKING PARAMETER

This parameter is used to select where double-clicking the  button can be used. The choices available for this parameter are:

>**NONE:** Double clicking is disabled entirely. To power up the Geo2 and enter the Main menu the user needs to push and hold the  button.

>**POWER UP:** Double clicking only works when powering up the Geo2. To enter the Main menu the user still needs to push and hold the  button.

>**ALL:** Double clicking works when powering up the Geo2 and entering the Main menu. Push and hold still works for these procedures as well.

>**CANCEL:** Cancel editing and leave the parameter unchanged.



## AUTO OFF

### THE AUTO POWER OFF TIME PARAMETER

The time that has to elapse before the Geo2 switches itself off if not used. The parameter can be set between 5 and 20 minutes.



## TRAINING

### THE TRAINING PARAMETER

The *TRAINING* parameter is used to select Training mode. In Training mode the Geo2 will function exactly the same as normal but with two important differences:



1. The solenoid valve is not driven so the bolt does not move and does not release a burst of air. Instead the beeper will sound for each pull of the trigger. This simulates the firing cycle without wasting air and generating lots of noise.
2. The BBSS is overridden so that the Geo2 can cycle without paint. The centre of the BBSS indicator changes to a 'T' to indicate that Training mode is enabled.

The *TRAINING* parameter choices are as follows:

- > **OFF:** Training mode is disabled and the Geo2 functions normally.
- > **ON:** Training mode is enabled.
- > **CANCEL:** Cancel editing and leave the parameter unchanged.

## QUICK GUIDE

CONTENTS

ORIENTATION

QUICK SET-UP

USING YOUR GEO2

MENU TREE

ADVANCED SET-UP

MAINTENANCE

E-PORTAL

FAULT FINDING

SERVICE CENTRES

PARTS LIST

SPARES & ACCESSORIES

INDEX

# ADVANCED SET-UP



## SHOT COUNT THE SHOT COUNT MENU

The *SHOT COUNT* menu allows the user to alter the shot gauge that appears in the shot count run screen.

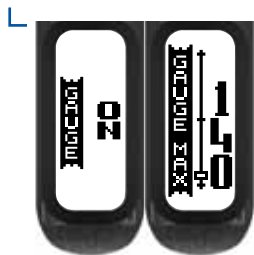

## GAUGE THE GAUGE PARAMETER

The *GAUGE* parameter allows the user to toggle the gauge graphic on and off, in the shot counter run screen.

The choices for the *GAUGE* parameter are:

- > **OFF:** Gauge graphic on the shot count run screen is disabled.
- > **ON:** Gauge graphic on the shot count run screen is enabled.
- > **CANCEL:** Cancel editing and leave the parameter unchanged.



## GAUGE MAX THE GAUGE MAX PARAMETER

The *GAUGE MAX* parameter allows the user to set the number the gauge counts down from every time the Geo2 is fired. The user can set the gauge from 100 to 2000 in increments of 10.



## TIMER

### THE GAME TIMER MENU

This menu is comprised of parameters that control the operation of the Game Timer.

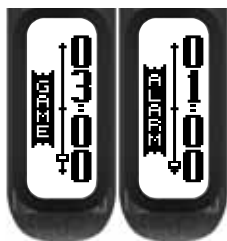

## GAME

### THE GAME TIME PARAMETER

This parameter is used to set the game time; the time from which the game timer counts down to zero. This parameter can be set between 00:00 and 60:00 minutes in 10 second increments and the factory default is 07:10 (7 minutes 10 seconds).

When the game timer reaches 00:00, **GAME OVER** will be displayed and the audible alarm will sound continually, provided that the *SOUND* parameter is set to 'ON'.



## ALARM

### THE ALARM TIME PARAMETER

An alarm condition is generated whenever the game timer counts down to a specific time set by the *ALARM* parameter. This parameter can be set between 00:00 and 10:00 minutes in 10 second increments.

When the alarm condition is generated the game timer will start to flash and the audible alarm will sound every second, provided that the *SOUND* parameter is set to 'ON'.



## START

### THE TIMER START PARAMETER

This parameter is used to select the event which will cause the game timer to begin counting down. This parameter has the following choices:

- > **BUTTON:** Pressing the  button will start the game timer.
- > **TRIGGER:** Pulling the trigger will start the game timer.
- > **CANCEL:** Cancel editing and leave the parameter unchanged.



## QUICK GUIDE

CONTENTS

ORIENTATION

QUICK SET-UP

USING YOUR GEO2

MENU TREE

ADVANCED SET-UP

MAINTENANCE

E-PORTAL

FAULT FINDING

SERVICE CENTRES

PARTS LIST

SPARES & ACCESSORIES

INDEX



## CLEANING THE BREAK BEAM SENSOR SYSTEM

**⚠ WARNING** //

**WARNING: DE-GAS YOUR MARKER, DISCHARGING ANY STORED GAS IN A SAFE DIRECTION, AND REMOVE THE BARREL, LOADER, AIR SYSTEM AND ANY PAINTBALLS TO MAKE THE MARKER EASIER AND SAFER TO WORK ON.**

Undo the retaining screw for the Break Beam Sensor cover on the left hand side of the Geo2 using a 5/64" (2mm) hex key (SEE FIGURE 9.1).

Remove the sensor cover to expose the back of the Break Beam Sensor unit (SEE FIGURE 9.2). Using a dry cotton bud, carefully remove any debris, paint or moisture from the back of the sensor unit and from inside the sensor cover.

Lift the BBSS free from the Geo2 body and using another dry cotton bud, remove any grease or debris build-up from the front of the sensor unit (SEE FIGURE 9.3).



FIG 9.1



FIG 9.2



FIG 9.3

## (CONTINUED)

Remove the rubber Detent and using a dry cotton bud clean the Detent and it's location point in the Geo2 Body.<sup>1</sup> (SEE FIGURE 9.4) Replace the Detent back into the Geo2 body and place the BBSS back into the designated slot in the body (SEE FIGURE 9.5). Ensure that the sensor is face down in the body i.e. looking into the breach.<sup>2</sup>

Replace the sensor cover and using a 5/64" hex key, replace the Bream Beam Sensor cover retaining screw to hold the sensor cover in place (SEE FIGURE 9.6).

Repeat the procedure for the opposite side of the Geo2.

You have now cleaned your Break Beam Sensor System.

<sup>1</sup>When cleaning the Break Beam sensor system inspect the condition of rubber finger detents and replace if necessary.

<sup>2</sup>Ensure that the receiver sensor (indicated by a red mark & red heat shrink) is located on the right-hand side of the marker body.

### ⚠ WARNING //

**WARNING: IF YOU ARE AT ALL UNSURE AT PERFORMING THE MAINTENANCE PROCEDURE PLEASE CONTACT YOUR NEAREST ECLIPSE SERVICE CENTRE. (SEE PAGES 69-71)**



FIG 9.4



FIG 9.5



FIG 9.6

## QUICK GUIDE

CONTENTS

ORIENTATION

QUICK SET-UP

USING YOUR GEO2

MENU TREE

ADVANCED SET-UP

MAINTENANCE

E-PORTAL

FAULT FINDING

SERVICE CENTRES

PARTS LIST

SPARES & ACCESSORIES

INDEX

# MAINTENANCE



## CLEANING THE INLINE REGULATOR

**⚠ WARNING //**

**WARNING: DE-GAS YOUR MARKER, DISCHARGING ANY STORED GAS IN A SAFE DIRECTION, AND REMOVE THE BARREL, LOADER, AIR SYSTEM AND ANY PAINTBALLS TO MAKE THE MARKER EASIER AND SAFER TO WORK ON.**

Disconnect the macroline hosing from your Inline Regulator allowing it to be unscrewed from the Front Regulator Mount (FRM) (SEE FIGURE 10.1). Inspect the o-ring at the top of the threads on the FRM for damage. Replace and re-lubricate as necessary<sup>1</sup>

Turn the Inline Regulator upside down and carefully unscrew the bottom section from the top section (SEE FIGURE 10.2).

Tip both the Piston and Spring out of the top of the Inline Regulator (SEE FIGURE 10.3).

Insert a 1/8" hex key into the Adjuster Screw in the bottom section of the Inline Regulator, turn the Adjuster Screw clockwise through the top of the Inline Regulator Bottom (SEE FIGURE 10.4), and pull out of the Inline Regulator Bottom when it will no longer turn upwards.<sup>2</sup>

Thoroughly clean the 011 NBR70 o-rings that sit on the outside of the Adjuster Assembly, then re-lubricate with Eclipse Grease (SEE OVERLEAF FIGURE 10.5).<sup>1</sup>

<sup>1</sup>If any o-rings are damaged then replace them. Extra o-rings are available in parts kits available at [www.planeteclipse.com](http://www.planeteclipse.com)

<sup>2</sup>The adjuster screw can only be removed by turning it upwards through the bottom section of the Inline Regulator. The regulator will be damaged if the adjuster screw is removed incorrectly.



FIG 10.1



FIG 10.2



FIG 10.3



FIG 10.4







## ADVANCED INLINE REGULATOR MAINTENANCE

**⚠ WARNING** //

**WARNING: DE-GAS YOUR MARKER, DISCHARGING ANY STORED GAS IN A SAFE DIRECTION, AND REMOVE THE BARREL, LOADER, AIR SYSTEM AND ANY PAINTBALLS TO MAKE THE MARKER EASIER AND SAFER TO WORK ON.**

This procedure is only required if you are fixing a supercharging SL3 Inline Regulator (common symptoms of supercharging are a very high velocity first shot and/or large variances in shot to shot consistency.)

Place 3/32" hex key through the Adjuster Top (SEE FIGURE 10.11), then insert a 1/8" hex key into the bottom of the Adjuster Screw and carefully turn it counter-clockwise until the two parts begin to unscrew freely (SEE FIGURE 10.12). With your fingers fully unscrew the two parts taking care not to lose any of the internal components (SEE FIGURE 10.13).

Inside the Adjuster Screw you will find a Regulator Seal, Purge Poppet and Spring (Purge Poppet Assembly) (SEE FIGURE 10.14). Inspect and clean the Regulator Seal, turning it over if one side appears excessively worn or damaged or replace if necessary. Inspect and clean the Purge Poppet or replace if necessary.<sup>1</sup>

Place the Purge Poppet and attached Spring in the central hole in the Regulator Seal, then insert these parts into the Adjuster Screw (SEE FIGURE 10.15).

With the Regulator Seal, Purge Valve and Spring installed back into the Adjuster Screw, replace the Adjuster Top (SEE FIGURE 10.16). Screw the two parts tightly together using 1/8" and 3/32" hex keys (SEE FIGURE 10.12). Refer to the 'CLEANING THE SL3 INLINE REGULATOR' section on page 48 to re-assemble the SL3 Inline Regulator.

<sup>1</sup>If the Purge Poppet Assembly is removed for maintenance ensure it is re-installed correctly, failure to do so may seriously damage the Geo2 solenoid.

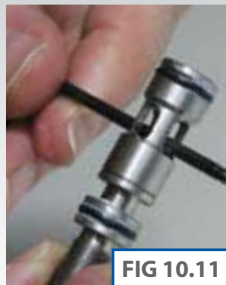

FIG 10.11



FIG 10.12



FIG 10.13



FIG 10.14

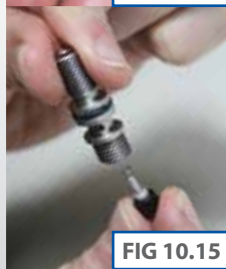

FIG 10.15

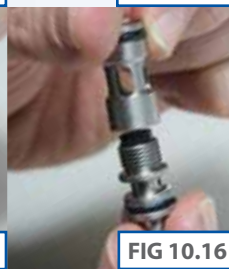

FIG 10.16

# MAINTAINING THE BOLT SYSTEM

## ⚠ WARNING //////////////////////////////////////

**WARNING: DE-GAS YOUR MARKER, DISCHARGING ANY STORED GAS IN A SAFE DIRECTION, AND REMOVE THE BARREL, LOADER, AIR SYSTEM AND ANY PAINTBALLS TO MAKE THE MARKER EASIER AND SAFER TO WORK ON.**

Using a 1/4" hex key or fingers unscrew the Prop Shaft from the marker body (SEE FIGURE 11.1). Once the threaded section is free from the threads in the marker body and turning freely, pull the Prop Shaft from the marker body.

Place a finger down the feed neck and push the Bolt free from the Can inside the body by pushing it backwards (SEE FIGURE 11.2). Once the Bolt is free from the Can, insert a finger into the rear of the marker and remove the bolt completely (SEE FIGURE 11.3).



## QUICK GUIDE

CONTENTS

ORIENTATION

QUICK SET-UP

USING YOUR GEO2

MENU TREE

ADVANCED SET-UP

MAINTENANCE

E-PORTAL

FAULT FINDING

SERVICE CENTRES

PARTS LIST

SPARES & ACCESSORIES

INDEX

# MAINTENANCE



## (CONTINUED)

By inserting a finger or an appropriately sized hex key into the rear of the marker body (SEE PREVIOUS PAGE FIGURE 11.4), hook onto one of the holes in the Can and extract it from the marker body (SEE FIGURE 11.6).

You should now have removed the following parts from the marker body: the Can (A), the Bolt (B) and the Prop Shaft (C) (SEE FIGURE 11.7).

Take the Can and having cleaned off any old grease, paint or debris, apply a small amount of Eclipse Grease to the internal o-ring and the 2 external o-rings (SEE FIGURE 11.8).<sup>1</sup>

Smear a light coat of Eclipse Grease onto the smooth internal bore of the Can from the rear (SEE FIGURE 11.9).



<sup>1</sup>Remove any excess blobs of eclipse grease from the inside and outside of the can.

## (CONTINUED)

Take the Prop Shaft and having cleaned off any old grease, paint or debris, apply Eclipse Grease to the large rear o-ring and the threads (SEE FIGURE 11.10) and also to the 14x2 o-ring near the front of the Prop Shaft (SEE FIGURE 11.11).

Take the Bolt and having cleaned off any old grease, paint or debris, apply a light film of Eclipse Grease to cover the front end of the bolt and also the internal rear bore of the bolt (SEE FIGURE 11.12). Apply a coat of Eclipse Grease to the 2 external Bolt o-rings near the centre of the bolt (SEE FIGURE 11.13).

Remove excess Eclipse Grease by wiping off with finger. Aim to apply only a very thin film of grease to the components maintained, as excess grease can cause poor performance.

Slide the Bolt onto the Prop Shaft (SEE FIGURE 11.14) and slide the Can over the Bolt and push into place until the Can touches the Prop Shaft Back Cap (SEE FIGURE 11.15).

Finally wipe any excess Eclipse Grease off the o-ring on the head of the bolt and insert the complete Bolt Assembly into the marker body (SEE FIGURE 11.16).

Either by hand or using a 1/4" hex key, screw the Bolt Assembly into the marker body (SEE FIGURE 11.17).<sup>1</sup>

If inserted by hand the Prop Shaft and Bolt can be accessed and maintained by hand in future.

<sup>1</sup>DO NOT over tighten the Bolt Assembly.



## QUICK GUIDE

CONTENTS

ORIENTATION

QUICK SET-UP

USING YOUR GEO2

MENU TREE

ADVANCED SET-UP

MAINTENANCE

E-PORTAL

FAULT FINDING

SERVICE CENTRES

PARTS LIST

SPARES & ACCESSORIES

INDEX

# MAINTENANCE

**⚠ WARNING** //

**WARNING: IF YOU ARE AT ALL UNSURE AT PERFORMING THE MAINTENANCE PROCEDURE PLEASE CONTACT YOUR NEAREST ECLIPSE SERVICE CENTRE. (SEE PAGES 69-71)**



## ADVANCED BOLT SYSTEM MAINTENANCE

This procedure is only required if you are replacing the front Prop Shaft bumper, or maintaining the rear Prop Shaft 14x2 o-ring, which if damaged or dirty will cause a leak around the Back Cap of the Geo2.

To replace an excessively worn front bumper, insert an appropriately sized hex key or screw driver shaft into the hole in the middle of the Prop Shaft, then unscrew the Prop Shaft Tip by hand (**SEE FIGURE 11.18**). Remove and replace the worn front bumper ensuring the flat face of the bumper faces the threads of the Prop Shaft Tip (**SEE FIGURE 11.19**). Reattach the Prop Shaft Tip, being carefully not to apply too much force, it only needs to be screwed in **hand tight** (**SEE FIGURE 11.18**).<sup>1</sup>

Keeping the hex key in the Prop Shaft hole, take a 1/8" hex key and remove the Retaining Screw in the back of the Prop Shaft (**SEE FIGURE 11.20**). Remove the Prop Shaft from the Back Cap, taking care not to lose the Prop Shaft Spring. Check the 14x2 o-ring at the back of the Prop Shaft, and clean or replace then re-lubricate with Eclipse Grease as necessary (**SEE FIGURE 11.21**).

Check the rear bumper for signs of wear, replace as necessary then re-install the spring (**SEE FIGURE 11.22**). Replace the Back Cap over the rear of the Prop Shaft, then replace the Retaining Screw using a 1/8" hex key to reassemble to Prop Shaft (**SEE FIGURES 11.20 & 11.23**).<sup>1</sup>

<sup>1</sup>If any o-rings or bumpers are damaged then replace them. Extra o-rings and bumpers are available in parts kits available at [www.planeteclipse.com](http://www.planeteclipse.com).

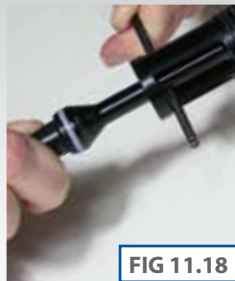

FIG 11.18



FIG 11.19



FIG 11.20



FIG 11.21



FIG 11.22

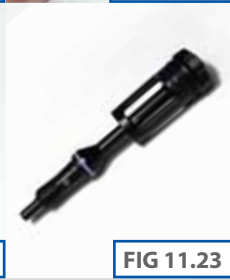

FIG 11.23

# HOW TO REMOVE THE FRAME

## ⚠ WARNING //

**WARNING: DE-GAS YOUR MARKER, DISCHARGING ANY STORED GAS IN A SAFE DIRECTION, AND REMOVE THE BARREL, LOADER AND AIR SYSTEM TO MAKE THE MARKER EASIER TO WORK ON.**

Disconnect any hosing and unscrew the Inline Regulator from the Front Regulator Mount (FRM) as detailed in the 'CLEANING THE INLINE REGULATOR' section of this Maintenance Guide.

Using a 5/64" hex key, remove the six screws that attach the Geo2 Rubber Grips to the Geo2 Grip Frame (SEE FIGURE 12.1).

Unplug the Solenoid and the Break Beam Sensor System wiring harnesses from their respective ports on the Geo2 Circuit Board (SEE FIGURE 12.2).

Using a 1/8" hex key, undo and remove the Front Frame Screw (SEE FIGURE 12.3). Using the short arm of a 1/8" hex key, loosen the Rear Frame Screw a full turn (SEE FIGURE 12.4). Slide the Frame backwards approximately half an inch so that the Rear Frame Screw disengages from the Frame and remove the Frame from the Geo2 Body taking care not to damage any wires (SEE FIGURE 12.5).

You have now removed your Geo2 Grip Frame from the Geo2 Body and have access to the Solenoid Assembly and Break Beam Sensor System wires if maintenance on either is required. Also access to the Trigger Spring Return Strength adjuster screw.

## ⚠ WARNING //

**WARNING: IF YOU ARE AT ALL UNSURE AT PERFORMING THE MAINTENANCE PROCEDURE PLEASE CONTACT YOUR NEAREST ECLIPSE SERVICE CENTRE. (SEE PAGES 69-71)**



FIG 12.1

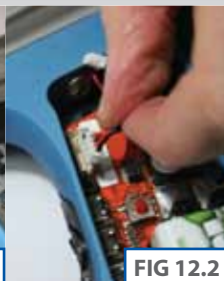

FIG 12.2



FIG 12.3



FIG 12.4



FIG 12.5

## QUICK GUIDE

CONTENTS

ORIENTATION

QUICK SET-UP

USING YOUR GEO2

MENU TREE

ADVANCED SET-UP

MAINTENANCE

E-PORTAL

FAULT FINDING

SERVICE CENTRES

PARTS LIST

SPARES & ACCESSORIES

INDEX

MAINTENANCE



## ATTACHING THE FRAME

**⚠ WARNING //**

**WARNING: DE-GAS YOUR MARKER, DISCHARGING ANY STORED GAS IN A SAFE DIRECTION, AND REMOVE THE BARREL, LOADER AND AIR SYSTEM TO MAKE THE MARKER EASIER TO WORK ON.**

To install the Frame, firstly ensure the solenoid and BBSS wires are sat in the channel on the left of the body (SEE FIGURE 12.6). Carefully thread the Solenoid and the Break Beam Sensor System wiring harnesses through the access hole in the top of the Frame and line the frame up so that the Rear Frame Screw sits in the access hole (SEE FIGURE 12.7).

*BE CAREFUL NOT TO TRAP OR PINCH THE BBSS OR SOLENOID WIRES BEHIND THE REAR FRAME SCREW OR BETWEEN THE BODY AND FRAME, BEING UNABLE TO FREELY PULL THE TRIGGER ALL THE WAY BACK IS A SIGN THE WIRES ARE TRAPPED BETWEEN THE BODY AND FRAME.*

Slide the frame forward so that it sits completely flush with the Geo2 Body and using the short arm of a 1/8" hex key, tighten the Rear Frame Screw into place (SEE FIGURE 12.8).<sup>1</sup>

Insert the Front Frame Screw into its designated position at the front of the Frame and using a 1/8" hex key tighten it into place (SEE FIGURE 12.9).

<sup>1</sup> Check that no wires are trapped before tightening down the two frame screws.



FIG 12.6



FIG 12.7



FIG 12.8



FIG 12.9



## (CONTINUED)

Connect the Solenoid and Break Beam Sensor System wiring harnesses to their respective ports on the Geo2 Circuit Board and (SEE FIGURE 12.10).

Adjust the wires so that they sit neatly in the Grip Frame and ensure that the wires do not obstruct either the Micro-switch or the Opto sensor (SEE FIGURE 12.11).

Attach the Geo2 Rubber Grips to the Frame using a 5/64" hex key to replace the 6 grip screws (SEE FIGURE 12.12).

Screw the Inline Regulator back into the Front Regulator Mount and connect any hosing that was disconnected earlier (SEE FIGURE 12.13).

You have now installed your Geo2 Grip Frame onto the Geo2.



FIG 12.10



FIG 12.11



FIG 12.12



FIG 12.13

⚠ WARNING //////////////////////////////////////

**WARNING: IF YOU ARE AT ALL UNSURE AT PERFORMING THE MAINTENANCE PROCEDURE PLEASE CONTACT YOUR NEAREST ECLIPSE SERVICE CENTRE. (SEE PAGES 69-71)**

## QUICK GUIDE

CONTENTS

ORIENTATION

QUICK SET-UP

USING YOUR GEO2

MENU TREE

ADVANCED SET-UP

MAINTENANCE

E-PORTAL

FAULT FINDING

SERVICE CENTRES

PARTS LIST

SPARES & ACCESSORIES

INDEX

# MAINTENANCE



## THE GEO2 SOLENOID ASSEMBLY

**⚠ WARNING** //

**WARNING: DE-GAS YOUR MARKER, DISCHARGING ANY STORED GAS IN A SAFE DIRECTION, AND REMOVE THE BARREL, LOADER, AIR SYSTEM AND ANY PAINTBALLS TO MAKE THE MARKER EASIER AND SAFER TO WORK ON.**

With the frame separated from the Geo2 body and the Solenoid Assembly and BBSS Assembly unplugged from the Circuit Board (see page 55) use a 5/64" hex key to undo and remove the two screws that hold the Solenoid Assembly onto the Geo2 body (**SEE FIGURE 13.1**).

With the Solenoid Assembly completely removed from the Geo2 body the bottom of the Geo2 body should now resemble **FIGURE 13.2** Ensure that the air transfer holes in the bottom of the body are free from contamination from any dirt, debris, paint or moisture and clear away any excess grease if it appears to be blocking any of the transfer holes.

Check the underside of the Solenoid Assembly to ensure that it is also free from damage or debris (**SEE FIGURE 13.3**) and remove the rubber gasket to clean the filter section as shown in **FIGURE 13.4** Replace the rubber gasket ensuring that it lies flat in its designated groove in the manifold body (**SEE FIGURE 13.5**).

If you are replacing a defective Pilot Assembly, unscrew it from the manifold now and replace it with a new Pilot Assembly unit (**SEE FIGURE 13.6**).



FIG 13.1



FIG 13.2



FIG 13.3



FIG 13.4



FIG 13.5



FIG 13.6

## (CONTINUED)

Using a 5/64" hex key, unscrew and remove the Back-Check Assembly from the manifold (**SEE FIGURE 13.7**). The Back-Check Assembly comprises of three parts; the Back-Check Ball, the Back-Check Spring and the Back-Check Cap (**SEE FIGURE 13.8**). If the Back-Check Ball or Spring is deformed or damaged replace as necessary using authentic Geo2 Spares.

Rebuild the Back-Check Assembly by placing the Back-Check Ball into hole in the manifold and then attach the Back-Check Spring to the end of the Back-Check Cap as shown in **FIGURE 13.9**. Holding the manifold on its end, insert the connected Spring and Cap into their designated hole in the manifold (**SEE FIGURE 13.10**). Using a 5/64 hex key screw the Back-Check Cap back into the manifold to hold the contents of the Back-Check Assembly in place (**SEE FIGURE 13.11**).<sup>1</sup>

Using an appropriately sized Phillips head screwdriver, remove the Spool Pack Retaining screw from the manifold (**SEE FIGURE 13.12**) and using a pair of needle nosed pliers remove the Spool Pack from the manifold (**SEE FIGURE 13.13**).

<sup>1</sup>If any of the components of the Back-Check assembly are damaged or not installed correctly they will prevent the marker from operating correctly.

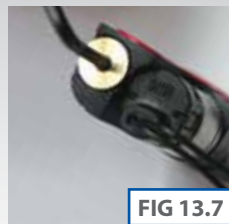

FIG 13.7



FIG 13.8



FIG 13.9

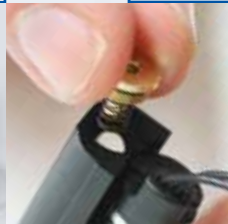

FIG 13.10

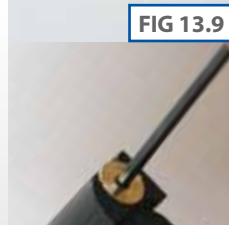

FIG 13.11



FIG 13.12



FIG 13.13

## QUICK GUIDE

### CONTENTS

### ORIENTATION

### QUICK SET-UP

### USING YOUR GEO2

### MENU TREE

### ADVANCED SET-UP

### MAINTENANCE

### E-PORTAL

### FAULT FINDING

### SERVICE CENTRES

### PARTS LIST

### SPARES & ACCESSORIES

### INDEX

# MAINTENANCE



## (CONTINUED)

Clean off any dirt, debris, paint or grease from the Spool Pack and inspect the o-rings for signs of wear or damage (SEE FIGURE 13.14). If any of the o-rings on the Spool Pack are damaged replace the entire spool pack. Using a dry Q-tip clean the inside of the manifold where the Spool Pack resides ensuring that any dirt, debris and old grease is removed (SEE FIGURE 13.15). Lubricate every o-ring on the outside of the Spool Pack thoroughly with Eclipse Grease and insert the Spool Pack into the manifold making sure that the screw hole in the end lines up with the hole in the manifold (SEE FIGURE 13.16).

Using an appropriate sized Phillips head screwdriver, replace and tighten the Spool Pack Retaining screw into the manifold (SEE FIGURE 13.17).

Hold the Solenoid Assembly onto the bottom of the Geo2 body, taking care to line it up correctly with the screw holes in the body and to avoid pinching the BBSS wires underneath it (SEE FIGURE 13.18). Use a 5/64" hex key to tighten the two screws that hold the Solenoid Assembly onto the Geo2 body (SEE FIGURE 13.19).<sup>1</sup>

You have now successfully stripped and cleaned your Geo2 Solenoid Assembly.

<sup>1</sup>DO NOT over tighten screws in the Solenoid Assembly.

**⚠ WARNING** //

**WARNING: IF YOU ARE AT ALL UNSURE AT PERFORMING THE MAINTENANCE PROCEDURE PLEASE CONTACT YOUR NEAREST ECLIPSE SERVICE CENTRE. (SEE PAGES 69-71)**

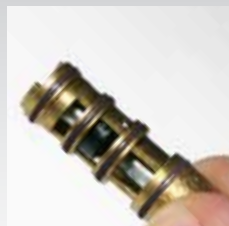

FIG 13.14



FIG 13.15

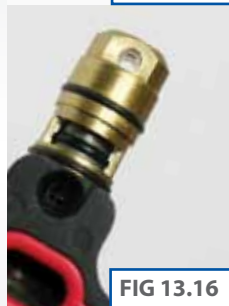

FIG 13.16

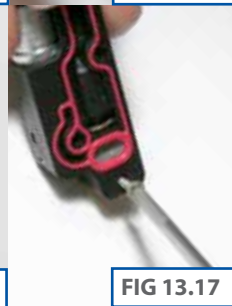

FIG 13.17

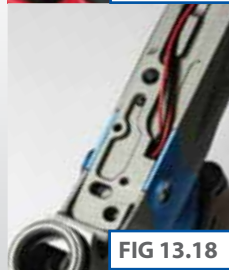

FIG 13.18

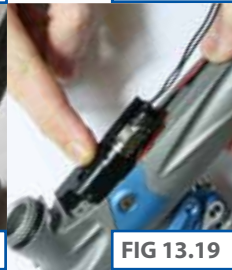

FIG 13.19

# THE GEO2 TRIGGER ASSEMBLY

## ⚠ WARNING //////////////////////////////////////

**WARNING: DE-GAS YOUR MARKER, DISCHARGING ANY STORED GAS IN A SAFE DIRECTION, AND REMOVE THE BARREL, LOADER, AIR SYSTEM AND ANY PAINTBALLS TO MAKE THE MARKER EASIER AND SAFER TO WORK ON.**

Remove the screws from the Geo2 frame that hold the bearing carrier in place in the top of the frame (SEE FIGURE 14.1). Gently lift the bearing carrier and trigger assembly free from the frame taking care not to damage the micro-switch or the Opto sensors (SEE FIGURE 14.2).

Using a 1/16" hex key, loosen the trigger pin retaining set screw from the bottom of the trigger (SEE FIGURE 14.3). Use a small hex key to push the trigger pin out of the bearing carrier from one side (SEE FIGURE 14.4).

Clean the trigger and bearing carrier thoroughly and also clean the space within the frame that the trigger sits into.

Carefully remove the trigger spring from the spring hole in the top of the trigger and clean off any paint debris or moisture from it (SEE FIGURE 14.5).



FIG 14.1



FIG 14.2



FIG 14.3



FIG 14.4



FIG 14.5

## QUICK GUIDE

CONTENTS

ORIENTATION

QUICK SET-UP

USING YOUR GEO2

MENU TREE

ADVANCED SET-UP

MAINTENANCE

E-PORTAL

FAULT FINDING

SERVICE CENTRES

PARTS LIST

SPARES & ACCESSORIES

INDEX

# MAINTENANCE



## (CONTINUED)

Replace the trigger spring into the spring hole in the top of the trigger and position the trigger so that the hole through the trigger lines up with the holes in the bearing carrier, slide the trigger pin in place (SEE FIGURE 14.6).<sup>1</sup>

Gently lower the trigger assembly and bearing carrier into the frame, taking care not to damage the micro-switch or the Opto sensor, and ensuring that the trigger is positioned correctly (SEE FIGURE 14.7). Using a 5/64" hex key tighten the two screws that hold the bearing carrier in place in the top of the Geo2 frame (SEE FIGURE 14.8). Using a 1/16" hex key tighten down the trigger pin retaining set screw (SEE FIGURE 14.9).

You have now stripped and cleaned your Geo2 trigger assembly.



FIG 14.6



FIG 14.7



FIG 14.8



FIG 14.9

<sup>1</sup>DO NOT fully tighten the trigger pin retaining screw until the bearing carrier has been secured in the frame. This is to ensure the trigger pin is correctly lined up against the side wall of the frame.

**⚠ WARNING //**

**WARNING: IF YOU ARE AT ALL UNSURE AT PERFORMING THE MAINTENANCE PROCEDURE PLEASE CONTACT YOUR NEAREST ECLIPSE SERVICE CENTRE. (SEE PAGES 69-71)**

# THE GEO2 ON/OFF PURGE SYSTEM (OOPS)

## ⚠ WARNING //////////////////////////////////////

**WARNING: DE-GAS YOUR MARKER, DISCHARGING ANY STORED GAS IN A SAFE DIRECTION, AND REMOVE THE BARREL, LOADER, AIR SYSTEM AND ANY PAINTBALLS TO MAKE THE MARKER EASIER AND SAFER TO WORK ON.**

Having disconnected the macroline hose from the fitting on the OOPS body, unscrew the OOPS knob from the OOPS body (SEE FIGURE 15.1). Clean off any dirt, debris or moisture from the OOPS pin and the threaded section of the OOPS body.

Use an appropriately sized hex key to push the OOPS pin out of the OOPS body (SEE FIGURE 15.2) and then remove the OOPS insert using a pair of needle nosed pliers (SEE FIGURE 15.3).

Clean and check the condition of the two 008 NBR70 o-rings on the outside of the OOPS insert, replacing as necessary (SEE FIGURE 15.4).



FIG 15.1



FIG 15.2



FIG 15.3

FIG 15.4

## QUICK GUIDE

CONTENTS

ORIENTATION

QUICK SET-UP

USING YOUR GEO2

MENU TREE

ADVANCED SET-UP

MAINTENANCE

E-PORTAL

FAULT FINDING

SERVICE CENTRES

PARTS LIST

SPARES & ACCESSORIES

INDEX

# MAINTENANCE



## (CONTINUED)

Clean and check the condition of the single internal 006 NBR90 o-ring in the front of the OOPS insert, replace if necessary (SEE FIGURE 15.5). Lubricate all three of these o-rings liberally using Eclipse Grease (SEE FIGURE 15.6).

Replace the OOPS insert into the OOPS body ensuring that the o-ring end goes in first, pushing it into place (SEE FIGURE 15.7).

Lubricate the narrow end of the OOPS pin with a smear of Eclipse Grease and push the pin, narrow end first, into the OOPS body so that it sits in the OOPS insert and pokes through the front of the OOPS body (SEE FIGURE 15.8).

Screw the OOPS knob back onto the OOPS body until only a couple of threads are showing (SEE FIGURE 15.9).

Reconnect the macroline hose to the fitting on the OOPS body (SEE FIGURE 15.10).

You have now successfully cleaned and maintained your On/Off purge system.



FIG 15.5



FIG 15.6



FIG 15.7



FIG 15.8



FIG 15.9



FIG 15.10

**⚠ WARNING //**

**WARNING: IF YOU ARE AT ALL UNSURE AT PERFORMING THE MAINTENANCE PROCEDURE PLEASE CONTACT YOUR NEAREST ECLIPSE SERVICE CENTRE. (SEE PAGES 69-71)**



# THE ECLIPSE E-PORTAL

## ⚠ WARNING //////////////////////////////////////

**WARNING: DE-GAS YOUR MARKER, DISCHARGING ANY STORED GAS IN A SAFE DIRECTION, AND REMOVE THE BARREL, LOADER, AIR SYSTEM AND ANY PAINTBALLS TO MAKE THE MARKER EASIER AND SAFER TO WORK ON.**

The Geo2 is compatible with Eclipse E-Portal software. This software is an upgrade to the Geo2 platform. The E-Portal software, USB cable and USB daughter board are sold as a kit, separate from the Geo2.<sup>1</sup>

The Eclipse E-Portal allows you to connect the Eclipse Geo2 to a PC, where a number of operations can be performed:<sup>2</sup>

**UPDATE THE MARKERS FIRMWARE** - from time to time new firmware may be released by Planet Eclipse. You can now download and install the latest firmware using the Eclipse E-Portal.

**ALTER THE ELECTRONIC PARAMETERS** - the Eclipse E-Portal will give you full access to all of the parameters on the Geo2 circuit board.

**CUSTOMISE SCREEN GRAPHICS** - Customise the boot up screen graphic.

<sup>1</sup>If you already own an Eclipse E-portal kit (such as the kit included with the Eclipse SLS), this kit will be compatible with the Geo2.

<sup>2</sup>Minimum system requirements :

Monitor Resolution - 1024x768 or higher, CD-ROM drive, Keyboard, Mouse, USB socket, 5MB of hard disk space, 1GHz Processor, 384Mb RAM, Windows XP/Windows Vista/Windows 7, internet connection (required for software and firmware updates).

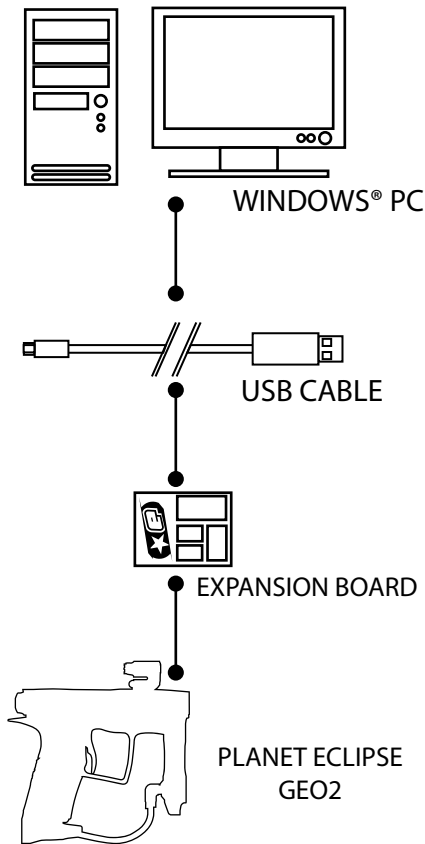

## QUICK GUIDE

CONTENTS

ORIENTATION

QUICK SET-UP

USING YOUR GEO2

MENU TREE

ADVANCED SET-UP

MAINTENANCE

E-PORTAL

FAULT FINDING

SERVICE CENTRES

PARTS LIST

SPARES & ACCESSORIES

INDEX

ECLIPSE E-PORTAL



# FAULT FINDING

SYMPTOM	POSSIBLE CAUSE	SOLUTION
Although a fresh battery has been fitted, the Geo2 will not switch on.	The battery has been fitted incorrectly.	Fit the Battery correctly with the positive terminal nearest to the side of the frame.
	The battery terminals are not making proper contact with the battery.	Remove the Battery, gently bend the terminals towards where the Battery will sit and then replace the Battery.
The battery does not seem to last very long.	The battery type is of a low quality.	Use an alkaline or metal hydride battery. Do not use a low quality or rechargeable battery.
The Geo2 leaks from the Solenoid Assembly.	Check that the Solenoid gasket is intact and seated in its designated pocket in the manifold.	Replace the Solenoid gasket if damaged.
	Damaged Geo2 Solenoid.	Replace Geo2 Solenoid.
	Geo2 Solenoid Assembly is over-pressurising.	Check the Inline Regulator output pressure and consequent velocity. Adjust accordingly.
	Debris on / damage to Spool Pack.	Clean/Replace Spool Pack.
Geo2 leaks down the barrel.	Main Prop Shaft 14 x2 HNBR 70 o-ring is damaged, dirty or dry.	Replace, clean and lubricate 14 x 2 HNBR 70 o-ring on Prop Shaft.
	Internal 017 NBR 70 o-ring and external 020 NBR 70 o-rings on Can are damaged, dry or dirty.	Replace, clean and lubricate 017 NBR 70 o-ring and 020 NBR 70 o-rings on Can.
Gas vents quickly down the barrel as soon as the Geo2 is gasses up	Bolt is stuck in a forward position.	Push Bolt backwards.
	Main Prop Shaft 014x2 o-ring is damaged or an incorrect size.	Replace with a 014x2 size o-ring.
The Geo2 is chopping or trapping paint.	Loader has too high a force setting or paint is poor quality.	Adjust loader setting and try another brand of paint.
	The Break Beam Sensor System is switched off.	Switch on the Break Beam Sensor System.
	The Bolt is dirty causing the Sensor System to incorrectly detect a paintball.	Clean the Bolt.

SYMPTOM	POSSIBLE CAUSE	SOLUTION
The Geo2 is chopping or trapping paint.	The Bream Beam Sensor System is dirty causing the incorrect detection of paintballs.	Clean the Break Beam Sensor System.
The Geo2 does not fire.	Trigger and trigger detection method are set up incorrectly.	Set up trigger correctly (refer to "Setting the Trigger" section).
	Solenoid Assembly is not plugged into Geo2 PCB correctly.	Plug Solenoid Assembly plug into its port on the Geo2 PCB.
	The Break Beam Sensor System is enabled but there is no paintball in the breach.	Fill loader with paint.
	The Micro-switch is not being activated.	Adjust Micro-switch activation screw accordingly.
	Micro-switch is damaged.	Replace circuit board.
The Geo2 does not cycle fully.	Sticky or faulty Back-check Assembly in Solenoid.	Check Back-check Assembly, clean and replace as necessary.
	Bolt Assembly dirty or incorrectly lubricated.	Clean, re-lubricate and replace o-rings on Bolt as necessary.
	Dwell set too low.	Increase Dwell.
The Geo2 has low velocity on the first shot.	FSDO parameters are set too low to overcome o-ring stiction.	Adjust FSD COMP and FSD DLY parameters.
The Geo2 has high velocity on the first shot.	FSDO parameters are set too high.	Adjust FSD COMP and FSD DLY parameters.
	Inline Regulator pressure creeping.	Strip, clean and maintain Inline Regulator. Replace Inline Regulator Piston if necessary.
Geo2 has velocity drop-off during rapid fire.	Air system/regulator does not flow fast enough to keep up.	Try another air system/regulator and replace as necessary.
	Sticky o-rings in Bolt Assembly.	Clean, re-lubricate and replace o-rings on Bolt Assembly as necessary.
	Blocked Filter in Solenoid Assembly.	Clean/replace Filter in Solenoid Assembly as necessary.
	Incorrectly assembled Back-check Assembly.	Remove Back-check Assembly, rebuild correctly and replace.

## QUICK GUIDE

CONTENTS

ORIENTATION

QUICK SET-UP

USING YOUR GEO2

MENU TREE

ADVANCED SET-UP

MAINTENANCE

E-PORTAL

**FAULT FINDING**

SERVICE CENTRES

PARTS LIST

SPARES & ACCESSORIES

INDEX

# FAULT FINDING



## FAULT FINDING

SYMPTOM	POSSIBLE CAUSE	SOLUTION
Geo2 has velocity drop-off during rapid fire.	Poorly maintained Inline Regulator.	Strip, lubricate and rebuild Inline Regulator.
	Battery is poor quality or has insufficient power.	Use an Alkaline or metal hydride battery. Do not use a low quality or rechargeable battery.
On/Off Purge System is leaking from front hole.	006 NBR 90 o-ring inside OOPS Insert is damaged or dry.	Replace the 006 NBR 90 o-ring and lubricate with Eclipse Grease.
Geo2 Trigger is very "bouncy".	Incorrect filter settings.	Check that your trigger filter and debounce settings suit your trigger set-up.
The Break Beam Sensor System does not appear to be reading correctly.	The Break Beam Sensor System is dirty.	Clean the Break Beam Sensor System as per the Maintenance Section.
	Break Beam Sensors are the wrong way around.	Check that the red receiver is on the right-hand side of the Breech.
The Break Beam Sensor System is not reading at all.	There is a broken wire or contact, or a short circuit on either of the Breech Sensor cables.	Check the plug of the cables. Check for cuts or pinches in the sensor cables.
	Either sensor is back to front.	Check that the sensors face each other when installed.
	Two or more balls are being fed into the breech.	Detents are broken/missing
Geo2 is inconsistent.	Inline Regulator is supercharging.	Strip and clean Inline Regulator. (See Maintenance Section .
Break Beam Sensor System turns itself off after firing.	Eye is dirty.	Clean the eyes.
	Eye is faulty.	Replace the eyes.
	Eye is out of place.	Re-Install Eyes. Check alignment.
When the Geo2 powers up, the right hand side of the screen is not displayed and the marker will not fire	The trigger is permanently depressed.	Adjust the Trigger until the selected Trigger detection method is activated when the Trigger is released.

# ECLIPSE CERTIFIED SERVICE CENTRES

Are you unsure of where to send your Geo2 to be repaired or serviced? If your local Eclipse dealer can't assist you, why not contact your nearest Certified Eclipse Service Centre and arrange to send it into them to undertake any work that you require.

## EUROPE

### PLANET ECLIPSE LTD

[ ENGLAND ]

CALL: 01618 725 575  
EMAIL: TECHNICAL@PLANETECLIPSE.COM

### P8NTBALL.BE

[ BELGIUM ]

CALL: +32(0)499-057878  
EMAIL: INFO@P8NTBALL.BE  
VISIT: WWW.P8NTBALL.BE

### AGS

[ CZECH REPUBLIC ]

CALL: ++420 272 762 938  
EMAIL: INFO@PAINTBALLSHOPCZ  
VISIT: WWW.PAINTBALLSHOPCZ

### LONDON PAINTBALL SUPPLIES

[ ENGLAND ]

CALL: 01707 325 007  
EMAIL: SALES@LIPSPAINBALL.COM  
VISIT: WWW.LPSPAINBALL.BIZ

### JUST PAINTBALL

[ ENGLAND ]

CALL: 01325 242 419  
EMAIL: SHOP@JUSTPAINTBALL.CO.UK  
VISIT: WWW.STORE.JUSTPAINTBALL.CO.UK

### CAMP

[ FRANCE ]

CALL: +33(0)1 41 09 1004  
EMAIL: ATELIER@PAINTBALLCAMP.COM  
VISIT: WWW.PAINTBALLCAMP.COM

### PAINTBALL.DE

[ GERMANY ]

CALL: ++49(0) 211 210 2300  
EMAIL: SALESFORCE@PAINTBALL.DE  
VISIT: WWW.PAINTBALL.DE

### PAINTBALL NORGE AS

[ NORWAY ]

CALL: ++47 3802 9710  
EMAIL: POST@PAINTBALLNORGE.NO  
VISIT: WWW.PAINTBALLNORGE.NO

### SKILL PAINTBALL

[ POLAND ]

CALL: ++48 22 875 2777  
EMAIL: INFO@SKILL.COM.PL  
VISIT: WWW.SKILL.COM.PL

### ESTRATEGO PORTUGAL

[ PORTUGAL ]

CALL: ++351 213 863 637  
EMAIL: INFO@ESTRATEGO.PT  
VISIT: WWW.ESTRATEGO.COM

### ACTION PAINTBALL GAMES

[ RUSSIA ]

CALL: +7(0) 95 7851 762  
EMAIL: INFO@PAINTBALL.RU  
VISIT: WWW.PAINTBALL.RU

### DOC'S TECH

[ RUSSIA ]

CALL: +7 911 9496969  
EMAIL: DOC.BO@MAIL.RU

### SISSOS

[ SCANDINAVIA ]

CALL: +358 9 85590093  
EMAIL: HASSE@PAINTBALL.SE  
VISIT: WWW.SISSOS.FI

### ADRENALICIA S.L.

[ SPAIN ]

CALL: ++34 669 011 515  
EMAIL: JOTA@ADRENALICIA.COM  
VISIT: WWW.ADRENALICIA.COM

### STRATEC

[ SWEDEN ]

CALL: +46 (0)31 164871  
EMAIL: INFO@STRATEC.NU  
VISIT: WWW.STRATEC.NU

### THREE 4 ONE

[ SWITZERLAND ]

CALL: +41 (0)79 445 24 12  
EMAIL: SHOP@341.CH  
VISIT: WWW.341.CH

## QUICK GUIDE

CONTENTS

ORIENTATION

QUICK SET-UP

USING YOUR GEO2

MENU TREE

ADVANCED SET-UP

MAINTENANCE

E-PORTAL

FAULT FINDING

SERVICE CENTERS

PARTS LIST

SPARES & ACCESSORIES

INDEX

SERVICE CENTRES



## **NORTH AMERICA**

### **PLANET ECLIPSE LLC**

[ RHODE ISLAND ]

CALL: 401-247-9061  
EMAIL: GERRY.B@PLANETECLIPSE.COM  
VISIT: WWW.PLANETECLIPSE.COM

### **MT. DOOM PAINTBALL**

[ ALABAMA ]

CALL: 256-339-1601  
EMAIL: BRIANPIRKLE@MSN.COM  
VISIT: WWW.MTDOOMPAINBALL.COM

### **DISRUPTIVE PAINTBALL**

[ ARIZONA ]

CALL: 520-320-0333  
EMAIL: DISRUPTIVEPAINTBALL@YAHOO.COM  
VISIT: WWW.DISRUPTIVEPAINTBALL.COM

### **MOUNTAIN VIEW PAINTBALL**

[ CALIFORNIA ]

CALL: 909-373-0998  
EMAIL: MVPSTEVE@MOUNTAINVIEWPAINTBALL.COM  
VISIT: WWW.MOUNTAINVIEWPAINTBALL.COM

### **BADLANDS PAINTBALL**

[ CANADA ]

CALL: 416-245-4084  
EMAIL: TECHZONE@BADLANDSPAINTBALL.COM  
VISIT: WWW.BADLANDSPAINTBALL.COM

### **PAINTBALL SUPPLY SHACK**

[ EAST COAST ]

CALL: 401-353-6040  
EMAIL: PAINTBALLSUPPLY@AOL.COM  
VISIT: WWW.PAINTBALLSHOWCASE.COM

### **SPLAT ATTACK (MIAMI)**

[ FLORIDA & SOUTH AMERICA ]

CALL: 305-412-9991  
EMAIL: SPLATATTACK@GMAIL.COM  
VISIT: WWW.SPLATATTACK.COM

### **ADRENALIN PAINTBALL**

[ GEORGIA ]

CALL: 478-329-8589  
EMAIL: ADRENALINPB@BELLSOUTH.NET  
VISIT:

### **L&M SPORTS**

[ GEORGIA ]

CALL: 229-894-5720  
EMAIL: LMSPORTS1@BELLSOUTH.NET  
VISIT:

### **FRONTLINE PAINTBALL**

[ INDIANA ]

CALL: 614-539-4440  
EMAIL: FRONTLINEPB@SBCGLOBAL.NET  
VISIT: WWW.WALLTOWALLPAINTBALL.COM

### **GUNFIGHTER PAINTBALL**

[ LOUISIANA ]

CALL: 985-727-4370  
EMAIL: INFO@GUNFIGHTERPAINTBALL.COM  
VISIT: WWW.GUNFIGHTERPAINTBALL.COM

### **TC PAINTBALL/MAGNUM SPORTS**

[ MICHIGAN ]

CALL: 616-249-8227  
EMAIL: RICK.STEINEBACH@GMAIL.COM  
VISIT: WWW.TCPAINTBALL.COM

### **AIR ASSAULT PAINTBALL**

[ MINNESOTA ]

CALL: 763-479-3113  
EMAIL: INFO@AIRASSAULTPAINTBALL.COM  
VISIT: WWW.AIRASSAULTPAINTBALL.COM

### **SWAT PAINTBALL**

[ MISSISSIPPI ]

CALL: 877-927-7331  
EMAIL: GERWIN@SWATPAINTBALL.COM  
VISIT: WWW.SWATPAINTBALL.COM

### **PROSTAR PB**

[ NEBRASKA ]

CALL: 402-403-1880  
EMAIL: WALT@PROSTARPB.COM  
VISIT: PROSTARPB.COM

### **OPERATION STINGRAY**

[ NEW YORK ]

CALL: 718-384-1280  
EMAIL: INFO@STINGRAYDIVERS.COM  
VISIT: WWW.STINGRAYOPS.BLOG.COM

### **PAINTBALL CENTRAL**

[ NORTH CAROLINA ]

CALL: 336-274-4002  
EMAIL: KRIS@PBCENTRAL.COM  
VISIT: WWW.PBALLCENTRAL.COM

### **THE PAINTBALL SPHERE**

[ OHIO ]

CALL: 330-965-9099  
EMAIL: SPHEREPOINT@ZOOMINTERNET.NET  
VISIT: WWW.THEPAINTBALLSPHERE.COM

### **WAR PAINT INTERNATIONAL**

[ OREGON ]

CALL: 503-585-9477  
EMAIL: ADAM@WARPAINTPB.COM  
VISIT: WWW.WARPAINTPB.COM

### **PRO SHOP PAINTBALL**

[ TEXAS ]

CALL: 210-523-5000  
EMAIL: PROSHOPPAINTBALL@GMAIL.COM  
VISIT: WWW.PROSHOPPAINTBALL.COM

### **PNL PAINTBALL**

[ VERMONT & MASSACHUSETTS ]

CALL: 508-697-5808  
EMAIL: PNLPAINTBALL@AOL.COM  
VISIT: WWW.PNLPAINTBALL.COM

## DGX PAINTBALL

[ WEST COAST & CALIFORNIA ]

CALL: 707-255-5166

EMAIL: DC@DGXPAINBALL.COM

VISIT: WWW.DGXPAINBALL.COM

## I-70 PAINTBALL

[ WEST VIRGINIA ]

CALL: 937-237-7070

EMAIL: SERVICE@I70PAINTBALL.COM

VISIT: WWW.I70PAINTBALL.COM

# REST OF WORLD

## ACTION PAINTBALL GAMES

[ AUSTRALIA ]

CALL: ++61 2 9679 0011

EMAIL: SALES@ACTIONPAINTBALL.COM.AU

VISIT: WWW.ACTIONPAINTBALL.COM.AU

## MEGA PLAY MORUMBI PAINTBALL

[ BRAZIL ]

CALL: (11) 3771-2969

EMAIL: PAINTBALL@MEGAPLAYMORUMBI.COM.BR

VISIT: WWW.MEGAPLAYMORUMBI.COM.BR

## BRAZIL'S MOST WANTED PAINTBALL

[ BRAZIL ]

CALL: 55-61-8406-5781

CALL: 55-61-3345-1664

EMAIL: ANDREOBARROS@GMAIL.COM

VISIT: WWW.BMWPAINBALL.COM

## EL 2NEL

[ CHILE ]

CALL: (56+2) 8393852

EMAIL: MLOBOS@2NEL.CL

VISIT: WWW.2NEL.CL

## FAST DUCKS PAINTBALL

[ COLOMBIA ]

CALL: 7119410-2382922

EMAIL: ARIEL@FASTDUCKSPAINTBALL.COM

VISIT: WWW.FASTDUCKSPAINTBALL.COM

## SKIRMISH PAINTBALL ASIA

[ MALAYSIA ]

CALL: ++603 7722 5629

EMAIL: INFO@SKIRMISHPAINTBALLASIA.COM

VISIT: WWW.SKIRMISHPAINTBALLASIA.COM

## EXTREME SPORTS MEXICO

[ MEXICO ]

CALL: 619-392-8563

CALL USA: 619-567-6141

CALL MEXICO: 664-630-8742

EMAIL: JACUZZI9@HOTMAIL.COM

## THE PAINTBALL SHOP

[ SOUTH AFRICA -CENTURION]

CALL: ++27 126534650

EMAIL: PAINTBALLSHOP@CINET.CO.ZA

VISIT: WWW.PAINTBALLSHOP.CO.ZA

## THE PAINTBALL SHOP

[ SOUTH AFRICA -PORT ELIZABETH]

CALL: ++27 413743715

EMAIL: INFO@PAINTBALLSHOP.CO.ZA

VISIT: WWW.PAINTBALLSHOP.CO.ZA

## VIPER PAINTBALL SUPPLY

[ VENEZUELA ]

CALL: 584122060751

EMAIL: VIPERTCPS@HOTMAIL.COM

# QUICK GUIDE

CONTENTS

ORIENTATION

QUICK SET-UP

USING YOUR GEO2

MENU TREE

ADVANCED SET-UP

MAINTENANCE

E-PORTAL

FAULT FINDING

SERVICE CENTRES

PARTS LIST

SPARES & ACCESSORIES

INDEX

# SERVICE CENTRES

# 71.



# PARTS LIST

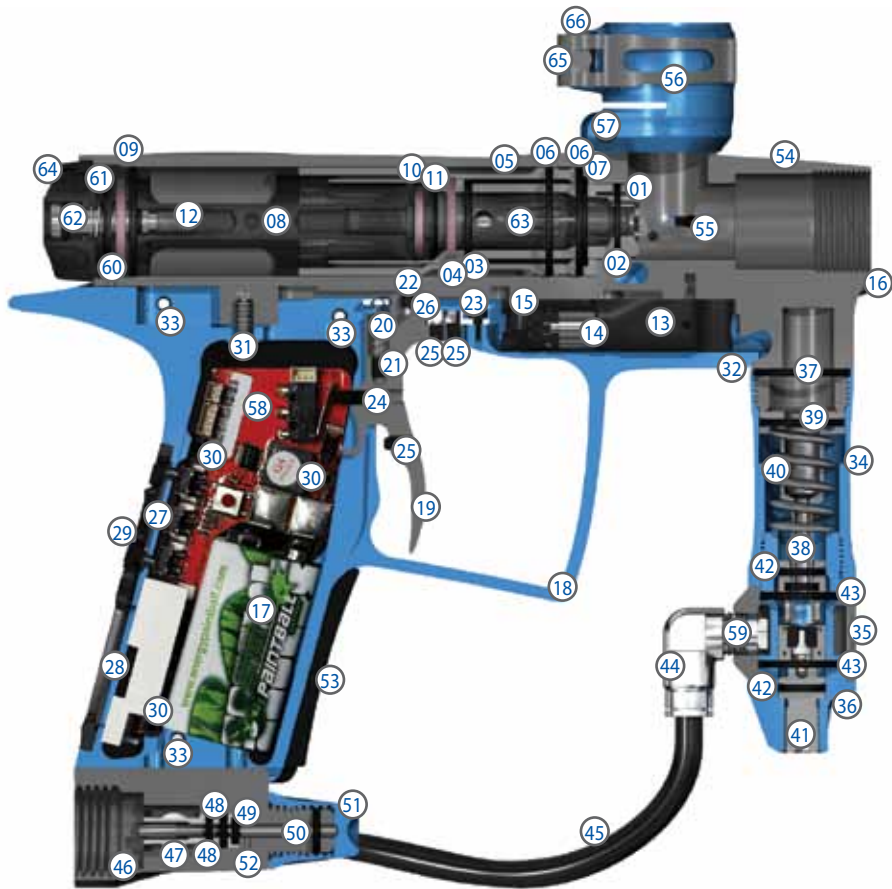



## PART NAME

- |   |                                       |                                  |
|---|---------------------------------------|----------------------------------|
| 01 Bolt                                     | 27 Plastic Push Button Strip          | 54 Body                          |
| 02 Bolt Front o-ring                        | 28 Display Window                     | 55 Anti Double Ball (ADB) Finger |
| 03 Bolt Bumper o-ring                       | 29 Navigation Console                 | 56 Clamping Feed Tube            |
| 04 Bolt Rear o-ring                         | 30 PCB Retaining Screw                | 57 Clamping Feed Tube Screw      |
| 05 Can                                      | 31 Rear Frame Screw                   | 58 Printed Circuit Board (PCB)   |
| 06 External Can o-rings                     | 32 Front Frame Screw                  | 59 Inline Purge Control Valve*   |
| 07 Can inner o-ring                         | 33 Rubber Grip Screw                  | 60 Prop Shaft Rear o-ring        |
| 08 Prop Shaft                               | 34 Inline Regulator Top               | 61 Prop Shaft Rear Bumper        |
| 09 Prop Shaft Back Cap o-ring               | 35 Inline Regulator Swivel Collar     | 62 Prop Shaft Spring             |
| 10 Prop Shaft Middle o-ring                 | 36 Inline Regulator Bottom            | 63 Prop Shaft Tip                |
| 11 Prop Shaft Front Bumper                  | 37 Inline Regulator Top o-ring        | 64 Prop Shaft Back Cap           |
| 12 Prop Shaft Screw Assembly                | 38 Inline Regulator Piston            | 65 Clamping Feed Sprocket Screw  |
| 13 Solenoid Assembly                        | 39 Inline Regulator Piston o-ring     | 66 Clamping Feed Swivel          |
| 14 Pilot Valve                              | 40 Inline Regulator Spring            |                                  |
| 15 Back-check Assembly                      | 41 Inline Regulator Adjuster Assembly |                                  |
| 16 Body Plug                                | 42 Inline Regulator Adjuster o-ring   |                                  |
| 17 9 Volt Battery                           | 43 Inline Regulator Bottom o-ring     |                                  |
| 18 Frame                                    | 44 1/4" Elbow                         |                                  |
| 19 Trigger                                  | 45 1/4" Hose                          |                                  |
| 20 Trigger Spring                           | 46 OOPS Body                          |                                  |
| 21 Trigger Spring Adjuster Set Screw        | 47 OOPS Insert                        |                                  |
| 22 Trigger Pin Locking Set Screw            | 48 External OOPS Insert o-ring        |                                  |
| 23 Bearing Carrier Assembly<br>(inc Magnet) | 49 Internal OOPS Insert o-ring        |                                  |
| 24 Micro-switch Activation Set Screw        | 50 OOPS Pin                           |                                  |
| 25 Trigger Stop Set Screw                   | 51 OOPS Knob                          |                                  |
| 26 Trigger Pin                              | 52 OOPS Adjuster Screw                |                                  |
|   | 53 Rubber Grip                        |                                  |

\* Inside 1/4" Elbow

## QUICK GUIDE

CONTENTS

ORIENTATION

QUICK SET-UP

USING YOUR GEO2

MENU TREE

ADVANCED SET-UP

MAINTENANCE

E-PORTAL

FAULT FINDING

SERVICE CENTRES

PARTS LIST

SPARES & ACCESSORIES

INDEX













# PARTS LIST









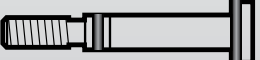



73.



# PARTS LIST

74.

SCREW	QTY	DESCRIPTION
	5	PCB SCREW (3), BEARING CARRIER SCREW (2) (M2.5 x5 CAP HEAD SOCKET)
	2	SOLENOID SCREW (2) (M2.5 x12 CAP HEAD SOCKET)
	8	RUBBER GRIP SCREW (6), BBSS COVERS SCREW (2) (6-32UNC x5/16 COUNTERSUNK SOCKET)
	1	SHORT FEED NECK SCREW (1 x10-32UNF x1/2 CAP HEAD SOCKET)
	1	CLAMPING FEED SPROCKET (CUSTOM MANUFACTURED)
	1	MICRO-SWITCH SCREW (6-32 UNC x1/2 SOCKET SET SCREW)
	1	TRIGGER PIN RETAINING SCREW (6-32 UNC x1/8 SOCKET SET SCREW)
	4	TRIGGER LOCKING SCREW (6-32 UNC x3/16 SOCKET SET SCREW)
	2	OOPS SCREW (10-32 UNF x1/2 SOCKET SET SCREW)
	1	SHORT FRAME SCREW (10-32 UNF x3/8 SOCKET BUTTON HEAD)
	1	LONG FRAME SCREW (10-32 UNF x3/4 SOCKET BUTTON HEAD)
	1	BODY PLUG (CUSTOM MANUFACTURED)
	1	PROP SHAFT RETAINING SCREW (CUSTOM MANUFACTURED)

O-RING	LOCATION	O-RING	LOCATION
 20X2	Back Cap	 14X2	Prop Shaft Back (x2) HNBR70 Bolt Rear HNBR70
 020	Can Outside (x2)	 013	Bolt Front
 017	Can Inside Geo2 Body FRM	 011	SL3 Inline Reg Adjuster Outside
 016	SL3 Inline Reg Piston SL3 Inline Reg Bottom Shaft4 Back (Body End)	 009	Prop -Shaft Retaining Screw Rear
 015	Shaft4 Back (Tip End) Bolt Bumper (Middle) NBR90	 008	OOPS Insert Outside SL3 Inline Reg Adjuster Inside
		 7X1	Prop -Shaft Tip
		 006	Body Plug OOPS Insert Inside (NBR 90)
		 4X1	Prop -Shaft Retaining Screw Front
<b>ALL O-RINGS ARE NBR 70 DUROMETER UNLESS OTHERWISE STATED.</b>			

## QUICK GUIDE

CONTENTS

ORIENTATION

QUICK SET-UP

USING YOUR GEO2

MENU TREE

ADVANCED SET-UP

MAINTENANCE

E-PORTAL

FAULT FINDING

SERVICE CENTRES

PARTS LIST

SPARES & ACCESSORIES

INDEX

# PARTS LIST



**ALL THE ACTION!**  
Videos. Team Profiles. Interviews. Features.



GET MORE AT  
[PLANETECLIPSE.COM/ETV](http://PLANETECLIPSE.COM/ETV)

### ECLIPSE GREASE

The recommended grease for use in all maintenance and servicing procedures that require grease.



### TECH FLEX MAT

Protect your Geo2 whilst you maintain it with the Eclipse Tech Flex Mat.



### ECLIPSE E-PORTAL

Connect your GEO2 to a PC for ultimate customisability. See page 65 for more information on the E-Portal.



### GEO2 SERVICING & SPARES

Contact your nearest service centre for all your service and spares needs. See the service centre list or interactive map at [www.planeteclipse.com](http://www.planeteclipse.com).



### BALL DETENTS

10 Replacement rubber Detents for your Geo2.



### ECLIPSE GEO2 TOOL TUBE

This handy little tool tube includes all of the hex key sizes that you will need to strip and maintain your Geo2.



## QUICK GUIDE

CONTENTS

ORIENTATION

QUICK SET-UP

USING YOUR GEO2

MENU TREE

ADVANCED SET-UP

MAINTENANCE

E-PORTAL

FAULT FINDING

SERVICE CENTRES

PARTS LIST

SPARES & ACCESSORIES

INDEX

# SPARES

77.



## INDEX

Actual Rate of Fire.....27  
Adjuster Screw.....8  
Adjuster Top.....8  
Advanced Trigger Filter Setup.....40  
*ALARM*.....31, 45  
Air System.....16 – 17  
Anti Double Ball.....72 – 73  
*AUTO OFF*.....30, 42  
*AUX OUT*.....30, 42  
*AUX OUT Indicator*.....23 - 24  
*BACK*.....28 - 31  
Back-Check Assembly.....10, 72 – 73  
*BACKLIGHT*.....30, 41  
Basic Trigger Filter Set-up.....40  
Battery.....6, 13, 72 – 73  
Battery Level Indicator.....23, 26  
Bearing Carrier Assembly.....72 – 73  
Bearing Carrier Screw.....74  
Blanking Plug.....6  
*BLU LEVEL*.....30, 42  
Body.....6, 72 – 73  
Body Plug.....72 – 74  
Bolt.....9, 72 – 73  
Bolt Bumper O-ring.....72 - 73  
Bolt Front O-ring.....72 – 73  
Bolt Rear O-ring.....72 - 73  
Bolt System.....6, 9, 51 - 54  
Break Beam Sensor System (BBSS).....15, 46 - 47  
Break Beam Sensor System Indicator.....23 - 24  
*BS OFF ROF*.....28, 35  
*BS ON ROF*.....28, 35  
Can.....9, 72 – 73  
Can External O-rings.....72 – 73  
Can Internal O-ring.....72 – 73  
*CANCEL*.....28 – 29  
Clamping Feed Sprocket Screw.....72 – 74  
Clamping Feed Swivel.....72 – 73  
Clamping Feed Tube.....72 – 73  
Clamping Feed Tube Screw.....72 – 73  
Clamping Lever.....6  
Circuit Board.....6, 14  
*DBL CLICK*.....31, 42  
*DEBOUNCE*.....29, 39  
Display Option.....23  
Display Window.....72 – 73

*DWELL*.....29, 38  
*E-Portal*.....65  
*EMPTY*.....29, 39  
*EXIT*.....31  
Expansion Board.....65  
Eye Cover.....6  
Eye Cover Screw.....6, 74  
*FACTORY*.....28  
Feedneck.....6, 19  
*FILTER*.....21, 38  
*FIRE MODE*.....28, 35  
Frame.....55 – 57, 72 – 73  
Frame Screw.....6  
Front Bumper.....9  
Front Frame Screw.....72 – 74  
Front Stop Trigger Screw.....20  
*FSD COMP*.....29, 38  
*FSD DELAY*.....29, 38  
*FULL*.....30, 39  
*GAME*.....31, 45  
Game Timer.....26, 31  
Gasket and Filter.....10  
*GAUGE*.....31, 44  
*GAUGE MAX*.....31, 44  
*GRN LEVEL*.....30, 42  
*HARDWARE*.....40  
Inline Purge Control Valve.....72 – 73  
Inline Regulator Adjuster Screw.....50, 72 – 73  
Inline Regulator Assembly.....6, 48 - 49  
Inline Regulator Bottom.....8, 72 – 73  
Inline Regulator Piston.....8, 72 – 73  
Inline Regulator Spring.....8, 72 – 73  
Inline Regulator Swivel.....8, 72 – 73  
Inline Regulator Top.....8, 72 – 73  
*KICK-IN*.....29, 37  
*LOAD*.....28, 34  
Loader.....19  
Lock Indicator.....23, 26  
*LINEAR*.....29  
Macroline Elbow.....6, 18, 72 – 73  
Macroline Fitting.....8  
Macroline Hose.....18, 72 – 73  
Magnet Return Strength Screw.....20  
Manifold.....10  
Main Menu.....28 – 31, 33  
Menu System.....27, 31  
Menu Tree.....28-31  
Micro-switch Activation Screw.....21, 72 – 74

MS 10.....28  
 Navigation Console.....11, 72 – 73  
 NPPL..... 28  
 On/Off Purge System (OOPS).....6, 16 – 17, 63 - 64  
 OOPS Body..... 72 – 73  
 OOPS Insert..... 72 – 73  
 OOPS Knob.....16 – 17, 72 – 73  
 OOPS Pin..... 72 – 73  
 OOPS Adjuster Screw..... 72 – 74  
 Operational Overview.....12  
 Parameters.....32  
 PCB Retaining Screw..... 72 – 74  
 Peak Rate of Fire.....27  
 Pilot Valve.....6, 10, 72 – 73  
 Plastic Push Button Strip.....72 – 73  
 PRESET.....28, 34  
 Printed Circuit Board.....72 – 73  
 Prop Shaft.....9, 72 – 73  
 Prop Shaft Back Cap.....9, 72 – 73  
 Prop Shaft Back Cap O-ring.....72 – 73  
 Prop Shaft Front Bumper.....72 – 73  
 Prop Shaft Middle O-ring.....72 – 73  
 Prop Shaft Retaining Screw.....9, 74  
 Prop Shaft Screw Assembly.....72 – 73  
 Prop Shaft Spring.....9, 72 – 73  
 Prop Shaft Tip.....9, 72 – 73  
 PSP 10.....28  
 PSP 12.....28  
 PULL PT.....30, 39  
 PULL TM.....30, 39  
 Purge Control Valve.....8  
 Purge Poppet Assembly.....8  
 RAMP.....28  
 RAMP SET UP.....29, 36  
 RATE.....29, 36  
 Rear Bumper.....9  
 Rear Frame Screw.....72 – 74  
 Rear Stop Trigger Screw.....20  
 RED LEVEL.....30, 41  
 Regulator Seal.....8  
 RELEASE PT.....30, 39  
 RELEASE TM.....30, 39  
 RESTART.....29, 37  
 ROF CAP.....28, 35  
 Rubber Grip..... 72 – 73  
 Rubber Grip Screw..... 72 – 74  
 Run Screen.....23  
 SL3 Inline Regulator.....8  
 SAVE.....28, 34  
 SEMI.....28  
 SEMI SHOTS.....29, 37  
 Shaft4 Barrel.....7  
 SHOT COUNT.....31, 44  
 Shot Counter.....26  
 Solenoid Assembly.....6, 10, 58 – 60, 72 – 73  
 Solenoid Retaining Screw.....6, 74  
 SOUND.....30, 41  
 Sound Indicator.....23, 25  
 Spool Pack.....10  
 Spool Pack Retaining Screw.....10  
 Spring Return Strength Screw.....21  
 START.....31, 45  
 STEP.....29  
 SUSTAIN.....29, 37  
 TIMER.....45  
 TIMING.....37  
 TONES.....30, 41  
 TRAINING.....31, 43  
 Trigger.....6, 20 – 21, 72 – 73  
 TRIGGER.....30, 41  
 Trigger Assembly.....61 - 62  
 Trigger Detection Indicator (TDI).....21, 23, 25  
 Trigger Pin..... 72 – 73  
 Trigger Pin Locking Set Screw.....72 – 74  
 Trigger Pin Retaining Screw.....74  
 Trigger Spring..... 72 – 73  
 Trigger Spring Adjuster Set Screw.....72 – 73  
 Trigger Stop Set Screw.....72 – 73  
 T-Slot Mounting System.....18  
 TURN OFF.....28  
 TYPE.....29, 36  
 USB Cable.....65  
 USER1.....28  
 USER2.....28  
 User Interface.....23  
 Velocity.....22

## QUICK GUIDE

CONTENTS

ORIENTATION

QUICK SET-UP

USING YOUR GEO2

MENU TREE

ADVANCED SET-UP

MAINTENANCE

E-PORTAL

FAULT FINDING

SERVICE CENTRES

PARTS LIST

SPARES & ACCESSORIES

INDEX

INDEX



GET MORE AT [PLANETECLIPSE.COM](http://PLANETECLIPSE.COM)

130 Franklin Street, Building L4 & L5, Warren, Rhode Island, 02 885, U.S.A  
Call UK & Europe: +44 (0)161 872 5572 Call USA & Canada: 401 247 9061

Licensed under one or more of the following patents:

US 6311682, 6615814, 5881707, 5967133, 6035843, 6474326B1, 6637421B2 UK GB 234270, GB 2345953

© 2010 Copyright Planet Eclipse Ltd. Eclipse, the Estar Logo Device, Eclipse E-Portal, Ego, Etek and Geo are all either design trademarks, registered trademarks or trademarks of Planet Eclipse Ltd.

*Windows is a registered trademark of Microsoft Corporation in the United States and other countries.*