



LUXE®

VIII X XVIII

OWNER'S MANUAL



CONTENTS

GET TO KNOW YOUR NEW LUXE® MARKER

1

ORIENTATION

WELCOME TO THE LUXE® EXPERIENCE. Please read this section thoroughly before you use your Luxe®, to learn about important safety and operation procedures.

- LUXE SPECS & FEATURES** * * * 00 *
- 1.1 QUICK START** * * * 01 *
- 1.2 INSTALLING THE BARREL BLOCKER** * * * 04 *
- 1.3 SELECTING AND INSTALLING A LOADER** * * * 04 *
- 1.4 HANDLING THE LiPo BATTERY** * * * 04 *

2

AIR

YOUR LUXE® RELIES ON THE POWER of high-pressure compressed air for fast, quiet and consistent operation. Proper air system handling is extremely important for your safety.

- 2.1 ABOUT COMPRESSED AIR** * * * 06 *
- 2.2 INSTALLING AN AIR SYSTEM** * * * 07 *
- 2.3 REGULATOR GRIP PANEL** * * * 07 *

3

HARDWARE

THE PHYSICAL ASPECTS OF OPERATING and adjusting your new Luxe® have been streamlined to get you in the game fast. This section will inform you about trigger and velocity adjustment as well as barrel tuning and battery maintenance.

- 3.1 LUXE® BARREL SYSTEM** * * * 08 *
- 3.2 ADJUSTING VELOCITY** * * * 09 *
- 3.3 DEGASSING THE SYSTEM** * * * 09 *
- 3.4 ADJUSTING THE TRIGGER** * * * 10 *
- 3.5 LiPo RECHARGEABLE BATTERY** * * * 11 *
- 3.6 REPLACING OR CHARGING THE BATTERY** * * * 11 *

THIS IS NOT A TOY. LUXE® ELECTROPNEUMATIC .68 CALIBER PAINTBALL MARKER. Misuse/careless use may cause serious injury or death. Eye protection in compliance with ASTM Specification F1776, with temple, ear and face protection must be worn by anyone within range of the Luxe®. Must be at least 18 years old



4

SOFTWARE

YOUR LUXE® HAS A COMPUTER on board to provide precise control of its operation. Fortunately, you won't need to be a computer expert to use it. Voice menus, an OLED screen and trigger programming interface put complete control at your fingertips.

- 4.1 INTRODUCTION TO PROGRAMMING** * * * 12 *
- 4.2 NAVIGATION MODES** * * * 13 *
- 4.3 ADDITIONAL POWER BUTTON FUNCTIONS** * * * 13 *
- 4.4 RESET TO FACTORY DEFAULTS** * * * 13 *
- 4.5 USB INTERFACE** * * * 13 *
- 4.6 FIRING MODES AND SETTINGS** * * * 14 *
- 4.7 MENU SETTINGS** * * * 15 *

5

MAINTENANCE

REGULAR MAINTENANCE IS NECESSARY to keep your Luxe® in peak operating condition. Tool-free access to the Luxe® Power Core and ball detents make this a quick and simple process.

- 5.1 LUXE® POWER CORE** * * * 17 *
- 5.2 BALL DETENTS & VISION™ EYES** * * * 19 *

6

ADVANCED MAINTENANCE

SHOULD ANYTHING GO WRONG with your marker, your Certified Luxe® Dealer is ready and able to provide complete warranty support without the hassle or wait of shipping your marker. For the more more technically inclined, advanced maintenance guides cover more complex service procedures.

- 6.1 INTRODUCTION** * * * 21 *
- 6.2 SERVICING THE VERTICAL REGULATOR** * * * 22 *
- 6.3 BALL DETENT ASSEMBLIES** * * * 24 *
- 6.4 GRIP FRAME REMOVAL** * * * 25 *
- 6.5 VISION AND SOLENOID VALVE REMOVAL** * * * 26 *
- 6.6 THE LUXE® ICE ADVANTAGE** * * * 28 *
- 6.7 QUICK-STRIP PLUG DISASSEMBLY** * * * 29 *
- 6.8 ASA REMOVAL** * * * 31 *
- 6.9 TRIGGER REMOVAL** * * * 31 *
- 6.10 SPEAKER REMOVAL** * * * 32 *
- 6.11 CIRCUIT BOARD REMOVAL** * * * 32 *
- 6.12 TROUBLESHOOTING** * * * 33 *
- 6.13 LIMITED WARRANTY** * * * 34 *

to purchase, 14 years old to use or operate with adult supervision, 10 years or older to operate on insured paintball fields meeting ASTM-standard F1777-97.

Thoroughly read entire operating manual before using. **DLX TECHNOLOGY GROUP, 100 STATION ST., LOYALHANNA, PA . 15661**
WWW.LUXEPAINTBALL.COM

ORIENTATION

GET TO KNOW YOUR NEW LUXE® MARKER















BASIC GUIDE TO THE LUXE® SPECS & FEATURES

MAIN CONTROLS & FEATURES

- 1 ✖ ✖ POWER/OLED DISPLAY
- 2 ✖ ✖ TRIGGER
- 3 ✖ ✖ GRIP
- 4 ✖ ✖ REMOVABLE BATTERY (UNDER GRIP)
- 5 ✖ ✖ LUXE® POWER CORE
- 6 ✖ ✖ CLAMPING FEEDNECK
- 7 ✖ ✖ LUXE® XL 3-PIECE BARREL SYSTEM
- 8 ✖ ✖ LUXE® INTEGRATED AIR BOTTOM LINE
- 9 ✖ ✖ LUXE® INTEGRATED AIR VERTICAL REGULATOR
- 10 ✖ ✖ LUXE® QUICK-SNAP BALL DETENT ASSEMBLY (2)



THE FINE DETAILS

 WEIGHT (LESS BARREL) 1.48 lbs (0.675 kg)	 OPERATING PRESSURE 110 psi (7.58 bar)	 OPERATING METHOD Electropneumatic
 DIMENSIONS 8.25 x 7 in (21.0 x 17.8 cm)	 POWER SOURCE LiPo Rechargeable Battery	 ANTI-CHOP SYSTEM 630nm Vision Break Beam
 PAINT SIZE .68 caliber	 PROPELLANT Compressed Air	 RATE OF FIRE Uncapped
 FIRING MODES 8	 BARREL THREADS Smart Parts	 LUBRICANT GR33SE™

fit.

ORIENTATION

GET TO KNOW YOUR NEW LUXE® MARKER

ORIENTATION 1.1 QUICK START

WELCOME TO THE LUXE® EXPERIENCE. Follow these simple steps to get your new Luxe® marker up and running in no time.

1



STEP ONE CHARGE THE BATTERY (INCLUDED)

MAKE SURE THE LUXE®'S INTERNAL LITHIUM-POLYMER BATTERY is fully charged. Open the rubber grip from the left side your Luxe® and connect the charger to the charging port before plugging the charger into a domestic electrical outlet. The included charger will operate on either 110 or 240 volt standard AC power. The LED on the charger will glow when it is plugged in and receiving power, whether it is charging a Luxe® or not. The Luxe® X is compatible with standard USB and USB-C chargers, allowing it to be charged directly from a portable phone power pack, car USB power source, laptop computer or other USB compliant power supply. The battery may also be removed and charged separately with the optional Luxe® battery charger. The battery may also be removed and charged separately with the optional Luxe® battery charger. It must be fully seated in the grip frame for on-board charging.

2



STEP TWO REINSTALL THE GRIP

REINSTALL THE LUXE®'S RUBBER GRIP by first sliding its tab into the slots on either side of the grip frame, then pop it back in place over the 2 snap grip screws and 2 grip screws on the opposing side of the grip. Ensure that the battery wedge extending from the center of the grip fills the small gap above the top of the battery, locking it in place.

3



STEP THREE AFFIX THE BARREL BLOCKER (INCLUDED)

ASSEMBLE THE LUXE® BARREL (see **HARDWARE 3.4**) and screw it into your Luxe®. Slide the included barrel blocker over the barrel and secure its cord as far back on the Luxe® body as possible, cinching it tight. The barrel blocker is a critical piece of paintball safety equipment—nearly as important as paintball goggles. The barrel blocker must be fully seated on the marker's muzzle and secured in place with its strap any time the marker is stored or handled in an area where people are not properly protected by paintball goggles or paintball field netting.

ORIENTATION

GET TO KNOW YOUR NEW LUXE® MARKER

4



STEP FOUR FILL & INSTALL YOUR AIR TANK (SOLD SEPARATELY)

YOUR LUXE® IS DESIGNED TO OPERATE PROPERLY with high pressure compressed air (HPA—also commonly referred to in paintball as *nitrogen* or *nitro*) as its power source. Have your air system filled, following its manufacturer's directions. Pull the Luxe® bottom-line charging handle out and forward to the off position, then screw the air system into the back of the ASA.

5



STEP FIVE INSTALL YOUR LOADER (SOLD SEPARATELY)

THE ANTI-CHOP VISION™ SYSTEM IN YOUR LUXE® will allow it to work with any loader. Best performance and highest rate of fire however, will only be possible with a high performance force-feed loader system. Open the marker's locking feedneck by pulling the lock lever away from the neck, then insert the loader and secure it in place by folding the lever back to its locked position. Loader necks vary in size from brand to brand. If the loader does not fit securely or the lock lever does not easily close, see Orientation 1.3 in this manual for feedneck clamp adjustment instructions.

6



STEP SIX TURN ON AIR

GENTLY GAS UP YOUR LUXE® BY SLOWLY PULLING the Luxe® bottom-line charging handle back to the on position, folding it into the body of the ASA. This will depress the valve pin on your air system.

WARNING

A GENTLE RISE IN PRESSURE IS IMPORTANT, AS A SUDDEN BLAST MAY REDUCE THE SERVICE LIFE OF PRESSURE SEALS WITHIN YOUR LUXE®.

The Luxe® bottom-line charging handle must be turned off (pulled out) before removing screw-in compressed air systems.

ORIENTATION

GET TO KNOW YOUR NEW LUXE® MARKER

7

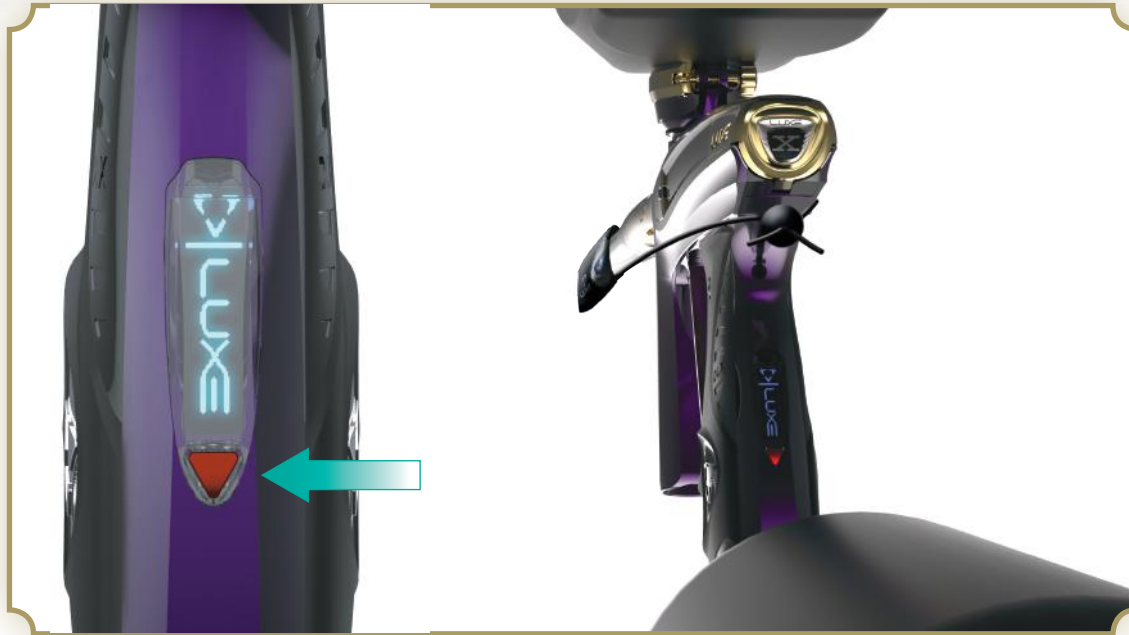

STEP SEVEN POWER ON YOUR LUXE® MARKER

TURN THE MARKER ON BY DOUBLE-CLICKING (quickly pressing twice) the power button, or by holding it down for two seconds. Turn it off by pressing and holding the power button for two seconds. When the Luxe® turns on, the OLED display will be activated, indicating the marker's status.

∞ WARNING ∞

ALTHOUGH THE POWER BUTTON SERVES AS THE LUXE®'S SAFETY SWITCH TO PREVENT ACCIDENTAL FIRING, IT SHOULD NEVER BE RELIED UPON IN PLACE OF A BARREL BLOCKER AND PROPER PAINTBALL EYE PROTECTION.

8



STEP EIGHT ADJUST LUXE® VELOCITY

FILL THE HOPPER WITH PAINTBALLS and turn it on. While wearing ASTM compliant paintball goggles, in an area where all bystanders are protected, remove the barrel blocker and fire over a chronograph to measure the velocity. Using a 5/32-inch allen wrench on the adjuster in the bottom of the vertical regulator, turn clockwise to increase velocity/pressure, and counterclockwise to decrease. Take three or four shots after every adjustment to allow the gas pressure inside your Luxe® to stabilize before firing over the chronograph again to check velocity. Adjust until the marker is firing consistently within the limits for the field where you are playing.

∞ WARNING ∞

NEVER ADJUST YOUR LUXE® TO FIRE AT GREATER THAN 300 FEET PER SECOND.

ORIENTATION

GET TO KNOW YOUR NEW LUXE® MARKER

FIG. 1

1



FIG. 2

2



ORIENTATION 1.2 INSTALLING THE BARREL BLOCKER

THE BARREL BLOCKING DEVICE IS A CRITICAL PIECE of paintball safety equipment—nearly as important as paintball goggles. The Barrel Blocker serves to protect against accidental discharge of a paintball by catching it before it can cause harm. A Barrel Blocker is included with the Luxe® and must be used every time it is handled in an area where people or property are not properly protected by paintball goggles or paintball field netting. To use the Barrel Blocker simply slip it over the end of the barrel and stretch its cord back over the rear of the Luxe® [FIG. 1] Use the strap's adjuster to cinch the strap tight, so that the Barrel Blocker can provide protection against accidental discharge of a paintball.

WARNING

THE BARREL BLOCKER SHOULD ONLY BE REMOVED WHEN THE LUXE® IS ON A “LIVE” PAINTBALL FIELD AND ALL PERSONS INVOLVED ARE WEARING PROPER PAINTBALL PROTECTION.

ORIENTATION 1.3 SELECTING AND INSTALLING A LOADER

YOUR LUXE® IS A HIGH PERFORMANCE PROFESSIONAL GRADE PAINTBALL MARKER. Although its Vision anti-chop system will allow it to operate properly with any paintball loader without fear of chopping paint, a high-end forced-feed loader must be used to achieve high rates of fire.

The Luxe® is equipped with a locking feedneck which allows it to adapt to variance in hopper neck sizes and to release hoppers quickly when desired, but hold them securely on the field [FIG. 2] Pulling the lock lever away from the feedneck moves it to the open, or unlocked position. While it is open the locking mechanism may be adjusted by turning its knurled knob, or using a 1/8-inch allen wrench if it is stiff. Turning clockwise will cause the feedneck to grip tighter, while turning it counterclockwise will result in a better fit for larger hopper necks. Place the hopper in the feedneck, and secure it by closing the lever. If the latch is difficult to close, do not force it. Instead, open it fully, then turn the adjuster counter-clockwise and try again until you have adjusted for a perfect fit.

WARNING

OVER-TIGHTENING THE FEED NECK CAN CAUSE DAMAGE TO ITS LATCHING MECHANISM. DO NOT OVER-TIGHTEN.

ORIENTATION 1.4 HANDLING THE LiPo BATTERY

INCLUDED WITH YOUR LUXE® IS A RECHARGEABLE LITHIUM-POLYMER BATTERY. The battery may be removed for inspection, charging with the optional Luxe® battery charger or for a quick-change with a fully charged battery. For battery removal instructions, see the Hardware section of this manual.

WARNING

DO NOT IMMERSE THE BATTERY IN LIQUID. STORE IN A COOL, DRY ENVIRONMENT WHEN NOT IN USE. DO NOT CONNECT THE BATTERY DIRECTLY TO AN ELECTRICAL OUTLET. DO NOT STRIKE OR THROW THE BATTERY AGAINST A HARD SURFACE. DO NOT MODIFY, PIERCE, OR SOLDER NEW CONNECTIONS TO THE BATTERY. STORE AND TRANSPORT THE BATTERY IN A CASE WHICH PROTECTS IT FROM DAMAGE OR CONTACT WITH SHARP OR METAL OBJECTS WHEN NOT IN USE. BATTERY DAMAGE MAY LEAD TO FIRE OR EXPLOSION. IF THE BATTERY LEAKS, AVOID CONTACT WITH FLUIDS. IN CASE OF EYE CONTACT DO NOT RUB, RINSE WITH CLEAN RUNNING WATER AND SEEK IMMEDIATE MEDICAL ATTENTION. IF THE BATTERY SWELLS, EMITS SMOKE OR GIVES OFF AN ODOR, DISCONNECT IT AND CONTACT A BATTERY RECYCLER FOR DISPOSAL ADVICE. DO NOT THROW USED BATTERIES IN THE TRASH, TURN THEM OVER TO A BATTERY RECYCLING PROGRAM (COLLECTION POINTS ARE FOUND AT MANY HARDWARE STORES AND HOME CENTERS).

 BASIC GUIDE TO THE
LUXE® INTEGRATED AIR SYSTEM

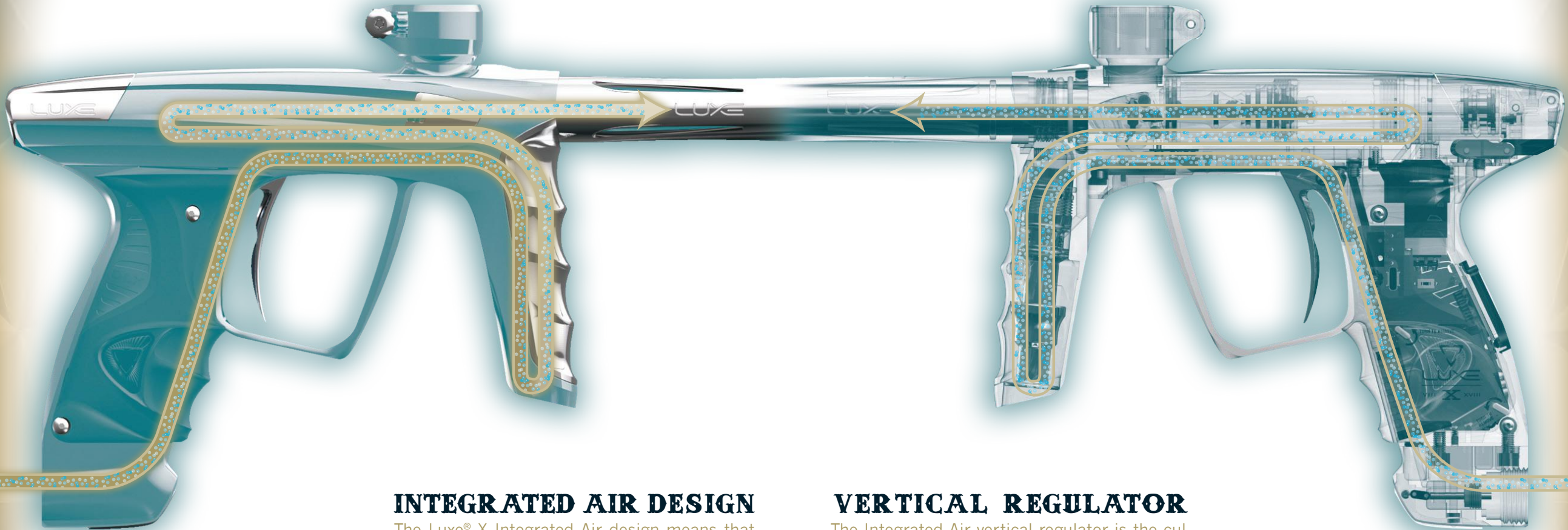

INTEGRATED AIR DESIGN

The Luxe® X Integrated Air design means that there are no hoses on the outside or inside of the marker. Hoses and hose fittings are the most common places for leaks to occur in paintball markers. Air passages machined into the Luxe® grip frame and body eliminate these possible failure points, making the Luxe® X more reliable.



VERTICAL REGULATOR

The Integrated Air vertical regulator is the culmination of more than a decade's worth of design, testing and field experience. It delivers the high flow rates and consistent output pressure that the Luxe® X needs to compete at the professional level. Its unique bi-directional ASA connection allows it to work with the Luxe® X Integrated Air system.



FIG.



AIR 2.1 ABOUT COMPRESSED AIR

YOUR LUXE® IS DESIGNED TO OPERATE ON HIGH-PRESSURE AIR (HPA) which is stored in cylinders (tanks) at pressures of up to 3,000 or 4,500 psi [FIG. 1] The storage cylinder, along with the regulator mounted in its neck forms an HPA system. There are two main types of HPA systems, those on which the regulator's output pressure is adjustable, and those for which their regulator is pre-set to deliver a fixed output pressure. HPA systems designed to screw into an ASA are usually pre-set to provide 400 psi (low pressure output) or 800 psi (high pressure output.) Best performance can be achieved between 450 and 550 psi.

∞ WARNING ∞

DO NOT USE CO₂ WITH YOUR LUXE®. USE THE LUXE® ONLY WITH COMPRESSED AIR SYSTEMS FEATURING TWO BURST DISKS, ONE FOR THE HIGH PRESSURE SIDE OF THE REGULATOR, AND AN 1800 PSI RATED BURST DISK FOR THE DOWNSTREAM SIDE OF THE REGULATOR. THE 1800 PSI (ALSO SOMETIMES MARKED 1.8K) PROVIDES CRITICAL PROTECTION IN CASE OF A REGULATOR LEAK, AND ITS ABSENCE MAY CAUSE DAMAGE TO THE LUXE® AND OR SERIOUS INJURY.

If you are using your Luxe® with an adjustable output compressed air system, it should be set to deliver about 650 psi. The Luxe® vertical regulator can accommodate a wide range of input pressures, and lower them to the marker's operating pressure, so exact adjustment of the air system is not critical, and either low output, or high output pre-set HPA systems may be used. If using a screw-in style air system, the Luxe® on/off bottom-line or similar is recommended, as the on/off control is important for proper set-up and degassing.

∞ WARNING ∞

NEVER USE OIL OR ANY PETROLEUM BASED CLEANER OR LUBRICANT IN A COMPRESSED AIR REGULATOR OR CYLINDER. EXPOSURE TO PRESSURIZED AIR INCREASES OIL'S FLAMMABILITY AND CAN CAUSE A SERIOUS SAFETY HAZARD. ONLY USE MANUFACTURER RECOMMENDED LUBRICANTS WITH COMPRESSED AIR SYSTEMS, AND FOLLOW THE MANUFACTURER'S MAINTENANCE AND OPERATION INSTRUCTIONS EXPLICITLY.

Regardless of the type of air system used, be sure to turn it on by slowly opening its control valve (either on the HPA system, or on/off bottom-line, depending on the configuration) so that the gas pressure in the Luxe® rises gently, rather than jumping to full pressure. Slower pressurization will maximize the service life of the seals and low pressure components in the Luxe®. The Luxe® offers multiple options for mounting compressed air systems. Located on the bottom of the grip frame are a pair of industry standard 10-32 screw holes for air system mounting. Located forward and to the side of these holes is the Luxe® grip integrated gas port. A small o-ring sitting in a recess at the gas port provides an airtight seal.

∞ WARNING ∞

DEGAS AND UNLOAD THE LUXE® BEFORE MAKING ANY AIR SYSTEM CHANGES.

FIG. 3

3



FIG. 4

4



FIG. 5

5



AIR 2.2 INSTALLING AN AIR SYSTEM

WHEN MOUNTING THE BOTTOM-LINE ADAPTER DIRECTLY TO YOUR LUXE® GRIP FRAME, it must first be disassembled by unscrewing and removing its pivot pin with a 1/16-inch allen wrench [FIG. 3]. The charging handle and actuating pin will then be free to slide out the front of the ASA. The actuating pin should be very lightly lubricated with GR33SE™ before it is reinstalled.

The ASA may be removed by first taking out the charging handle and actuating pin then sliding a 5/32-inch allen wrench through each of the access holes in the bottom of the ASA into the heads of the ASA mount screws [FIG.4] and unscrewing them. Once the ASA is free from the grip frame, its mount screws may be slid through the central slot one at a time towards the center hole and lifted out the top.

When installing a new air system, accessory or mount, the grip must be removed and the battery removed from the Luxe® (see **HARDWARE 3.6.**) Only use mounting screws which will reach through the air system, accessory or mount, and fully engage the screw threads in the grip frame, but not extend into the open space of the grip frame far enough that they interfere with the placement of the battery. Installing mount screws while the battery is removed will ensure that a screw which is too long does not accidentally damage the lithium-polymer battery

AIR 2.3 REGULATOR GRIP PANEL

THE REGULATOR GRIP PANEL ON YOUR LUXE® CAN BE REMOVED to service the integrated air regulator or simply to swap it out for another color or style.

Use a 3/8-inch allen wrench to unscrew the integrated air cover lock from the bottom of the foregrip. Once the cover lock is removed, you may then lift out the grip panel by pulling forward from the bottom [FIG. 5]. The top of the grip panel will pivot and then release. When reinstalling the grip panel, seat the alignment pin at its top first, then swing it into position before securing it with the cover lock.



HARDWARE

HOW TO ADJUST ALL MECHANICAL SETTINGS



BASIC GUIDE TO THE LUXE® XL 3-PIECE BARREL SYSTEM

HARDWARE 3.1 LUXE® XL BARREL SYSTEM

EVEN THE BEST QUALITY PAINTBALLS WILL VARY in size from one batch to the next and as weather conditions change. Although your Luxe® can work well even with a poor paint to barrel fit, optimal performance will be achieved with a proper fit. The ideal fit between the paintball and the barrel is found when the ball is inserted in the bore and does not slip or roll through to the muzzle on its own, yet can be blown out like a blowgun, using a minimal amount of breath. The barrel can be adapted to fit a wide range of paintball sizes through the use of Freak® XL inserts. The .687-inch ID Freak® XL bore insert is included with your Luxe® X. Optional Freak® XL inserts may be purchased for use with your Luxe® X. The Freak® XL bore insert may be removed by sliding it out the back of the barrel, and inserting an appropriate sized Freak® XL insert in its place. The Luxe® Freak XL 3-piece barrel is compatible with all Freak® XL multi-piece barrel components, providing access to a variety of optional fronts and inserts.



XL FRONT

FITS ANY **FREAK® XL BACK**, IN ADDITION TO THE LUXE® XL BACK.

Linear pressure compensating ports make every shot quiet and accurate. Freak® XL barrel compatibility lets you switch to optional fronts to keep pace with changing playing conditions.

★ INSERTS ★

AVAILABLE IN 10 COLOR CODED SIZES, FREAK BORE INSERTS
CREATE THE PERFECT FIT WITH ANY BRAND OF PAINT.



XL BACK

ACCEPTS ALL **FREAK® XL FRONTS** AND **FREAK® XL INSERTS**

The Luxe® back accepts optional Freak® XL bore inserts, allowing it to quickly adapt to changing paint conditions.

HARDWARE

HOW TO ADJUST ALL MECHANICAL SETTINGS

FIG. 1



HARDWARE 3.2 ADJUSTING VELOCITY

THE VELOCITY, OR SPEED AT WHICH YOUR LUXE® FIRES a paintball, must be measured and adjusted to below the paintball field's velocity limit immediately before each day of play for player safety. Fill the hopper with paintballs and turn it on.

While wearing ASTM compliant paintball goggles, in an area where all bystanders are protected, remove the barrel blocker and fire over a chronograph to measure the velocity. Using a 5/32-inch allen wrench on the adjuster in the bottom of the Luxe® Vertical Regulator, turn clockwise to increase velocity/pressure [FIG. 1] and counterclockwise to decrease.

∞ WARNING ∞

DO NOT ATTEMPT TO ADJUST THE LUXE® VERTICAL REGULATOR WITH LARGER SIZED ALLEN WRENCHES. THESE ARE USED TO REMOVE AND DISASSEMBLE THE REGULATOR, WHICH MUST NOT BE DONE WHILE IT IS PRESSURIZED.

Take three or four shots after every adjustment to allow the gas pressure inside the Luxe® to stabilize. Adjust and retest until the marker is firing consistently within the limits for the field where you are playing.

∞ WARNING ∞

ALWAYS MEASURE THE VELOCITY OF PAINTBALLS FIRED BY THE LUXE® BEFORE USE, AND NEVER ADJUST TO FIRE ABOVE 300FPS (91.44 M/S.)

FIG. 2

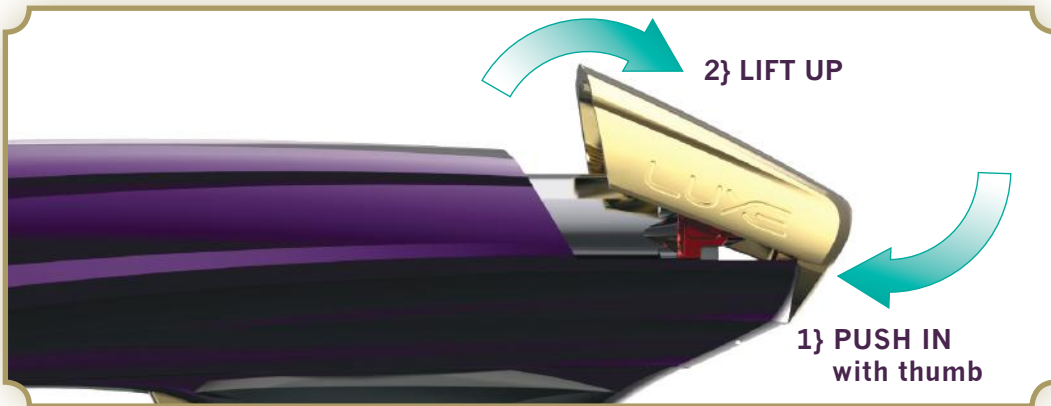

HARDWARE 3.3 DEGASSING THE SYSTEM

BEFORE STORAGE, TRANSPORT OR MAINTENANCE, your marker will need to be unloaded and degassed. In an area where it is safe to shoot and while wearing paintball goggles, loosen the Luxe®'s clamping feedneck and remove the loader. By turning the marker upside down, you can empty any extra paintballs from the feedneck into your hand.

∞ WARNING ∞

EVEN WITH ITS GAS SUPPLY TURNED OFF, THE REGULATOR AND GAS PASSAGES IN THE LUXE® WILL CONTAIN ENOUGH PRESSURE TO FIRE MULTIPLE SHOTS UNTIL THE MARKER IS DEGASSED.

Turn off your HPA system either with its on/off valve, or the on/off valve of a connected bottom-line adapter. Lift the quick-strip latch upward to vent pressure from the Power Core [FIG 2] As the Power Core is depressurized, it will make a sound similar to a soda can being opened. If you hear the sound of escaping gas for more than a second or two, your HPA system has not been turned off. Turn off your HPA system and repeat the degassing procedure.

Once the Luxe® has completely degassed, there will be no more hissing sound. If performing maintenance on the Luxe®, remove the Power Core (see **MAINTENANCE 5.1**) to protect against accidental pressurization—otherwise, re-close the latch. If using a screw-in style HPA system, unscrew the system from the marker's bottom-line ASA. Pay careful attention to make sure the HPA system regulator is unscrewing from the Luxe®'s ASA, rather than the tank unscrewing from its regulator.

∞ WARNING ∞

DO NOT LIFT THE QUICK-STRIP LATCH UNTIL THE GAS SUPPLY HAS BEEN TURNED OFF. IF THIS IS DONE ACCIDENTALLY, TURN OFF THE GAS SUPPLY IMMEDIATELY. THE LUXE® POWER CORE WILL FIRE A LOW-POWER SHOT IF REMOVED BEFORE IT IS FULLY DEGASSED. ATTEMPTING TO CLOSE THE LATCH WHILE THE GAS SUPPLY IS ON MAY RESULT IN O-RING DAMAGE.

HARDWARE

HOW TO ADJUST ALL MECHANICAL SETTINGS

FIG.

3



- 1 POST-TRAVEL
- 2 PRE-TRAVEL
- 3 ACTIVATION POINT
- 4 RESISTANCE

HARDWARE 3.4 ADJUSTING THE TRIGGER

YOUR LUXE® IS EQUIPPED WITH A 4-POINT ADJUSTABLE TRIGGER, providing complete versatility to both the feel and length of the trigger pull [FIG 3] The Luxe® can be adjusted to a super-sensitive hair trigger, though many players find that a slightly longer, and heavier trigger pull is easier to walk to higher rates of fire. Perform trigger adjustments while the Luxe® is unloaded and degassed. Luxe® Training Mode (see **SOFTWARE 4.1**) can be used to determine the effectiveness of changes in trigger adjustment.

POST-TRAVEL The post-travel adjustment sets how far back the trigger can travel, affecting the area of the trigger pull that occurs after the Luxe® fires. Turning the adjustment screw clockwise with a 1/16-inch allen wrench will reduce post-travel, limiting how far back the trigger can swing, while turning counterclockwise will increase it. The post-travel limit must be set to stop the trigger before it is brought to a stop by the trigger switch.

PRE-TRAVEL The pre-travel adjustment determines how far forward the trigger can swing, affecting the area of the trigger pull that occurs before the Luxe® fires. Pre-travel is adjusted with an 1/16-inch allen wrench in the pre-travel adjustment screw. Turn clockwise to reduce pre-travel, and counterclockwise to increase.

ACTIVATION POINT The activation point setting determines the point in the trigger pull at which the Luxe® trigger switch is activated, signaling the marker to fire. As the screw is turned clockwise with a 1/16-inch allen wrench, it will extend out the back of the trigger, closer to the trigger switch, causing the trigger to be activated earlier in the trigger pull. Due to the limited space to access this adjustment, use of a ball-end allen wrench is advised.

∞ WARNING ∞

USE CAUTION WHEN ADJUSTING THE ACTIVATION POINT AND POST-TRAVEL ADJUSTMENT. WHEN PROPERLY ADJUSTED, THE TRIGGER SHOULD COME TO A SOLID STOP AGAINST THE POST TRAVEL ADJUSTMENT SCREW. IF IT COMES TO A SOFTER STOP CAUSED BY THE ACTIVATION POINT ADJUSTMENT SCREW OR REAR OF THE TRIGGER PRESSING AGAINST THE TRIGGER SWITCH, THEN TRIGGER SWITCH AND OR CIRCUIT BOARD DAMAGE MAY RESULT FROM RAPID OR HARD PULLS ON THE TRIGGER.

TRIGGER RESISTANCE Trigger resistance, or the weight of the trigger pull may be adjusted with a 1/16-inch allen wrench in the trigger resistance adjustment screw. Turning clockwise increases pressure on the trigger return magnet, for increased resistance, while turning counterclockwise decreases pressure on the trigger.

HARDWARE

HOW TO ADJUST ALL MECHANICAL SETTINGS

FIG. 1



HARDWARE 3.5 LIPO RECHARGEABLE BATTERY

YOUR LUXE® IS EQUIPPED WITH a Lithium-Polymer (LiPo) battery. Lithium-Polymer batteries provide consistent power output in a minimal size and weight, without suffering from charge memory effects.

Open the rubber grip from the left side your Luxe® and connect the charger to the charging port before plugging the charger into a domestic electrical outlet. The included charger will operate on either 110 or 240 volt standard AC power. The LED on the charger will glow when it is plugged in and receiving power, whether it is charging a Luxe® or not. The Luxe® X is compatible with standard USB and USB-C chargers, allowing it to be charged directly from a portable phone power pack, car USB power source, laptop computer or other USB compliant power supply. The battery may also be removed and charged separately with the optional Luxe® battery charger. It must be fully seated in the grip frame for on-board charging.

Charge Luxe® batteries at least once every six months to maximize their operating life. A spare battery that is unused for more than six months or stored completely empty may lose capacity or fail entirely.

WARNING

ONLY USE GENUINE LUXE® BATTERIES. CRITICAL CHARGE AND DISCHARGE CONTROL CIRCUITS MAY CAUSE DAMAGE AND RISK OF FIRE OR EXPLOSION IF USED WITH OTHER BATTERIES. BATTERIES MAY BE CHARGED EXTERNALLY WITH THE LUXE X BATTERY CHARGER. FOLLOW THE INSTRUCTIONS INCLUDED WITH THE CHARGER.

When your Luxe® is turned on, it will display an estimate of the remaining battery charge [FIG. 1] This will be displayed at the bottom of the marker's OLED display It is important to note that battery discharge rates can be affected by various factors, including temperature. The indicated charge level is only an estimation of the expected remaining charge life.

FIG. 2



BATTERY CHARGE LEVELS

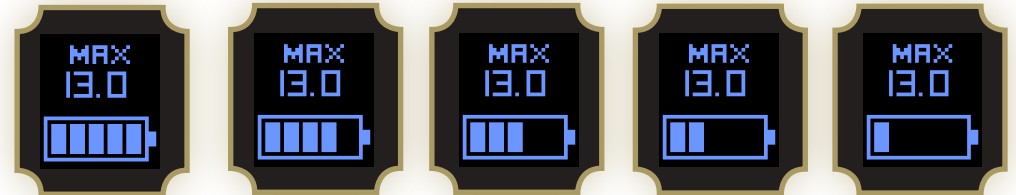

HARDWARE 3.6 REPLACING OR CHARGING THE BATTERY

CHANGING THE LUXE® BATTERY may become necessary to replace a worn out battery, or to swap in a fully charged battery between games to get back out on the field without waiting for a charging cycle to complete.

Unload and degas your Luxe® following the instructions in this manual. The Luxe® battery may be removed to be charged in a Luxe® battery charger or swapped with a freshly charged battery. To remove the battery, open the rubber grip (See **QUICK-START: STEP 1**) and press inward and upward on the front of the battery to release it. Once released the battery will slide forward and can be easily grasped and removed. To reinstall, simply slide the battery back in place, oriented so that its gold plated contacts are on the lower half of the rear edge. [FIG. 2] When pushed all the way back, press slightly downward on the front of the battery so that it catches on the lip at the bottom of the battery slot and is retained in place. Close the rubber grip, making sure that the rubber wedge fits in the gap above the battery, locking the battery in place. [FIG. 3]

FIG. 3



SOFTWARE

ALL ELECTRONIC SETTINGS AND FEATURES



BASIC GUIDE TO THE LUXE® SYSTEM NAVIGATION



— OR —

SLIDE

THE
SWITCH
TO
UNLOCK
PROGRAMMING
MODE



— OR —
SIMPLY
PULL

THE
TRIGGER
WHILE
POWERING
ON



HOLD
THE
POWER
BUTTON



— TO —
EXIT
PROGRAMMING
MODE

— fin. —

SOFTWARE 4.1

INTRODUCTION TO PROGRAMMING

YOUR LUXE® COMBINES VOICE FEEDBACK with its OLED display to make electronic adjustment simple. All adjustments are performed with the Luxe® turned on, but unloaded and degassed (see **HARDWARE 3.3**). Adjustments are made with the trigger and power button when the Luxe® is unlocked. To access the tournament lock switch, pull the rubber grip off of the quick snap grip screws on the left side of the trigger frame. Slide the tournament lock switch towards the barrel to allow access to the trigger programming menu.

Enter the Luxe® programming mode by turning the marker on while holding back the trigger. This will open the Main Menu, which is indicated by voice feedback and tabs which appear at the bottom and sides of the OLED display.

Pull the trigger to scroll through the available settings, each of which is identified by a verbal response and the OLED display. To make a change, find the desired setting and tap the power button. The Luxe® will display the currently selected value for that sub-menu on its OLED display with "SET" appearing on the bottom tab. Additionally it will speak the current value. Changes may be made to the setting by pulling the trigger to cycle through the available values. Once a new setting has been chosen (changed dwell setting, new firing mode, etc.) tapping the power button will return to the main menu, allowing other settings to be checked or changed. Press the power button for approximately 2 seconds to turn off the Luxe® and exit programming mode. When programming is complete, re-secure the grip. When the Luxe® tournament lock is engaged, programming mode is not accessible. The Luxe® can be locked into any tournament or field legal mode required.

SOFTWARE

ALL ELECTRONIC SETTINGS AND FEATURES

SOFTWARE 4.2 NAVIGATING MODES



➤ MAIN MENU ❖

Within the main menu, you may choose which setting you want to check or change. The Main Menu is indicated by tabs appearing on the sides and bottom of the OLED display and the Luxe® verbally announcing that it is in the main menu.

➤ SETTING VALUES ❖

The word "SET" appears on the bottom tab, and the side tabs disappear when a menu item is selected for setting. The joystick controller or trigger may be used to cycle through the available values for each setting.

➤ TOURNAMENT LOCK ❖

Paintball tournaments and field operators require that paintball markers be locked so that their velocity and firing modes cannot be changed on the field. The Luxe® Tournament Lock is turned on by sliding the tournament lock switch to the right, towards the rear of the marker. It is turned off by sliding it towards the barrel. Lock status is indicated by a locked or unlocked padlock in the OLED display. When the Luxe® Tournament Lock is on, holding the trigger back will not access the Main Menu for adjustment. For events which require that adjustments may not be made without the use of a tool, optional grip screws may be used in place of the Luxe® rubber grip posts, securing access to the tournament lock..

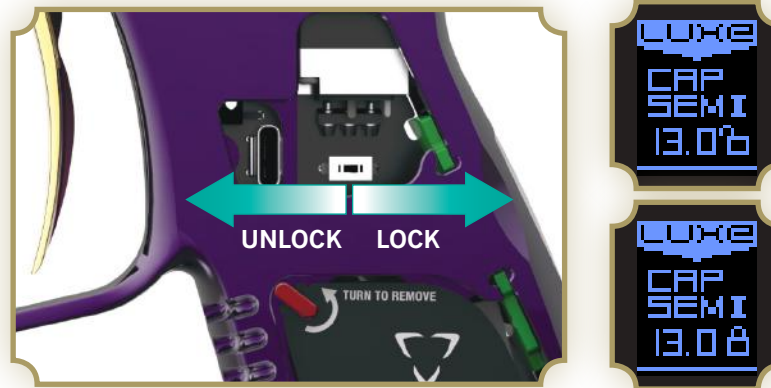

SOFTWARE 4.3

ADDITIONAL POWER BUTTON FUNCTIONS

➤ VISION CONTROL & BREECH STATUS ❖

The Luxe® is equipped with a Vision break-beam anti-chop system. The status of the Vision system is indicated in the OLED display. An empty circle indicates the breech is empty, while a full circle indicates a ball has been detected. "OFF" indicates that Vision has been deactivated, and "FAULT" indicates an error, such as debris blocking the Vision sensor. Vision may be deactivated by a quick double-tap of the power button. It may be turned back on the same way.

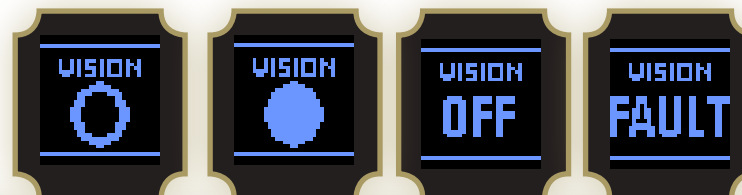

SOFTWARE 4.4 USB INTERFACE

INCLUDED WITH YOUR LUXE® is a USB-C cable, which can be used to read or adjust the marker's settings and re-flash the circuit board with firmware updates, alternate language OLED firmware or alternate voice sets. Download the latest version of the Luxe® USB Interface software, instructions, voice files and firmware at LuxePaintball.com.

❖ WARNING ❖

CONFIRM THAT BOTH THE INTERFACE SOFTWARE AND FIRMWARE FILE VERSIONS ARE COMPATIBLE WITH THE LUXE® X BEFORE UPDATING FIRMWARE OR CHANGING SETTINGS VIA USB. THE LUXE® X MUST BE POWERED OFF TO RE-FLASH ITS SOFTWARE.



SOFTWARE 4.5 FACTORY RESET

PRESSING AND HOLDING THE TRIGGER FOR approximately 5 seconds while in programming mode will result in the Luxe® resetting all menu items to their factory default values. Factory Reset is confirmed by 3 chirps from the speaker.

SOFTWARE

ALL ELECTRONIC SETTINGS AND FEATURES

SOFTWARE 4.6 FIRING MODES AND SETTINGS

⇒ FIRING MODE ⇐

As its name implies, this setting selects one of the Luxe®'s eleven available firing modes, each of which is identified by the Luxe® speaking the mode name and displaying it near the top of the OLED display. Settings which affect the performance of a firing mode are stored specifically for the currently selected mode. Firing mode related settings are only available for adjustment when their associated firing modes are selected. For example, Burst Count may only be adjusted when the firing mode is set to Burst.

⇒ SEMI-AUTO CAPPED ⇐

While this mode functions like Semi-Automatic, with one shot per trigger pull, it also takes into account the value set in the BPS (Balls Per Second) Limit. By activating this cap, the Luxe®'s maximum rate of fire can be restricted to meet the demands of special game rules, or to handicap experienced players against those who are new to the sport.

⇒ SEMI-AUTO UNCAPPED ⇐

This is a traditional semi-automatic firing mode, delivering one shot per complete trigger pull, and it is the factory default setting for the Luxe®. Semi-Automatic mode is uncapped, and the maximum rate of fire that can be achieved in this mode will depend on loader feed rates and Luxe® Dwell settings. Semi-Automatic mode is appropriate for use at most paintball fields and events.

⇒ PSP BURST ⇐

For use in events following PSP rules. Initially this mode acts like Semi-Automatic until three trigger pulls are made in quick succession. At this point PSP mode begins a burst of shots with each trigger pull, as long as the user continues to pull the trigger at least once per second. Once the trigger is allowed to rest for more than a second, the cycle begins again with one shot per trigger pull. The PSP mode can be adjusted with the BPS Limit and BPS Fine settings.

⇒ BURST MODE ⇐

This mode fires a burst of shots when the trigger is pulled and held down. The number of shots in each burst is determined by the Burst setting.

⇒ MILLENNIUM ⇐

Millennium mode complies with the WPBO firing mode requirements. Initially this mode acts like Semi-Automatic. After four trigger pulls in quick succession (200ms or less each), it begins firing repeatedly at the BPS Limit. If there is a delay between trigger pulls of more than 200 milliseconds, this mode reverts to firing one shot per trigger pull. The BPS Limit must be set to 10.5 or lower. Check latest editions of league rules for BPS Limit changes.

⇒ AUTO RESPONSE ⇐

Auto Response is a specialty mode which doubles firepower by firing both when the trigger is pulled and when it is released. Auto Response is affected by the BPS Limit setting.

⇒ NXL ⇐

NXL mode complies with the WPBO firing mode requirements. Initially this mode acts like Semi-Automatic. After four trigger pulls in quick succession (200ms or less each), it begins firing repeatedly at the BPS Limit. If there is a delay between trigger pulls of more than 200 milliseconds, this mode reverts to firing one shot per trigger pull. The BPS Limit must be set to 10.5 or lower. Check latest editions of league rules for BPS Limit changes.

⇒ FULL-AUTO ⇐

In Full-Automatic mode, the Luxe® fires repeatedly, while the trigger is pulled and held. The rate of fire delivered will depend on the value of the BPS Limit setting.

⇒ CUSTOM REBOUND MODE ⇐

User-definable Rebound mode allows the Luxe® to operate with ramping built to meet nearly any imaginable rule set. Rebound mode fires as semi-automatic until the set number of activation shots (Shots To Enter) are fired at a minimum rate (Shots To Sustain) or faster, at which point the Rebound mode kicks in and fires additional shots, maximizing firepower. Once the rate of trigger pulls drops below the Shots To Sustain setting, one shot is fired per trigger pull. To configure Rebound mode, adjust the Shots To Enter and Shots To Sustain settings.

⇒ BPS LIMIT ⇐

This setting adjusts how fast the Luxe® can fire in all modes except Semi-Auto. For modes such as Capped Semi-Auto, this setting limits the maximum rate of fire. For modes which provide automatic shots, like Burst and Full-Auto, it determines the rate of fire. BPS limit is adjusted in whole numbers of Balls Per Second. The value may be set from 4 BPS to 20 BPS. Default BPS and BPS Fine values vary between firing modes.

Due to variances in the timing of both the Luxe® and paintball shot timers, it is recommended that players confirm timing values with a field's shot timer before competition to reduce the chance of a penalty.

⇒ DWELL ⇐

The Dwell setting determines how long the Luxe® sends power to its solenoid valve, which in turn affects how long the bolt remains forward and how much gas is released from the fire chamber to propel each paintball. Dwell is adjustable from 4 to 25 milliseconds in one millisecond increments. The default Dwell value is 16 milliseconds, which provides an excellent balance between gas efficiency, speed and reliable operation.

⇒ FIRST SHOT DROP ⇐

The o-rings in the Luxe® power core may become set in position when resting between shots, causing slightly more friction than is seen during rapid firing. This results in the first shot of a group having decreased velocity, also known as First Shot Drop Off, or FSDO. In order to overcome this friction, the anti-bolt-stick function of the Luxe® firmware will slightly increase the dwell time of the first shot in a group. The increased dwell will compensate for the change in friction, keeping velocity more consistent. The standard value for First Shot Drop is 7 milliseconds, and it may be adjusted between 0 and 25 milliseconds in one millisecond increments. A setting of 0 turns off first shot drop compensation.

⇒ FIRST SHOT DROP TIMER ⇐

This setting adjusts the amount of time which the Luxe® must be at rest between shots before activating the anti-bolt-stick dwell increase. Time is adjustable between 20 and 100 seconds in 20 second increments. The default setting is 20 seconds.

SOFTWARE

ALL ELECTRONIC SETTINGS AND FEATURES

SOFTWARE 4.7 MENU SETTINGS

⇒ BPS FINE ⇐

The rate of fire cap may be fine tuned through adjustment of the BPS Fine setting, which is added to the BPS Limit value. BPS Fine ranges from 0 to 9 and adds tenths of a ball per second to the rate of fire limit. For example, a BPS Limit of 12, combined with a BPS Fine setting of 8 will result in a 12.8 BPS cap to maximize firepower under a 13 BPS tournament limit while still providing a margin of error to reduce the chance of a penalty.

Rebound, Auto Response and Capped Semi modes are limited to 20 BPS. All other modes are limited to 15 BPS, except Semi-Auto, which has no cap.

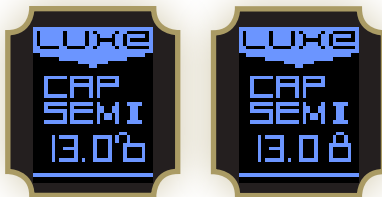

⇒ BYPASS BPS ⇐

Bypass BPS is an additional rate of fire limit that is imposed when the Vision system detects a fault, such as paint or debris that prevents it from working properly. The Bypass BPS setting can be adjusted to ensure that the Luxe® fires slower than its loader's slowest response rate. Bypass BPS is adjustable between 6 and 16 bps, though the Luxe® firmware will not allow it to be adjusted to a value higher than the BPS limit.

⇒ MAINTENANCE COUNTER ⇐

When active, the Maintenance Counter tracks the number of shots fired by the Luxe® and displays the total each time the Luxe® is turned on. Like the odometer in a car, it can be used to as a guide for replacing wear components such as o-rings. The Maintenance Counter tracks bolt cycles detected by the vision system during a firing cycle, and is not increased by "dry firing" without gas in the marker. The Maintenance Counter is reset by turning it off and powering off the Luxe®.

⇒ SPEAKER VOLUME ⇐

The Volume of the Luxe® speaker is adjustable. Volume may be set to 1-silent, 2-quiet, or 3-loud.

⇒ SHOTS TO ENTER ⇐

Shots To Enter determines the number of trigger pulls that must be made at the *Shots To Sustain* rate in order to activate Rebound mode and deliver more than one shot per trigger pull. Shots To Enter may be adjusted from 1 to 5 and has a default value of 3.

⇒ SHOTS TO SUSTAIN ⇐

The trigger must be pulled repeatedly at this rate for the *Shots To Enter* number of times to activate Rebound mode, and must continue to be pulled at this rate to keep Rebound mode active. This setting is adjustable between 2 and 10 balls per second and has a default value of 5 BPS.

⇒ VISION MODE ⇐

The Vision anti-chop system in the Luxe® may be programmed to operate with one of two strategies. Vision® will stop the Luxe from firing if there is not a ball detected in the breach when the trigger is pulled. Forced Shot will still provide Vision operation during normal trigger pulls. If the trigger is held down for a long trigger pull, Forced Shot Vision® will fire even if a paintball is not detected in the breach.

⇒ LOADER DELAY ⇐

The loader delay allows time for the paintball to seat fully in the breach, after the Vision system has detected it, before the Luxe® fires. For forced feed loaders, less time is necessary than with gravity fed loaders. The loader delay is adjustable between 0 and 15 milliseconds with a default setting of 3.

⇒ VOICE SELECT ⇐

As configured from DLX Technology, the Luxe® speaks English, German, Spanish and Russian. Alternatively, different voice sets may be loaded into voice banks 2, 3 and 4 with the Luxe USB interface software and cable (see **SOFTWARE 4.5**). Selecting each voice bank allows its voice set to be used.

⇒ AUTO SHUTDOWN ⇐

The Luxe® will automatically turn itself off to conserve battery power if it is not fired for an extended period of time. The Auto Shutdown Timer is set to 30 minutes by default, and may be adjusted from 5 to 60 minutes.

⇒ TOURNAMENT LOCK ⇐

When turned on, the Tournament Lock blocks access to the Main Menu via the power button and trigger, requiring use of a tool to open the rubber grip and make adjustments (See **4.3 ADDITIONAL POWER BUTTON FEATURES**). The Tournament Lock is off by default. Because the Tournament Lock may be turned on by the trigger and power button, it is convenient to unlock the Luxe® at a paintball field's staging area, close its grip, make adjustments at the chrono station with trigger based programming, and then lock the marker with the Tournament Lock before heading on to the field.

⇒ MECHANICAL DEBOUNCE ⇐

When a paintball marker's trigger is adjusted to an extremely short pull, it is sometimes possible for the vibration of firing to activate the trigger, causing a runaway condition where one shot triggers the next shot. The Mechanical Debounce filtering function of the Luxe® firmware can be set to discriminate against these mechanical bounces, allowing for extremely sensitive trigger adjustment while meeting tournament rule and field safety requirements. Mechanical Debounce is adjustable over a range of 0 (off) to 10, and is off by default.

⇒ TRIGGER DEBOUNCE ⇐

When the Luxe® trigger switch is activated, it will create a series of very fast electrical pulses before a complete connection is made. The Luxe® firmware uses the Trigger Debounce setting to determine the difference between this switch noise and the solid signal from a completed trigger pull. Trigger signals which last longer than the Trigger Debounce value are considered to be a valid trigger pull. The Trigger Debounce value is adjustable between 1 and 25 milliseconds in 1 millisecond increments. The default value is 7 milliseconds.

⇒ SOFTWARE VERSION ⇐

Although this item cannot be adjusted, selecting it to be set will cause the Luxe® to read out the version number of the currently installed Luxe® firmware.

SOFTWARE

ALL ELECTRONIC SETTINGS AND FEATURES

⇨ GAME TIMER ENABLE ⇨

The Luxe® is equipped with a count-down timer. When Game Timer Enable is turned on, the Luxe® switches to an alternate display layout, showing the remaining game time. The game timer begins counting down after a single short press of the power button.

⇨ GAME TIMER ⇨

The Game Timer may be set between 1 and 60 minutes, in 1 minute increments.

⇨ SHOT COUNTER ⇨

When set to on, the Shot Counter will be displayed on the Luxe® OLED display. The counter will reset each time the marker is turned off, and will not be displayed if the Game Timer is enabled.

∞ WARNING ∞

WHILE REFERENCES TO PAINTBALL TOURNAMENT LEAGUE RULES ARE ACCURATE AT THE TIME OF THIS WRITING, IT IS NOT UNCOMMON FOR PAINTBALL LEAGUES TO MAKE CHANGES TO THEIR RULES. IN ADDITION TO THE MODE CHOICE, SOME SERIES WILL REQUIRE THE USE OF THE LUXE®'S BPS LIMIT TO LIMIT MAXIMUM RATE OF FIRE. BE SURE TO MAKE YOURSELF FAMILIAR WITH THE RULES OF ANY TOURNAMENT, SCENARIO OR GAME WHERE YOU WILL BE PLAYING, TO BE CERTAIN YOUR LUXE® SETTINGS ARE IN COMPLIANCE.



SHOT
COUNTER



MAINTENANCE
COUNTER



GAME
TIMER



VISION
OFF



MAINTENANCE

ESSENTIAL STEPS FOR PEAK LUXE® PERFORMANCE



BASIC GUIDE TO THE

LUXE® POWER CORE QUICK-STRIP

THE INNOVATIVE LUXE® POWER CORE CAN BE REMOVED IN SECONDS, NO TOOLS REQUIRED.

MAINTENANCE 5.1 LUXE® POWER CORE

THE HEART OF YOUR LUXE® is the Luxe® Power Core. This single module comprises both the marker's bolt and exhaust valve system. Its compact, tool-free design makes the Luxe® incredibly fast and simple to maintain. The Luxe® should be disassembled and cleaned any time it shows erratic performance, becomes contaminated with paint, dirt or other debris, or for preventative maintenance after 3 or 4 days of use.

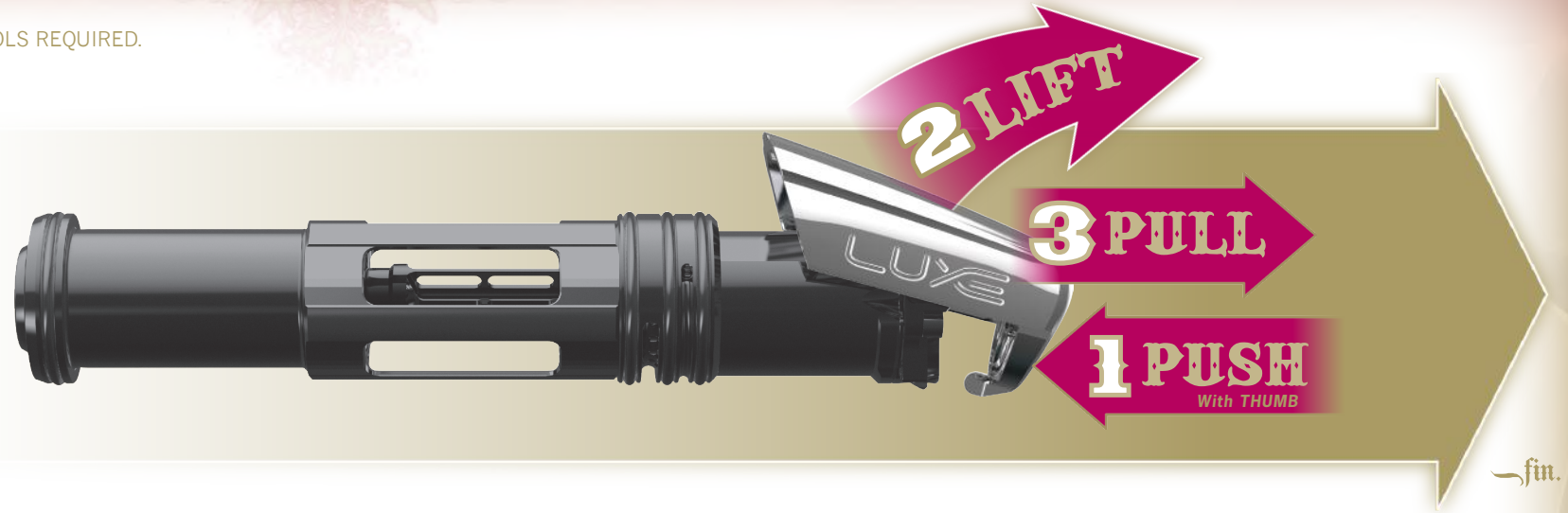

1



STEP ONE UNLOAD AND DEGAS YOUR LUXE®

UNLOAD AND DEGAS YOUR LUXE® (see **HARDWARE 3.3.**) Turn off and or remove the gas supply. Remove the barrel then press in on the bottom-rear of the quick-strip latch, lift its front, and wait for the Luxe® to completely depressurize before, pulling the Power Core out of the Luxe® receiver. If the Power Core has not been removed recently it may need to be wiggled slightly to break o-ring friction.

∞ WARNING ∞

The Luxe® will fire a low-power shot if the Power Core is removed while still under pressure.

2



STEP TWO REMOVE THE BOLT

BEGIN DISASSEMBLING THE LUXE® POWER CORE by unscrewing the core cap from the fire chamber. This will release the bolt which is captive between the two parts.

MAINTENANCE

ESSENTIAL STEPS FOR PEAK LUXE® PERFORMANCE

3



STEP THREE REMOVE THE FIRE CHAMBER AND INTERNALS

ONCE THE BOLT HAS BEEN REMOVED the bolt guide can slide forward out of its seat where friction holds it in the fire chamber. The slender spool assembly may then be slid out the front. Unscrewing the fire chamber from the end cap assembly will provide access to slide out the spool shuttle out of the end cap. It may be necessary to carefully use a pick or other hooked tool to grasp the spool shuttle and pull it out. Take care not to scratch the interior surfaces of the spool shuttle.

4



STEP FOUR CLEAN THE POWER CORE

USING A CLEAN, SOFT CLOTH, wipe dirt, paint debris and old grease from all of the Power Core surfaces. Inspect all o-rings and replace any which show significant signs of wear, or have rips, tears or other damage. The windows milled into the side of the fire chamber allow easy access for inspecting internal o-rings and changing them if necessary. Make sure the gas vents in the sides and front of the fire chamber and bolt are clean and clear.

5



STEP FIVE LUBRICATE THE POWER CORE

LUBRICATE ALL O-RINGS WITH A LIGHT COATING of GR33SE™ marker grease. Take care to ensure that grease is applied to inner o-rings at the front and middle of the fire chamber. Re-assemble the power core in the opposite order of disassembly. Take care to be sure the spool spring remains on its guide in the spool shuttle, and slides into the spool assembly without binding.

6

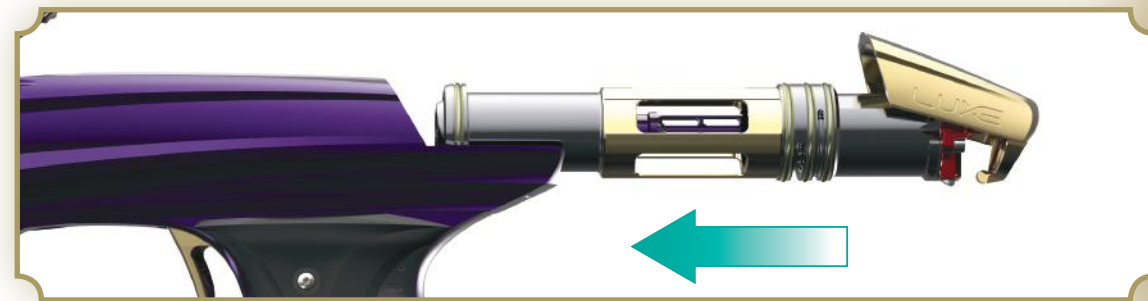

STEP SIX REINSERT THE POWER CORE

Insert the Power Core into the rear of the Luxe® body, with the quick strip latch lifted up. Once the Power Core is in position, close the quick strip latch.

MAINTENANCE

ESSENTIAL STEPS FOR PEAK LUXE® PERFORMANCE

DETENT TOOL-FREE ACCESS FOR
USE IN THE FIELD



BASIC GUIDE TO REMOVING THE LUXE® QUICK-SNAP DETENT ASSEMBLIES

MAINTENANCE 5.2 BALL DETENTS & VISION EYES

THE LUXE® QUICK-SNAP BALL DETENT ASSEMBLIES serve both to prevent double-feeding of paint, and to protect the Vision™ anti-chop eye system. Their unique magnetic and physical latch systems keeps them secure, while allowing for easy tool-free maintenance. There is a ball detent assembly on each side of the marker, and both should be cleaned and inspected in the same manner.



—fin.



STEP ONE PRESS DETENT ASSEMBLY

PRESS ON THE FORWARD POINT OF THE BALL DETENT ASSEMBLY while sliding the Quick-Snap latch forward. This will separate the magnets at the rear, pushing the assembly's back edge out from the Luxe® body.

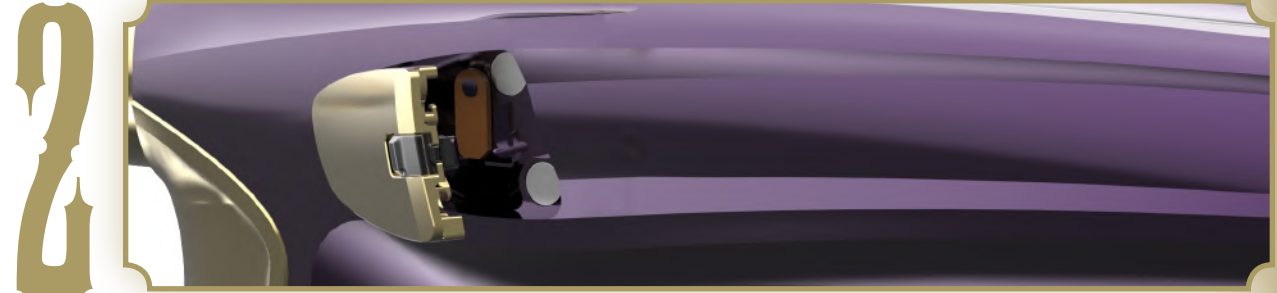

STEP TWO REMOVE DETENT ASSEMBLY

GRASP THE BALL DETENT ASSEMBLY from the rear, and lift outward, away from the Luxe® body.

MAINTENANCE

ESSENTIAL STEPS FOR PEAK LUXE® PERFORMANCE

3



STEP THREE CLEAN VISION™ EYE POCKET

LIFT OUT THE VISION™ EYE from its pocket in the Luxe® body. Using a soft cloth or cotton swab, clean any paint, debris or grease from the passage between the eye pocket and the breech, or from the eye itself. If debris buildup is severe, use a cotton swab dampened with rubbing alcohol for cleaning the Vision™ eye and its pocket and allow them to dry completely before proceeding. Take care not to scratch the Vision™ eye or strain its flex-strip circuit. Gently re-seat the Vision™ eye in its pocket, with its emitter or sensor facing inward.

4



STEP FOUR INSPECT BALL DETENT ARM

CLEAN AND INSPECT THE BALL DETENT ARM in the ball detent assembly. It should move freely when pressed in and released. If the plunger or the Quick-Strip latch tension spring show significant signs of wear or binding, replace them following the instructions in **ADVANCED MAINTENANCE 6.3**.

5



STEP FIVE REINSTALL DETENT

REINSERT THE BALL DETENT ASSEMBLY by hooking its pointed edge into the front side of its pocket in the Luxe® body. Then angle the rear into place, allowing the rare-earth magnets to grip and secure it in place. Make sure that the latch has clicked into the locked position. Test the latch by pressing on the forward point of the detent assembly to make sure it does not pop out.



ADVANCED MAINTENANCE

REPAIR PROCEDURES FOR YOUR LUXE® MARKER



BASIC GUIDE TO LUXE® ADVANCED MAINTENANCE

ADVANCED MAINTENANCE 6.1 INTRODUCTION

UNDER NORMAL CONDITIONS, YOUR LUXE® should only need the basic maintenance procedures performed. This advanced maintenance section is provided to give you additional familiarity with the Luxe®. If you do not feel comfortable with going beyond regular maintenance, see your Authorized Luxe® dealer for support.

MAIN LUXE® MARKER COMPONENTS

- 1 ✱ ✱ BODY
- 2 ✱ ✱ LUXE® 3-PIECE BARREL SYSTEM
- 3 ✱ ✱ CLAMPING FEEDNECK
- 4 ✱ ✱ LUXE® POWER CORE
- 5 ✱ ✱ LUXE® EYE COVERS
- 6 ✱ ✱ UPPER VISION™ CIRCUIT
- 7 ✱ ✱ SOLENOID VALVE & MANIFOLD
- 8 ✱ ✱ GRIP FRAME
- 9 ✱ ✱ TRIGGER
- 10 ✱ ✱ GRIP
- 11 ✱ ✱ VENTING ON/OFF BOTTOM-LINE
- 12 ✱ ✱ REGULATOR GRIP PANEL
- 13 ✱ ✱ PRESSURE CONTROL PISTON
- 14 ✱ ✱ VERTICAL REGULATOR SPRING
- 15 ✱ ✱ VELOCITY ADJUSTER
- 16 ✱ ✱ LOWER VERTICAL REGULATOR HOUSING
- 17 ✱ ✱ COVER LOCK INNER O-RING
- 18 ✱ ✱ COVER LOCK



ADVANCED MAINTENANCE

REPAIR PROCEDURES FOR YOUR LUXE® MARKER

ADVANCED MAINTENANCE 6.2 SERVICING THE VERTICAL REGULATOR

1



STEP ONE REMOVE REGULATOR FROM THE FOREGRIP

WITH THE LUXE® UNLOADED AND DEGASSED, remove the grip panel, following the instructions in section AIR 2.3. Use a 5/16-inch allen wrench to remove the lower regulator housing from the foregrip. The regulator filter may fall out of the receiver, or stay in place, due to adhesion of factory applied lubricant.

⋈ WARNING ⋈

SERVICE AND ADJUSTMENTS TO THE REGULATOR WILL CAUSE CHANGES IN ITS OUTPUT PRESSURE. RE-ADJUST THE REGULATOR FOR THE CORRECT VELOCITY USING A CHRONOGRAPH AS DESCRIBED IN THE MARKER'S MANUAL.

2



STEP TWO PRESSURE CONTROL PISTON

THE PRESSURE CONTROL PISTON and regulator spring may come out with the lower regulator housing. If they do, the pressure control piston may be pulled out of the lower regulator housing by hand.

3



STEP THREE INSPECT SEALS AND REGULATOR HOUSING

AT THIS LEVEL OF DISASSEMBLY, the pressure control piston seal and regulator housings may be inspected, and cleaned with a soft cloth or cotton swab. If the piston seal shows signs of excessive wear or damage, it must be replaced. Lightly lubricate all o-rings with GR33SE™ before reassembly. For normal maintenance this is all that must be done.

ADVANCED MAINTENANCE

REPAIR PROCEDURES FOR YOUR LUXE® MARKER

4



STEP FOUR VELOCITY ADJUSTER

THE VELOCITY ADJUSTER IS left-hand threaded. Using a 5/32-inch allen wrench, turn the velocity adjuster clockwise to unscrew it from the lower regulator housing. Clean, inspect, lubricate and if necessary replace the adjuster's o-rings and filter then reinstall it, turning counter-clockwise.

∞ WARNING ∞

PARTS OF THE LUXE® INTEGRATED AIR VERTICAL REGULATOR USE LEFT-HANDED THREADS. THESE PARTS MUST BE TURNED COUNTER-CLOCKWISE TO SCREW THEM IN AND CLOCKWISE TO UNSCREW THEM—THE OPPOSITE DIRECTION OF NORMAL SCREWS.

5



STEP FIVE OPEN VELOCITY ADJUSTER

TO ACCESS THE REGULATOR SEAT for inspection or replacement, turn counter-clockwise to unscrew the two halves of the velocity adjuster using a 5/32-inch allen wrench in the adjuster and the same size or smaller allen wrench through the vent holes in the top adjuster half to provide leverage.

Note - The two halves of the regulator adjustment screw are adhered together with blue 242 medium-strength Loctite®.

6



STEP SIX REMOVE REGULATOR SEAT

THE REGULATOR SEAT IS HOUSED within the velocity adjuster, and may be pushed out with a smaller allen wrench. A slight ring shaped indentation from the tip of the brass pressure control piston is normal and will not impact regulator performance. Rips, damage, or irregular dents from debris are indicators to that a fresh seating surface is needed. The regulator seat may be replaced, or if in good enough condition, flipped over to use the undamaged opposite side.

7



STEP SEVEN REASSEMBLE REGULATOR

REASSEMBLY IS PERFORMED in the reverse order of disassembly. Use the tip of the brass pressure control piston to press the valve seat into place, as the sharp edges or point on an allen wrench or pick may tear into the sealing surface.

ADVANCED MAINTENANCE

REPAIR PROCEDURES FOR YOUR LUXE® MARKER

FIG. 1

1

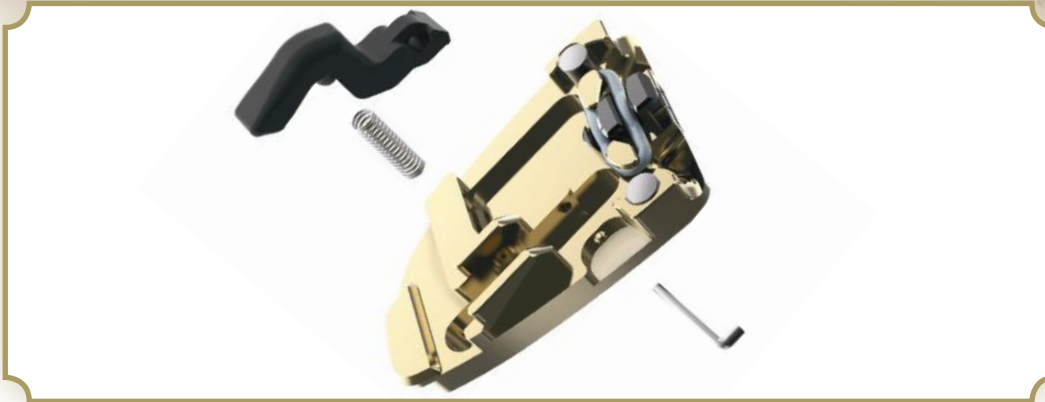

ADVANCED MAINTENANCE 6.3 BALL DETENT ASSEMBLIES

IF THE BALL DETENT OR ITS SPRING are worn and need replacing, this is a relatively simple task. Remove the ball detent assemblies from the Luxe® and lift the detent pin out of its slot with a pick or fine needle nosed pliers [FIG. 1] Take care to keep pressure on the detent while doing so, as it is under spring pressure and may pop free once released. After cleaning and inspection the detent may be reinstalled by placing it over its spring and securing it with the pin.

If the retention latches must be removed, carefully lift off their springs with an o-ring pick. After cleaning, reinstall the latch and stretch its spring over the spring hook on one side first, then the other [FIG. 2]

∞ WARNING ∞

THE BALL DETENTS ARE MADE OF SELF-LUBRICATING MATERIAL. DO NOT USE GREASE, OIL OR OTHER LUBRICANTS ON THEM.

FIG. 2

2



WARNING - Do not disassemble parts 9 and 11 unless necessary to fix a leak

ADVANCED MAINTENANCE

REPAIR PROCEDURES FOR YOUR LUXE® MARKER

FIG. 1

1



FIG. 2

2



FIG. 3

3



ADVANCED MAINTENANCE 6.4 GRIP FRAME REMOVAL

REMOVING THE LUXE® GRIP FRAME IS NOT a part of regular maintenance. It should only need to be performed for a detailed cleaning or if replacing the anti-chop Vision™ eyes or solenoid valve. For ease of maintenance, this task can be performed without the use of tools. After unloading and degassing the Luxe® and removing its power core, lift the grip latch at the rear of the body [FIG. 1]

Slide the front grip frame latch to its rear, unlocked position [FIG. 2]

Slide the grip frame down and away from the body. [FIG. 3]

After re-assembly, the grip frame can be reinstalled with the reverse procedure. Ensure that both latches are in their unlocked positions before sliding the grip frame up into the body. Make sure all electrical contacts and the gas path are free of debris and correctly aligned. If the grip frame does not seat smoothly into place, do not force it. Back it out and check for obstructions.

Once the grip frame is fully seated in place, close both the front and rear latches. Neither should require excessive force. If they do, remove the grip frame and inspect the latch assemblies and their counterpart locations in the body for debris.

ADVANCED MAINTENANCE

REPAIR PROCEDURES FOR YOUR LUXE® MARKER

FIG. 1

1

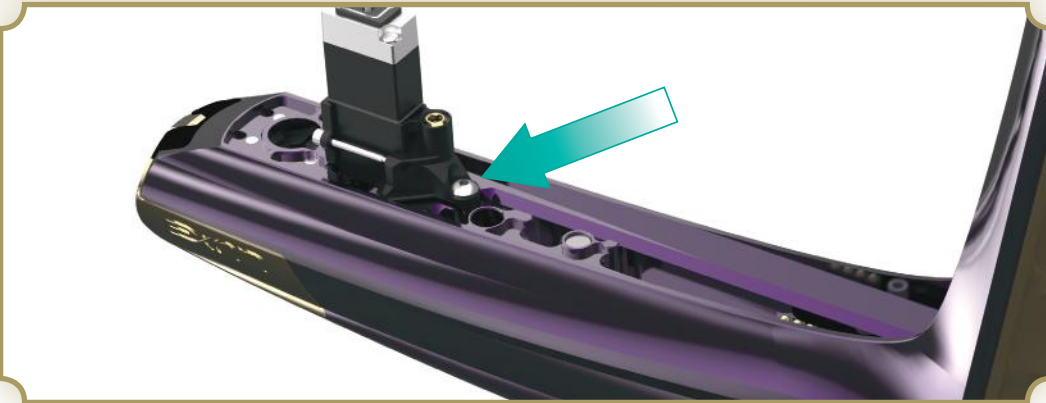

FIG. 2

2

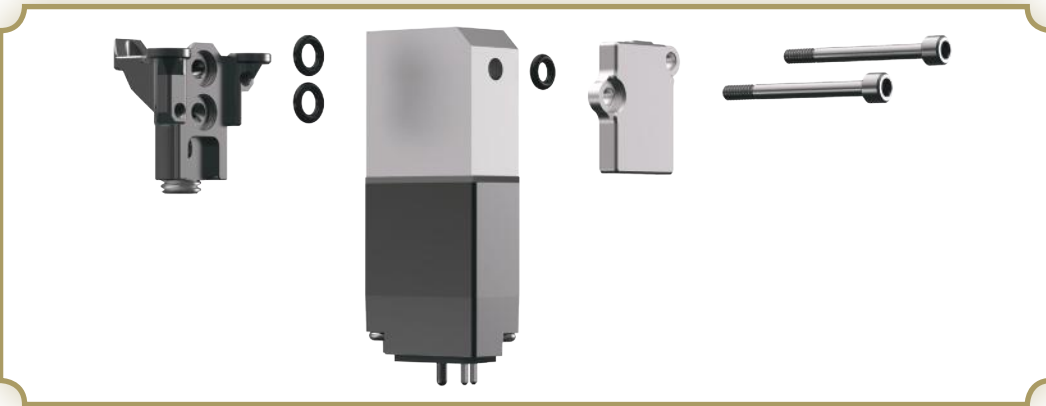
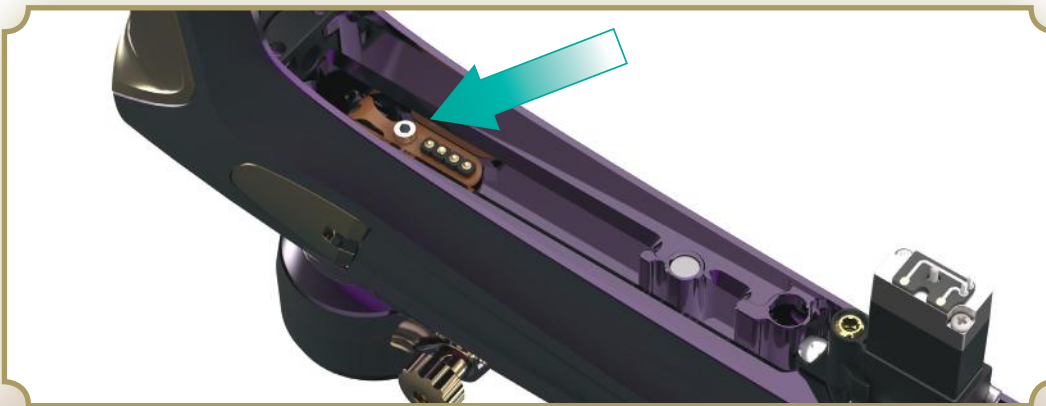

FIG. 3

3



ADVANCED MAINTENANCE 6.5 VISION AND SOLENOID VALVE REMOVAL

WITH THE RECEIVER AND GRIP FRAME APART (see [MAINTENANCE 3.4](#)), the solenoid valve manifold may be removed from the Luxe® by taking out the mount screw at it's front with a 1/16-inch allen wrench [FIG. 1]

Further disassembly of the solenoid valve from its manifold is achieved by removing two screws [FIG. 2]

Note- The Luxe® X solenoid is not user-servicable and should not be disassembled.

On reassembly, inspect exposed o-rings and replace if necessary. A very thin film of GR33SE™ may be used as an assembly lubricant to help the o-rings slide smoothly into their pockets and stay in place while the parts are being handled. Take caution not to leave free gobs of lubricant in or around the o-rings and air passages, as they can gum up the solenoid valve and prevent smooth operation.

The Vision™ emitter and detector may be removed by first lifting out the detent assemblies (see [MAINTENANCE 5.2](#)) then unscrewing the upper Vision™ contact strip screw from the bottom of the body [FIG. 3] and lifting out the Vision™ flex circuit.

ADVANCED MAINTENANCE

REPAIR PROCEDURES FOR YOUR LUXE® MARKER



BASIC GUIDE TO MAINTAINING THE LUXE® SOLENOID

MAIN LUXE® VISION™ AND SOLENOID COMPONENTS

- 1 ✱ ✱ LUXE® EYE COVERS
- 2 ✱ ✱ UPPER VISION™ CIRCUIT
- 3 ✱ ✱ SOLENOID MANIFOLD REAR
- 4 ✱ ✱ SOLENOID VALVE
- 5 ✱ ✱ SOLENOID O-RINGS
- 6 ✱ ✱ LOWER VISION™ SCREW
- 7 ✱ ✱ SOLENOID MANIFOLD FRONT
- 8 ✱ ✱ SOLENOID MANIFOLD SCREWS
- 9 ✱ ✱ SOLENOID MANIFOLD MOUNT SCREW
- 10 ✱ ✱ MANIFOLD O-RING SEALS



ADVANCED MAINTENANCE

REPAIR PROCEDURES FOR YOUR LUXE® MARKER



BASIC GUIDE TO MAINTAINING THE LUXE® POWER CORE

ADVANCED MAINTENANCE 6.6 THE LUXE® ICE ADVANTAGE

THE INTERNAL PARTS OF THE LUXE® POWER CORE ARE COATED with an Internal Ceramic Elastomer - ICE. This innovative finish combines the durability of ceramic, the friction reduction of PTFE and the corrosion resistance of high-phosphor nickel into a cohesive layer of protection. An auto-catalytic reaction fuses this ultra-durable, super-slick compound directly to the power core creating a surface so slippery that the Luxe® ICE can operate reliably even without lubrication. Properly lubricating all seals with GR33SE™ is still the key to a long service life between o-ring replacements, but going dry doesn't mean the game is over.

MAIN LUXE® POWER CORE COMPONENTS

- | | |
|--------------------------------|---------------------------------------|
| 1 ✱ ✱ CORE CAP | 11 ✱ ✱ LIFT END CAP REAR |
| 2 ✱ ✱ BOLT | 12 ✱ ✱ LIFT PIVOT PIN |
| 3 ✱ ✱ BOLT GUIDE | 13 ✱ ✱ LIFT END CAP REAR MOUNT SCREWS |
| 4 ✱ ✱ SPOOL | 14 ✱ ✱ LATCH PIN PIVOT SCREW |
| 5 ✱ ✱ FIRE CHAMBER | 15 ✱ ✱ LATCH PIN |
| 6 ✱ ✱ SPOOL RETURN SPRING | 16 ✱ ✱ TAIL COVER MOUNT SCREW |
| 7 ✱ ✱ SPRING GUIDE | 17 ✱ ✱ LIFT |
| 8 ✱ ✱ SHUTTLE | 18 ✱ ✱ TAIL COVER |
| 9 ✱ ✱ LIFT END CAP FRONT | 19 ✱ ✱ LIFT END CAP BALL SEALS |
| 10 ✱ ✱ LIFT END CAP ORING SEAL | |

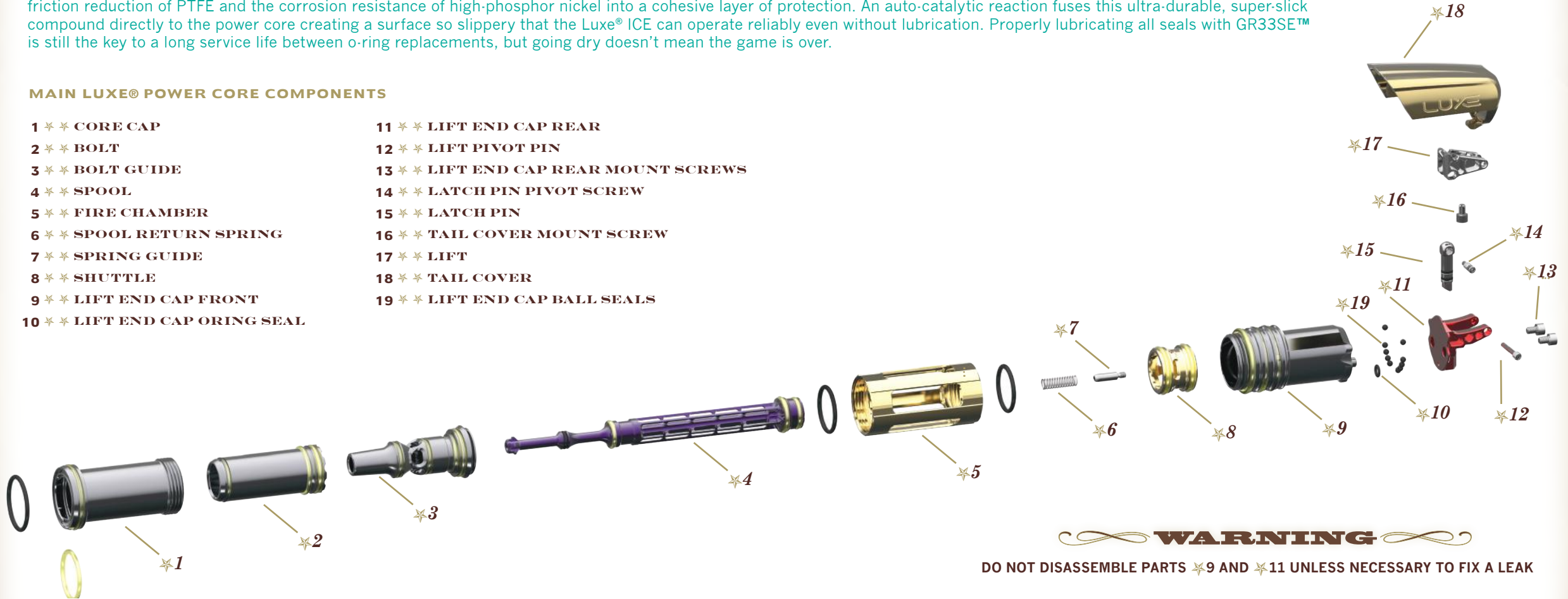

WARNING

DO NOT DISASSEMBLE PARTS ✱9 AND ✱11 UNLESS NECESSARY TO FIX A LEAK

ADVANCED MAINTENANCE

REPAIR PROCEDURES FOR YOUR LUXE® MARKER

FIG. 1

1

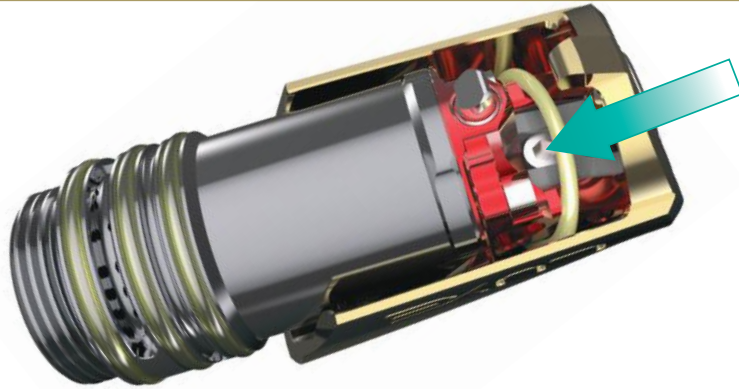

FIG. 2

2



FIG. 3

3



ADVANCED MAINTENANCE 6.7 QUICK-STRIP PLUG DISASSEMBLY

IT MAY OCCASIONALLY BECOME NECESSARY to disassemble the Luxe® Power Core's quick strip plug. First, remove and disassemble the Power Core, following the instructions in **MAINTENANCE 5.1**.

Use a 3/32-inch allen wrench to remove the quick-strip latch screw [FIG. 1] from underneath the rear of the quick-strip plug, then lift the latch away [FIG. 2]

The latch return o-ring does not act as a seal. Instead, it performs the function of a spring, returning the quick-strip latch to its closed position. Stretch and remove the o-ring [FIG. 3]

ADVANCED MAINTENANCE

REPAIR PROCEDURES FOR YOUR LUXE® MARKER

FIG. 4

4



FIG. 5

5

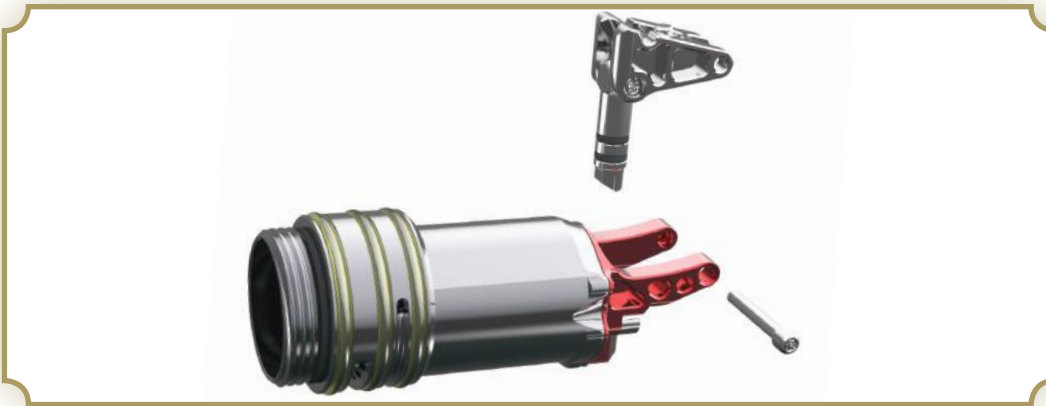

Using a 1/16-inch allen wrench, remove the Quick Strip pivot pin [FIG. 4] With the pin removed, the latch can be lifted upward, exposing the degassing valve core and its black o-rings [FIG. 5] If the quick-strip latch was opened while the Luxe® was still connected to a gas supply and has developed a leak, these are the o-rings likely to have been damaged. To replace, simply remove them with an o-ring pick and slide new o-rings into place, lubricating them lightly with GR33SE™.

The degassing valve core pin also serves as the locking pin which secures the Power Core in the Luxe® body. Inspect the lower end of the degassing valve core pin for signs of wear or bending, its edges should be square and undamaged.

Reassembly of the Power Core is performed in reverse of disassembly. Lower the cleaned and GR33SE™ lubricated degassing valve core into place, and align the rear of the quick-strip latch. Apply a small amount of Blue Loctite® 242 or equivalent threadlocker (if unavailable, clear nail polish may substitute) on the threads of the latch cover screw and pivot pin. Slide the quick-strip latch pivot pin into place and screw it in, taking care not to over-tighten. Use an o-ring pick to stretch the latch return o-ring up into its groove in the Quick Strip latch. Set the latch cover in place and secure it with its screw. Next, re-assemble the Power Core.

ADVANCED
MAINTENANCE
REPAIR PROCEDURES FOR YOUR LUXE® MARKER

ADVANCED MAINTENANCE 6.8 ASA DISASSEMBLY

FIG. 1

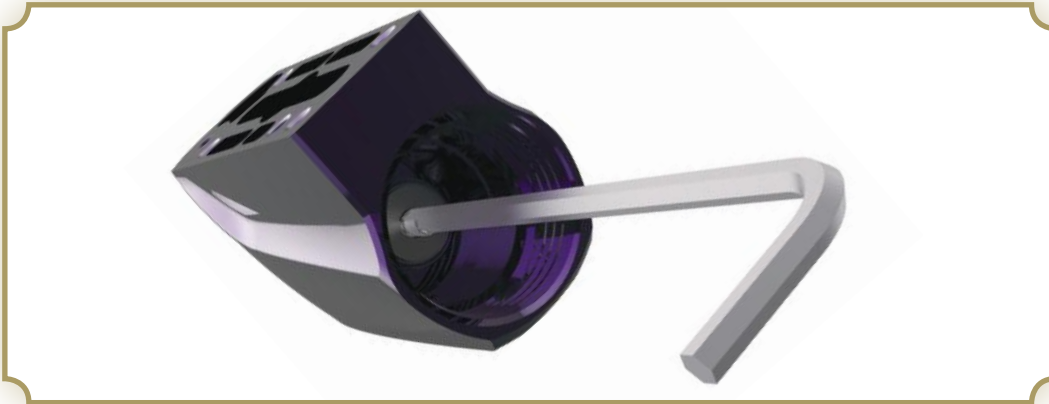

FIG. 2



AFTER REMOVING THE ASA'S CHARGING HANDLE and actuating pin (See AIR 2.2) the ASA nut may be removed from the ASA with a 7/64-inch allen wrench [FIG. 1] The actuating pin o-ring is captured in the front face of the nut [FIG. 2] and may be inspected for nicks or tears. If damaged, it should be replaced. Lubricate the o-ring lightly with GR33SE™ before reassembly.

ADVANCED MAINTENANCE 6.9 TRIGGER REMOVAL

FIG. 1



FIG. 2



TO REMOVE THE TRIGGER FROM THE LUXE® first remove the grip frame from the marker (See ADVANCED MAINTENANCE 6.4) then use an 1/16-inch allen wrench to remove the trigger pivot pin [FIG. 1] With the pin removed, the trigger can slide free of the grip frame [FIG. 2] When reinstalling the trigger, do not lubricate the o-ring on the pivot pin. This o-ring provides friction to keep the pin from working loose.

ADVANCED MAINTENANCE

REPAIR PROCEDURES FOR YOUR LUXE® MARKER

ADVANCED MAINTENANCE 6.10 SPEAKER REMOVAL

FIG. 1



FIG. 2



THE SPEAKER MAY BE EXPOSED by removing the rubber grip, twisting the two red speaker cover clips to release the speaker cover [FIG. 1] and lifting out the speaker cover. The speaker may then be removed for cleaning or replacement [FIG. 2] Reassembly is the reverse of removal.

ADVANCED MAINTENANCE 6.11 CIRCUIT BOARD REMOVAL

FIG. 1



FIG. 2



TO REMOVE THE CIRCUIT BOARD FOR CLEANING or replacement, the grip frame must first be removed from the body (see **ADVANCED MAINTENANCE 6.4**) and the battery must be removed from the grip frame (see **HARDWARE 3.6**). Gently unplug the lower Vison™ flex strip from the circuit board [FIG. 1] Next twist the red circuit board clips and remove the circuit board [FIG. 2] When re-assembling, take care to align the circuit board and OLED display connectors carefully to avoid bending connector pins. Although it is possible to remove and install the main circuit board with the battery in place and grip on the marker, this is not recommended, as damage to spring loaded connector pins may result.

ADVANCED MAINTENANCE

REPAIR PROCEDURES FOR YOUR LUXE® MARKER

ADVANCED MAINTENANCE 6.12 TROUBLESHOOTING

FIG. 1

1

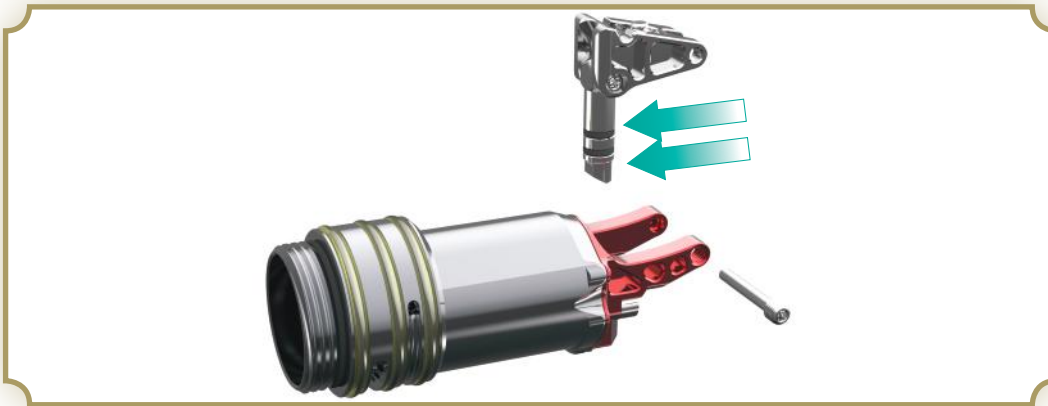

FIG. 2

2



FOR MORE IN-DEPTH TROUBLESHOOTING AND REPAIR TIPS, VISIT LUXEPAINTBALL.COM.

PROBLEM

AFTER ACCIDENTALLY CLOSING THE QUICK-STRIP LATCH, WHILE THE MARKER'S HPA SYSTEM WAS TURNED ON, THE LUXE® HAS A SLOW, CONTINUOUS LEAK.

SOLUTION

✧ Disassemble the Quick Strip Plug [FIG. 1] following the instructions in this manual, and replace the damaged degassing core o-rings

PROBLEM

LUXE® WILL NOT TURN ON WHEN POWER BUTTON IS DOUBLE-PRESSED.

SOLUTION

✧ Recharge the Luxe® battery [FIG. 2] following the instructions in this manual (see **HARDWARE 3.6.**)
✧ ✧ Following the battery replacement instructions (see **HARDWARE 3.6.**) ensure that the battery is installed and connected securely to the Luxe® circuit board.

PROBLEM

FIRST SHOT FIRED HAS LOW VELOCITY BUT STABILIZES WITH FOLLOWING SHOTS (FIRST SHOT DROP-OFF.)

SOLUTION

✧ Clean, inspect and lubricate the Luxe® Power Core and bolt spring (see **MAINTENANCE 5.1.**)
✧ ✧ Increase FSD Compensation setting (see **SOFTWARE 4.6**)

PROBLEM

LUXE® WILL TURN ON AND MAKES PUFFING SOUND WHEN TRIGGER PULLED BUT WILL NOT FIRE.

SOLUTION

✧ Make sure that the Dwell setting is set to the default value or higher (see **SOFTWARE 4.6.**)
✧ ✧ Clean the Power Core, and replace and lubricate the fire chamber's inner o-rings. (see **MAINTENANCE 5.1.**)

PROBLEM

VELOCITY DROPS OFF DURING RAPID FIRE.

SOLUTION

✧ Clean, inspect and lubricate the Luxe® Power Core (see **MAINTENANCE 5.1.**)

ADVANCED MAINTENANCE

REPAIR PROCEDURES FOR YOUR LUXE® MARKER

ADVANCED MAINTENANCE 6.13 LIMITED WARRANTY

WARRANTY SUPPORT AND SERVICE FOR DLX TECHNOLOGY GROUP PRODUCTS IS PROVIDED BY FACTORY TRAINED SERVICE TECHNICIANS AT LUXE® AUTHORIZED DEALERS.

DLX TECHNOLOGY GROUP WARRANTS FOR ONE (1) YEAR TO INITIAL RETAIL PURCHASER THAT THE PAINTBALL MARKER AND REGULATOR COMPONENTS ARE FREE FROM DEFECTS IN MATERIALS AND WORKMANSHIP. THE VALVE ASSEMBLY AND SOLENOID ARE WARRANTED FOR SIX (6) MONTHS. DISPOSABLE PARTS (BATTERIES, O-RINGS, SEALS, ETC.) ARE NOT WARRANTED. ELECTRONIC COMPONENTS ARE WARRANTED FOR SIX MONTHS WITHOUT THE INCLUSION OF INSTALLATION AND LABOR CHARGES.

THIS WARRANTY DOES NOT COVER SURFACE DAMAGES (SCRATCHES AND NICKS), MISUSE, IMPROPER DISASSEMBLY AND RE-ASSEMBLY, ATTEMPTS MADE TO DRILL HOLES OR REMOVE METAL FROM THE EXTERNAL SURFACES WHICH COULD DEGRADE PERFORMANCE AND REDUCE PRESSURE SAFETY FACTORS OF THE MARKER. DO NOT MAKE CHANGES TO THE BASIC MARKER PARTS WITHOUT WRITTEN APPROVAL. THE ONLY AUTHORIZED LUBRICANT FOR THE MARKER IS GR33SE™ LUBRICANT. USE OF ANY OTHER LUBRICANT COULD RESULT IN VOIDING YOUR WARRANTY. PAINTBALL MARKERS ARE NON-REFUNDABLE.

THIS WARRANTY IS LIMITED TO REPAIR OR REPLACEMENT OF DEFECTIVE PARTS WITH THE CUSTOMER RESPONSIBLE FOR TRANSPORTING THE PRODUCT TO AND FROM THE LUXE® AUTHORIZED DEALER. THIS WARRANTY IS EFFECTIVE ONLY IF THE CUSTOMER REGISTERS THE MARKER AT LUXEPAINTBALL.COM. THE WARRANTY IS NON-TRANSFERABLE. DO NOT ATTEMPT TO ALTER THE TRIGGER ASSEMBLY IN ANY WAY, AS THIS WILL VOID YOUR DLX TECHNOLOGY GROUP WARRANTY. TRIGGER ALTERATION OF ANY KIND MAY RESULT IN SERIOUS INJURY.





- ✧ TREAT EVERY PAINTBALL MARKER AS IF IT WERE LOADED. ✧
- ✧ NEVER LOOK DOWN THE BARREL OF A PAINTBALL MARKER. ✧
- ✧ KEEP THE LUXE® MARKER ON SAFE (POWER OFF) UNTIL READY TO SHOOT. ✧
- ✧ KEEP YOUR FINGER OFF THE TRIGGER UNTIL READY TO SHOOT. ✧
- ✧ NEVER POINT THE LUXE® MARKER AT ANYTHING YOU DON'T WISH TO SHOOT. ✧
- ✧ DO NOT SHOOT FRAGILE OBJECTS SUCH AS WINDOWS. ✧
- ✧ KEEP THE BARREL BLOCKING DEVICE ON THE LUXE® MARKER'S MUZZLE WHEN NOT SHOOTING. ✧
- ✧ ALWAYS REMOVE PAINTBALLS AND DEGAS THE LUXE® MARKER BEFORE DISASSEMBLY. ✧
- ✧ STORE AND TRANSPORT THE LUXE® MARKER UNLOADED AND DEGASSED IN A SECURE PLACE. ✧
- ✧ FOLLOW ALL MANUFACTURER'S WARNINGS AND INSTRUCTIONS FOR PROPELLANT ✧
SOURCE HANDLING, STORAGE, AND FILLING.

PREMIUM ELECTROPNEUMATIC MARKER

LUXE® MARKER IS COVERED BY ONE OR MORE OF THE FOLLOWING U.S. PATENTS: 5,881,707;
5,967,133; 6,035,843; 6,474,326; 6,637,421; 7,100,593.
OTHER PATENTS PENDING. FOREIGN PATENTS GRANTED AND PENDING.
©2016 DLX TECHNOLOGY GROUP. ALL RIGHTS RESERVED.

**THE PRECAUTION LIST AND OPERATOR'S MANUAL
MUST ALWAYS ACCOMPANY THE PRODUCT IN THE EVENT OF RESALE OR
NEW OWNERSHIP.**

✧ **LUXE X EDITION** ✧ REV 1.0

WHILE EVERY EFFORT HAS BEEN MADE TO ENSURE THAT THE INFORMATION CONTAINED IN THIS GUIDE IS ACCURATE AND COMPLETE, NO LIABILITY CAN BE ACCEPTED FOR ERRORS OR OMISSIONS. DLX TECHNOLOGY GROUP RESERVES THE RIGHT TO CHANGE THE SPECIFICATIONS OF THE LUXE® MARKER AT ANY TIME WITHOUT PRIOR NOTICE. THE LATEST VERSION OF THIS MANUAL MAY BE DOWNLOADED FREE OF CHARGE AT LUXEPAINTBALL.COM.