

## AMCO PARK LAMP, POST AND BASE



MODEL NO.

**D - 417 - B**

**D - 418 - B**



MODEL NO.

**D - 417 - C**



MODEL NO.

**D - 418 - P4 - 15**

**D - 417 - P4 - 15**

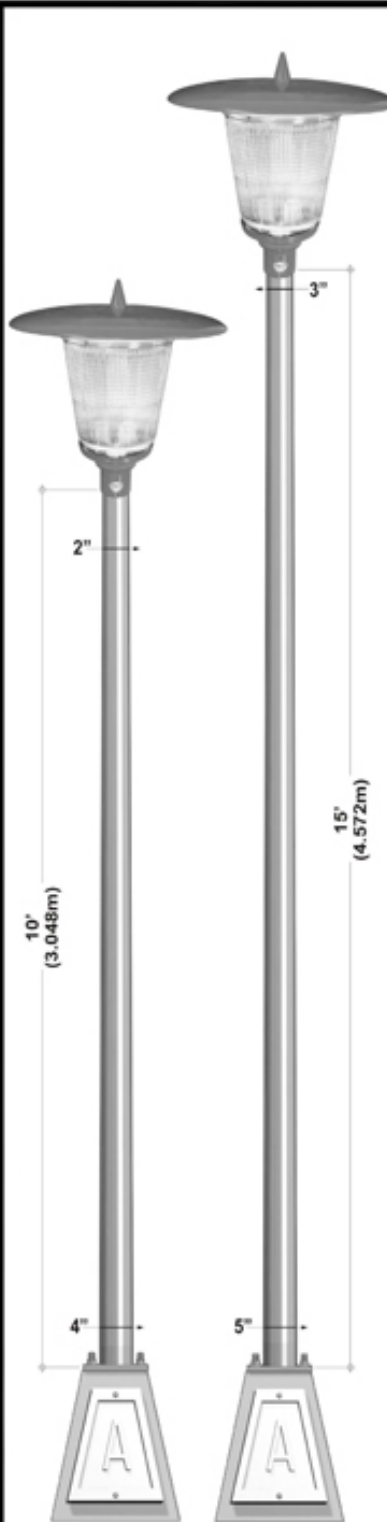

MODEL NO.

**D - 418 - PT - 10**

**D - 417 - PT - 15**

### DETAILS:

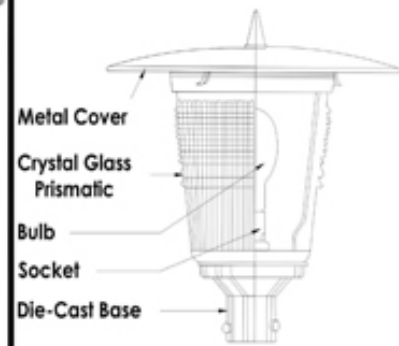

MAX. 250W

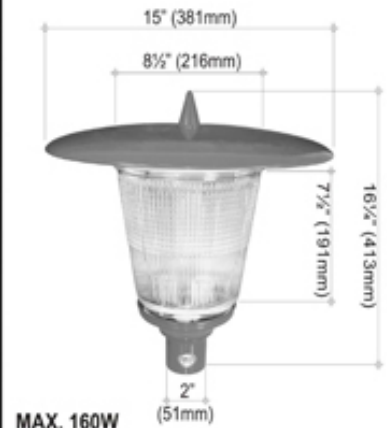

MODEL NO.

**D - 418 - C**



MODEL NO.

**D - 418 - P5 - 15**

**D - 417 - P5 - 15**

## AMCO GARDEN AND PARK LAMP

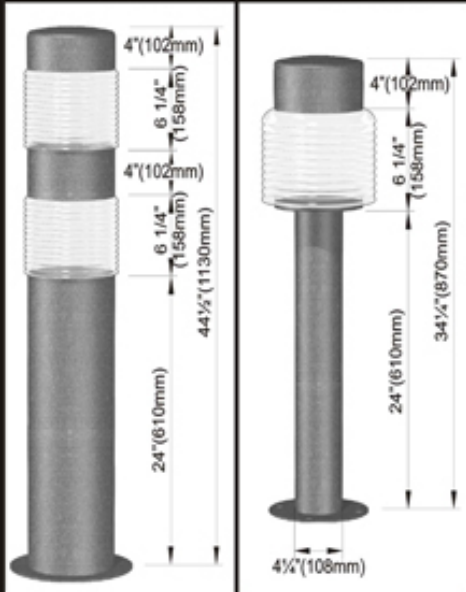

MODEL NO.	MODEL NO.
<b>C-21-BD</b> 8"Ø	<b>C-22-B</b> 8"Ø
<b>C-21-MD</b> 6 1/4"Ø	<b>C-22-M</b> 6 1/4"Ø
<b>C-21-SD</b> 5 1/2"Ø	<b>C-22-S</b> 5 1/2"Ø

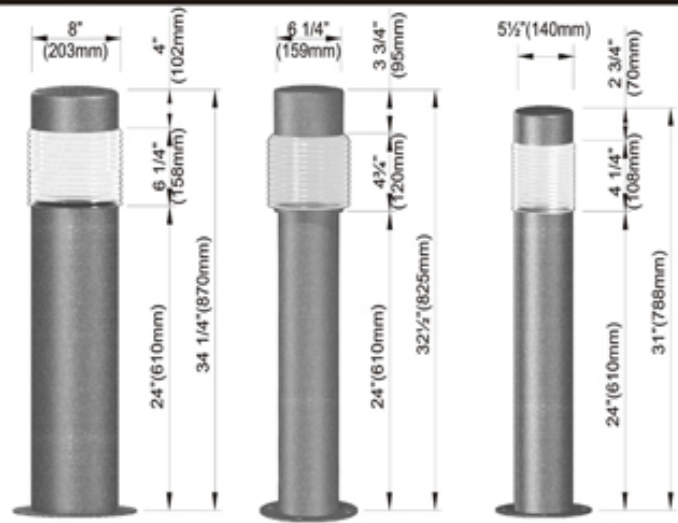

MODEL NO.	MODEL NO.	MODEL NO.
<b>C-21-B</b>	<b>C-21-M</b>	<b>C-21-S</b>

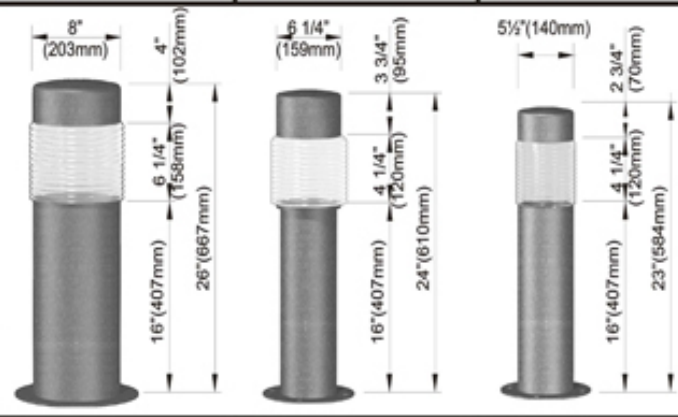

MODEL NO.	MODEL NO.	MODEL NO.
<b>C-21-BB</b>	<b>C-21-MM</b>	<b>C-21-SS</b>

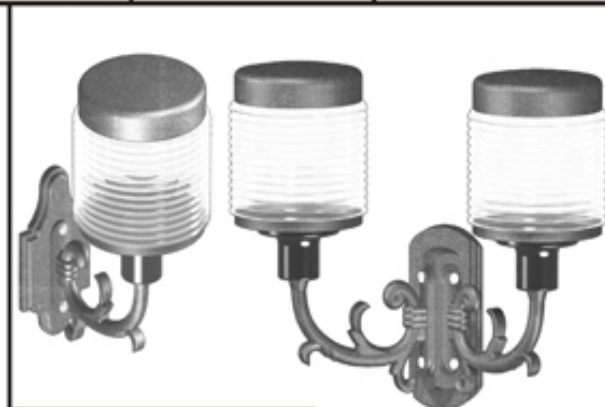
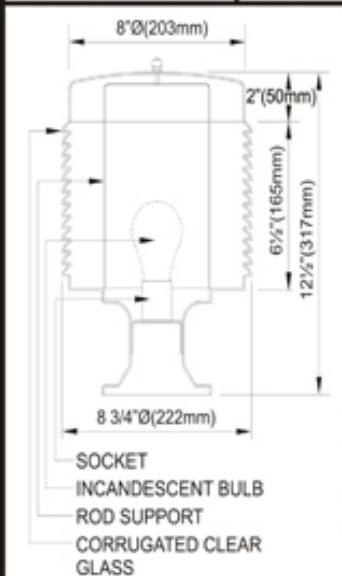

MODEL NO.	MODEL NO.
<b>C-22-GB-1A</b> 8"Ø	<b>C-22-GM-2A</b> 6 1/4"Ø
<b>C-22-GM-1A</b> 6 1/4"Ø	<b>C-22-GS-2A</b> 5 1/2"Ø
<b>C-22-GS-1A</b> 5 1/2"Ø	

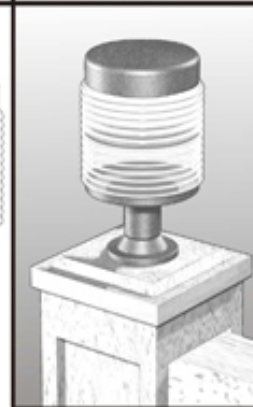

MODEL NO.
<b>C-22-GB</b> 8"Ø
<b>C-22-GM</b> 6 1/4"Ø
<b>C-22-GS</b> 5 1/2"Ø

**AMCO GARDEN AND PARK LAMP**  
COLOR: GRASS GREEN

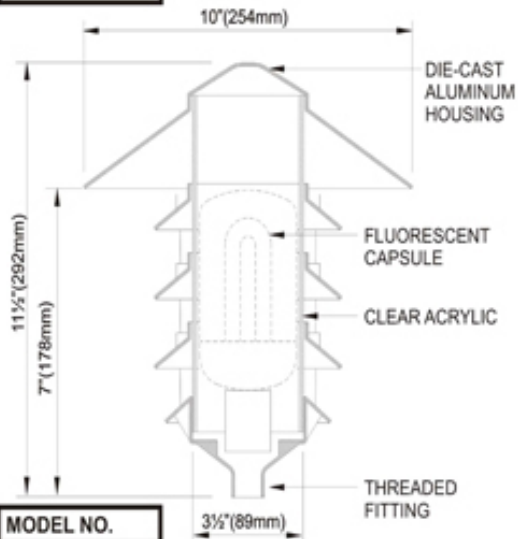
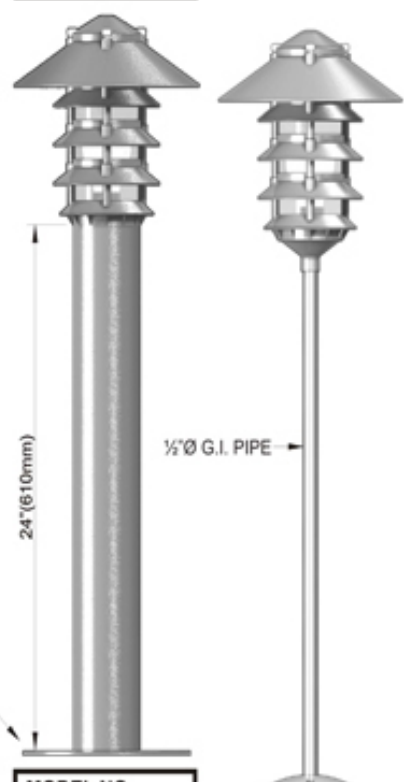
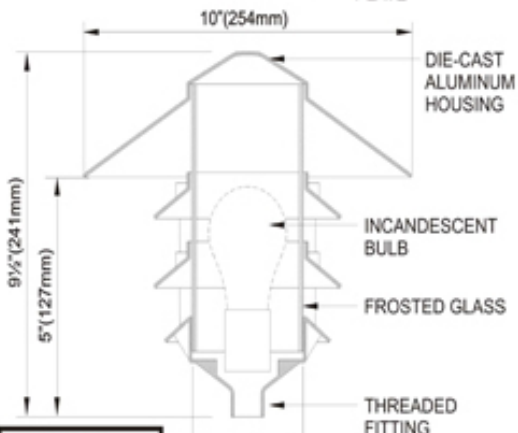
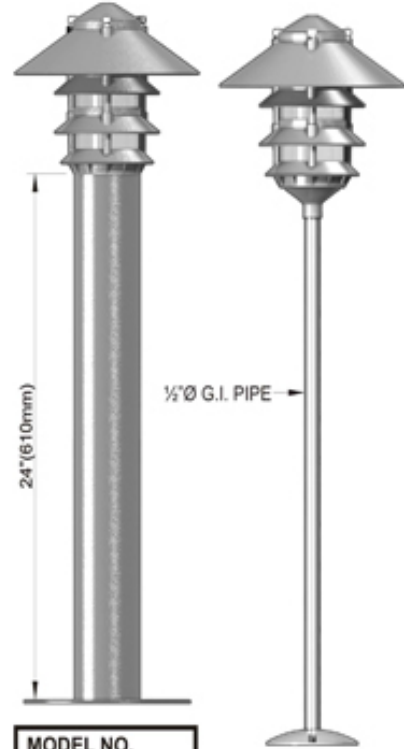
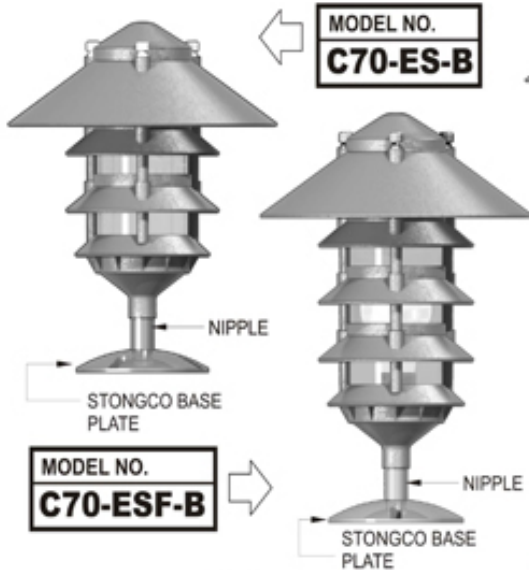

SAMPLE No. 1

SAMPLE No. 2

**AMCO GARDEN AND PARK LAMP**  
COLOR: GRASS GREEN

<p>DIE-CAST ALUMINUM BODY INCANDESCENT BULB (MAX. 100W) FROSTED GLASS</p> <p>5" (127 mm) 9 1/4" (235 mm) 3 1/2" (89 mm)</p>	<p>STONGCO BASE PLATE NIPPLE</p>	<p>12" (305 mm) SPIKE</p>	
<p>MODEL NO. <b>C70-MS</b></p>	<p>MODEL NO. <b>C70-MS-B</b></p>	<p>MODEL NO. <b>C70-MS-S</b></p>	
<p>FLUORESCENT CAPSULE ACRYLIC PIPE TREAD</p> <p>6" (152 mm) 11 1/2" (292 mm) 3 1/2" (89 mm)</p>	<p>STONGCO BASE PLATE NIPPLE</p>	<p>12" (305 mm) SPIKE</p>	
<p>MODEL NO. <b>C70-MSF</b></p>	<p>MODEL NO. <b>C70-MSF-B</b></p>	<p>MODEL NO. <b>C70-MSF-S</b></p>	
<p>1/2" O.D. G.I. PIPE</p> <p>SAMPLE NO. 1</p>	<p>1/2" O.D. G.I. PIPE</p> <p>SAMPLE NO. 2</p>	<p>24" (610 mm) 3 1/2" (89 mm) 9" (229 mm) 24" (610 mm)</p> <p>MODEL NO. <b>C70-MS-P</b></p> <p>MODEL NO. <b>C70-MSF-P</b></p>	

## AMCO GARDEN LAMP

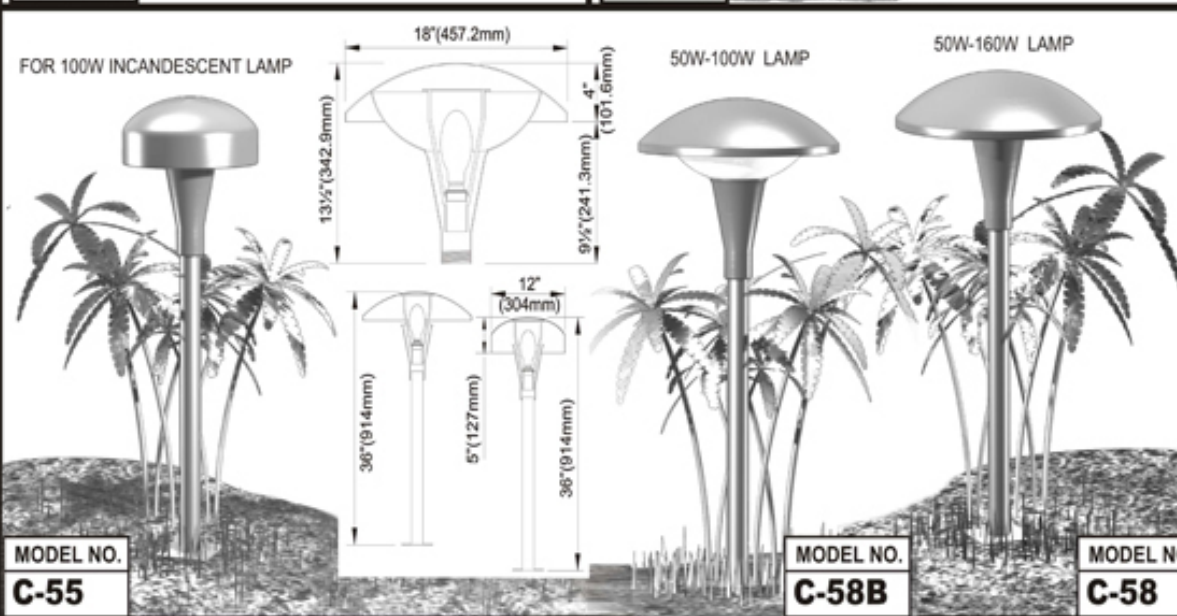
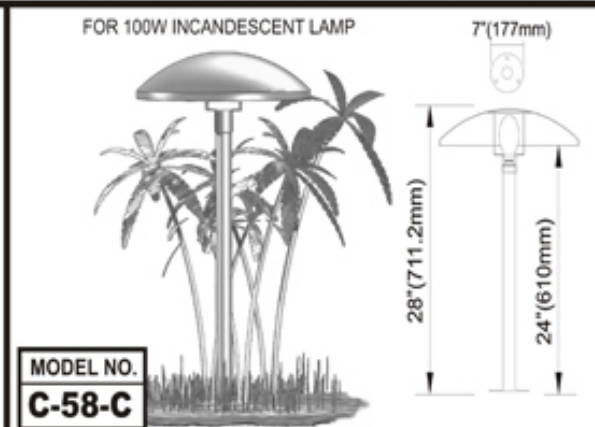
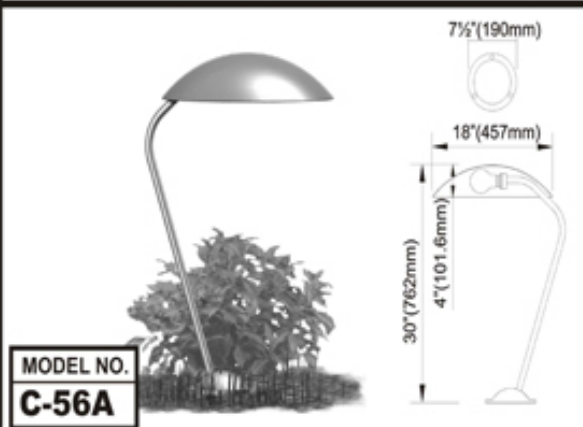
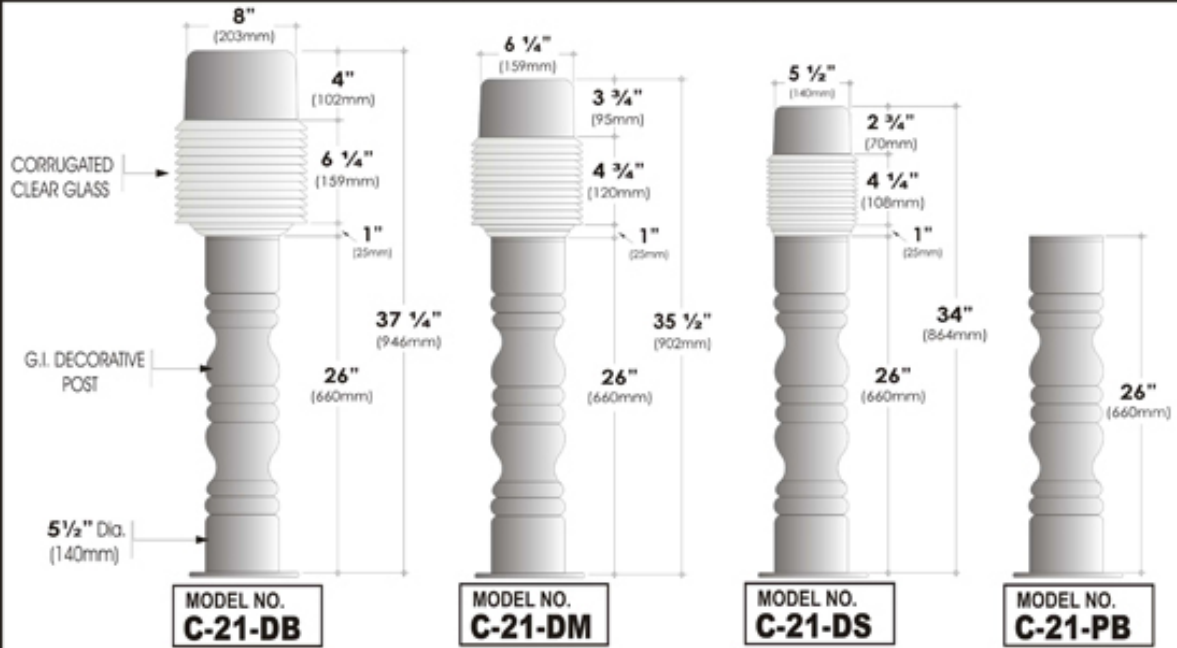

## AMCO GARDEN AND PARK LAMP

