



VERSATILITY

Rules and Regulations

2024

FOREWORD

The National Walking Horse Association (NWHHA) is a non-profit organization formed to do the following:

To promote and increase public awareness of the true and inherent abilities of the Walking Horse

- To provide an equitable horse show affiliation program for Walking Horses, Spotted Saddle Horses and Racking Horses to be exhibited, judged, and showcased in full compliance with the Horse Protection Act.

The NWHHA will accomplish these goals through:

- Rules that are enforced fairly and consistently.
- A judges program that trains judges to place horses in compliance with the Rule Book.
- A designated qualified person (DQP) program with thorough and fair inspections.

The term Rules, when used herein, are the Rules of the National Walking Horse Association unless otherwise stated.

These Rules may be changed and amended from time to time by the National Walking Horse Association.

© 2023 National Walking Horse Association. Any use of the National Walking Horse Association Rules and Regulations or Versatility Rule Books, in whole or in part, is strictly prohibited unless used at National Walking Horse Association affiliated or sanctioned events. Permission to use materials may be requested.

NATIONAL WALKING HORSE ASSOCIATION

P.O. Box 12430

Reading, PA 19612

859-252-NWHA (6942)

Visit our Web Site at: www.nwha.com

1 Table of Contents

| | |
|---|----------|
| 1 VERSATILITY | 1 |
| 1.1 General | 1 |
| 1.1.1 Horse/Rider Combinations | 1 |
| 1.1.2 Courses and Patterns | 1 |
| 1.1.3 Division of Classes | 1 |
| 1.2 Versatility Classes | 2 |
| 2 COMPETITIVE TRAIL RIDING | 2 |
| 3 DRESSAGE | 2 |
| 3.2 Tests | 2 |
| 3.2.1 Qualifying Gaits | 2 |
| 3.2.1.1 Medium Walk | 2 |
| 3.2.1.2 Free Walk | 2 |
| 3.2.1.3 Flat Walk and Running Walk | 2 |
| 3.2.1.4 Canter | 2 |
| 3.2.2 Objectives and Standards of Levels of Competition | 2 |
| 3.2.3 Collective Marks | 2 |
| 3.2.3.1 Gaits | 2 |
| 3.2.3.2 Submission | 4 |
| 3.2.3.3 Impulsion | 4 |
| 3.2.3.4 Position of Rider | 4 |
| 3.2.4 Scoring | 4 |
| 3.2.5 Participation in Dressage Competitions | 5 |
| 3.2.6 Attire | 5 |
| 3.2.7 Tack and Equipment | 5 |
| 3.2.8 Bits Permitted in Dressage | 6 |
| 3.2.8.1 The following snaffle bits are permitted: | 6 |
| 3.2.9 Execution of the Tests – Calling Tests | 6 |
| 3.2.10 Errors | 6 |
| 3.2.11 General Rules | 7 |
| 3.2.11.1 Lameness | 7 |
| 3.2.11.2 Accuracy | 7 |
| 3.2.11.3 Grinding of the Teeth and Wringing of the Tail | 7 |
| 3.2.11.4 Fall of Horse and/or Rider | 7 |

| | | |
|----------|---|-----------|
| 3.2.11.5 | Unusual Circumstances | 7 |
| 3.2.11.6 | Elimination | 7 |
| 3.2.12 | Posting of Scores | 7 |
| 3.3 | Western Dressage | 8 |
| 3.3.1 | Participation | 8 |
| 3.3.2 | Gaits of Western Dressage | 8 |
| 3.3.3 | Objectives and Standards of Levels of Competition | 8 |
| 3.3.4 | Collective Marks | 8 |
| 3.3.4.1 | Gaits | 9 |
| 3.3.4.2 | Collection | 9 |
| 3.3.4.3 | Submission | 9 |
| 3.3.4.4 | Impulsion | 9 |
| 3.3.4.5 | Position of Rider | 9 |
| 3.3.5 | Scoring | 9 |
| 3.3.6 | Attire, Tack & Equipment | 10 |
| 3.3.7 | Bits Permitted in Western Dressage | 12 |
| 3.3.8 | Execution of the Tests - Calling Tests | 12 |
| 3.3.9 | Errors | 12 |
| 3.3.10 | Unusual Circumstances | 12 |
| 3.3.11 | Elimination | 12 |
| 4 | DRIVING | 13 |
| 4.2 | General | 13 |
| 4.3 | Combined Driving | 13 |
| 4.4 | Obstacle Driving | 13 |
| 4.4.1 | Tack and Equipment | 13 |
| 4.4.2 | Class Procedure | 13 |
| 4.4.3 | Suggestions for obstacles | 13 |
| 4.4.4 | Judging | 14 |
| 4.4.4.1 | Faults | 14 |
| 4.4.4.2 | Elimination | 14 |
| 4.5 | Pleasure Driving | 14 |
| 4.5.1 | General | 14 |
| 4.5.2 | Driver | 14 |
| 4.5.3 | Judging & Procedures | 15 |
| 4.5.4 | Attire & Equipment | 15 |
| 4.6 | Reinsmanship | 16 |
| 4.6.1 | Tack & Equipment | 16 |
| 4.6.2 | Class Procedures | 16 |

| | | |
|-----------|-------------------------------|-----------|
| 4.6.3 | Judging | 17 |
| 4.6.3.1 | Disqualifications | 17 |
| 5 | ENDURANCE RIDING | 17 |
| 6 | EQUITATION | 17 |
| 6.2 | General | 17 |
| 6.2.1 | Classes | 17 |
| 6.3 | Intermediate Equitation | 17 |
| 6.4 | Stock Seat Equitation | 18 |
| 6.4.1 | General | 18 |
| 6.4.2 | Appointments | 18 |
| 6.4.3 | Judging Criteria | 19 |
| 6.4.3.1 | Suggested Scoring Criteria | 19 |
| 6.4.3.2 | Classes and Appropriate Tests | 19 |
| 6.5 | Walking Seat Equitation | 20 |
| 6.5.1 | General | 20 |
| 6.5.2 | Appointments | 20 |
| 7 | JUDGED PLEASURE RIDES | 27 |
| 8 | JUMPING | 27 |
| 8.2 | Hunter Over Fences | 27 |
| 8.2.1 | Course Diagrams and Schooling | 27 |
| 8.2.2 | Obstacles | 27 |
| 8.2.2.1 | In-And-Outs | 28 |
| 8.2.3 | Tack and Equipment | 28 |
| 8.2.4 | Attire | 28 |
| 8.2.5 | Judging | 28 |
| 8.2.5.1 | Suggested Scoring | 28 |
| 8.3 | Hunter Hack | 29 |
| 8.3.1 | Obstacles | 29 |
| 8.3.2 | Attire, Tack & Equipment | 29 |
| 8.3.3 | Judging | 29 |
| 9 | MODEL | 30 |
| 9.2 | Model Classes | 30 |
| 9.2.1 | General | 30 |
| 9.2.2 | Procedures & Judging | 30 |
| 9.2.3 | Tack & Equipment | 30 |
| 10 | REINING | 30 |
| 10.2 | General | 30 |
| 10.3 | Tack & Equipment | 31 |
| 10.4 | Scoring | 31 |
| 10.4.1 | Penalties | 32 |

| | | |
|-----------|--|-----------|
| 10.5 | Patterns | 32 |
| 11 | SHOWMANSHIP AT HALTER | 46 |
| 11.2 | Showmanship | 46 |
| 11.3 | General | 46 |
| 11.4 | Attire, Tack & Equipment | 46 |
| 11.4.1 | English Attire | 46 |
| 11.4.2 | Western Attire | 47 |
| 11.4.3 | Tack & Equipment | 47 |
| 11.4.3.1 | English Tack | 47 |
| 11.4.3.2 | Western Tack | 47 |
| 11.4.4 | Fitting and Grooming | 47 |
| 11.4.5 | Showing the Horse | 47 |
| 11.4.6 | Faults | 48 |
| 11.4.7 | Disqualifications | 49 |
| 11.4.8 | Additional Tests (as requested by judge) | 49 |
| 11.4.9 | Judging | 49 |
| 12 | SPEED EVENTS | 49 |
| 12.2 | Barrel Racing | 49 |
| 12.2.1 | Tack and Equipment | 49 |
| 12.2.2 | The Pattern | 49 |
| 12.2.3 | Timing | 50 |
| 12.2.4 | Penalties | 50 |
| 12.2.5 | Disqualification | 50 |
| 12.2.6 | Barrel pattern | 51 |
| 12.3 | Pole Bending | 51 |
| 12.3.1 | Tack and Equipment | 51 |
| 12.3.2 | The Pattern | 51 |
| 12.3.3 | Timing | 51 |
| 12.3.4 | Penalties | 52 |
| 12.3.5 | Disqualification | 52 |
| 12.3.6 | Pole Bending Diagram | 52 |
| 13 | TRAIL OBSTACLE | 53 |
| 13.2 | General | 53 |
| 13.3 | Class Specifications | 54 |
| 13.4 | Course Design | 54 |
| 13.4.1.1 | Inspection of the course | 54 |
| 13.5 | Maneuvers & Obstacles | 55 |
| 13.5.1 | Mandatory Obstacles | 55 |
| 13.5.2 | Optional Maneuvers & Obstacles | 55 |
| 13.5.3 | Prohibited Obstacles | 55 |
| 13.6 | Judging | 56 |
| 13.6.1 | Penalties | 56 |
| 13.6.2 | Scoring | 57 |

| | | |
|-----------|------------------------|-----------|
| 13.6.2.1 | Penalty points | 57 |
| 13.7 | In-Hand Trail Obstacle | 57 |
| 13.7.1 | Class Specifications | 58 |
| 13.7.2 | Exhibitor Requirements | 58 |
| 13.8 | Judging | 58 |
| 13.8.1 | Scoring & Penalties | 59 |
| 14 | WATER GLASS | 59 |
| 14.2 | Water Glass | 59 |
| 14.3 | Tack and Equipment | 59 |
| 14.4 | General Rules | 59 |
| 14.5 | Scoring | 59 |
| 14.6 | Disqualification | 59 |
| 15 | WESTERN RIDING | 60 |
| 15.2 | General | 60 |
| 15.2.1 | Patterns | 60 |
| 15.3 | Tack and Equipment | 60 |
| 15.4 | Scoring | 60 |
| 15.4.1 | Penalty Points | 61 |
| 15.4.2 | Disqualification | 61 |
| 15.5 | Accepted Patterns | 62 |

1 VERSATILITY

The NWHHA Versatility Program provides a venue for owners to showcase the versatility of the breed in classes that are not designated as Under Saddle or Halter Division events. The versatility program highlights the versatility of the walking horse and its inherent ability to perform and compete in a variety of disciplines. The NWHHA Rule Book applies in all matters in addition to the versatility rules that follow, refer to the NWHHA Rule Book for additional information concerning regulations on attire and equipment, shoeing, exhibiting and more.

1.1 General

1.1.1 Horse/Rider Combinations

For any versatility event where competitors ride individually, the horse may enter a maximum of one time with an adult rider AND one time with a youth rider. No horse may be entered with more than one adult rider or more than one youth rider. Riders may enter on multiple horses as time and show management permit.

1.1.2 Courses and Patterns

For any event that requires a course, pattern, or individual test, that pattern must be posted at least one hour prior to the beginning of the class. Show managers may make courses and patterns available (electronically or printed) prior to the show at their discretion.

1.1.3 Division of Classes

Classes may be divided into youth and adult where there are sufficient entries. Show management may offer variations of classes to accommodate various levels and entries. Show management will determine whether entries may cross-enter into various levels offered.

a. Limitations

The following limitations may be used for Versatility classes only, except Novice which is addressed in NWHHA Rule Book, section 6.5 for classes other than Versatility. Limitations may be applied to either horse or rider or a combination of both. Eligibility is established as of the closing date of entries. Only NWHHA competitions affect reckoning of limitation criteria. Single horse classes do not affect reckoning. Exception: Dressage limitations use scoring instead of ribbons won, reference section 1.1.3 b.

- Maiden has not won one (1) blue ribbon
- Novice has not won three (3) blue ribbons
- Limit has not won six (6) blue ribbons

b. Dressage Limitations

Maiden, Novice and Limit classes or divisions are open to horse/rider combinations which have not attained one/ three/six scores of 60% or higher, respectively, in Dressage classes at NWHHA competitions in the particular level in which they are shown. Scores attained at a lower dressage level do not count in the reckoning of Maiden, Novice, or Limit status at a higher level, however, the same horse/rider combination cannot compete in Maiden, Novice or Limit classes or divisions if they have previously competed at a higher dressage level in a NWHHA competition.

c. Green - horse or rider are those in their first or second year of showing in Jumping classes only.

1.2 Versatility Classes

Versatility Classes showcase the abilities of the walking horse. Versatility classes may be amateur, youth and/or open as specified by Show Management, in keeping with specific class requirements. NWA Regulated classes within the Versatility Division include:

Competitive Trail Riding

Dressage

- Traditional
- Western

Driving

- Combined Driving
- Obstacle Driving
- Pleasure Driving

Endurance Riding

Equitation

- Reinsmanship
- Walking or Stock Seat

Judged Pleasure Riding

Jumping

- Hunter Over Fences
- Hunter Hack

Model

Reining

Showmanship at Halter

Speed Events

- Barrel Racing
- Pole Bending

Trail Obstacles

Untimed Events

- Water Glass

Western Riding

Versatility Classes may be further organized into the following groups and may or may not be NWA Regulated versatility classes

Untimed Events

Examples

Egg & Spoon

Ribbon Pairs

Water Glass

Speed Events

Examples

Catalog Race

Indiana Flags

Barrel Racing

•

2 COMPETITIVE TRAIL RIDING

In competitive trail riding, the horse is judged on condition, soundness and trail ability negotiating natural trail obstacles. The rider is judged on presentation, grooming (no artificial enhancements, polished hooves, etc.), trail equitation, trail safety/courtesy, stabling, etc. The general rules and requirements of the sanctioning body of the competition will apply.

3 DRESSAGE

Dressage is the development of communication between the horse and rider. We strive for a calm, supple, confident, and attentive horse. Eventually, the horse achieves perfect understanding with its rider.

The objectives are shown in the following attributes

- The freedom, tempo and regularity of the gaits.
- The harmony, lightness, and ease of movement.
- The lightness of the forehand, engagement of the hindquarters.
- Acceptance of the bit.

3.2 Tests

Current NWAHA Gaited Dressage tests are provided online at www.nwha.com with licensing permission from USEF as stated on each test which reads:

© United States Equestrian Federation, Inc. (USEF). Reprinted with the permission of USEF. All rights reserved. Reproduction without permission is prohibited by law. Tests are modified with the permission of USEF for use by National Walking Horse Association. USEF is not responsible for any errors or omissions in the publication or for the use of its copyrighted materials in an unauthorized manner.

3.2.1 Qualifying Gaits

3.2.1.1 *Medium Walk*

The Medium Walk is a marching pace in "four time". Often, in the world of the gaited horse, the slow (normal horse) walk is referred to as a Trail Walk. In no case should the medium walk be a Trail Walk. Rather, it is an energetic, marching gait on the bit, with soft contact. The horse is soft and giving through the poll and jaw, listening to the aids, and has its hind end engaged. The horse should use its back and exhibit some over-stride. Remember, the name of this gait is the Medium Walk.

3.2.1.2 *Free Walk*

At the Free Walk, the horse is allowed to lower and stretch out its head and neck. At this forward moving gait, the horse stretches forward and downward over its top line in search of contact. The tempo (beats per minute) should be the same as in Medium Walk. One does not throw away the reins, but rather allows the horse to take them as he stretches. The horse must be able to listen to seat and legs for guidance and to maintain straightness. The Free Walk is often performed on the diagonal, which is the longest possible straight line in the arena. Steering with the hands is penalized.

3.2.1.3 *Flat Walk and Running Walk*

Refer to NWAHA Rulebook Section 10.3.8.

3.2.1.4 *Canter*

Refer to NWAHA Rulebook Section 10.3.8.

•

3.2.2 Objectives and Standards of Levels of Competition

Refer to the current NWAHA Gaited Dressage Tests for

- Introductory Level
- Training Level
- First Level
- Second Level
- Third Level
- Fourth Level

3.2.3 Collective Marks

Refer to the current NWAHA Gaited Dressage tests for collective marks description and scoring.

3.2.3.1 *Gaits*

The Judge shall consider the overall quality of all the gaits exhibited. No one gait receives preferences over the other. If the horse exhibits an excellent flat walk, but less than average canter, the collective mark must take both into account. The Judge should review the individual scores and comments of the test's movements to arrive at his or her final collective mark for gaits.

3.2.3.2 *Submission*

This mark provides an overall impression of the horse's willingness to relax the jaw, flex over the poll, and submit to the rider's aids. A horse that presents a tense, hollow frame will receive a significantly lower score than one who is soft and giving.

3.2.3.3 *Impulsion*

This mark reflects the overall ability of the horse to use its hind end as a motor to propel himself forward. The horse must shift its balance rearward and use its hind legs to push its body forward. This energy should transmit all the way from the back legs through the bridle as the horse moves forward. At the Medium Walk, the horse demonstrates impulsion with a marching, forward cadence. At the Flat Walk, the horse propels himself by driving from behind. Similarly, at the Canter, the horse presents a balanced frame with its hind legs reaching well under its body. Impulsion is never a gauge of speed.

3.2.3.4 *Position of Rider*

The aids of the hands, legs, and seat are of great importance in Dressage. The Judge provides an overall assessment of the Rider's ability to communicate with the horse, the effectiveness of the aids, and the correctness of the overall position of the Rider on the horse. The Rider should present a balanced position, with the shoulder, hip, and heel in a straight line close to perpendicular with the horizon. The Rider's loins and hips remain supple, thighs and legs steady and well stretched downward. The Rider should not grip with the knee or any other part of the leg, but rather allow the weight of the leg to flow downward from the hip through the heel. The upper body should be upright and relaxed. Elbows must be bent so that the rider's arms fall naturally from the shoulder along the body, and then bend to meet the reins. Hands are carried slightly above the horse's withers, about 4 - 6 inches apart, with the thumbs on top and the wrists straight. Reins may be held between the ring (4th) finger and the pinky, or outside the pinky. Both hands must be the same height above the withers. The Rider should apply the aids promptly and correctly, demonstrating the proper use of seat, legs, and hands. Simultaneously, the horse must respond to the aids. Failure to do so indicates a lack of training or concentration.

3.2.4 Scoring

All movements and certain transitions are scored individually on the Judge's sheets. They are marked 0 to 10, 0 being the lowest mark and 10 being the highest.

The scale of marks follows:

| | | | |
|----|--------------|---|--------------|
| 10 | Excellent | 5 | Sufficient |
| 9 | Very Good | 4 | Insufficient |
| 8 | Good | 3 | Fairly Poor |
| 7 | Fairly Good | 2 | Poor |
| 6 | Satisfactory | 1 | Very Poor |
| | | 0 | No Executed |

"Not Executed" means that practically nothing of the required movement has been performed."

After each performance, the Judge's sheets are scored. The marks are multiplied by the corresponding coefficients where applicable, and then totaled. Penalty points incurred for errors in the execution of the test are then deducted on each judge's sheet. The total number of points earned is then divided by the total number of possible points and multiplied by 100 to arrive at a percentage. The rider with the highest percentage wins the class.

Scores must be posted on a public scoreboard as soon as possible after each ride.

3.2.5 Participation in Dressage Competitions

- a. Stallions will be barred from any class in which the conditions specify that a Youth exhibitor is to ride.
- b. No horse may be ridden more than once in any Dressage class, except in cases of an Adult and Youth sharing a horse when there is not a separate class for Youth.
- c. A Dressage Competition Manager may not compete at his or her own competition. However, he/she may ride "Hors de Concours" (receives score, but it is not counted for awards) if they wish.
- d. Horses may enter no more than two consecutive levels at any one competition. For example, a competitor may ride Intro and Training level, or Training and First levels, but may not ride Intro and First nor all three.
- e. Horses must have at least (50) minutes between tests unless exhibitor provides permission otherwise.
- f. A horse may enter no more than three tests per day.

3.2.6 Attire

English style attire is mandatory, Exhibitors may choose to wear:

- Traditional Dressage attire consisting of:
 - Dressage style jacket, shirt and stock tie or choker, breeches and tall boots.
 - Coordinating half chaps may be worn for Intro and Training Levels only.
 - Hunt Seat attire (See NWA Versatility Section 11.4.3)
 - Saddle Seat attire are permitted in Intro and Training Levels only. See NWA Rulebook Section 8.
 - Gloves are optional.
- a. Exhibitors are required to wear protective ASTM/SEI approved headgear. Such protective headgear should be black or be covered with a dark hat cover.
 - b. A whip no longer than 4 feet including lash may be carried in all classes.
 - c. Spurs must be made of metal, and there must be a shank pointing directly back from the center of the spur. The arms of the spur must be smooth. If rowels are used, they must be free to rotate.

3.2.7 Tack and Equipment

English type saddle with stirrups is compulsory at all levels. Cut-back saddles are allowed if the horse is exhibited in Saddle Seat attire.

- a. A plain snaffle bridle must be used. Micklem bridles are permitted.
 - Training, First and Second Level tests, a plain snaffle bridle is required with a cavesson.
- b. The following cavessons are permitted as long as the inside of the cavesson and/or noseband must be smooth leather or leather like material.
 - Regular cavesson
 - Dropped noseband
 - Flash noseband (a combination of a cavesson and a dropped noseband attachment)
 - Crossed/Figure 8 noseband are permitted.
- c. Third-level tests and above may be ridden in either a snaffle or a double bridle.

Reference USEF Dressage Division rules for regulations of bridles and bits. The following equipment is forbidden:

- Martingales.
- Bit guards.
- Any kind of gadgets (bearing, side, running, balancing reins, tongue tied down, etc.).
- Boots or bandages.
- Blinkers.

- Ear-muffs, ear plugs, or nose covers.
- Seat covers.
- Hoods.
- Ribbons, flowers, etc. in the mane or tail.
 - Exception: Traditional braided forelock and mane ribbons are permitted in Saddle Seat attire and tack presentations.

Use of any of the above equipment will result in the elimination of the competitor.

- d. A breastplate and/or crupper may be used.
- e. Braiding of the horse's mane and tail is encouraged.

Ring Stewards will spot-check equipment either before the horse enters or immediately as it leaves the arena. The responsibility for the correct attire and equipment rests with the Competitor.

3.2.8 Bits Permitted in Dressage

Snaffle bits are required through Second Level and optional at Third and Fourth levels. Snaffle bits are required when competing in traditional Saddle Seat attire. All bits must be smooth and solid. Twisted, wire, and certain roller bits are prohibited.

3.2.8.1 The following snaffle bits are permitted:

1. Ordinary snaffle with single -jointed mouthpiece.
2. (a, b, c) Double-jointed snaffles.
3. Racing snaffle (D-ring).
4. Snaffle.
 - a) with cheeks, with or without keepers.
 - b) without cheeks (Egg-butt).
5. Snaffle with upper or lower cheeks.
6. Unjointed snaffle (Mullen mouth).
7. Snaffle with cheeks. (Hanging or drop cheek Baucher). This may be a D-ring or other ordinary snaffle as pictured in Nos. 1-6.
8. Fulmer.
9. French snaffle.
10. Snaffle with rotating mouthpiece (Myler Level 1 and Level 2).
11. Snaffle with rotating middle piece.
12. Happy Mouth with roller.

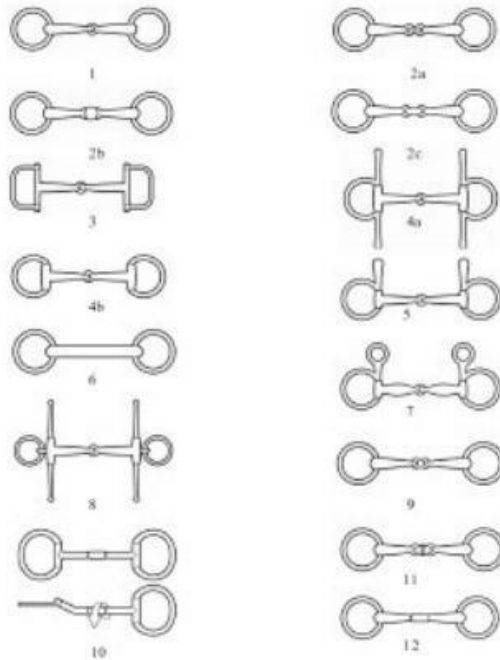

Note: For biting permitted in Third Level and above, reference the USDF Dressage Equipment Booklet at: www.usef.org

3.2.9 Execution of the Tests – Calling Tests

The Exhibitor may have any tests called during the competition. If tests are called, it is the responsibility of the Competitor to arrange for a Caller to announce the test. Lateness and errors in announcing will not relieve the Rider from "error penalties."

3.2.10 Errors

When a Competitor makes an "error of the course" (takes the wrong turn, omits a movement, etc), the Judge will alert the Rider by using a bell or other sound. The Judge will then tell the Competitor where s/he went off, the point at which they must take up the test again, and the next movement to be executed. The Judge then allows the competitor to continue.

Errors are penalized:

- 1st error: 2 points

- 2nd error: 4 points
- 3rd error: 8 points
- 4th error: Elimination
 - The competitor may continue their ride, and receive marks for them, but they will not be considered for placing.

3.2.11 General Rules

3.2.11.1 *Lameness*

In the case of marked lameness or soreness, the horse and Rider are eliminated. There is no appeal against this decision.

3.2.11.2 *Accuracy*

In a movement which must be carried out at a certain point of the arena, it should occur at the moment when the Competitor's body is above this point. Accuracy should be a factor only if the inaccuracy makes the movement easier. If a problem appears once, it may be treated lightly; if it appears multiple times, the Judge will score it more harshly each time.

3.2.11.3 *Grinding of the Teeth and Wringing of the Tail*

These are both signs of tenseness or resistance and will be noted in the score where they appear and in the collective marks.

Having the tongue over the bit or performing with an open mouth are also signs of resistance and the Judge will mark it down.

3.2.11.4 *Fall of Horse and/or Rider*

If the horse or Rider falls, the competitor will not be eliminated. He/she will be penalized by the effect of the fall on the movement being performed and in the collective marks.

3.2.11.5 *Unusual Circumstances*

The Judge may stop a test and/or allow a Competitor to restart a test from the beginning or from any appropriate point in the test if, in his/her discretion, some unusual circumstance has occurred to interrupt the test.

3.2.11.6 *Elimination*

The following will result in elimination:

- Misrepresentation of entry or inappropriate entry.
- Illegal equipment.
- Unauthorized assistance.
- Four errors of the course.
- Horse's tongue tied down.
- Late entry into the arena.
- All four feet of the horse leave the arena.
- Cruelty.
- Marked lameness or soreness.
- Resistance of longer than 20 seconds.
- Any situation where a direct rule violation can be cited.

3.2.12 Posting of Scores

Scores for Dressage classes must be posted as soon as possible after completion of the class and the Judge's placement cards turned in. Show management must make test sheets available to Competitors immediately after the class is scored. Test-sheets may be picked up in the Show Office.

Competitors are responsible for checking the accuracy of their test-sheet scores.

If a mathematical error on the test-sheet is discovered, it must be brought to the attention of the Show Management/Secretary within 1 hour of the conclusion of the Dressage competition. All scores are considered final after expiration of the 1 hour time period.

3.3 Western Dressage

The goal of Western Dressage is to develop a partnership between a happy equine athlete working in harmony with his rider. A system of progressive training produces a horse that is physically strong, balanced, supple and flexible; this equine athlete also demonstrates a calm, confident, attentive attitude and is happy to do his job.

The objectives are shown in the following attributes:

- The freedom, tempo and regularity of the gaits
- The harmony, lightness, and ease of movement
- The lightness of the forehand, engagement of the hindquarters
- Acceptance of the bit

The NWA will apply all rules, regulations and guidelines as currently published by the Western Dressage Association of America (WDAA) as much as possible.

Current Western Dressage tests are provided online at www.wdaa.com. with licensing permission from WDAA as stated on each test.

3.3.1 Participation

Western Dressage classes are open to riders on horses, mules and/or ponies of any origin.

- a. Stallions shall be barred from any class in which the conditions specify that a youth exhibitor is to ride.
- b. No horse may be ridden more than once in any Western Dressage class, except in cases of an adult and youth sharing a horse when there is not a separate class for youth.
- c. A Western Dressage Competition Manager may not compete at his or her own competition. However, he/she may ride "Hors de Concours" (receives score, but it is not counted for awards) if they wish.
- d. Horses may enter no more than two consecutive levels at any one competition. For example, a competitor may ride Intro and Training, or Training and First levels, but may not ride Intro and First nor all three.
- e. Horses must have at least (50) minutes between tests unless exhibitor provides permission otherwise.

3.3.2 Gaits of Western Dressage

All required gaits in the Western Dressage tests will follow the rules and guidelines as stated in the current WDAA Rulebook. In reference to the "saddle gait", it is an equivalent to the definition of the "Flat Walk". Refer to NWA Rulebook Section 10.3.8 Item 5.

3.3.3 Objectives and Standards of Levels of Competition

Current Western Dressage tests are provided online at www.wdaa.com. with licensing permission from WDAA as stated on each test.

- Introductory Level
- Basic Level
- First Level
- Second Level
- Third Level
- Fourth Level

3.3.4 Collective Marks

Reference the current Western Dressage tests for collective marks descriptions and scoring.

3.3.4.1 *Gaits*

The Judge will consider the overall quality of ALL the gaits exhibited. No one gait will receive preference over another. If the horse exhibits an excellent Flat Walk, but less than average Canter, the collective mark must take both into account. The Judge should review the individual scores and comments of the test's movements to arrive at his or her final collective mark for gaits.

3.3.4.2 *Collection*

The aim of collection of the horse is to add to the ease and carriage of the horse, to increase the strength and athleticism, and to make him more pleasurable to ride. The lightness of contact, which is the hallmark of Western Dressage, shall be demonstrated in collection.

3.3.4.3 *Submission*

This mark provides an overall impression of the horse's obedience revealing its presence by a constant attention, willingness and confidence in the whole behavior of the horse as well as by the harmony, lightness and ease he is displaying in the execution of the different movements. Submission is demonstrated by the way the horse accepts the bit, with light contact and a supple pole. Resistance to or evasion of the contact, by being either "above the bit" or "behind the bit" demonstrate lack of submission.

3.3.4.4 *Impulsion*

This mark is used to describe the transmission of an eager and energetic, yet controlled, positive forward energy generated from the hindquarters in the athletic movement of the horse. Its ultimate expression can be shown only through the horses' soft, relaxed, swinging back guided by a light, elastic contact with the rider's hand. Speed, of itself, has nothing to do with impulsion.

3.3.4.5 *Position of Rider*

All the Western Dressage movement should be obtained with imperceptible aids and without apparent effort of the rider. The rider should be well-balanced, elastic, sitting deep in the center of the saddle. Smoothly absorbing the movement of the horse with his core muscles, supply thighs with the legs steady and stretched well down. The heels should be the lowest point with the ankles relatively relaxed. The upper part of the body should be tall and supply demonstrating a vertical alignment of the shoulder to hip to heel. The light contact of the rider's hands should be independent from the rider's seat. The hands should be carried steadily in a style appropriate to the style of rein and bit being used with a straight line from the supple elbow through the hand to the horse's mouth. The elbows should be close to the body. These criterions enable the rider to follow the movements of the horse smoothly and freely.

- a. The Rider may use one or two hands with a curb bit but may not go from one handed to two handed during an individual test.
- b. The Rider must use two hands with a snaffle bit.
- c. Quiet use of the voice and clicking of the tongue is permitted.

3.3.5 *Scoring*

All movements and certain transitions are scored individually on the Judge's sheets. They are marked 0 to 10, 0 being the lowest mark and 10 being the highest.

The scale of marks follows:

| | | | |
|----|--------------|---|--------------|
| 10 | Excellent | 5 | Sufficient |
| 9 | Very Good | 4 | Insufficient |
| 8 | Good | 3 | Fairly Poor |
| 7 | Fairly Good | 2 | Poor |
| 6 | Satisfactory | 1 | Very Poor |
| | | 0 | Not Executed |

"Not Executed" means that practically nothing of the required movement has been performed.

Collective marks are awarded (from 0 – 10, including ½ marks) after the Competitor has finished his performance for:

- Gaits
- Impulsion
- Submission
- The Rider's position, seat and hand(s)
- Correctness and effective use of the aids
- Accuracy
- Harmony

After each performance, the Judge's sheets are scored. The marks are multiplied by the corresponding coefficients where applicable, and then totaled. Penalty points incurred for errors in the execution of the test are then deducted on each Judge's sheet. The total number of points earned is then divided by the total number of possible points and multiplied by 100 to arrive at a percentage. The Rider with the highest percentage wins the class.

Scores must be posted on a public scoreboard as soon as possible after each ride. Individual score sheets may not be available until after official Judging, scoring and placement of said class is complete and awards presented accordingly.

If a mathematical error on a score sheet is discovered, it must be brought to the attention of Show Management within 1 hour of the official posting of the scores from the last class of that competition day. Show management should announce said posting and must make test sheets available to competitors immediately.

3.3.6 Attire, Tack & Equipment

The attire, tack & Equipment for Western Dressage is addressed in the NWA Rule Book Chapter 8, Western Sections. Exhibitors are encouraged to wear protective ASTM/SEI-approved headgear.

- a. One whip no longer than 47.2 inches (120cm or 3 ft. 11.2 in.) including lash, is permitted in all classes/tests.
- b. Protective manufactured leg wraps are permitted, with color matching natural color of the horse as much as possible.
- c. Fly hoods (ear covers) will only be permitted in order to protect horses from insects and only permitted in extreme cases at the discretion of the judge. Permission must be granted prior to the class and applies to all competitors in the class.

The following equipment is forbidden:

- Martingales
- Bit guards
- Any kind of gadgets (bearing, side, running, balancing reins, tongue tied down, etc.)
- Boots or bandages
- Blinkers
- Ear-muffs, ear plugs, or nose covers
- Flash, figure eight or dropped nosebands
- Mechanical hackamores

- Any decorations of the horse with extravagant items (ribbons, flowers etc in the mane and tail)
Use of any of the above equipment will result in the elimination of the competitor.

The responsibility for the correct attire and equipment rests with the competitor.

3.3.7 Bits Permitted in Western Dressage

- a. Snaffle: Any snaffle bit may be used on a horse of any age being ridden at any level. The Rider must use two hands with a snaffle bit.
- b. Curb Bit: There is no discrimination against any standard Western bit. A standard Western curb bit may be used on a horse of any age being ridden at any level; The rider may use one or two hands with a curb bit.
- c. Illegal Bits: All curb bits must be free of mechanical devices. Nothing such as extensions, rivets or prongs, may protrude below the mouthpiece (bars).

The following are prohibited:

- Slip or gag bits, donut or flat polo mouthpieces and kimberwicks.
- Roping bits with reins attached to a single ring at the center of a cross bar.
- Any rein design or other devices which increases the effective length and thereby the leverage of the shank of a standard western bit.
- Anything that alters the intended use of equipment as provided for in the description of appointments for a given class/test.

Examples of biting can be found at www.wdaa.org

3.3.8 Execution of the Tests - Calling Tests

The Exhibitor may have any tests called during the competition. If tests are called, it is the responsibility of the competitor to arrange for a Caller to announce the test. Lateness and errors in announcing will not relieve the rider from "error penalties."

3.3.9 Errors

When a Competitor makes an "error of the course" (takes the wrong turn, omits a movement, etc), the Judge will alert the rider by using a bell or other sound. The Judge will then tell the Competitor where he/she made the error, the point at which they must take up the test again, and the next movement to be executed. The Judge then allows the competitor to continue.

Errors are penalized:

- 1st error: 2 points
- 2nd error: 4 points
- 3rd error: 8 points
- 4th error: Elimination. The competitor may continue their ride, and receive marks for them, but they will not be considered for placing.

3.3.10 Unusual Circumstances

The Judge may stop a test and/or allow a competitor to restart a test from the beginning or from any appropriate point in the test if, in his or her discretion, some unusual circumstance has occurred to interrupt the test.

3.3.11 Elimination

The following will result in eliminations:

- Misrepresentation of entry or inappropriate entry
- Illegal equipment
- Unauthorized assistance
- Four errors of the course
- Horse's tongue tied down
- Late entry into the arena
- All four feet of the horse leave the arena
- Cruelty
- Marked lameness or soreness
- Resistance of longer than 20 seconds
- Any situation where a direct rule violation can be cited

2.

4 DRIVING

4.2 General

Combined Driving, Obstacle Driving and Reinsmanship Driving events.

•

4.3 Combined Driving

Combined Driving combines three separate phases, one on each day, similar to 3-day Eventing. Each phase tests the ability of the horse and Driver. First, Dressage tests the balance, flexibility and communication skills of the pair. Next, the Marathon event tests the horse's endurance and stamina over a Cross-Country course driving through obstacles. Finally, the "cones" test calls for precision driving between sets of cones laid out in an elaborate course.

The general rules and requirements of the sanctioning body of the competition will apply.

4.4 Obstacle Driving

This class tests the skill of the Driver, the obedience and handiness of the horse, and the accuracy with which the course is driven. Judging is based on performance, manner, and appropriateness of entry.

Breeching or thimbles or securely adjusted wraps are required since a number of obstacles require entrants to back. Obstacles will be at least 16 inches wider than the width of the vehicle, measured hub to hub.

4.4.1 Tack and Equipment

Complete driving appointments may be found in the NWAHA Rule Book, 10.23.

4.4.2 Class Procedure

Competitors may have the opportunity to walk the course prior to the start of the class, but no horse may enter the ring, either in hand, under saddle, or hitched, prior to its turn to compete. Competitors drive over a course consisting of six (6) to eight (8) obstacles. The course will be irregular, necessitating changes of directions. Markers indicating obstacles will be at least 16 inches wider than the outside hub of the wheels of each vehicle and at least 12 inches high. (Traffic cones with tennis balls on top work well). Obstacles that are not combined must be at least fifteen (15) feet from one another. If open, all-breed, Driving classes are offered and gaits other than a Trail Walk are posted in the pattern, the words "Working Walk" may be used in place of "Walk" and "Intermediate Gait" or "Pleasure Gait" may be used in place of "Flat Walk."

Leading a turnout into the ring is considered outside assistance and not permitted. Drivers receiving outside assistance after the judging has begun will be disqualified.

4.4.3 Suggestions for obstacles

- a. Bridge - must be at least 8 feet wide.
- b. Back into a stall, touch bar, drive out; or back between two cones and touch a third.
- c. Walk with wheels between triple rails - right two rails 16 inches apart (10 inches at more advanced levels).
- d. Drive through an L
- e. U-turn with center cone
- f. Figure 8 between cones - cones minimum 30 feet apart
- g. Twist between 3 to 5 cones minimum 25 feet apart.
- h. Drive beside a distracting but reasonable trail type object.
- i. Navigate between 2 pairs of cones making a 10 foot square.

4.4.4 Judging

The purpose of the competition is to test the skill of the Driver and the obedience and handiness of the animal. The Obstacle Driving shall be scored 80% on a fault system and 20% on manners, responsiveness, and smoothness of performance. Credit shall be awarded to horses that negotiates the course in a continuous motion, smoothly and alertly, in prompt response to the Driver's cues.

4.4.4.1 *Faults*

- First and second refusal. A refusal is defined as a horse refusing to move forward to the obstacle or backing away from the obstacle. The horse may stop for a moment and then proceed without penalty, but ANY backward step will count as a refusal.
- Touching or Displacing marker.
- Hoof or wheel outside marker.
- Breaking gait.
- Showing an obstacle to the horse.

4.4.4.2 *Elimination*

- Three accumulated refusals.
- Receiving outside assistance.
- Runaways shall be eliminated immediately.
- Taking an obstacle out of order (off course). "Off course" is defined as taking an obstacle in the wrong direction, negotiating from the wrong side, skipping a task (unless directed by the Judge), or negotiating obstacles in the wrong order.
- Equipment failure, including breakage of either harness or vehicle which necessitates a halt for repair. Management or a technical delegate may insist on a safety inspection of the vehicle before allowing it to be used in subsequent classes.
- An overturned vehicle.

4.5 Pleasure Driving

4.5.1 General

Performance of the horse shall be paramount and in no way overshadowed by equipment turnout. Pleasure horse qualities are paramount. Grooming and turnout of horse shall conform to breed standards.

- a. If open, all-breed, Driving classes are offered, the gaits: "Working Walk" may be used in place of "Flat Walk" and "Intermediate Gait" or "Pleasure Gait" may be used in place of "Running Walk."
- b. Show management may offer other classes such as Antique or Period, Drive & Ride or Obstacle.

•

4.5.2 Driver

The term Driver used herein refers to the person controlling the reins and whip. Youth drivers who have not yet reached their 12th birthday must be accompanied by an Adult in the vehicle. Youth Drivers who are older than 12 but not yet 18 years of age may be accompanied by an Adult. Youth Drivers accompanied by an Adult shall sit on the right side of the vehicle. Only the Driver may handle the reins, whip or brake; Failure to comply will result in elimination.

Drivers should strive to present an appropriate turnout to include compatible size, type and weight of horse and vehicle.

- Either one or two handed method of Driving is acceptable. Drivers will not be penalized for using one style over another. The distal ends of the lines (reins) shall always be buckled together.
- An appropriate Driving whip shall always be carried, in the right hand while Driving. The thong on the whip must be long enough to reach the shoulder of the horse or pony.
- Drivers should strive to maintain a safe distance from other vehicles both during the competition and the warm-up area.

4.5.3 Judging & Procedures

The horse should be judged with the same general qualities as the Flat Shod Pleasure Horse. The following are suggestions to be used in judging:

70% on performance, way of going, manners and condition of horse.

30% on condition, fit and appropriateness of harness and vehicle, neatness and appropriateness of Driver's attire and overall impression.

Entries are to enter and track to the right (counterclockwise or First Way) and work both ways of the ring at the Flat Walk and Running Walk. Reverse to be executed on the diagonal at a Walk or at the direction of the Ringmaster. The horse is to line up, stand quietly and back readily.

- - a. Unless the ring is very large, classes of more than 14 Entries shall be split. In a small ring the class may need to be split at a lower number of entries.
 - b. All Entries shall reverse on the diagonal unless otherwise directed by the Judge or Ringmaster. Failure to do so may result in elimination.
 - c. No entry may leave the arena after judging has begun without permission from the Judge and/or Ringmaster. If asked to leave the ring by the Judge and/or Ringmaster, the turnout must do so as soon as is safely possible.
 - d. A Driver without whip in hand shall be severely penalized.
 - e. Dragging of reins on the ground is unsafe and unsightly and shall be penalized.
 - f. Leading a turnout into the ring is considered outside assistance and not permitted. A neatly attired Header should be called in at lineup for safety reasons but should be instructed not to touch the horse unless directed to by the Judge. If the header holds the horse it must be penalized.
 - g. An uncontrollable horse must be immediately dismissed with assistance if necessary. The Judge must excuse a competitor with unsafe vehicle or harness.

4.5.4 Attire & Equipment

- a. Ladies shall wear conservative dress, blouse and skirt, shirt and jodhpurs with apron, saddle suit or day coat and jodhpurs. Men should wear a business suit, saddle suit or sport jacket and slacks.
 - Gloves and either hats or protective headgear are required. Floppy hats are discouraged.
- b. Bridles with blinkers should be adjusted to fit snugly to prevent catching on the vehicle or other pieces of harness. Flash nosebands are strongly discouraged in Pleasure Driving classes.
 - A bridle with reins attached and passed through the saddle terrets must be in place whenever a horse is put to a vehicle.
 - A throatlatch and noseband or cavesson are mandatory.
 - The bridle shall not be removed from a horse, under any condition, while it is still put to a vehicle.
 - The horse must never be left unattended while put to a vehicle.

- c. Snaffle bits and other traditional driving bits such as Half-Cheek Snaffle, Liverpool, Elbow and Butterfly are allowed. Typical, Walking Horse curb bits are not considered Driving bits.
 - Burr, Gag and Twisted Wire Bits are not permitted.
 - Severe bits are to be penalized in Judging. See Illustration #3 for Driving bits.
- d. A black harness is considered appropriate with most vehicles and for vehicles with iron parts painted any color except brown.
 - Russet (brown) harness is considered appropriate with natural wood vehicle with brown or black iron, painted vehicle with natural wood panels with any color iron or vehicle that is painted brown with brown iron.
 - Shaft and pole trimmings should match the harness. All metal furnishings should match.
 - Breast collars are appropriate with any vehicle. Full collars may be used for heavier vehicles.
 - Side-Checks, Over-Checks and Martingales are optional.
- e. Driving vehicle may be two or four wheel and of suitable appearance and safety. Show management may choose to limit classes to two or four wheel vehicles.
 - Breeching is not used with wire wheels and is recommended with wooden wheel vehicles.
 - Combined Driving Marathon vehicles are restricted from Pleasure Driving classes.

4.6 Reinsmanship

Reinsmanship is a Pleasure Driving class in which Entries are Judged primarily on the knowledge, ability, and skill of the Driver and the communication between Driver and Horse. Horses show both ways of the ring at the Walk, Park Gait (Flat Walk or Intermediate Gait), and Road Gait (Running Walk or Fast Rack). Drivers must halt, stand quietly, and rein back (back). The horse should respond promptly and willingly.

a. Suggested classes are:

- Youth
- Adult

4.6.1 Tack & Equipment

Complete driving appointments may be found in Chapter 2 herein. Use of illegal equipment will result in elimination.

4.6.2 Class Procedures

Horses will enter the ring counterclockwise at the Flat Walk (or slow Intermediate Gait). Competitors will show both ways of the ring at the Walk, Park Gait, and Road Gait, reversing across the diagonal and to the inside of Entries on the rail. Individual workouts may be required of all or selected entrants at discretion of Judge. During individual workouts all entrants will be excused from the ring, with only one Exhibitor at a time performing in the ring.

Additional Tests may include:

- Pivot with one wheel in place, left or right, at 90 degrees or 180 degrees at Judge's discretion.
- Backing 4 to 8 steps and returning to place in line.
- Perform a circle or a figure eight (crossing the center line twice), evaluating consistency of speed, willingness, and flexing of the horse on the turns.
- Turns - within a 30 foot parallel, right and left, evaluating willingness, speed, smoothness.
- Mounting - the driver can mount the cart either by the step-on or slide-on method, being sure that control of the horse is always maintained. The Ringmaster will serve as Header.
- Perform at any gait requested by the Judge.

- Negotiate a simple obstacle such as driving or backing between 2 markers or poles.

4.6.3 Judging

To be judged 75% on handling of reins and whip, control, posture, technique, and ability of Driver and 25% on condition and fit of harness and horse, proper harnessing and hitching, and neatness of attire.

When the Driver is driving, both feet should be resting on the stirrups or flat on the floor. The back should be straight, hands held forward no more than chest high, with elbows in a slightly cocked position. The Driver should be driving on contact at all times. Reins may be held in one or two hands.

•

4.6.3.1 Disqualifications

- Unsafe equipment.
- Unruly behavior of the horse or Driver.
- Excessive use of the whip.

5 ENDURANCE RIDING

Endurance rides are a minimum of 25 miles in length, and the first horse/rider team who completes the ride wins. The general rules and requirements of the sanctioning body of the competition will apply.

6 EQUITATION

6.2 General

In the Equitation Division, the Rider, as opposed to the horse, is Judged. Riders will be judged on seat, hands, ability to control and show the horse. Results as shown by performance of the horse are not to be considered more important than the method used by the Rider.

•

Open to Youth exhibitors 17 years old and under and Adults 18 years old and over.

Sections:

- Intermediate Equitation Optional Tack 2 Gait.
- Stock Seat Equitation.
- Walking Seat Equitation.

Note: The awarding of prize money in this division is forbidden.

6.2.1 Classes

- a. Youth Walking or Stock Seat Equitation: Open to Youth Riders 17 and under.

Suggested classes are:

- Riders 11 and under (no Canter required.)
- Riders 12-14 years.
- Riders 15-17 years.
- Championship.

- b. Adult Walking or Stock Seat Equitation: Open to Adult Riders 18 and over.

Suggested classes are:

- Walking Seat Equitation, Riders 18 and Over (no Canter required.)
- Walking Seat Equitation, Riders 18 and Over (Canter.)

6.3 Intermediate Equitation

This is an Optional Tack class that follows the same rules as outlined for Walking and Stock Seat Equitation with the following **exceptions**:

- Daycoats are permitted when showing in Saddle Seat Attire.

- All types of English Saddles are allowed including Dressage saddles.
- A Canter is not required.
- Addressing the reins is not required.

Show Managers may elect to offer variations of the class including: Amateur, Adult, Novice or Youth. Show Management may permit Exhibitors to cross-enter into both Intermediate Equitation and Walking or Stock Seat Equitation classes if they are offered at the same show.

The gait call for the Intermediate Equitation class should be a trail walk and intermediate gait. An intermediate gait may be a flat-walk, pleasure gait, show walk, or slow rack.

Western riders using a shank bit may rein with one or two hands. The rider may not switch their rein hand during the class if riding one-handed. Riders cannot switch between riding with one hand or riding with two hands during this class.

6.4 Stock Seat Equitation

Riders will be judged on seat, hands, ability to control and show the horse.

Results as shown by performance of the horse are not to be considered more important than the method used by the Rider.

6.4.1 General

- a. Fall of the horse and/or rider requires automatic disqualification from the class. Reference NWSHA Rule Book Section 10.3.6.
- b. Any Rider not having his/her mount under sufficient control shall be dismissed from the ring.
- c. No attendant shall be allowed in the ring except at the request of the Judge.
- d. When additional tests are desired the Judge's instructions to the Riders shall be publicly announced. Tests should be posted at least one hour before the class.
- e. Unsoundness of the mount shall not penalize a Rider unless it is sufficient to impair the required performance, except such unsoundness that violates the HPA and other Rules mentioned elsewhere which shall disqualify both horse and Rider.

6.4.2 Appointments

A. Attire

Above all, the Rider's clothing must be clean, workmanlike and neat.

1. The horse and Rider should be well groomed and exercise good taste.
2. The Rider's hair must be neat and well groomed. Riders with long hair must have it styled above the collar.
3. Stock Seat Equitation attire must include:
 - i. Western hat or approved ASTM/SEI certified helmet
 - ii. Long sleeved shirt with collar
 - iii. Long pants, and boots.
 - iv. Optional attire:
 - a. A Tie, Pin or Scarf.
 - b. Vest.
 - c. Coordinating Western Chaps.
 - d. Jacket.
 - e. Gloves.

B. Tack

Tack requirements comply with the rules governing proper tack for a Western Pleasure horse.

1. The saddle should be the correct size to fit the Rider.

C. Seat and Hands

1. The Rider should sit in center of saddle with legs under rider forming a straight

vertical line through, ear, center of shoulder, center of hip and back of heel.

Stirrup length should allow heels to be lower than toes, with slight bend in knee and toe directly under knee. Body should always appear comfortable, relaxed and flexible, and back should be nearly flat. Stiff and/or arched lower back should be avoided. Feet may be placed home in the stirrup with boot heel touching the stirrup or may be placed with ball of foot in the stirrup. Riding with toes only in stirrup will be penalized.

2. Both hands and arms shall be held in a relaxed easy manner, with the shoulders back and down, and upper arm in a straight line with the body, the arm holding the reins bent at elbow forming a straight line from the elbow to the horse's mouth. Wrists are to be kept straight and relaxed, with thumb on top and fingers closed around the reins. Some movement of the arm is permissible but excessive pumping will be penalized. Reins are to be carried immediately above or slightly in front of saddle horn. Only one hand is to be used for reining, and the reining hand shall not be changed. Reins should be carried so as to have light contact with the horse's mouth. Excessively loose reins or tight reins will be penalized. In the event a horse (five years of age or younger) is shown with a snaffle bit or bosal, a rider will show with two hands on the reins.

6.4.3 Judging Criteria

Exhibitors are to be scored from 0-20 with ½ increments acceptable. Ten points should be allocated for overall appearance and functional riding positions and styles. Ten points should be allocated for execution of performance to include rail work and other requested work. Suggested final scoring shall be on a basis of 0-20 with the following scores and criteria for each. At the judge's discretion only those riders who are contenders for an award may be asked to perform extra work or patterns, or they may ask all participants to perform extra work.

6.4.3.1 Suggested Scoring Criteria

- | | |
|-------|---|
| 20 | Excellent equitation including body position and use of aids. Performance on rail (and extra work) executed with precision, promptness and smoothness. |
| 18-19 | Generally excellent performance with one minor fault in appearance or position or execution of performance. |
| 16-17 | Good equitation appearance and position with minor fault(s) in precision, smoothness or promptness of performance. |
| 14-15 | Average equitation appearance and position with flaws that prevent effective riding, or committing two or three minor faults in the performance or appearance or position of the exhibitor. |
| 12-13 | One major fault or several minor faults in the performance or position that precludes effective communication with the horse. |
| 10-11 | Two major faults or many minor faults in the performance or appearance and position of the rider. |
| 6-9 | Several major faults or one severe fault in the performance, appearance and position of the rider. Exhibitor demonstrates a lack of riding ability in performance, position or appearance. |
| 1-5 | Exhibitor commits one or more severe faults in the performance, position or appearance of rider; however, the rider completes the class. |

6.4.3.2 Classes and Appropriate Tests

The Judge will ask each Rider to work individually. These individual workouts will be any of the maneuvers the Judge feels are necessary to determine the horsemanship ability of the Rider. The purpose of the Stock Seat Equitation class is to determine the riding ability of the Rider. Markers should be carefully planned to standardize patterns and guide Riders. Their placement should be indicated in the posted pattern and their placement in the arena well

supervised.

- a. Youth Classes
 - Youth Exhibitors 11 years old and younger should perform on the rail in both directions at the Flat Walk and Running Walk. Test 1 is acceptable extra work. Approved ASTM/SEI certified helmet must be worn.
 - Youth Exhibitors 12-18 years old, tests 1-4 are acceptable.
- b. Adult Classes
 - Adult Stock Seat Equitation is for Riders 19 years and over. These classes follow the same class routine as the Youth classes.
- c. Equitation Championship Classes
 - Judges are encouraged to choose tests not performed in preliminary classes.

6.5 Walking Seat Equitation

6.5.1 General

- Fall of the horse and/or Rider requires automatic disqualification from the class.
- Any Rider not having his/her mount under sufficient control shall be dismissed from the ring.
- No attendant shall be allowed in the ring except at the request of the Judge.

- When additional tests are desired the Judge's instructions to the Riders shall be publicly announced. Tests should be posted at least one hour before the class.
- Unsoundness of the mount shall not penalize a rider unless it is sufficient to impair the required performance, except such unsoundness that violates the HPA and other Rules mentioned elsewhere which shall disqualify both horse and Rider.

6.5.2 Appointments

b. Personal

- The Rider should choose a neat, well-fitted habit with accompanying accessories within the guidelines based on tradition and present-day customs.
- A traditional saddle suit must consist of matching coat and pants and is correct for both day and evening. Suggested colors include black, blue, grey, green, beige or brown with coordinated accessories. Vests should be worn and may either match or contrast with the habit color. The coat length should be at least three inches below the fingertips when standing. The jodhpurs should be long enough to rest on the rider's boot top and the bottom of the boot heel showing only the toe of the boot when mounted. Jodhpur underpasses must be worn.
- A matching or coordinated English riding hat or approved ASTM/SEI certified helmet must be worn. Approved ASTM/SEI certified helmets are required for exhibitors aged 11 and under. A tie matching or coordinating with the suit color should be worn with a man's style shirt. Boots should be of the English type in either calf or patent leather. Gloves shall be worn. English type spurs (either blunt or small rowel) and a whip are optional.
- The semi-formal or tuxedo type suit is suitable to be worn after 6 p.m. only. The acceptable colors are dark blue, brown, grey or black, with collar or lapels of the same color. Top hat or homburg, dark bow tie, cummerbund, gloves, and dark boutonniere complete the outfit.
- The formal or tuxedo type suit is also acceptable only after 6 p.m. The acceptable colors are dark blue, brown, grey, and black with collar or lapels of the same color. Top hat, white bow tie, cummerbund (or pique vest), white gloves, and a white boutonniere complete the outfit.
- The Rider's hair should be neat and well groomed. Riders with long hair should have it styled above the collar.

- c. Tack
 - All tack should be clean and well kept.
 - Standard English Walking Horse bridle with a single rein must be used. Colored brow bands are appropriate; however, rhinestones, etc., are not acceptable. Cavessons and breast straps should be of brown or black leather.
 - English saddles are to be used. Whether of the flat or deep seat variety, the saddle should be the correct size for the Rider. Forward seat saddles and Dressage saddles are prohibited. White, brown or black solid color girths are to be used.
 - Braids should be of the straight plaited variety without butterflies or other ornamentations.

d. Seat and Hands

The Walking Seat Equitation rider should be one of calm, supple workmanship in balance with effective and easy control of self and mount. The rider should show his horse well and exercise appropriate show ring etiquette.

2. Basic Position

- In ideal position, a vertical line could be drawn through the ear, shoulder, hip and heel.
- Head held high looking forward.
- Shoulders square with rib cage drawn up out of the belt.
- Waist should be supple. Buttocks should be neatly tucked (avoid sway back). Seat deep, close, in deepest part of the saddle. Thighs and knees should be in close contact, with toes pointed forward.
- With foot out of the stirrup, the iron should strike the rider just below the ankle. Ball of foot should rest squarely on the stirrup iron with the weight of the leg lowering the heel below the toe.
- Arm should fall naturally from the shoulder with the elbow on the vertical or slightly forward. Forearm parallel to the ground or angling up slightly. Hands and forearms should form a "V" when viewed from above. They should be held well over the withers and far enough apart so that the thumbs almost touch when extended. The hands should be light and in unison with the horse, showing adaptability as well as control.
- Rein should be held between the thumb and index finger with the rest of the fingers closing gently around the rein. Closed (or crossed) reins are optional. Both hands shall be on the reins, and the bight of the reins should be on the off-side.
- Excessive pumping of the reins at the Canter is not appropriate and should be penalized.

D. Judging Criteria

Exhibitors are to be scored from 0 to 20 with ½ increments acceptable. Ten points should be allocated for overall appearance and functional riding positions and styles. Ten points should be allocated for execution of performance to include rail work and other requested work. Suggested final scoring shall be on a basis of 0-20 with the following scores and criteria for each. At the Judge's discretion only those Riders who are contenders for an award may be asked to perform extra work or pattern, or the Judge may ask all participants to perform extra work.

SUGGESTED SCORING CRITERIA

- 20 Excellent equitation including body position and use of aids. Performance on rail (and extra work) executed with precision, promptness and smoothness.
- 18-19 Generally excellent performance with one minor fault in appearance or position or execution of performance.
- 16-17 Good equitation appearance and position with minor fault(s) in precision, smoothness or promptness of performance.
- 14-15 Average equitation appearance and position with flaws that prevent effective riding, or committing two or three minor faults in the performance or appearance or position of the exhibitor.

- 12-13 One major fault or several minor faults in the performance or position that precludes effective communication with the horse.
- 10-11 Two major faults or many minor faults in the performance or appearance and position of the rider.
- 6-9 Several major faults or one severe fault in the performance, appearance and position of the rider. Exhibitor demonstrates a lack of riding ability in performance, position or appearance.
- 1-5 Exhibitor commits one or more severe faults in the performance, position or appearance of rider; however, the Rider completes the class.

E. Class Division and Appropriate Tests:

Class Routine: Enter the ring at the Flat Walk turning to the right and proceeding in counterclockwise direction. The class shall proceed around the ring at each required gait, and on command, reverse and repeat. Riders should line up on command, be judged individually, address reins, and back at the request of the Judge. Any extra work should be performed in 30 seconds per Rider.

1. Youth Class Division

- Youth Exhibitors 11 years old and younger should perform on the rail in both directions at the Flat Walk and Running Walk. Test 1 is acceptable extra work if chosen.
- For Youth Exhibitors 12-14 years old, tests 1-4 are acceptable.
- For Youth Exhibitors 15-18 years old, tests 1-4 are acceptable if chosen.
- Equitation Championships: Judges are encouraged to choose tests not performed in preliminary classes.

2. Adult Class Division

- Adult Equitation is for Riders 19 years and over. This division follows the same class routine as the Youth equitation division.

WALKING SEAT TEST PATTERNS

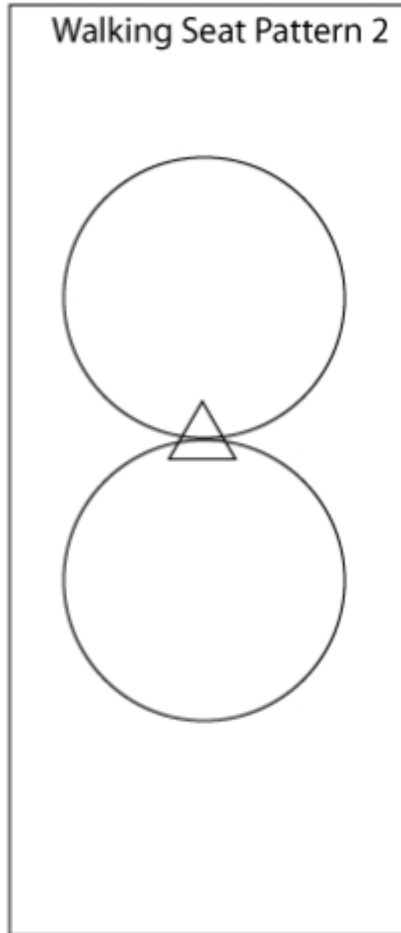
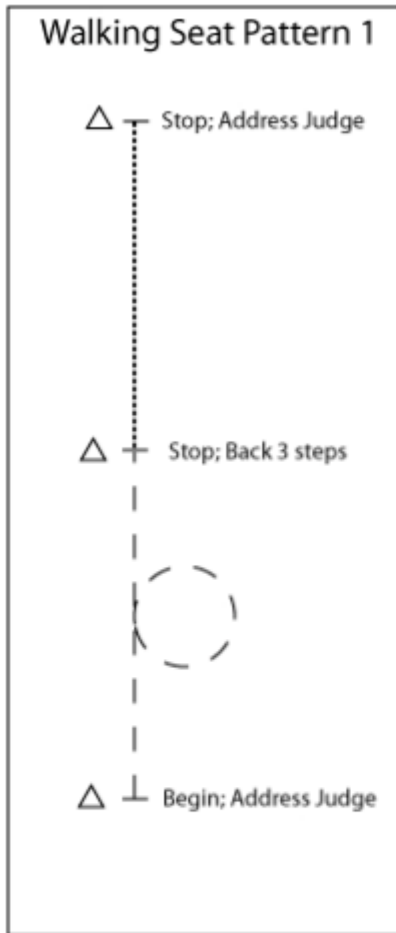

Pattern may be performed at any or all gaits

Key:

| | |
|--------------|-----------|
| Flatwalk | — — — — |
| Running Walk | |
| Canter | - - - - - |
| △ Marker | — Stop |

WALKING SEAT TEST PATTERNS

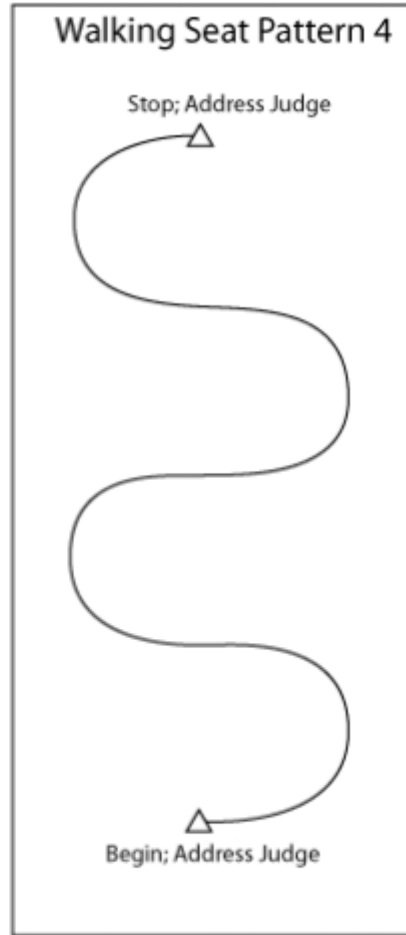

Pattern may be performed at any or all gaits.

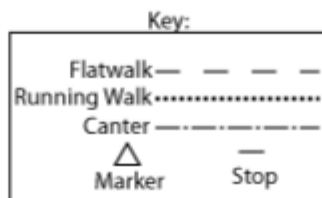

STOCK SEAT PATTERNS

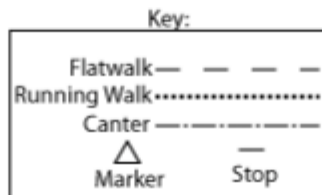
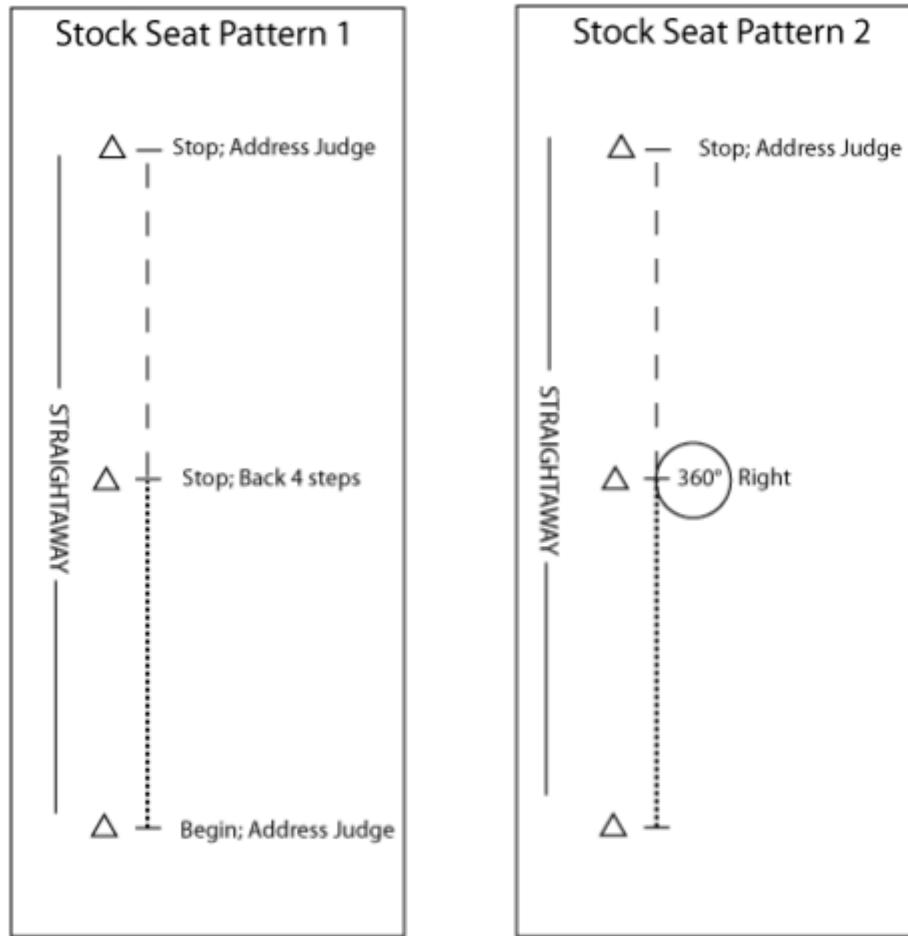

STOCK SEAT PATTERNS

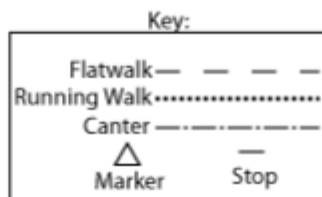
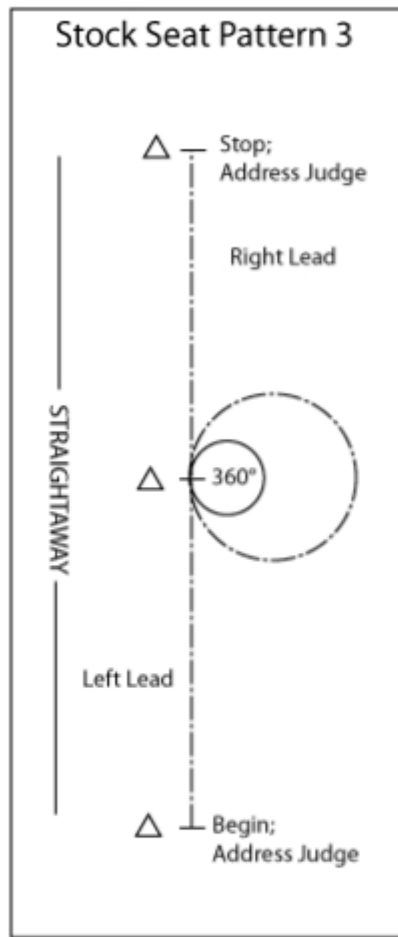

7 JUDGED PLEASURE RIDES

Judged pleasure rides are not timed, except that riders might have a time limit on any particular obstacle. Helmet use is recommended and encouraged. Horse/rider teams may use any type of saddle and bridle (including hackamores and bosals). Riders are judged on how well they negotiate their horse through the obstacles with an emphasis on calmness and safety. Judged pleasure rides are not a race. Judged Pleasure rides are also called Trail Trials.

Obstacles are natural and typically encountered while on a trail ride. A judge at each obstacle evaluates the way both horse and rider negotiate these obstacles. The general rules and requirements of the sanctioning body of the competition will apply.

8 JUMPING

8.2 Hunter Over Fences

The Over Fences classes are judged on performance, soundness, suitability and manners. Horses perform over a minimum of seven obstacles at a controlled, even hunter pace. Excessive speed is not desirable and shall be penalized. Judges are responsible for correctness of each course and shall notify Show Management to any errors that would result in unfair or inappropriate courses.

- All Exhibitors must wear an ASTM/SEI approved helmet during any and all schooling and showing over fences.
- It is recommended that long manes be put up in a “running braid” to prevent the rider’s hands from becoming tangled.

8.2.1 Course Diagrams and Schooling

The course diagram will show the obstacles in the order indicated by numbers. An arrow is used on the diagram to indicate the direction which each obstacle is to be taken. Schooling fences must be provided by Show Management, which may include the opportunity to school the actual course prior to the beginning of the class. If riders are not allowed to school the actual course, they must have the opportunity to walk the course prior to the start of the class.

8.2.2 Obstacles

The course shall include a minimum of four (4) actual jumps. At least one change of direction is mandatory.

Obstacles must be at least 18 inches in height. Obstacles must simulate those found in the hunting field such as natural post and rail, brush, stone wall, white board fence or gate, chicken coop, aiken, hedge, oxer, etc. It is recommended that when fences are set closer together than 84 feet they be set at multiples of 11 feet and 12 feet. Show managers may elect to offer variations of the class including: green, advanced, novice, amateur, youth, etc. Show Managers may permit green horses to cross-enter both green and advanced classes.

- a. “Jumper” type fences such as liverpools, banks, hogsbacks, targets are prohibited. Additionally, spreads over four feet and square oxers are prohibited.
- b. A ground line is required for all obstacles. Courses shall be designed to provide smooth turns and lines. Sharp roll-backs, “jumper” style turns and challenges are prohibited.

8.2.2.1 *In-And-Outs*

An in-and-out is a pair of jumping efforts set either one or two strides apart. They are considered as one obstacle in the required number of obstacles and must never be used as the first fence. The suggested distance for a one stride in-and-out is 22ft to 24ft. The distance between fences for a 2 stride in-and-out should be 34ft to 36 ft.

8.2.3 Tack and Equipment

a. Tack

English bridles with snaffles, Pelhams or Kimberwicks are required. Figure eight nosebands are prohibited.

Saddles should be of jumping saddle types, e.g.: Close Contact, All-Purpose or Eventing. Dressage saddles are permissible. Cut back saddles are prohibited.

b. Equipment

Protective boots, wraps and bandages are permitted. Martingales are permitted, but must be adjusted so as to be safe. Tie-downs and draw reins are not permitted in Jumping classes. Hunter style crops, not to exceed 3 feet in length, are permitted.

8.2.4 Attire

Exhibitors should wear traditional English Hunt Seat attire, including:

- Required ASTM/SEI-approved hunt cap or helmet.
- "Ratcatcher" or collared, button-down shirt.
- Stock tie or choker.
- Hunt Seat or Dressage style jacket
- Breeches or Jodhpurs
- Hunt Seat "dress" or "field" boots. Jodphur boots and matching half-chaps are permitted in non-championship classes.
- Youth riders may exhibit in jodphurs, jodphur boots and garters.

8.2.5 Judging

The horse should exhibit a quiet, even-paced canter, exceptional manners, and good jumping style. These attributes combine with faults and way of moving over the course. Excessive speed must be penalized. The performance starts as the competitor enters and ends when he leaves. Horses that are not serviceably sound will be excused by the judge and are ineligible for placing.

8.2.5.1 *Suggested Scoring*

Scoring shall be on a basis of 0-100 with a break-down of:

- 90-100 Excellent performer.
- 80-89 Good or excellent performer that may commit one or two minor faults.
- 70-79 Fair mover, no severe faults, good performer with a few minor faults.
- 60-69 Poor mover, minor mistakes, average mover 1 or 2 poor fences.
- 50-59 Horse commits one major fault; refusal, crow canter, drops legs, hind-end knockdown.
- 30-39 Two or more major faults, dangerous manor.
- 10-29 Horse avoids elimination but jumps unsafely.

a. Faults

When a horse makes two faults at one obstacle only the major fault will be counted.

Refusals count in addition to a major fault. For an In-and Out, each obstacle is considered separately. In case of a refusal or runout at one obstacle in a combination, the competitor

must re-jump the entire combination. Judges must penalize unsafe jumping and bad form over fences, whether touched or untouched. Circling once upon entering the ring and once upon leaving is recommended. In cases of broken equipment, the competitor may either continue without penalty or stop and fix the problem, in which case he will be penalized. In case of loss of shoe, rider may either continue without penalty or choose to stop and be eliminated. Schooling is not allowed in the event of elimination

b. The following may or may not be considered as faults

- Light rubs
- Late lead changes
- Excessive animation

The following faults are scored according to the Judge's opinion, and depending on severity, may be considered minor or major faults.

Minor Faults

- Showing an obstacle to a horse.
- Not changing leads when required.
- Spooking.
- Inappropriate jumping form.

Major Faults

- Knocking down an obstacle.
- Refusals.
- Breaking gait.
- Bucking.
- Stopping for broken equipment.
- Circling while on course.
- Dangerous jumping

c. Elimination

- Three refusals.
- Off course.
- Jumping a fence before it is reset. Riders will not be penalized for stopping to wait for a fence to be reset.
- Bolting.
- Stopping for loss of shoe.
- Fall of horse or rider.

8.3 Hunter Hack

Hunter Hack will be judged on style over fences, quiet, even Canter, flat work, manners and way of going.

8.3.1 Obstacles

Horses are required to jump two fences between eighteen (18") inches and two (2') feet. A ground line is required for each jump. Horses also work both directions on the rail at a Medium Walk, Intermediate Gait and Canter. Horses jump individually but work on the flat as a group. The Judge may decide the order in which the exhibitors complete either the flat work before the over fences work or vice versa. Generally, all exhibitors line up in the center of the ring during the individual jumping portion of the class.

8.3.2 Attire, Tack & Equipment

Attire, Tack & Equipment are identical to that of the Hunter over Fences.

8.3.3 Judging

Horses are judged on way of going and suitability for the hunt field. Horses should exhibit a calm forward motion. Excessive speed shall be penalized. Excessive pulling of the reins shall also be penalized. At the discretion of the Judge, entries may be asked to Hand Gallop, Halt, or Back and stand quietly. The class shall be judged with 70% emphasis for individual fence work and 30% for work on the flat.

Faults over fences will be scored as in Hunter Over Fences. Faults (to be scored accordingly,

but not necessarily to cause disqualification during rail work) include:

- Wrong lead.
- Excessive speed at any gait.
- Breaking gait.

9 MODEL

9.2 Model Classes

Model Classes for Two year and over horses presented in hand are to be shown in a bridle or show halter. Model Classes should be divided by sex of the horse. Entries in this division should exemplify the ultimate in conformation. They should be in sufficient, good flesh to present a healthy appearance and should be immaculately groomed. All horses should be free of genetic abnormalities such as parrot mouth, under-bite or any other incorrect bite deviations. Additionally, all stallions three years of age and older must have two testicles descended.

9.2.1 General

- a. No entry may be administered a medication that will alter its disposition or deportment in the ring. When such a medication is suspected by a Judge, he shall have the authority to order a medical examination to determine if such medication has been administered. The NWHHA shall reserve the right to examine any entry to determine if drugs have been administered. Such examination as may be required shall be administered after the class. Entries showing obvious outward signs of being sedated or tranquilized shall be excused by the Judge.
- b. No ginger or any medication may be applied to the entry.
- c. Any trainer or handler who, in the opinion of the Judge, abuses an entry with a whip or other instrument shall be excused from the class.
- d. If, in the opinion of the Judge, an entry poses a threat to other exhibitors or, by its behavior, offers an obstacle to other exhibitors, it may be excused from competition.
- e. Exhibitors must wear conservative attire including, at a minimum, a collared shirt and tie.

9.2.2 Procedures & Judging

- a. Entries shall be led into the ring, lined up as directed and then judged. Conformation and conditioning are paramount.
- b. Entries shall be judged on conformation and presentation.
- c. Horses must stand quietly. Entries who do not stand quietly shall be penalized in final judging. Unruly entries shall be dismissed from the ring.
- d. When entries are exhibited, they should stand erect and square on all four feet. Entries should be alert with ears forward and attentive to their surroundings.
- e. Extremes in any conformation component are not desirable. Soundness of limbs should be of utmost importance.
- f. Entries with any genetic abnormalities should be severely penalized.

9.2.3 Tack & Equipment

- a. Model entries must wear a show bridle or show halter.
- b. Boots or action devices and set tails of any kind are prohibited on all entries.
- c. Braids in the manes and/or forelocks are required.
- d. Whips not to exceed four feet in length including snapper are permitted for use by handlers presenting their horses with English equipment.
 - 1. Neither whips nor crops are allowed with Western presentation.

10 REINING

10.2 General

In reining, a horse and rider work as a team to demonstrate the qualities of a working horse. The guidance of the horse should appear effortless, with no apparent resistance. All deviations

from the pattern are considered loss of control and will be scored accordingly.

Shows may choose to offer Novice Reining classes, which allow for simple lead changes in place of flying lead changes and allow exhibitors to use two hands on the reins instead of one. Show Managers may offer variations of the class, including advanced, novice, amateur, youth, etc. Show Managers may permit cross-entry into both and advanced classes.

10.3 Tack & Equipment

Riders must use appropriate western tack and attire. For complete descriptions of Western tack and attire. (NWA Rule Book Chapter 8). Properly worn ASTM/SEI approved headgear is highly recommended for the exhibitor in any and all events and shall not be penalized. Youth riders MUST wear ASTM/SEI-approved helmets. Failure to use appropriate attire will result in a final score of zero.

- a. Curb bits are considered as a standard Western bit. Mechanical hackamores are not permitted. Snaffle bits and bosals are permitted only on junior horses.
- b. One hand is to be used on the reins and the rider may not change hands during performance. Five year old and under horses may be reined using a bosal or snaffle, but the rider must use two hands on the reins. References to bosal means the use of a flexible, braided rawhide, leather or rope bosal, the core of which may be either rawhide or flexible cable. No rigid material will be allowed under the jaws regardless of how padded or covered. Horse hair bosals are prohibited.
- c. Protective boots and polo wraps are permitted.
- d. Whips, crops, or bats are prohibited.
- e. Tie-downs, martingales and draw reins are prohibited.

10.4 Scoring

The rider begins with a score of 70. The judge scores each movement in ½ point increments from a low of -1 ½ to a high of +1 ½ with a score of 0 representing a correctly executed movement with no degree of difficulty.

The following will result in disqualification:

- a. Abuse of an animal.
- b. Illegal equipment.
- c. Exhibitor disrespect or misconduct.
- d. Any unsafe act.

The following will result in a final score of 0:

- a. Improper holding of the reins.
- b. Off-course.
- c. Equipment failure.
- d. Balking or refusal.
- e. Running away.
- f. Fall by horse or rider.
- g. Dropping a rein while the horse is moving.
- h. Maneuvers not specified, including turning more than 90 degrees and backing more than 2 strides.

If an exhibitor is assigned a score of zero, they are included in the group considered for awards. That is, if there are fewer horses in the class than there are placings, an exhibitor assigned a "0" score may be awarded a ribbon. Disqualified exhibitors must not receive any award, no matter the number of entries.

10.4.1 Penalties

- Wrong lead (-1) point.
- Minus 1 point for each $\frac{1}{4}$ of the circumference of a circle or any part thereof out of lead.
- Delayed change of lead (-1) point from one stride to $\frac{1}{4}$ of circumference of a circle, cumulative beyond that point.
- Starting circle at a Flat Walk or exiting rollbacks at any gait other than Canter up to 2 strides ($-\frac{1}{2}$) point.
- Flat Walk beyond 2 strides but less than $\frac{1}{2}$ circle or $\frac{1}{2}$ the length of the arena - 2 points.
- Over or under spinning up to $\frac{1}{8}$ th of a turn ($-\frac{1}{2}$) point
- Over or under spinning up to $\frac{1}{4}$ of a turn (- 1) point
- Failure to remain a minimum of 20 feet from wall or fence when approaching a stop and/or rollback ($-\frac{1}{2}$) point.
- Break of gait - 2 points.
- Freezing up in spins or rollbacks - 2 points.
- Failure to pass the specified marker before initiating a stop - 2 points.

The judge shall have the authority to remove any contestant who shows any disrespect or misconduct as to render himself or the competition in an unprofessional manner.

10.5 Patterns

The following patterns are to be worked as stated, not as drawn. Exhibitors who do not complete the pattern as written shall be "off course" and shall be disqualified.

Markers will be placed on the wall or fence of the arena as follows:

- a. at the center of the arena.
- b. at least 50 feet from each end wall.

Where the Pattern designates a stop beyond a marker, the horse should begin its stop after he passes the specified marker.

All horses will be judged immediately upon entering the arena and judging will cease after the last maneuver. Any fault incurred prior to the commencement of a pattern will be scored accordingly. At the discretion of Show Management, Reining patterns may be included on the show's class sheet or program, and may be distributed prior to the show.

*Reining Patterns are reproduced with the permission of the National Reining Horse Association

REINING PATTERN NUMBER 1

Horse must walk or stop prior to starting pattern.

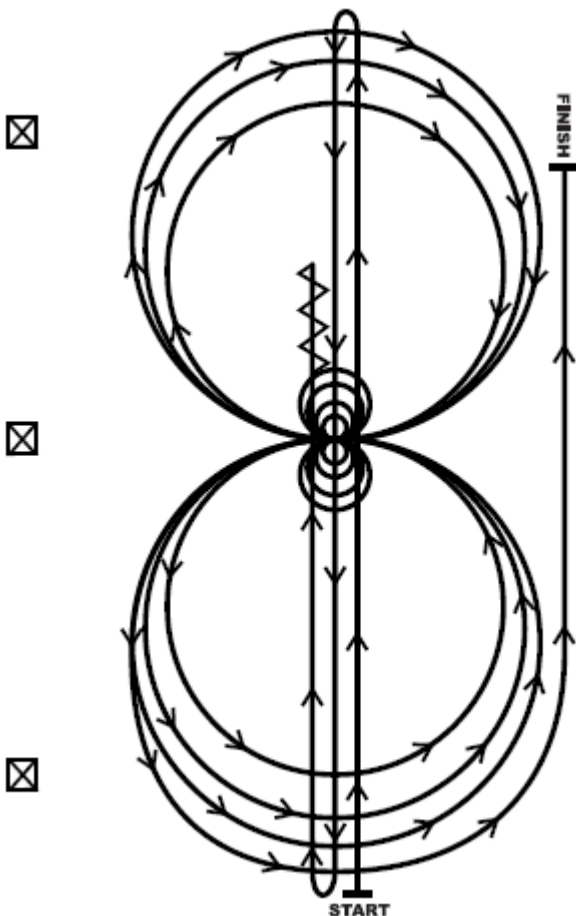

1. Run at speed to the far end of the arena past the end marker and do a left rollback—no hesitation.

2. Run to the opposite end of the arena past the end marker and do a right rollback—no hesitation.

3. Run past the center marker and do a sliding stop. Back up to center of the arena or at least ten feet (three meters). Hesitate.

4. Complete four spins to the right. Hesitate.

5. Complete four and one-quarter spins to the left so that horse is facing left wall or fence. Hesitate.

6. Beginning on the left lead, complete three circles to the left: the first circle large and fast; the second circle small and slow; the third circle large and fast. Change leads at the center of the arena.

7. Complete three circles to the right: the first circle large and fast; the second circle small and slow; the third circle large and fast. Change leads at the center of the arena.

8. Begin a large fast circle to the left but do not close this circle. Run straight up the right side of the arena past the center marker and do a sliding stop at least twenty feet (six meters) from wall or fence. Hesitate to demonstrate the completion of the pattern.

REINING PATTERN NUMBER 2

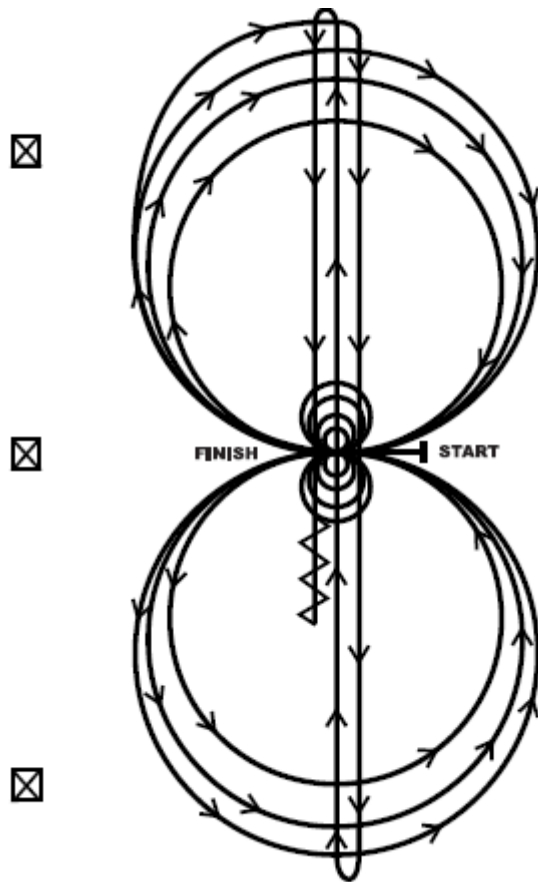

Horses may walk or trot to the center of arena. Horses must walk or stop prior to starting pattern. Beginning at the center of the arena facing the left wall or fence.

1. Beginning on the right lead, complete three circles to the right: the first circle small and slow; the next two circles large and fast. Change leads at the center of the arena.

2. Complete three circles to the left: the first circle small and slow; the next two circles large and fast. Change leads at the center of the arena.

3. Continue around previous circle to the right. At the top of the circle, run down the middle to the far end of the arena past the end marker and do a right rollback—no hesitation.

4. Run up the middle to the opposite end of the arena past the end marker and do a left rollback—no hesitation.

5. Run past the center marker and do a sliding stop. Back up to the center of the arena or at least ten feet (three meters). Hesitate.

6. Complete four spins to the right. Hesitate.

7. Complete four spins to the left. Hesitate to demonstrate the completion of the pattern.

Rider may drop bridle to the designated judge.

REINING PATTERN NUMBER 3

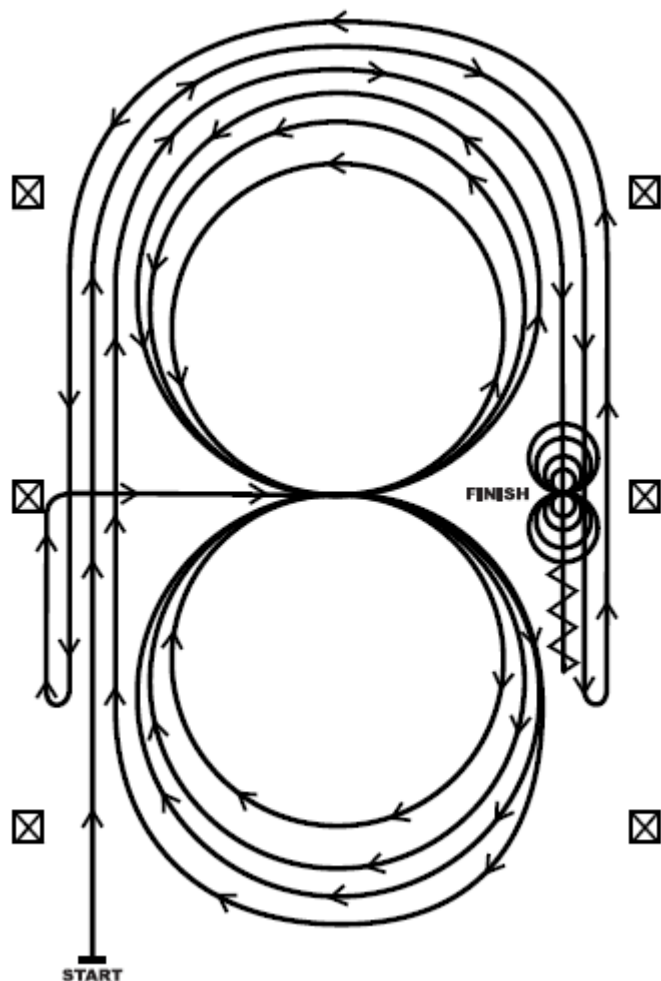

1. Beginning, lope straight up the left side of the arena, circle the top end of the arena, and staying at least twenty feet (six meters) from the walls or fence, run straight down the opposite or right side of the arena past the center marker and do a left rollback—no hesitation.
2. Continue straight up the right side of the arena circle back around the top of the arena, and staying at least twenty feet (six meters) from the walls or fence, run straight down the left side of the arena past the center marker and do a right rollback—no hesitation.
3. Continue up the left side of the arena to the center marker. At the center marker, the horse should be on the right lead. Guide the horse to the center of the arena on the right lead and complete three circles to the right: the first two circles large and fast; the third circle small and slow. Change leads at the center of the arena.
4. Complete three circles to the left: the first two circles large and fast; the third circle small and slow. Change leads in the center of the arena.
5. Begin a large fast circle to the right but do not close this circle. Continue up the left side of the arena, circle the top of the arena, and staying at least twenty feet (six meters) from the walls or fence, run straight down the opposite or right side of the arena past the center marker and do a sliding stop. Back up at least ten feet (three meters). Hesitate.
6. Complete four spins to the right. Hesitate.
7. Complete four spins to the left. Hesitate to demonstrate completion of the pattern.

Rider may drop bridle to the designated judge.

REINING PATTERN NUMBER 4

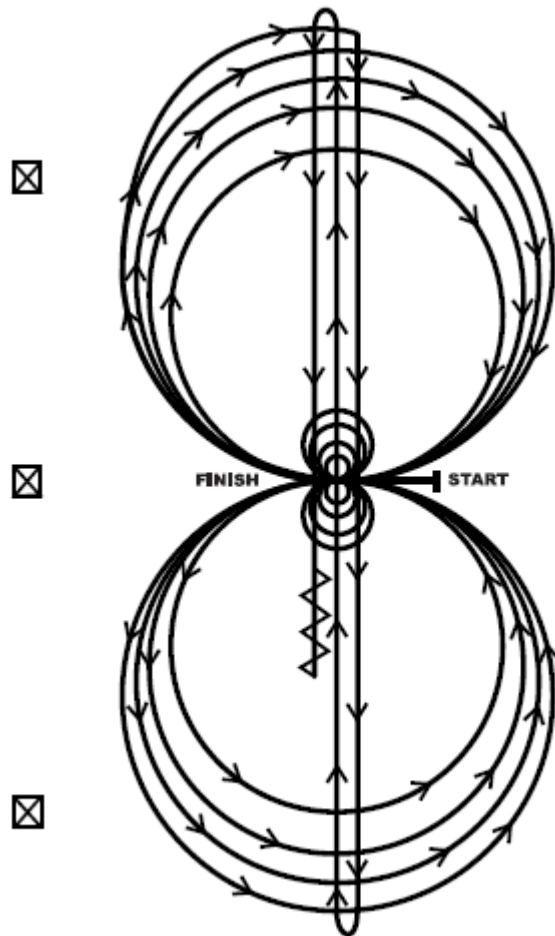

Horses may walk to the center of the arena. Horses must walk or stop prior to starting pattern. Beginning at the center of the arena facing the left wall or fence.

- ☒ 1. Beginning on the right lead, complete three circles to the right: the first two large and fast; the third circle small and slow. Stop at the center of the arena. Hesitate.
- 2. Complete four spins to the right. Hesitate.
- 3. Beginning on the left lead, complete three circles to the left: the first two circles large and fast; the third circle small and slow. Stop at the center of the arena. Hesitate.
- ☒ 4. Complete four spins to the left. Hesitate.
- 5. Beginning on the right lead, run a large fast circle to the right, change leads at the center of the arena, run a large fast circle to the left, and change leads at the center of the arena. (Figure 8)
- 6. Continue around previous circle to the right. At the top of the circle, run down the middle to the far end of the arena past the end marker and do a right rollback—no hesitation.
- 7. Run up the middle to the opposite end of the arena past the end marker and do a left rollback—no hesitation.
- 8. Run past the center marker and do a sliding stop. Back up to the center of the arena or at least ten feet (three meters). Hesitate to demonstrate completion of the pattern.

Rider may drop bridle to the designated judge.

REINING PATTERN NUMBER 5

Horse may Walk or Flat Walk to the center of the arena. Horse must walk or stop prior to starting pattern. Beginning at the center of the arena facing the left wall or fence.

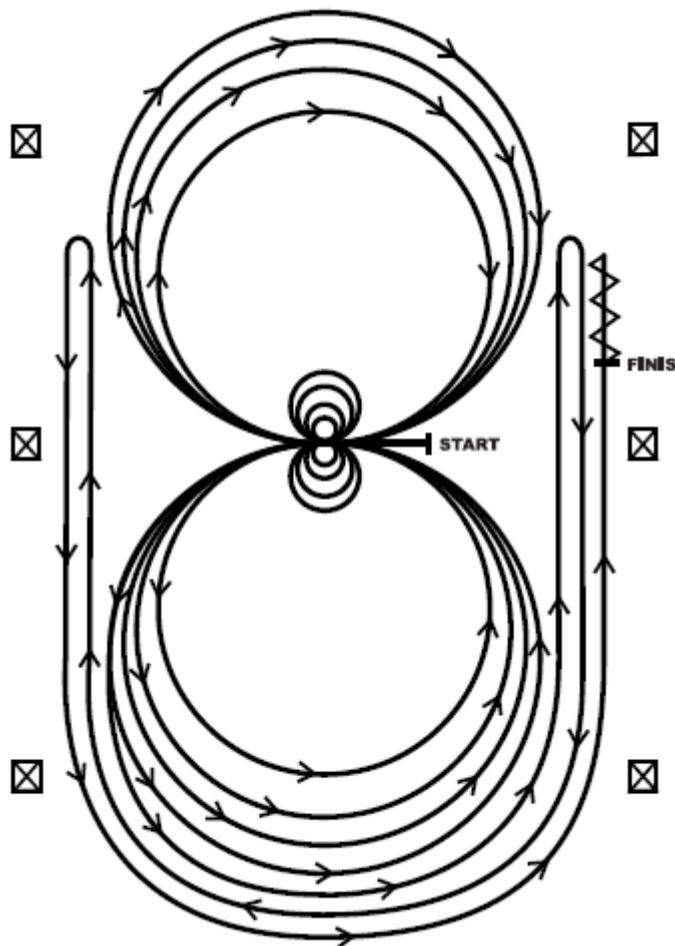

1. Beginning on the left lead, complete three circles to the left: the first two circles large and fast; the third circle small and slow. Stop at the center of the arena. Hesitate.
2. Complete four spins to the left. Hesitate.
3. Beginning on the right lead, complete three circles to the right: the first two circles large and fast; the third circle small and slow. Stop at the center of the arena. Hesitate.
4. Complete four spins to the right. Hesitate.
5. Beginning on the left lead, run a large fast circle to the left, change leads at the center of the arena, run a large fast circle to the right, and change leads at the center of the arena. (Figure 8)
6. Continue around previous circle to the left but do not close this circle. Run up the right side of the arena past the center marker and do a right rollback at least twenty feet (six meters) from the wall or fence—no hesitation.
7. Continue around previous circle but do not close this circle. Run up the left side of the arena past the center marker and do a left rollback at least twenty feet (six meters) from the wall or fence—no hesitation.
8. Continue back around previous circle but do not close this circle. Run up the right side of the arena past the center marker and do a sliding stop at least twenty feet (six meters) from the wall or fence. Back up at least ten feet (three meters). Hesitate to demonstrate completion of the pattern.

Rider may drop bridle to the designated judge.

REINING PATTERN NUMBER 6

Horse may Walk or Flat Walk to the center of the arena. Horse must Walk or stop prior to starting pattern. Beginning at the center of the arena facing the left wall or fence.

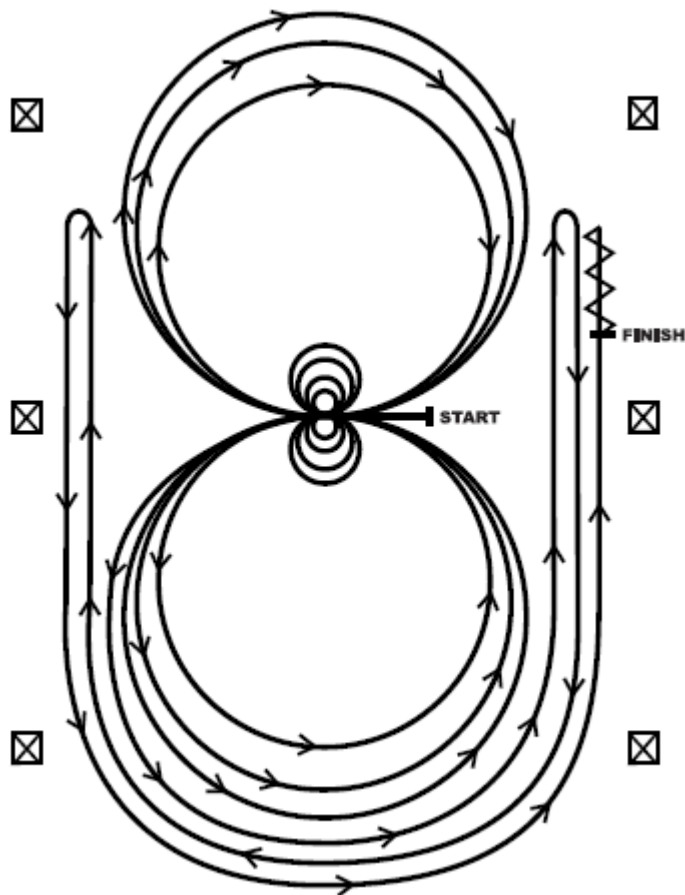

1. Complete four spins to the right. Hesitate.
2. Complete four spins to the left. Hesitate.
3. Beginning on the left lead, complete three circles to the left: the first two circles large and fast; the third circle small and slow. Change leads at the center of the arena.
4. Complete three circles to the right: the first two circles large and fast; the third circle small and slow. Change leads at the center of the arena.
5. Begin a large fast circle to the left but do not close this circle. Run up the right side of the arena past the center marker and do a right rollback at least twenty feet (six meters) from the wall or fence—no hesitation.
6. Continue back around previous circle but do not close this circle. Run up the left side of the arena past the center marker and do a left rollback at least twenty feet (six meters) from the wall or fence—no hesitation.
7. Continue back around previous circle but do not close this circle. Run up the right side of the arena past the center marker and do a sliding stop at least twenty feet (six meters) from the wall or fence. Back up at least ten feet (three meters). Hesitate to demonstrate the completion of the pattern.

Rider may drop bridle to the designated judge.

REINING PATTERN NUMBER 7

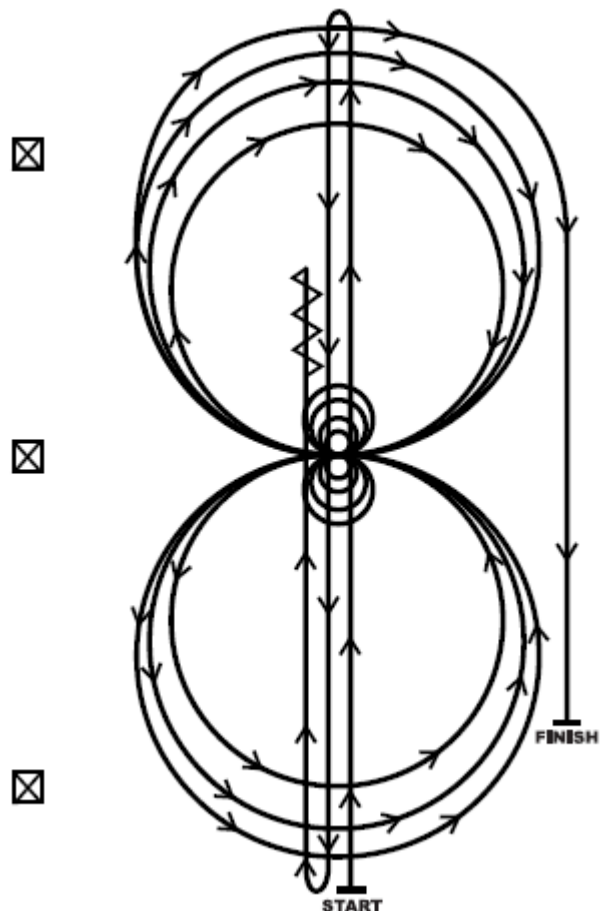

1. Run at speed to the far end of the arena past the end marker and do a left rollback—no hesitation.
2. Run to the opposite end of the arena past the end marker and do a right rollback—no hesitation.
3. Run past the center marker and do a sliding stop. Back up to the center of the arena or at least ten feet (three meters). Hesitate.
4. Complete four spins to the right. Hesitate.
5. Complete four and one-quarter spins to the left so that horse is facing left wall or fence. Hesitate.
6. Beginning on the right lead, complete three circles to the right: the first two circles large fast; the third circle small and slow. Change leads at the center of the arena.
7. Complete three circles to the left: the first two circles large fast; the third circle small and slow. Change leads at the center of the arena.
8. Begin a large fast circle to the right but do not close this circle. Run straight down the right side of the arena past the center marker and do a sliding stop at least twenty feet (six meters) from the wall or fence. Hesitate to demonstrate completion of the pattern.

Rider may drop bridle to the designated judge.

REINING PATTERN NUMBER 8

Horse may Walk or Flat Walk to the center of the arena. Horse must Walk or stop prior to starting pattern. Beginning at the center of the arena facing the left wall or fence.

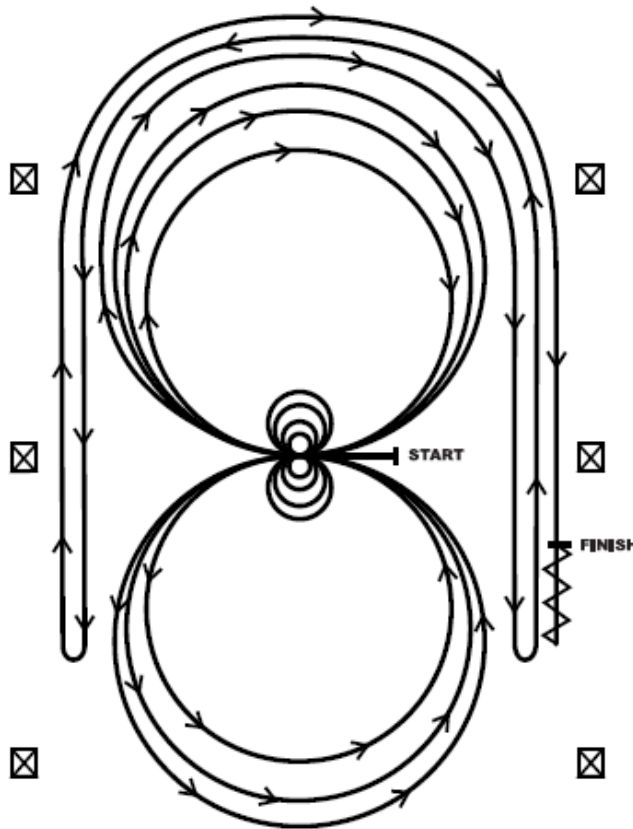

1. Complete four spins to the left. Hesitate.
2. Complete four spins to the right. Hesitate.
3. Beginning on the right lead, complete three circles to the right: the first circle large and fast; the second circle small and slow; the third circle large and fast. Change leads at the center of the arena.
4. Complete three circles to the left: the first circle large and fast; the second circle small and slow; the third circle large and fast. Change leads at the center of the arena.
5. Begin a large fast circle to the right but do not close this circle. Run straight down the right side of the arena past the center marker and do a left rollback at least twenty feet (six meters) from the wall or fence—no hesitation.
6. Continue back around the previous circle but do not close this circle. Run down the left side of the arena past the center marker and do a right rollback at least twenty feet (six meters) from the wall or fence—no hesitation.
7. Continue back around the previous circle but do not close this circle. Run down the right side of the arena past the center marker and do a sliding stop at least twenty feet (six meters) from the wall or fence. Back up at least ten feet (three meters). Hesitate to demonstrate completion of the pattern.

Rider may drop bridle to the designated judge

REINING PATTERN NUMBER 9

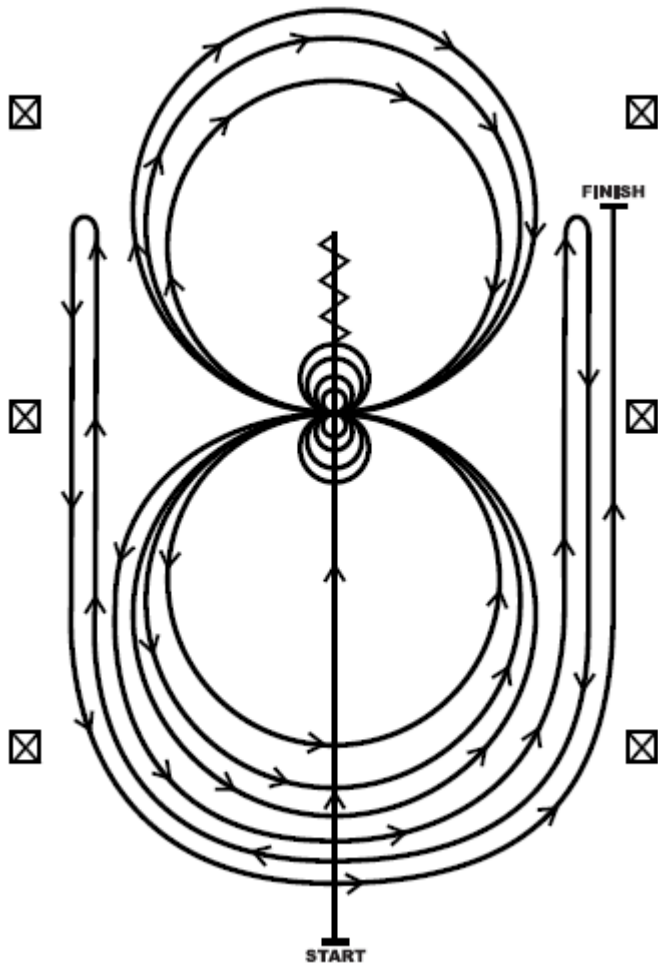

1. Run past the center marker and do a sliding stop. Back up to the center of the arena or at least ten feet (three meters). Hesitate.
2. Complete four spins to the right. Hesitate.
3. Complete four and one-quarter spins to the left so that horse is facing the left wall or fence. Hesitate.
4. Beginning on the left lead, complete three circles to the left: the first circle small and slow; the next two circles large and fast. Change leads at the center of the arena.
5. Complete three circles to the right: the first circle small and slow; the next two circles large and fast. Change leads at the center of the arena.
6. Begin a large fast circle to the left but do not close this circle. Run up the right side of the arena past the center marker and do a right rollback at least twenty feet (six meters) from the wall or fence—no hesitation.
7. Continue back around the previous circle but do not close this circle. Run up the left side of the arena past the center marker and do a left rollback at least twenty feet (six meters) from the wall or fence—no hesitation.
8. Continue back around previous circle but do not close this circle. Run up right side of the arena past the center marker and do a sliding stop at least twenty feet (six meters) from the wall or fence. Hesitate to demonstrate completion of the pattern.

Rider may drop bridle to the designated judge.

REINING PATTERN NUMBER 10

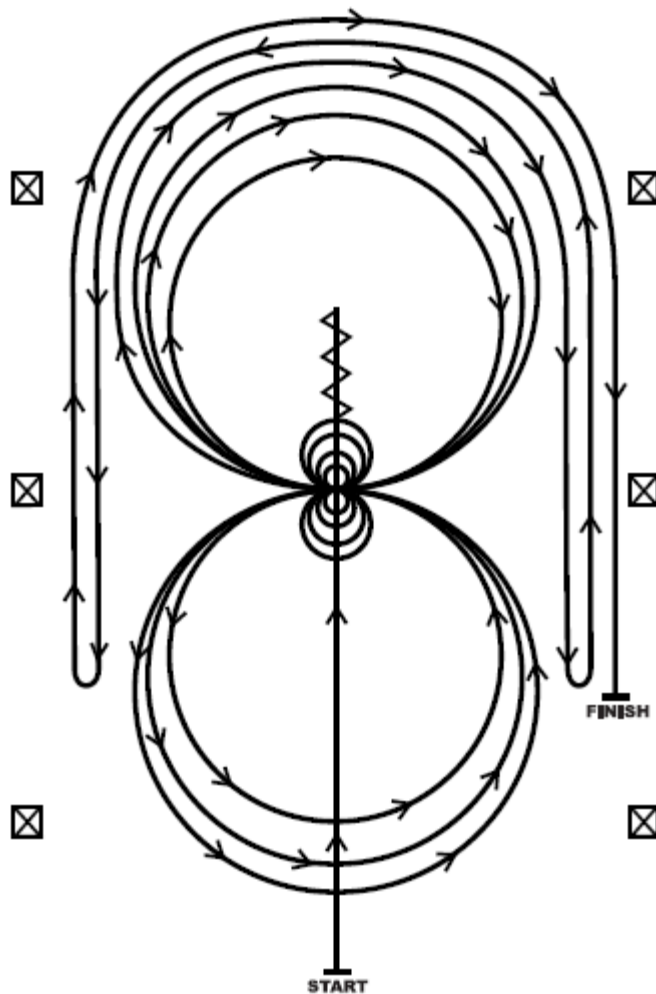

1. Run past the center marker and do a sliding stop. Back up to the center of the arena or at least ten feet (three meters). Hesitate.
2. Complete four spins to the right. Hesitate.
3. Complete four and one-quarter spins to the left so that the horse is facing the left wall or fence. Hesitate.
4. Beginning on the right lead, complete three circles to the right: the first two circles large and fast, the third circle small and slow. Change leads at the center of the arena.
5. Complete three circles to the left: the first circle small and slow, the next two circles large and fast. Change leads at the center of the arena.
6. Begin a large fast circle to the right but do not close this circle. Run down the right side of the arena past the center marker and do a left rollback at least twenty feet (six meters) from the wall or fence—no hesitation.
7. Continue back around the previous circle but do not close this circle. Run down the left side of the arena past the center and do a right rollback at least twenty feet (six meters) from the wall or fence—no hesitation.
8. Continue back around previous circle but do not close this circle. Run down the right side of the arena past the center marker and do a sliding stop at least twenty feet (six meters) from the wall or fence. Hesitate to demonstrate completion of the pattern.

Rider may drop bridle to the designated judge.

REINING PATTERN NUMBER 11

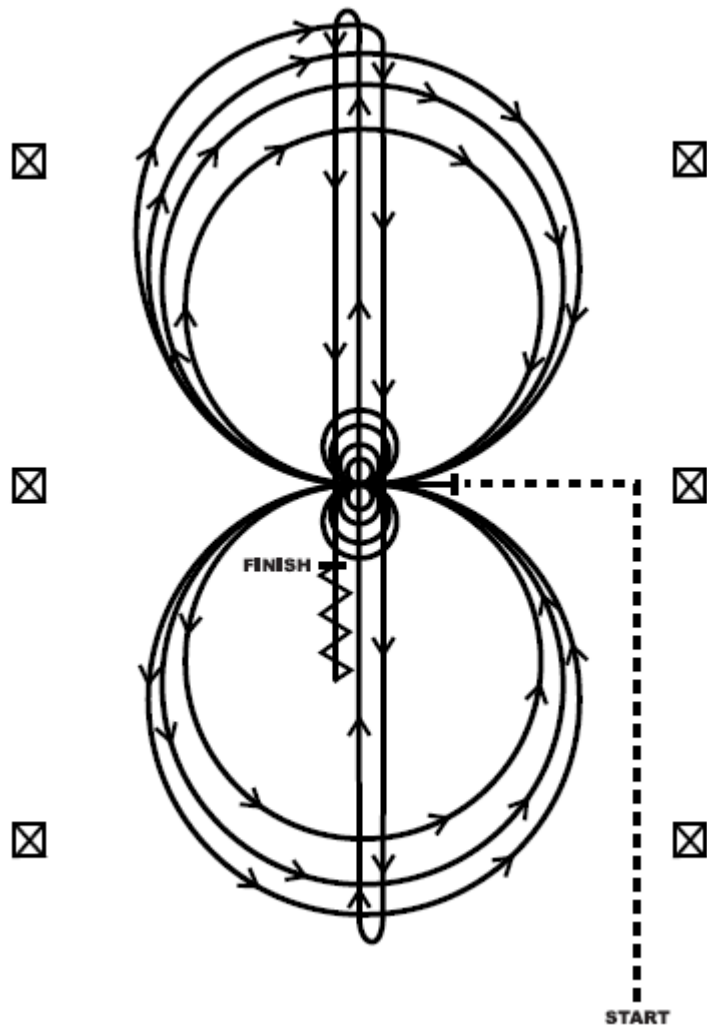

Horses may Walk or Flat Walk to the center of the arena. Horses must Walk or stop prior to starting the pattern. Beginning at the center of the arena facing the left wall or fence.

1. Complete four spins to the left. Hesitate.
2. Complete four spins to the right. Hesitate
3. Beginning on the right lead complete three circles to the right; the first circle small and slow; the next two circles large and fast. Change leads at the center of the arena.
4. Complete three circles to the left; the first circle small and slow; the next two circles large and fast. Change leads at the center of the arena.
5. Begin a large circle to the right, but do not close this circle. Run down the center of the arena past the end marker and do a right rollback—no hesitation.
6. Run up the middle to the opposite end of the arena past the end marker and do a left rollback—no hesitation.
7. Run past the center marker and do a sliding stop. Back up to the center of the arena or at least ten feet (three meters). Hesitate to demonstrate completion of the pattern.

Rider may drop bridle to the designated judge.

REINING PATTERN NUMBER 12

Youth pattern

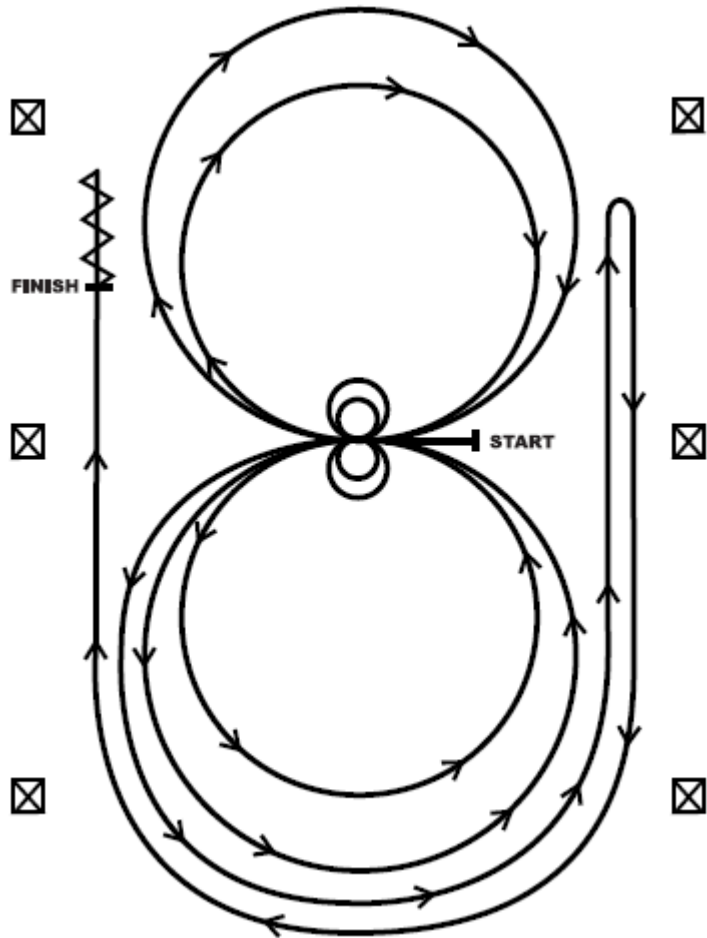

Horses may Walk or Flat Walk to the center of the arena. Horses must Walk or stop prior to starting the pattern. Beginning at the center of the arena facing the left wall or fence.

1. Beginning on the left lead, complete two circles to the left. Stop at the center of the arena. Hesitate.
2. Complete two spins to the left. Hesitate.
3. Beginning on the right lead complete two circles to the right. Stop at the center of the arena. Hesitate.
4. Complete two spins to the right. Hesitate.
5. Beginning on the left lead, go around the end of the arena, run down the right side of the arena past center marker, stop and roll back right.
6. Continue around the end of the arena to run down the left side of the arena past the center marker. Stop. Back up.

REINING PATTERN NUMBER 13

Youth pattern

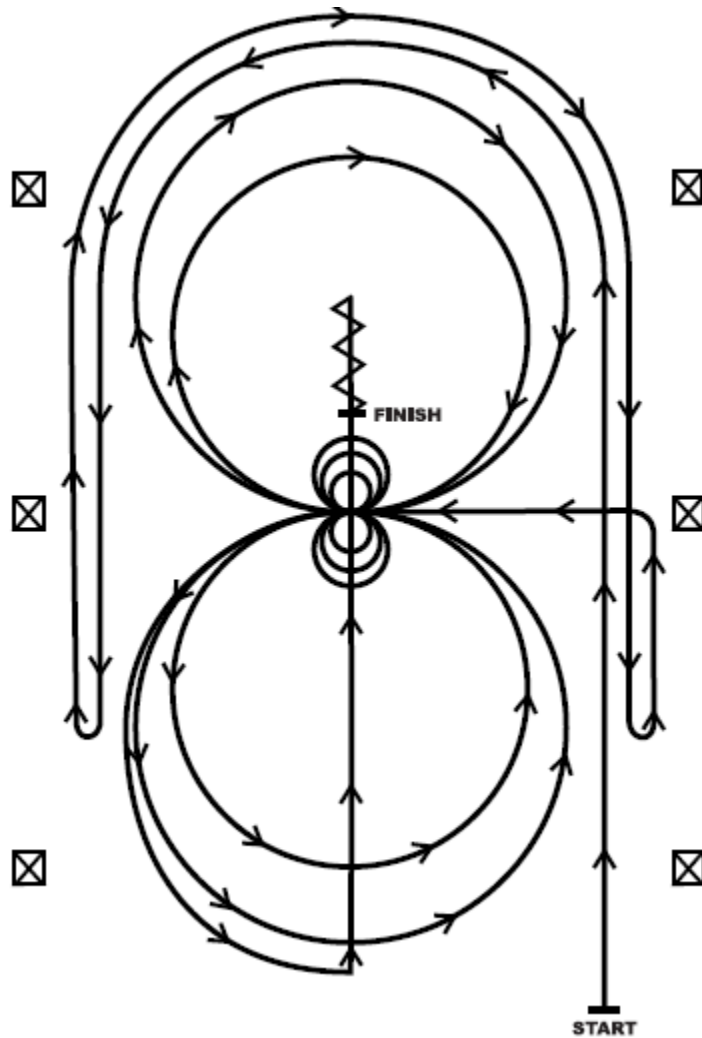

1. Beginning, lope straight up the right side of the arena, circle the top of the arena run straight down the opposite or left side of the arena past the center mark and do a right rollback—no hesitation.
2. Continue straight up the left side of the arena circle back around the top of the arena run straight down the right side of the arena past the center marker and do a left rollback—no hesitation.
3. Continue up the right side of the arena to the center marker, at the center marker the horse should be on the left lead and complete two circles to the left, one large fast and one small slow. Stop at center
4. Complete three spins to the left. Hesitate.
5. Complete two circles to the right, one large fast and one small slow. Stop at center.
6. Complete three spins to the right. Hesitate.
7. Begin a large fast circle to the left, do not close the circle. Continue up the center of the arena past the center marker and do a sliding stop.
8. Back up at least ten feet. Hesitate to demonstrate completion of the pattern.

11 SHOWMANSHIP AT HALTER

11.2 Showmanship

Showmanship is designed to judge the exhibitor's ability to present the horse. The Exhibitor uses the horse as a tool to display their ability to properly condition and show their horse. Exhibitors are judged on the fitting, grooming, training, and showing of their horses. It is recommended that the Judge(s) keep separate score cards for each exhibitor.

The pattern guidelines include:

- a. Leading the horse at a Walk, Flat Walk, or Back in a straight or curved line, or a combination of straight and curved lines.
- b. Stop; and turn 90 degrees ($\frac{1}{4}$), 180 degrees ($\frac{1}{2}$), 270 degrees ($\frac{3}{4}$), 360 degrees (full turn) or any combination or multiple of these turns.
- c. The pull turn is an unacceptable maneuver.
- d. The Judge must have exhibitors set the horse up for inspection sometime during the class, either in the pattern or during the lineup.

Horses shown in Saddle Seat attire may be Parked Out during inspection and line up, however the judge may ask the exhibitor to square up the horse for inspection. Horses shown in any other attire should be set up square for inspection and during line up. Show Managers may offer variations of the class, including advanced, novice, amateur, youth, etc. Show Managers may permit cross-entry in multiple classes.

11.3 General

- a. Showmanship classes should be divided according to the age of exhibitors.
- b. The horse's conformation is not to be considered in the judging of the class.
- c. The horse must be serviceably sound.
- d. Exhibitors must wear the correct attire and tack, either English or Western but not a combination of both.
- e. Whips are permitted with English attire only.
- f. Patterns are at the Judges' discretion and may be different for different age levels. If a pattern is used the exhibitors must be provided the opportunity to ask questions prior to the start of the class.
- g. Patterns must be posted at least one hour prior to the beginning of the class.

11.4 Attire, Tack & Equipment

The exhibitor shall present a neat, clean, well groomed, attentive, courteous look that is appropriate for the class. Either Western or English attire are permitted but not a combination of both and attire must match the tack.

Suitability of tack and attire, fit, and cleanliness will be considered. Properly worn ASTM/SEI approved headgear is strongly recommended in any and all events. For complete descriptions of attire, please refer to the NWA Rule Book Chapter 8.

11.4.1 English Attire

- a. The rider should choose a neat, well-fitted habit with accompanying accessories within the guidelines based on tradition and present-day customs.
- b. A traditional saddle suit must consist of matching coat and pants and is correct for both day and evening. Suggested colors include black, blue, grey, green, beige or brown with coordinated accessories. Vests should be worn and may either match or contrast with the habit color. The coat length should be at least three inches below the fingertips when standing. The jodhpurs should be long enough to rest on the rider's boot top.
 - Underpasses are not required to be worn.

- c. A matching or coordinated English riding hat A tie matching or coordinating with the suit color should be worn with an appropriate styled shirt. Boots should be of the English type in either calf or patent leather. Gloves and whips are optional.
- d. Spurs may not be worn.

11.4.2 Western Attire

- a. The rider should choose a neat, well-fitted Western style outfit with accompanying accessories within the guidelines based on tradition and present-day customs.
- b. A traditional Western outfit must consist of a Western styled, long-sleeve shirt with collar, Western style pants, Western cowboy hat and Western style boots.
- c. Western styled coats, vests and/or jackets are appropriate.
- d. Ties, bolos or scarfs may be worn.
- e. Gloves are optional.
- f. Spurs may not be worn.

11.4.3 Tack & Equipment

Clean and properly adjusted equipment should be used. Lead shanks (or ropes) should be 6-7 feet long. If a chain is used it should be adjusted so that the Exhibitor's hands do not touch the chain. The shank needs to be short enough to assure maximum control and responsiveness from the horse.

- Rope Halters are not permitted.

11.4.3.1 English Tack

- English show halter; chain on lead strap permitted (may be used over or under horse's nose).
- Arab-style cable halters are not permitted.

11.4.3.2 Western Tack

- Leather Halter; chain on lead strap permitted (may be used over or under horse's nose).
- Whips of any kind are not permitted.

11.4.4 Fitting and Grooming

The horse shall present a polished appearance. The bridle path should be clipped to approximately 4 inches behind the poll, as well as the long hair on the jaw, pasterns and legs. Manes and tails shall be groomed and clean and free of tangles.

Braids are acceptable for English attire and tack.

Braids are prohibited for entries showing in Western attire and tack.

The horse's feet should be trimmed and may be properly shod. The hooves should be clean. Clear hoof polish is optional.

11.4.5 Showing the Horse

Always lead from the left side at an alert Walk, following the Judge's directions. The length of the lead should not be so short as to interfere with free, natural movement of the animal or so long as to surrender control or permit a sloppy lead. Exhibitors must have the right hand on the lead when leading their horse. The left hand holds the remainder of the lead in one loose loop or in a figure-eight folded manner. The exhibitor should never hold the chain portion of the lead. Horses should Walk in a brisk, alert manner and give the appearance that the exhibitor and horse are a team.

Posing: Always keep the horse posed square or parked out depending on attire and tack. Know where the Judge is and what they want. Make it easy for the Judge to see the horse at its best advantage. Position the horse by the pressure on the lead. When posing the horse, stand toward the front, facing the horse at a 45 degree angle, but never directly in front of the horse. Always be in a

position where you can observe your horse and keep an eye on the judge. The Quarter Method is the suggested method of showmanship.

11.4.6 Faults

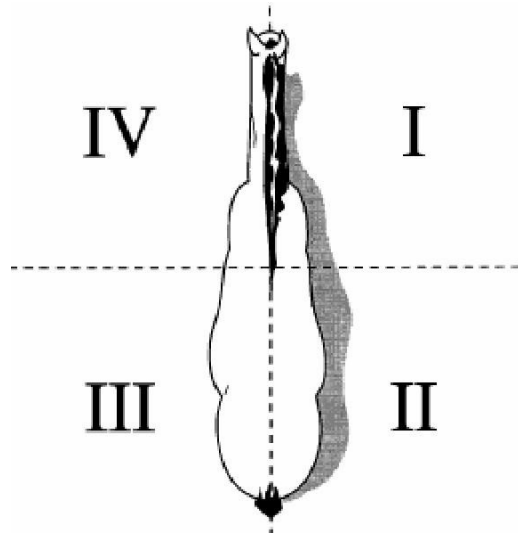

| | |
|---|--------|
| <p>sing the quarter method, when the Judge comes to quadrant I, the handler should be in V. As the judge moves to II, the handler moves to I. When the Judge moves to III, the handler moves to IV. As the Judge moves up the horse to IV, the handler returns once more to Quadrant I.</p> | U I |
|---|--------|

Minor faults

- Breaking the gait at the Walk or Flat Walk for one stride.
- Using an ill fitted halter.
- Lifting a pivot foot and replacing in same place or sliding the foot.

Major faults

- Not performing gait or not stopping within 10 feet of designated area.
- Breaking the gait at the Walk or Flat Walk for more than one stride.
- Crossing to the wrong side of the cone.
- Not remaining alert and watching the Judge for instructions.
- Stepping out of or moving the hind end significantly during a pivot or turn.
- Allowing the horse to remain out of position.

Severe faults

- Moving to the offside of the horse and remaining out of position.
- Using your feet to move the horse's feet.
- Pushing the horse with your hands or using your hands to place the horse's feet and legs.
- Standing directly in front of your horse.
- Loud voice commands to your horse or other unnecessary actions.
- Holding your hand on the chain of the lead shank.
- Failure of the horse to lead properly.
- Not wearing the correct number in a visible manner.
- Over-turning more than ½ turn of designated turn.

11.4.7 Disqualifications

- Loss of control of the horse.
- Willful abuse, excessive schooling/training.
- Knocking over the cone or going off pattern.
- Never performing a specific gait.

11.4.8 Additional Tests (as requested by judge)

- a. The judge may question exhibitors. The same question must be asked of each exhibitor.
- b. Walk horse to and from the judge.
- c. Back the horse.
- d. Reverse the horse.
- e. Pick up horse's hoof or hooves.
- f. Move to a different spot in line.

11.4.9 Judging

- 50% Exhibitor's method of showing.
- 20% Exhibitor's attire and equipment.
- 30% Horse's Fitting and Grooming.

12 SPEED EVENTS

12.2 Barrel Racing

Barrel Racing is a timed event in which the horse and rider execute a clover-leaf pattern around three barrels. The horse/rider team who completes the pattern in the shortest time wins. In the event of a tie, the tied horse/rider teams have a run-off. The fastest time in the run-off is declared the winner of that placing, and the second horse moves to the next lower placing.

12.2.1 Tack and Equipment

Western attire and equipment is required. Properly worn ASTM/SEI approved headgear is highly recommended for the exhibitor in any and all events and shall not be penalized. All youth riders must wear ASTM/SEI-approved helmets. Exhibitors must wear a hat or helmet when entering the ring. "Stampede Strings" may be used. Baseball caps ARE NOT permitted. A 5 second penalty will be assessed if the hat or helmet is not on the exhibitor's person the entire time they are in the arena. For complete descriptions of Western tack and attire, please refer to the NWAHA Rule Book Chapter. Martingales, tie-downs, protective boots, and polo wraps are permitted. Hackamores (including mechanical hackamores) and bosals are permitted. Whips, crops, or bats are prohibited. Draw reins are prohibited.

12.2.2 The Pattern

The barrel distances for a standard size arena (130 ft. wide by 200 ft. long) are as follows:

From the starting line to the 1st and 2nd barrels the distance is 60 feet.

The distance between the first and second barrels is 90 feet,

The distance from the 1st and 2nd barrels to the 3rd barrel is 105 feet.

The course must be measured exactly. However, if the course is too large for the available space, the pattern should be reduced five yards at a time until the pattern fits the arena. It is not necessary to move barrel #3 closer to the start/finish line in this case. When measuring the area for the course, allow ample room for the horses to complete their turns and stop at the finish.

Barrels must not be placed within 15 feet of any obstacle. Maintain a distance of at least 18 feet

from each barrel to the rail. It is recommended there be at least 45 feet from the starting line to the end of the arena. 55 gallon drums with both ends intact should be used.

Barrel patterns may be run either to the right or left, at the discretion of the exhibitor.

At a signal from the starter, the exhibitor will run to the first barrel, complete an approximate 360 degree turn around it, go to barrel number two, complete an approximately 360 degree turn around it, and then proceed to the last barrel, another approximate 360 degree turn around it, and sprint to the finish line.

In a right-hand pattern, the horse enters in the middle, turns right to go around barrel #1 (near barrel #1 but between barrels #1 and #3), comes across the arena and turns left around barrel number 2 (near barrel #2 but between barrels #2 and #3), and then proceeds through the middle of the arena to turn left again around barrel #3 (going near barrel #3 but between Barrel #3 and Barrel #1) before sprinting to the finish line.

In a left-hand pattern, the horse enters in the middle, turns left to go around barrel #2 (near barrel #2 but between barrels #2 and #3), comes across the arena and turns right around barrel number 1 (near barrel #1 but between barrels #1 and #3), and then proceeds through the middle of the arena to turn right again around barrel #3 (going near barrel #3 but between Barrel #3 and Barrel #2) before sprinting to the finish line.

12.2.3 Timing

Starting line markers or electric timers (when possible) shall be placed against the arena fence. An electric timer or at least two stop watches shall be used, with the time indicated by the electric timer or an average time of the watches used by the official timers to be the official time.

Timing shall begin as soon as the horse's nose reaches the starting line and will stop when the horse's nose reaches the finish line. The exhibitor is allowed a running start from inside the arena after the gate is closed. Horses shall not be allowed to run out of the arena after the pattern is complete.

12.2.4 Penalties

- a. Knocking over a barrel – five (5) seconds. Exhibitors may touch the barrel with their hands to prevent it from tipping.
- b. Hat or helmet is not on the exhibitor's person for the entire time the Exhibitor is in the arena – five (5) seconds.

12.2.5 Disqualification

- Failure to follow the course.
- Use of illegal tack or equipment.
- Using the ends of the reins to whip the horse.
- Fall of horse or rider.
- Breaking the time barrier prior to completing the course or breaking the barrier a second time after completing the course.

12.2.6 Barrel pattern

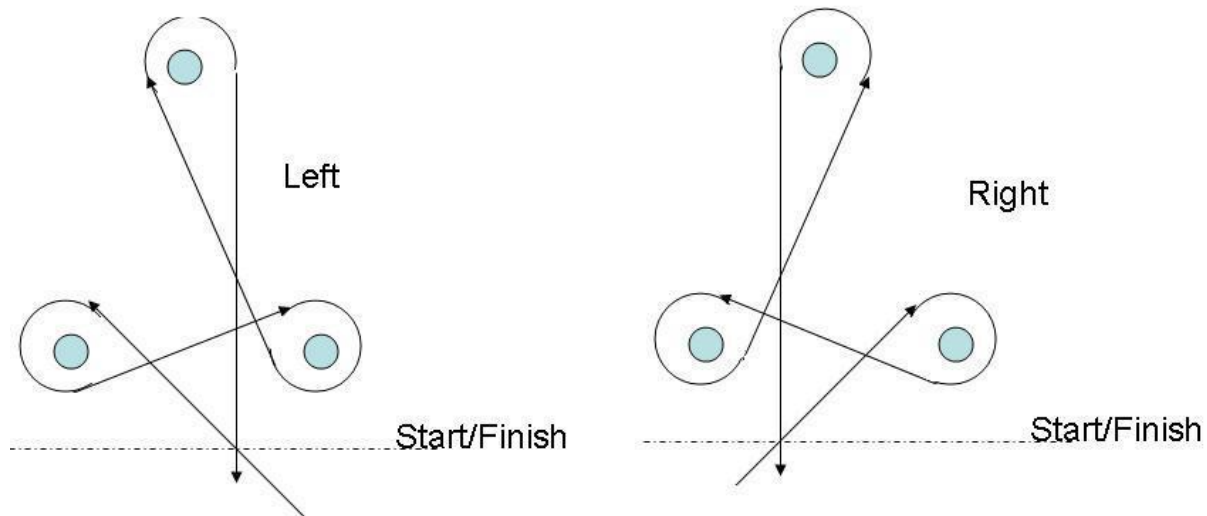

Reproduced with permission of the American Quarter Horse Association

12.3 Pole Bending

Pole Bending is a timed event in which the horse and rider execute a serpentine pattern around six poles spaced twenty-one (21) feet apart. The horse/rider team who completes the pattern in the fastest time wins. In the event of a tie, the tied horse/rider teams have a run-off. The fastest time in the run-off is declared the winner of that placing, and the second horse moves to the next lower placing.

12.3.1 Tack and Equipment

Western attire and equipment are required. Properly worn ASTM/SEI approved headgear is highly recommended for the exhibitor in any and all events and shall not be penalized. Youth riders must wear ASTM/SEI-approved safety helmets. Exhibitors must wear a hat or helmet when entering the ring. "Stampede Strings" are permitted. Baseball caps ARE NOT permitted. A 5 second penalty will be assessed if the hat or helmet is not on the Exhibitor's person the entire time they are in the arena. For complete descriptions of Western tack and attire, please refer to the NQHA Rule Book Chapter 8.

- Whips, crops, or bats are prohibited.
- Martingales, tie-downs, protective boots, and polo wraps are permitted.
- Hackamores (including mechanical and non-mechanical) and bosals are permitted.

12.3.2 The Pattern

The poles must be placed in a straight line, with 21 feet between each pole and 21 feet from the first pole to the start/finish line. The course must be measured exactly. Assure that the distance between the last pole and the end of the arena is at least 30 feet to allow ample room for the horses to complete their turns.

12.3.3 Timing

Starting line markers or electric timers shall be placed against the arena fence. An electric timer or at least two stop watches shall be used. The official time is the time indicated by the electric timer or an average time of the watches used. The start/finish line must be clearly marked.

Timing begins when the horse's nose reaches the starting line and stops when the horse's nose reaches the finish line. The exhibitor is allowed a running start from inside the arena after the gate is closed. Horses shall not be allowed to run out of the arena after the pattern is complete.

Pole bending patterns may be run either to the right or left, at the discretion of the exhibitor. At a signal from the starter, the exhibitor will run to the last pole at the far end of the arena, complete an approximate 180 degree turn around it. The competitor then serpentines through the poles, alternating left and right.

When the competitor gets to the first pole, they complete an approximate 180 degree turn around it, and serpentine back through the poles to the far end of the arena. After the last pole, the competitor turns 180 degrees toward "home", and sprints to the finish line.

12.3.4 Penalties

- Knocking over a pole – five (5) seconds.
- A Contestant may touch a pole with his or her hand. If original course is altered by a Rider intentionally grasping a pole then a five second penalty will be assessed.
- Hat or helmet is not on the Exhibitor's person for the entire time the exhibitor is in the arena – 5 seconds.

12.3.5 Disqualification

- Failure to follow the course.
- Use of illegal tack or equipment.
- Using the ends of the reins to whip the horse.
- Fall of horse or Rider.
- Breaking the time barrier prior to completing the course or breaking the barrier a second time after completing the course.

12.3.6 Pole Bending Diagram

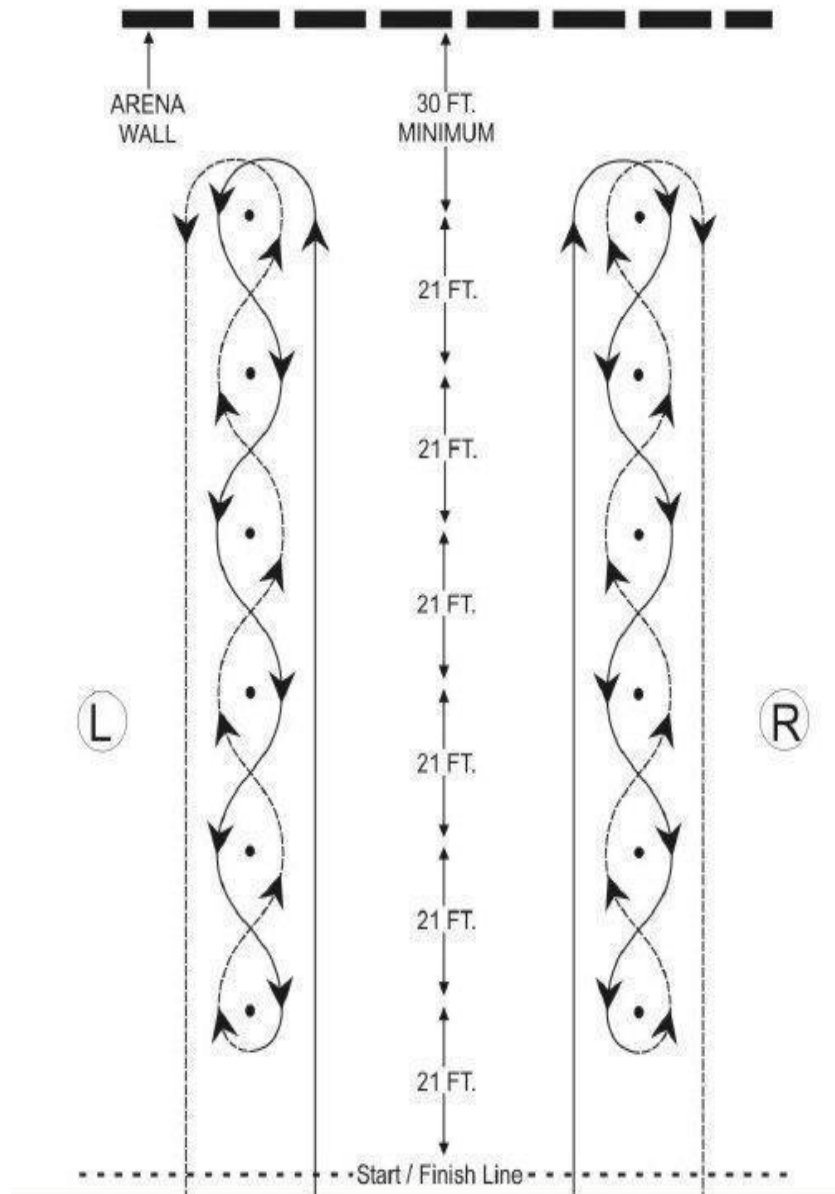

13 TRAIL OBSTACLE

13.2 General

The trail horse is required to work over and through obstacles which might be found during a normal day on the range or trail ride. A good trail horse gives the impression of being a pleasure to ride out and negotiate any obstacle on a trail ride. It can maneuver through a course of obstacles quietly, obediently, with physical skill and a good attitude. It should travel through and between obstacles in a forward manner without compromising its calm, relaxed attitude and way of going. It should approach each obstacle with authority yet maintaining its willingness to obey the rider with no apparent resistance. Ultimately, the trail horse is skillful, confident, and leaves one with the impression of being sane, safe, sure and a pleasure to ride over any piece of ground for a trail ride.

13.3 Class Specifications

- a. Exhibitors perform a course over and through obstacles on a reasonably loose rein. Exhibitors are judged on performance and way of going, with emphasis on manners. Exhibitors perform a course over and through at a Walk, Flat Walk or Slow Gait, Running Walk or Fast Gait, Canter or Lope, depending on the difficulty of the class.
- b. Rider's hands shall be clear of horse.
- c. Competitors may use English or Western tack and attire but not a combination of both. For complete descriptions of tack and attire, see NWAHA Rule Book Chapter 8.
- d. Exhibitors are penalized for any unnecessary delay while approaching obstacle. If a horse takes excessive time at an obstacle, the judges are encouraged to advance it on to next obstacle.
- e. Obvious unsoundness must be disqualified with no prize awarded.
- f. No time outs will be allowed.
- g. In western attire, the exhibitor must hold reins in one hand and may not change hands during the performance. **Exception:** Five year old and under may be reined in a bosal or snaffle, but the rider must use two hands on the reins.
 - Exception - Hand may be changed when:
 - putting on or removing a slicker.
 - carrying an object from one part of the arena to another.
 - working the gate.
- h. The course will include a minimum of six and a maximum of ten obstacles.
- i. If at any time a trail obstacle is found to be unsafe, it shall be repaired or removed from the course. If it cannot be repaired and horses have completed the course, the score for that obstacle shall be deducted. No horse shall be asked to repeat the course.
- j. Show Managers may offer variations of the class, including novice, youth, amateur, etc. Show Managers may permit cross-entry into both classes.

13.4 Course Design

Trail obstacles should be designed with safety in mind to prevent accidents and injury. If there is spacing between obstacles, it should allow exhibitors to Flat Walk at least 30 feet or Lope at least 50 feet. If the horse performs the Trail Walk between obstacles, there is not a minimum distance between them. The course must consist of at least six obstacles. All obstacles should be safe and in good condition. Courses should be a resemblance to obstacles and occurrences which may occur on the trail. It is recommended that on the pattern each trail obstacle be numbered to reflect its position in the pattern.

13.4.1.1 *Inspection of the course*

- Exhibitors will be allowed to walk and inspect the course (without horse) prior to the start of the class.
- Exhibitors shall alert show management or the judge prior to the beginning of the class if they find any unsafe obstacle.
- No horse may enter the trail course area until the course and the Judge are ready.

The Judge must walk the course and has the right and duty to alter the course in any manner. The Judge may remove or change any obstacle deemed unsafe or non-negotiable. If at any time a trail obstacle is deemed to be unsafe by the Judge, it shall be repaired or removed from the course. If it cannot be repaired and horses have completed the course, the score from that obstacle shall be deducted from all previous works for that class.

-

13.5 Maneuvers & Obstacles

All elevated walk-over or low jump poles must be set in a standard jump cup or similar type bracket. The Judge has the right to alter the course.

b. Suggested dimensions of trail obstacles:

- WALK OVERS: Minimum height 4 inches; Maximum height 12 inches.
- Spacing between logs or poles:
 - Walk Over: 22 inches – 26 inches.
 - Elevated Walk Over: 22 inches.
- LOPE OVERS: 7 feet - 8 feet.
- BACK THROUGHs: May be on the ground, elevated, or the use of barrels or cones. The back through chute must have a minimum width of 30 inches. Required turns (such as backing through an “L”) will require a wider distance between the sides.
- GATE: approximately 60 inches high with latch available at that height.
- Any other maneuvers should figure horse's total length at about eight feet from nose to tail.

13.5.1 Mandatory Obstacles

- Navigate through a safe gate. Gates may be a regular gate or a rope gate.
- Ride over at least four (4) logs or poles. May be in a straight line, zigzag, curved, or raised.
- Back through and/or around at least 3 markers such as barrels, poles or cones. Back throughs can be L, V, U, straight or similar shaped courses.

13.5.2 Optional Maneuvers & Obstacles

- Groups of logs and brush put together to make it a pile and horse must Walk through.
- Backing around barrels or through poles on the ground.
- A line where the horse has to weave through like pole bending with the trees close together.
- Walking forward on the bridge, backing down the bridge.
- Box of poles where a turn on the haunches must be completed inside the box.
- Dismount, ground tie, Walk around the horse, and return.
- Sidepass a pole: may be elevated to 12 inches maximum, but may not have uprights on either side.
- Carrying objects.
- Put on and remove slicker.
- Remove and replace materials from mailbox.
- Any safe and negotiable obstacle which could reasonably be encountered on a trail ride and meets the approval of the Judge.
- A combination of two or more of any obstacles is acceptable.
- Bridges: must be a minimum of 36 inches wide and at least 6 feet long. Bridge should be sturdy, safe and negotiated at a walk only;
- Tarps, provided that they are secured by poles, flower boxes, or other means, so that they will not blow or drag.

Obstacles not listed may be used as long as they are not prohibited and may reasonably be expected to be encountered on a trail work.

13.5.3 Prohibited Obstacles

- Logs/poles elevated in a manner that permits them to roll.
- Flames, noise, dry ice, fire extinguisher.
- Hides.

- Jumps or poles over 12 in. in height.
- Rocking/moving bridges.
- Tires.
- Water box with moving/floating objects.
- Animals.

13.6 Judging

It is recommended that the Judge(s) keep separate cards for each exhibitor.

13.6.1 Penalties

Minor Faults

- Ticks/rubs on obstacle.
- Chewing on bit.
- Tail wringing.
- Too fast/slow.

Major Faults

- Falling/stepping off bridge.
- Knocking over markers.
- Losing the gate.
- Breaking gait.
- Refusals. A refusal is any action taken by the horse to avoid performing an obstacle, part of a combination of obstacles or portion of a trail course.
- Stepping outside markers during turns, side passes or backing.
- Wrong lead, corrected prior to completion of the Lope.

No Score on an Obstacle

- Working an obstacle differently than noted on the pattern.
- Attempting, but not completing an obstacle.
- Not in the posted gait or correct lead.
- Third refusal: Disqualification.
- Not working obstacles in posted order (“off course”)*.
- More than one finger between reins, except when changing hands to work an obstacle.
- Major disobedience (rearing, schooling, etc.).
- Touching in front of cinch.
- Fall of horse or rider.
- Illegal equipment.
- Abuse of horse.
- In western tack, use of two hands or changing hands on reins except where permitted as described above (except for junior horses ridden in a bosal or snaffle).
- Equipment failure that delays competition of pattern.
- Riding outside designated boundary marker of the course.

* Off Course is defined as not following the drawn pattern by taking an obstacle in the wrong direction, wrong side, or wrong sequence, or skipping an obstacle unless directed by the Judge.

13.6.2 Scoring

Scoring will be on the basis of zero to infinity, with 70 denoting an average performance. Each obstacle will receive an obstacle score and may also be subject to a penalty.

Each obstacle will be scored as follows:

- (-1 ½) Extremely poor
- (-1) Very poor
- (- ½) Poor
- 0 Correct
- (½) Good
- (+1) Very good
- (+1 ½) Excellent

Obstacle scores are to be determined and assessed independently of penalty points. Should a tie occur after all contestants have performed, two methods may be used to break the tie. Over-all attitude, manners, and style score may be used as a tie-breaker. In addition to the obstacle scoring, scored gaits can also be used in placing a class.

13.6.2.1 Penalty points

(-½) Point

- Each tick of log, pole, cone or obstacle

(-)1 Point

- Each hit of or stepping on log, pole, cone or obstacle.
- Break of gait at Walk, Flat Walk, Running Walk or Canter/Lope for two strides or less.
- Skipping over or failing to step into required space.
- Split pole in Canter/Lope over.

(-3) Points

- Break of gait for more than 2 strides
- Out of lead or break of gait at canter/lope (except when correcting an incorrect lead)
- Knocking down an elevated pole, cone, barrel, plant obstacle or severely disturbing an obstacle.
- Stepping outside the confines of, falling or jumping off or out of an obstacle with one foot.

(-5) Points

- Dropping object required to be carried on course.
- First refusal, balk, or attempting to evade an obstacle by shying or backing more than 2 strides away.
- Letting go of gate or dropping rope gate.
- Use of either hand to instill fear or praise.
- Stepping outside the confines of, falling or jumping off or out of an obstacle with more than one foot.
- Blatant disobedience (kicking out, bucking, rearing, striking).
- Second refusal, balk or attempting to evade an obstacle by shying or backing more than two strides away.

13.7 In-Hand Trail Obstacle

The In-Hand trail horse gives the impression of being able to negotiate any obstacle in-hand on a trail ride. It can maneuver through a course of obstacles quietly, obediently, with physical skill and a good attitude. It should travel through and between obstacles in a forward manner without compromising its calm, relaxed attitude and way of going. It should approach each obstacle in a round relaxed frame looking down on approach in a thinking manner viewing the

needs required of it to begin and complete the obstacle with no apparent resistance. The in-hand trail horse is skillful, confident and safe.

13.7.1 Class Specifications

- Competitors may use English or Western tack and attire but not a combination of both.
- Horse shall be shown in a halter.
- No crop, whip, chaps, chinks or spurs allowed.
- The horse shall be led using the right hand. Excess lead should be held loosely, looped in the left hand.

13.7.2 Exhibitor Requirements

Exhibitor must use only the right hand on the lead where the chain begins, and lead on the horse's left side. A chain may be used under the chin or hanging from the halter.

Exhibitor must use only the left hand to carry the excess lead, looped loosely **except** when:

- a. Carrying an object from one part of the arena to another.
 - b. Dragging an object from one part of the arena to another.
 - c. Opening/closing a gate, left hand gate only. In these cases, the right hand can also carry the excess lead.
 - d. Side-passing. In this case, the lead at the chain and the excess lead can be held in the hand at the horse's head.
1. Exhibitors should be poised, confident, courteous and sportsmanlike at all times. The exhibitor should continue showing the horse until the class has been placed or excused.
 2. Any stops should be straight, smooth and responsive with the horse's body remaining straight. Backing and turning should be performed from the left side of the horse. The exhibitor should face the horse when backing. Exception: When negotiating a gate, the exhibitor is not required to face the horse. The horse should back up readily with the head, neck and body aligned in a straight or curved line as instructed.
 3. When executing a turn to the right, the exhibitor should face the horse and move the horse away from them. On turns of less than 90 degrees, it is acceptable to lead the horse toward them. On turns of 90 degrees or greater, the horse should pivot on the right or left hind leg while stepping across with the front legs.
 4. The exhibitor should be positioned at the horse's left shoulder while leading. Obstacles are performed by sending rather than dragging or pulling the horse.
 5. The horse should move forward as directed, correctly and smoothly. When backing, the exhibitor may turn and face the horse.
 6. Stops should be smooth with the horse's body straight.

13.8 Judging

Judges should consider the overall appearance of the horse, conditioning and grooming, as well as the equipment (dirty, ill-fitting or ragged equipment) in their overall scores. Also, to be considered is the correctness of the horse while being led.

Drifting to the side, leading or stopping crooked, failure to maintain a pivot foot in a turn, leading or turning sluggishly should be considered and evaluated in the horse's maneuver scores and reflected in his overall score.

Exhibitors should be discouraged from excessive verbal cues and excessive stiff or unnatural

movements around horse or when leading. For safety reasons, those handlers continuously holding the chain on the lead, tightly coiling the lead shank around their hand, or dragging the lead shank should be penalized.

13.8.1 Scoring & Penalties

Scoring & Penalties are covered in Trail Obstacle as applicable and are addressed in sections 11.5.2 and 11.5.2.1 in addition to the following:

The exhibitor will be penalized utilizing the obstacle scoring guidelines for the following:

- Blatant disobedience of the horse to include kicking, bucking, rearing, circling the exhibitor.
- Changing hands except when necessary to side pass to the right.
- Dragging the horse.
- Holding the horse tightly and/or by the chain on the lead rope.
- Excessive verbal and/or physical praise or correction.
- Touching the horse.
- Failure to demonstrate correct gait.
- Horse becomes loose from exhibitor.
- Leading from the wrong side.

14 WATER GLASS

14.2 Water Glass

Each contestant rides their mount while carrying a cup of water. Exhibitors perform at the discretion of the Judge. The rider who has the most water at the end wins.

14.3 Tack and Equipment

Either English or Western tack is appropriate for the class. Refer to the NWHHA Rule Book, Chapter 8 for more information on acceptable equipment. Martingales, tie-downs, and boots of any kind are prohibited.

14.4 General Rules

Exhibitors will enter the ring and will receive a glass of water. Glasses must not exceed five (5) inches tall. Water may be “topped off” after the rider receives the glass, but before the class begins. Exhibitors will ride to the rail and perform at the discretion of the Judge. The Judge may ask for the Walk, Flat Walk, Running Walk, Halt, Back, and turns. The Judge may ask for the Canter/Lope in the event of a tie. A noted change of gaits is required when the Flat Walk and Running Walk are called or the Judge will disqualify exhibitor. The Judge may also call for the extending of the arm holding the water glass out to the side, above the Exhibitor’s eye level or above the shoulder. The Judge may also call for switching hands. Small circles either in the Flat Walk or Running Walk or other patterns may be called. A Trail Walk may be called or other maneuvers such as Backing, turn on the forehand or haunches. The Judge may request that Exhibitors drop their stirrups.

When Exhibitors are called to the lineup, they will relinquish their cups to the Judge or his/her designee for judging.

14.5 Scoring

Glasses may be weighed, measured with a ruler, or measured by eye. Generally, weight is the most accurate determination. Other measurements often result in ride-offs. The rider with the most water in their glass wins, and the next most second, etc. In case of a tie at any placing, the Judge may call for a ride-off. In this case, the same glasses are returned to the Exhibitors who will ride-off, and they continue with the amount of water that they had prior to judging.

14.6 Disqualification

- Hand or fingers may not cover the top of the glass at any time.
- Failure to Canter/Lope when called.
- Failure to change gait when called.
- Standing in the stirrups with the seat clear of the saddle.

15 WESTERN RIDING

15.2 General

In Western Riding, the horse exhibits responsive lead changes at the Lope, manners, and a confident disposition. Emphasis is placed on smoothness and the horse's ability to change leads precisely. The horse should have a relaxed appearance. The horse should cross the log without breaking gait or radically changing stride. Show Managers may offer variations of the class including but not limited, Novice, Amateur, Youth or Open. Show Managers may permit or bar cross-entry into multiple variations of the class.

Simple lead changes and riding with two hands is permissible in Novice Western Riding, as determined by Show Management. Show Management may permit simple lead changes in any class but must be declared and posted either on the show bill or on the selected pattern at least 1 hour before the class.

15.2.1 Patterns

One of the four patterns as provided herein shall be performed. Reference Section 13.4.

- Markers should be separated by at least 30 feet but not more than 50 feet on the sides with 5 markers.
- Markers must be a minimum of 15 feet from the fence and with 50 to 80 feet width in the pattern, as the arena permits.
- A solid log or pole should be used and be a minimum of 8 feet in length.

15.3 Tack and Equipment

Western tack and attire are required. Properly worn ASTM/SEI approved headgear is recommended for Exhibitors in any and all events and shall not be penalized. For complete descriptions of Western tack and attire, please refer to the NWAHA Rules Rule Book Chapter 8.

- Protective boots and polo wraps are permitted.

15.4 Scoring

Exhibitors shall be scored on a basis of 0-100 with 70 denoting an average performance. Points will be added or subtracted from the maneuvers as follows:

| | | |
|-----------------------|----------------|------------------|
| (-1.5) Extremely poor | 0 Average | (+1.5) Excellent |
| (-1) Very poor | (+0.5) Good | |
| (-0.5) Poor | (+1) Very good | |

Maneuver scores are to be determined independently of penalty points. The following characteristics are considered faults and should be judged accordingly in maneuver scores:

- Opening mouth excessively.
- Anticipating signals.
- Stumbling.

Credits:

- Changes of leads, hind and front simultaneously.

- Change of lead near the center point of the lead change area.
- Accurate and smooth pattern.
- Even tempo throughout.
- Easy to guide and control with rein and leg.
- Manners and disposition.

15.4.1 Penalty Points

A contestant shall be penalized each time any of the following occur:

Five (5) points

- Wrong lead beyond the next designated change area (failure to change leads includes cross- cantering).
- Each failure to change results in an additional five-point penalty.
- Kicking out, biting and bucking.

Three (3) points

- Not performing the specific gait or stopping when called for within 10 feet of the designated area.
- Simple change of leads.
- Additional lead changes anywhere in pattern (except when correcting an extra change or incorrect lead).
- Break of any gait for more than two strides.

One (1) point

- Hitting or rolling log.
- Wrong lead more than one stride either side of the center point and between the markers.
- Splitting the log (log between the two front or two hind feet) at the Lope.

One-half (0.5) point

- Tick or light touch of log.
- Lead change not synchronous (Front to hind or hind to front).

15.4.2 Disqualification

- Illegal equipment.
- Willful abuse.
- Off course.
- Knocking over markers.
- Missing log.
- Major refusal.
- Major disobedience - rearing, etc.

15.5 Accepted Patterns

**Reproduced with permission of the American Quarter Horse Association.*

WESTERN RIDING PATTERN I

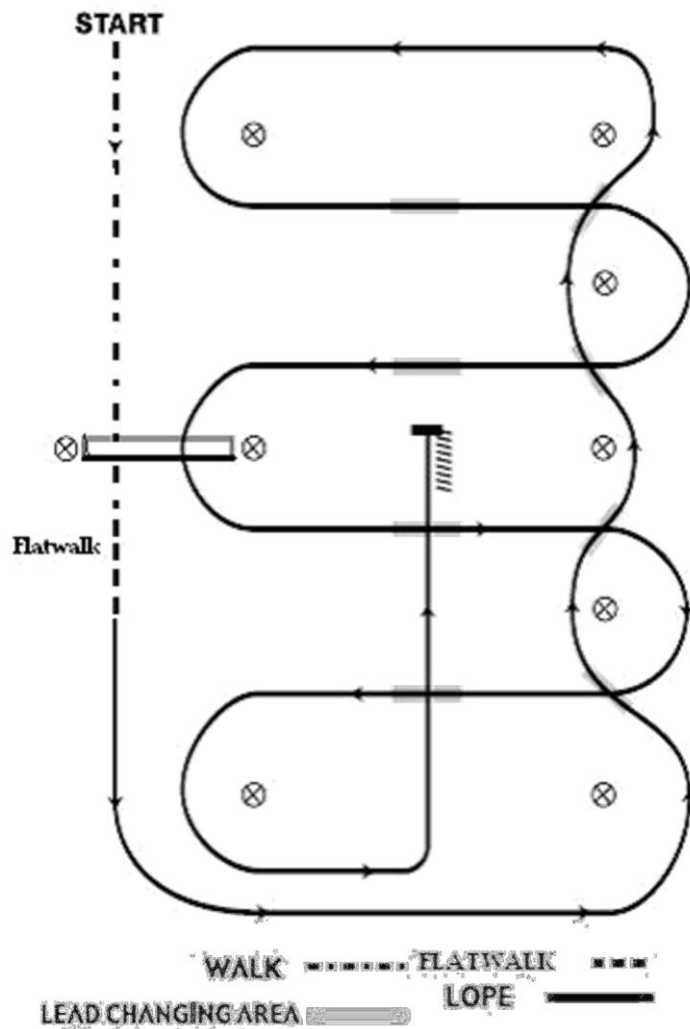

1. Walk at least 15' & walk over log, transition to Flat Walk
2. Transition to left lead & Lope around end
3. First line change
4. Second line change
5. Third line change
6. Fourth line change lope around the end of arena
7. First crossing change
8. Second crossing change
9. Lope over log
10. Third crossing change
11. Fourth crossing change
12. Lope up the center, Halt & Back

WESTERN RIDING PATTERN 2

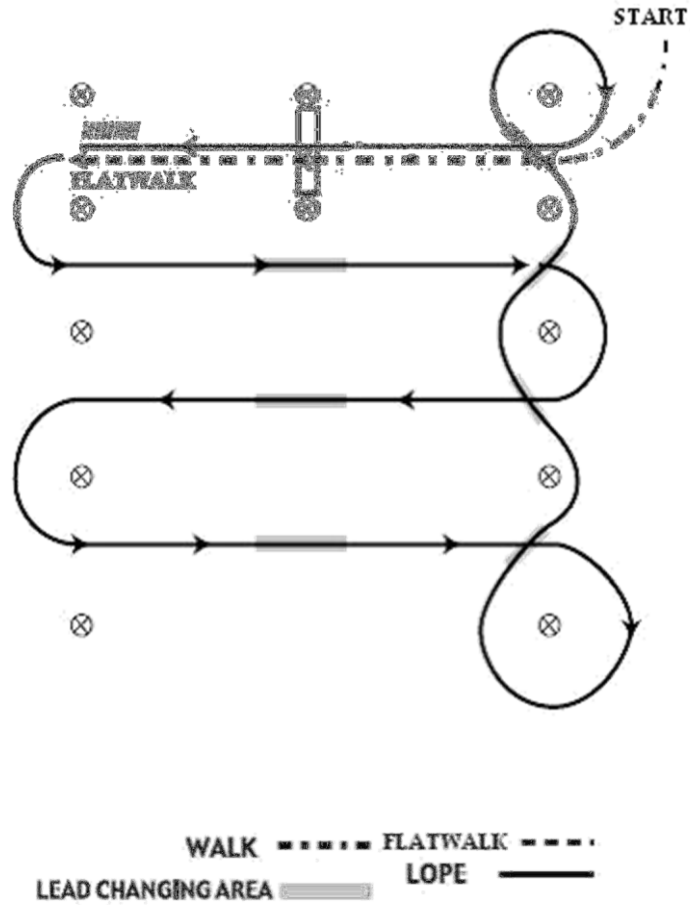

1. Walk over log, transition to Flat Walk
2. Transition to the Lope, on the left lead
3. First crossing change
4. Second crossing change
5. Third crossing change
6. Circle & first line change
7. Second line change
8. Third line change
9. Fourth line change & circle
10. Lope over log
11. Lope, Halt & Back

WESTERN RIDING PATTERN III

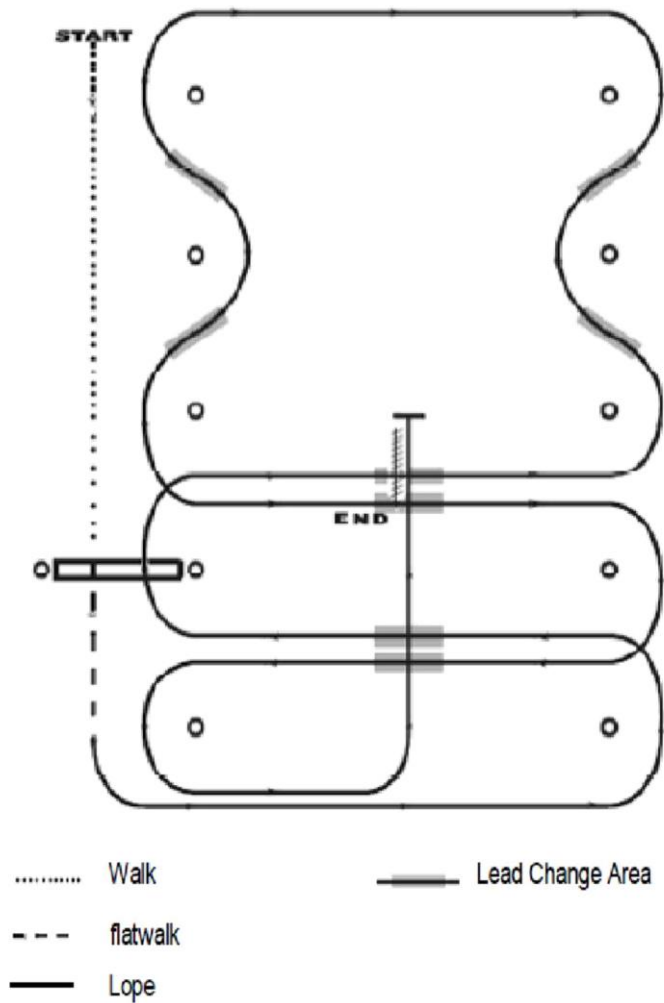

1. Walk over log, transition to Flat Walk
2. Transition to the Lope, on the left lead
3. First crossing change
4. Lope over log
5. Second crossing change
6. First line change
7. Second line change
8. Third line change
9. Fourth line change
10. Third crossing change
11. Fourth crossing change
12. Lope up the center, Halt & Back

WESTERN RIDING PATTERN IV

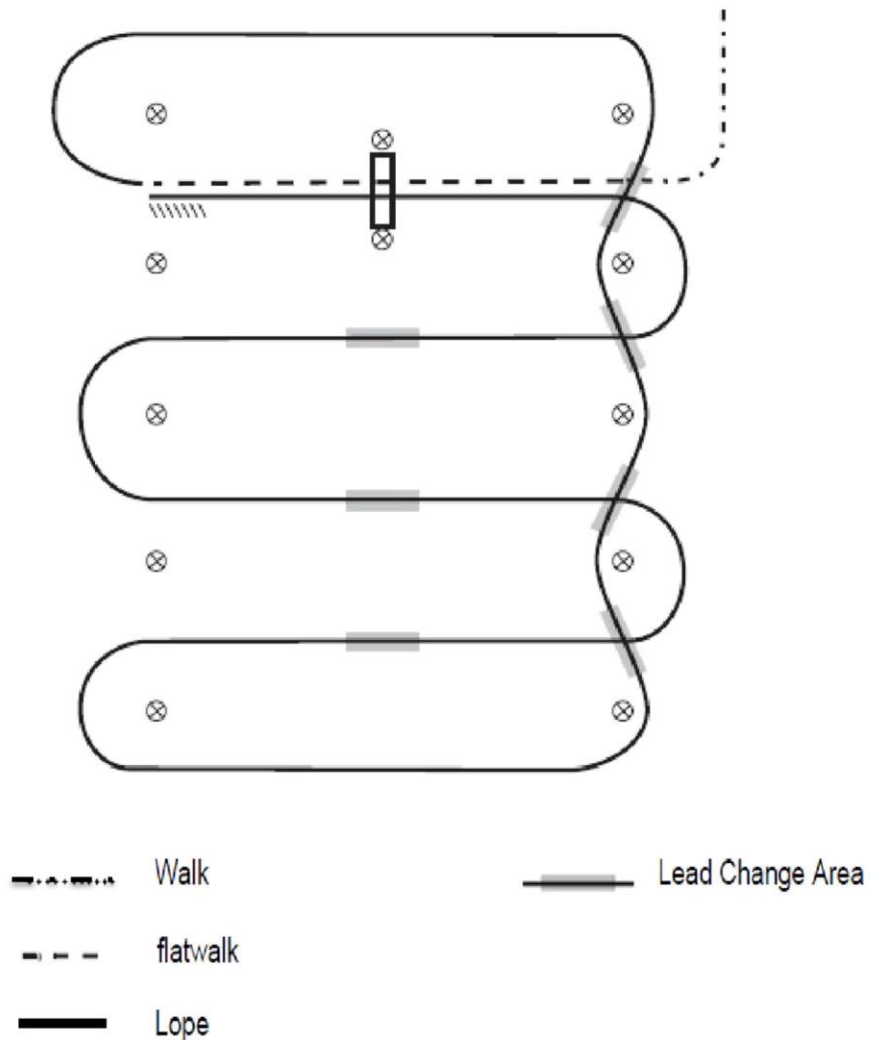

3. Enter at a Walk, transition to Flat Walk. Flat walk over log
4. Transition to the Lope, on the right lead
5. First line change
6. Second line change
7. Third line change
8. Fourth line change
9. First crossing change
10. Second crossing change
11. Third crossing change
12. Lope over log
13. Lope, Halt & Back