

# 2023

## Illustrated Price List

Effective April 1, 2023

USA

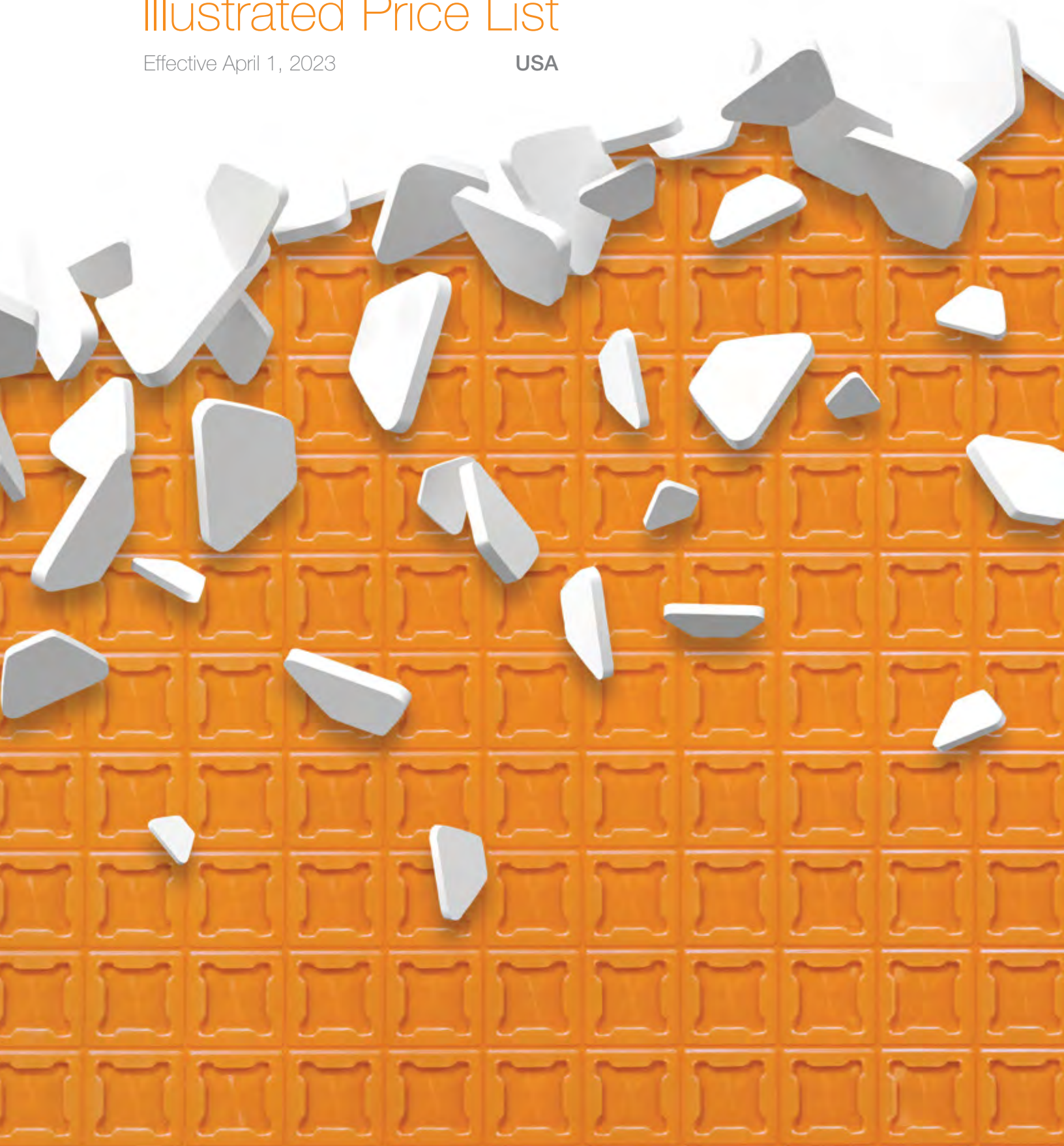



Dear Tile Professional,

Constant development of innovative solutions for ceramic tile and natural stone installations is the cornerstone of our tradition at Schluter. The Illustrated Price List, which you hold in your hands, features new and improved products that reflect that tradition.









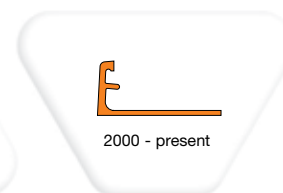
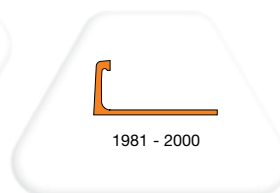
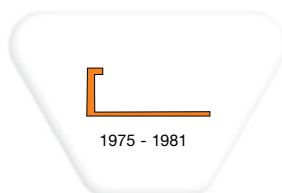





A perfect example is Schluter®-SCHIENE, which became the foundation of Schluter's success in 1975. In our tradition of innovation, the simple right-angle profile has since evolved to include an integrated joint spacer. Often, small details result in large advantages for the installer. In this case, the integrated joint spacer makes tile setting easier and cleaner. Gradually, all of our products will be equipped with this feature.

To a large degree, Schluter®-Systems owes its position as market leader to you, our industry partner. Your input has helped us improve on the function, aesthetic appeal, and safety of our products. Hence, we will keep our ear to the market, so that we may continue to deliver high quality, professional products to specifiers and architects, distributors and dealers, contractors and owners.

Sincerely,

**Werner Schlüter**



	<b>Product Overview</b>	<b>4 - 11</b>
	<b>Finishing, edge-protection, &amp; transition profiles for floors</b>	<b>12 - 21</b>
	<b>Finishing &amp; edge-protection profiles for walls &amp; countertops</b>	<b>22 - 59</b>
	<b>Stair-nosing profiles</b>	<b>60 - 70</b>
	<b>Movement joint &amp; cove-shaped profiles</b>	<b>71 - 91</b>
	<b>Profiles for resilient floor &amp; wall coverings</b>	<b>92 - 96</b>
	<b>Waterproof substrates &amp; building panels</b>	<b>97 - 104</b>
	<b>Waterproofing &amp; uncoupling membranes</b>	<b>105 - 111</b>
	<b>Removable fleece</b>	<b>112 - 113</b>
	<b>Electric floor warming system</b>	<b>114 - 121</b>
	<b>Shower system</b>	<b>122 - 171</b>
	<b>Modular screed system for conventional &amp; radiant-heated screeds</b>	<b>172 - 174</b>
	<b>Setting materials</b>	<b>175 - 178</b>
	<b>Tools</b>	<b>179 - 180</b>



**A**

Schluter®-ALL-SET ..... 176

**B**

Schluter®-BEKOTEC ..... 173

Schluter®-BEKOTEC-BRS ..... 174

Schluter®-BEKOTEC-BRSK ..... 174

Schluter®-BEKOTEC-BRS/KF ..... 174

Schluter®-BEKOTEC-BRS/KSF ..... 174

Schluter®-BEKOTEC-F ..... 173

Schluter®-BEKOTEC-THERM-RH 75 ..... 174

**D**

Schluter®-DECO ..... 16

Schluter®-DECO-DE ..... 47

Schluter®-DECO-SG ..... 47 & 170

▲ Schluter®-DECO-SGC ..... 48 & 171

Schluter®-DESIGNBASE-SL ..... 58 - 59

Schluter®-DESIGNLINE ..... 46

Schluter®-DILEX-AHK ..... 83 - 85

Schluter®-DILEX-AHKA ..... 86 - 87

Schluter®-DILEX-AKWS ..... 76

Schluter®-DILEX-AS ..... 78

Schluter®-DILEX-BT ..... 77

Schluter®-DILEX-BTO ..... 77

Schluter®-DILEX-BTS ..... 78

Schluter®-DILEX-BWA ..... 79

Schluter®-DILEX-BWB ..... 74

Schluter®-DILEX-BWS ..... 73

Schluter®-DILEX-DFP ..... 174

Schluter®-DILEX-EDP ..... 74

Schluter®-DILEX-EHK ..... 89

Schluter®-DILEX-EKE ..... 80

Schluter®-DILEX-EKSB ..... 76

Schluter®-DILEX-EZ 6 + 9 ..... 73

Schluter®-DILEX-HK ..... 82

Schluter®-DILEX-HKS ..... 90

Schluter®-DILEX-HKU ..... 91

Schluter®-DILEX-HKW ..... 81

Schluter®-DILEX-KSA ..... 79

Schluter®-DILEX-KSN ..... 75

Schluter®-DILEX-MOP ..... 72

Schluter®-DILEX-MP/-MPV ..... 72

Schluter®-DILEX-PHK ..... 88

Schluter®-DITRA ..... 106

Schluter®-DITRA-HEAT ..... 115

Schluter®-DITRA-HEAT-DUO ..... 115

▲ Schluter®-DITRA-HEAT-DUO-PS ..... 116

Schluter®-DITRA-HEAT-E-HK ..... 117

Schluter®-DITRA-HEAT-E-R ..... 120

Schluter®-DITRA-HEAT-E-RR ..... 120

▲ Schluter®-DITRA-HEAT-E-RRS ..... 121

▲ Schluter®-DITRA-HEAT-E-RS1 ..... 121

Schluter®-DITRA-HEAT-E-RT ..... 120

Schluter®-DITRA-HEAT-E-WiFi ..... 120

▲ Schluter®-DITRA-HEAT-PS ..... 116

Schluter®-DITRA-HEAT/-DITRA-XL-

TROWEL ..... 179

Schluter®-DITRA-ROLLER ..... 179

Schluter®-DITRA-TROWEL ..... 179

Schluter®-DITRA-XL ..... 106

**E**

Schluter®-ECK-E ..... 54

Schluter®-ECK-K ..... 55

Schluter®-ECK-KHK ..... 56

Schluter®-ECK-KI ..... 57

**F**

Schluter®-FAST-SET ..... 176

Schluter®-FINEC ..... 44

Schluter®-FINEC-SQ ..... 43

**I**

Schluter®-INDEC ..... 45

**J**

▲ Schluter®-JOLLY ..... 23 - 26

Schluter®-JOLLY-P ..... 27

**K**

Schluter®-KERDI ..... 108 & 123

Schluter®-KERDI-BAND ..... 104, 109 & 124

Schluter®-KERDI-BOARD ..... 98

Schluter®-KERDI-BOARD-E ..... 99



**NEW!**

DITRA-HEAT-PS

Peel & stick floor warming membrane

(page 116)

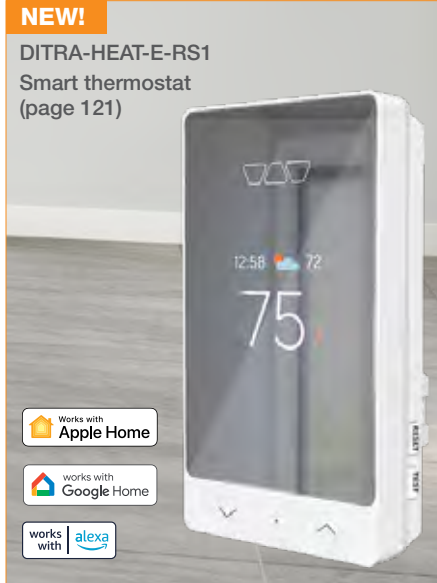

Schluter®-KERDI-BOARD-KIT .....	156	Schluter®-KERDI-KERS .....	110 & 125	Schluter®-RONDEC-CT .....	51 - 52
Schluter®-KERDI-BOARD-SB .....	100 & 152	Schluter®-KERDI-KERS-B .....	110 & 125	Schluter®-RONDEC-DB .....	45
Schluter®-KERDI-BOARD-SC .....	100 & 151	Schluter®-KERDI-KM .....	111 & 126	Schluter®-RONDEC-STEP ...	49 - 51 & 61 - 62
Schluter®-KERDI-BOARD-SN .....	100 & 152	Schluter®-KERDI-LINE .....	142 - 147		
Schluter®-KERDI-BOARD-U .....	99	Schluter®-KERDI-LINE-FC .....	147	<b>S</b>	
Schluter®-KERDI-BOARD-V .....	99	Schluter®-KERDI-SEAL-PS/-MV ...	111 & 126	Schluter®-SCHIENE .....	13 -15 & 28
Schluter®-KERDI-BOARD-ZA .....	101	Schluter®-KERDI-SHOWER-CB .....	135	Schluter®-SCHIENE-STEP .....	53 & 63
Schluter®-KERDI-BOARD-ZB .....	102	Schluter®-KERDI-SHOWER-KIT ...	153 - 155	Schluter®-SET .....	176
Schluter®-KERDI-BOARD-ZC .....	101	Schluter®-KERDI-SHOWER-LT/-LTS .....	150	Schluter®-SHELF .....	158 - 167
Schluter®-KERDI-BOARD-ZDK .....	104	Schluter®-KERDI-SHOWER-R .....	151	Schluter®-SHOWERPROFILE-R .....	168
Schluter®-KERDI-BOARD-ZFP .....	103	Schluter®-KERDI-SHOWER-T/-TS/-TT ...	149	Schluter®-SHOWERPROFILE-S .....	168
Schluter®-KERDI-BOARD-ZS .....	103	Schluter®-KERDI-TROWEL .....	179	Schluter®-SHOWERPROFILE-WS .....	169
Schluter®-KERDI-BOARD-ZSA .....	104	Schluter®-KERDI-TUBKIT .....	155	Schluter®-SHOWERPROFILE-WSK .....	169
Schluter®-KERDI-BOARD-ZSD .....	102			Schluter®-SNIPS .....	180
Schluter®-KERDI-BOARD-ZT .....	103	<b>P</b>			
Schluter®-KERDI-BOARD-ZW .....	102	Schluter®-PRIMER-U .....	178	<b>T</b>	
Schluter®-KERDI-DRAIN .....	128 - 138	Schluter®-PROCUT-TSM .....	180	Schluter®-TREP-E .....	65
Schluter®-KERDI-DRAIN-F .....	139			Schluter®-TREP-EFK .....	69
Schluter®-KERDI-DS .....	108 & 123	<b>Q</b>		Schluter®-TREP-EK .....	69
Schluter®-KERDI-FIX .....	111 & 171	Schluter®-QUADEC .....	38 - 41	Schluter®-TREP-FL .....	64
Schluter®-KERDI-FLEX .....	107	Schluter®-QUADEC-FS .....	42	Schluter®-TREP-G .....	66
Schluter®-KERDI-KERECK-F .....	109 & 124	Schluter®-QUADEC-K .....	42	Schluter®-TREP-GK .....	70
		<b>R</b>		Schluter®-TREP-SE/-S/-B .....	67
		Schluter®-REFLEECE .....	113	Schluter®-TREP-TAP .....	68
		Schluter®-REMA .....	57		
		Schluter®-RENO-RAMP .....	20	<b>V</b>	
		Schluter®-RENO-RAMP-K .....	20	Schluter®-VINPRO-RO .....	95
		Schluter®-RENO-T .....	17	Schluter®-VINPRO-S .....	93
		Schluter®-RENO-TK .....	18	Schluter®-VINPRO-STEP .....	96
		Schluter®-RENO-U .....	21	Schluter®-VINPRO-STEP-R .....	96
		Schluter®-RENO-V .....	19	Schluter®-VINPRO-T .....	93
		Schluter®-RONDEC .....	29 - 37	Schluter®-VINPRO-U .....	94



Schluter®-SCHIENE  
Page 13 - 15



Schluter®-DECO  
Page 16



Schluter®-RENO-T  
Page 17



Schluter®-RENO-TK  
Page 18



Schluter®-RENO-V  
Page 19



Schluter®-RENO-RAMP/-K  
Page 20



Schluter®-RENO-U  
Page 21



 Schluter®-JOLLY  
Page 23 - 26



Schluter®-JOLLY-P  
Page 27



Schluter®-SCHIENE  
Page 28

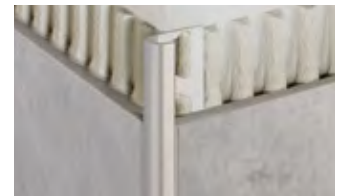

Schluter®-RONDEC  
Page 29 - 37



Schluter®-QUADEC  
Page 38 - 41



Schluter®-QUADEC-K  
Page 42

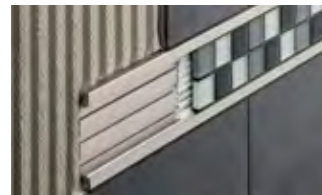

Schluter®-QUADEC-FS  
Page 42



Schluter®-FINEC-SQ  
Page 43

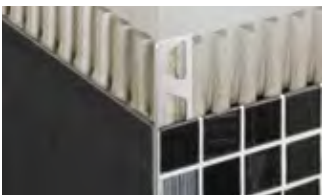

Schluter®-FINEC  
Page 44



Schluter®-INDEC  
Page 45

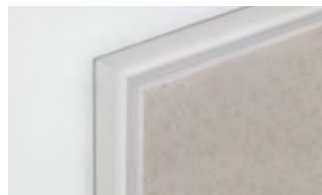

Schluter®-RONDEC-DB  
Page 45



Schluter®-DESIGNLINE  
Page 46

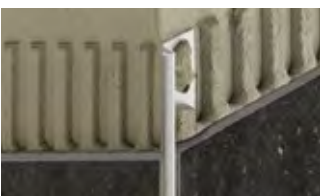

Schluter®-DECO-DE  
Page 47

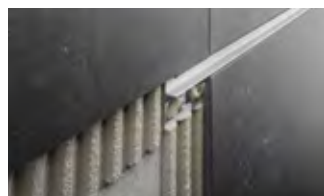

Schluter®-DECO-SG  
Page 47



 Schluter®-DECO-SGC  
Page 48

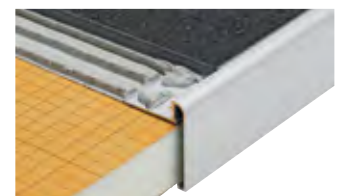

Schluter®-RONDEC-STEP  
Page 49 - 51



Schluter®-RONDEC-CT  
Page 51 - 52



Schluter®-SCHIENE-STEP  
Page 53



Schluter®-ECK-E  
Page 54



Schluter®-ECK-K  
Page 55



Schluter®-ECK-KHK  
Page 56



Schluter®-ECK-KI  
Page 57

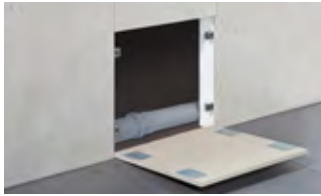

Schluter®-REMA  
Page 57

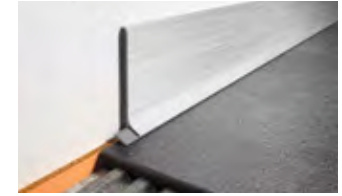

Schluter®-DESIGNBASE-SL  
Page 58 - 59

STAIR-NOSING PROFILES

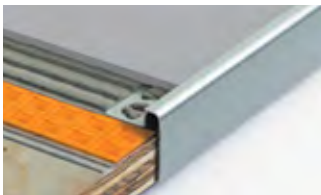

Schluter®-RONDEC-STEP  
Page 61 - 62



Schluter®-SCHIENE-STEP  
Page 63



Schluter®-TREP-FL  
Page 64



Schluter®-TREP-E  
Page 65



Schluter®-TREP-G  
Page 66



Schluter®-TREP-SE/-S/-B  
Page 67



Schluter®-TREP-TAP  
Page 68



Schluter®-TREP-EK  
Page 69



Schluter®-TREP-EFK  
Page 69



Schluter®-TREP-GK  
Page 70



Schluter®-DILEX-MOP  
Page 72



Schluter®-DILEX-MP/-MPV  
Page 72



Schluter®-DILEX-EZ 6 + 9  
Page 73



Schluter®-DILEX-BWS  
Page 73

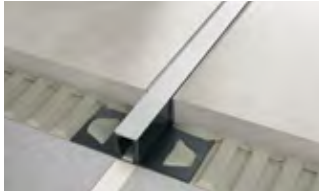

Schluter®-DILEX-BWB  
Page 74



Schluter®-DILEX-EDP  
Page 74

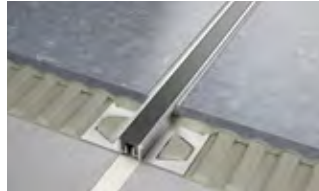

Schluter®-DILEX-KSN  
Page 75



Schluter®-DILEX-EKSB  
Page 76



Schluter®-DILEX-AKWS  
Page 76



Schluter®-DILEX-BT  
Page 77



Schluter®-DILEX-BTO  
Page 77



Schluter®-DILEX-BTS  
Page 78

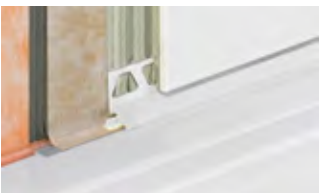

Schluter®-DILEX-AS  
Page 78



Schluter®-DILEX-BWA  
Page 79



Schluter®-DILEX-KSA  
Page 79



Schluter®-DILEX-EKE  
Page 80



Schluter®-DILEX-HKW  
Page 81



Schluter®-DILEX-HK  
Page 82



Schluter®-DILEX-AHK  
Page 83 - 85



Schluter®-DILEX-AHKA  
Page 86 - 87



Schluter®-DILEX-PHK  
Page 88



Schluter®-DILEX-EHK  
Page 89



Schluter®-DILEX-HKS  
Page 90



Schluter®-DILEX-HKU  
Page 91





Schluter®-VINPRO-S  
Page 93



Schluter®-VINPRO-T  
Page 93



Schluter®-VINPRO-U  
Page 94



Schluter®-VINPRO-RO  
Page 95



Schluter®-VINPRO-STEP  
Page 96



Schluter®-VINPRO-STEP-R  
Page 96

WATERPROOF SUBSTRATES & BUILDING PANELS



Schluter®-KERDI-BOARD  
Page 98

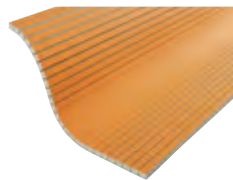

Schluter®-KERDI-BOARD-V  
Page 99

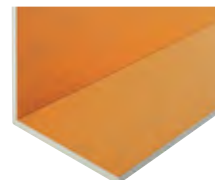

Schluter®-KERDI-BOARD-E  
Page 99

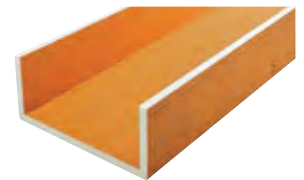

Schluter®-KERDI-BOARD-U  
Page 99



Schluter®-KERDI-BOARD-SC  
Page 100



Schluter®-KERDI-BOARD-SN  
Page 100



Schluter®-KERDI-BOARD-SB  
Page 100



Schluter®-KERDI-BOARD-ZC  
Page 101

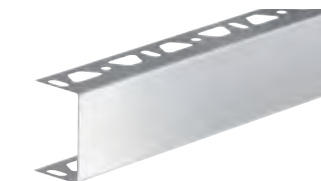

Schluter®-KERDI-BOARD-ZA  
Page 101



Schluter®-KERDI-BOARD-ZB  
Page 102



Schluter®-KERDI-BOARD-ZW  
Page 102



Schluter®-KERDI-BOARD-ZSD  
Page 102

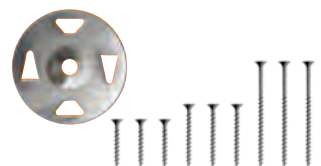

Schluter®-KERDI-BOARD-ZT/-ZS  
Page 103



Schluter®-KERDI-BOARD-ZFP  
Page 103



Schluter®-KERDI-BAND  
Page 104



Schluter®-KERDI-BOARD-ZSA  
Page 104



Schluter®-KERDI-BOARD-ZDK  
Page 104

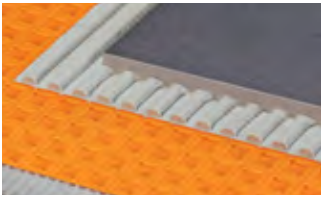

Schluter®-DITRA  
Page 106

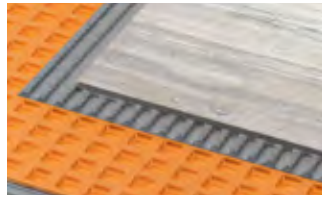

Schluter®-DITRA-XL  
Page 106



Schluter®-KERDI-FLEX  
Page 107



Schluter®-KERDI-DS  
Page 108



Schluter®-KERDI-BAND  
Page 109

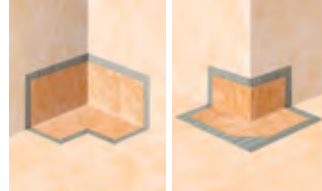

Schluter®-KERDI-KERECK-F  
Page 109



Schluter®-KERDI-KERS-B  
Page 110



Schluter®-KERDI-KERS  
Page 110

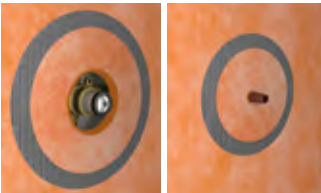

Schluter®-KERDI-SEAL-PS/-MV  
Page 111



Schluter®-KERDI-KM  
Page 111



Schluter®-KERDI-FIX  
Page 111



Schluter®-REFLEECE  
Page 113



Schluter®-DITRA-HEAT  
Page 115

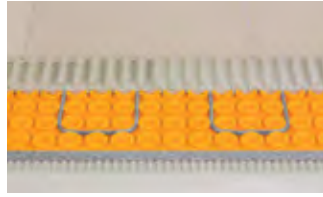

Schluter®-DITRA-HEAT-DUO  
Page 115



 Schluter®-DITRA-HEAT-PS  
Page 116

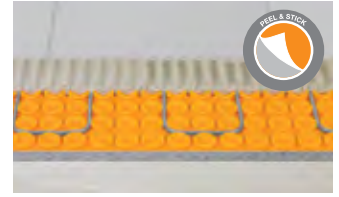

 Schluter®-DITRA-HEAT-DUO-PS  
Page 116



Schluter®-DITRA-HEAT-E-HK  
Page 117



Schluter®-DITRA-HEAT-E-WIFI  
Page 120



Schluter®-DITRA-HEAT-E-RT  
Page 120



Schluter®-DITRA-HEAT-E-R  
Page 120



Schluter®-DITRA-HEAT-E-RR  
Page 120



 Schluter®-DITRA-HEAT-E-RS1  
Page 121

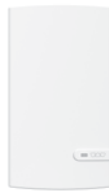

 Schluter®-DITRA-HEAT-E-RRS  
Page 121

SHOWER SYSTEM



Schluter®-KERDI/-DS  
Page 123



Schluter®-KERDI-BAND  
Page 124

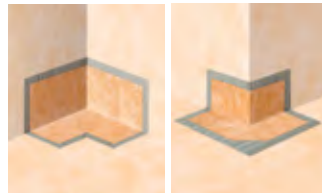

Schluter®-KERDI-KERECK-F  
Page 124



Schluter®-KERDI-KERS-B  
Page 125



Schluter®-KERDI-KERS  
Page 125

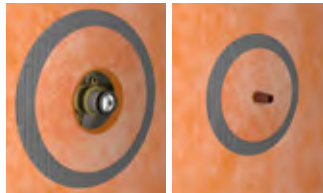

Schluter®-KERDI-SEAL-PS/-MV  
Page 126



Schluter®-KERDI-KM  
Page 126



Schluter®-KERDI-DRAIN  
Page 128 - 138



Schluter®-KERDI-SHOWER-CB  
Page 135



Schluter®-KERDI-DRAIN-F  
Page 139



Schluter®-KERDI-LINE  
Page 142 - 147

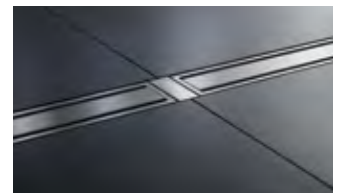

Schluter®-KERDI-LINE-FC  
Page 147



Schluter®-KERDI-SHOWER-T/-TS/-TT  
Page 149



Schluter®-KERDI-SHOWER-LT/-LTS  
Page 150



Schluter®-KERDI-BOARD-SC  
Page 151



Schluter®-KERDI-SHOWER-R  
Page 151



Schluter®-KERDI-BOARD-SB  
Page 152



Schluter®-KERDI-BOARD-SN  
Page 152



Schluter®-KERDI-SHOWER-KIT  
Page 153 - 155



Schluter®-KERDI-TUBKIT  
Page 155



Schluter®-KERDI-BOARD-KIT  
Page 156



Schluter®-SHELF  
Page 158 - 167



Schluter®-SHOWERPROFILE-S  
Page 168



Schluter®-SHOWERPROFILE-R  
Page 168



Schluter®-SHOWERPROFILE-WS  
Page 169



Schluter®-SHOWERPROFILE-WSK  
Page 169



Schluter®-DECO-SG  
Page 170



 Schluter®-DECO-SGC  
Page 171



Schluter®-KERDI-FIX  
Page 171

MODULAR SCREED SYSTEM FOR CONVENTIONAL & RADIANT-HEATED SCREEDS



Schluter®-**BEKOTEC**  
Page 173



Schluter®-**BEKOTEC-F**  
Page 173



Schluter®-**BEKOTEC-BRS**  
Page 174



Schluter®-**BEKOTEC-BRSK**  
Page 174



Schluter®-**BEKOTEC-BRS/KF**  
Page 174



Schluter®-**BEKOTEC-BRS/KSF**  
Page 174



Schluter®-**DILEX-DFP**  
Page 174



Schluter®-**BEKOTEC-THERM-RH-75**  
Page 174

SETTING MATERIALS



Schluter®-**SET**  
Page 176



Schluter®-**ALL-SET**  
Page 176



Schluter®-**FAST-SET**  
Page 176



Schluter®-**PRIMER-U**  
Page 178

TOOLS



Schluter®-**DITRA-TROWEL**  
Schluter®-**KERDI-TROWEL**  
Schluter®-**DITRA-HEAT/**  
**-DITRA-XL-TROWEL**  
Page 179



Schluter®-**DITRA Roller**  
Page 179



Schluter®-**SNIPS**  
Page 180



Schluter®-**PROCUT-TSM**  
Page 180



MANUFACTURING

The majority of Schluter® products sold in North America are also produced here. In addition, products produced in North America are shipped overseas for worldwide distribution. International cooperation in product development and support of the local economies are vital elements of our core strategy.



## Schluter® Profiles

### Transition & edge-protection profiles for floors

Transitions from a tiled floor to other surfaces need to be protected, and floor profiles are designed to ensure a smooth transition, while preventing tile edges from chipping and cracking. Schluter Systems offers a vast selection of floor profiles that protect tile edges between floor coverings at both equal and lower elevations.

Schluter floor profiles improve the integrity of the tile assembly, are maintenance-free, and are available in a variety of shapes, sizes, materials, and finishes to complement the design of any room.





### Schluter®-SCHIENE

**Schluter®-SCHIENE** features an 87° angle to transfer point loads and protect tile edges in tile coverings. Typical applications include edge protection where tile is bordered by carpet, at expansion joints, or as a decorative edging for stairs. SCHIENE in aluminum and brass, in sizes 1/4" (6 mm) and higher, features an integrated joint spacer that establishes a defined joint cavity between the tile and the profile.

**Note:** Also available in stainless steel 316L (1.4404 = V4A). Contact Customer Service for pricing and availability.

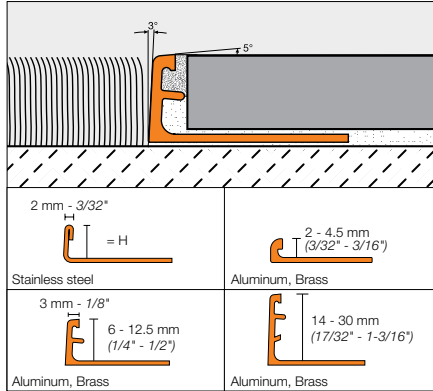

Schluter®-SCHIENE										
Length = 2.5 m - 8' 2-1/2"	Stainless steel 304 (1.4301 = V2A) (E)		Brushed stainless steel 304 (1.4301 = V2A) (EB)		Solid brass* (M)		Aluminum (A)		Satin anodized aluminum (AE)	
H = mm - in.	Item No.	\$ / Length	Item No.	\$ / Length	Item No.	\$ / Length	Item No.	\$ / Length	Item No.	\$ / Length
2 - 3/32	E 20	27.43	-	-	-	-	A 20	9.09	AE 20	13.90
3 - 1/8	E 30	30.17	-	-	M 30	28.80	A 30	9.53	AE 30	14.55
4.5 - 3/16	E 45	35.68	-	-	M 45	32.25	A 45	9.75	AE 45	14.91
6 - 1/4	E 60	36.37	E 60 EB	43.64	M 60	33.61	A 60	10.42	AE 60	15.56
7 - 9/32	E 70	37.06	-	-	-	-	A 70	10.60	AE 70	15.87
8 - 5/16	E 80	36.62	E 80 EB	45.29	M 80	37.03	A 80	10.47	AE 80	15.45
9 - 11/32	E 90	38.94	-	-	M 90	37.45	A 90	11.14	AE 90	16.75
10 - 3/8	E 100	38.64	E 100 EB	47.75	M 100	37.86	A 100	11.01	AE 100	16.39
11 - 7/16	E 110	39.23	E 110 EB	49.36	M 110	38.84	A 110	11.38	AE 110	17.46
12.5 - 1/2	E 125	39.95	E 125 EB	49.40	M 125	39.25	A 125	11.58	AE 125	17.57
14 - 17/32	E 140	42.86	-	-	-	-	A 140	13.68	AE 140	19.59
15 - 9/16	E 150	48.02	-	-	M 150	44.05	A 150	14.32	AE 150	19.81
16 - 5/8	E 160	48.99	-	-	M 160	44.33	A 160	14.73	AE 160	21.48
17.5 - 11/16	E 175	49.41	-	-	M 175	45.14	A 175	15.64	AE 175	22.73
20 - 3/4	E 200	51.45	-	-	M 200	46.11	A 200	16.29	AE 200	24.64
21 - 13/16	-	-	-	-	-	-	A 210	16.93	AE 210	25.28
22.5 - 7/8	E 225	53.53	-	-	M 225	56.26	A 225	17.34	AE 225	25.92
25 - 1	E 250	55.57	-	-	M 250	57.36	A 250	18.21	AE 250	27.17
27.5 - 1-1/16	-	-	-	-	-	-	A 275	18.89	AE 275	29.06
30 - 1-3/16	E 300	59.71	-	-	M 300	62.42	A 300	20.19	AE 300	30.31

#### 10-foot (3.05 m) SCHIENE Profiles – Stainless Steel

Length = 3.05 m - 10'	Stainless steel 304 (1.4301 = V2A) (E)	
H = mm - in.	Profile	\$ / Length
8 - 5/16	E 80 / 300	45.77
10 - 3/8	E 100 / 300	48.30
12.5 - 1/2	E 125 / 300	49.95

Special shipping conditions apply, see pages 191-192.

**Note:** The anchoring leg of Schluter®-SCHIENE is available with a special radius perforation so that the profile can be used to form curves.

- Price surcharge: \$0.70 per foot
- Available in all materials
- Item No.: R / Profile No. (e.g., R/M 80)
- For delivery time, please call Customer Service



\* ⚠️ **WARNING:** Reproductive Harm - www.P65Warnings.ca.gov



<b>Schluter®-SCHIENE</b>								
Length = 2.5 m - 8' 2-1/2"	Polished chrome anodized aluminum (ACG)		Brushed chrome anodized aluminum (ACGB)		Satin nickel anodized aluminum (AT)		Polished nickel anodized aluminum (ATG)	
H = mm - in.	Item No.	\$ / Length	Item No.	\$ / Length	Item No.	\$ / Length	Item No.	\$ / Length
6 - 1/4	A 60 ACG	18.18	A 60 ACGB	19.43	A 60 AT	18.49	A 60 ATG	23.93
8 - 5/16	A 80 ACG	19.43	A 80 ACGB	19.96	A 80 AT	18.88	A 80 ATG	24.30
10 - 3/8	A 100 ACG	21.50	A 100 ACGB	22.08	A 100 AT	19.24	A 100 ATG	24.95
12.5 - 1/2	A 125 ACG	22.74	A 125 ACGB	23.31	A 125 AT	19.88	A 125 ATG	25.16

Length = 2.5 m - 8' 2-1/2"	Brushed nickel anodized aluminum (ATGB)		Satin copper anodized aluminum (AK)		Polished copper anodized aluminum (AKG)		Brushed copper anodized aluminum (AKGB)	
H = mm - in.	Item No.	\$ / Length	Item No.	\$ / Length	Item No.	\$ / Length	Item No.	\$ / Length
6 - 1/4	A 60 ATGB	21.48	A 60 AK	18.49	A 60 AKG	23.93	A 60 AKGB	21.48
8 - 5/16	A 80 ATGB	21.73	A 80 AK	19.24	A 80 AKG	24.30	A 80 AKGB	22.16
10 - 3/8	A 100 ATGB	22.19	A 100 AK	19.62	A 100 AKG	24.95	A 100 AKGB	22.62
12.5 - 1/2	A 125 ATGB	23.16	A 125 AK	20.26	A 125 AKG	25.16	A 125 AKGB	23.16

Length = 2.5 m - 8' 2-1/2"	Satin brass anodized aluminum (AM)		Polished brass anodized aluminum (AMG)		Brushed brass anodized aluminum (AMGB)		Brushed antique bronze anodized aluminum (ABGB)	
H = mm - in.	Item No.	\$ / Length	Item No.	\$ / Length	Item No.	\$ / Length	Item No.	\$ / Length
6 - 1/4	A 60 AM	15.51	A 60 AMG	18.18	A 60 AMGB	20.67	A 60 ABGB	22.95
8 - 5/16	A 80 AM	16.12	A 80 AMG	19.43	A 80 AMGB	21.38	A 80 ABGB	24.14
10 - 3/8	A 100 AM	17.98	A 100 AMG	21.91	A 100 AMGB	22.94	A 100 ABGB	24.87
12.5 - 1/2	A 125 AM	19.21	A 125 AMG	23.18	A 125 AMGB	24.16	A 125 ABGB	26.94

<b>10-foot (3.05 m) SCHIENE Profiles – Anodized Aluminum</b>								
Length = 3.05 m - 10'	Satin anodized aluminum (AE)		Polished chrome anodized aluminum (ACG)		Satin nickel anodized aluminum (AT)		Brushed antique bronze anodized aluminum (ABGB)	
H = mm - in.	Item No.	\$ / Length	Item No.	\$ / Length	Item No.	\$ / Length	Item No.	\$ / Length
8 - 5/16	AE 80 / 300	19.32	A 80 ACG / 300	24.29	A 80 AT / 300	23.61	A 80 ABGB / 300	30.18
10 - 3/8	AE 100 / 300	20.49	A 100 ACG / 300	26.86	A 100 AT / 300	24.06	A 100 ABGB / 300	31.10
12.5 - 1/2	AE 125 / 300	21.97	A 125 ACG / 300	28.41	A 125 AT / 300	24.85	A 125 ABGB / 300	33.67

Special shipping conditions apply, see pages 191-192.





**Schluter®-TRENDLINE** Textured Color-coated Aluminum

Matte White and Matte Black

Schluter®-SCHIENE			
Length = 2.5 m - 8' 2-1/2"		Textured color-coated aluminum (TS)	
H = mm - in.	Item No.	\$ / Length	
6 - 1/4	A 60 + color*	32.72	
8 - 5/16	A 80 + color*	33.45	
10 - 3/8	A 100 + color*	34.10	
11 - 7/16	A 110 + color*	34.45	
12.5 - 1/2	A 125 + color*	35.13	

Schluter®-SCHIENE			
Length = 2.5 m - 8' 2-1/2"		Textured color-coated aluminum	
H = mm - in.	Item No.	\$ / Length	
3 - 1/8	A 30 + color*	25.15	
4.5 - 3/16	A 45 + color*	25.65	
6 - 1/4	A 60 + color*	26.18	
8 - 5/16	A 80 + color*	26.75	
10 - 3/8	A 100 + color*	27.27	
11 - 7/16	A 110 + color*	27.56	
12.5 - 1/2	A 125 + color*	28.11	

**\*Color Codes**

\* To complete the item number, add the **color** code (e.g., A 60 **TSC**).

**\*Color Codes**

\* To complete the item number, add the **color** code (e.g., A 60 **MGS**).

**Note:** The anchoring leg of **Schluter®-SCHIENE** is available with a special radius perforation so that the profile can be used to form curves.

- Price surcharge: \$0.70 per foot
- Available in all materials
- Polished and color-coated aluminum finishes require a relatively large bending radius
- Item No.: R / Profile No. (e.g., R/A 80 AT)
- For delivery time, please call Customer Service



**Schluter®-SCHIENE-RADIUS**

**Schluter®-SCHIENE-RADIUS** is an extruded profile, with special perforations, for finishing and protecting the edges of curved tile coverings. SCHIENE-RADIUS provides edge protection while enhancing the aesthetic appearance of a curved design, including curved tile-to-tile transitions and curved outside wall corners, as well as curved designs in other surface coverings. Other sizes are available upon request.

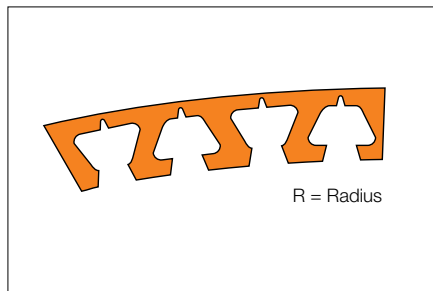

Schluter®-SCHIENE-RADIUS									
Length = 2.5 m - 8' 2-1/2"		Stainless steel 304 (1.4301 = V2A) (E)		Solid brass* (M)		Aluminum (A)		Satin anodized aluminum (AE)	
H = mm - in.	Item No.	\$ / Length	Item No.	\$ / Length	Item No.	\$ / Length	Item No.	\$ / Length	
6 - 1/4	R/E 60	41.97	R/M 60	39.21	R/A 60	16.02	R/AE 60	21.16	
8 - 5/16	R/E 80	42.22	R/M 80	42.63	R/A 80	16.07	R/AE 80	21.05	
10 - 3/8	R/E 100	44.24	R/M 100	43.46	R/A 100	16.61	R/AE 100	21.99	
12.5 - 1/2	R/E 125	45.55	R/M 125	44.85	R/A 125	17.18	R/AE 125	23.17	

\* ⚠ **WARNING:** Reproductive Harm - [www.P65Warnings.ca.gov](http://www.P65Warnings.ca.gov)



### Schluter®-DECO

**Schluter®-DECO** is designed to provide decorative lines within tile coverings and edge protection at transitions from tile coverings to other same-height surface coverings such as wood or carpet. The profile features a 1/4" (6 mm)-wide visible surface.

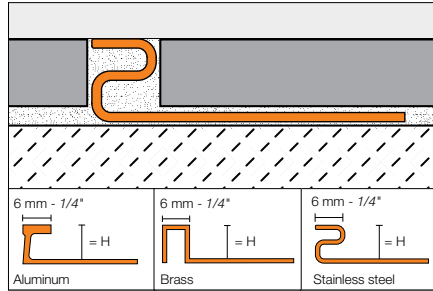

Schluter®-DECO								
Length = 2.5 m - 8' 2-1/2"	Stainless steel 304 (1.4301 = V2A) (E)		Solid brass* (M)		Chrome-plated* solid brass (MC)		Satin anodized aluminum (AE)	
H = mm - in.	Item No.	\$ / Length	Item No.	\$ / Length	Item No.	\$ / Length	Item No.	\$ / Length
8 - 5/16	E 80 D	45.20	-	-	-	-	AE 80 D	21.60
9 - 11/32	E 90 D	45.78	M 90 D	86.69	MC 90 D	188.93	-	-
10 - 3/8	E 100 D	46.47	-	-	-	-	AE 100 D	24.35
11 - 7/16	E 110 D	47.06	M 110 D	93.25	MC 110 D	195.63	-	-
12.5 - 1/2	E 125 D	48.19	M 125 D	97.76	MC 125 D	200.14	AE 125 D	25.14
14 - 17/32	E 140 D	48.92	-	-	-	-	-	-
16 - 5/8	E 160 D	50.48	-	-	-	-	-	-
18.5 - 23/32	E 185 D	52.19	-	-	-	-	-	-
21 - 13/16	E 210 D	53.77	-	-	-	-	-	-
25 - 1	E 250 D	56.75	-	-	-	-	-	-
30 - 1-3/16	E 300 D	59.87	-	-	-	-	-	-

**Note:** The anchoring leg of **Schluter®-DECO** is available with a special radius perforation so that the profile can be used to form curves.

- Price surcharge: \$0.70 per foot
- Available in all materials except stainless steel and chrome-plated solid brass
- Item No.: R / Profile No. (e.g., R/M 90 D)
- For delivery time, please call Customer Service



R = Radius

\* **WARNING:** Reproductive Harm - [www.P65Warnings.ca.gov](http://www.P65Warnings.ca.gov)



### Schluter®-RENO-T

**Schluter®-RENO-T** is designed to provide transitions between existing, same-height, hard surface floor coverings, primarily in retrofit applications (e.g., ceramic tile or natural stone, parquet flooring, concrete pavers, laminate, etc.). RENO-T, in brass and anodized aluminum size 9/14, is flexible in the lateral direction and can be used in curved applications.

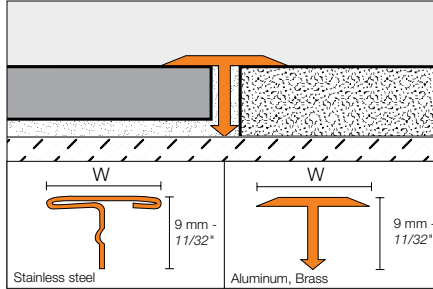

#### Schluter®-RENO-T

Length = 2.5 m - 8' 2-1/2"	Stainless steel 304 (1.4301 = V2A) (E)		Brushed stainless steel 304 (1.4301 = V2A) (EB)		Solid brass* (M)		Satin anodized aluminum (AE)	
W = mm - in.	Item No.	\$/ Length	Item No.	\$/ Length	Item No.	\$/ Length	Item No.	\$/ Length
14 - 17/32	T 9/14 E	34.26	T 9/14 EB	36.46	T 9/14 M	23.36	T 9/14 AE	12.13
25 - 1	T 9/25 E	46.86	T 9/25 EB	51.20	T 9/25 M	39.59	T 9/25 AE	19.60

Length = 2.5 m - 8' 2-1/2"	Satin nickel anodized aluminum (AT)		Satin copper anodized aluminum (AK)		Satin brass anodized aluminum (AM)	
W = mm - in.	Item No.	\$/ Length	Item No.	\$/ Length	Item No.	\$/ Length
14 - 17/32	T 9/14 AT	14.19	T 9/14 AK	14.48	T 9/14 AM	13.11
25 - 1	T 9/25 AT	23.60	T 9/25 AK	23.60	T 9/25 AM	19.95

\* **WARNING:** Reproductive Harm - [www.P65Warnings.ca.gov](http://www.P65Warnings.ca.gov)



### Schluter®-RENO-TK

**Schluter®-RENO-TK** is designed to protect tile edges and provide a smooth transition from tile coverings to floor coverings at lower elevations, typically carpet. The 1/4" (6 mm) channel beneath the sloped flange of the profile hides and protects the cut edge of lower adjoining surface coverings. RENO-TK in anodized aluminum sizes 5/16" (8 mm) and larger features an integrated joint spacer that establishes a defined joint cavity between the tile and the profile.

**ADA-Compliant**

**Technical Note:** ADA requirements regarding transitions between surfaces of different heights:

- Up to 6 mm (1/4") - no special requirements
- 6 mm (1/4") to 12.5 mm (1/2") - slope ratio, 1:2
- More than 12.5 mm (1/2") - slope ratio, 1:12

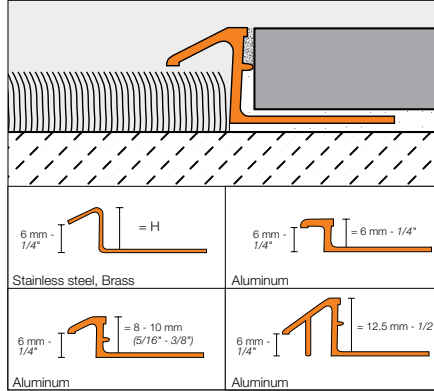

Diagram Values		
H = mm - in.	B = mm - in.	
	Aluminum	Stainless steel/Brass
6 - 1/4	7.5 - 19/64	-
8 - 5/16	8.5 - 21/64	7 - 9/32
10 - 3/8	8.5 - 21/64	11 - 7/16
11 - 7/16	-	13.5 - 17/32
12.5 - 1/2	15.5 - 39/64	16.5 - 21/32

Schluter®-RENO-TK								
Length = 2.5 m - 8' 2-1/2"	Stainless steel 304 (1.4301 = V2A) (E)		Brushed stainless steel 304 (1.4301 = V2A) (EB)		Solid brass* (M)		Satin anodized aluminum (AE)	
H = mm - in.	Item No.	\$ / Length	Item No.	\$ / Length	Item No.	\$ / Length	Item No.	\$ / Length
6 - 1/4	-	-	-	-	-	-	AETK 60	18.25
8 - 5/16	ETK 80	50.90	EBTK 80	66.19	MTK 80	42.22	AETK 80	19.60
10 - 3/8	ETK 100	55.65	EBTK 100	72.35	MTK 100	45.79	AETK 100	20.95
11 - 7/16	ETK 110	60.16	EBTK 110	74.50	-	-	-	-
12.5 - 1/2	ETK 125	61.78	EBTK 125	77.21	MTK 125	62.02	AETK 125	27.00

Length = 2.5 m - 8' 2-1/2"	Bright chrome anod. alu. (ACB)		Satin nickel anod. alu. (AT)		Brushed nickel anod. alu. (ATGB)		Brushed antique bronze anod. alu. (ABGB)	
H = mm - in.	Item No.	\$ / Length	Item No.	\$ / Length	Item No.	\$ / Length	Item No.	\$ / Length
6 - 1/4	ATK 60 ACB	19.60	ATK 60 AT	20.95	-	-	-	-
8 - 5/16	ATK 80 ACB	20.95	ATK 80 AT	22.31	ATK 80 ATGB	28.78	ATK 80 ABGB	28.78
10 - 3/8	ATK 100 ACB	22.31	ATK 100 AT	27.00	ATK 100 ATGB	31.19	ATK 100 ABGB	31.19
12.5 - 1/2	ATK 125 ACB	29.05	ATK 125 AT	30.41	ATK 125 ATGB	37.86	ATK 125 ABGB	37.86

**Note:** The anchoring leg of **Schluter®-RENO-TK** is available with a special radius perforation so that the profile can be used to form curves.

- Price surcharge: \$0.70 per foot
- Available in all materials except stainless steel
- Bright/polished finishes require a relatively large bending radius
- Item No.: R / Profile No. (e.g., R/ATK 100 ACB)
- For delivery time, please call Customer Service



\* **WARNING:** Reproductive Harm - www.P65Warnings.ca.gov



### Schluter®-RENO-V

**Schluter®-RENO-V** is designed to protect tile edges and provide a smooth transition between tile coverings and floor coverings at lower elevations. The profile features a movable transition arm that allows the profile to adjust to the height of the adjacent floor covering via a ball-and-socket joint and eliminates trip hazards. RENO-V features an integrated joint spacer that establishes a defined joint cavity between the tile and the profile.

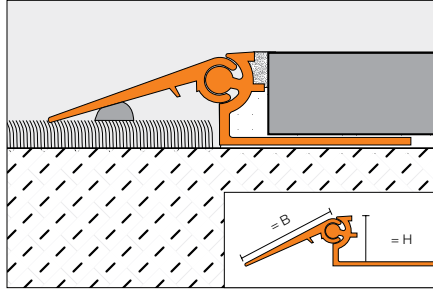

B = 20 mm - 3/4", 30 mm - 1-3/16", 40 mm - 1-9/16"

<b>Schluter®-RENO-V</b>			
Length = 2.5 m - 8' 2-1/2"	Satin anodized aluminum (AE)		
H = mm - in.	Item No.	\$/ Length	
<b>B = 20 mm - 3/4"</b>			
8 - 5/16	AEVT 80 B20	55.83	
10 - 3/8	AEVT 100 B20	57.21	
12.5 - 1/2	AEVT 125 B20	58.59	
15 - 9/16	AEVT 150 B20	60.62	
17.5 - 11/16	AEVT 175 B20	62.01	
20 - 3/4	AEVT 200 B20	66.86	
<b>B = 30 mm - 1-3/16"</b>			
8 - 5/16	AEVT 80 B30	62.01	
10 - 3/8	AEVT 100 B30	63.37	
12.5 - 1/2	AEVT 125 B30	64.10	
15 - 9/16	AEVT 150 B30	65.49	
17.5 - 11/16	AEVT 175 B30	66.86	
20 - 3/4	AEVT 200 B30	71.67	
<b>B = 40 mm - 1-9/16"</b>			
8 - 5/16	AEVT 80 B40	68.22	
10 - 3/8	AEVT 100 B40	69.61	
12.5 - 1/2	AEVT 125 B40	71.39	
15 - 9/16	AEVT 150 B40	73.04	
17.5 - 11/16	AEVT 175 B40	74.44	
20 - 3/4	AEVT 200 B40	79.26	

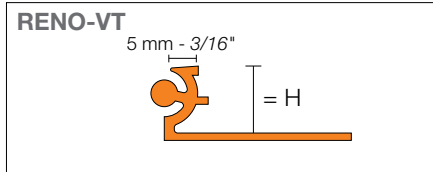

<b>Schluter®-RENO-VT</b>			
Support profile			
Length = 2.5 m - 8' 2-1/2"	Satin anodized aluminum (AE)		
H = mm - in.	Item No.	\$/ Length	
8 - 5/16	AEVT 80	25.71	
10 - 3/8	AEVT 100	26.88	
12.5 - 1/2	AEVT 125	28.29	
15 - 9/16	AEVT 150	29.80	
17.5 - 11/16	AEVT 175	31.23	
20 - 3/4	AEVT 200	35.32	

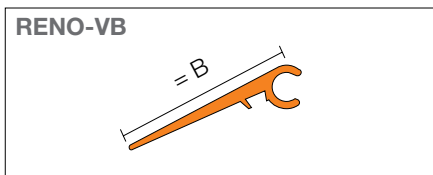

<b>Schluter®-RENO-VB</b>			
Variable transition arm			
Length = 2.5 m - 8' 2-1/2"	Satin anodized aluminum (AE)		
B = mm - in.	Item No.	\$/ Length	
20 - 3/4	AEVB 20	24.96	
30 - 1-3/16	AEVB 30	28.78	
40 - 1-9/16	AEVB 40	35.83	



## Schluter®-RENO-RAMP/-K

**Schluter®-RENO-RAMP/-K** are designed to protect tile edges and provide a smooth transition between tile coverings and floor coverings at lower elevations or finished concrete. The sloped surface eliminates trip hazards and allows easy access for wheel carts. RENO-RAMP/-K feature an integrated joint spacer that establishes a defined joint cavity between the tile and the profile.

RENO-RAMP has an anchoring leg which is embedded in the tile bond coat.

RENO-RAMP-K is subsequently bonded adjacent to existing floor coverings.

### ADA-Compliant

**Note:** 15 mm (9/16") and 20 mm (3/4") are not ADA-compliant.

**Technical Note:** ADA requirements regarding transitions between surfaces of different heights:

- Up to 6 mm (1/4") - no special requirements
- 6 mm (1/4") to 12.5 mm (1/2") - slope ratio, 1:2
- More than 12.5 mm (1/2") - slope ratio, 1:12

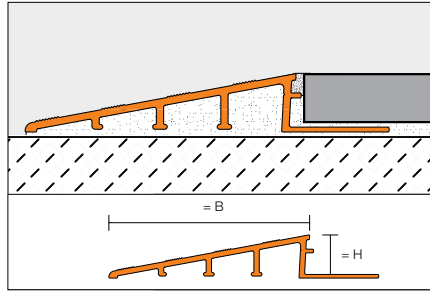

B= 50 mm - 2", 64 mm - 2-1/2", 89 mm - 3-1/2"



### Diagram Values

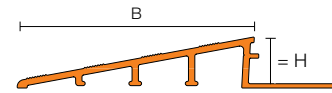

H = mm - in.	B = mm - in.
6 - 1/4	50 - 2
10 - 3/8	64 - 2-1/2
12.5 - 1/2	64 - 2-1/2
12.5 - 1/2	89 - 3-1/2
15 - 9/16	89 - 3-1/2
20 - 3/4	89 - 3-1/2

### Schluter®-RENO-RAMP

Length = 2.5 m - 8' 2-1/2"	Satin anodized aluminum (AE)	
H = mm - in.	Item No.	\$ / Length
<b>B = 50 mm - 2"</b>		
6 - 1/4	AERP 60 B50	48.38
<b>B = 64 mm - 2-1/2"</b>		
10 - 3/8	AERP 100 B65	48.71
12.5 - 1/2	AERP 125 B65	50.80
<b>B = 89 mm - 3-1/2"</b>		
12.5 - 1/2	AERP 125 B90	65.42
15 - 9/16	AERP 150 B90	67.52
20 - 3/4	AERP 200 B90	70.97

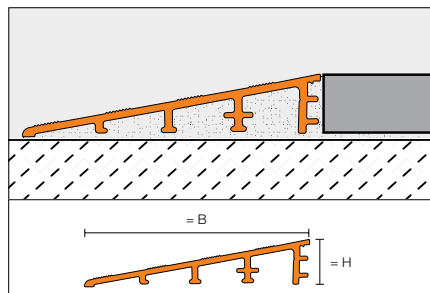

B= 64 mm - 2-1/2"



### Schluter®-RENO-RAMP-K

Length = 2.5 m - 8' 2-1/2"	Satin anodized aluminum (AE)	
H = mm - in.	Item No.	\$ / Length
<b>B = 64 mm - 2-1/2"</b>		
12.5 - 1/2	AERPK 125 B65	59.37



### Schluter®-RENO-U

**Schluter®-RENO-U** is designed to protect tile edges and provide a smooth transition between tile coverings and floor coverings at lower elevations or finished concrete. The sloped surface eliminates trip hazards and the leading edge of the profile abuts the lower surface covering. RENO-U in anodized aluminum features an integrated joint spacer that establishes a defined joint cavity between the tile and the profile.

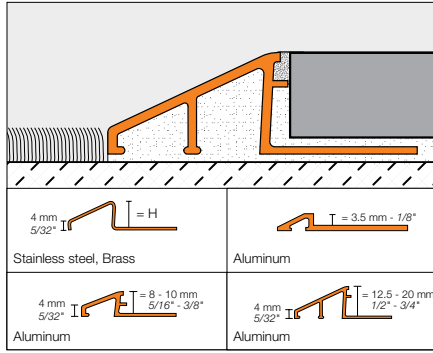

#### ADA-Compliant

**Note:** When leading edge abuts lower surface covering, sizes 20 mm (3/4") and 17.5 mm (11/16") are not ADA-compliant. When leading edge rests on top of lower surface covering, sizes 20 mm (3/4"), 15 mm (9/16"), and 17.5 mm (11/16") are not ADA-compliant.

**Technical Note:** ADA requirements regarding transitions between surfaces of different heights:

- Up to 6 mm (1/4") - no special requirements
- 6 mm (1/4") to 12.5 mm (1/2") - slope ratio, 1:2
- More than 12.5 mm (1/2") - slope ratio, 1:12

#### Diagram Values

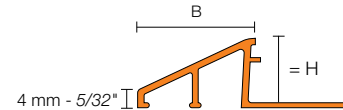

H = mm - in.	B = mm - in.	
	Aluminum	Stainless steel/Brass
3.5 - 1/8	9 - 23/64	-
8 - 5/16	12.5 - 31/64	13 - 33/64
10 - 3/8	16.5 - 21/32	17.5 - 11/16
11 - 7/16	-	19.5 - 49/64
12.5 - 1/2	22 - 55/64	23 - 29/32
15 - 9/16	27.5 - 1-5/64	28 - 1-7/64
17.5 - 11/16	27 - 1-1/16	33.5 - 1-5/16
20 - 3/4	-	40 - 1-37/64

Schluter®-RENO-U								
Length = 2.5 m - 8' 2-1/2"	Stainless steel 304 (1.4301 = V2A) (E)		Brushed stainless steel 304 (1.4301 = V2A) (EB)		Solid brass * (M)		Satin anodized aluminum (AE)	
H = mm - in.	Item No.	\$ / Length	Item No.	\$ / Length	Item No.	\$ / Length	Item No.	\$ / Length
3.5 - 1/8	-	-	-	-	-	-	AEU 35	15.68
8 - 5/16	EU 80	52.44	EBU 80	80.97	MU 80	56.48	AEU 80	18.90
10 - 3/8	EU 100	57.34	EBU 100	86.02	MU 100	63.43	AEU 100	19.87
11 - 7/16	EU 110	62.12	EBU 110	88.94	-	-	-	-
12.5 - 1/2	EU 125	63.62	EBU 125	92.57	MU 125	79.59	AEU 125	26.37
15 - 9/16	EU 150	69.23	EBU 150	98.04	MU 150	88.27	AEU 150	33.78
17.5 - 11/16	EU 175	76.13	EBU 175	104.87	-	-	AEU 175	41.08
20 - 3/4	EU 200	83.78	EBU 200	112.22	-	-	-	-

Length = 2.5 m - 8' 2-1/2"	Bright chrome anod. alu. (ACB)		Satin nickel anod. alu. (AT)		Brushed nickel anod. alu. (ATGB)	
H = mm - in.	Item No.	\$ / Length	Item No.	\$ / Length	Item No.	\$ / Length
8 - 5/16	AU 80 ACB	20.67	AU 80 AT	20.33	AU 80 ATGB	33.53
10 - 3/8	AU 100 ACB	24.12	AU 100 AT	21.37	AU 100 ATGB	36.83
12.5 - 1/2	AU 125 ACB	31.01	AU 125 AT	27.55	AU 125 ATGB	44.45

Length = 2.5 m - 8' 2-1/2"	Brushed antique bronze anod. alu. (ABGB)		Satin brass anod. alu. (AM)	
H = mm - in.	Item No.	\$ / Length	Item No.	\$ / Length
8 - 5/16	AU 80 ABGB	33.53	AU 80 AM	20.33
10 - 3/8	AU 100 ABGB	36.83	AU 100 AM	21.37
12.5 - 1/2	AU 125 ABGB	44.45	AU 125 AM	27.55

\* **WARNING:** Reproductive Harm - www.P65Warnings.ca.gov



## Schluter® Profiles

### Finishing & edge-protection profiles for walls & countertops

From framing a shower niche to accentuating a fireplace surround, Schluter profiles add the perfect finishing touch to tiled walls as they conceal and protect exposed tile edges and eliminate the need for unsightly caulking. The assortment of available accessories eliminate the need for mitering, expedite installation time, and provide a nice, clean finish.

Resistant to staining, scratching, and high heat, tiled countertops require no maintenance and are easy to clean with standard household products. Cover the subassembly using a profile with a wide reveal, or frame a designated area for bonding accent tile. Do-away with caulking around the sink and bring the elegance of your tile installation to the next level.



Backsplash trim: Schluter®-QUADEC in bright white (page 41)  
Counter trim: Schluter®-RONDEC-STEP in brushed chrome (page 49)





**Schluter®-JOLLY**

**Schluter®-JOLLY** is a decorative profile featuring a 90° angle designed to finish and protect external corners and other tile edges in wall applications. Its 90° angle creates a clean, flush look on wall corner installations, and the joint spacers on both sides of the profile ensure consistent grout joints and perfect symmetry. Matching corners are available, which feature innovative plug-in connections that result in clean, visually appealing corner applications.

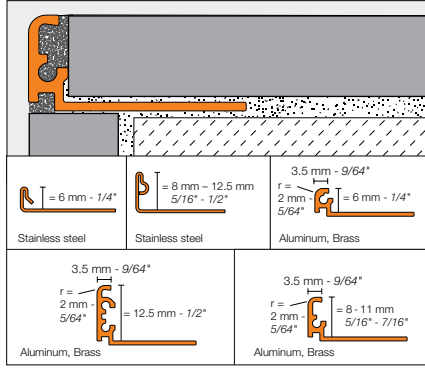

**Stainless Steel**

<b>Schluter®-JOLLY</b>				
Length = 2.5 m - 8' 2-1/2"	<b>Brushed stainless steel 304 (1.4301 = V2A) (EB)</b>			
H = mm - in.	Profile	\$ / Length	Outside corner	\$ / Unit
6 - 1/4	J 60 EB	43.64	EV / J 60 EB	21.50
8 - 5/16	J 80 EB	45.29	EV / J 80 EB	21.50
10 - 3/8	J 100 EB	47.75	EV / J 100 EB	21.50
11 - 7/16	J 110 EB	49.36	EV / J 110 EB	21.50
12.5 - 1/2	J 125 EB	49.40	EV / J 125 EB	21.50

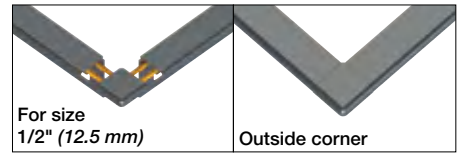
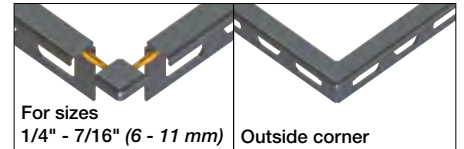

**Brass**

<b>Schluter®-JOLLY</b>				
Length = 2.5 m - 8' 2-1/2"	<b>Chrome-plated solid brass (MC) *</b>			
H = mm - in.	Profile	\$ / Length	Outside corner	\$ / Unit
6 - 1/4	J 60 MC	86.32	EV / J 60 MC	20.57
8 - 5/16	J 80 MC	89.33	EV / J 80 MC	20.57
10 - 3/8	J 100 MC	90.49	EV / J 100 MC	20.57
11 - 7/16	J 110 MC	91.39	EV / J 110 MC	20.57
12.5 - 1/2	J 125 MC	92.00	EV / J 125 MC	20.57



Connector	Quantity	\$ / Pkg.
V / J PP4	4	2.72



**Note:** The anchoring leg of **Schluter®-JOLLY** is available with a special radius perforation so that the profile can be used to form curves.

- Price surcharge: \$0.70 per foot
- Chrome-plated brass requires a relatively large bending radius
- Item No.: R / Profile No. (e.g., R/J 60 EB)
- For delivery time, please call Customer Service



\* **WARNING:** Reproductive Harm - www.P65Warnings.ca.gov



Anodized Aluminum

<b>Schluter®-JOLLY</b>									
Length = 2.5 m - 8' 2-1/2"		Satin anodized aluminum (AE)				Polished chrome anodized aluminum (ACG)			
H = mm - in.	Profile	\$/ Length	Outside corner	\$/ Unit	Profile	\$/ Length	Outside corner	\$/ Unit	
6 - 1/4	J 60 AE	15.56	EV / J 60 AE	8.20	J 60 ACG	18.18	EV / J 60 ACG	10.73	
8 - 5/16	J 80 AE	15.45	EV / J 80 AE	8.20	J 80 ACG	19.43	EV / J 80 ACG	10.73	
10 - 3/8	J 100 AE	16.39	EV / J 100 AE	8.20	J 100 ACG	21.50	EV / J 100 ACG	10.73	
11 - 7/16	J 110 AE	17.46	EV / J 110 AE	8.20	J 110 ACG	21.71	EV / J 110 ACG	10.73	
12.5 - 1/2	J 125 AE	17.57	EV / J 125 AE	8.20	J 125 ACG	22.74	EV / J 125 ACG	10.73	

Length = 2.5 m - 8' 2-1/2"		Brushed chrome anodized aluminum (ACGB)				Satin nickel anodized aluminum (AT)			
H = mm - in.	Profile	\$/ Length	Outside corner	\$/ Unit	Profile	\$/ Length	Outside corner	\$/ Unit	
6 - 1/4	J 60 ACGB	19.43	EV / J 60 ACGB	10.73	J 60 AT	18.49	EV / J 60 AT	10.73	
8 - 5/16	J 80 ACGB	19.96	EV / J 80 ACGB	10.73	J 80 AT	18.88	EV / J 80 AT	10.73	
10 - 3/8	J 100 ACGB	22.08	EV / J 100 ACGB	10.73	J 100 AT	19.24	EV / J 100 AT	10.73	
11 - 7/16	J 110 ACGB	22.52	EV / J 110 ACGB	10.73	J 110 AT	19.43	EV / J 110 AT	10.73	
12.5 - 1/2	J 125 ACGB	23.31	EV / J 125 ACGB	10.73	J 125 AT	19.88	EV / J 125 AT	10.73	

Length = 2.5 m - 8' 2-1/2"		Polished nickel anodized aluminum (ATG)				Brushed nickel anodized aluminum (ATGB)			
H = mm - in.	Profile	\$/ Length	Outside corner	\$/ Unit	Profile	\$/ Length	Outside corner	\$/ Unit	
6 - 1/4	J 60 ATG	23.93	EV / J 60 ATG	10.73	J 60 ATGB	21.48	EV / J 60 ATGB	10.73	
8 - 5/16	J 80 ATG	24.30	EV / J 80 ATG	10.73	J 80 ATGB	21.73	EV / J 80 ATGB	10.73	
10 - 3/8	J 100 ATG	24.95	EV / J 100 ATG	10.73	J 100 ATGB	22.19	EV / J 100 ATGB	10.73	
11 - 7/16	J 110 ATG	25.07	EV / J 110 ATG	10.73	J 110 ATGB	22.41	EV / J 110 ATGB	10.73	
12.5 - 1/2	J 125 ATG	25.16	EV / J 125 ATG	10.73	J 125 ATGB	23.16	EV / J 125 ATGB	10.73	

Length = 2.5 m - 8' 2-1/2"		Satin copper anodized aluminum (AK)				Polished copper anodized aluminum (AKG)			
H = mm - in.	Profile	\$/ Length	Outside corner	\$/ Unit	Profile	\$/ Length	Outside corner	\$/ Unit	
6 - 1/4	J 60 AK	18.49	EV / J 60 AK	10.73	J 60 AKG	23.93	EV / J 60 AKG	10.73	
8 - 5/16	J 80 AK	19.24	EV / J 80 AK	10.73	J 80 AKG	24.30	EV / J 80 AKG	10.73	
10 - 3/8	J 100 AK	19.62	EV / J 100 AK	10.73	J 100 AKG	24.95	EV / J 100 AKG	10.73	
11 - 7/16	J 110 AK	19.82	EV / J 110 AK	10.73	J 110 AKG	25.07	EV / J 110 AKG	10.73	
12.5 - 1/2	J 125 AK	20.26	EV / J 125 AK	10.73	J 125 AKG	25.16	EV / J 125 AKG	10.73	

Length = 2.5 m - 8' 2-1/2"		Brushed copper anodized aluminum (AKGB)				Satin brass anodized aluminum (AM)			
H = mm - in.	Profile	\$/ Length	Outside corner	\$/ Unit	Profile	\$/ Length	Outside corner	\$/ Unit	
6 - 1/4	J 60 AKGB	21.48	EV / J 60 AKGB	10.73	J 60 AM	15.51	EV / J 60 AM	10.73	
8 - 5/16	J 80 AKGB	22.16	EV / J 80 AKGB	10.73	J 80 AM	16.12	EV / J 80 AM	10.73	
10 - 3/8	J 100 AKGB	22.62	EV / J 100 AKGB	10.73	J 100 AM	17.98	EV / J 100 AM	10.73	
11 - 7/16	J 110 AKGB	22.84	EV / J 110 AKGB	10.73	J 110 AM	18.34	EV / J 110 AM	10.73	
12.5 - 1/2	J 125 AKGB	23.16	EV / J 125 AKGB	10.73	J 125 AM	19.21	EV / J 125 AM	10.73	



Schluter®-JOLLY								
Length = 2.5 m - 8' 2-1/2"	Polished brass anodized aluminum (AMG)				Brushed brass anodized aluminum (AMGB)			
H = mm - in.	Profile	\$ / Length	Outside corner	\$ / Unit	Profile	\$ / Length	Outside corner	\$ / Unit
6 - 1/4	J 60 AMG	18.18	EV / J 60 AMG	10.73	J 60 AMGB	20.67	EV / J 60 AMGB	10.73
8 - 5/16	J 80 AMG	19.43	EV / J 80 AMG	10.73	J 80 AMGB	21.38	EV / J 80 AMGB	10.73
10 - 3/8	J 100 AMG	21.91	EV / J 100 AMG	10.73	J 100 AMGB	22.94	EV / J 100 AMGB	10.73
11 - 7/16	J 110 AMG	22.35	EV / J 110 AMG	10.73	J 110 AMGB	23.40	EV / J 110 AMGB	10.73
12.5 - 1/2	J 125 AMG	23.18	EV / J 125 AMG	10.73	J 125 AMGB	24.16	EV / J 125 AMGB	10.73

Length = 2.5 m - 8' 2-1/2"	Brushed antique bronze anodized aluminum (ABGB)				Bright black anodized aluminum (AGSG)			
H = mm - in.	Profile	\$ / Length	Outside corner	\$ / Unit	Profile	\$ / Length	Outside corner	\$ / Unit
6 - 1/4	J 60 ABGB	22.95	EV / J 60 ABGB	10.73	J 60 AGSG	18.51	EV / J 60 AGSG	10.73
8 - 5/16	J 80 ABGB	24.14	EV / J 80 ABGB	10.73	J 80 AGSG	18.89	EV / J 80 AGSG	10.73
10 - 3/8	J 100 ABGB	24.87	EV / J 100 ABGB	10.73	J 100 AGSG	20.27	EV / J 100 AGSG	10.73
11 - 7/16	J 110 ABGB	25.62	EV / J 110 ABGB	10.73	J 110 AGSG	20.47	EV / J 110 AGSG	10.73
12.5 - 1/2	J 125 ABGB	26.94	EV / J 125 ABGB	10.73	J 125 AGSG	20.91	EV / J 125 AGSG	10.73

Length = 2.5 m - 8' 2-1/2"	Brushed graphite anodized aluminum (AGRB)			
H = mm - in.	Profile	\$ / Length	Outside corner	\$ / Unit
6 - 1/4	J 60 AGRB	22.95	EV / J 60 AGRB	10.73
8 - 5/16	J 80 AGRB	24.14	EV / J 80 AGRB	10.73
10 - 3/8	J 100 AGRB	25.35	EV / J 100 AGRB	10.73
11 - 7/16	J 110 AGRB	25.86	EV / J 110 AGRB	10.73
12.5 - 1/2	J 125 AGRB	26.94	EV / J 125 AGRB	10.73

10-foot (3.05 m) JOLLY Profiles – Anodized Aluminum								
Length = 3.05 m - 10'	Satin anodized aluminum (AE)		Polished chrome anodized aluminum (ACG)		Satin nickel anodized aluminum (AT)		Brushed antique bronze anodized aluminum (ABGB)	
H = mm - in.	Profile	\$ / Length	Profile	\$ / Length	Profile	\$ / Length	Profile	\$ / Length
8 - 5/16	J 80 AE / 300	19.32	J 80 ACG / 300	24.29	J 80 AT / 300	23.61	J 80 ABGB / 300	30.18
10 - 3/8	J 100 AE / 300	20.49	J 100 ACG / 300	26.86	J 100 AT / 300	24.06	J 100 ABGB / 300	31.10
12.5 - 1/2	J 125 AE / 300	21.97	J 125 ACG / 300	28.41	J 125 AT / 300	24.85	J 125 ABGB / 300	33.67

Special shipping conditions apply, see pages 191-192.

Connector	Quantity	\$ / Pkg.
V / J PP4	4	2.72



**Note:** The anchoring leg of Schluter®-JOLLY is available with a special radius perforation so that the profile can be used to form curves.

- Price surcharge: \$0.70 per foot
- Polished aluminum finishes require a relatively large bending radius
- Item No.: R / Profile No. (e.g., R/J 60 ACGB)
- For delivery time, please call Customer Service





Schluter®-TRENDLINE Textured Color-coated Aluminum

Schluter®-JOLLY					
Length = 2.5 m - 8' 2-1/2"		Textured color-coated aluminum (TS)			
H = mm - in.	Profile	\$/ Length	Outside corner	\$/ Unit	
6 - 1/4	J 60 + color*	32.72	EV / J 60 + color*	15.47	
8 - 5/16	J 80 + color*	33.45	EV / J 80 + color*	15.47	
10 - 3/8	J 100 + color*	34.10	EV / J 100 + color*	15.47	
11 - 7/16	J 110 + color*	34.45	EV / J 110 + color*	15.47	
12.5 - 1/2	J 125 + color*	35.13	EV / J 125 + color*	15.47	

**\*Color Codes**

\* To complete the item number, add the **color** code (e.g., J 60 **TSC**).

Matte White and Matte Black

Length = 2.5 m - 8' 2-1/2"		Textured color-coated aluminum			
H = mm - in.	Profile	\$/ Length	Outside corner	\$/ Unit	
6 - 1/4	J 60 + color*	26.18	EV / J 60 + color*	13.94	
8 - 5/16	J 80 + color*	26.75	EV / J 80 + color*	13.94	
10 - 3/8	J 100 + color*	27.27	EV / J 100 + color*	13.94	
11 - 7/16	J 110 + color*	27.56	EV / J 110 + color*	13.94	
12.5 - 1/2	J 125 + color*	28.11	EV / J 125 + color*	13.94	

**\*Color Codes**

\* To complete the item number, add the **color** code (e.g., J 60 **MGS**).

10-foot (3.05 m) JOLLY Profiles – Textured Color-coated Aluminum							
Length = 3.05 m - 10'		Textured color-coated aluminum (TS)		Matte white (MBW)		Matte black (MGS)	
H = mm - in.	Profile	\$/ Length	Profile	\$/ Length	Profile	\$/ Length	
6 - 1/4	J 60 + color* / 300	39.27	J 60 MBW / 300	31.42	J 60 MGS / 300	31.42	
8 - 5/16	J 80 + color* / 300	40.15	J 80 MBW / 300	32.10	J 80 MGS / 300	32.10	
10 - 3/8	J 100 + color* / 300	40.92	J 100 MBW / 300	32.73	J 100 MGS / 300	32.73	
11 - 7/16	J 110 + color* / 300	41.34	J 110 MBW / 300	33.08	J 110 MGS / 300	33.08	
12.5 - 1/2	J 125 + color* / 300	42.16	J 125 MBW / 300	33.73	J 125 MGS / 300	33.73	

Special shipping conditions apply, see pages 191-192.

Color-coated Aluminum

Length = 2.5 m - 8' 2-1/2"		Color-coated aluminum			
H = mm - in.	Profile	\$/ Length	Outside corner	\$/ Unit	
6 - 1/4	J 60 + color*	18.51	EV / J 60 + color*	9.96	
8 - 5/16	J 80 + color*	18.89	EV / J 80 + color*	9.96	
10 - 3/8	J 100 + color*	20.27	EV / J 100 + color*	9.96	
11 - 7/16	J 110 + color*	20.60	EV / J 110 + color*	9.96	
12.5 - 1/2	J 125 + color*	20.91	EV / J 125 + color*	9.96	

**\*Color Codes**

\* To complete the item number, add the **color** code (e.g., J 60 **G**).

Connector	Quantity	\$/ Pkg.
V / J PP4	4	2.72



**Note:** The anchoring leg of Schluter®-JOLLY is available with a special radius perforation so that the profile can be used to form curves.

- Price surcharge: \$0.70 per foot
- Color-coated aluminum profiles require a relatively large bending radius
- Item No.: R / Profile No. (e.g., R/J 80 TSC)
- For delivery time, please call Customer Service





Schluter®-JOLLY in matte black (page 26)

### Schluter®-JOLLY-P

**Schluter®-JOLLY-P** is a PVC profile featuring an 87° angle designed to finish and protect external corners and other tile edges in wall applications. The vertical wall section of the profile provides a decorative finish and protects adjacent tiles. JOLLY-P in sizes 1/4" (6 mm) and higher features an integrated joint spacer that establishes a defined joint cavity between the tile and the profile.

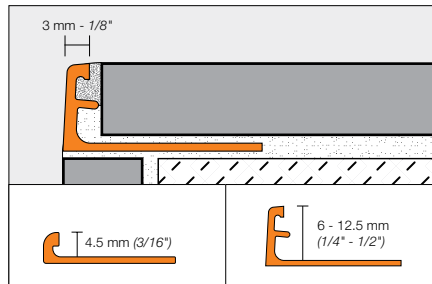

Schluter®-JOLLY-P		
Length = 2.5 m - 8' 2-1/2"	PVC	
H = mm - in.	Item No.	\$/ Length
4.5 - 3/16	color* + 45	6.02
6 - 1/4	color* + 60	6.12
8 - 5/16	color* + 80	6.39
10 - 3/8	color* + 100	6.53
11 - 7/16	color* + 110	6.72
12.5 - 1/2	color* + 125	6.89

**\*Color Codes**

Bright white	White	Sand pebble	Bahama	Light beige	Light grey
Classic grey	Grey	Black			

\* To complete the item number, add the **color** code (e.g., **G** 45).

10-foot (3.05 m) JOLLY-P Profiles – PVC		
Length = 3.05 m - 10'	Bright white (BW)	
H = mm - in.	Item No.	\$/ Length
8 - 5/16	BW 80 / 300	7.97
10 - 3/8	BW 100 / 300	8.17
12.5 - 1/2	BW 125 / 300	8.61

Special shipping conditions apply, see pages 191-192.

### Get perfect cuts!

**Schluter®-SNIPS** for PVC profiles. See page 180 for more information.





## Schluter®-SCHIENE

**Schluter®-SCHIENE** is an edging profile featuring an 87° angle designed to finish and protect external corners and other tile edges. Though SCHIENE is typically used in floor applications, the finishes listed in this section are specifically suited for use in wall applications. SCHIENE in sizes 1/4" (6 mm) and higher features an integrated joint spacer that establishes a defined joint cavity between the tile and the profile.

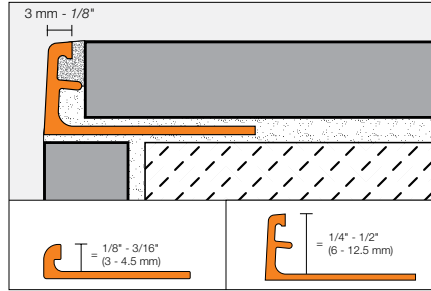

Schluter®-SCHIENE						
Length = 2.5 m - 8' 2-1/2"	Chrome-plated* solid brass (MC)		Bright black anodized aluminum (AGSG)		Brushed graphite anodized aluminum (AGRB)	
H = mm - in.	Item No.	\$/ Length	Item No.	\$/ Length	Item No.	\$/ Length
4.5 - 3/16	-	-	A 45 AGSG	17.52	-	-
6 - 1/4	MC 60	86.32	A 60 AGSG	18.51	A 60 AGRB	22.95
8 - 5/16	MC 80	89.33	A 80 AGSG	18.89	A 80 AGRB	24.14
10 - 3/8	MC 100	90.49	A 100 AGSG	20.27	A 100 AGRB	25.35
12.5 - 1/2	MC 125	92.00	A 125 AGSG	20.91	A 125 AGRB	26.94

## Color-coated Aluminum

Length = 2.5 m - 8' 2-1/2"	Color-coated aluminum		
H = mm - in.	Item No.	\$/ Length	
3 - 1/8	A 30 + color*	16.90	
4.5 - 3/16	A 45 + color*	17.52	
6 - 1/4	A 60 + color*	18.51	
8 - 5/16	A 80 + color*	18.89	
10 - 3/8	A 100 + color*	20.27	
11 - 7/16	A 110 + color*	20.60	
12.5 - 1/2	A 125 + color*	20.91	

### \*Color Codes



\* To complete the item number, add the **color** code (e.g., A 45 **G**).

<sup>1</sup> Red brown (RB) is only available in sizes 80, 100, and 125.

**Note:** The anchoring leg of **Schluter®-SCHIENE** is available with a special radius perforation so that the profile can be used to form curves.

- Price surcharge: \$0.70 per foot
- Available in all materials
- Chrome-plated brass, color-coated aluminum, and bright/polished finishes require a relatively large bending radius
- Item No.: R / Profile No. (e.g., R/A 80 AGRB)
- For delivery time, please call Customer Service





## Schluter®-RONDEC

**Schluter®-RONDEC** is a finishing and edge-protection profile for tiled edges and outside corners of tiled surfaces. The reveal of the profile forms a symmetrically rounded corner along the surface edge. RONDEC allows for color coordination with tile and grout and the creation of interesting accents in decorative designs. The profile can be combined with the Schluter®-DESIGNLINE border profile for further design options (page 46). RONDEC in aluminum and PVC features an integrated joint spacer that establishes a defined joint cavity between the tile and the profile.

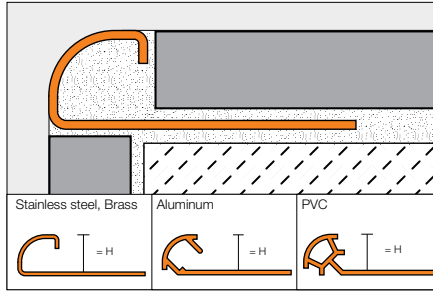

### Accessories



90° Outside corner

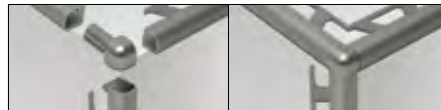

90° Inside corner



RONDEC prefabricated corners eliminate the need for a mitered edge.

EV/

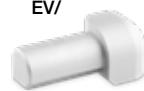

ED/



IV/



ID/

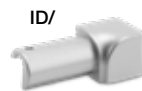

Corners with item numbers beginning with EV/ are milled out of solid aluminum and corners with item numbers beginning with ED/ are die cast metal.



90° Double-leg outside corner (E2L/)



90° Double-leg inside corner (I2L/)



Double-leg corners simplify the framing of smaller elements with the RONDEC profile, such as niches, windows, etc. The legs are detachable for use in applications where a single-leg corner is needed.



Sink corner with 3/8" (10 mm) radius (I2S/)



Sink corner with 1-1/2" (38 mm) radius (ISK/)



Stainless steel sink corners are used with the RONDEC profile to produce tiled-under sinks. The corners have a large radius (3/8" - 10 mm or 1-1/2" - 38 mm) that allows them to match up to the contour of most standard sinks. The 3/8" corner piece features a double-leg design for ease of installation, while the 1-1/2" corner includes two stainless steel connectors to maintain the alignment of the corner piece and profiles during installation.



Connector Stainless Steel (V/)



Connector PVC (V/)

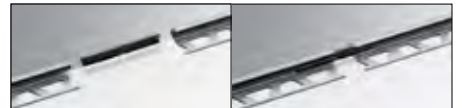

RONDEC connectors simplify the alignment of adjacent profile sections. Connectors are made of either PVC for aluminum profiles or stainless steel for stainless steel profiles.

End cap



End caps feature a bendable leg that is inserted into the RONDEC profile, and a brushed stainless steel plate that covers the open area of the profile in applications where the end of the profile is to be left exposed. RONDEC end caps can be used with stainless steel and brushed stainless steel RONDEC profiles.



Stainless Steel 304 (1.4301 = V2A)



**Note:** RONDEC in sizes 60, 80, 100, and 125 is also available in stainless steel 316L (1.4404 = V4A). Contact customer service for price and availability.

Schluter®-RONDEC									
Stainless steel 304 (1.4301 = V2A) (E)									
Length = 2.5 m - 8' 2-1/2"	H = mm - in.	Profile	\$ / Length	Outside corner, 90°	\$ / Unit	Sink corner 3/8" (10 mm) radius	\$ / Unit	Sink corner 1-1/2" (38 mm) radius	\$ / Unit
	4.5 - 3/16	RO 45 E	45.25	EV/RO 45 E	33.44	-	-	-	-
	6 - 1/4	RO 60 E	47.09	EV/RO 60 E	33.44	-	-	-	-
	7 - 9/32	RO 70 E	48.84	EV/RO 70 E	35.92	-	-	-	-
	8 - 5/16	RO 80 E	49.17	EV/RO 80 E	35.92	I2S/RO 80 EV/2A	53.93	ISK/RO 80 E/38	28.08
	9 - 11/32	RO 90 E	52.51	EV/RO 90 E	38.59	-	-	-	-
	10 - 3/8	RO 100 E	52.80	EV/RO 100 E	38.59	I2S/RO 100 EV/2A	53.93	ISK/RO 100 E/38	28.08
	11 - 7/16	RO 110 E	54.52	EV/RO 110 E	39.93	-	-	-	-
	12.5 - 1/2	RO 125 E	56.24	EV/RO 125 E	39.93	I2S/RO 125 EV/2A	53.93	ISK/RO 125 E/38	28.08
	15 - 9/16	RO 150 E	63.71	EV/RO 150 E	40.86	-	-	-	-

Brushed stainless steel 304 (1.4301 = V2A) (EB)						
Die cast metal with stainless steel appearance						
Length = 2.5 m - 8' 2-1/2"	H = mm - in.	End cap	\$ / Unit	Outside corner, 90°	Inside corner, 90°	\$ / Unit
	6 - 1/4	-	-	ED/RO 60 E	ID/RO 60 E	7.91
	8 - 5/16	EK/RO 80 EB	4.80	ED/RO 80 E	ID/RO 80 E	7.91
	10 - 3/8	EK/RO 100 EB	4.80	ED/RO 100 E	ID/RO 100 E	7.91
	12.5 - 1/2	EK/RO 125 EB	4.80	ED/RO 125 E	ID/RO 125 E	7.91

Brushed stainless steel 304 (1.4301 = V2A) (EB)									
Length = 2.5 m - 8' 2-1/2"	H = mm - in.	Profile	\$ / Length	Outside corner, 90°	\$ / Unit	Sink corner 3/8" (10 mm) radius	\$ / Unit	End cap	\$ / Unit
	6 - 1/4	RO 60 EB	72.23	EV/RO 60 EB	40.58	-	-	-	-
	7 - 9/32	RO 70 EB	73.65	EV/RO 70 EB	40.58	-	-	-	-
	8 - 5/16	RO 80 EB	75.39	EV/RO 80 EB	40.58	I2S/RO 80 EB/V2A	53.93	EK/RO 80 EB	4.80
	9 - 11/32	RO 90 EB	76.90	EV/RO 90 EB	40.58	-	-	-	-
	10 - 3/8	RO 100 EB	78.74	EV/RO 100 EB	46.82	I2S/RO 100 EB/V2A	53.93	EK/RO 100 EB	4.80
	11 - 7/16	RO 110 EB	80.30	EV/RO 110 EB	46.82	-	-	-	-
	12.5 - 1/2	RO 125 EB	82.18	EV/RO 125 EB	46.82	I2S/RO 125 EB/V2A	53.93	EK/RO 125 EB	4.80
	15 - 9/16	RO 150 EB	90.42	EV/RO 150 EB	49.61	-	-	-	-

Stainless steel 304 (1.4301 = V2A) (E)		
H = mm - in.	Connector	\$ / Unit
6 - 1/4	V/RO 60 E	6.29
8 - 5/16	V/RO 80 E	6.29
10 - 3/8	V/RO 100 E	6.29
11 - 7/16	V/RO 110 E	6.29
12.5 - 1/2	V/RO 125 E	6.29





Brass



Schluter®-RONDEC						
Length = 2.5 m - 8' 2-1/2"		Chrome-plated* solid brass (MC)		Aluminum with polished chrome finish		
H = mm - in.	Profile	\$/ Length	Outside corner, 90°	Inside corner, 90°	\$/ Unit	
6 - 1/4	RO 60 MC	123.82	EV/RO 60 ACG	IV/RO 60 ACG	9.38	
8 - 5/16	RO 80 MC	130.93	EV/RO 80 ACG	IV/RO 80 ACG	9.38	
10 - 3/8	RO 100 MC	136.56	EV/RO 100 ACG	IV/RO 100 ACG	9.38	
12.5 - 1/2	RO 125 MC	143.85	EV/RO 125 ACG	IV/RO 125 ACG	9.38	

Anodized Aluminum



Schluter®-RONDEC						
Length = 2.5 m - 8' 2-1/2"		Satin anodized aluminum (AE)				
H = mm - in.	Profile	\$/ Length	Outside corner, 90°	Inside corner, 90°	\$/ Unit	Connector
6 - 1/4	RO 60 AE	17.91	EV/RO 60 AE	IV/RO 60 AE	7.91	V/RO 60
8 - 5/16	RO 80 AE	18.69	EV/RO 80 AE	IV/RO 80 AE	7.91	V/RO 80
10 - 3/8	RO 100 AE	20.19	EV/RO 100 AE	IV/RO 100 AE	7.91	V/RO 100
12.5 - 1/2	RO 125 AE	22.55	EV/RO 125 AE	IV/RO 125 AE	7.91	V/RO 125

H = mm - in.	Double-leg outside corner, 90°	Double-leg inside corner, 90°	\$/ Unit
8 - 5/16	E2L/RO 80 AE	I2L/RO 80 AE	16.97
10 - 3/8	E2L/RO 100 AE	I2L/RO 100 AE	16.97
12.5 - 1/2	E2L/RO 125 AE	I2L/RO 125 AE	16.97

Length = 2.5 m - 8' 2-1/2"		Polished chrome anod. alu. (ACG)				
H = mm - in.	Profile	\$/ Length	Outside corner, 90°	Inside corner, 90°	\$/ Unit	Connector
6 - 1/4	RO 60 ACG	21.90	EV/RO 60 ACG	IV/RO 60 ACG	9.38	V/RO 60
8 - 5/16	RO 80 ACG	24.55	EV/RO 80 ACG	IV/RO 80 ACG	9.38	V/RO 80
10 - 3/8	RO 100 ACG	27.19	EV/RO 100 ACG	IV/RO 100 ACG	9.38	V/RO 100
12.5 - 1/2	RO 125 ACG	31.82	EV/RO 125 ACG	IV/RO 125 ACG	9.38	V/RO 125

H = mm - in.	Double-leg outside corner, 90°	Double-leg inside corner, 90°	\$/ Unit
8 - 5/16	E2L/RO 80 ACG	I2L/RO 80 ACG	16.32
10 - 3/8	E2L/RO 100 ACG	I2L/RO 100 ACG	16.32
12.5 - 1/2	E2L/RO 125 ACG	I2L/RO 125 ACG	16.32

Length = 2.5 m - 8' 2-1/2"		Brushed chrome anod. alu. (ACGB)				
H = mm - in.	Profile	\$/ Length	Outside corner, 90°	Inside corner, 90°	\$/ Unit	Connector
6 - 1/4	RO 60 ACGB	22.55	EV/RO 60 ACGB	IV/RO 60 ACGB	14.77	V/RO 60
8 - 5/16	RO 80 ACGB	25.20	EV/RO 80 ACGB	IV/RO 80 ACGB	14.77	V/RO 80
10 - 3/8	RO 100 ACGB	28.51	EV/RO 100 ACGB	IV/RO 100 ACGB	14.77	V/RO 100
12.5 - 1/2	RO 125 ACGB	33.16	EV/RO 125 ACGB	IV/RO 125 ACGB	14.77	V/RO 125

H = mm - in.	Double-leg outside corner, 90°	Double-leg inside corner, 90°	\$/ Unit
8 - 5/16	E2L/RO 80 ACGB	I2L/RO 80 ACGB	20.13
10 - 3/8	E2L/RO 100 ACGB	I2L/RO 100 ACGB	20.13
12.5 - 1/2	E2L/RO 125 ACGB	I2L/RO 125 ACGB	20.13



<b>Schluter®-RONDEC</b>							
Length = 2.5 m - 8' 2-1/2"	<b>Satin nickel anod. alu. (AT)</b>						
H = mm - in.	Profile	\$ / Length	Outside corner, 90°	Inside corner, 90°	\$ / Unit	Connector	\$ / Unit
6 - 1/4	RO 60 AT	<b>18.33</b>	EV/RO 60 AT	IV/RO 60 AT	<b>7.98</b>	V/RO 60	<b>2.63</b>
8 - 5/16	RO 80 AT	<b>19.58</b>	EV/RO 80 AT	IV/RO 80 AT	<b>7.98</b>	V/RO 80	<b>2.63</b>
10 - 3/8	RO 100 AT	<b>20.46</b>	EV/RO 100 AT	IV/RO 100 AT	<b>7.98</b>	V/RO 100	<b>2.63</b>
12.5 - 1/2	RO 125 AT	<b>23.21</b>	EV/RO 125 AT	IV/RO 125 AT	<b>7.98</b>	V/RO 125	<b>2.63</b>

H = mm - in.	Double-leg outside corner, 90°	Double-leg inside corner, 90°	\$ / Unit
8 - 5/16	E2L/RO 80 AT	I2L/RO 80 AT	<b>16.74</b>
10 - 3/8	E2L/RO 100 AT	I2L/RO 100 AT	<b>16.74</b>
12.5 - 1/2	E2L/RO 125 AT	I2L/RO 125 AT	<b>16.74</b>

Length = 2.5 m - 8' 2-1/2"	<b>Polished nickel anod. alu. (ATG)</b>						
H = mm - in.	Profile	\$ / Length	Outside corner, 90°	Inside corner, 90°	\$ / Unit	Connector	\$ / Unit
6 - 1/4	RO 60 ATG	<b>23.90</b>	EV/RO 60 ATG	IV/RO 60 ATG	<b>9.38</b>	V/RO 60	<b>2.63</b>
8 - 5/16	RO 80 ATG	<b>25.20</b>	EV/RO 80 ATG	IV/RO 80 ATG	<b>9.38</b>	V/RO 80	<b>2.63</b>
10 - 3/8	RO 100 ATG	<b>29.85</b>	EV/RO 100 ATG	IV/RO 100 ATG	<b>9.38</b>	V/RO 100	<b>2.63</b>
12.5 - 1/2	RO 125 ATG	<b>33.82</b>	EV/RO 125 ATG	IV/RO 125 ATG	<b>9.38</b>	V/RO 125	<b>2.63</b>

H = mm - in.	Double-leg outside corner, 90°	Double-leg inside corner, 90°	\$ / Unit
8 - 5/16	E2L/RO 80 ATG	I2L/RO 80 ATG	<b>16.97</b>
10 - 3/8	E2L/RO 100 ATG	I2L/RO 100 ATG	<b>16.97</b>
12.5 - 1/2	E2L/RO 125 ATG	I2L/RO 125 ATG	<b>16.97</b>

Length = 2.5 m - 8' 2-1/2"	<b>Brushed nickel anod. alu. (ATGB)</b>						
H = mm - in.	Profile	\$ / Length	Outside corner, 90°	Inside corner, 90°	\$ / Unit	Connector	\$ / Unit
6 - 1/4	RO 60 ATGB	<b>25.20</b>	EV/RO 60 ATGB	IV/RO 60 ATGB	<b>14.61</b>	V/RO 60	<b>2.63</b>
8 - 5/16	RO 80 ATGB	<b>27.85</b>	EV/RO 80 ATGB	IV/RO 80 ATGB	<b>14.61</b>	V/RO 80	<b>2.63</b>
10 - 3/8	RO 100 ATGB	<b>30.59</b>	EV/RO 100 ATGB	IV/RO 100 ATGB	<b>14.61</b>	V/RO 100	<b>2.63</b>
12.5 - 1/2	RO 125 ATGB	<b>35.47</b>	EV/RO 125 ATGB	IV/RO 125 ATGB	<b>14.61</b>	V/RO 125	<b>2.63</b>

H = mm - in.	Double-leg outside corner, 90°	Double-leg inside corner, 90°	\$ / Unit
8 - 5/16	E2L/RO 80 ATGB	I2L/RO 80 ATGB	<b>20.92</b>
10 - 3/8	E2L/RO 100 ATGB	I2L/RO 100 ATGB	<b>20.92</b>
12.5 - 1/2	E2L/RO 125 ATGB	I2L/RO 125 ATGB	<b>20.92</b>

Length = 2.5 m - 8' 2-1/2"	<b>Satin copper anod. alu. (AK)</b>						
H = mm - in.	Profile	\$ / Length	Outside corner, 90°	Inside corner, 90°	\$ / Unit	Connector	\$ / Unit
6 - 1/4	RO 60 AK	<b>19.24</b>	EV/RO 60 AK	IV/RO 60 AK	<b>7.91</b>	V/RO 60	<b>2.63</b>
8 - 5/16	RO 80 AK	<b>20.56</b>	EV/RO 80 AK	IV/RO 80 AK	<b>7.91</b>	V/RO 80	<b>2.63</b>
10 - 3/8	RO 100 AK	<b>21.87</b>	EV/RO 100 AK	IV/RO 100 AK	<b>7.91</b>	V/RO 100	<b>2.63</b>
12.5 - 1/2	RO 125 AK	<b>23.21</b>	EV/RO 125 AK	IV/RO 125 AK	<b>7.91</b>	V/RO 125	<b>2.63</b>

H = mm - in.	Double-leg outside corner, 90°	Double-leg inside corner, 90°	\$ / Unit
8 - 5/16	E2L/RO 80 AK	I2L/RO 80 AK	<b>16.47</b>
10 - 3/8	E2L/RO 100 AK	I2L/RO 100 AK	<b>16.47</b>
12.5 - 1/2	E2L/RO 125 AK	I2L/RO 125 AK	<b>16.47</b>



<b>Schluter®-RONDEC</b>							
Length = 2.5 m - 8' 2-1/2"		Polished copper anod. alu. (AKG)					
H = mm - in.	Profile	\$ / Length	Outside corner, 90°	Inside corner, 90°	\$ / Unit	Connector	\$ / Unit
6 - 1/4	RO 60 AKG	<b>23.90</b>	EV/RO 60 AKG	IV/RO 60 AKG	<b>9.38</b>	V/RO 60	<b>2.63</b>
8 - 5/16	RO 80 AKG	<b>25.20</b>	EV/RO 80 AKG	IV/RO 80 AKG	<b>9.38</b>	V/RO 80	<b>2.63</b>
10 - 3/8	RO 100 AKG	<b>29.85</b>	EV/RO 100 AKG	IV/RO 100 AKG	<b>9.38</b>	V/RO 100	<b>2.63</b>
12.5 - 1/2	RO 125 AKG	<b>33.82</b>	EV/RO 125 AKG	IV/RO 125 AKG	<b>9.38</b>	V/RO 125	<b>2.63</b>

H = mm - in.	Double-leg outside corner, 90°	Double-leg inside corner, 90°	\$ / Unit
8 - 5/16	E2L/RO 80 AKG	I2L/RO 80 AKG	<b>16.80</b>
10 - 3/8	E2L/RO 100 AKG	I2L/RO 100 AKG	<b>16.80</b>
12.5 - 1/2	E2L/RO 125 AKG	I2L/RO 125 AKG	<b>16.80</b>

Length = 2.5 m - 8' 2-1/2"		Brushed copper anod. alu. (AKGB)					
H = mm - in.	Profile	\$ / Length	Outside corner, 90°	Inside corner, 90°	\$ / Unit	Connector	\$ / Unit
6 - 1/4	RO 60 AKGB	<b>25.20</b>	EV/RO 60 AKGB	IV/RO 60 AKGB	<b>14.77</b>	V/RO 60	<b>2.63</b>
8 - 5/16	RO 80 AKGB	<b>27.85</b>	EV/RO 80 AKGB	IV/RO 80 AKGB	<b>14.77</b>	V/RO 80	<b>2.63</b>
10 - 3/8	RO 100 AKGB	<b>31.17</b>	EV/RO 100 AKGB	IV/RO 100 AKGB	<b>14.77</b>	V/RO 100	<b>2.63</b>
12.5 - 1/2	RO 125 AKGB	<b>35.47</b>	EV/RO 125 AKGB	IV/RO 125 AKGB	<b>14.77</b>	V/RO 125	<b>2.63</b>

H = mm - in.	Double-leg outside corner, 90°	Double-leg inside corner, 90°	\$ / Unit
8 - 5/16	E2L/RO 80 AKGB	I2L/RO 80 AKGB	<b>20.51</b>
10 - 3/8	E2L/RO 100 AKGB	I2L/RO 100 AKGB	<b>20.51</b>
12.5 - 1/2	E2L/RO 125 AKGB	I2L/RO 125 AKGB	<b>20.51</b>

Length = 2.5 m - 8' 2-1/2"		Brushed antique bronze anod. alu. (ABGB)					
H = mm - in.	Profile	\$ / Length	Outside corner, 90°	Inside corner, 90°	\$ / Unit	Connector	\$ / Unit
6 - 1/4	RO 60 ABGB	<b>25.20</b>	EV/RO 60 ABGB	IV/RO 60 ABGB	<b>14.77</b>	V/RO 60	<b>2.63</b>
8 - 5/16	RO 80 ABGB	<b>27.85</b>	EV/RO 80 ABGB	IV/RO 80 ABGB	<b>14.77</b>	V/RO 80	<b>2.63</b>
10 - 3/8	RO 100 ABGB	<b>31.17</b>	EV/RO 100 ABGB	IV/RO 100 ABGB	<b>14.77</b>	V/RO 100	<b>2.63</b>
12.5 - 1/2	RO 125 ABGB	<b>35.47</b>	EV/RO 125 ABGB	IV/RO 125 ABGB	<b>14.77</b>	V/RO 125	<b>2.63</b>

H = mm - in.	Double-leg outside corner, 90°	Double-leg inside corner, 90°	\$ / Unit
8 - 5/16	E2L/RO 80 ABGB	I2L/RO 80 ABGB	<b>20.51</b>
10 - 3/8	E2L/RO 100 ABGB	I2L/RO 100 ABGB	<b>20.51</b>
12.5 - 1/2	E2L/RO 125 ABGB	I2L/RO 125 ABGB	<b>20.51</b>

Length = 2.5 m - 8' 2-1/2"		Satin brass anod. alu. (AM)					
H = mm - in.	Profile	\$ / Length	Outside corner, 90°	Inside corner, 90°	\$ / Unit	Connector	\$ / Unit
6 - 1/4	RO 60 AM	<b>19.24</b>	EV/RO 60 AM	IV/RO 60 AM	<b>7.98</b>	V/RO 60	<b>2.63</b>
8 - 5/16	RO 80 AM	<b>21.90</b>	EV/RO 80 AM	IV/RO 80 AM	<b>7.98</b>	V/RO 80	<b>2.63</b>
10 - 3/8	RO 100 AM	<b>24.55</b>	EV/RO 100 AM	IV/RO 100 AM	<b>7.98</b>	V/RO 100	<b>2.63</b>
12.5 - 1/2	RO 125 AM	<b>28.51</b>	EV/RO 125 AM	IV/RO 125 AM	<b>7.98</b>	V/RO 125	<b>2.63</b>

H = mm - in.	Double-leg outside corner, 90°	Double-leg inside corner, 90°	\$ / Unit
8 - 5/16	E2L/RO 80 AM	I2L/RO 80 AM	<b>16.47</b>
10 - 3/8	E2L/RO 100 AM	I2L/RO 100 AM	<b>16.47</b>
12.5 - 1/2	E2L/RO 125 AM	I2L/RO 125 AM	<b>16.47</b>



Schluter®-RONDEC							
Length = 2.5 m - 8' 2-1/2"		Polished brass anod. alu. (AMG)					
H = mm - in.	Profile	\$ / Length	Outside corner, 90°	Inside corner, 90°	\$ / Unit	Connector	\$ / Unit
6 - 1/4	RO 60 AMG	22.55	EV/RO 60 AMG	IV/RO 60 AMG	9.38	V/RO 60	2.63
8 - 5/16	RO 80 AMG	25.20	EV/RO 80 AMG	IV/RO 80 AMG	9.38	V/RO 80	2.63
10 - 3/8	RO 100 AMG	28.51	EV/RO 100 AMG	IV/RO 100 AMG	9.38	V/RO 100	2.63
12.5 - 1/2	RO 125 AMG	32.50	EV/RO 125 AMG	IV/RO 125 AMG	9.38	V/RO 125	2.63

H = mm - in.	Double-leg outside corner, 90°	Double-leg inside corner, 90°	\$ / Unit
8 - 5/16	E2L/RO 80 AMG	I2L/RO 80 AMG	16.47
10 - 3/8	E2L/RO 100 AMG	I2L/RO 100 AMG	16.47
12.5 - 1/2	E2L/RO 125 AMG	I2L/RO 125 AMG	16.47

Length = 2.5 m - 8' 2-1/2"		Brushed brass anod. alu. (AMGB)					
H = mm - in.	Profile	\$ / Length	Outside corner, 90°	Inside corner, 90°	\$ / Unit	Connector	\$ / Unit
6 - 1/4	RO 60 AMGB	23.87	EV/RO 60 AMGB	IV/RO 60 AMGB	15.04	V/RO 60	2.63
8 - 5/16	RO 80 AMGB	26.50	EV/RO 80 AMGB	IV/RO 80 AMGB	15.04	V/RO 80	2.63
10 - 3/8	RO 100 AMGB	29.85	EV/RO 100 AMGB	IV/RO 100 AMGB	15.04	V/RO 100	2.63
12.5 - 1/2	RO 125 AMGB	33.82	EV/RO 125 AMGB	IV/RO 125 AMGB	15.04	V/RO 125	2.63

H = mm - in.	Double-leg outside corner, 90°	Double-leg inside corner, 90°	\$ / Unit
8 - 5/16	E2L/RO 80 AMGB	I2L/RO 80 AMGB	20.92
10 - 3/8	E2L/RO 100 AMGB	I2L/RO 100 AMGB	20.92
12.5 - 1/2	E2L/RO 125 AMGB	I2L/RO 125 AMGB	20.92

Length = 2.5 m - 8' 2-1/2"		Graphite anod. alu. (AGR)					
H = mm - in.	Profile	\$ / Length	Outside corner, 90°	Inside corner, 90°	\$ / Unit	Connector	\$ / Unit
6 - 1/4	RO 60 AGR	19.63	EV/RO 60 AGR	IV/RO 60 AGR	8.07	V/RO 60	2.63
8 - 5/16	RO 80 AGR	20.98	EV/RO 80 AGR	IV/RO 80 AGR	8.07	V/RO 80	2.63
10 - 3/8	RO 100 AGR	22.33	EV/RO 100 AGR	IV/RO 100 AGR	8.07	V/RO 100	2.63
12.5 - 1/2	RO 125 AGR	23.67	EV/RO 125 AGR	IV/RO 125 AGR	8.07	V/RO 125	2.63

H = mm - in.	Double-leg outside corner, 90°	Double-leg inside corner, 90°	\$ / Unit
8 - 5/16	E2L/RO 80 AGR	I2L/RO 80 AGR	16.80
10 - 3/8	E2L/RO 100 AGR	I2L/RO 100 AGR	16.80
12.5 - 1/2	E2L/RO 125 AGR	I2L/RO 125 AGR	16.80

Length = 2.5 m - 8' 2-1/2"		Bright black anod. alu. (AGSG)					
H = mm - in.	Profile	\$ / Length	Outside corner, 90°	Inside corner, 90°	\$ / Unit	Connector	\$ / Unit
6 - 1/4	RO 60 AGSG	24.36	EV/RO 60 AGSG	IV/RO 60 AGSG	9.85	V/RO 60	2.63
8 - 5/16	RO 80 AGSG	25.69	EV/RO 80 AGSG	IV/RO 80 AGSG	9.85	V/RO 80	2.63
10 - 3/8	RO 100 AGSG	30.43	EV/RO 100 AGSG	IV/RO 100 AGSG	9.85	V/RO 100	2.63
12.5 - 1/2	RO 125 AGSG	34.50	EV/RO 125 AGSG	IV/RO 125 AGSG	9.85	V/RO 125	2.63

H = mm - in.	Double-leg outside corner, 90°	Double-leg inside corner, 90°	\$ / Unit
8 - 5/16	E2L/RO 80 AGSG	I2L/RO 80 AGSG	17.13
10 - 3/8	E2L/RO 100 AGSG	I2L/RO 100 AGSG	17.13
12.5 - 1/2	E2L/RO 125 AGSG	I2L/RO 125 AGSG	17.13



**Schluter®-RONDEC**

Length = 2.5 m - 8' 2-1/2"		Brushed black anod. alu. (AGSB)					
H = mm - in.	Profile	\$/ Length	Outside corner, 90°	Inside corner, 90°	\$/ Unit	Connector	\$/ Unit
6 - 1/4	RO 60 AGSB	25.20	EV/RO 60 AGSB	IV/RO 60 AGSB	14.90	V/RO 60	2.63
8 - 5/16	RO 80 AGSB	27.85	EV/RO 80 AGSB	IV/RO 80 AGSB	14.90	V/RO 80	2.63
10 - 3/8	RO 100 AGSB	31.17	EV/RO 100 AGSB	IV/RO 100 AGSB	14.90	V/RO 100	2.63
12.5 - 1/2	RO 125 AGSB	34.47	EV/RO 125 AGSB	IV/RO 125 AGSB	14.90	V/RO 125	2.63

H = mm - in.	Double-leg outside corner, 90°	Double-leg inside corner, 90°	\$/ Unit
8 - 5/16	E2L/RO 80 AGSB	I2L/RO 80 AGSB	20.51
10 - 3/8	E2L/RO 100 AGSB	I2L/RO 100 AGSB	20.51
12.5 - 1/2	E2L/RO 125 AGSB	I2L/RO 125 AGSB	20.51

**10-foot (3.05 m) RONDEC Profiles – Anodized Aluminum**

Length = 3.05 m - 10'		Satin anod. alu. (AE)		Polished chrome anod. alu. (ACG)		Satin nickel anod. alu. (AT)	
H = mm - in.	Profile	\$/ Length	Profile	\$/ Length	Profile	\$/ Length	
8 - 5/16	RO 80 AE / 300	23.35	RO 80 ACG / 300	30.69	RO 80 AT / 300	24.46	
10 - 3/8	RO 100 AE / 300	25.24	RO 100 ACG / 300	33.99	RO 100 AT / 300	25.58	
12.5 - 1/2	RO 125 AE / 300	28.17	RO 125 ACG / 300	39.78	RO 125 AT / 300	29.02	

Special shipping conditions apply, see pages 191-192.



Schluter®-RONDEC in brushed chrome (page 31)



Schluter®-TRENDLINE Textured Color-coated Aluminum



Schluter®-RONDEC							
Length = 2.5 m - 8' 2-1/2"							
Textured color-coated aluminum (TS)							
H = mm - in.	Profile	\$ / Length	Outside corner, 90°	Inside corner, 90°	\$ / Unit	Connector	\$ / Unit
6 - 1/4	RO 60 + color*	41.45	EV/RO 60 + color*	IV/RO 60 + color*	14.78	V/RO 60	2.63
8 - 5/16	RO 80 + color*	42.30	EV/RO 80 + color*	IV/RO 80 + color*	14.78	V/RO 80	2.63
10 - 3/8	RO 100 + color*	43.67	EV/RO 100 + color*	IV/RO 100 + color*	14.78	V/RO 100	2.63
11 - 7/16	RO 110 + color*	44.16	EV/RO 110 + color*	IV/RO 110 + color*	14.78	V/RO 110	2.63
12.5 - 1/2	RO 125 + color*	44.60	EV/RO 125 + color*	IV/RO 125 + color*	14.78	V/RO 125	2.63

**\*Color Codes**

Ivory	Greige	Stone grey	Cream	Beige	Rustic brown	Bronze	Pewter	Light anthracite	Dark anthracite

\* To complete the item number, add the color code (e.g., RO 60 TSC).

Matte White and Matte Black

Length = 2.5 m - 8' 2-1/2"							
Textured color-coated aluminum							
H = mm - in.	Profile	\$ / Length	Outside corner, 90° (die cast)	Inside corner, 90° (die cast)	\$ / Unit	Connector	\$ / Unit
6 - 1/4	RO 60 + color*	33.16	ED/RO 60 + color*	ID/RO 60 + color*	11.47	V/RO 60	2.63
8 - 5/16	RO 80 + color*	33.84	ED/RO 80 + color*	ID/RO 80 + color*	11.47	V/RO 80	2.63
10 - 3/8	RO 100 + color*	34.94	ED/RO 100 + color*	ID/RO 100 + color*	11.47	V/RO 100	2.63
11 - 7/16	RO 110 + color*	35.34	ED/RO 110 + color*	ID/RO 110 + color*	11.47	V/RO 110	2.63
12.5 - 1/2	RO 125 + color*	35.68	ED/RO 125 + color*	ID/RO 125 + color*	11.47	V/RO 125	2.63

**\*Color Codes**

		* To complete the item number, add the color code (e.g., RO 60 MGS).
Matte white	Matte black	

10-foot (3.05 m) RONDEC Profiles – Textured Color-coated Aluminum						
Length = 3.05 m - 10'						
Textured color-coated aluminum (TS)			Matte white (MBW)		Matte black (MGS)	
H = mm - in.	Profile	\$ / Length	Profile	\$ / Length	Profile	\$ / Length
6 - 1/4	RO 60 + color* / 300	51.81	RO 60 MBW / 300	41.45	RO 60 MGS / 300	41.45
8 - 5/16	RO 80 + color* / 300	52.88	RO 80 MBW / 300	42.30	RO 80 MGS / 300	42.30
10 - 3/8	RO 100 + color* / 300	54.60	RO 100 MBW / 300	43.67	RO 100 MGS / 300	43.67
11 - 7/16	RO 110 + color* / 300	55.19	RO 110 MBW / 300	44.17	RO 110 MGS / 300	44.17
12.5 - 1/2	RO 125 + color* / 300	55.77	RO 125 MBW / 300	44.60	RO 125 MGS / 300	44.60

Special shipping conditions apply, see pages 191-192.



Color-coated Aluminum



Schluter®-RONDEC							
Length = 2.5 m - 8' 2-1/2"		Color-coated aluminum (AC)					
H = mm - in.	Profile	\$/ Length	Outside corner, 90° (die cast)	Inside corner, 90° (die cast)	\$/ Unit	Connector	\$/ Unit
6 - 1/4	RO 60 + color*	21.07	ED/RO 60 + color*	ID/RO 60 + color*	4.75	V/RO 60	2.63
8 - 5/16	RO 80 + color*	23.61	ED/RO 80 + color*	ID/RO 80 + color*	4.75	V/RO 80	2.63
10 - 3/8	RO 100 + color*	25.89	ED/RO 100 + color*	ID/RO 100 + color*	4.75	V/RO 100	2.63
12.5 - 1/2	RO 125 + color*	32.36	ED/RO 125 + color*	ID/RO 125 + color*	4.75	V/RO 125	2.63

**\*Color Codes**

BW	W	SP	BH	HB	HG	PG	G	GM	SB	GS
Bright white	White	Sand pebble	Bahama	Light beige	Light grey	Classic grey	Grey	Metallic grey	Black brown	Black

\* To complete the item number, add the color code (e.g., RO 60 G).

PVC



Length = 2.5 m - 8' 2-1/2"		PVC (P)				
H = mm - in.	Profile	\$/ Length	Outside corner, 90°	Inside corner, 90°	\$/ Unit	
6 - 1/4	PRO 60 + color*	7.31	E/PRO 60 + color*	I/PRO 60 + color*	2.89	
8 - 5/16	PRO 80 + color*	7.70	E/PRO 80 + color*	I/PRO 80 + color*	2.89	
10 - 3/8	PRO 100 + color*	8.20	E/PRO 100 + color*	I/PRO 100 + color*	2.89	
11 - 7/16	PRO 110 + color*	9.22	E/PRO 110 + color*	I/PRO 110 + color*	2.89	
12.5 - 1/2	PRO 125 + color*	10.26	E/PRO 125 + color*	I/PRO 125 + color*	2.89	

**\*Color Codes**

BW	W	SP	BH	HB	HG	PG	G	GS
Bright white	White	Sand pebble	Bahama	Light beige	Light grey	Classic grey	Grey	Black

\* To complete the item number, add the color code (e.g., PRO 60 G).

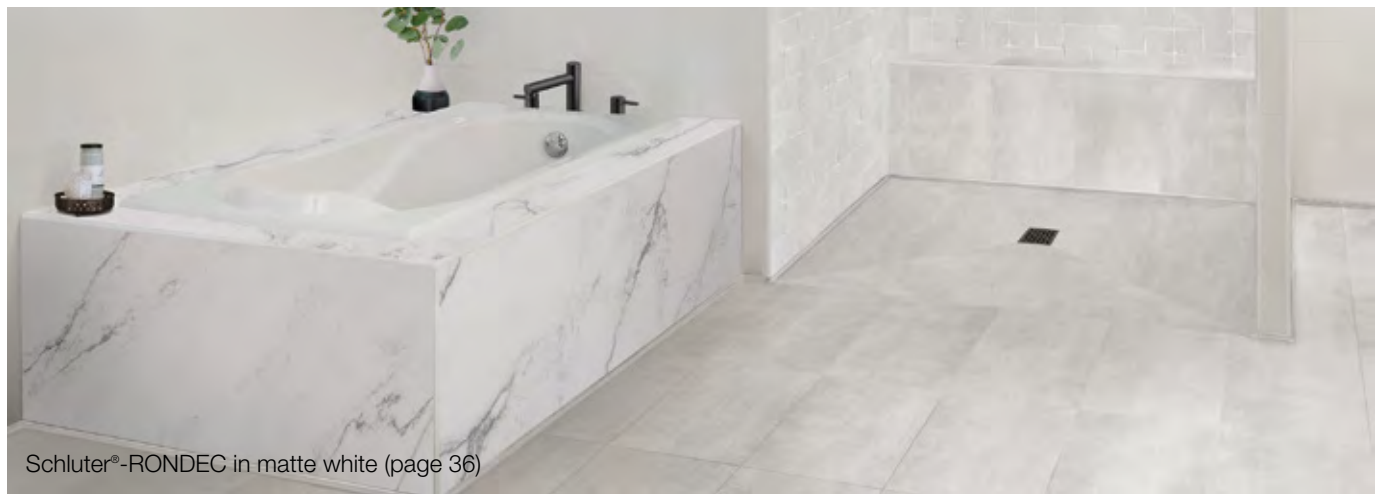

Schluter®-RONDEC in matte white (page 36)



### Schluter®-QUADEC

**Schluter®-QUADEC** is a finishing and edge-protection profile for tiled edges and outside corners of tiled surfaces. The reveal of the profile forms a square outer corner along the surface edge. QUADEC allows for modern decorative design and interesting contrasts. The profile can be combined with the Schluter®-QUADEC-FS (page 42) feature strip profile and/or the Schluter®-DESIGNLINE border profile for further design options (page 46). QUADEC, in stainless steel, can also be used as a stair nosing or floor transition profile. QUADEC in aluminum and PVC feature an integrated joint spacer that establishes a defined joint cavity between the tile and the profile.

**Note:** Also available in chrome-plated brass, and stainless steel 316L (1.4404 = V4A). Contact Customer Service for pricing and availability.

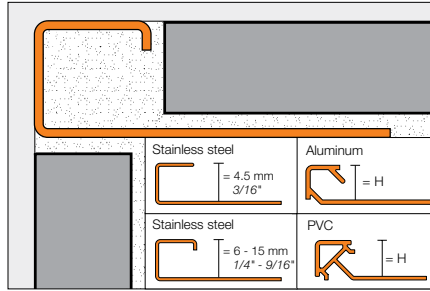

Inside/outside corner/end cap (EV/)

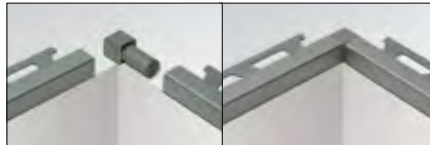

### Stainless Steel 304 (1.4301 = V2A)

Schluter®-QUADEC						
Length = 2.5 m - 8' 2-1/2"	Stainless steel 304 (1.4301 = V2A) (E)					
H = mm - in.	Profile	\$ / Length	Inside/outside corner	\$ / Unit	Connector	\$ / Unit
4.5 - 3/16	Q 45 E	43.39	EV/Q 45 E	34.93	-	-
6 - 1/4	Q 60 E	49.81	EV/Q 60 E	38.29	V/RO 60 E	6.29
7 - 9/32	Q 70 E	51.69	EV/Q 70 E	38.83	-	-
8 - 5/16	Q 80 E	52.01	EV/Q 80 E	39.35	V/RO 80 E	6.29
9 - 11/32	Q 90 E	55.45	EV/Q 90 E	40.74	-	-
10 - 3/8	Q 100 E	55.86	EV/Q 100 E	42.50	V/RO 100 E	6.29
11 - 7/16	Q 110 E	57.81	EV/Q 110 E	43.15	V/RO 110 E	6.29
12.5 - 1/2	Q 125 E	59.51	EV/Q 125 E	43.62	V/RO 125 E	6.29
14 - 17/32	Q 140 E	63.74	EV/Q 140 E	45.35	-	-
15 - 9/16	Q 150 E	66.30	EV/Q 150 E	48.63	-	-

Length = 2.5 m - 8' 2-1/2"	Brushed stainless steel 304 (1.4301 = V2A) (EB)					
H = mm - in.	Profile	\$ / Length	Inside/outside corner	\$ / Unit	Connector	\$ / Unit
6 - 1/4	Q 60 EB	73.29	EV/Q 60 EB	46.21	V/RO 60 E	6.29
7 - 9/32	Q 70 EB	76.06	EV/Q 70 EB	46.71	-	-
8 - 5/16	Q 80 EB	78.81	EV/Q 80 EB	47.18	V/RO 80 E	6.29
9 - 11/32	Q 90 EB	81.60	EV/Q 90 EB	48.84	-	-
10 - 3/8	Q 100 EB	84.64	EV/Q 100 EB	50.96	V/RO 100 E	6.29
11 - 7/16	Q 110 EB	87.60	EV/Q 110 EB	51.72	V/RO 110 E	6.29
12.5 - 1/2	Q 125 EB	90.18	EV/Q 125 EB	52.21	V/RO 125 E	6.29
14 - 17/32	Q 140 EB	92.45	EV/Q 140 EB	52.90	-	-
15 - 9/16	Q 150 EB	93.78	EV/Q 150 EB	54.32	-	-





Anodized Aluminum

<b>Schluter®-QUADEC</b>										
Length = 2.5 m - 8' 2-1/2"	Satin anodized aluminum (AE)				Polished chrome anodized aluminum (ACG)				Connector	
H = mm - in.	Profile	\$/ Length	Inside/outside corner	\$/ Unit	Profile	\$/ Length	Inside/outside corner	\$/ Unit	Item No.	\$/ Unit
4.5 - 3/16	Q 45 AE	18.01	EV/Q 45 AE	8.53	Q 45 ACG	22.63	EV/Q 45 ACG	10.12	-	-
6 - 1/4	Q 60 AE	18.77	EV/Q 60 AE	8.53	Q 60 ACG	23.58	EV/Q 60 ACG	10.12	V/Q 60	2.63
8 - 5/16	Q 80 AE	19.57	EV/Q 80 AE	8.53	Q 80 ACG	26.57	EV/Q 80 ACG	10.12	V/RO 80	2.63
10 - 3/8	Q 100 AE	21.16	EV/Q 100 AE	8.53	Q 100 ACG	29.30	EV/Q 100 ACG	10.12	V/RO 100	2.63
12.5 - 1/2	Q 125 AE	23.62	EV/Q 125 AE	8.53	Q 125 ACG	34.32	EV/Q 125 ACG	10.12	V/RO 125	2.63
15 - 9/16	Q 150 AE	26.64	EV/Q 150 AE	9.64	-	-	-	-	-	-
20 - 3/4	Q 200 AE	29.18	EV/Q 200 AE	9.64	-	-	-	-	-	-

Length = 2.5 m - 8' 2-1/2"	Satin nickel anodized aluminum (AT)				Brushed nickel anodized aluminum (ATGB)				Connector	
H = mm - in.	Profile	\$/ Length	Inside/outside corner	\$/ Unit	Profile	\$/ Length	Inside/outside corner	\$/ Unit	Item No.	\$/ Unit
4.5 - 3/16	Q 45 AT	18.98	EV/Q 45 AT	8.37	-	-	-	-	-	-
6 - 1/4	Q 60 AT	19.77	EV/Q 60 AT	8.37	-	-	-	-	V/Q 60	2.63
8 - 5/16	Q 80 AT	21.12	EV/Q 80 AT	8.37	Q 80 ATGB	25.88	EV/Q 80 ATGB	15.48	V/RO 80	2.63
10 - 3/8	Q 100 AT	22.50	EV/Q 100 AT	8.37	Q 100 ATGB	28.80	EV/Q 100 ATGB	15.48	V/RO 100	2.63
12.5 - 1/2	Q 125 AT	25.05	EV/Q 125 AT	8.37	Q 125 ATGB	31.11	EV/Q 125 ATGB	15.48	V/RO 125	2.63

Length = 2.5 m - 8' 2-1/2"	Brushed antique bronze anodized aluminum (ABGB)				Connector	
H = mm - in.	Profile	\$/ Length	Inside/outside corner	\$/ Unit	Item No.	\$/ Unit
6 - 1/4	Q 60 ABGB	25.33	EV/Q 60 ABGB	15.48	V/Q 60	2.63
8 - 5/16	Q 80 ABGB	25.88	EV/Q 80 ABGB	15.48	V/RO 80	2.63
10 - 3/8	Q 100 ABGB	28.80	EV/Q 100 ABGB	15.48	V/RO 100	2.63
12.5 - 1/2	Q 125 ABGB	31.11	EV/Q 125 ABGB	15.48	V/RO 125	2.63

<b>10-foot (3.05 m) QUADEC Profiles – Anodized Aluminum</b>		
Length = 3.05 m - 10'	Polished chrome anodized aluminum (ACG)	
H = mm - in.	Profile	\$/ Length
8 - 5/16	Q 80 ACG / 300	33.22
10 - 3/8	Q 100 ACG / 300	36.62
12.5 - 1/2	Q 125 ACG / 300	42.91

Special shipping conditions apply, see pages 191-192.



Schluter®-TRENDLINE Textured Color-coated Aluminum

Schluter®-QUADEC						
Length = 2.5 m - 8' 2-1/2"	Textured color-coated aluminum (TS)					
H = mm - in.	Profile	\$ / Length	Inside/outside corner	\$ / Unit	Connector	\$ / Unit
4.5 - 3/16	Q 45 + color*	40.24	EV/Q 45 + color*	16.09	-	-
6 - 1/4	Q 60 + color*	41.05	EV/Q 60 + color*	16.09	V/Q 60	2.63
8 - 5/16	Q 80 + color*	41.89	EV/Q 80 + color*	16.09	V/RO 80	2.63
10 - 3/8	Q 100 + color*	43.02	EV/Q 100 + color*	16.09	V/RO 100	2.63
11 - 7/16	Q 110 + color*	43.62	EV/Q 110 + color*	16.09	V/RO 110	2.63
12.5 - 1/2	Q 125 + color*	44.04	EV/Q 125 + color*	16.09	V/RO 125	2.63



**\*Color Codes**

Ivory	Greige	Stone grey	Cream	Beige	Rustic brown	Bronze	Pewter	Light anthracite	Dark anthracite

\* To complete the item number, add the color code (e.g., Q 60 TSC).

Matte White and Matte Black

Length = 2.5 m - 8' 2-1/2"	Textured color-coated aluminum					
H = mm - in.	Profile	\$ / Length	Inside/outside corner	\$ / Unit	Connector	\$ / Unit
4.5 - 3/16	Q 45 + color*	31.89	EV/Q 45 + color*	16.09	-	-
6 - 1/4	Q 60 + color*	32.53	EV/Q 60 + color*	16.09	V/Q 60	2.63
8 - 5/16	Q 80 + color*	33.20	EV/Q 80 + color*	16.09	V/RO 80	2.63
10 - 3/8	Q 100 + color*	34.28	EV/Q 100 + color*	16.09	V/RO 100	2.63
11 - 7/16	Q 110 + color*	34.67	EV/Q 110 + color*	16.09	V/RO 110	2.63
12.5 - 1/2	Q 125 + color*	35.01	EV/Q 125 + color*	16.09	V/RO 125	2.63

**\*Color Codes**

		* To complete the item number, add the color code (e.g., Q 60 MGS).
Matte white	Matte black	

10-foot (3.05 m) QUADEC Profiles – Textured Color-coated Aluminum						
Length = 3.05 m - 10'	Textured color-coated aluminum (TS)		Matte white (MBW)		Matte black (MGS)	
H = mm - in.	Profile	\$ / Length	Profile	\$ / Length	Profile	\$ / Length
6 - 1/4	Q 60 + color* / 300	51.32	Q 60 MBW / 300	40.66	Q 60 MGS / 300	40.66
8 - 5/16	Q 80 + color* / 300	52.36	Q 80 MBW / 300	41.51	Q 80 MGS / 300	41.51
10 - 3/8	Q 100 + color* / 300	53.78	Q 100 MBW / 300	42.85	Q 100 MGS / 300	42.85
11 - 7/16	Q 110 + color* / 300	54.52	Q 110 MBW / 300	43.34	Q 110 MGS / 300	43.34
12.5 - 1/2	Q 125 + color* / 300	55.06	Q 125 MBW / 300	43.76	Q 125 MGS / 300	43.76

Special shipping conditions apply, see pages 191-192.



Color-coated Aluminum

Schluter®-QUADEC					
Length = 2.5 m - 8' 2-1/2"		Color-coated aluminum (AC)			
H = mm - in.	Profile	\$ / Length	Outside corner, 90° (die cast)	\$ / Unit	
4.5 - 3/16	Q 45 + color*	19.43	ED/Q 45 + color*	4.66	
6 - 1/4	Q 60 + color*	20.89	ED/Q 60 + color*	4.66	
8 - 5/16	Q 80 + color*	22.10	ED/Q 80 + color*	4.66	
10 - 3/8	Q 100 + color*	23.32	ED/Q 100 + color*	4.66	
11 - 7/16	Q 110 + color*	24.04	ED/Q 110 + color*	4.66	
12.5 - 1/2	Q 125 + color*	25.51	ED/Q 125 + color*	4.66	

**\*Color Codes**

\* To complete the item number, add the color code (e.g., Q 45 PG).

PVC

Length = 2.5 m - 8' 2-1/2"		PVC (P)			
H = mm - in.	Profile	\$ / Length	Outside corner, 90°	\$ / Unit	
6 - 1/4	PQ 60 + color*	7.62	E/PQ 60 + color*	2.84	
8 - 5/16	PQ 80 + color*	8.02	E/PQ 80 + color*	2.84	
10 - 3/8	PQ 100 + color*	8.56	E/PQ 100 + color*	2.84	
11 - 7/16	PQ 110 + color*	9.64	E/PQ 110 + color*	2.84	
12.5 - 1/2	PQ 125 + color*	10.71	E/PQ 125 + color*	2.84	

**\*Color Codes**

\* To complete the item number, add the color code (e.g., PQ 80 PG).



Schluter®-QUADEC in cream (page 40)



### Schluter®-QUADEC-K

**Schluter®-QUADEC-K** is a variant of the QUADEC profile without an anchoring leg. It features an open cavity that is filled with thin-set mortar to secure the profile in the assembly. Alternatively, the profile may be installed with an adhesive such as Schluter®-KERDI-FIX. QUADEC-K is installed in wall applications (e.g., wainscotings and bases) with coverings up to 1/2" (12.5 mm) thick. The profile is particularly suited for finishing edges in retrofit applications, such as thin porcelain panel installation over existing wall tiles.

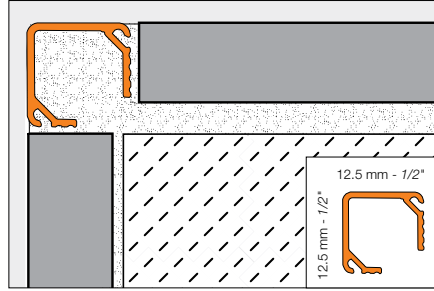

#### Schluter®-QUADEC-K

Length = 2.5 m - 8' 2-1/2"	Satin anodized aluminum (AE)						Polished chrome anod. alu. (ACG)					
	Profile	\$ / Length	Inside/outside corner	\$ / Unit	Connector	\$ / Unit	Profile	\$ / Length	Inside/outside corner	\$ / Unit	Connector	\$ / Unit
H = mm - in.												
12.5 - 1/2	Q 125 AE K	21.68	EV/Q 125 AE	8.53	V/RO 125	2.63	Q 125 ACG K	25.60	EV/Q 125 ACG	10.12	V/RO 125	2.63

Length = 2.5 m - 8' 2-1/2"	Satin nickel anod. alu. (AT)						Brushed antique bronze anod. alu. (ABGB)					
	Profile	\$ / Length	Inside/outside corner	\$ / Unit	Connector	\$ / Unit	Profile	\$ / Length	Inside/outside corner	\$ / Unit	Connector	\$ / Unit
H = mm - in.												
12.5 - 1/2	Q 125 AT K	23.72	EV/Q 125 AT	8.37	V/RO 125	2.63	Q 125 ABGB K	28.03	EV/Q 125 ABGB	15.48	V/RO 125	2.63

### Schluter®-QUADEC-FS

**Schluter®-QUADEC-FS** is a double-rail feature strip profile that features a recessed section to which field or accent tile is bonded. The profile can be used to produce accents in tile fields on walls, chair rails, and various other decorative applications. The profile can be combined with the Schluter®-QUADEC (page 38) finishing and edge-protection profile. QUADEC-FS features integrated joint spacers that establish defined joint cavities between the accent tile and the profile.

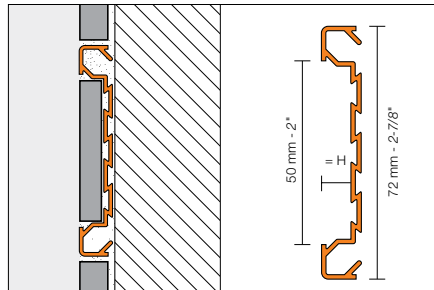

Inside/outside corner / End cap (EV)

**Note:** The universal accessory piece can be used to produce a 90° inside corner, 90° outside corner, and end cap.



#### Schluter®-QUADEC-FS

Length = 2.5 m - 8' 2-1/2"	Satin anodized aluminum (AE)				Polished chrome anod. alu. (ACG)			
	Profile	\$ / Length	Inside/outside corner	\$ / Unit	Profile	\$ / Length	Inside/outside corner	\$ / Unit
H = mm - in.								
8 - 5/16	QF8/50 AE	38.22	EV/QF8/50 AE	25.52	QF8/50 ACG	50.84	EV/QF8/50 ACG	30.21

  

Length = 2.5 m - 8' 2-1/2"	Satin nickel anod. alu. (AT)				Brushed antique bronze anod. alu. (ABGB)			
	Profile	\$ / Length	Inside/outside corner	\$ / Unit	Profile	\$ / Length	Inside/outside corner	\$ / Unit
H = mm - in.								
8 - 5/16	QF8/50 AT	40.48	EV/QF8/50 AT	25.52	QF8/50 ABGB	54.85	EV/QF8/50 ABGB	32.75



### Schluter®-FINEC-SQ

**Schluter®-FINEC-SQ** is a finishing and edge-protection profile for outside corners of tile coverings. This minimalistic wall profile features a symmetrical 3/16" (4.5 mm) profile reveal that combines the slim look of Schluter®-FINEC with the square shape of Schluter®-QUADEC and a perforated anchoring leg that is secured in mortar bond coat beneath the tile. This profile is available in larger sizes to accommodate thicker tiles and is ideal for protecting mitered edges. Available in satin anodized aluminum, as well as color-coated aluminum in all TRENDLINE colors.

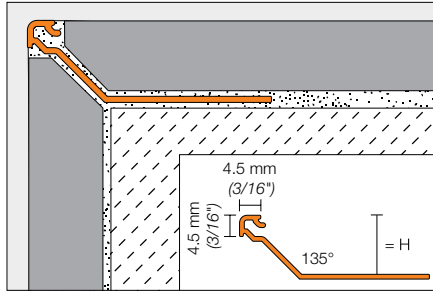

FINEC-SQ can be combined with QUADEC corner pieces

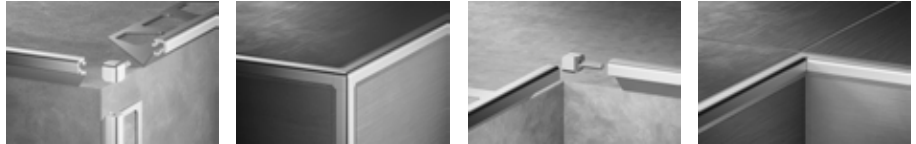

Schluter®-FINEC-SQ				
Length = 2.5 m - 8' 2-1/2"	Satin anodized aluminum (AE)			
H = mm - in.	Profile	\$ / Length	Inside/Outside Corner	\$ / Unit
11 - 7/16	FSQ 110 AE	21.97	EV/Q 45 AE	8.53
12.5 - 1/2	FSQ 125 AE	22.21		
15 - 9/16	FSQ 150 AE	22.27		
Length = 2.5 m - 8' 2-1/2"	Textured color-coated aluminum			
H = mm - in.	Profile	\$ / Length	Inside/Outside Corner	\$ / Unit
11 - 7/16	FSQ 110 + color*	29.55	EV/Q 45 + color*	16.09
12.5 - 1/2	FSQ 125 + color*	29.63		
15 - 9/16	FSQ 150 + color*	29.73		

#### \*Color Codes



\* To complete the item number, add the **color** code (e.g., FSQ 110 **TSC**).



Schluter®-FINEC-SQ in matte black



## Schluter®-FINEC

**Schluter®-FINEC** is a finishing and edge-protection profile for the external edges of tile coverings or mosaics. The finishing leg of the profile protects the covering edges from mechanical damage, and features a very slim, elegant reveal. Available in anodized aluminium, color-coated aluminum in all TRENDLINE colors, as well as stainless steel. FINEC is ideal for protecting mitered edges, while creating a discreet trim for a minimalist design.

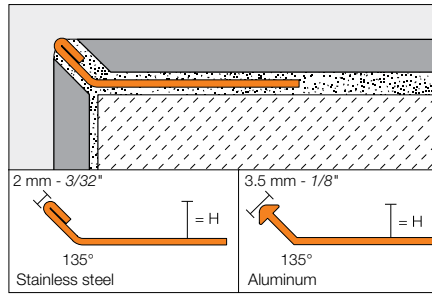

Schluter®-FINEC				
Length = 2.5 m - 8' 2-1/2"	Stainless steel 304 (1.4301 = V2A) (E)		Satin anodized aluminum (AE)	
H = mm - in.	Item No.	\$/ Length	Item No.	\$/ Length
2.5 - 3/32	-	-	F 25 AE	16.78
4.5 - 3/16	F 45 E	32.71	F 45 AE	17.02
7 - 9/32	F 70 E	34.32	F 70 AE	17.71
9 - 11/32	F 90 E	36.58	F 90 AE	18.57
11 - 7/16	F 110 E	37.79	F 110 AE	19.31
12.5 - 1/2	F 125 E	38.49	F 125 AE	19.80

Length = 2.5 m - 8' 2-1/2"	Textured color-coated aluminum		
H = mm - in.	Item No.	\$/ Length	
2.5 - 3/32	F 25 MBW	23.28	
4.5 - 3/16	F 45 + color*	23.75	
7 - 9/32	F 70 + color*	24.24	
9 - 11/32	F 90 + color*	25.27	
11 - 7/16	F 110 + color*	25.52	
12.5 - 1/2	F 125 + color*	26.02	

**\*Color Codes**

TSI Ivory	TSBG Greige	TSSG Stone grey	TSC Cream	TSB Beige	TSR Rustic brown
TSOB Bronze	TSG Pewter	TSLA Light anthracite	TSDA Dark anthracite	MBW Matte white	MGS Matte black

\* To complete the item number, add the **color** code (e.g., F 70 **TSC**).



Schluter®-FINEC in stainless steel



### Schluter®-INDEC

**Schluter®-INDEC** is an anodized aluminum profile for outside corners of tiled surfaces and tiled edges. The reveal of the profile forms a square recessed groove for modern decorative design and interesting contrasts.

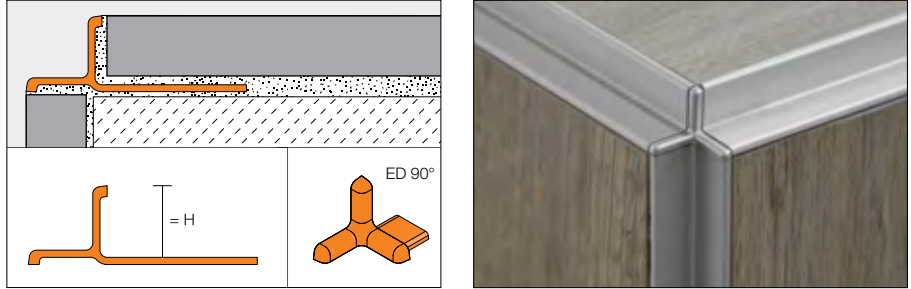

Schluter®-INDEC									
Length = 2.5 m - 8' 2-1/2"	Satin anodized aluminum (AE)			Cast zinc with AE appearance		Polished chrome anod. alu. (ACG)		Cast zinc with ACG appearance	
H = mm - in.	Profile	\$/ Length	Outside corner 90°	\$/ Unit	Profile	\$/ Length	Outside corner 90°	\$/ Unit	
8 - 5/16	IN 80 AE	26.82	ED / IN 80 AE	7.26	IN 80 ACG	47.11	ED / IN 80 ACG	7.26	
10 - 3/8	IN 100 AE	27.72	ED / IN 100 AE	7.26	IN 100 ACG	48.37	ED / IN 100 ACG	7.26	
11 - 7/16	IN 110 AE	28.61	ED / IN 110 AE	7.26	IN 110 ACG	51.29	ED / IN 110 ACG	7.26	
12.5 - 1/2	IN 125 AE	33.62	ED / IN 125 AE	7.26	IN 125 ACG	54.71	ED / IN 125 ACG	7.26	

### Schluter®-RONDEC-DB

**Schluter®-RONDEC-DB** is a decorative profile for walls, wainscotings, and tile bases. The profile produces a pronounced visible surface that establishes a clean line along tile edges and allows for decorative design. RONDEC-DB can also be used as a finishing profile within wall surfaces. RONDEC-DB features an integrated joint spacer that establishes a defined joint cavity between the tile and the profile.

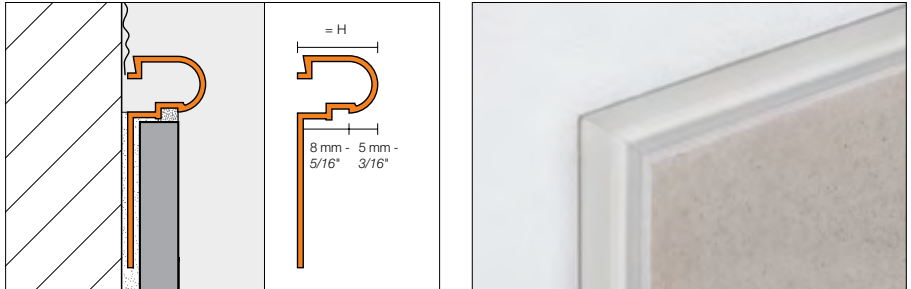

Outside corner (90°)

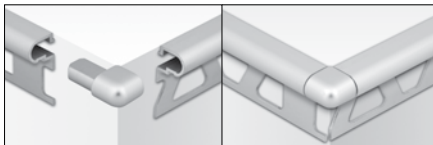

Schluter®-RONDEC-DB								
Length = 2.5 m - 8' 2-1/2"	Satin anodized aluminum (AE)				Satin copper anod. alu. (AK)		Satin brass anod. alu. (AM)	
H = mm - in.	Profile	\$/ Length	Outside corner, 90°	\$/ Unit	Profile	\$/ Length	Profile	\$/ Length
14 - 17/32	DB 14 AE	32.25	EV/DB 14 AE	12.59	DB 14 AK	34.14	DB 14 AM	32.25

10-foot (3.05 m) RONDEC-DB Profile		
Length = 3.05 m - 10'	Satin anodized aluminum (AE)	
H = mm - in.	Profile	\$/ Length
14 - 17/32	DB 14 AE / 300	40.32

Special shipping conditions apply, see pages 191-192.



### Schluter®-DESIGNLINE

**Schluter®-DESIGNLINE** is a border profile for producing decorative designs in tile fields on walls. DESIGNLINE in stainless steel can also be used to produce decorative designs in floors. The profile can be combined with Schluter®-QUADEC (page 38) and Schluter®-RONDEC (page 29) finishing and edge-protection profiles. DESIGNLINE in anodized aluminum features an integrated joint spacer that establishes a defined joint cavity between the tile and the profile.

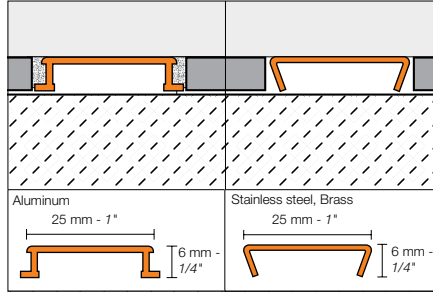

Schluter®-DESIGNLINE						
Length = 2.5 m - 8' 2-1/2"	Stainless steel 304 (1.4301 = V2A) (E)		Brushed stainless steel 304 (1.4301 = V2A) (EB)		Chrome-plated solid brass (MC) *	
H = mm - in.	Item No.	\$ / Length	Item No.	\$ / Length	Item No.	\$ / Length
6 - 1/4	DL 625 E	62.36	DL 625 EB	91.21	DL 625 MC	98.62
Length = 2.5 m - 8' 2-1/2"	Satin anodized aluminum (AE)		Polished chrome anod. alu. (ACG)		Brushed chrome anod. alu. (ACGB)	
H = mm - in.	Item No.	\$ / Length	Item No.	\$ / Length	Item No.	\$ / Length
6 - 1/4	DL 625 AE	27.31	DL 625 ACG	37.59	DL 625 ACGB	43.06
Length = 2.5 m - 8' 2-1/2"	Satin nickel anod. alu. (AT)		Polished nickel anod. alu. (ATG)		Brushed nickel anod. alu. (ATGB)	
H = mm - in.	Item No.	\$ / Length	Item No.	\$ / Length	Item No.	\$ / Length
6 - 1/4	DL 625 AT	28.68	DL 625 ATG	38.93	DL 625 ATGB	44.40
Length = 2.5 m - 8' 2-1/2"	Satin copper anod. alu. (AK)		Polished copper anod. alu. (AKG)		Brushed copper anod. alu. (AKGB)	
H = mm - in.	Item No.	\$ / Length	Item No.	\$ / Length	Item No.	\$ / Length
6 - 1/4	DL 625 AK	28.68	DL 625 AKG	38.93	DL 625 AKGB	44.40
Length = 2.5 m - 8' 2-1/2"	Satin brass anod. alu. (AM)		Polished brass anod. alu. (AMG)		Brushed brass anod. alu. (AMGB)	
H = mm - in.	Item No.	\$ / Length	Item No.	\$ / Length	Item No.	\$ / Length
6 - 1/4	DL 625 AM	27.31	DL 625 AMG	37.59	DL 625 AMGB	43.06

\* **WARNING:** Reproductive Harm - [www.P65Warnings.ca.gov](http://www.P65Warnings.ca.gov)





### Schluter®-DECO-DE

**Schluter®-DECO-DE** is a stainless steel finishing and edge-protection profile for 135° outside corners of tiled surfaces.

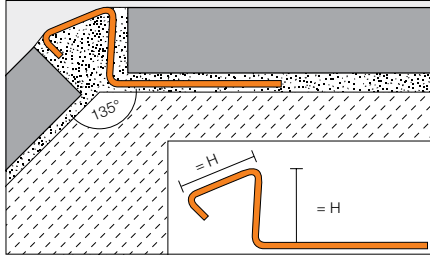

Schluter®-DECO-DE				
Length = 2.5 m - 8' 2-1/2"	Stainless steel 304 (1.4301 = V2A) (E)		Brushed stainless steel 304 (1.4301 = V2A) (EB)	
H = mm - in.	Item No.	\$ / Length	Item No.	\$ / Length
8 - 5/16	DE 80 ES	47.35	DE 80 EBS	52.28
10 - 3/8	DE 100 ES	49.77	DE 100 EBS	55.01
11 - 7/16	DE 110 ES	50.63	DE 110 EBS	56.34
12.5 - 1/2	DE 125 ES	52.05	DE 125 EBS	58.23

### Schluter®-DECO-SG

**Schluter®-DECO-SG** is a decorative profile featuring a 1/2" (12.5 mm) or 9/16" (15 mm) wide channel that creates a shadow gap between tile courses or other wall covering. The profile may also be used as a support channel for glass panels. The 1/2" (12.5 mm) wide channel accommodates glass panels up to a thickness of 3/8" (10 mm), and the 9/16" (15 mm) wide channel accommodates glass panels up to a thickness of 1/2" (12.5 mm). DECO-SG features a trapezoid-perforated anchoring leg that is secured in the bond coat beneath the tile.

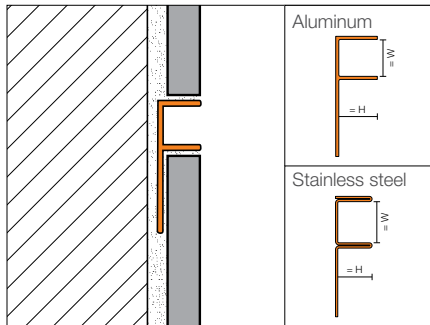

Schluter®-DECO-SG						
Length = 2.5 m - 8' 2-1/2"	Brushed stainless steel 304 (1.4301 = V2A) (EB)		Satin anodized aluminum (AE)		Bright chrome anodized aluminum (ACB)	
H = mm - in.	Item No.	\$ / Length	Item No.	\$ / Length	Item No.	\$ / Length
<b>W: 12.5 mm - 1/2"</b>						
8 - 5/16	SG 80 EB 12	78.03	SG 80 AE 12	21.55	SG 80 ACB 12	22.42
10 - 3/8	SG 100 EB 12	83.34	SG 100 AE 12	22.66	SG 100 ACB 12	23.47
11 - 7/16	SG 110 EB 12	86.20	SG 110 AE 12	23.28	SG 110 ACB 12	24.15
12.5 - 1/2	SG 125 EB 12	90.77	SG 125 AE 12	24.07	SG 125 ACB 12	24.94
<b>W: 15 mm - 9/16"</b>						
8 - 5/16	SG 80 EB 15	80.46	SG 80 AE 15	22.62	SG 80 ACB 15	23.53
10 - 3/8	SG 100 EB 15	85.71	SG 100 AE 15	23.80	SG 100 ACB 15	24.65
11 - 7/16	SG 110 EB 15	88.91	SG 110 AE 15	24.44	SG 110 ACB 15	25.36
12.5 - 1/2	SG 125 EB 15	92.28	SG 125 AE 15	25.28	SG 125 ACB 15	26.20



**Schluter®-DECO-SGC**

**Schluter®-DECO-SGC** is a decorative profile featuring a 1/2" (12.5 mm) or 9/16" (15 mm) -wide channel used as a vertical support for glass panels in recessed showers that border on untilted walls that are plastered, creating a 90° angle between the glass partition and the untilted wall. The 1/2" (12.5 mm) wide channel accommodates glass panels up to a thickness of 3/8" (10 mm), and the 9/16" (15 mm) wide channel accommodates glass panels up to a thickness of 1/2" (12.5 mm). DECO-SGC features a trapezoid-perforated anchoring leg that is secured in the bond coat beneath the tile.

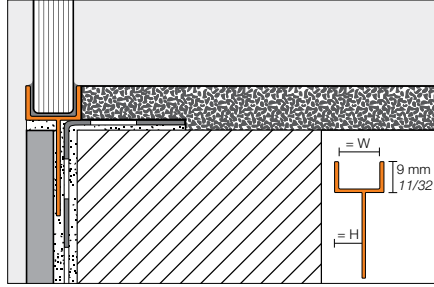

Schluter®-DECO-SGC		
Length = 2.5 m - 8' 2-1/2"	Satin anodized aluminum (AE)	
H = mm - in.	Item No.	\$ / Length
<b>W: 12.5 mm - 1/2"</b>		
8 - 5/16	SGC 80 AE 12	23.28
10 - 3/8	SGC 100 AE 12	24.48
11 - 7/16	SGC 110 AE 12	25.14
12.5 - 1/2	SGC 125 AE 12	26.00
<b>W: 15 mm - 9/16"</b>		
8 - 5/16	SGC 80 AE 15	24.43
10 - 3/8	SGC 100 AE 15	25.71
11 - 7/16	SGC 110 AE 15	26.39
12.5 - 1/2	SGC 125 AE 15	27.31



Schluter®-DECO-SG (page 47)



### Schluter®-RONDEC-STEP

**Schluter®-RONDEC-STEP** is a finishing and edging profile for ceramic tile and dimension stone installations on countertops and stairs. The top of the profile features a symmetrically rounded edge that matches the Schluter®-RONDEC profile (page 29), while the vertical leg of the profile hides the exposed edge of the sub-assembly. RONDEC-STEP features an integrated joint spacer that establishes a defined joint cavity between the tile and the profile.

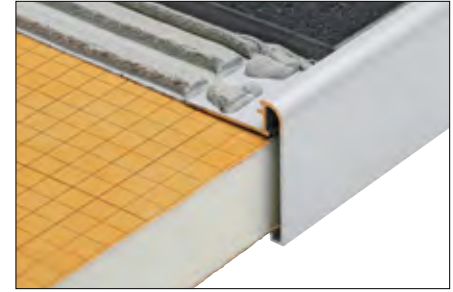
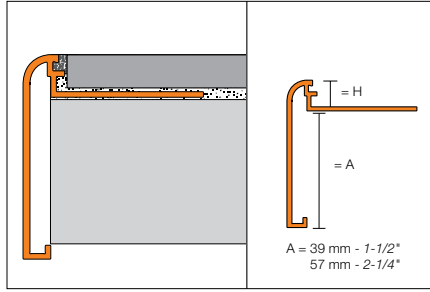

Outside corner (90° or 135°)



Inside corner (90° or 135°)



Schluter®-RONDEC-STEP								
Length = 2.5 m - 8' 2-1/2"	Satin anodized aluminum (AE)							
H = mm - in.	Profile	\$/ Length	Outside corner, 90°	Outside corner, 135°	Inside corner, 90°	Inside corner, 135°	\$/ Unit	
<b>A: 39 mm - 1-1/2"</b>								
8 - 5/16	RS 80 AE 39	46.03	E90 RS 80 AE 39	E135 RS 80 AE 39	I90 RS 80 AE 39	I135 RS 80 AE 39	21.47	
10 - 3/8	RS 100 AE 39	46.78	E90 RS 100 AE 39	E135 RS 100 AE 39	I90 RS 100 AE 39	I135 RS 100 AE 39	21.47	
12.5 - 1/2	RS 125 AE 39	48.37	E90 RS 125 AE 39	E135 RS 125 AE 39	I90 RS 125 AE 39	I135 RS 125 AE 39	21.47	
<b>A: 57 mm - 2-1/4"</b>								
8 - 5/16	RS 80 AE 57	47.22	E90 RS 80 AE 57	E135 RS 80 AE 57	I90 RS 80 AE 57	I135 RS 80 AE 57	21.47	
10 - 3/8	RS 100 AE 57	47.98	E90 RS 100 AE 57	E135 RS 100 AE 57	I90 RS 100 AE 57	I135 RS 100 AE 57	21.47	
12.5 - 1/2	RS 125 AE 57	50.20	E90 RS 125 AE 57	E135 RS 125 AE 57	I90 RS 125 AE 57	I135 RS 125 AE 57	21.47	

Length = 2.5 m - 8' 2-1/2"	Brushed chrome anodized aluminum (ACGB)							
H = mm - in.	Profile	\$/ Length	Outside corner, 90°	Outside corner, 135°	Inside corner, 90°	Inside corner, 135°	\$/ Unit	
<b>A: 39 mm - 1-1/2"</b>								
8 - 5/16	RS 80 ACGB 39	60.26	E90 RS 80 ACGB 39	E135 RS 80 ACGB 39	I90 RS 80 ACGB 39	I135 RS 80 ACGB 39	24.24	
10 - 3/8	RS 100 ACGB 39	60.94	E90 RS 100 ACGB 39	E135 RS 100 ACGB 39	I90 RS 100 ACGB 39	I135 RS 100 ACGB 39	24.24	
12.5 - 1/2	RS 125 ACGB 39	63.03	E90 RS 125 ACGB 39	E135 RS 125 ACGB 39	I90 RS 125 ACGB 39	I135 RS 125 ACGB 39	24.24	
<b>A: 57 mm - 2-1/4"</b>								
8 - 5/16	RS 80 ACGB 57	61.38	E90 RS 80 ACGB 57	E135 RS 80 ACGB 57	I90 RS 80 ACGB 57	I135 RS 80 ACGB 57	24.24	
10 - 3/8	RS 100 ACGB 57	62.07	E90 RS 100 ACGB 57	E135 RS 100 ACGB 57	I90 RS 100 ACGB 57	I135 RS 100 ACGB 57	24.24	
12.5 - 1/2	RS 125 ACGB 57	64.14	E90 RS 125 ACGB 57	E135 RS 125 ACGB 57	I90 RS 125 ACGB 57	I135 RS 125 ACGB 57	24.24	

Length = 2.5 m - 8' 2-1/2"	Satin nickel anodized aluminum (AT)							
H = mm - in.	Profile	\$/ Length	Outside corner, 90°	Outside corner, 135°	Inside corner, 90°	Inside corner, 135°	\$/ Unit	
<b>A: 39 mm - 1-1/2"</b>								
8 - 5/16	RS 80 AT 39	46.03	E90 RS 80 AT 39	E135 RS 80 AT 39	I90 RS 80 AT 39	I135 RS 80 AT 39	21.47	
10 - 3/8	RS 100 AT 39	46.78	E90 RS 100 AT 39	E135 RS 100 AT 39	I90 RS 100 AT 39	I135 RS 100 AT 39	21.47	
12.5 - 1/2	RS 125 AT 39	48.37	E90 RS 125 AT 39	E135 RS 125 AT 39	I90 RS 125 AT 39	I135 RS 125 AT 39	21.47	
<b>A: 57 mm - 2-1/4"</b>								
8 - 5/16	RS 80 AT 57	47.22	E90 RS 80 AT 57	E135 RS 80 AT 57	I90 RS 80 AT 57	I135 RS 80 AT 57	21.47	
10 - 3/8	RS 100 AT 57	47.98	E90 RS 100 AT 57	E135 RS 100 AT 57	I90 RS 100 AT 57	I135 RS 100 AT 57	21.47	
12.5 - 1/2	RS 125 AT 57	50.20	E90 RS 125 AT 57	E135 RS 125 AT 57	I90 RS 125 AT 57	I135 RS 125 AT 57	21.47	



<b>Schluter®-RONDEC-STEP</b>							
Length = 2.5 m - 8' 2-1/2"	<b>Brushed nickel anodized aluminum (ATGB)</b>						
H = mm - in.	Profile	\$ / Length	Outside corner, 90°	Outside corner, 135°	Inside corner, 90°	Inside corner, 135°	\$ / Unit
<b>A: 39 mm - 1-1/2"</b>							
8 - 5/16	RS 80 ATGB 39	<b>60.26</b>	E90 RS 80 ATGB 39	E135 RS 80 ATGB 39	I90 RS 80 ATGB 39	I135 RS 80 ATGB 39	<b>24.24</b>
10 - 3/8	RS 100 ATGB 39	<b>60.94</b>	E90 RS 100 ATGB 39	E135 RS 100 ATGB 39	I90 RS 100 ATGB 39	I135 RS 100 ATGB 39	<b>24.24</b>
12.5 - 1/2	RS 125 ATGB 39	<b>63.03</b>	E90 RS 125 ATGB 39	E135 RS 125 ATGB 39	I90 RS 125 ATGB 39	I135 RS 125 ATGB 39	<b>24.24</b>

Length = 2.5 m - 8' 2-1/2"	<b>Satin copper anodized aluminum (AK)</b>						
H = mm - in.	Profile	\$ / Length	Outside corner, 90°	Outside corner, 135°	Inside corner, 90°	Inside corner, 135°	\$ / Unit
<b>A: 39 mm - 1-1/2"</b>							
8 - 5/16	RS 80 AK 39	<b>46.03</b>	E90 RS 80 AK 39	E135 RS 80 AK 39	I90 RS 80 AK 39	I135 RS 80 AK 39	<b>21.47</b>
10 - 3/8	RS 100 AK 39	<b>46.78</b>	E90 RS 100 AK 39	E135 RS 100 AK 39	I90 RS 100 AK 39	I135 RS 100 AK 39	<b>21.47</b>
12.5 - 1/2	RS 125 AK 39	<b>48.37</b>	E90 RS 125 AK 39	E135 RS 125 AK 39	I90 RS 125 AK 39	I135 RS 125 AK 39	<b>21.47</b>
<b>A: 57 mm - 2-1/4"</b>							
8 - 5/16	RS 80 AK 57	<b>47.22</b>	E90 RS 80 AK 57	E135 RS 80 AK 57	I90 RS 80 AK 57	I135 RS 80 AK 57	<b>21.47</b>
10 - 3/8	RS 100 AK 57	<b>47.98</b>	E90 RS 100 AK 57	E135 RS 100 AK 57	I90 RS 100 AK 57	I135 RS 100 AK 57	<b>21.47</b>
12.5 - 1/2	RS 125 AK 57	<b>50.20</b>	E90 RS 125 AK 57	E135 RS 125 AK 57	I90 RS 125 AK 57	I135 RS 125 AK 57	<b>21.47</b>

Length = 2.5 m - 8' 2-1/2"	<b>Brushed copper anodized aluminum (AKGB)</b>						
H = mm - in.	Profile	\$ / Length	Outside corner, 90°	Outside corner, 135°	Inside corner, 90°	Inside corner, 135°	\$ / Unit
<b>A: 39 mm - 1-1/2"</b>							
8 - 5/16	RS 80 AKGB 39	<b>60.26</b>	E90 RS 80 AKGB 39	E135 RS 80 AKGB 39	I90 RS 80 AKGB 39	I135 RS 80 AKGB 39	<b>24.24</b>
10 - 3/8	RS 100 AKGB 39	<b>60.94</b>	E90 RS 100 AKGB 39	E135 RS 100 AKGB 39	I90 RS 100 AKGB 39	I135 RS 100 AKGB 39	<b>24.24</b>
12.5 - 1/2	RS 125 AKGB 39	<b>63.03</b>	E90 RS 125 AKGB 39	E135 RS 125 AKGB 39	I90 RS 125 AKGB 39	I135 RS 125 AKGB 39	<b>24.24</b>
<b>A: 57 mm - 2-1/4"</b>							
8 - 5/16	RS 80 AKGB 57	<b>61.38</b>	E90 RS 80 AKGB 57	E135 RS 80 AKGB 57	I90 RS 80 AKGB 57	I135 RS 80 AKGB 57	<b>24.24</b>
10 - 3/8	RS 100 AKGB 57	<b>62.07</b>	E90 RS 100 AKGB 57	E135 RS 100 AKGB 57	I90 RS 100 AKGB 57	I135 RS 100 AKGB 57	<b>24.24</b>
12.5 - 1/2	RS 125 AKGB 57	<b>64.14</b>	E90 RS 125 AKGB 57	E135 RS 125 AKGB 57	I90 RS 125 AKGB 57	I135 RS 125 AKGB 57	<b>24.24</b>

Length = 2.5 m - 8' 2-1/2"	<b>Satin brass anodized aluminum (AM)</b>						
H = mm - in.	Profile	\$ / Length	Outside corner, 90°	Outside corner, 135°	Inside corner, 90°	Inside corner, 135°	\$ / Unit
<b>A: 57 mm - 2-1/4"</b>							
8 - 5/16	RS 80 AM 57	<b>47.22</b>	E90 RS 80 AM 57	E135 RS 80 AM 57	I90 RS 80 AM 57	I135 RS 80 AM 57	<b>21.47</b>
10 - 3/8	RS 100 AM 57	<b>47.98</b>	E90 RS 100 AM 57	E135 RS 100 AM 57	I90 RS 100 AM 57	I135 RS 100 AM 57	<b>21.47</b>
12.5 - 1/2	RS 125 AM 57	<b>50.20</b>	E90 RS 125 AM 57	E135 RS 125 AM 57	I90 RS 125 AM 57	I135 RS 125 AM 57	<b>21.47</b>

Length = 2.5 m - 8' 2-1/2"	<b>Brushed brass anodized aluminum (AMGB)</b>						
H = mm - in.	Profile	\$ / Length	Outside corner, 90°	Outside corner, 135°	Inside corner, 90°	Inside corner, 135°	\$ / Unit
<b>A: 39 mm - 1-1/2"</b>							
8 - 5/16	RS 80 AMGB 39	<b>60.26</b>	E90 RS 80 AMGB 39	E135 RS 80 AMGB 39	I90 RS 80 AMGB 39	I135 RS 80 AMGB 39	<b>24.24</b>
10 - 3/8	RS 100 AMGB 39	<b>60.94</b>	E90 RS 100 AMGB 39	E135 RS 100 AMGB 39	I90 RS 100 AMGB 39	I135 RS 100 AMGB 39	<b>24.24</b>
12.5 - 1/2	RS 125 AMGB 39	<b>63.03</b>	E90 RS 125 AMGB 39	E135 RS 125 AMGB 39	I90 RS 125 AMGB 39	I135 RS 125 AMGB 39	<b>24.24</b>
<b>A: 57 mm - 2-1/4"</b>							
8 - 5/16	RS 80 AMGB 57	<b>61.38</b>	E90 RS 80 AMGB 57	E135 RS 80 AMGB 57	I90 RS 80 AMGB 57	I135 RS 80 AMGB 57	<b>24.24</b>
10 - 3/8	RS 100 AMGB 57	<b>62.07</b>	E90 RS 100 AMGB 57	E135 RS 100 AMGB 57	I90 RS 100 AMGB 57	I135 RS 100 AMGB 57	<b>24.24</b>
12.5 - 1/2	RS 125 AMGB 57	<b>64.14</b>	E90 RS 125 AMGB 57	E135 RS 125 AMGB 57	I90 RS 125 AMGB 57	I135 RS 125 AMGB 57	<b>24.24</b>



Schluter®-RONDEC-STEP							
Length = 2.5 m - 8' 2-1/2"	Brushed antique bronze anodized aluminum (ABGB)						
H = mm - in.	Profile	\$/ Length	Outside corner, 90°	Outside corner, 135°	Inside corner, 90°	Inside corner, 135°	\$/ Unit
<b>A: 39 mm - 1-1/2"</b>							
8 - 5/16	RS 80 ABGB 39	60.26	E90 RS 80 ABGB 39	E135 RS 80 ABGB 39	I90 RS 80 ABGB 39	I135 RS 80 ABGB 39	24.24
10 - 3/8	RS 100 ABGB 39	60.94	E90 RS 100 ABGB 39	E135 RS 100 ABGB 39	I90 RS 100 ABGB 39	I135 RS 100 ABGB 39	24.24
12.5 - 1/2	RS 125 ABGB 39	63.03	E90 RS 125 ABGB 39	E135 RS 125 ABGB 39	I90 RS 125 ABGB 39	I135 RS 125 ABGB 39	24.24

### Schluter®-RONDEC-CT

**Schluter®-RONDEC-CT** is a double-rail edging profile for countertops to be fitted with a ceramic or dimension stone tile covering. The face of the profile features a recessed section to which field or accent tile is bonded. The top and bottom edges of the profile are symmetrically rounded and match the Schluter®-RONDEC profile (page 29). RONDEC-CT features an integrated joint spacer that establishes a defined joint cavity between the tile and the profile.

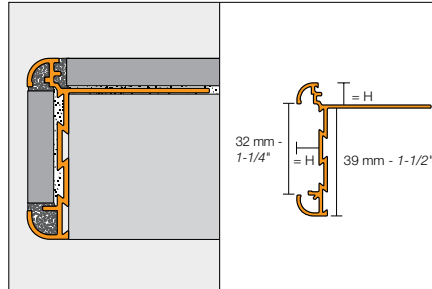

Outside corner (90° or 135°)

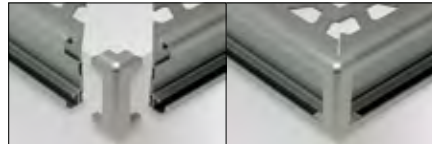

Inside corner (90° or 135°)



Schluter®-RONDEC-CT							
Length = 2.5 m - 8' 2-1/2"	Satin anodized aluminum (AE)						
H = mm - in.	Profile	\$/ Length	Outside corner, 90°	Outside corner, 135°	Inside corner, 90°	Inside corner, 135°	\$/ Unit
8 - 5/16	RC 80 AE 39	50.95	E90 RC 80 AE 39	E135 RC 80 AE 39	I90 RC 80 AE 39	I135 RC 80 AE 39	26.72
10 - 3/8	RC 100 AE 39	51.82	E90 RC 100 AE 39	E135 RC 100 AE 39	I90 RC 100 AE 39	I135 RC 100 AE 39	26.72
12.5 - 1/2	RC 125 AE 39	54.20	E90 RC 125 AE 39	E135 RC 125 AE 39	I90 RC 125 AE 39	I135 RC 125 AE 39	26.72

Schluter®-RONDEC-CT							
Length = 2.5 m - 8' 2-1/2"	Brushed chrome anodized aluminum (ACGB)						
H = mm - in.	Profile	\$/ Length	Outside corner, 90°	Outside corner, 135°	Inside corner, 90°	Inside corner, 135°	\$/ Unit
8 - 5/16	RC 80 ACGB 39	57.90	E90 RC 80 ACGB 39	E135 RC 80 ACGB 39	I90 RC 80 ACGB 39	I135 RC 80 ACGB 39	30.78
10 - 3/8	RC 100 ACGB 39	58.22	E90 RC 100 ACGB 39	E135 RC 100 ACGB 39	I90 RC 100 ACGB 39	I135 RC 100 ACGB 39	30.78
12.5 - 1/2	RC 125 ACGB 39	60.25	E90 RC 125 ACGB 39	E135 RC 125 ACGB 39	I90 RC 125 ACGB 39	I135 RC 125 ACGB 39	30.78

Schluter®-RONDEC-CT							
Length = 2.5 m - 8' 2-1/2"	Satin nickel anodized aluminum (AT)						
H = mm - in.	Profile	\$/ Length	Outside corner, 90°	Outside corner, 135°	Inside corner, 90°	Inside corner, 135°	\$/ Unit
8 - 5/16	RC 80 AT 39	55.81	E90 RC 80 AT 39	E135 RC 80 AT 39	I90 RC 80 AT 39	I135 RC 80 AT 39	26.72
10 - 3/8	RC 100 AT 39	57.04	E90 RC 100 AT 39	E135 RC 100 AT 39	I90 RC 100 AT 39	I135 RC 100 AT 39	26.72
12.5 - 1/2	RC 125 AT 39	59.43	E90 RC 125 AT 39	E135 RC 125 AT 39	I90 RC 125 AT 39	I135 RC 125 AT 39	26.72



Schluter®-RONDEC-CT							
Length = 2.5 m - 8' 2-1/2"		Brushed nickel anodized aluminum (ATGB)					
H = mm - in.	Profile	\$ / Length	Outside corner, 90°	Outside corner, 135°	Inside corner, 90°	Inside corner, 135°	\$ / Unit
8 - 5/16	RC 80 ATGB 39	<b>60.65</b>	E90 RC 80 ATGB 39	E135 RC 80 ATGB 39	I90 RC 80 ATGB 39	I135 RC 80 ATGB 39	<b>30.78</b>
10 - 3/8	RC 100 ATGB 39	<b>61.82</b>	E90 RC 100 ATGB 39	E135 RC 100 ATGB 39	I90 RC 100 ATGB 39	I135 RC 100 ATGB 39	<b>30.78</b>
12.5 - 1/2	RC 125 ATGB 39	<b>62.25</b>	E90 RC 125 ATGB 39	E135 RC 125 ATGB 39	I90 RC 125 ATGB 39	I135 RC 125 ATGB 39	<b>30.78</b>

Length = 2.5 m - 8' 2-1/2"		Satin copper anodized aluminum (AK)					
H = mm - in.	Profile	\$ / Length	Outside corner, 90°	Outside corner, 135°	Inside corner, 90°	Inside corner, 135°	\$ / Unit
8 - 5/16	RC 80 AK 39	<b>55.81</b>	E90 RC 80 AK 39	E135 RC 80 AK 39	I90 RC 80 AK 39	I135 RC 80 AK 39	<b>26.72</b>
10 - 3/8	RC 100 AK 39	<b>57.04</b>	E90 RC 100 AK 39	E135 RC 100 AK 39	I90 RC 100 AK 39	I135 RC 100 AK 39	<b>26.72</b>
12.5 - 1/2	RC 125 AK 39	<b>59.43</b>	E90 RC 125 AK 39	E135 RC 125 AK 39	I90 RC 125 AK 39	I135 RC 125 AK 39	<b>26.72</b>

Length = 2.5 m - 8' 2-1/2"		Brushed copper anodized aluminum (AKGB)					
H = mm - in.	Profile	\$ / Length	Outside corner, 90°	Outside corner, 135°	Inside corner, 90°	Inside corner, 135°	\$ / Unit
8 - 5/16	RC 80 AKGB 39	<b>60.65</b>	E90 RC 80 AKGB 39	E135 RC 80 AKGB 39	I90 RC 80 AKGB 39	I135 RC 80 AKGB 39	<b>30.78</b>
10 - 3/8	RC 100 AKGB 39	<b>61.82</b>	E90 RC 100 AKGB 39	E135 RC 100 AKGB 39	I90 RC 100 AKGB 39	I135 RC 100 AKGB 39	<b>30.78</b>
12.5 - 1/2	RC 125 AKGB 39	<b>62.25</b>	E90 RC 125 AKGB 39	E135 RC 125 AKGB 39	I90 RC 125 AKGB 39	I135 RC 125 AKGB 39	<b>30.78</b>

Length = 2.5 m - 8' 2-1/2"		Satin brass anodized aluminum (AM)					
H = mm - in.	Profile	\$ / Length	Outside corner, 90°	Outside corner, 135°	Inside corner, 90°	Inside corner, 135°	\$ / Unit
8 - 5/16	RC 80 AM 39	<b>52.58</b>	E90 RC 80 AM 39	E135 RC 80 AM 39	I90 RC 80 AM 39	I135 RC 80 AM 39	<b>26.72</b>
10 - 3/8	RC 100 AM 39	<b>53.83</b>	E90 RC 100 AM 39	E135 RC 100 AM 39	I90 RC 100 AM 39	I135 RC 100 AM 39	<b>26.72</b>
12.5 - 1/2	RC 125 AM 39	<b>56.21</b>	E90 RC 125 AM 39	E135 RC 125 AM 39	I90 RC 125 AM 39	I135 RC 125 AM 39	<b>26.72</b>

Length = 2.5 m - 8' 2-1/2"		Brushed brass anodized aluminum (AMGB)					
H = mm - in.	Profile	\$ / Length	Outside corner, 90°	Outside corner, 135°	Inside corner, 90°	Inside corner, 135°	\$ / Unit
8 - 5/16	RC 80 AMGB 39	<b>57.90</b>	E90 RC 80 AMGB 39	E135 RC 80 AMGB 39	I90 RC 80 AMGB 39	I135 RC 80 AMGB 39	<b>30.78</b>
10 - 3/8	RC 100 AMGB 39	<b>58.22</b>	E90 RC 100 AMGB 39	E135 RC 100 AMGB 39	I90 RC 100 AMGB 39	I135 RC 100 AMGB 39	<b>30.78</b>
12.5 - 1/2	RC 125 AMGB 39	<b>60.25</b>	E90 RC 125 AMGB 39	E135 RC 125 AMGB 39	I90 RC 125 AMGB 39	I135 RC 125 AMGB 39	<b>30.78</b>

Schluter®-TRENDLINE Textured Color-coated Aluminum

Length = 2.5 m - 8' 2-1/2"		Textured color-coated aluminum (TS)	
H = mm - in.	Profile	\$ / Length	
8 - 5/16	RC 80 + color* 39	<b>75.71</b>	
10 - 3/8	RC 100 + color* 39	<b>79.81</b>	
12.5 - 1/2	RC 125 + color* 39	<b>81.76</b>	

**\*Color Codes**



TSB  
Beige



TSOB  
Bronze



TSG  
Pewter

\* To complete the item number, add the color code (e.g., RC 80 **TSB** 39).

Length = 2.5 m - 8' 2-1/2"		Textured color-coated aluminum (TS)				
H = mm - in.	Outside corner, 90°	Outside corner, 135°	Inside corner, 90°	Inside corner, 135°	\$ / Unit	
8 - 5/16	E90 RC 80 + color* 39	E135 RC 80 + color* 39	I90 RC 80 + color* 39	I135 RC 80 + color* 39	<b>32.32</b>	
10 - 3/8	E90 RC 100 + color* 39	E135 RC 100 + color* 39	I90 RC 100 + color* 39	I135 RC 100 + color* 39	<b>32.32</b>	
12.5 - 1/2	E90 RC 125 + color* 39	E135 RC 125 + color* 39	I90 RC 125 + color* 39	I135 RC 125 + color* 39	<b>32.32</b>	



### Schluter®-SCHIENE-STEP

**Schluter®-SCHIENE-STEP** is a finishing and edging profile for ceramic tile and natural stone installations on countertops, stairs, and tile over tile applications on walls. The top of the profile features a vertical wall section that finishes and protects the tile from damage, while the vertical leg covers the edge of the sub-assembly, top of the riser, or existing wall tile edge.

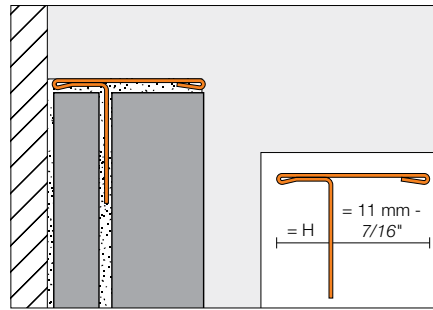
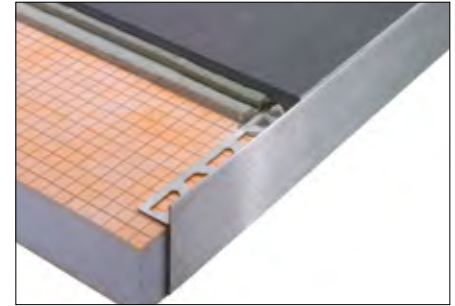
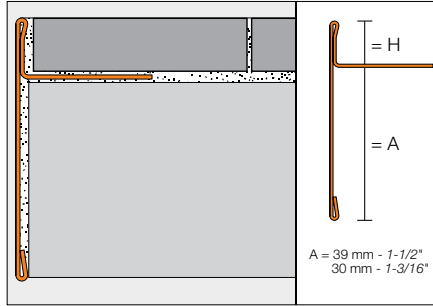

Schluter®-SCHIENE-STEP							
Length = 2.5 m - 8' 2-1/2"	Brushed Stainless Steel 304 (1.4301 = V2A) (EB)						
H = mm - in.	Profile	\$ / Length	Inside corner, 90°	Inside corner, 135°	Outside corner, 90° and End Cap	Outside corner, 135°	\$ / Unit
<b>A: 39 mm - 1-1/2"</b>							
6 - 1/4	SS 60 EB 39	<b>139.61</b>	I90 / SS 60 EB 39	I135 / SS 60 EB 39	E90 / SS 60 EB 39	E135 / SS 60 EB 39	<b>18.44</b>
9 - 11/32	SS 90 EB 39	<b>145.40</b>	I90 / SS 90 EB 39	I135 / SS 90 EB 39	E90 / SS 90 EB 39	E135 / SS 90 EB 39	<b>18.44</b>
11 - 7/16	SS 110 EB 39	<b>148.03</b>	I90 / SS 110 EB 39	I135 / SS 110 EB 39	E90 / SS 110 EB 39	E135 / SS 110 EB 39	<b>18.44</b>
12.5 - 1/2	SS 125 EB 39	<b>150.36</b>	I90 / SS 125 EB 39	I135 / SS 125 EB 39	E90 / SS 125 EB 39	E135 / SS 125 EB 39	<b>18.44</b>
<b>A: 30 mm - 1-3/16"</b>							
9 - 11/32	SS 90 EB 30	<b>109.94</b>	-	-	E90 / SS 90 EB 30	-	<b>18.44</b>
11 - 7/16	SS 110 EB 30	<b>111.35</b>	-	-	E90 / SS 110 EB 30	-	<b>18.44</b>
12.5 - 1/2	SS 125 EB 30	<b>112.76</b>	-	-	E90 / SS 125 EB 30	-	<b>18.44</b>
<b>A: 11 mm - 7/16"</b>							
6 - 1/4	SS 60 EB 11	<b>105.77</b>					
12.5 - 1/2	SS 125 EB 11	<b>107.13</b>					

Brushed Stainless Steel 304 (1.4301 = V2A) (EB)		
H = mm - in.	Connector	\$ / Unit
<b>A: 39 mm - 1-1/2"</b>		
6 - 1/4	V / SS 60 EB 39	<b>15.68</b>
9 - 11/32	V / SS 90 EB 39	<b>15.68</b>
11 - 7/16	V / SS 110 EB 39	<b>15.68</b>
12.5 - 1/2	V / SS 125 EB 39	<b>15.68</b>
<b>A: 30 mm - 1-3/16"</b>		
9 - 11/32	V / SS 90 EB 30	<b>15.68</b>
11 - 7/16	V / SS 110 EB 30	<b>15.68</b>
12.5 - 1/2	V / SS 125 EB 30	<b>15.68</b>
<b>A: 11 mm - 7/16"</b>		
6 - 1/4	V / SS 60 EB 11	<b>15.68</b>
12.5 - 1/2	V / SS 125 EB 11	<b>15.68</b>

**Note:** The anchoring leg of **Schluter®-SCHIENE-STEP** is available with a special radius perforation so that the profile can be used to form curves.

- Price surcharge: \$0.70 per foot
- Item No.: R / Profile No. (e.g., R/SS 60 EB 11)
- For delivery time, please call Customer Service





### Schluter®-ECK-E

**Schluter®-ECK-E** is a stainless steel edging profile for outside corners of tiled walls that offers excellent edge protection against mechanical stresses in commercial/industrial applications. The profile produces a radiused edge along the outside wall corner for a clean, decorative finish. ECK-E is installed simultaneously with the tile, while ECK-K (page 55) is subsequently installed on the outside corners of existing installations.

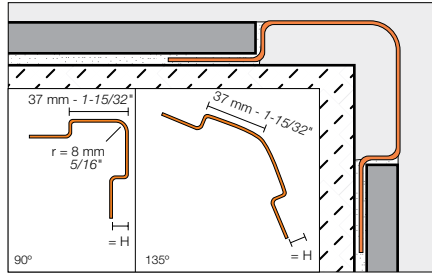

**Note:** ECK-E is also available in stainless steel 316L (1.4404 = V4A). Contact Customer Service for price and availability.

Schluter®-ECK-E				
H = mm - in.	Stainless steel 304 (1.4301 = V2A) (E)		Brushed stainless steel 304 (1.4301 = V2A) (EB)	
	Item No.	\$ / Length	Item No.	\$ / Length
<b>90° Angle</b>				
Length = 1.50 m - 4' 11"				
6 - 1/4	E37 V2A 60/150	60.38	E37 V2A EB 60/150	78.48
8 - 5/16	E37 V2A 80/150	62.79	E37 V2A EB 80/150	81.62
11 - 7/16	E37 V2A 110/150	65.30	E37 V2A EB 110/150	84.87
Length = 2.00 m - 6' 7"				
6 - 1/4	E37 V2A 60/200	77.56	E37 V2A EB 60/200	100.86
8 - 5/16	E37 V2A 80/200	80.64	E37 V2A EB 80/200	104.88
11 - 7/16	E37 V2A 110/200	83.98	E37 V2A EB 110/200	109.19
Length = 2.5 m - 8' 2-1/2"				
6 - 1/4	E37 V2A 60/250	94.75	E37 V2A EB 60/250	123.16
8 - 5/16	E37 V2A 80/250	98.55	E37 V2A EB 80/250	128.10
11 - 7/16	E37 V2A 110/250	102.71	E37 V2A EB 110/250	133.52
Length = 3.00 m - 9' 10"				
6 - 1/4	E37 V2A 60/300	117.07	E37 V2A EB 60/300	152.23
8 - 5/16	E37 V2A 80/300	123.52	E37 V2A EB 80/300	160.59
11 - 7/16	E37 V2A 110/300	127.81	E37 V2A EB 110/300	166.20
<b>135° Angle</b>				
Length = 2.5 m - 8' 2-1/2"				
6 - 1/4	E37 E 60S	90.90	E37 EB 60S	118.37
8 - 5/16	E37 E 80S	94.22	E37 EB 80S	122.61
11 - 7/16	E37 E 110S	98.04	E37 EB 110S	127.47
Length = 3.00 m - 9' 10"				
6 - 1/4	E37 E 60S/300	109.01	E37 EB 60S/300	141.97
8 - 5/16	E37 E 80S/300	113.02	E37 EB 80S/300	147.12
11 - 7/16	E37 E 110S/300	117.64	E37 EB 110S/300	152.96





### Schluter®-ECK-K

**Schluter®-ECK-K** is a stainless steel edging profile for outside corners of tiled walls that offers excellent edge protection against mechanical stresses in commercial/ industrial applications. The profile produces a radiused edge along the outside wall corner for a clean, decorative finish. ECK-K is subsequently bonded to the outside corners of existing installations. As such, ECK-K can be installed as a repair so that existing, damaged corners do not have to be replaced.

**Note:** ECK-K is also available in stainless steel 316L (1.4404 = V4A). Contact Customer Service for price and availability.

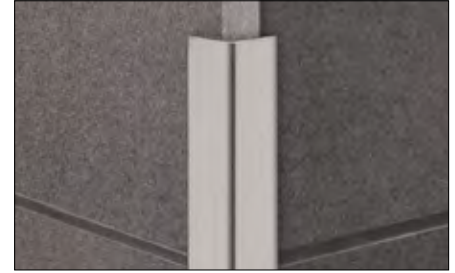
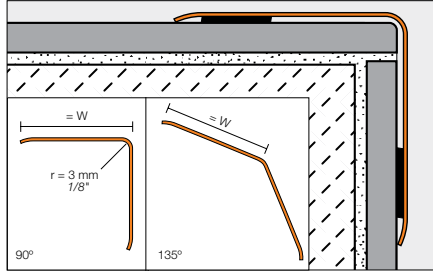

<b>Schluter®-ECK-K</b>				
W = mm - in.	Stainless steel 304 (1.4301 = V2A) (E)		Brushed stainless steel 304 (1.4301 = V2A) (EB)	
	Item No.	\$ / Length	Item No.	\$ / Length
<b>90° Angle</b>				
Length = 1.50 m - 4' 11"				
15 - 9/16	K15 V2A/150	35.69	K15 V2A EB/150	46.41
32 - 1-9/32	K32 V2A/150	58.71	K32 V2A EB/150	76.36
50 - 2	K50 V2A/150	75.55	K50 V2A EB/150	98.26
Length = 2.00 m - 6' 7"				
32 - 1-9/32	K32 V2A/200	78.40	K32 V2A EB/200	101.87
50 - 2	K50 V2A/200	100.74	K50 V2A EB/200	130.96
Length = 2.5 m - 8' 2-1/2"				
15 - 9/16	K15 V2A/250	59.43	K15 V2A EB/250	77.36
32 - 1-9/32	K32 V2A/250	97.90	K32 V2A EB/250	127.31
50 - 2	K50 V2A/250	125.92	K50 V2A EB/250	163.66
Length = 3.00 m - 9' 10"				
15 - 9/16	K15 V2A/300	71.32	K15 V2A EB/300	92.70
32 - 1-9/32	K32 V2A/300	118.86	K32 V2A EB/300	154.46
50 - 2	K50 V2A/300	150.27	K50 V2A EB/300	195.34
<b>135° Angle</b>				
Length = 1.50 m - 4' 11"				
32 - 1-9/32	K32 ES/150	57.00		
Length = 2.5 m - 8' 2-1/2"				
32 - 1-9/32	K32 ES	94.95		
Length = 3.00 m - 9' 10"				
32 - 1-9/32	K32 ES/300	113.94		



### Schluter®-ECK-KHK

**Schluter®-ECK-KHK** is a stainless steel profile for inside wall corners that produces a radiused edge for a clean, decorative finish. ECK-KHK provides a 5/16" (8 mm) radius to prevent the accumulation of dirt and make cleaning simple. Thus, the profile is especially suited for commercial kitchens, bathrooms, food processing plants or any environment where a sanitary corner is desired. ECK-KHK is subsequently bonded to the inside corners of existing tile or other wall coverings. As such, the profile can be installed as a repair so that existing, damaged corners do not have to be replaced.

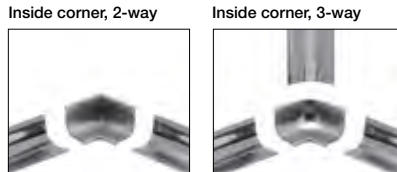
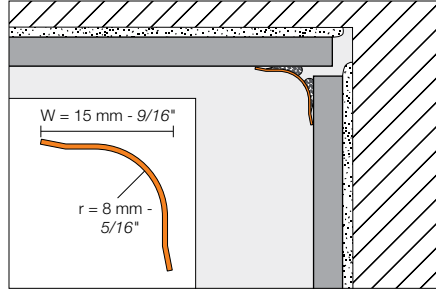

### Schluter®-ECK-KHK

Stainless steel 304 (1.4301 = V2A) (E)						
W = mm - in.	Profile	\$ / Length	Outside corner, 90°	Inside corner, 90° (2-way)	Inside corner, 90° (3-way)	\$ / Unit
Length = 1.50 m - 4' 11"			E/KHK 15 E	1/2KHK 15 E	1/3KHK 15 E	10.45
15 - 9/16	KHK 15 E/150	24.55				
Length = 2.00 m - 6' 7"						
15 - 9/16	KHK 15 E/200	32.72				
Length = 2.5 m - 8' 2-1/2"						
15 - 9/16	KHK 15 E	40.91				
Length = 3.00 m - 9' 10"						
15 - 9/16	KHK 15 E/300	49.08				
Connector	V/KHK 15 E					7.09

Brushed stainless steel 304 (1.4301 = V2A) (EB)						
W = mm - in.	Profile	\$ / Length	Outside corner, 90°	Inside corner, 90° (2-way)	Inside corner, 90° (3-way)	\$ / Unit
Length = 1.50 m - 4' 11"			E/KHK 15 EB	1/2KHK 15 EB	1/3KHK 15 EB	10.45
15 - 9/16	KHK 15 EB/150	27.56				
Length = 2.00 m - 6' 7"						
15 - 9/16	KHK 15 EB/200	36.74				
Length = 2.5 m - 8' 2-1/2"						
15 - 9/16	KHK 15 EB	45.94				
Length = 3.00 m - 9' 10"						
15 - 9/16	KHK 15 EB/300	55.13				
Connector	V/KHK 15 EB					7.09



### Schluter®-ECK-KI

**Schluter®-ECK-KI** is a stainless steel profile for inside wall corners that produces a clean, decorative finish. ECK-KI is subsequently bonded to the inside corners of existing tile or other wall coverings. As such, the profile can be installed as a repair so that existing, damaged corners do not have to be replaced.

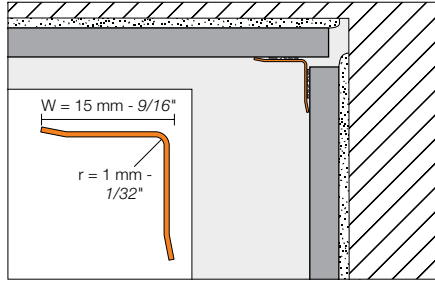

Schluter®-ECK-KI				
W = mm - in.	Stainless steel 304 (1.4301 = V2A) (E)		Brushed stainless steel 304 (1.4301 = V2A) (EB)	
	Item No.	\$ / Length	Item No.	\$ / Length
Length = 1.50 m - 4' 11"				
15 - 9/16	KI15 E/150	24.55	KI15 EB/150	27.56
Length = 2.00 m - 6' 7"				
15 - 9/16	KI15 E/200	32.72	KI15 EB/200	36.74
Length = 2.5 m - 8' 2-1/2"				
15 - 9/16	KI15 E	40.91	KI15 EB	45.94
Length = 3.00 m - 9' 10"				
15 - 9/16	KI15 E/300	49.08	KI15 EB/300	55.13

### Schluter®-REMA

**Schluter®-REMA** is a system for creating concealed access panels in tiled walls without impairing the visual appearance of the tile covering. REMA is suited for all tile sizes and thicknesses, and adapts perfectly to the joint pattern.

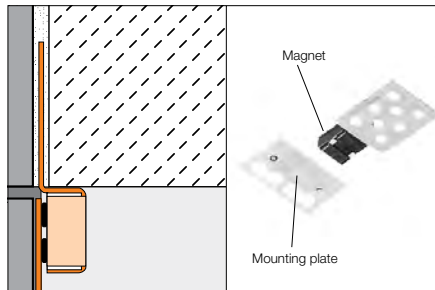

Schluter®-REMA	
Set = 4 Magnets + 4 Mounting plates	
Item No.	\$ / Set
REMA	11.10



### Schluter®-DESIGNBASE-SL

The Schluter®-DESIGNBASE-SL profile provides a modern alternative to traditional baseboards. The profile is available in brushed stainless steel, anodized aluminum, and color-coated aluminum. DESIGNBASE features a clean, sleek look, and is simply attached to the wall with a suitable adhesive. An optional sealing lip accessory is available to protect the floor/wall transition from moisture penetration and to reduce the transmission of impact sound.

The brushed stainless steel profile is available in 4-3/8" or 6-3/8" (110 or 160 mm) heights to meet code requirements for a commercial cove base.

The anodized and color-coated aluminum profiles are available in 2-3/8" or 3-1/8" (60 or 80 mm) heights.

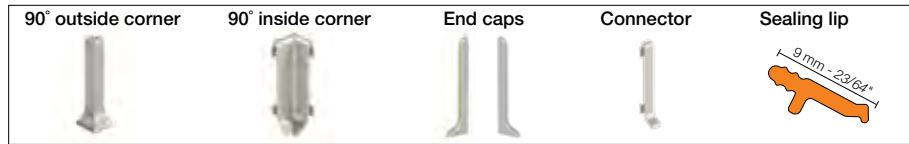
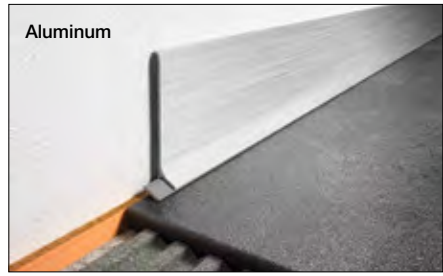
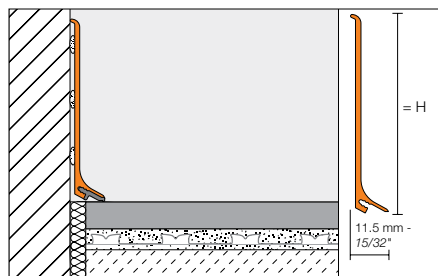
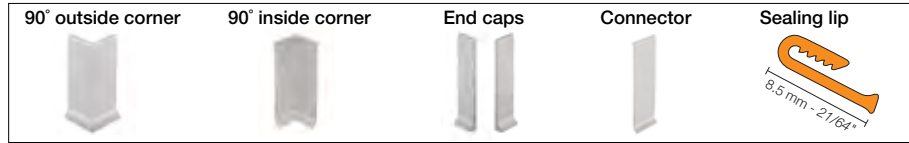
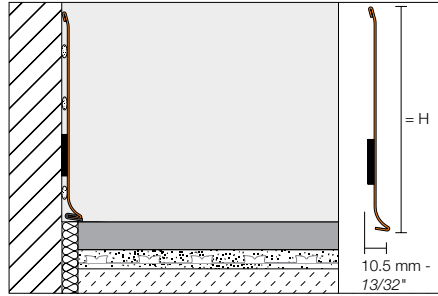

### Schluter®-DESIGNBASE-SL-E

Length = 2.5 m - 8' 2-1/2"		Brushed stainless steel 304 (1.4301 = V2A) (EB)				
H = mm - in.	Profile	\$ / Length	Outside corner, 90°	\$ / Unit	Inside corner, 90°	\$ / Unit
110 - 4-3/8	DB SL 110 EB	117.33	E90 / DB SL 110 EB	58.44	I90 / DB SL 110 EB	58.44
160 - 6-3/8	DB SL 160 EB	164.50	E90 / DB SL 160 EB	60.44	I90 / DB SL 160 EB	60.44

H = mm - in.	End cap (left)	\$ / Unit	End cap (right)	\$ / Unit	Connector	\$ / Unit
110 - 4-3/8	EL / DB SL 110 EB	58.44	ER / DB SL 110 EB	58.44	V / DB SL 110 EB	31.78
160 - 6-3/8	EL / DB SL 160 EB	60.44	ER / DB SL 160 EB	60.44	V / DB SL 160 EB	32.83

Length = 2.5 m - 8' 2-1/2"		Schluter®-DESIGNBASE-SLZ-E	
Sealing lip		\$ / Length	
DB ZS LL E		17.99	

### Schluter®-DESIGNBASE-SL

Length = 2.5 m - 8' 2-1/2"		Satin anodized aluminum (AE)				
H = mm - in.	Profile	\$ / Length	Outside corner, 90°	\$ / Unit	Inside corner, 90°	\$ / Unit
60 - 2-3/8	DB SL 60 AE	27.93	ED / DB SL 60 AE	10.21	ID / DB SL 60 AE	10.21
80 - 3-1/8	DB SL 80 AE	34.14	ED / DB SL 80 AE	10.21	ID / DB SL 80 AE	10.21

H = mm - in.	End cap (left)	\$ / Unit	End cap (right)	\$ / Unit	Connector	\$ / Unit
60 - 2-3/8	EL / DB SL 60 AE	8.98	ER / DB SL 60 AE	8.98	V / DB SL 60 AE	8.98
80 - 3-1/8	EL / DB SL 80 AE	8.98	ER / DB SL 80 AE	8.98	V / DB SL 80 AE	8.98

**Schluter®-DESIGNBASE-SL**

Length = 2.5 m - 8' 2-1/2"	Anodized aluminum with brushed stainless steel appearance (AEEB)					
H = mm - in.	Profile	\$ / Length	Outside corner, 90°	\$ / Unit	Inside corner, 90°	\$ / Unit
60 - 2-3/8	DB SL 60 AEEB	86.37	ED / DB SL 60 AEEB	10.21	ID / DB SL 60 AEEB	10.21
80 - 3-1/8	DB SL 80 AEEB	113.29	ED / DB SL 80 AEEB	10.21	ID / DB SL 80 AEEB	10.21

H = mm - in.	End cap (left)	\$ / Unit	End cap (right)	\$ / Unit	Connector	\$ / Unit
60 - 2-3/8	EL / DB SL 60 AEEB	8.98	ER / DB SL 60 AEEB	8.98	V / DB SL 60 AEEB	8.98
80 - 3-1/8	EL / DB SL 80 AEEB	8.98	ER / DB SL 80 AEEB	8.98	V / DB SL 80 AEEB	8.98

**Note:** For reasons associated with production technology, inside corners ID / DB SL 60 AEEB and ID / DB SL 80 AEEB are not brushed.

Length = 2.5 m - 8' 2-1/2"	Matte white color-coated aluminum (MBW)					
H = mm - in.	Profile	\$ / Length	Outside corner, 90°	\$ / Unit	Inside corner, 90°	\$ / Unit
60 - 2-3/8	DB SL 60 MBW	47.98	ED / DB SL 60 MBW	10.21	ID / DB SL 60 MBW	10.21
80 - 3-1/8	DB SL 80 MBW	68.09	ED / DB SL 80 MBW	10.21	ID / DB SL 80 MBW	10.21

H = mm - in.	End cap (left)	\$ / Unit	End cap (right)	\$ / Unit	Connector	\$ / Unit
60 - 2-3/8	EL / DB SL 60 MBW	8.98	ER / DB SL 60 MBW	8.98	V / DB SL 60 MBW	8.98
80 - 3-1/8	EL / DB SL 80 MBW	8.98	ER / DB SL 80 MBW	8.98	V / DB SL 80 MBW	8.98

Length = 2.5 m - 8' 2-1/2"	Schluter®-DESIGNBASE-SLZ	
	Sealing lip	\$ / Length
	DB ZS LL	10.21



## Schluter® Profiles

### Edge-protection & slip-resistant profiles for stairs

Tiled stair edges are vulnerable to chipping and breaking and create a slip hazard, especially in exterior applications. Schluter stair-nosing profiles protect exposed tile edges and improve safety on tiled stairways by providing slip-resistant wear surfaces and increased visibility—all while providing decorative accents within the tile covering.

Stair-nosing profiles are available in a variety of shapes, sizes, materials, and finishes, with options designed for both commercial and residential applications.

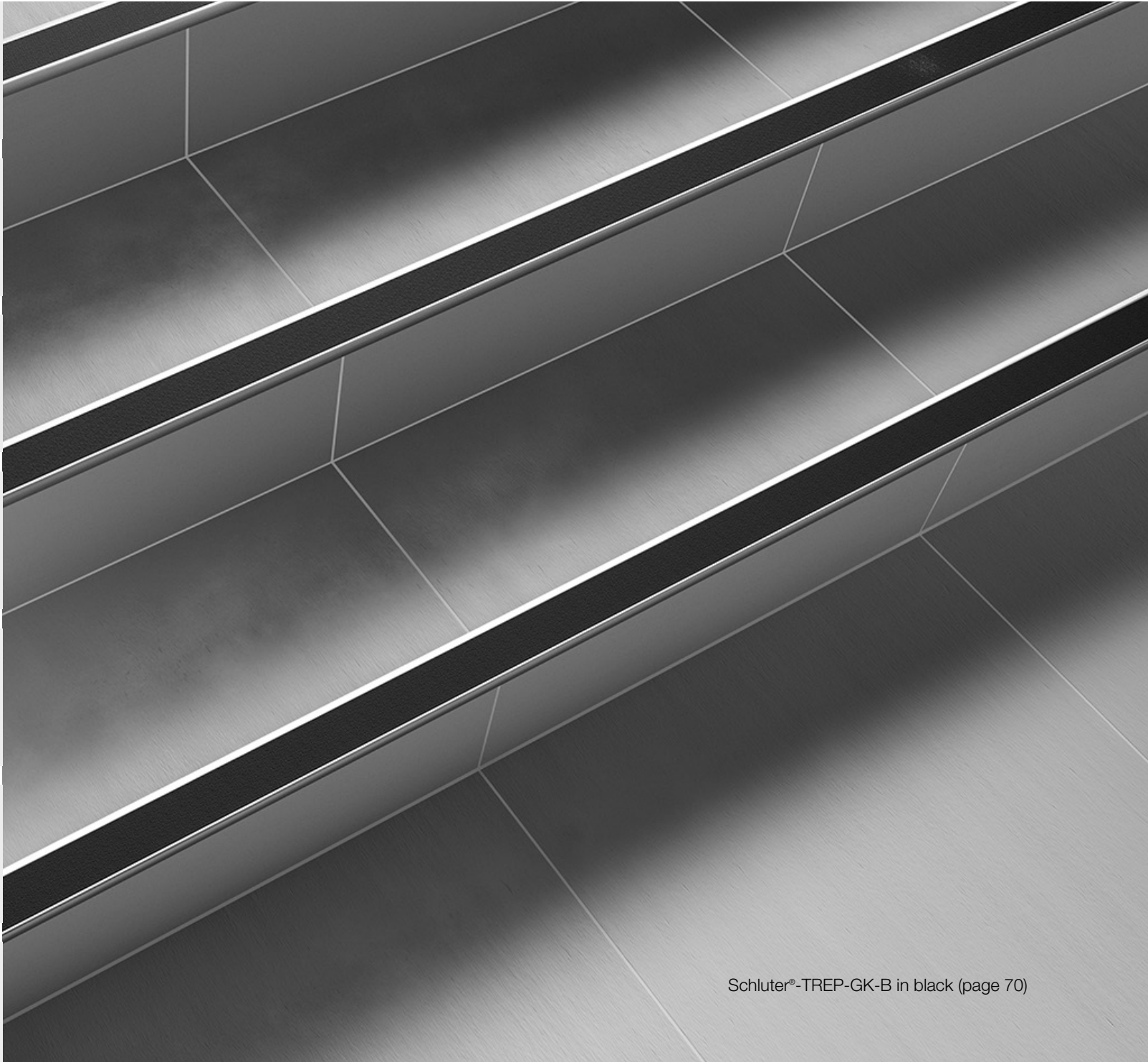



**Schluter®-RONDEC-STEP**

**Schluter®-RONDEC-STEP** is a finishing and edging profile for ceramic tile and dimension stone installations on countertops and stairs. The top of the profile features a symmetrically rounded edge that matches the Schluter®-RONDEC profile (page 29), while the vertical leg of the profile hides the exposed edge of the sub-assembly. RONDEC-STEP features an integrated joint spacer that establishes a defined joint cavity between the tile and the profile.

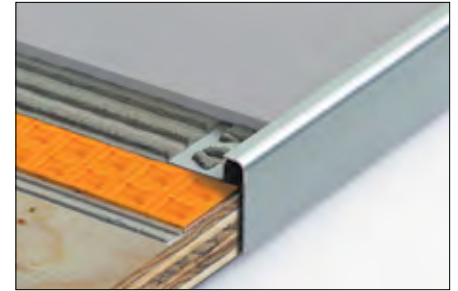
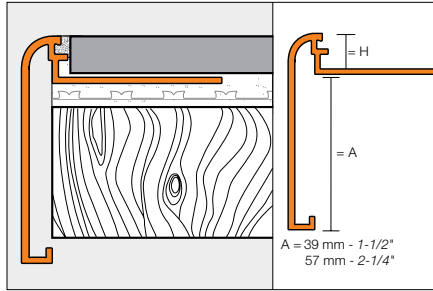

Outside corner (90° or 135°)

Inside corner (90° or 135°)

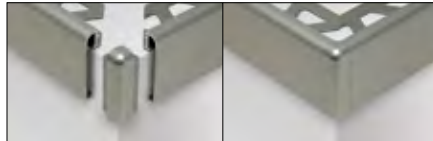

**Schluter®-RONDEC-STEP**

Length = 2.5 m - 8' 2-1/2"		Satin anodized aluminum (AE)						
H = mm - in.	Profile	\$/ Length	Outside corner, 90°	Outside corner, 135°	Inside corner, 90°	Inside corner, 135°	\$/ Unit	
<b>A: 39 mm - 1-1/2"</b>								
8 - 5/16	RS 80 AE 39	46.03	E90 RS 80 AE 39	E135 RS 80 AE 39	I90 RS 80 AE 39	I135 RS 80 AE 39	21.47	
10 - 3/8	RS 100 AE 39	46.78	E90 RS 100 AE 39	E135 RS 100 AE 39	I90 RS 100 AE 39	I135 RS 100 AE 39	21.47	
12.5 - 1/2	RS 125 AE 39	48.37	E90 RS 125 AE 39	E135 RS 125 AE 39	I90 RS 125 AE 39	I135 RS 125 AE 39	21.47	
<b>A: 57 mm - 2-1/4"</b>								
8 - 5/16	RS 80 AE 57	47.22	E90 RS 80 AE 57	E135 RS 80 AE 57	I90 RS 80 AE 57	I135 RS 80 AE 57	21.47	
10 - 3/8	RS 100 AE 57	47.98	E90 RS 100 AE 57	E135 RS 100 AE 57	I90 RS 100 AE 57	I135 RS 100 AE 57	21.47	
12.5 - 1/2	RS 125 AE 57	50.20	E90 RS 125 AE 57	E135 RS 125 AE 57	I90 RS 125 AE 57	I135 RS 125 AE 57	21.47	

Length = 2.5 m - 8' 2-1/2"		Brushed chrome anod. alu. (ACGB)						
H = mm - in.	Profile	\$/ Length	Outside corner, 90°	Outside corner, 135°	Inside corner, 90°	Inside corner, 135°	\$/ Unit	
<b>A: 39 mm - 1-1/2"</b>								
8 - 5/16	RS 80 ACGB 39	60.26	E90 RS 80 ACGB 39	E135 RS 80 ACGB 39	I90 RS 80 ACGB 39	I135 RS 80 ACGB 39	24.24	
10 - 3/8	RS 100 ACGB 39	60.94	E90 RS 100 ACGB 39	E135 RS 100 ACGB 39	I90 RS 100 ACGB 39	I135 RS 100 ACGB 39	24.24	
12.5 - 1/2	RS 125 ACGB 39	63.03	E90 RS 125 ACGB 39	E135 RS 125 ACGB 39	I90 RS 125 ACGB 39	I135 RS 125 ACGB 39	24.24	
<b>A: 57 mm - 2-1/4"</b>								
8 - 5/16	RS 80 ACGB 57	61.38	E90 RS 80 ACGB 57	E135 RS 80 ACGB 57	I90 RS 80 ACGB 57	I135 RS 80 ACGB 57	24.24	
10 - 3/8	RS 100 ACGB 57	62.07	E90 RS 100 ACGB 57	E135 RS 100 ACGB 57	I90 RS 100 ACGB 57	I135 RS 100 ACGB 57	24.24	
12.5 - 1/2	RS 125 ACGB 57	64.14	E90 RS 125 ACGB 57	E135 RS 125 ACGB 57	I90 RS 125 ACGB 57	I135 RS 125 ACGB 57	24.24	

Length = 2.5 m - 8' 2-1/2"		Satin nickel anod. alu. (AT)						
H = mm - in.	Profile	\$/ Length	Outside corner, 90°	Outside corner, 135°	Inside corner, 90°	Inside corner, 135°	\$/ Unit	
<b>A: 39 mm - 1-1/2"</b>								
8 - 5/16	RS 80 AT 39	46.03	E90 RS 80 AT 39	E135 RS 80 AT 39	I90 RS 80 AT 39	I135 RS 80 AT 39	21.47	
10 - 3/8	RS 100 AT 39	46.78	E90 RS 100 AT 39	E135 RS 100 AT 39	I90 RS 100 AT 39	I135 RS 100 AT 39	21.47	
12.5 - 1/2	RS 125 AT 39	48.37	E90 RS 125 AT 39	E135 RS 125 AT 39	I90 RS 125 AT 39	I135 RS 125 AT 39	21.47	
<b>A: 57 mm - 2-1/4"</b>								
8 - 5/16	RS 80 AT 57	47.22	E90 RS 80 AT 57	E135 RS 80 AT 57	I90 RS 80 AT 57	I135 RS 80 AT 57	21.47	
10 - 3/8	RS 100 AT 57	47.98	E90 RS 100 AT 57	E135 RS 100 AT 57	I90 RS 100 AT 57	I135 RS 100 AT 57	21.47	
12.5 - 1/2	RS 125 AT 57	50.20	E90 RS 125 AT 57	E135 RS 125 AT 57	I90 RS 125 AT 57	I135 RS 125 AT 57	21.47	

Length = 2.5 m - 8' 2-1/2"		Brushed nickel anod. alu. (ATGB)						
H = mm - in.	Profile	\$/ Length	Outside corner, 90°	Outside corner, 135°	Inside corner, 90°	Inside corner, 135°	\$/ Unit	
<b>A: 39 mm - 1-1/2"</b>								
8 - 5/16	RS 80 ATGB 39	60.26	E90 RS 80 ATGB 39	E135 RS 80 ATGB 39	I90 RS 80 ATGB 39	I135 RS 80 ATGB 39	24.24	
10 - 3/8	RS 100 ATGB 39	60.94	E90 RS 100 ATGB 39	E135 RS 100 ATGB 39	I90 RS 100 ATGB 39	I135 RS 100 ATGB 39	24.24	
12.5 - 1/2	RS 125 ATGB 39	63.03	E90 RS 125 ATGB 39	E135 RS 125 ATGB 39	I90 RS 125 ATGB 39	I135 RS 125 ATGB 39	24.24	



**Schluter®-RONDEC-STEP**

Length = 2.5 m - 8' 2-1/2"							
Satin copper anod. alu. (AK)							
H = mm - in.	Profile	\$ / Length	Outside corner, 90°	Outside corner, 135°	Inside corner, 90°	Inside corner, 135°	\$ / Unit
<b>A: 39 mm - 1-1/2"</b>							
8 - 5/16	RS 80 AK 39	46.03	E90 RS 80 AK 39	E135 RS 80 AK 39	I90 RS 80 AK 39	I135 RS 80 AK 39	21.47
10 - 3/8	RS 100 AK 39	46.78	E90 RS 100 AK 39	E135 RS 100 AK 39	I90 RS 100 AK 39	I135 RS 100 AK 39	21.47
12.5 - 1/2	RS 125 AK 39	48.37	E90 RS 125 AK 39	E135 RS 125 AK 39	I90 RS 125 AK 39	I135 RS 125 AK 39	21.47
<b>A: 57 mm - 2-1/4"</b>							
8 - 5/16	RS 80 AK 57	47.22	E90 RS 80 AK 57	E135 RS 80 AK 57	I90 RS 80 AK 57	I135 RS 80 AK 57	21.47
10 - 3/8	RS 100 AK 57	47.98	E90 RS 100 AK 57	E135 RS 100 AK 57	I90 RS 100 AK 57	I135 RS 100 AK 57	21.47
12.5 - 1/2	RS 125 AK 57	50.20	E90 RS 125 AK 57	E135 RS 125 AK 57	I90 RS 125 AK 57	I135 RS 125 AK 57	21.47

Length = 2.5 m - 8' 2-1/2"							
Brushed copper anod. alu. (AKGB)							
H = mm - in.	Profile	\$ / Length	Outside corner, 90°	Outside corner, 135°	Inside corner, 90°	Inside corner, 135°	\$ / Unit
<b>A: 39 mm - 1-1/2"</b>							
8 - 5/16	RS 80 AKGB 39	60.26	E90 RS 80 AKGB 39	E135 RS 80 AKGB 39	I90 RS 80 AKGB 39	I135 RS 80 AKGB 39	24.24
10 - 3/8	RS 100 AKGB 39	60.94	E90 RS 100 AKGB 39	E135 RS 100 AKGB 39	I90 RS 100 AKGB 39	I135 RS 100 AKGB 39	24.24
12.5 - 1/2	RS 125 AKGB 39	63.03	E90 RS 125 AKGB 39	E135 RS 125 AKGB 39	I90 RS 125 AKGB 39	I135 RS 125 AKGB 39	24.24
<b>A: 57 mm - 2-1/4"</b>							
8 - 5/16	RS 80 AKGB 57	61.38	E90 RS 80 AKGB 57	E135 RS 80 AKGB 57	I90 RS 80 AKGB 57	I135 RS 80 AKGB 57	24.24
10 - 3/8	RS 100 AKGB 57	62.07	E90 RS 100 AKGB 57	E135 RS 100 AKGB 57	I90 RS 100 AKGB 57	I135 RS 100 AKGB 57	24.24
12.5 - 1/2	RS 125 AKGB 57	64.14	E90 RS 125 AKGB 57	E135 RS 125 AKGB 57	I90 RS 125 AKGB 57	I135 RS 125 AKGB 57	24.24

Length = 2.5 m - 8' 2-1/2"							
Satin brass anod. alu. (AM)							
H = mm - in.	Profile	\$ / Length	Outside corner, 90°	Outside corner, 135°	Inside corner, 90°	Inside corner, 135°	\$ / Unit
<b>A: 57 mm - 2-1/4"</b>							
8 - 5/16	RS 80 AM 57	47.22	E90 RS 80 AM 57	E135 RS 80 AM 57	I90 RS 80 AM 57	I135 RS 80 AM 57	21.47
10 - 3/8	RS 100 AM 57	47.98	E90 RS 100 AM 57	E135 RS 100 AM 57	I90 RS 100 AM 57	I135 RS 100 AM 57	21.47
12.5 - 1/2	RS 125 AM 57	50.20	E90 RS 125 AM 57	E135 RS 125 AM 57	I90 RS 125 AM 57	I135 RS 125 AM 57	21.47

Length = 2.5 m - 8' 2-1/2"							
Brushed brass anod. alu. (AMGB)							
H = mm - in.	Profile	\$ / Length	Outside corner, 90°	Outside corner, 135°	Inside corner, 90°	Inside corner, 135°	\$ / Unit
<b>A: 39 mm - 1-1/2"</b>							
8 - 5/16	RS 80 AMGB 39	60.26	E90 RS 80 AMGB 39	E135 RS 80 AMGB 39	I90 RS 80 AMGB 39	I135 RS 80 AMGB 39	24.24
10 - 3/8	RS 100 AMGB 39	60.94	E90 RS 100 AMGB 39	E135 RS 100 AMGB 39	I90 RS 100 AMGB 39	I135 RS 100 AMGB 39	24.24
12.5 - 1/2	RS 125 AMGB 39	63.03	E90 RS 125 AMGB 39	E135 RS 125 AMGB 39	I90 RS 125 AMGB 39	I135 RS 125 AMGB 39	24.24
<b>A: 57 mm - 2-1/4"</b>							
8 - 5/16	RS 80 AMGB 57	61.38	E90 RS 80 AMGB 57	E135 RS 80 AMGB 57	I90 RS 80 AMGB 57	I135 RS 80 AMGB 57	24.24
10 - 3/8	RS 100 AMGB 57	62.07	E90 RS 100 AMGB 57	E135 RS 100 AMGB 57	I90 RS 100 AMGB 57	I135 RS 100 AMGB 57	24.24
12.5 - 1/2	RS 125 AMGB 57	64.14	E90 RS 125 AMGB 57	E135 RS 125 AMGB 57	I90 RS 125 AMGB 57	I135 RS 125 AMGB 57	24.24

Length = 2.5 m - 8' 2-1/2"							
Brushed antique bronze anod. alu. (ABGB)							
H = mm - in.	Profile	\$ / Length	Outside corner, 90°	Outside corner, 135°	Inside corner, 90°	Inside corner, 135°	\$ / Unit
<b>A: 39 mm - 1-1/2"</b>							
8 - 5/16	RS 80 ABGB 39	60.26	E90 RS 80 ABGB 39	E135 RS 80 ABGB 39	I90 RS 80 ABGB 39	I135 RS 80 ABGB 39	24.24
10 - 3/8	RS 100 ABGB 39	60.94	E90 RS 100 ABGB 39	E135 RS 100 ABGB 39	I90 RS 100 ABGB 39	I135 RS 100 ABGB 39	24.24
12.5 - 1/2	RS 125 ABGB 39	63.03	E90 RS 125 ABGB 39	E135 RS 125 ABGB 39	I90 RS 125 ABGB 39	I135 RS 125 ABGB 39	24.24





### Schluter®-SCHIENE-STEP

**Schluter®-SCHIENE-STEP** is a finishing and edging profile for ceramic tile and natural stone installations on countertops, stairs, and tile over tile applications on walls. The top of the profile features a vertical wall section that finishes and protects the tile from damage, while the vertical leg covers the edge of the sub-assembly, top of the riser, or existing wall tile edge.

SCHIENE-STEP is available in anodized aluminum and brushed stainless steel versions, which have different shapes and intended uses. The stainless steel version is available in three vertical leg lengths: 1-1/2" (39 mm), 1-3/16" (30 mm), and 7/16" (11 mm). The anodized aluminum version is intended for residential stair applications (stairs not exposed to heavy traffic). It is available in two vertical leg lengths, 1-3/16" (30 mm) and 1-1/2" (39 mm). The ribbed vertical leg covers the sub-assembly or top of the riser. The integrated joint spacer establishes a defined joint cavity between the tile and the profile.

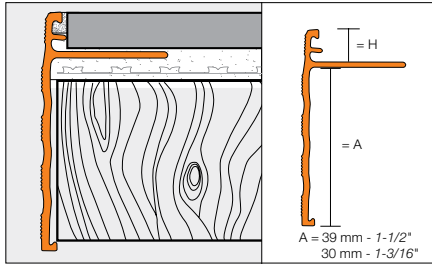
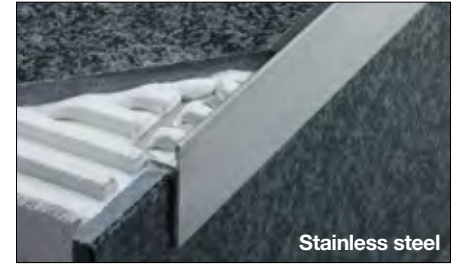
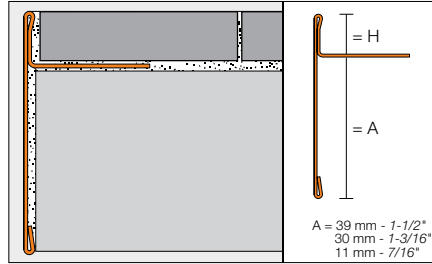

Schluter®-SCHIENE-STEP									
Length = 2.5 m - 8' 2-1/2"	Brushed Stainless Steel 304 (1.4301 = V2A) (EB)								
H = mm - in.	Profile	\$ / Length	Inside corner, 90°	Inside corner, 135°	Outside corner, 90° and End Cap	Outside corner, 135°	\$ / Unit		
<b>A: 39 mm - 1-1/2"</b>									
6 - 1/4	SS 60 EB 39	139.61	I90 / SS 60 EB 39	I135 / SS 60 EB 39	E90 / SS 60 EB 39	E135 / SS 60 EB 39	18.44		
9 - 11/32	SS 90 EB 39	145.40	I90 / SS 90 EB 39	I135 / SS 90 EB 39	E90 / SS 90 EB 39	E135 / SS 90 EB 39	18.44		
11 - 7/16	SS 110 EB 39	148.03	I90 / SS 110 EB 39	I135 / SS 110 EB 39	E90 / SS 110 EB 39	E135 / SS 110 EB 39	18.44		
12.5 - 1/2	SS 125 EB 39	150.36	I90 / SS 125 EB 39	I135 / SS 125 EB 39	E90 / SS 125 EB 39	E135 / SS 125 EB 39	18.44		
<b>A: 30 mm - 1-3/16"</b>									
9 - 11/32	SS 90 EB 30	109.94	-	-	E90 / SS 90 EB 30	-	18.44		
11 - 7/16	SS 110 EB 30	111.35	-	-	E90 / SS 110 EB 30	-	18.44		
12.5 - 1/2	SS 125 EB 30	112.76	-	-	E90 / SS 125 EB 30	-	18.44		
<b>A: 11 mm - 7/16"</b>									
6 - 1/4	SS 60 EB 11	105.77							
12.5 - 1/2	SS 125 EB 11	107.13							

Brushed Stainless Steel 304 (1.4301 = V2A) (EB)		
H = mm - in.	Connector	\$ / Unit
<b>A: 39 mm - 1-1/2"</b>		
6 - 1/4	V / SS 60 EB 39	15.68
9 - 11/32	V / SS 90 EB 39	15.68
11 - 7/16	V / SS 110 EB 39	15.68
12.5 - 1/2	V / SS 125 EB 39	15.68
<b>A: 30 mm - 1-3/16"</b>		
9 - 11/32	V / SS 90 EB 30	15.68
11 - 7/16	V / SS 110 EB 30	15.68
12.5 - 1/2	V / SS 125 EB 30	15.68
<b>A: 11 mm - 7/16"</b>		
6 - 1/4	V / SS 60 EB 11	15.68
12.5 - 1/2	V / SS 125 EB 11	15.68

Schluter®-SCHIENE-STEP				
Length = 2.5 m - 8' 2-1/2"	Satin anodized aluminum (AE)		Satin nickel anodized aluminum (AT)	
H = mm - in.	Profile	\$ / Length	Profile	\$ / Length
<b>A: 30 mm - 1-3/16"</b>				
8 - 5/16	SS 80 AE 30	38.32	SS 80 AT 30	42.28
10 - 3/8	SS 100 AE 30	38.93	SS 100 AT 30	42.72
12.5 - 1/2	SS 125 AE 30	39.64	SS 125 AT 30	43.43
15 - 9/16	SS 150 AE 30	40.24	SS 150 AT 30	44.03
<b>A: 39 mm - 1-1/2"</b>				
8 - 5/16	SS 80 AE 39	41.68	SS 80 AT 39	45.46
10 - 3/8	SS 100 AE 39	42.35	SS 100 AT 39	46.13
12.5 - 1/2	SS 125 AE 39	42.94	SS 125 AT 39	46.74
15 - 9/16	SS 150 AE 39	43.61	SS 150 AT 39	47.39

**Note:** The anchoring leg of Schluter®-SCHIENE-STEP is available with a special radius perforation so that the profile can be used to form curves.

- Available in stainless steel only
- Price surcharge: \$0.70 per foot
- Item No.: R / Profile No. (e.g., R/SS 60 EB 11)
- For delivery time, please call Customer Service





### Schluter®-TREP-FL

**Schluter®-TREP-FL** is a decorative stair-nosing profile with a protruding rounded edge that can be integrated into stairs covered with tile or stone. The profile protects the front edge of stairs and adds a high degree of safety by improving the visibility of the stair edges. The profile is available in stainless steel or anodized aluminum. TREP-FL is suitable for residential applications, e.g., stairs not exposed to heavy traffic.

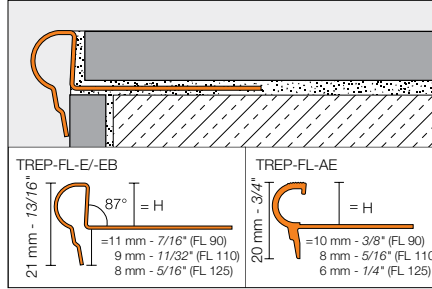

End cap (E)



Schluter®-TREP-FL		
Stainless steel 304 (1.4301 = V2A) (E)		
H = mm - in.	Item No.	\$ / Length
Length = 2.5 m - 8' 2-1/2"		
9 - 11/32	FL 90 E	64.97
11 - 7/16	FL 110 E	67.81
12.5 - 1/2	FL 125 E	70.83
Length = 1.50 m - 4' 11"		
9 - 11/32	FL 90 E/150	38.97
11 - 7/16	FL 110 E/150	40.68
12.5 - 1/2	FL 125 E/150	42.50
End cap		\$ / Unit
E/FLEB		4.63

Schluter®-TREP-FL		
Brushed stainless steel 304 (1.4301 = V2A) (EB)		
H = mm - in.	Item No.	\$ / Length
Length = 2.5 m - 8' 2-1/2"		
9 - 11/32	FL 90 EB	77.97
11 - 7/16	FL 110 EB	81.39
12.5 - 1/2	FL 125 EB	84.99
Length = 1.50 m - 4' 11"		
9 - 11/32	FL 90 EB/150	46.79
11 - 7/16	FL 110 EB/150	48.81
12.5 - 1/2	FL 125 EB/150	51.00
End cap		\$ / Unit
E/FLEB		4.63

Schluter®-TREP-FL		
Satin anodized aluminum (AE)		
H = mm - in.	Item No.	\$ / Length
Length = 2.5 m - 8' 2-1/2"		
9 - 11/32	FL 90 AE	29.72
11 - 7/16	FL 110 AE	30.34
12.5 - 1/2	FL 125 AE	30.95
Length = 1.50 m - 4' 11"		
9 - 11/32	FL 90 AE/150	21.05
11 - 7/16	FL 110 AE/150	21.43
12.5 - 1/2	FL 125 AE/150	23.03
End cap		\$ / Unit
E/FLAE		1.87



### Schluter®-TREP-E

**Schluter®-TREP-E** is designed to protect tiled stair edges and provide an easily visible, slip-resistant wear surface for durable, safe, and visually appealing stair-nosing design. The profile is made of stainless steel with an integrated slip-resistant tread, making it suitable for interior and exterior use in areas subjected to heavy foot-traffic, such as offices or public buildings. TREP-E features a trapezoid-perforated anchoring leg that is secured in the bond coat beneath the tile.

**Note:** Sizes 80, 110, and 160 are also available in stainless steel 316L (1.4404 = V4A). Contact Customer Service for pricing and availability.

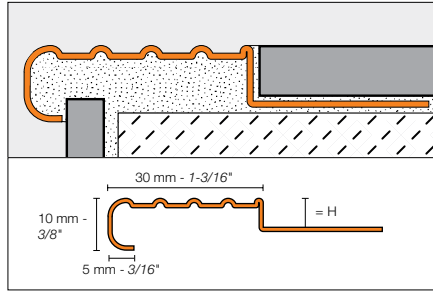

A version without the anchoring leg for retrofit applications is also available. Please refer to TREP-EK on page 69.

<b>Schluter®-TREP-E</b>		
<b>Stainless steel 304 (1.4301 = V2A) (E)</b>		
H = mm - in.	Item No.	\$ / Length
Length = 2.5 m - 8' 2-1/2"		
2 - 3/32	TE 20	47.89
5 - 3/16	TE 50	49.51
8 - 5/16	TE 80	50.99
11 - 7/16	TE 110	52.49
16 - 5/8	TE 160	55.01
25 - 1	TE 250	59.10
Length = 1.50 m - 4' 11"		
2 - 3/32	TE 20/150	29.96
5 - 3/16	TE 50/150	30.95
8 - 5/16	TE 80/150	31.88
11 - 7/16	TE 110/150	32.78
16 - 5/8	TE 160/150	34.41
25 - 1	TE 250/150	37.35
<b>End cap</b>		<b>\$ / Unit</b>
E/TE		3.04

End cap (E/)



Schluter®-TREP-E



### Schluter®-TREP-G

**Schluter®-TREP-G** is designed to protect tiled stair edges and provide an easily visible, slip-resistant wear surface for durable, safe, and visually appealing stair-nosing design. The profile is made of stainless steel, making it suitable for interior and exterior use in areas subjected to heavy foot-traffic, such as offices or public buildings. The surface features a self-adhesive, non-slip tread with an embedded mineral grain coating, which can be replaced in case of damage or wear. TREP-G features a trapezoid-perforated anchoring leg that is secured in the bond coat beneath the tile.

**Note:** Sizes 130 and 150 are not stocked. Please call Customer Service for delivery times.



A version without the anchoring leg for retrofit applications is also available. Please refer to TREP-GK on page 70.

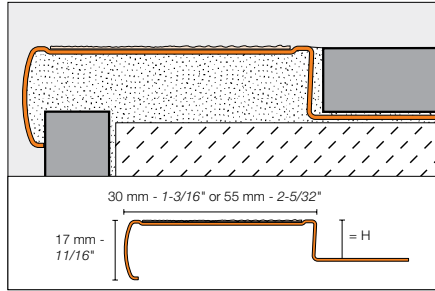

<b>Schluter®-TREP-G-S</b>			
Brushed stainless steel support with non-slip tread (30 mm - 1-3/16")			
H = mm - in.	Item No.	\$ / Length	
Length = 2.5 m - 8' 2-1/2"			
9 - 11/32	GS EB 90 + color*	134.79	
11 - 7/16	GS EB 110 + color*	136.25	
13 - 33/64	GS EB 130 + color*	137.68	
15 - 9/16	GS EB 150 + color*	140.04	
Length = 1.50 m - 4' 11"			
9 - 11/32	GS EB 90 + color*/150	85.38	
11 - 7/16	GS EB 110 + color*/150	86.31	
13 - 33/64	GS EB 130 + color*/150	87.20	
15 - 9/16	GS EB 150 + color*/150	88.53	
Replacement tread			
Length = 18.3 m - 60' 1/32"		\$ / Unit	
GS KB 183 + color*		148.56	
End cap		\$ / Unit	
E/GS EB		4.59	

<b>Schluter®-TREP-G-B</b>			
Brushed stainless steel support with non-slip tread (55 mm - 2-5/32")			
H = mm - in.	Item No.	\$ / Length	
Length = 2.5 m - 8' 2-1/2"			
9 - 11/32	GB EB 90 + color*	172.95	
11 - 7/16	GB EB 110 + color*	174.16	
13 - 33/64	GB EB 130 + color*	175.61	
15 - 9/16	GB EB 150 + color*	177.05	
Length = 1.50 m - 4' 11"			
9 - 11/32	GB EB 90 + color*/150	108.93	
11 - 7/16	GB EB 110 + color*/150	109.71	
13 - 33/64	GB EB 130 + color*/150	110.61	
15 - 9/16	GB EB 150 + color*/150	111.51	
Replacement tread			
Length = 18.3 m - 60' 1/32"		\$ / Unit	
GB KB 183 + color*		267.72	
End cap		\$ / Unit	
E/GB EB		4.59	

**\*Color Codes**



Transparent



Black

\* To complete the item number, add the **color** code (e.g., GS EB 90 **GS**).





**Schluter®-TREP-SE/-S/-B**

Schluter®-TREP-SE/-S/-B are designed to protect tiled stair edges and provide an easily visible, slip-resistant wear surface for durable, safe, and visually appealing stair-nosing design. They are suitable for use in areas subjected to heavy foot-traffic, such as offices or public buildings. The profiles feature a trapezoid-perforated anchoring leg made of stainless steel (-SE) or aluminum (-S and -B), with a slip-resistant, thermoplastic rubber wear surface. The tread surface is available in a variety of colors and can be replaced in case of damage or wear.

**Note:** Radius of leading edge for TREP-S and TREP-B: 8 mm - 5/16".

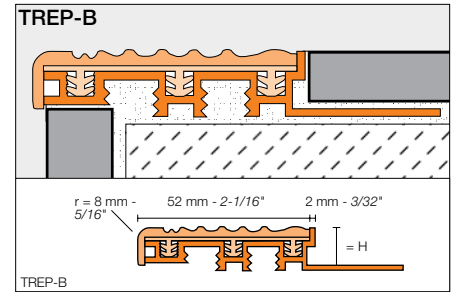
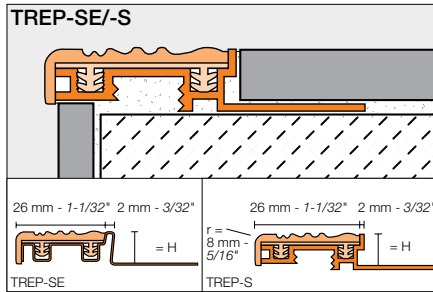
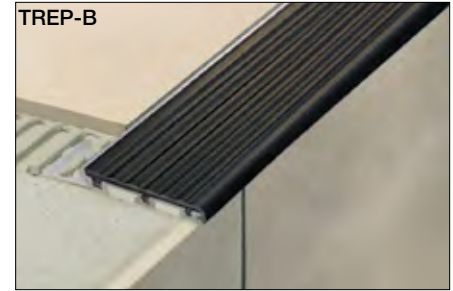

<b>Schluter®-TREP-SE</b>			
Stainless steel support with thermoplastic rubber insert (26 mm - 1-1/32")			
H = mm - in.	Item No.		\$/ Length
Length = 2.5 m - 8' 2-1/2"			
8 - 5/16	color* + 8 SE		76.43
10 - 3/8	color* + 10 SE		78.79
12.5 - 1/2	color* + 12 SE		82.03
Length = 1.50 m - 4' 11"			
8 - 5/16	color* + 8 SE/150		47.76
10 - 3/8	color* + 10 SE/150		49.25
12.5 - 1/2	color* + 12 SE/150		50.63
Stainless steel support section			
Length = 2.5 m - 8' 2-1/2"			
8 - 5/16	TES 8		58.37
10 - 3/8	TES 10		60.70
12.5 - 1/2	TES 12		63.97
Length = 1.50 m - 4' 11"			
8 - 5/16	TES 8/150		39.61
10 - 3/8	TES 10/150		40.06
12.5 - 1/2	TES 12/150		41.10
Replacement thermoplastic rubber insert			
Length = 2.5 m - 8' 2-1/2"			
	PE 26/+ color*		17.89
Length = 3 m - 9' 10"			
	PE 26/+ color*/300		22.37
End cap			\$/ Unit
	E 26/+ color*		1.69

<b>Schluter®-TREP-S</b>			
Aluminum support with thermoplastic rubber insert (26 mm - 1-1/32")			
H = mm - in.	Item No.		\$/ Length
Length = 2.5 m - 8' 2-1/2"			
8 - 5/16	color* + 8 S		51.07
10 - 3/8	color* + 10 S		53.04
12.5 - 1/2	color* + 12 S		56.37
Length = 1.50 m - 4' 11"			
8 - 5/16	color* + 8 S/150		32.57
10 - 3/8	color* + 10 S/150		33.16
12.5 - 1/2	color* + 12 S/150		35.21
Aluminum support section			
Length = 2.5 m - 8' 2-1/2"			
8 - 5/16	TAS 8		33.71
10 - 3/8	TAS 10		35.67
12.5 - 1/2	TAS 12		38.98
Length = 1.50 m - 4' 11"			
8 - 5/16	TAS 8/150		16.88
10 - 3/8	TAS 10/150		17.83
12.5 - 1/2	TAS 12/150		19.50
Replacement thermoplastic rubber insert			
Length = 2.5 m - 8' 2-1/2"			
	PEA 26/+ color*		17.89
Length = 3 m - 9' 10"			
	PEA 26/+ color*/300		22.37
Length = 15 m - 50'			
	PEA 26/+ color*/50		111.85
End cap			\$/ Unit
	E 26/+ color*		1.69

<b>Schluter®-TREP-B</b>			
Aluminum support with thermoplastic rubber insert (52 mm - 2-1/16")			
H = mm - in.	Item No.		\$/ Length
Length = 2.5 m - 8' 2-1/2"			
8 - 5/16	color* + 8 B		74.15
10 - 3/8	color* + 10 B		78.66
12.5 - 1/2	color* + 12 B		82.10
15 - 9/16	color* + 15 B		86.62
25 - 1	color* + 25 B		88.58
Length = 1.50 m - 4' 11"			
8 - 5/16	color* + 8 B/150		46.35
10 - 3/8	color* + 10 B/150		49.16
12.5 - 1/2	color* + 12 B/150		51.29
15 - 9/16	color* + 15 B/150		54.14
25 - 1	color* + 25 B/150		55.39
Aluminum support section			
Length = 2.5 m - 8' 2-1/2"			
8 - 5/16	TAB 8		46.04
10 - 3/8	TAB 10		50.56
12.5 - 1/2	TAB 12		53.98
15 - 9/16	TAB 15		58.52
25 - 1	TAB 25		60.48
Length = 1.50 m - 4' 11"			
8 - 5/16	TAB 8/150		23.01
10 - 3/8	TAB 10/150		25.27
12.5 - 1/2	TAB 12/150		27.00
15 - 9/16	TAB 15/150		29.25
25 - 1	TAB 25/150		30.23
Replacement thermoplastic rubber insert			
Length = 2.5 m - 8' 2-1/2"			
	PEA 52/+ color*		28.95
Length = 3 m - 9' 10"			
	PEA 52/+ color*/300		36.19
Length = 15 m - 50'			
	PEA 52/+ color*/50		181.02
End cap			\$/ Unit
	E 52/+ color*		2.09

**\*Color Codes**

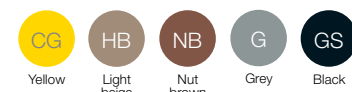

\* To complete the item number, add the color code (e.g., G 10 SE).

**End cap (E26/ or E52/)**

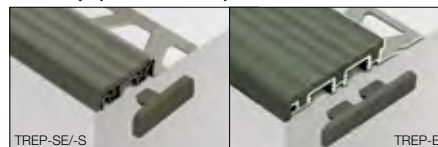



### Schluter®-TREP-TAP

**Schluter®-TREP-TAP** is an anodized aluminum cover profile that integrates with the Schluter®-TREP-S/-B stair-nosing profiles (page 67) to conceal the top of the riser. There are two options available: a 2-13/32" (61 mm) version featuring horizontal grooves, and a 2" (50 mm) version with a smooth surface finish.

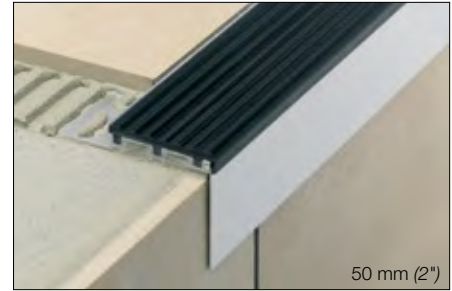
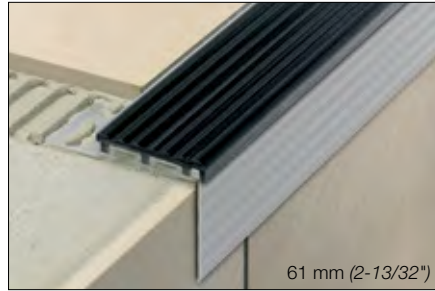

<b>Schluter®-TREP-TAP</b>	
Satin anodized aluminum (AE)	
Item No.	\$ / Length
<b>50 mm - 2" Smooth</b>	
Length = 2.5 m - 8' 2-1/2"	
TAP 50 AE	33.43
Length = 1.50 m - 4' 11"	
TAP 50 AE/150	21.05
Length = 1.00 m - 3' 3"	
TAP 50 AE/100	15.48
<b>61 mm - 2-13/32" Grooved</b>	
Length = 2.5 m - 8' 2-1/2"	
TAPR 61 AE	34.38
Length = 1.50 m - 4' 11"	
TAPR 61 AE/150	20.98

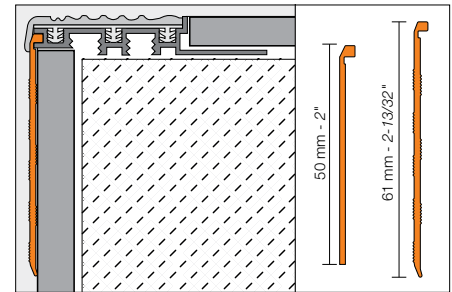

Schluter®-TREP-E (page 65)



# Safety can be retrofitted

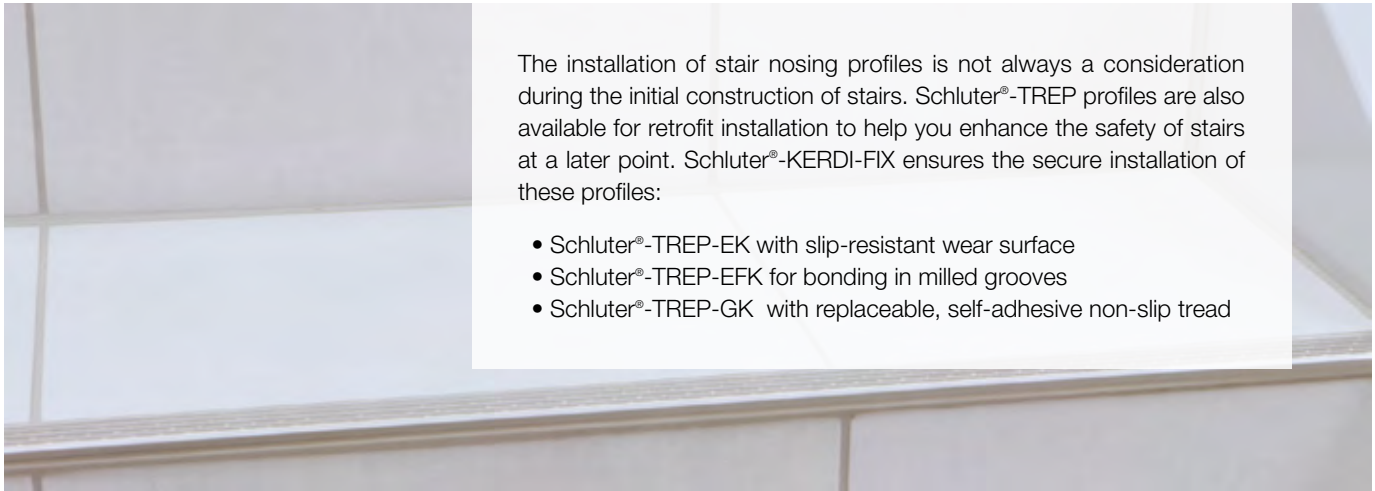

The installation of stair nosing profiles is not always a consideration during the initial construction of stairs. Schluter®-TREP profiles are also available for retrofit installation to help you enhance the safety of stairs at a later point. Schluter®-KERDI-FIX ensures the secure installation of these profiles:

- Schluter®-TREP-EK with slip-resistant wear surface
- Schluter®-TREP-EFK for bonding in milled grooves
- Schluter®-TREP-GK with replaceable, self-adhesive non-slip tread

## Schluter®-TREP-EK

**Schluter®-TREP-EK** is designed to protect tiled stair edges and provide an easily visible, slip-resistant wear surface for durable, safe, and visually appealing stair-nosing design. The profile is made of stainless steel with an integrated slip-resistant wear surface, making it suitable for interior and exterior use in areas subjected to heavy foot-traffic, such as offices or public buildings.

TREP-EK is subsequently bonded to existing installations. As such, TREP-EK can be installed as a repair so that existing, damaged stair treads do not have to be replaced.

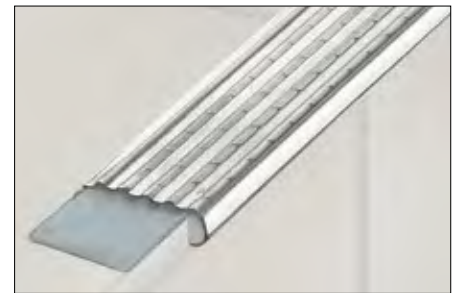
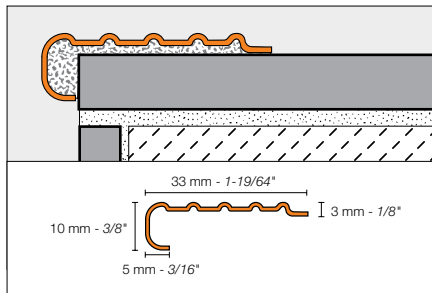

<b>Schluter®-TREP-EK</b>	
Stainless steel 304 (1.4301 = V2A) (E)	
Item No.	\$ / Length
Length = 2.5 m - 8' 2-1/2"	
TEK	52.48
Length = 1.50 m - 4' 11"	
TEK/150	31.48

## Schluter®-TREP-EFK

**Schluter®-TREP-EFK** is a retrofit stainless steel stair profile which is bonded to existing steps. The stair profile features an easily visible, slip-resistant wear surface for durable and safe stairs. The profile is suitable for interior and exterior use in areas subjected to heavy foot traffic, such as offices or public buildings.

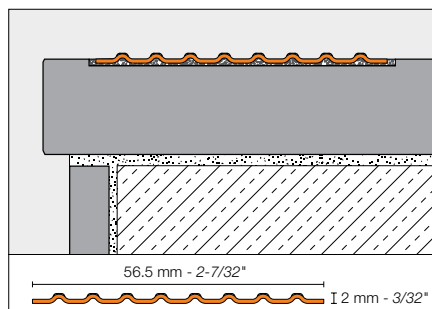

<b>Schluter®-TREP-EFK</b>	
Stainless steel 316L (1.4404 = V4A) (E)	
Item No.	\$ / Length
Length = 2.5 m - 8' 2-1/2"	
TEF56K/V4A	68.21



### Schluter®-TREP-GK

**Schluter®-TREP-GK** is designed to protect tiled stair edges and provide an easily visible, slip-resistant wear surface for durable, safe, and visually appealing stair-nosing design. The profile is made of stainless steel, making it suitable for interior and exterior use in areas subjected to heavy foot-traffic, such as offices or public buildings. The surface features a self-adhesive, non-slip tread with an embedded mineral grain coating, which can be replaced in case of damage or wear.

TREP-GK is subsequently bonded to existing installations. As such, TREP-GK can be installed as a repair so that existing, damaged stair treads do not have to be replaced.

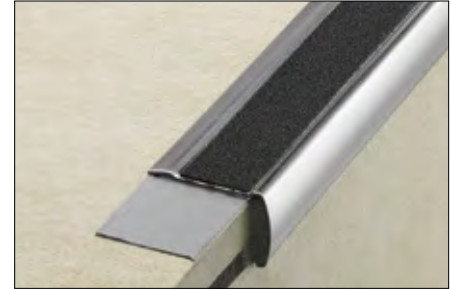
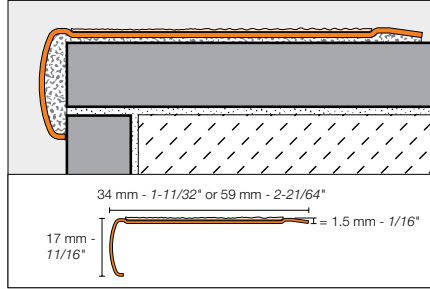

<b>Schluter®-TREP-GK-S</b>	
Brushed stainless steel support with non-slip tread (34 mm - 1-11/32")	
Item No.	\$ / Length
Length = 2.5 m - 8' 2-1/2"	
GS EBK + color*	114.00
Length = 1.50 m - 4' 11"	
GS EBK + color*/150	72.27
Replacement tread	
Length = 18.3 m - 60' 1/32"	
GS KB 183 + color*	148.56

<b>Schluter®-TREP-GK-B</b>	
Brushed stainless steel support with non-slip tread (59 mm - 2-21/64")	
Item No.	\$ / Length
Length = 2.5 m - 8' 2-1/2"	
GB EBK + color*	151.94
Length = 1.50 m - 4' 11"	
GB EBK + color*/150	95.68
Replacement tread	
Length = 18.3 m - 60' 1/32"	
GB KB 183 + color*	267.72

*Color Codes	
Transparent	Black
* To complete the item number, add the color code (e.g., GS EBK <b>GS</b> ).	





# Schluter® Profiles

## Movement joint & cove-shaped profiles

Movement joints are an integral part of any tile assembly and must be incorporated within the tile field at doorsills, and at transitions to walls and other restraining structures to allow movement of the assembly and prevent stresses that can damage the system. Schluter movement joint profiles protect tile edges and prevent sound bridges and surface water penetration, resulting in a permanent, maintenance-free installation.

Cove bases are a practical and hygienic method for treating floor-to-wall or wall-to-wall transitions, as they provide a curved surface that is easy to clean and prevent the accumulation of dirt. Schluter cove-shaped profiles provide an attractive, clean, and maintenance-free alternative for inside wall corners and floor/wall (including countertop/backsplash) transitions. Plus, they completely eliminate the need for caulk.



Schluter®-DILEX-KSN in stainless steel (page 75)

**Schluter®-DILEX-MOP**

**Schluter®-DILEX-MOP** is a screed joint profile with rigid PVC side sections that protect tile edges and a soft PVC movement zone that separates individual fields in the tile assembly and forms the visible surface. DILEX-MOP is designed to provide movement joints in tile installations that are set in a mortar bed (e.g., ceramic tile, natural stone, pavers, and agglomerate tile).

**Note:** Available only in grey.

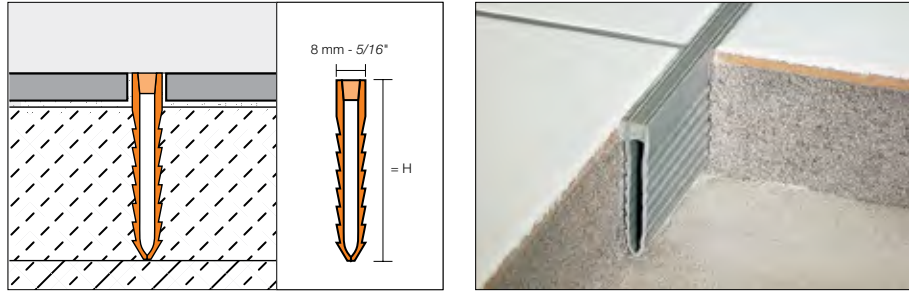

Schluter®-DILEX-MOP		
Length = 2.5 m - 8' 2-1/2"	Screed joint profile	
H = mm - in.	Item No.	\$ / Length
35 - 1-3/8	MOP 35 G	17.71
50 - 2	MOP 50 G	22.59
65 - 2-5/8	MOP 65 G	26.28



**WARNING:** Cancer [www.P65Warnings.ca.gov](http://www.P65Warnings.ca.gov)

**Schluter®-DILEX-MP/-MPV**

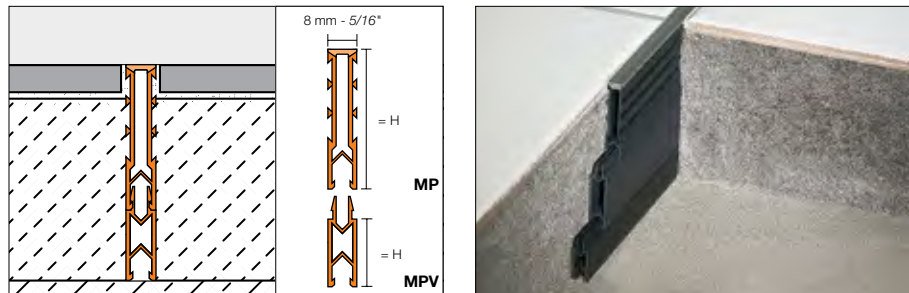
**Schluter®-DILEX-MP** is a screed joint profile with rigid PVC side sections that protect tile edges and a soft chlorinated polyethylene (CPE) movement zone that separates individual fields in the tile assembly and forms the visible surface. The movement zone is available in different colors to match the grout. DILEX-MP is designed to provide movement joints in tile installations that are set in a mortar bed (e.g., ceramic tile, natural stone, pavers, and agglomerate tile). DILEX-MP adjusts to the thickness of the mortar bed and tile surface by attaching the DILEX-MPV extensions.



**\*Color Codes**

			
HB Light beige	G Grey	ZR Brick red	GS Black

\* To complete the item number, add the **color** code (e.g., MP 35 **G**).

Schluter®-DILEX-MP		
Length = 2.5 m - 8' 2-1/2"	Screed joint profile	
H = mm - in.	Item No.	\$ / Length
35 - 1-3/8	MP 35 + <b>color</b> *	20.84

Schluter®-DILEX-MPV		
Length = 2.5 m - 8' 2-1/2"	Extension profile	
H = mm - in.	Item No.	\$ / Length
15 - 9/16	MPV 15	14.09
25 - 1	MPV 25	15.15



### Schluter®-DILEX-EZ 6 + 9

**Schluter®-DILEX-EZ 6** and **9** combine decorative design with stress-relieving function for tile and stone set in a thin bed of adhesive. The profile features two usable surfaces in different colors. The sidewalls are made of rigid PVC; the movement zones are made of soft PVC.

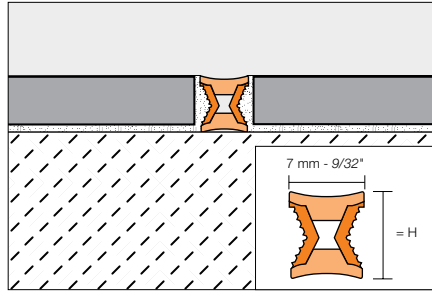

**\*Color Codes**

Grey	Yellow
M/G = Brass inlay / grey	
C/CG = Chrome inlay / yellow	

Schluter®-DILEX-EZ 6 + 9			
Length = 2.5 m - 8' 2-1/2"	Decorative movement joint		
H = mm - in.	Item No.		\$/ Length
6 - 1/4	EZ M/G 6		16.93
6 - 1/4	EZ C/CG 6		16.93
9 - 11/32	EZ M/G 9		20.15
9 - 11/32	EZ C/CG 9		20.15

**⚠ WARNING:** Cancer and Reproductive Harm - [www.P65Warnings.ca.gov](http://www.P65Warnings.ca.gov)

### Schluter®-DILEX-BWS

**Schluter®-DILEX-BWS** is a surface joint profile with rigid PVC anchoring legs that protect tile edges and a 3/16" (5 mm)-wide, soft CPE movement zone that separates individual fields in the tile covering and forms the visible surface. The movement zone is available in different colors to match the grout. The profile absorbs relatively limited movements and may be installed with greater frequency to create smaller fields, or the Schluter®-DILEX-BWB (3/8" - 10 mm movement zone) may be used. DILEX-BWS is suitable for residential to medium-duty commercial applications subject to light mechanical loads (e.g., offices and stores). The profile is also suited for exterior use.

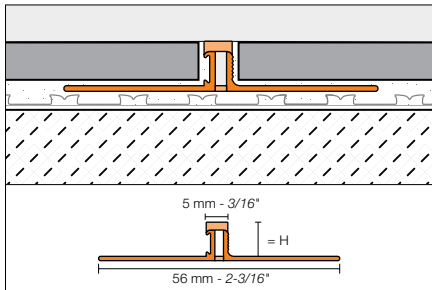

**\*Color Codes**

Bright white	Sand pebble	Light beige	Classic grey	Grey
Cream	Stone Grey	Grout Grey	Dark Anthracite	Black

\* To complete the item number, add the **color** code (e.g., BWS 80 **G**).

Schluter®-DILEX-BWS			
Length = 2.5 m - 8' 2-1/2"	PVC surface joint profile (5 mm - 3/16")		
H = mm - in.	Item No.		\$/ Length
4.5 - 3/16	BWS 45 + color*		18.54
6 - 1/4	BWS 60 + color*		18.54
8 - 5/16	BWS 80 + color*		18.54
9 - 11/32	BWS 90 + color*		19.48
10 - 3/8	BWS 100 + color*		19.48
11 - 7/16	BWS 110 + color*		19.48
12.5 - 1/2	BWS 125 + color*		19.48

### Schluter®-DILEX-BWB

**Schluter®-DILEX-BWB** is a surface joint profile with rigid PVC anchoring legs that protect tile edges and a 3/8" (10 mm)-wide, soft CPE movement zone that separates individual fields in the tile covering and forms the visible surface. The movement zone is available in different colors to match the grout. DILEX-BWB is suitable for residential to medium-duty commercial applications subject to light mechanical loads (e.g., offices and stores). The profile is also suited for exterior use.

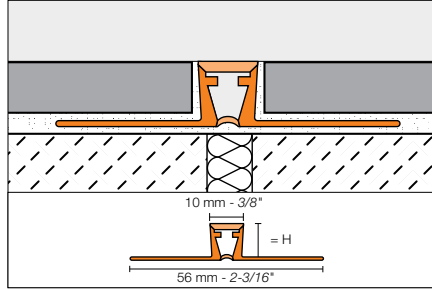

#### \*Color Codes



\* To complete the item number, add the **color** code (e.g., BWB 80 **G**).

\*\* BWB 60 is not available in sand pebble (SP).

#### Schluter®-DILEX-BWB

Length = 2.5 m - 8' 2-1/2"		PVC surface joint profile (10 mm - 3/8")	
H = mm - in.	Item No.	\$ / Length	
6 - 1/4	BWB 60 + color**	20.02	
8 - 5/16	BWB 80 + color*	20.54	
10 - 3/8	BWB 100 + color*	21.50	
12.5 - 1/2	BWB 125 + color*	21.50	
15 - 9/16	BWB 150 G (Grey only)	24.91	
20 - 3/4	BWB 200 G (Grey only)	26.66	

### Schluter®-DILEX-EDP

**Schluter®-DILEX-EDP** is a stainless steel surface joint profile that protects tile edges and separates individual fields in the tile covering. The profile accommodates horizontal movement via the 15/32" (12 mm)-wide stainless steel tongue-and-groove connection, which also forms the visible surface. DILEX-EDP is particularly suited for tile surfaces subject to heavy use, including areas exposed to continuous vehicular traffic. The profile is, therefore, suited for use in production facilities, warehouses, shopping centers, and underground parking garages, or for floor surfaces maintained with cleaning machines.

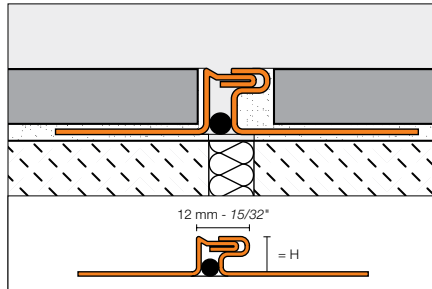

#### Schluter®-DILEX-EDP

Length = 2.5 m - 8' 2-1/2"		Stainless steel 304 (1.4301 = V2A) (E)	
H = mm - in.	Item No.	\$ / Length	
8 - 5/16	EDP 80	104.72	
9 - 11/32	EDP 90	106.21	
10 - 3/8	EDP 100	107.31	
11 - 7/16	EDP 110	108.28	
12.5 - 1/2	EDP 125	110.21	
14 - 17/32	EDP 140	111.71	
16 - 5/8	EDP 160	114.36	
18.5 - 23/32	EDP 185	117.09	
21 - 13/16	EDP 210	119.72	
25 - 1	EDP 250	124.65	
30 - 1-3/16	EDP 300	130.24	



### Schluter®-DILEX-KSN

**Schluter®-DILEX-KSN** is a surface joint profile with stainless steel or aluminum anchoring legs that protect tile edges and a 7/16" (11 mm)-wide, soft thermoplastic rubber movement zone that separates individual fields in the tile covering and forms the visible surface. The movement zone is available in different colors to match the grout and can be replaced if damaged. DILEX-KSN in stainless steel offers secure edge protection for surfaces exposed to heavy-duty commercial traffic (e.g., warehouses, production facilities, or shopping malls).

**Note:** DILEX-KSN is also available in stainless steel 316L (1.4404 = V4A). Contact Customer Service for price and availability.

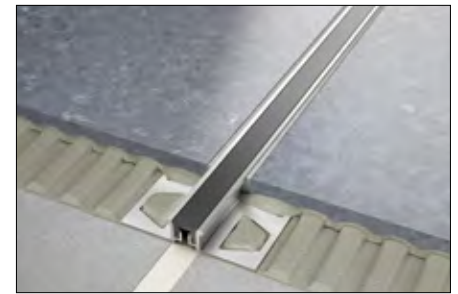
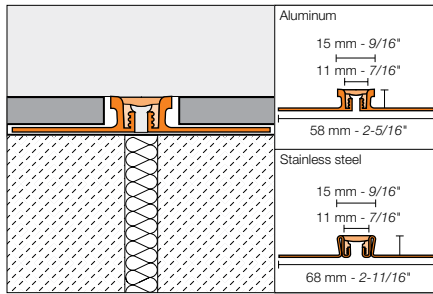

Schluter®-DILEX-KSN					
Length = 2.5 m - 8' 2-1/2"		Stainless steel 304 (1.4301 = V2A) (E)		Aluminum (A)	
H = mm - in.	Item No.	\$ / Length	Item No.	\$ / Length	
8 - 5/16	EKSN 80 + color*	95.87	AKSN 80 + color*	45.77	
10 - 3/8	EKSN 100 + color*	114.61	AKSN 100 + color*	47.76	
11 - 7/16	EKSN 110 + color*	117.47	AKSN 110 + color*	49.93	
12.5 - 1/2	EKSN 125 + color*	118.05	AKSN 125 + color*	49.75	
14 - 17/32	EKSN 140 + color*	120.09	AKSN 140 + color*	51.07	
16 - 5/8	EKSN 160 + color*	123.52	AKSN 160 + color*	53.04	
18.5 - 23/32	EKSN 185 + color*	126.26	-	-	
21 - 13/16	EKSN 210 + color*	129.70	AKSN 210 + color*	58.34	
25 - 1	EKSN 250 + color*	135.90	-	-	
30 - 1-3/16	EKSN 300 + color*	142.06	-	-	
<b>Rubber insert replacement</b>			KSE/ + color*		15.32

#### \*Color Codes



\* To complete the item number, add the **color** code (e.g., AKSN 125 **G**).

<sup>1</sup> The colors cream (C), stone grey (SG), grout grey (FG), and dark anthracite (DA) are only available in the following profile sizes:  
EKSN sizes 100, 110, 125, 140, and 160  
AKSN sizes 100, 110, and 125



Schluter®-DILEX-EDP (page 74)

**Schluter®-DILEX-EKSB**

**Schluter®-DILEX-EKSB** is a surface joint profile for thinner floor coverings (e.g., VCT flooring or coatings) with stainless steel anchoring legs and a 1/4" (6 mm)-wide, soft thermoplastic rubber movement zone that separates individual fields in the floor covering and forms the visible surface. The movement zone is available in different colors. DILEX-EKSB is suitable for residential to medium-duty commercial applications.

**Note:** DILEX-EKSB is also available in stainless steel 316L (1.4404 = V4A). Contact Customer Service for price and availability.

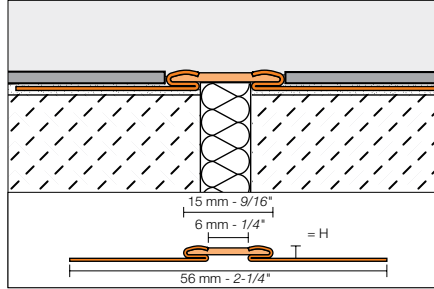

**\*Color Codes**



\* To complete the item number, add the **color** code (e.g., EKSB 60 **G**).

Schluter®-DILEX-EKSB		
Length = 2.5 m - 8' 2-1/2"	Stainless steel 304 (1.4301 = V2A) (E)	
H = mm - in.	Item No.	\$ / Length
2.5 - 3/32	EKSB 25 + <b>color*</b>	84.10
4.5 - 3/16	EKSB 45 + <b>color*</b>	88.94
6 - 1/4	EKSB 60 + <b>color*</b>	92.43

**Schluter®-DILEX-AKWS**

**Schluter®-DILEX-AKWS** is a surface joint profile with aluminum anchoring legs that protect tile edges and a 1/4" (6 mm)-wide, soft PVC movement zone that separates individual fields in the tile covering and forms the visible surface. The movement zone is available in different colors to match the grout. DILEX-AKWS is suitable for residential to medium-duty commercial applications, such as areas subject to moderate mechanical stresses, including light vehicular traffic.

An adhesive strip on the back of the profile ensures that the movement zone remains free of mortar during installation.

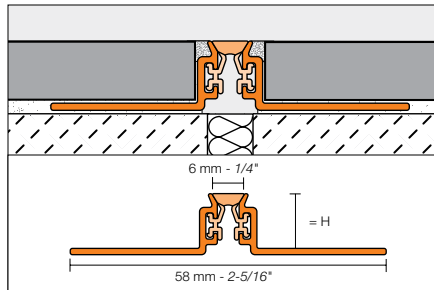

**\*Color codes**



\* To complete the item number, add the **color** code (e.g., AKWS 80 **G**).

Schluter®-DILEX-AKWS		
Length = 2.5 m - 8' 2-1/2"	Aluminum (A)	
H = mm - in.	Item No.	\$ / Length
8 - 5/16	AKWS 80 + <b>color*</b>	33.81
9 - 11/32	AKWS 90 + <b>color*</b>	35.79
10 - 3/8	AKWS 100 + <b>color*</b>	36.49
11 - 7/16	AKWS 110 + <b>color*</b>	37.12
12.5 - 1/2	AKWS 125 + <b>color*</b>	39.16
14 - 17/32	AKWS 140 + <b>color*</b>	42.44
16 - 5/8	AKWS 160 + <b>color*</b>	45.09
21 - 13/16	AKWS 210 + <b>color*</b>	49.06



### Schluter®-DILEX-BT

**Schluter®-DILEX-BT** is an expansion joint profile made of anodized aluminum that bridges expansion joints and accommodates movement via the 1-3/16" (30 mm)-wide telescopic center section, which also forms the visible surface. DILEX-BT protects tile edges and is suitable for tile surfaces exposed to foot traffic as well as vehicular traffic and is, therefore, suited for use in warehouses, production facilities, shopping centers, airports, train stations, and parking garages, or for coverings cleaned with machines.

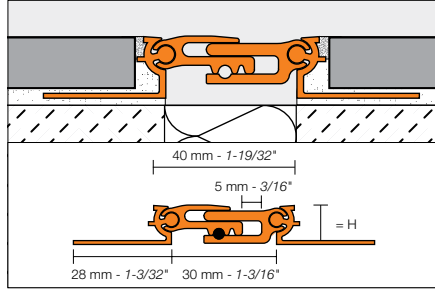

Schluter®-DILEX-BT		
Length = 2.5 m - 8' 2-1/2"	Satin anodized aluminum (AE)	
H = mm - in.	Item No.	\$/ Length
8 - 5/16	AEBT 80	154.21
10 - 3/8	AEBT 100	156.78
12.5 - 1/2	AEBT 125	159.74
15 - 9/16	AEBT 150	162.32
17.5 - 11/16	AEBT 175	165.58
20 - 3/4	AEBT 200	173.97

### Schluter®-DILEX-BTO

**Schluter®-DILEX-BTO** is an expansion joint profile made of anodized aluminum that bridges expansion joints at floor/wall transitions and accommodates movement via the 1-3/16" (30 mm)-wide telescopic center section, which also forms the visible surface. DILEX-BTO protects tile edges and is suitable for tile surfaces exposed to foot traffic as well as vehicular traffic and is, therefore, suited for use in warehouses, production facilities, shopping centers, airports, train stations, and parking garages, or for coverings cleaned with machines.

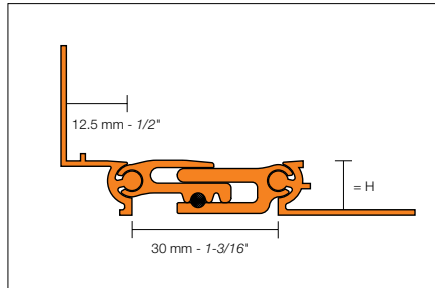

Schluter®-DILEX-BTO		
Length = 2.5 m - 8' 2-1/2"	Satin anodized aluminum (AE)	
H = mm - in.	Item No.	\$/ Length
8 - 5/16	AEBT 80/O 125	159.08
10 - 3/8	AEBT 100/O 125	160.30
12.5 - 1/2	AEBT 125/O 125	161.80
15 - 9/16	AEBT 150/O 125	163.14
17.5 - 11/16	AEBT 175/O 125	164.89
20 - 3/4	AEBT 200/O 125	168.95

**Schluter®-DILEX-BTS**

**Schluter®-DILEX-BTS** is an expansion joint profile made of anodized aluminum that bridges expansion joints and accommodates movement via the 1-3/16" (30 mm)-wide telescopic center section, which also forms the visible surface. The profile is installed in completed tile coverings. DILEX-BTS protects tile edges and is suitable for tile surfaces exposed to foot traffic as well as vehicular traffic and is, therefore, suited for use in warehouses, production facilities, shopping centers, airports, train stations, and parking garages, or for coverings cleaned with machines.

**Note:** DILEX-BTS can be inserted into existing joint spaces. The joints must be at least 1-3/4" (44 mm) wide and 3/8" (10 mm) deep.

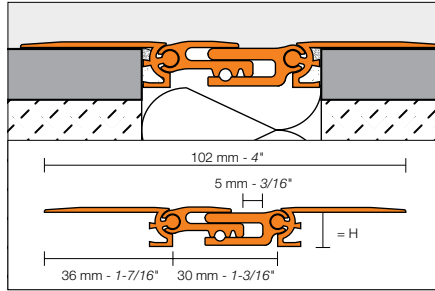

Schluter®-DILEX-BTS		
Length = 2.5 m - 8' 2-1/2"	Satin anodized aluminum (AE)	
H = mm - in.	Item No.	\$ / Length
10 - 3/8	AEBTS 100	159.74

**Schluter®-DILEX-AS**

**Schluter®-DILEX-AS** is a perimeter joint profile with a rigid PVC anchoring leg and a flexible joining leg with self-adhesive tape to bond the profile to fixed building elements (e.g., bathtubs, shower trays, door and window frames). DILEX-AS isolates the tile covering from the fixed building element and accommodates movement via the flexible joining leg, which also forms the visible surface. Suitable for tiles 3/16" to 3/8" (4 - 10 mm) thick.

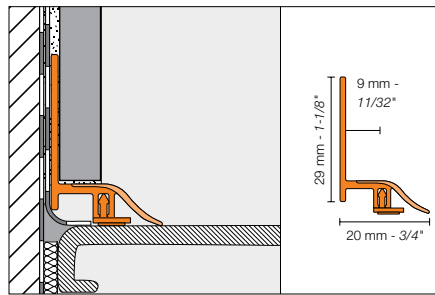

Schluter®-DILEX-AS								
Length = 2.5 m - 8' 2-1/2"	PVC perimeter joint profile Bright white (BW)							
H = mm - in.	Profile	\$ / Length	End cap (Right)	End cap (Left)	Inside corner	\$ / Unit	2 inside corners + 1 right end cap + 1 left end cap	\$ / Set
9 - 11/32	AS20BW	31.14	EKR/AS20BW	EKL/AS20BW	I/AS20BW	3.71	EKI/AS20BW	13.43





### Schluter®-DILEX-BWA

**Schluter®-DILEX-BWA** is a perimeter joint profile with a rigid PVC anchoring leg and a 3/16" (5 mm)-wide, soft CPE movement zone that isolates the tile covering from fixed building elements (e.g., bathtubs, shower trays, door and window frames) and forms the visible surface. The movement zone is available in different colors to match the grout. The profile also features a dovetailed channel made of rigid PVC that can be bonded to the fixed building elements.

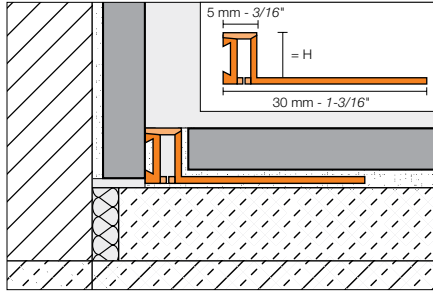

#### \*Color Codes



\* To complete the item number, add the **color** code (e.g., BWA 80 G).  
 \*\* BWA 45 is not available in Sand Pebble (SP)

#### Schluter®-DILEX-BWA

Length = 2.5 m - 8' 2-1/2"	PVC perimeter joint profile		
H = mm - in.	Item No.		\$/ Length
4.5 - 3/16	BWA 45 + color**		19.89
6 - 1/4	BWA 60 + color*		21.21
8 - 5/16	BWA 80 + color*		22.55
10 - 3/8	BWA 100 + color*		23.21
12.5 - 1/2	BWA 125 + color*		23.87

### Schluter®-DILEX-KSA

**Schluter®-DILEX-KSA** is a perimeter joint profile with a stainless steel or aluminum anchoring leg and a 3/8" (10 mm)-wide, soft thermoplastic rubber movement zone that isolates the tile covering from fixed building elements (e.g., window and door frames). The movement zone is available in different colors to match the grout and can be replaced if damaged. The profile also features a self-adhesive strip that allows it to bond to the fixed building elements.

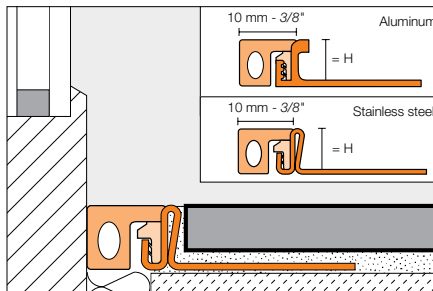

**Note:** DILEX-KSA is also available in stainless steel 316L (1.4404 = V4A). Contact Customer Service for price and availability.

#### Schluter®-DILEX-KSA

Length = 2.5 m - 8' 2-1/2"	Stainless steel 304 (1.4301 = V2A) (E)		Aluminum (A)	
H = mm - in.	Item No.	\$/ Length	Item No.	\$/ Length
8 - 5/16	EKSA 80 + color*	66.74	AKSA 80 + color*	37.16
10 - 3/8	EKSA 100 + color*	81.34	AKSA 100 + color*	38.17
11 - 7/16	EKSA 110 + color*	83.38	AKSA 110 + color*	39.11
12.5 - 1/2	EKSA 125 + color*	83.79	AKSA 125 + color*	39.44
14 - 17/32	EKSA 140 + color*	85.22	AKSA 140 + color*	41.21
16 - 5/8	EKSA 160 + color*	87.67	-	-
18.5 - 23/32	EKSA 185 + color*	89.62	-	-
21 - 13/16	EKSA 210 + color*	92.05	-	-
25 - 1	EKSA 250 + color*	96.46	-	-
30 - 1-3/16	EKSA 300 + color*	100.85	-	-
<b>Rubber insert replacement</b>			KSAE/+ color*	16.42

#### \*Color Codes



\* To complete the item number, add the **color** code (e.g., EKSA 80 G).

**Schluter®-DILEX-EKE**

**Schluter®-DILEX-EKE** is a corner movement joint profile with rigid PVC anchoring legs and a 3/16" (5 mm)-wide, soft CPE movement zone that separates individual tile fields at floor/wall transitions and inside wall corners and forms the visible surface. The movement zone is available in different colors to match the grout and forms a discreet, uniform joint. DILEX-EKE prevents surface water penetration and prevents sound bridges, making it ideal for floor/wall transitions in sound-rated floors.

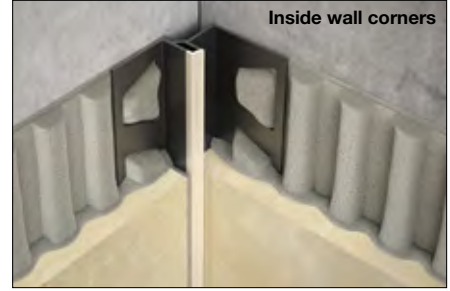
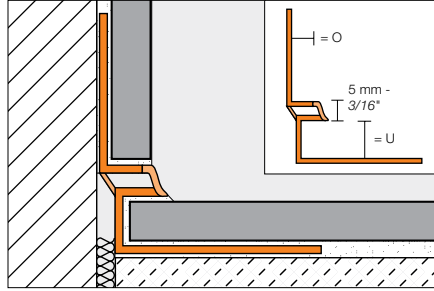

**\*Color Codes**



\* To complete the item number, add the **color** code (e.g., EKE U 8 / O 7 **BW**).

<b>Schluter®-DILEX-EKE</b>	
<b>Corner movement profile</b>	
Length = 2.5 m - 8' 2-1/2"	
<b>U = floor or wall, O = wall</b>	
EKE U 8/O 7 + <b>color*</b>	<b>\$ / Length</b>
EKE U 9/O 8 + <b>color*</b>	<b>18.98</b>
EKE U 11/O 10 + <b>color*</b>	<b>19.48</b>
EKE U 13/O 12 + <b>color*</b>	<b>19.62</b>
EKE U 15/O 14 + <b>color*</b>	<b>20.08</b>
EKE U 15/O 14 + <b>color*</b>	<b>20.70</b>

<b>U:</b> 8 mm = 5/16"	9 mm = 11/32"	11 mm = 7/16"	13 mm = 33/64"	15 mm = 9/16"
<b>O:</b> 7 mm = 9/32"	8 mm = 5/16"	10 mm = 3/8"	12 mm = 1/2"	14 mm = 17/32"

**Get perfect cuts!**

**Schluter®-SNIPS** for PVC profiles. See page 180 for more information.



Floor: Schluter®-DILEX-EKE in sand pebble  
Wall: Schluter®-QUADEC in cream (page 40)



### Schluter®-DILEX-HKW

**Schluter®-DILEX-HKW** is a PVC cove-shaped profile for inside wall corners and floor/wall transitions in applications where limited movement is expected. The profile provides an 11/16" (18 mm) radius to prevent the accumulation of dirt and makes cleaning simple. DILEX-HKW accommodates wall and floor tiles that are of the same thickness. DILEX-HKW prevents surface water penetration and meets the maintenance and hygienic requirements of commercial kitchens, bathrooms, food processing plants, or any tiled environment where a sanitary cove base is desired.

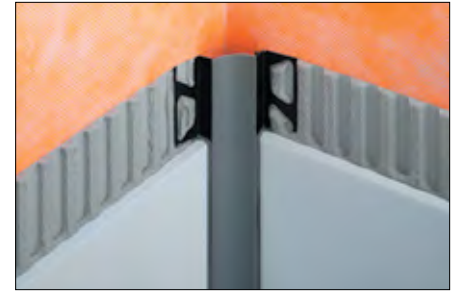
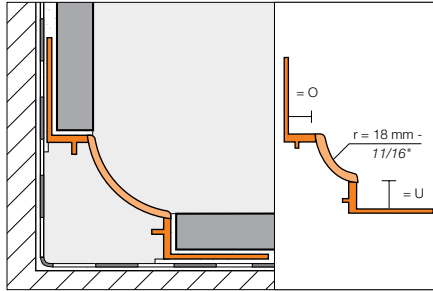

Outside corner (90°)



Inside corner, 2-way (90°)



Inside corner, 3-way (90°)



End cap



#### \*Color Codes



\* To complete the item number, add the **color** code (e.g., HKW U 9 / O 9 **HB**).

**U:** 7 mm = 9/32" 9 mm = 11/32" 11 mm = 7/16"  
**O:** 7 mm = 9/32" 9 mm = 11/32" 11 mm = 7/16"

### Schluter®-DILEX-HKW

Length = 2.5 m - 8' 2-1/2"  
 U = floor or wall, O = wall

#### Cove base profile

Profile	\$ / Length	Outside corner, 90°	Inside corner, 90° (2-way)	Inside corner, 90° (3-way)	End cap	\$ / Unit
HKW U 7/O 7 + <b>color</b> *	25.31					
HKW U 9/O 9 + <b>color</b> *	25.31	A/HKW/+ <b>color</b> *	I/HKW 2 R18/+ <b>color</b> *	I/HKW 3 R18/+ <b>color</b> *	E/HKW/G (Grey only)	4.77
HKW U 11/O 11 + <b>color</b> *	25.31					

**Schluter®-DILEX-HK**

**Schluter®-DILEX-HK** is a cove-shaped profile with rigid PVC anchoring legs and a soft CPE movement zone that separates individual tile fields at floor/wall transitions and forms the visible surface. The profile provides an 11/16" (18 mm) radius to prevent the accumulation of dirt and makes cleaning simple. DILEX-HK accommodates wall and floor tiles of dissimilar thicknesses and features a tile pocket that hides cut tile edges. DILEX-HKW (page 81) integrates with DILEX-HK where cove trim is required for inside wall corners. DILEX-HK prevents surface water penetration and meets the maintenance and hygienic requirements of commercial kitchens, bathrooms, food processing plants, or any tiled environment where a sanitary cove base is desired. DILEX-HK also prevents sound bridges, making it ideal for floor/wall transitions in sound-rated floors.

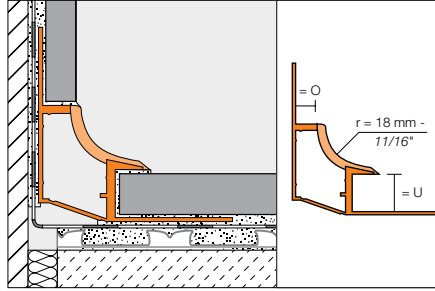

Outside corner (90°)



Connector



Inside corner, 2-way (90°)



End cap (right or left)

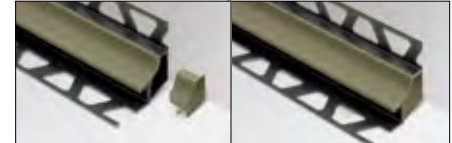

Inside corner, 3-way (90°)



**Note:** 3-way corners are to be used with DILEX-HKW (page 81) on the vertical.

**\*Color Codes**



\* To complete the item number, add the **color** code (e.g., HK U 12 / O 9 **BW**).

**U:** 12 mm = 1/2"  
**O:** 9 mm = 11/32"

**Schluter®-DILEX-HK**

Length = 2.5 m - 8' 2-1/2"		Cove base profile			
U = floor or wall, O = wall					
Profile	\$ / Length	Outside corner, 90°	Inside corner, 90° (2-way)	Inside corner, 90° (3-way)	\$ / Unit
HK U 12/O 9 + <b>color*</b>	36.35	A/HK/+ <b>color*</b>	I/HK 2 R18/+ <b>color*</b>	I/HK 3 R18/+ <b>color*</b>	4.77
<b>Connector</b>		V/HK			2.02
<b>End cap (Left)</b>		EL/HK/G (Grey only)			4.77
<b>End cap (Right)</b>		ER/HK/G (Grey only)			4.77



Schluter®-DILEX-AHK in dark anthracite (page 85)



### Schluter®-DILEX-AHK

**Schluter®-DILEX-AHK** is a cove-shaped profile with a single trapezoid-perforated anchoring leg for inside wall corners, countertop/backsplash transitions and floor/wall transitions in applications where limited movement is expected. DILEX-AHK provides a 3/8" (10 mm) radius to prevent accumulation of dirt and makes cleaning simple. DILEX-AHK is available in anodized aluminum and textured color-coated aluminum. DILEX-AHK prevents surface water penetration and meets the maintenance and hygienic requirements of commercial kitchens, bathrooms, food processing plants, or any tiled environment where a sanitary cove base is desired.

**Note:** 90° outside corners are available in 2 configurations. The "round" corner (E90) features a rounded front that integrates with RONDEC, while the "square" corner (E90Q) features a square shaped front that integrates with QUADDEC.

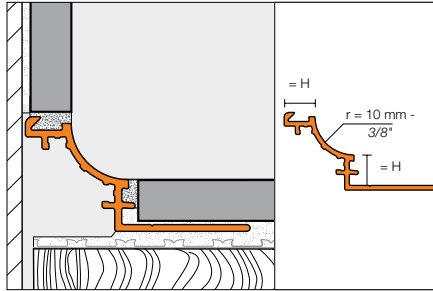

Outside corner, round (90° or 135°)

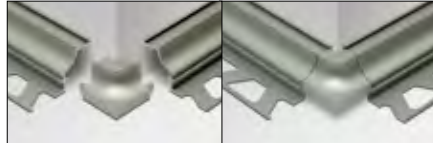

Inside corner (90° or 135°)

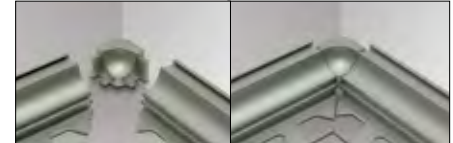

90° inside corners can be used 2-way or 3-way.

Outside corner, square (90°)

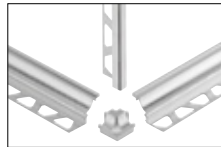

Connector



End cap

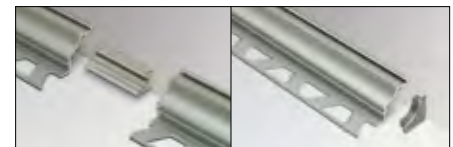

Schluter®-DILEX-AHK							
Length = 2.5 m - 8' 2-1/2"		Satin anodized aluminum (AE)					
H = mm - in.	Profile	\$/ Length	Outside corner, 90°	Outside corner, 135°	Inside corner, 90°	Inside corner, 135°	\$/ Unit
8 - 5/16	AHK 1S 80 AE	30.48	E 90/AHK 1S/AE	E 135/AHK 1S/AE	I 90/AHK 1S/AE	I 135/AHK 1S/AE	26.72
10 - 3/8	AHK 1S 100 AE	31.73					
12.5 - 1/2	AHK 1S 125 AE	33.18					
Outside corner square, 90°	E90 Q/AHK 1S/AE						25.90
Connector	V/AHK						4.52
End cap	E/AHK 1S/AE						16.02

Length = 2.5 m - 8' 2-1/2"		Polished chrome anod. alu. (ACG)					
H = mm - in.	Profile	\$/ Length	Outside corner, 90°	Outside corner, 135°	Inside corner, 90°	Inside corner, 135°	\$/ Unit
8 - 5/16	AHK 1S 80 ACG	52.80	E 90/AHK 1S/ACG	E 135/AHK 1S/ACG	I 90/AHK 1S/ACG	I 135/AHK 1S/ACG	30.78
10 - 3/8	AHK 1S 100 ACG	53.90					
12.5 - 1/2	AHK 1S 125 ACG	55.11					
Outside corner square, 90°	E90 Q/AHK 1S/ACG						30.22
Connector	V/AHK						4.52
End cap	E/AHK 1S/ACG						20.07

Length = 2.5 m - 8' 2-1/2"		Brushed chrome anod. alu. (ACGB)					
H = mm - in.	Profile	\$/ Length	Outside corner, 90°	Outside corner, 135°	Inside corner, 90°	Inside corner, 135°	\$/ Unit
8 - 5/16	AHK 1S 80 ACGB	47.24	E 90/AHK 1S/ACGB	E 135/AHK 1S/ACGB	I 90/AHK 1S/ACGB	I 135/AHK 1S/ACGB	30.78
10 - 3/8	AHK 1S 100 ACGB	48.55					
12.5 - 1/2	AHK 1S 125 ACGB	50.00					
Connector	V/AHK						4.52
End cap	E/AHK 1S/ACGB						20.07

Schluter®-DILEX-AHK							
Length = 2.5 m - 8' 2-1/2"	Satin nickel anod. alu. (AT)						
H = mm - in.	Profile	\$ / Length	Outside corner, 90°	Outside corner, 135°	Inside corner, 90°	Inside corner, 135°	\$ / Unit
8 - 5/16	AHK 1S 80 AT	35.25	E 90/AHK 1S/AT	E 135/AHK 1S/AT	I 90/AHK 1S/AT	I 135/AHK 1S/AT	26.72
10 - 3/8	AHK 1S 100 AT	36.55					
12.5 - 1/2	AHK 1S 125 AT	38.02					
15 - 9/16	AHK 1S 150 AT	39.47					
<b>Outside corner square, 90°</b>	E90 Q/AHK 1S/AT						25.90
<b>Connector</b>	V/AHK						4.52
<b>End cap</b>	E/AHK 1S/AT						16.02

Length = 2.5 m - 8' 2-1/2"	Polished nickel anod. alu. (ATG)						
H = mm - in.	Profile	\$ / Length	Outside corner, 90°	Outside corner, 135°	Inside corner, 90°	Inside corner, 135°	\$ / Unit
8 - 5/16	AHK 1S 80 ATG	55.80	E 90/AHK 1S/ATG	E 135/AHK 1S/ATG	I 90/AHK 1S/ATG	I 135/AHK 1S/ATG	30.78
10 - 3/8	AHK 1S 100 ATG	56.91					
12.5 - 1/2	AHK 1S 125 ATG	58.11					
<b>Connector</b>	V/AHK						
<b>End cap</b>	E/AHK 1S/ATG						20.07

Length = 2.5 m - 8' 2-1/2"	Brushed nickel anod. alu. (ATGB)						
H = mm - in.	Profile	\$ / Length	Outside corner, 90°	Outside corner, 135°	Inside corner, 90°	Inside corner, 135°	\$ / Unit
8 - 5/16	AHK 1S 80 ATGB	50.80	E 90/AHK 1S/ATGB	E 135/AHK 1S/ATGB	I 90/AHK 1S/ATGB	I 135/AHK 1S/ATGB	30.78
10 - 3/8	AHK 1S 100 ATGB	52.10					
12.5 - 1/2	AHK 1S 125 ATGB	53.55					
<b>Connector</b>	V/AHK						
<b>End cap</b>	E/AHK 1S/ATGB						20.07

Length = 2.5 m - 8' 2-1/2"	Satin copper anod. alu. (AK)						
H = mm - in.	Profile	\$ / Length	Outside corner, 90°	Outside corner, 135°	Inside corner, 90°	Inside corner, 135°	\$ / Unit
8 - 5/16	AHK 1S 80 AK	35.25	E 90/AHK 1S/AK	E 135/AHK 1S/AK	I 90/AHK 1S/AK	I 135/AHK 1S/AK	26.72
10 - 3/8	AHK 1S 100 AK	36.55					
12.5 - 1/2	AHK 1S 125 AK	38.02					
<b>Connector</b>	V/AHK						
<b>End cap</b>	E/AHK 1S/AK						16.02

Length = 2.5 m - 8' 2-1/2"	Polished copper anod. alu. (AKG)						
H = mm - in.	Profile	\$ / Length	Outside corner, 90°	Outside corner, 135°	Inside corner, 90°	Inside corner, 135°	\$ / Unit
8 - 5/16	AHK 1S 80 AKG	55.80	E 90/AHK 1S/AKG	E 135/AHK 1S/AKG	I 90/AHK 1S/AKG	I 135/AHK 1S/AKG	30.78
10 - 3/8	AHK 1S 100 AKG	56.91					
12.5 - 1/2	AHK 1S 125 AKG	58.11					
<b>Connector</b>	V/AHK						
<b>End cap</b>	E/AHK 1S/AKG						20.07

Length = 2.5 m - 8' 2-1/2"	Brushed copper anod. alu. (AKGB)						
H = mm - in.	Profile	\$ / Length	Outside corner, 90°	Outside corner, 135°	Inside corner, 90°	Inside corner, 135°	\$ / Unit
8 - 5/16	AHK 1S 80 AKGB	50.80	E 90/AHK 1S/AKGB	E 135/AHK 1S/AKGB	I 90/AHK 1S/AKGB	I 135/AHK 1S/AKGB	30.78
10 - 3/8	AHK 1S 100 AKGB	52.10					
12.5 - 1/2	AHK 1S 125 AKGB	53.55					
<b>Connector</b>	V/AHK						
<b>End cap</b>	E/AHK 1S/AKGB						20.07



Schluter®-DILEX-AHK							
Length = 2.5 m - 8' 2-1/2"	Satin brass anod. alu. (AM)						
H = mm - in.	Profile	\$/ Length	Outside corner, 90°	Outside corner, 135°	Inside corner, 90°	Inside corner, 135°	\$/ Unit
8 - 5/16	AHK 1S 80 AM	35.25	E 90/AHK 1S/AM	E 135/AHK 1S/AM	I 90/AHK 1S/AM	I 135/AHK 1S/AM	26.72
10 - 3/8	AHK 1S 100 AM	36.55					
12.5 - 1/2	AHK 1S 125 AM	38.02					
<b>Connector</b>	V/AHK						4.52
<b>End cap</b>	E/AHK 1S/AM						16.02

Schluter®-DILEX-AHK							
Length = 2.5 m - 8' 2-1/2"	Polished brass anod. alu. (AMG)						
H = mm - in.	Profile	\$/ Length	Outside corner, 90°	Outside corner, 135°	Inside corner, 90°	Inside corner, 135°	\$/ Unit
8 - 5/16	AHK 1S 80 AMG	54.38	E 90/AHK 1S/AMG	E 135/AHK 1S/AMG	I 90/AHK 1S/AMG	I 135/AHK 1S/AMG	30.78
10 - 3/8	AHK 1S 100 AMG	55.43					
12.5 - 1/2	AHK 1S 125 AMG	56.67					
<b>Connector</b>	V/AHK						4.52
<b>End cap</b>	E/AHK 1S/AMG						20.07

Schluter®-DILEX-AHK							
Length = 2.5 m - 8' 2-1/2"	Brushed brass anod. alu. (AMGB)						
H = mm - in.	Profile	\$/ Length	Outside corner, 90°	Outside corner, 135°	Inside corner, 90°	Inside corner, 135°	\$/ Unit
8 - 5/16	AHK 1S 80 AMGB	49.09	E 90/AHK 1S/AMGB	E 135/AHK 1S/AMGB	I 90/AHK 1S/AMGB	I 135/AHK 1S/AMGB	30.78
10 - 3/8	AHK 1S 100 AMGB	50.37					
12.5 - 1/2	AHK 1S 125 AMGB	51.82					
<b>Connector</b>	V/AHK						4.52
<b>End cap</b>	E/AHK 1S/AMGB						20.07

Schluter®-DILEX-AHK							
Length = 2.5 m - 8' 2-1/2"	Brushed graphite anod. alu. (AGRB)						
H = mm - in.	Profile	\$/ Length	Outside corner, 90°	Outside corner, 135°	Inside corner, 90°	Inside corner, 135°	\$/ Unit
8 - 5/16	AHK 1S 80 AGRB	50.80	E 90/AHK 1S/AGRB	E 135/AHK 1S/AGRB	I 90/AHK 1S/AGRB	I 135/AHK 1S/AGRB	30.78
10 - 3/8	AHK 1S 100 AGRB	52.10					
12.5 - 1/2	AHK 1S 125 AGRB	53.55					
15 - 9/16	AHK 1S 150 AGRB	55.17					
<b>Connector</b>	V/AHK						4.52
<b>End cap</b>	E/AHK 1S/AGRB						20.07

Schluter®-TRENDLINE Textured Color-coated Aluminum

Schluter®-TRENDLINE Textured Color-coated Aluminum							
Length = 2.5 m - 8' 2-1/2"	Textured color-coated aluminum (TS)						
H = mm - in.	Profile	\$/ Length	Outside corner, 90°	Outside corner, 135°	Inside corner, 90°	Inside corner, 135°	\$/ Unit
8 - 5/16	AHK 1S 80 + color*	53.29	E 90/AHK 1S/ + color*	E 135/AHK 1S/ + color*	I 90/AHK 1S/ + color*	I 135/AHK 1S/ + color*	32.29
10 - 3/8	AHK 1S 100 + color*	54.06					
12.5 - 1/2	AHK 1S 125 + color*	55.20					
15 - 9/16	AHK 1S 150 + color*	56.30					
<b>Outside corner square, 90°</b>	E90 Q/AHK 1S/+ color*						29.99
<b>Connector</b>	V/AHK						4.52
<b>End cap</b>	E/AHK 1S/+ color*						21.37

\*Color Codes



\* To complete the item number, add the color code (e.g., AHK 1S 80 TSB).

**Schluter®-DILEX-AHKA**

**Schluter®-DILEX-AHKA** is a cove-shaped profile for transitions between walls to be tiled and previously finished floors. DILEX-AHKA is available in anodized aluminum and textured color-coated aluminum. The profile features a single-trapezoid perforated anchoring leg that is secured in the mortar bond coat and a dovetailed channel, which can be bonded to floor surfaces using Schluter®-KERDI-FIX, epoxy resin, silicone, thin-set mortar, etc. A 3/8" (10 mm) radius cove section forms the visible surface and prevents the accumulation of dirt, making cleaning simple. DILEX-AHKA prevents surface water penetration and meets the maintenance and hygienic requirements of commercial kitchens, bathrooms, food processing plants, or any tiled environment where a sanitary cove base is desired. DILEX-AHKA integrates with the Schluter®-DILEX-AHK and Schluter®-RONDEC profiles at 90° inside and outside vertical wall corners, respectively.

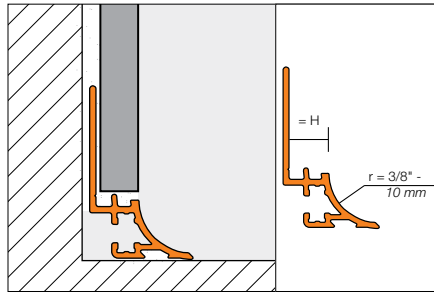

Outside corner (90° or 135°)

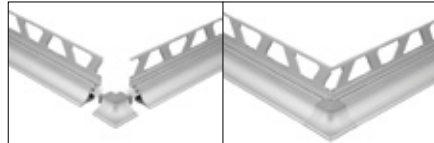

Inside corner (90° or 135°)

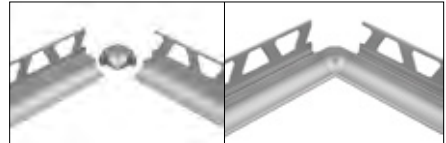

End cap



90° inside corners can be used 2-way, or 3-way when combined with DILEX-AHK on the vertical inside corner.

Schluter®-DILEX-AHKA							
Length = 2.5 m - 8' 2-1/2"	Satin anodized aluminum (AE)						
H = mm - in.	Profile	\$ / Length	Outside corner, 90°	Outside corner, 135°	Inside corner, 90°	Inside corner, 135°	\$ / Unit
8 - 5/16	AHKA 80 AE	30.48	E 90/AHKA/AE	E 135/AHKA/AE	I 90/AHKA/AE	I 135/AHKA/AE	26.72
10 - 3/8	AHKA 100 AE	31.73					
12.5 - 1/2	AHKA 125 AE	33.18					
15 - 9/16	AHKA 150 AE	34.17					
End cap (left)	EL/AHKA/AE						16.02
End cap (right)	ER/AHKA/AE						16.02
Length = 2.5 m - 8' 2-1/2"	Brushed chrome anod. alu. (ACGB)						
H = mm - in.	Profile	\$ / Length	Outside corner, 90°	Outside corner, 135°	Inside corner, 90°	Inside corner, 135°	\$ / Unit
8 - 5/16	AHKA 80 ACGB	47.24	E 90/AHKA/ACGB	E 135/AHKA/ACGB	I 90/AHKA/ACGB	I 135/AHKA/ACGB	30.78
10 - 3/8	AHKA 100 ACGB	48.55					
12.5 - 1/2	AHKA 125 ACGB	50.00					
15 - 9/16	AHKA 150 ACGB	51.51					
End cap (left)	EL/AHKA/ACGB						20.07
End cap (right)	ER/AHKA/ACGB						20.07
Length = 2.5 m - 8' 2-1/2"	Satin nickel anod. alu. (AT)						
H = mm - in.	Profile	\$ / Length	Outside corner, 90°	Outside corner, 135°	Inside corner, 90°	Inside corner, 135°	\$ / Unit
8 - 5/16	AHKA 80 AT	35.25	E 90/AHKA/AT	E 135/AHKA/AT	I 90/AHKA/AT	I 135/AHKA/AT	26.72
10 - 3/8	AHKA 100 AT	36.55					
12.5 - 1/2	AHKA 125 AT	38.02					
15 - 9/16	AHKA 150 AT	39.47					
End cap (left)	EL/AHKA/AT						16.02
End cap (right)	ER/AHKA/AT						16.02





Schluter®-DILEX-AHKA							
Length = 2.5 m - 8' 2-1/2"	Brushed nickel anod. alu. (ATGB)						
H = mm - in.	Profile	\$/ Length	Outside corner, 90°	Outside corner, 135°	Inside corner, 90°	Inside corner, 135°	\$/ Unit
8 - 5/16	AHKA 80 ATGB	50.80	E 90/AHKA/ATGB	E 135/AHKA/ATGB	I 90/AHKA/ATGB	I 135/AHKA/ATGB	30.78
10 - 3/8	AHKA 100 ATGB	52.10					
12.5 - 1/2	AHKA 125 ATGB	53.55					
15 - 9/16	AHKA 150 ATGB	55.17					
<b>End cap (left)</b>	EL/AHKA/ATGB						20.07
<b>End cap (right)</b>	ER/AHKA/ATGB						20.07

Schluter®-TRENDLINE Textured Color-coated Aluminum

Schluter®-TRENDLINE Textured Color-coated Aluminum							
Length = 2.5 m - 8' 2-1/2"	Textured color-coated aluminum (TS)						
H = mm - in.	Profile	\$/ Length	Outside corner, 90°	Outside corner, 135°	Inside corner, 90°	Inside corner, 135°	\$/ Unit
8 - 5/16	AHKA 80 + color*	53.29	E 90/AHKA/ + color*	E 135/AHKA/ + color*	I 90/AHKA/ + color*	I 135/AHKA/ + color*	32.29
10 - 3/8	AHKA 100 + color*	54.06					
12.5 - 1/2	AHKA 125 + color*	55.20					
15 - 9/16	AHKA 150 + color*	56.30					
<b>End cap (left)</b>	EL/AHKA/+ color*						20.84
<b>End cap (right)</b>	ER/AHKA/+ color*						20.84

**\*Color Codes**

TSI	TSBG	TSSG	TSC	TSB	TSR	TSOB	TSG	TSLA	TSDA
Ivory	Greige	Stone grey	Cream	Beige	Rustic brown	Bronze	Pewter	Light anthracite	Dark anthracite

\* To complete the item number, add the color code (e.g., AHKA 80 TSB).

**Schluter®-DILEX-PHK**

**Schluter®-DILEX-PHK** is a PVC, cove-shaped profile for inside wall corners, countertop/backsplash transitions and floor/wall transitions in applications where limited movement is expected. DILEX-PHK provides a 3/8" (10 mm) radius to prevent the accumulation of dirt and makes cleaning simple. DILEX-PHK prevents surface water penetration and meets the maintenance and hygienic requirements of commercial kitchens, bathrooms, food processing plants, or any tiled environment where a sanitary cove base is desired.

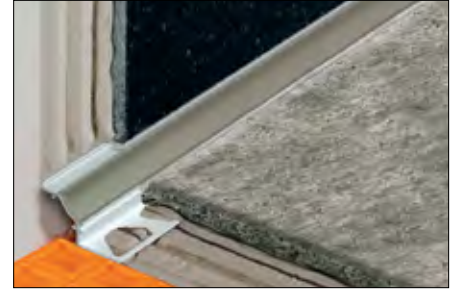
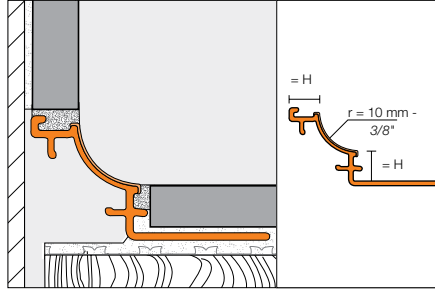

Outside corner (90° or 135°)

Inside corner (90° or 135°)



Connector

End cap

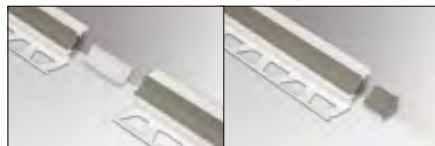

90° inside corners can be used 2-way or 3-way.

**\*Color Codes**



\* To complete the item number, add the **color** code (e.g., PHK 1S 80 / **BW**).

**Schluter®-DILEX-PHK**

Length = 2.5 m - 8' 2-1/2"		Cove base profile					
H = mm - in.	Profile	\$ / Length	Outside corner, 90°	Outside corner, 135°	Inside corner, 90°	Inside corner, 135°	\$ / Unit
8 - 5/16	PHK 1S 80 + <b>color</b> *	22.39					
10 - 3/8	PHK 1S 100 + <b>color</b> *	23.61	E 90/PHK 1S/ + <b>color</b> *	E 135/PHK 1S/ + <b>color</b> *	I 90/PHK 1S/ + <b>color</b> *	I 135/PHK 1S/ + <b>color</b> *	3.19
12.5 - 1/2	PHK 1S 125 + <b>color</b> *	23.95					
<b>Connector</b>	V/PHK						1.78
<b>End cap</b>	E/PHK 1S/ + <b>color</b> *						3.19



**Schluter®-DILEX-EHK**

**Schluter®-DILEX-EHK** is a stainless steel, cove-shaped profile for inside wall corners, countertop/backsplash transitions and floor/wall transitions in applications where limited movement is expected. DILEX-EHK provides a 23/32" (18.5 mm) radius to prevent the accumulation of dirt and makes cleaning simple. DILEX-EHK prevents surface water penetration and meets the maintenance and hygienic requirements of commercial kitchens, bathrooms, food processing plants, or any tiled environment where a sanitary cove base is desired.

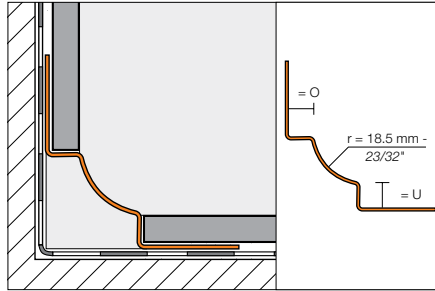

Outside corner (90° or 135°)

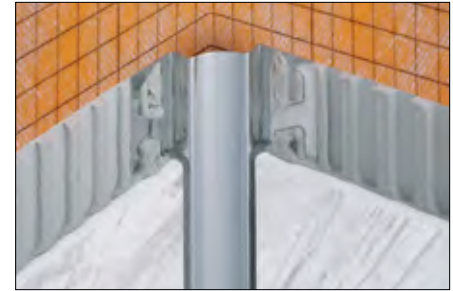

Inside corner, 3-way (90°)



Inside corner, 2-way (90° or 135°)



Connector



End cap

<b>U:</b>	7 mm = 9/32"	9 mm = 11/32"
	11 mm = 7/16"	16 mm = 5/8"
<b>O:</b>	7 mm = 9/32"	9 mm = 11/32"
	11 mm = 7/16"	16 mm = 5/8"

Schluter®-DILEX-EHK							
Stainless steel 304 (1.4301 = V2A) (E)	Stainless steel 316L (1.4404 = V4A) (EV4A)						
Length = 2.5 m - 8' 2-1/2" U = floor or wall, O = wall	\$ / Length	Outside corner, 90°	Inside corner, 90° (2-way)	Inside corner, 90° (3-way)	Outside corner, 135°	Inside corner, 135°	\$ / Unit
Profile							
EHK U 7/O 7	77.93	A/EHK 2 R18	I/EHK 2 R18	I/EHK 3 R18	E135/EHK2R18	I135/EHK2R18	9.16
EHK U 9/O 9	80.22						
EHK U 11/O 11	82.78						
<b>Connector</b>	V/EHK						9.16
<b>End cap</b>	E/HKW/G (Grey PVC only)						4.77

Stainless steel 316L (1.4404 = V4A) (EV4A)							
Length = 2.5 m - 8' 2-1/2" U = floor or wall, O = wall	\$ / Length	Outside corner, 90°	Inside corner, 90° (2-way)	Inside corner, 90° (3-way)	Outside corner, 135°	Inside corner, 135°	\$ / Unit
Profile							
EHK U 7/O 7/V4A	85.69	A/EHK 2 R18	I/EHK 2 R18	I/EHK 3 R18	E135/EHK 2 R18	I135/EHK 2 R18	9.16
EHK U 9/O 9/V4A	88.23						
EHK U 11/O 11/V4A	91.04						
EHK U 16/O 16/V4A	92.87						
<b>Connector</b>	V/EHK						9.16
<b>End cap</b>	E/HKW/G (Grey PVC only)						4.77

Brushed Stainless steel 304 (1.4301 = V2A) (EB)							
Length = 2.5 m - 8' 2-1/2" U = floor or wall, O = wall	\$ / Length	Outside corner, 90°	Inside corner, 90° (2-way)	Inside corner, 90° (3-way)	Outside corner, 135°	Inside corner, 135°	\$ / Unit
Profile							
EBHK U 7/O 7	101.31	A/EBHK 2 R18	I/EBHK 2 R18	I/EBHK 3 R18	E135/EBHK2R18	I135/EBHK2R18	11.89
EBHK U 9/O 9	104.28						
EBHK U 11/O 11	107.60						
<b>Connector</b>	V/EBHK						11.89
<b>End cap</b>	E/HKW/G (Grey PVC only)						4.77

## Schluter®-DILEX-HKS

**Schluter®-DILEX-HKS** is a stainless steel, cove-shaped profile for inside wall corners, and floor/wall transitions in applications. DILEX-HKS features a soft, thermoplastic rubber movement zone to absorb larger movements at floor/wall transitions and inside wall corners and a 23/32" (18.5 mm) radius to prevent the accumulation of dirt and makes cleaning simple. DILEX-HKS prevents surface water penetration and meets the maintenance and hygienic requirements of commercial kitchens, bathrooms, food processing plants, or any tiled environment where a sanitary cove base is desired.

**Note:** DILEX-HKS is also available in stainless steel 316L (1.4404 = V4A). Contact Customer Service for price and availability.

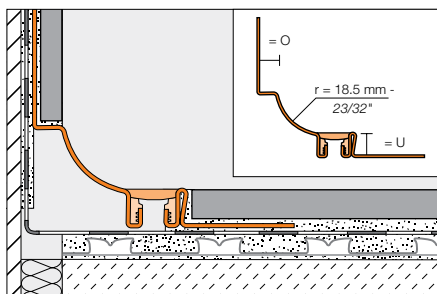

Outside corner (90°)



Inside corner, 2-way (90°)



Inside corner, 3-way (90°)



Connector



End cap

**\*Color Codes**

<b>HB</b> Light beige	<b>PG</b> Classic grey	<b>G</b> Grey	<b>GS</b> Black
--------------------------	---------------------------	------------------	--------------------

**\*** To complete the item number, add the **color** code (e.g., HKS V2A U 18 / O 7 **G**).

<b>U:</b> 8 mm = 5/16"	10 mm = 3/8"	12 mm = 15/32"	14 mm = 17/32"	16 mm = 5/8"
18 mm = 23/32"	21 mm = 13/16"	25 mm = 1"	30 mm = 1-3/16"	
<b>O:</b> 7 mm = 9/32"	9 mm = 11/32"	11 mm = 7/16"		

Schluter®-DILEX-HKS	
Length = 2.5 m - 8' 2-1/2" U = floor or wall, O = wall	Stainless steel 304 (1.4301 = V2A) (E)
Profile	\$ / Length
HKS V2A U 8 / O 7 + color*	137.25
HKS V2A U 10 / O 7 + color*	138.61
HKS V2A U 12 / O 7 + color*	139.26
HKS V2A U 14 / O 7 + color*	141.28
HKS V2A U 16 / O 7 + color*	142.65
HKS V2A U 18 / O 7 + color*	143.33
HKS V2A U 21 / O 7 + color*	144.65
HKS V2A U 25 / O 7 + color*	147.34
HKS V2A U 30 / O 7 + color*	149.36
HKS V2A U 8 / O 9 + color*	137.25
HKS V2A U 10 / O 9 + color*	138.61
HKS V2A U 12 / O 9 + color*	139.26
HKS V2A U 14 / O 9 + color*	141.28
HKS V2A U 16 / O 9 + color*	142.65
HKS V2A U 18 / O 9 + color*	143.33
HKS V2A U 21 / O 9 + color*	144.65
HKS V2A U 25 / O 9 + color*	147.34
HKS V2A U 30 / O 9 + color*	149.36
HKS V2A U 8 / O 11 + color*	137.25
HKS V2A U 10 / O 11 + color*	138.61
HKS V2A U 12 / O 11 + color*	139.26
HKS V2A U 14 / O 11 + color*	141.28
HKS V2A U 16 / O 11 + color*	142.65
HKS V2A U 18 / O 11 + color*	143.33
HKS V2A U 21 / O 11 + color*	144.65
HKS V2A U 25 / O 11 + color*	147.34
HKS V2A U 30 / O 11 + color*	149.36

Schluter®-DILEX-HKS		
Stainless steel 316L (1.4404 = V4A) (EV4A)		\$ / Unit
Outside corner, 90°	A/EHK 2 R18	9.16
Inside corner, 90° (2-way)	I/EHK 2 R18	9.16
Inside corner, 90° (3-way)	I/EHK 3 R18	9.16
Outside corner, 135°	E135/EHK2R18	9.16
Inside corner, 135°	I135/EHK2R18	9.16
Connector	V/EHK	9.16
End cap	E/HKW/G (Grey PVC only)	4.77

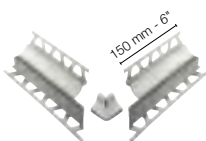

**Note:** 90° outside corners with pre-cut profile sections are available by special order only. Please contact Customer Service for availability.

Schluter®-DILEX-HKS		
Stainless steel 304 (1.4301 = V2A) (E)		\$ / Unit
90° outside corner with pre-cut profile sections	E90 V2A U ... / O ... + color**	54.16
Stainless steel 316L (1.4404 = V4A) (EV4A)		\$ / Unit
90° outside corner with pre-cut profile sections	E90 V4A U ... / O ... + color**	60.17

\*\* To complete the item number, add the "U" and "O" values, and the color code (e.g., E90 V2A U 12 / O 9 G). Available for U = 8, 10, 12, 14 and 16 mm only.



**Schluter®-DILEX-HKU**

**Schluter®-DILEX-HKU** is a stainless steel, cove-shaped profile for inside wall corners and floor/wall (including countertop/backsplash) transitions. DILEX-HKU may be used with floor coverings other than ceramic and stone tile, provided the floor coverings are fastened or adhered (i.e., no floating floors). The profile features a single anchoring leg that turns inward, which allows it to be used with different thicknesses of tile. DILEX-HKU is available with either a 3/8" (10 mm) or 1-7/16" (36 mm) radius cove section. The cove section forms the visible surface and prevents the accumulation of dirt, making cleaning simple. DILEX-HKU prevents surface water penetration and meets the maintenance and hygienic requirements of commercial kitchens, bathrooms, and food processing plants, or any tiled environment where a sanitary cove base is desired.

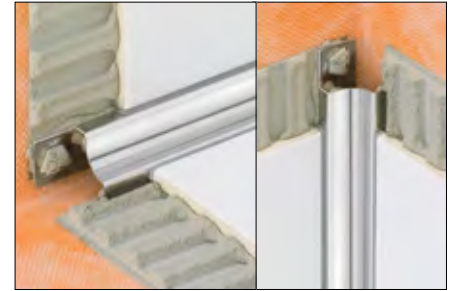
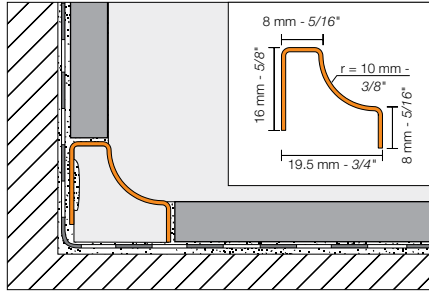

Outside corner (90° or 135°)

Inside corner (90° or 135°)

Connector

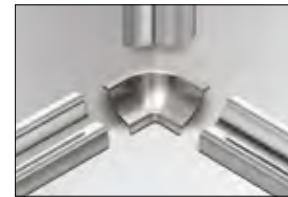
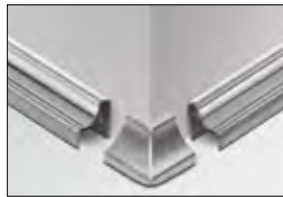

<b>Schluter®-DILEX-HKU (10 mm - 3/8" radius)</b>								
Length = 2.5 m - 8' 2-1/2"	<b>Stainless steel 304 (1.4301 = V2A) (E)</b>		<b>Stainless steel 316L (1.4404 = V4A) (EV4A)</b>					
R = mm - in.	Profile	\$ / Length	Outside corner 90°	Inside corner 90°	\$ / Unit	Outside corner 135°	Inside corner 135°	\$ / Unit
10 - 3/8	HKUR 10 E	54.79	EQ/HKUR 10 E	I/HKU 3 R 10 E	6.23	E135/HKUR 10 E	I135/HKUR 10 E	5.95
<b>Connector</b>	V/HKUR 10 E							5.66
<b>End cap</b>	EK/HKUR 10 E							5.16

Length = 2.5 m - 8' 2-1/2"	<b>Stainless steel 316L (1.4404 = V4A) (EV4A)</b>							
R = mm - in.	Profile	\$ / Length	Outside corner 90°	Inside corner 90°	\$ / Unit	Outside corner 135°	Inside corner 135°	\$ / Unit
10 - 3/8	HKUR 10 E / V4A	82.12	EQ/HKUR 10 E	I/HKU 3 R 10 E	6.23	E135/HKUR 10 E	I135/HKUR 10 E	5.95
<b>Connector</b>	V/HKUR 10 E							5.66
<b>End cap</b>	EK/HKUR 10 E							5.16

Length = 2.5 m - 8' 2-1/2"	<b>Brushed stainless steel 304 (1.4301 = V2A) (EB)</b>		<b>Brushed stainless steel 316L (1.4404 = V4A) (EBV4A)</b>					
R = mm - in.	Profile	\$ / Length	Outside corner 90°	Inside corner 90°	\$ / Unit	Outside corner 135°	Inside corner 135°	\$ / Unit
10 - 3/8	HKUR 10 EB	60.00	EQ/HKUR 10 EB	I/HKU 3 R 10 EB	6.23	E135/HKUR 10 EB	I135/HKUR 10 EB	5.95
<b>Connector</b>	V/HKUR 10 EB							5.66
<b>End cap</b>	EK/HKUR 10 EB							5.16

<b>Schluter®-DILEX-HKU (36 mm - 1-7/16" radius)</b>					
Length = 2.5 m - 8' 2-1/2"	<b>Stainless steel 304 (1.4301 = V2A) (E)</b>				
R = mm - in.	Profile	\$ / Length	Outside corner 90°	Inside corner 90°*	\$ / Unit
36 - 1-7/16	HKUR 36 E	89.76	E/HKUR 36 E	I/HKU 3 R 36 10 E	10.90
<b>External connector, stainless steel</b>	V/HKUR 36 E				10.90
<b>Internal connector, EPS foam</b>	VI/HKUR 36				3.08
<b>End cap</b>	EK/HKUR 36 E (grey PVC only)				8.20

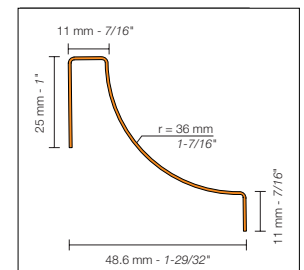

\*For 3-way inside corners, use the Schluter®-DILEX-EHK profile on the vertical (page 89).

Internal connector, EPS foam





## Schluter®-VINPRO

### Profiles designed for resilient surface coverings (LVT)

Luxury vinyl and other resilient flooring materials have improved and evolved into a whole new generation of vinyl floor coverings. Mimicking the natural looks of wood and stone using high-fidelity printing, the product is durable and realistic in both finish and texture. Following trends or creating custom layouts, resilient coverings are not limited to floors and can offer a fresh design and additional warmth to walls in a residential or commercial environment.

VINPRO is a series of finishing, edge-protection and transition profiles designed for luxury vinyl and other resilient coverings, for floors, walls, and stair surfaces.



Schluter®-VINPRO-STEP-R in brushed antique bronze (page 96)



### Schluter®-VINPRO-S

**Schluter®-VINPRO-S** is designed to provide edging for resilient coverings (e.g., LVT). Typical applications include edge protection where the resilient covering is bordered by carpet, floor coverings of similar heights, or as a finishing edge to wall skirting applications. The profile features a 1/4" (6 mm) or 7/16" (11 mm) wide sloped top flange to hide the cut edge of the resilient floor covering, providing a finished look.

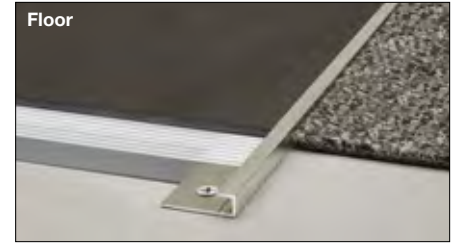
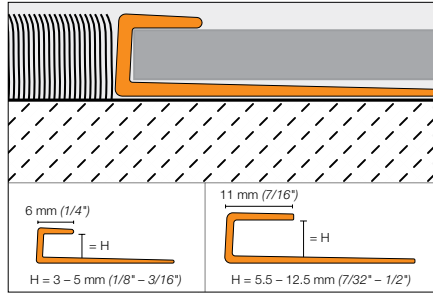

### Schluter®-VINPRO-S

Length = 2.5 m - 8' 2-1/2"	Brushed chrome anod. alu. (ACGB)		Brushed nickel anod. alu. (ATGB)		Brushed antique bronze anod. alu. (ABGB)	
	Item No.	\$ / Length	Item No.	\$ / Length	Item No.	\$ / Length
H = mm - in.						
3 - 1/8	VPS 30 ACGB	16.17	VPS 30 ATGB	17.27	VPS 30 ABGB	18.07
4 - 5/32	VPS 40 ACGB	16.36	VPS 40 ATGB	17.47	VPS 40 ABGB	18.33
5 - 3/16	VPS 50 ACGB	16.52	VPS 50 ATGB	17.64	VPS 50 ABGB	18.47
5.5 - 7/32	VPSL 55 ACGB	21.07	VPSL 55 ATGB	22.10	VPSL 55 ABGB	22.88
6 - 1/4	VPSL 60 ACGB	21.29	VPSL 60 ATGB	22.33	VPSL 60 ABGB	23.10
6.5 - 17/64	VPSL 65 ACGB	21.50	VPSL 65 ATGB	22.55	VPSL 65 ABGB	23.34
7 - 9/32	VPSL 70 ACGB	21.72	VPSL 70 ATGB	22.78	VPSL 70 ABGB	23.57
7.5 - 19/64	VPSL 75 ACGB	21.93	VPSL 75 ATGB	23.00	VPSL 75 ABGB	23.81
8 - 5/16	VPSL 80 ACGB	22.14	VPSL 80 ATGB	23.24	VPSL 80 ABGB	24.04
8.5 - 21/64	VPSL 85 ACGB	22.37	VPSL 85 ATGB	23.46	VPSL 85 ABGB	24.29
9 - 11/32	VPSL 90 ACGB	22.59	VPSL 90 ATGB	23.69	VPSL 90 ABGB	24.53
10 - 3/8	VPSL 100 ACGB	22.82	VPSL 100 ATGB	23.94	VPSL 100 ABGB	24.78
11 - 7/16	VPSL 110 ACGB	23.05	VPSL 110 ATGB	24.17	VPSL 110 ABGB	25.02
12.5 - 1/2	VPSL 125 ACGB	23.28	VPSL 125 ATGB	24.42	VPSL 125 ABGB	25.28

### Schluter®-VINPRO-T

**Schluter®-VINPRO-T** is designed to provide transitions between same-height resilient floor coverings, (e.g., LVT) primarily in retrofit applications.

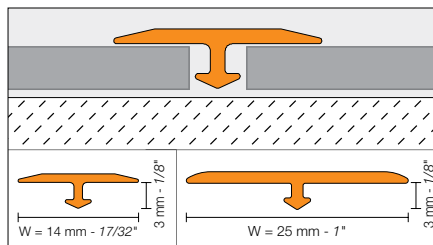

### Schluter®-VINPRO-T

Length = 2.5 m - 8' 2-1/2"	Brushed chrome anod. alu. (ACGB)		Brushed nickel anod. alu. (ATGB)		Brushed antique bronze anod. alu. (ABGB)	
	Item No.	\$ / Length	Item No.	\$ / Length	Item No.	\$ / Length
W = mm - in.						
14 - 17/32	VPT 3/14 ACGB	13.62	VPT 3/14 ATGB	13.62	VPT 3/14 ABGB	13.62
25 - 1	VPTL 3/25 ACGB	17.34	VPTL 3/25 ATGB	17.34	VPTL 3/25 ABGB	17.34



### Schluter®-VINPRO-U

Schluter®-VINPRO-U is designed to provide a smooth transition between resilient floor coverings (e.g. LVT) and floor coverings at lower elevations or finished concrete. The profile features a 1/4" (6 mm) or 7/16" (11 mm) wide sloped top flange to hide the cut edge of the resilient floor covering, providing a finished look.

#### ADA-Compliant

In installations where the leading edge abuts a lower surface covering, all sizes of VINPRO-U are compliant with the Americans with Disabilities Act (ADA). In installations where the leading edge rests on top of the lower floor covering (e.g., finished concrete), the 7/16" (11 mm) and 1/2" (12.5 mm) sizes are not ADA-compliant.

**Technical Note:** ADA requirements regarding transitions between surfaces of different heights:

- Up to 6 mm (1/4") - no special requirements
- 6 mm (1/4") to 12.5 mm (1/2") - slope ratio, 1:2
- More than 12.5 mm (1/2") - slope ratio, 1:12

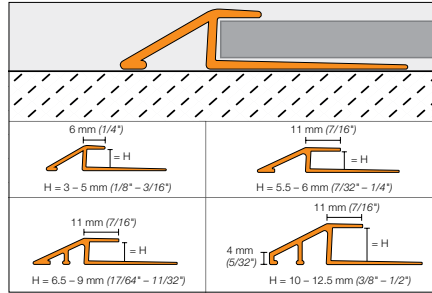

#### Diagram Values

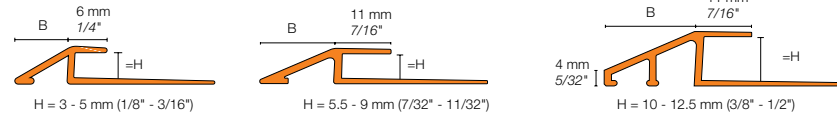

H = mm - in		B = mm - in	
3	- 1/8	8	- 5/16
4	- 5/32	9.5	- 3/8
5	- 3/16	11.5	- 29/64
5.5	- 7/32	15.4	- 19/32
6	- 1/4	16.5	- 21/32
6.5	- 17/64	17.5	- 11/16
7	- 9/32	18.6	- 47/64
7.5	- 19/64	19.7	- 25/32
8	- 5/16	20.8	- 13/16
8.5	- 21/64	21.8	- 55/64
9	- 11/32	22.9	- 29/32
10	- 3/8	19.2	- 49/64
11	- 7/16	21.5	- 27/32
12.5	- 1/2	24.7	- 31/32

### Schluter®-VINPRO-U

Length = 2.5 m - 8' 2-1/2"	Brushed chrome anod. alu. (ACGB)		Brushed nickel anod. alu. (ATGB)		Brushed antique bronze anod. alu. (ABGB)	
	Item No.	\$ / Length	Item No.	\$ / Length	Item No.	\$ / Length
H = 3 - 1/8	VPU 30 ACGB	18.60	VPU 30 ATGB	19.86	VPU 30 ABGB	20.77
4 - 5/32	VPU 40 ACGB	18.95	VPU 40 ATGB	20.20	VPU 40 ABGB	21.22
5 - 3/16	VPU 50 ACGB	19.64	VPU 50 ATGB	20.88	VPU 50 ABGB	21.90
5.5 - 7/32	VPUL 55 ACGB	30.29	VPUL 55 ATGB	32.54	VPUL 55 ABGB	33.33
6 - 1/4	VPUL 60 ACGB	31.20	VPUL 60 ATGB	33.52	VPUL 60 ABGB	34.33
6.5 - 17/64	VPUL 65 ACGB	32.14	VPUL 65 ATGB	34.52	VPUL 65 ABGB	35.36
7 - 9/32	VPUL 70 ACGB	33.10	VPUL 70 ATGB	35.56	VPUL 70 ABGB	36.42
7.5 - 19/64	VPUL 75 ACGB	34.10	VPUL 75 ATGB	36.62	VPUL 75 ABGB	37.52
8 - 5/16	VPUL 80 ACGB	35.12	VPUL 80 ATGB	37.72	VPUL 80 ABGB	38.65
8.5 - 21/64	VPUL 85 ACGB	36.17	VPUL 85 ATGB	38.85	VPUL 85 ABGB	39.80
9 - 11/32	VPUL 90 ACGB	37.26	VPUL 90 ATGB	40.01	VPUL 90 ABGB	40.99
10 - 3/8	VPUL 100 ACGB	40.62	VPUL 100 ATGB	46.52	VPUL 100 ABGB	51.13
11 - 7/16	VPUL 110 ACGB	41.83	VPUL 110 ATGB	47.92	VPUL 110 ABGB	52.66
12.5 - 1/2	VPUL 125 ACGB	43.10	VPUL 125 ATGB	49.36	VPUL 125 ABGB	54.24





**Schluter®-VINPRO-RO**

**Schluter®-VINPRO-RO** is a finishing and edging profile for resilient covering (e.g., LVT) installations on stairs and outside corners of resilient surfaces. The reveal of the profile forms a symmetrically rounded corner along the surface edge.

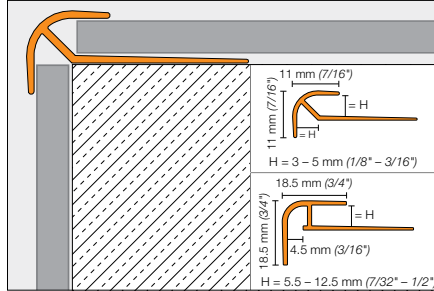

Schluter®-VINPRO-RO						
Length = 2.5 m - 8' 2-1/2"	Brushed chrome anod. alu. (ACGB)		Brushed nickel anod. alu. (ATGB)		Brushed antique bronze anod. alu. (ABGB)	
H = mm - in.	Item No.	\$ / Length	Item No.	\$ / Length	Item No.	\$ / Length
3 - 1/8	VPRO 30 ACGB	23.43	VPRO 30 ATGB	24.96	VPRO 30 ABGB	26.10
4 - 5/32	VPRO 40 ACGB	23.72	VPRO 40 ATGB	25.25	VPRO 40 ABGB	26.39
5 - 3/16	VPRO 50 ACGB	24.17	VPRO 50 ATGB	25.70	VPRO 50 ABGB	26.84
5.5 - 7/32	VPROL 55 ACGB	32.33	VPROL 55 ATGB	33.61	VPROL 55 ABGB	33.93
6 - 1/4	VPROL 60 ACGB	32.66	VPROL 60 ATGB	33.95	VPROL 60 ABGB	34.26
6.5 - 17/64	VPROL 65 ACGB	32.99	VPROL 65 ATGB	34.28	VPROL 65 ABGB	34.60
7 - 9/32	VPROL 70 ACGB	33.31	VPROL 70 ATGB	34.63	VPROL 70 ABGB	34.95
7.5 - 19/64	VPROL 75 ACGB	33.65	VPROL 75 ATGB	34.98	VPROL 75 ABGB	35.30
8 - 5/16	VPROL 80 ACGB	33.99	VPROL 80 ATGB	35.32	VPROL 80 ABGB	35.65
8.5 - 21/64	VPROL 85 ACGB	34.32	VPROL 85 ATGB	35.68	VPROL 85 ABGB	36.01
9 - 11/32	VPROL 90 ACGB	34.67	VPROL 90 ATGB	36.04	VPROL 90 ABGB	36.36
10 - 3/8	VPROL 100 ACGB	35.02	VPROL 100 ATGB	36.39	VPROL 100 ABGB	36.73
11 - 7/16	VPROL 110 ACGB	35.36	VPROL 110 ATGB	36.76	VPROL 110 ABGB	37.10
12.5 - 1/2	VPROL 125 ACGB	35.72	VPROL 125 ATGB	37.13	VPROL 125 ABGB	37.46



### Schluter®-VINPRO-STEP

**Schluter®-VINPRO-STEP** is a finishing and edging profile for resilient floor covering (e.g. LVT) installations on stairs. Two versions are available: the 1/8"-3/16" (3-5 mm) version featuring a 1/4" (6 mm) wide top flange that is grooved to add slip resistance to the horizontal surface, and the 7/32" (5.5 mm) and larger versions that feature a 7/16" (11 mm) wide top flange with a smooth horizontal surface finish. The vertical leg covers the edge of the subassembly and top of the riser.

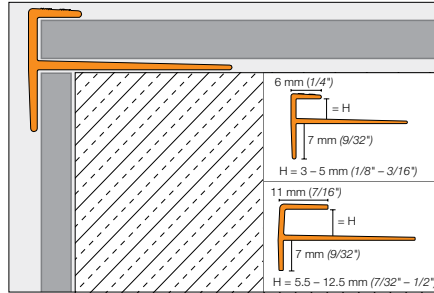

Schluter®-VINPRO-STEP							
Length = 2.5 m - 8' 2-1/2"		Brushed chrome anod. alu. (ACGB)		Brushed nickel anod. alu. (ATGB)		Brushed antique bronze anod. alu. (ABGB)	
H = mm - in.	Item No.	\$ / Length	Item No.	\$ / Length	Item No.	\$ / Length	
3 - 1/8	VPST 30 ACGB	22.81	VPST 30 ATGB	24.40	VPST 30 ABGB	24.40	
4 - 5/32	VPST 40 ACGB	22.98	VPST 40 ATGB	24.62	VPST 40 ABGB	24.62	
5 - 3/16	VPST 50 ACGB	23.19	VPST 50 ATGB	24.85	VPST 50 ABGB	24.85	
5.5 - 7/32	VPSTL 55 ACGB	26.16	VPSTL 55 ATGB	27.64	VPSTL 55 ABGB	29.68	
6 - 1/4	VPSTL 60 ACGB	26.95	VPSTL 60 ATGB	28.47	VPSTL 60 ABGB	30.57	
6.5 - 17/64	VPSTL 65 ACGB	27.75	VPSTL 65 ATGB	29.33	VPSTL 65 ABGB	31.49	
7 - 9/32	VPSTL 70 ACGB	28.59	VPSTL 70 ATGB	30.20	VPSTL 70 ABGB	32.44	
7.5 - 19/64	VPSTL 75 ACGB	29.45	VPSTL 75 ATGB	31.11	VPSTL 75 ABGB	33.41	
8 - 5/16	VPSTL 80 ACGB	30.33	VPSTL 80 ATGB	32.05	VPSTL 80 ABGB	34.40	
8.5 - 21/64	VPSTL 85 ACGB	31.24	VPSTL 85 ATGB	33.01	VPSTL 85 ABGB	35.45	
9 - 11/32	VPSTL 90 ACGB	32.18	VPSTL 90 ATGB	34.00	VPSTL 90 ABGB	36.51	
10 - 3/8	VPSTL 100 ACGB	33.14	VPSTL 100 ATGB	35.02	VPSTL 100 ABGB	37.60	
11 - 7/16	VPSTL 110 ACGB	34.14	VPSTL 110 ATGB	36.07	VPSTL 110 ABGB	38.73	
12.5 - 1/2	VPSTL 125 ACGB	35.16	VPSTL 125 ATGB	37.15	VPSTL 125 ABGB	39.89	

### Schluter®-VINPRO-STEP-R

**Schluter®-VINPRO-STEP-R** is a finishing and edging profile for resilient covering (e.g., LVT) installations on stairs. The top of the profile features a capping flange with a rounded leading edge, while the elongated vertical section provides increased visibility.

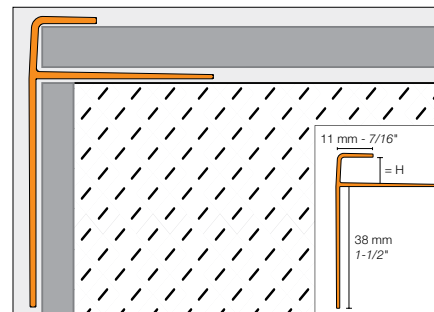

Schluter®-VINPRO-STEP-R							
Length = 2.5 m - 8' 2-1/2"		Brushed chrome anod. alu. (ACGB)		Brushed nickel anod. alu. (ATGB)		Brushed antique bronze anod. alu. (ABGB)	
H = mm - in.	Item No.	\$ / Length	Item No.	\$ / Length	Item No.	\$ / Length	
3 - 1/8	VPSTRL 30 ACGB	42.50	VPSTRL 30 ATGB	46.08	VPSTRL 30 ABGB	46.14	
4 - 5/32	VPSTRL 40 ACGB	42.93	VPSTRL 40 ATGB	46.54	VPSTRL 40 ABGB	46.60	
5 - 3/16	VPSTRL 50 ACGB	43.36	VPSTRL 50 ATGB	47.01	VPSTRL 50 ABGB	47.07	
5.5 - 7/32	VPSTRL 55 ACGB	43.79	VPSTRL 55 ATGB	47.48	VPSTRL 55 ABGB	47.54	
6 - 1/4	VPSTRL 60 ACGB	44.23	VPSTRL 60 ATGB	47.95	VPSTRL 60 ABGB	48.02	
6.5 - 17/64	VPSTRL 65 ACGB	44.68	VPSTRL 65 ATGB	48.43	VPSTRL 65 ABGB	48.50	
7 - 9/32	VPSTRL 70 ACGB	45.11	VPSTRL 70 ATGB	48.92	VPSTRL 70 ABGB	48.98	
7.5 - 19/64	VPSTRL 75 ACGB	45.57	VPSTRL 75 ATGB	49.41	VPSTRL 75 ABGB	49.47	
8 - 5/16	VPSTRL 80 ACGB	46.02	VPSTRL 80 ATGB	49.90	VPSTRL 80 ABGB	49.97	
8.5 - 21/64	VPSTRL 85 ACGB	46.48	VPSTRL 85 ATGB	50.40	VPSTRL 85 ABGB	50.47	
9 - 11/32	VPSTRL 90 ACGB	46.95	VPSTRL 90 ATGB	50.91	VPSTRL 90 ABGB	50.97	
10 - 3/8	VPSTRL 100 ACGB	47.42	VPSTRL 100 ATGB	51.42	VPSTRL 100 ABGB	51.48	
11 - 7/16	VPSTRL 110 ACGB	47.89	VPSTRL 110 ATGB	51.93	VPSTRL 110 ABGB	52.00	
12.5 - 1/2	VPSTRL 125 ACGB	48.37	VPSTRL 125 ATGB	52.45	VPSTRL 125 ABGB	52.52	



# Schluter®-KERDI-BOARD

## Waterproof, tile-ready substrates & building panels

Whether you work with mosaics or large-format tiles, an absolutely flat substrate with straight and precisely aligned inside and outside corners is essential for creating a perfect tile covering, which tile installers can now achieve on their own using KERDI-BOARD.

KERDI-BOARD gives tile setters control over their projects by providing them with the means to simply and easily create ideal substrates for tile. Unsuitable substrates can be remedied and new substrates can be produced while keeping the technical and aesthetic requirements of the tile covering in mind.





### Schluter®-KERDI-BOARD

Schluter®-KERDI-BOARD is a multifunctional tile substrate and building panel, which can also be used for creating bonded waterproofing assemblies with tile coverings. It consists of an extruded polystyrene foam panel, with a special reinforcement material on both sides and fleece webbing for effective anchoring in thin-set mortar.

With the available panel thicknesses of 3/16", 3/8", 1/2", 5/8", 3/4", 1", 1-1/2", and 2" (5, 9, 12.5, 15, 19, 25, 38, and 50 mm), KERDI-BOARD allows the installer to prepare and create a broad range of substrates and building elements for the installation of ceramic and natural stone tile that are flat, level, plumb, square, and dimensionally stable. With suitable preparation of the abutting seams and joint areas, the panel may be used for bonded waterproofing assemblies.

The boards are simply cut to size with a utility knife. The gridlines, which are printed on the surface, are helpful for neat and quick cuts and installation. Tiles can be installed directly over KERDI-BOARD using the thin-set method.

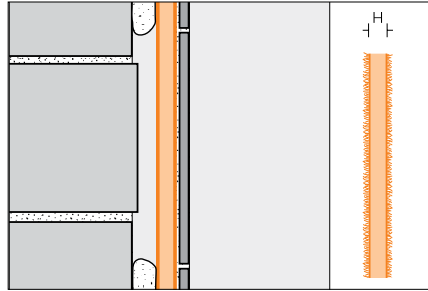

### KERDI-BOARD By Pallet

The KERDI-BOARD panels listed in the table below are shipped in full pallets only. Please order in multiples of the pallet quantity.

Schluter®-KERDI-BOARD				
Substrate and building panel				
H = mm - in.	Item No.	\$ / Panel	Panels / Pallet	\$ / Pallet
<b>Panel dimension: 122 cm x 81 cm – 48" x 32"</b>				
12.5 - 1/2	KB 12 1220 812	43.10	144	6,206.40
<b>Panel dimension: 122 cm x 162.5 cm – 48" x 64"</b>				
12.5 - 1/2	KB 12 1220 1625	86.22	78	6,725.16
<b>Panel dimension: 122 cm x 244 cm – 48" x 96"</b>				
12.5 - 1/2	KB 12 1220 2440	129.31	75	9,698.25
15 - 5/8	KB 15 1220 2440	146.20	60	8,772.00
<b>Panel dimension: 122 cm x 305 cm – 48" x 120"</b>				
15 - 5/8	KB 15 1220 3050*	182.74	60	10,964.40

\* KERDI-BOARD 5/8" panels in 48" x 120" format are available by special order only. Please contact Customer Service for more information.

### KERDI-BOARD By Bundle

The KERDI-BOARD panels listed in the table below are shipped in bundles only. Please order in multiples of the bundle quantity.

Schluter®-KERDI-BOARD				
Substrate and building panel				
H = mm - in.	Item No.	\$ / Panel	Panels / Bundle	\$ / Bundle
<b>Panel dimension: 122 cm x 162.5 cm – 48" x 64"</b>				
5 - 3/16	KB 5 1220 1625	78.54	10	785.40
9 - 3/8	KB 9 1220 1625	82.38	8	659.04
<b>Panel dimension: 122 cm x 244 cm – 48" x 96"</b>				
5 - 3/16	KB 5 1220 2440	117.76	6	706.56
9 - 3/8	KB 9 1220 2440	123.54	5	617.70
<b>Panel dimension: 62.5 cm x 244 cm – 24-1/2" x 96"</b>				
19 - 3/4	KB 19 625 2440	70.70	6	424.20
25 - 1	KB 25 625 2440	75.09	4	300.36
38 - 1-1/2	KB 38 625 2440	86.04	3	258.12
50 - 2	KB 50 625 2440	96.65	3	289.95

**⚠ WARNING:** Cancer and Reproductive Harm - www.P65Warnings.ca.gov

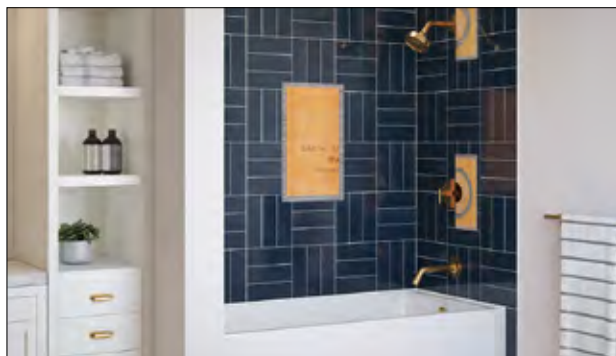

### Schluter®-KERDI-BOARD-KIT

Complete kit for waterproofing walls around bathtubs and acrylic shower bases. Refer to page 156.





### Schluter®-KERDI-BOARD-V

Schluter®-KERDI-BOARD-V is a vertically grooved substrate and building panel for creating curved elements. If a larger expanse of panels is required, several panels can be connected along the edges with thin-set mortar, Schluter®-KERDI-FIX adhesive, or double-sided adhesive tape.

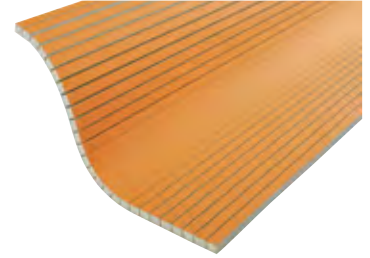
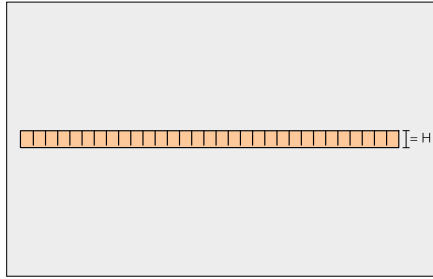

**⚠ WARNING:** Cancer and Reproductive Harm - [www.P65Warnings.ca.gov](http://www.P65Warnings.ca.gov)

Schluter®-KERDI-BOARD-V				
Grooved substrate and building panel				
H = mm - in.	Item No.	\$ / Panel	Panels / Bundle	\$ / Bundle
Panel dimension: 62.5 cm x 244 cm – 24-1/2" x 96"				
19 - 3/4	KB 19 625 2440 V	85.92	6	515.52
25 - 1	KB 25 625 2440 V	93.58	4	374.32
38 - 1-1/2	KB 38 625 2440 V	103.03	3	309.09
50 - 2	KB 50 625 2440 V	113.63	3	340.89

### Schluter®-KERDI-BOARD-E

Schluter®-KERDI-BOARD-E is an L-shaped panel used to create corners and pipe or column coverings.

The panels feature a V-shaped groove and are shipped in a space-saving flat design, which makes them easy to store. The flat panels are also quick to cut to the necessary dimensions. Thin-set mortar, Schluter®-KERDI-FIX adhesive, or double-sided adhesive tape is applied to the V-groove. The panels are then folded prior to installation.

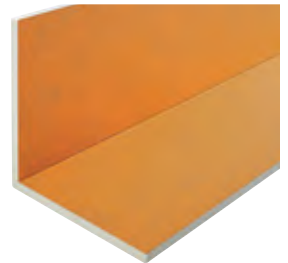
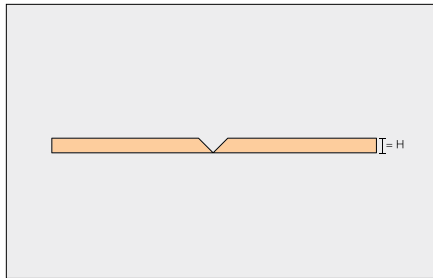

**⚠ WARNING:** Cancer and Reproductive Harm - [www.P65Warnings.ca.gov](http://www.P65Warnings.ca.gov)

Schluter®-KERDI-BOARD-E				
L-shaped panel				
H = mm - in.	Item No.	\$ / Panel	Panels / Bundle	\$ / Bundle
Panel dimension: 62.5 cm x 244 cm – 24-1/2" x 96"				
19 - 3/4	KB 19 625 2440 E	92.68	6	556.08
25 - 1	KB 25 625 2440 E	98.40	4	393.60

### Schluter®-KERDI-BOARD-U

Schluter®-KERDI-BOARD-U is a U-shaped panel used to create pipe or column coverings.

The panels feature V-shaped grooves and are shipped in a space-saving flat design, which makes them easy to store. The flat panels are also quick to cut to the necessary dimensions. Thin-set mortar, Schluter®-KERDI-FIX adhesive, or double-sided adhesive tape is applied to the V-grooves. The panels are then folded prior to installation.

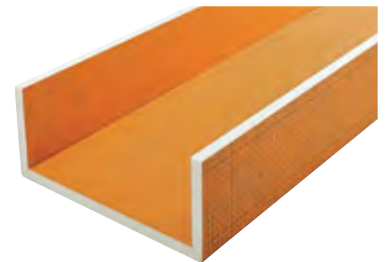
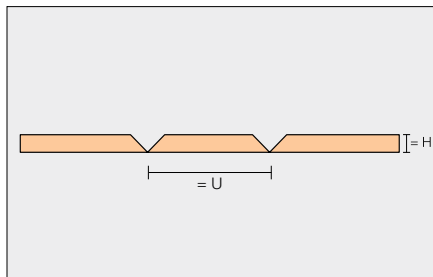

**⚠ WARNING:** Cancer and Reproductive Harm - [www.P65Warnings.ca.gov](http://www.P65Warnings.ca.gov)

Schluter®-KERDI-BOARD-U				
U-shaped panel				
H = mm - in.	Item No.	\$ / Panel	Panels / Bundle	\$ / Bundle
Panel dimension: 62.5 cm x 244 cm – 24-1/2" x 96"				
U = 20 cm – 7-7/8"				
19 - 3/4	KB 19 625 2440 U 20	116.34	6	698.04
U = 30 cm – 11-13/16"				
19 - 3/4	KB 19 625 2440 U 30	116.34	6	698.04



### Schluter®-KERDI-BOARD-SC

**Schluter®-KERDI-BOARD-SC** is a prefabricated shower curb made of KERDI-BOARD that is designed to integrate with the Schluter®-Shower System. The curb is lightweight, stable, and load bearing. It can be used in conjunction with the KERDI-SHOWER prefabricated shower trays as well as in mortar bed applications. KERDI-BOARD-SC is quick and easy to install, waterproof and ready to tile, making it a simple solution for tiled shower curbs.

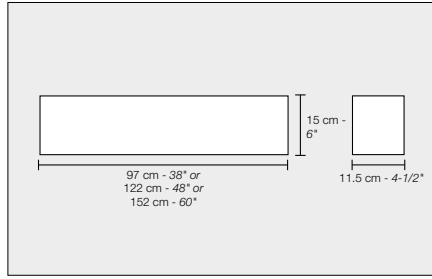

**⚠ WARNING:** Cancer and Reproductive Harm - [www.P65Warnings.ca.gov](http://www.P65Warnings.ca.gov)

Schluter®-KERDI-BOARD-SC				
Curb				
Item No.	Length	Width	Height	\$ / Unit
KBSC 115 150 970	97 cm - 38"	11.5 cm - 4-1/2"	15 cm - 6"	64.24
KBSC 115 150 1220	122 cm - 48"	11.5 cm - 4-1/2"	15 cm - 6"	70.08
KBSC 115 150 1524	152 cm - 60"	11.5 cm - 4-1/2"	15 cm - 6"	102.78

### Schluter®-KERDI-BOARD-SN

**Schluter®-KERDI-BOARD-SN** is a prefabricated shower niche made of KERDI-BOARD that can be installed in both Schluter®-KERDI and KERDI-BOARD wall assemblies. The shower niche features a 1/2" (12.5 mm) -thick by 2" (50 mm) -wide integrated bonding flange and is available in 4 different sizes. Larger sizes include a prefabricated KERDI-BOARD shelf that can be installed at any height to create separate compartments within the shower niche if desired.

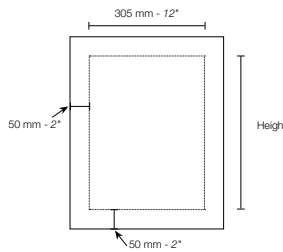

Schluter®-KERDI-BOARD-SN					
Niche					
Item No.	Height	Width	Depth	Shelf	\$ / Unit
KB 12 SN 305 152 A	152 mm - 6"	305 mm - 12"	89 mm - 3-1/2"	-	63.67
KB 12 SN 305 305 A	305 mm - 12"	305 mm - 12"	89 mm - 3-1/2"	-	76.25
KB 12 SN 305 508 A1	508 mm - 20"	305 mm - 12"	89 mm - 3-1/2"	1	103.07
KB 12 SN 305 711 A1	711 mm - 28"	305 mm - 12"	89 mm - 3-1/2"	1	123.19

**⚠ WARNING:** Cancer and Reproductive Harm - [www.P65Warnings.ca.gov](http://www.P65Warnings.ca.gov)

### Schluter®-KERDI-BOARD-SB

**Schluter®-KERDI-BOARD-SB** is a prefabricated shower bench made of KERDI-BOARD that is designed to integrate with the Schluter®-Shower System. The bench is lightweight, stable, and load bearing. It features a sloped surface to prevent the accumulation of water. KERDI-BOARD-SB is quick and easy to install, waterproof and ready to tile, making it a simple solution for tiled shower benches.

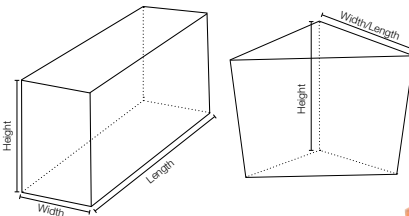

Includes 2 inside and 2 outside KERDI-KERECK waterproofing corners.

Schluter®-KERDI-BOARD-SB					
Bench					
Item No.	Length	Width	Height	Shape	\$ / Unit
KBSB 410 TA	41 cm - 16"	41 cm - 16"	51 cm - 20"	Triangular	177.53
KBSB 610 TA	61 cm - 24"	61 cm - 24"	51 cm - 20"	Triangular	231.27
KBSB 290 970 RA	97 cm - 38"	29 cm - 11-1/2"	51 cm - 20"	Rectangular	286.17
KBSB 410 1220 RA	122 cm - 48"	41 cm - 16"	51 cm - 20"	Rectangular	379.61

**⚠ WARNING:** Cancer and Reproductive Harm - [www.P65Warnings.ca.gov](http://www.P65Warnings.ca.gov)



### Schluter®-KERDI-BOARD-ZC

Schluter®-KERDI-BOARD-ZC is a brushed stainless steel, U-shaped profile with one perforated anchoring leg. It is used to finish the edges of countertops, vanities, and similar structures in conjunction with the Schluter®-RONDEC or Schluter®-QUADEC finishing profiles.

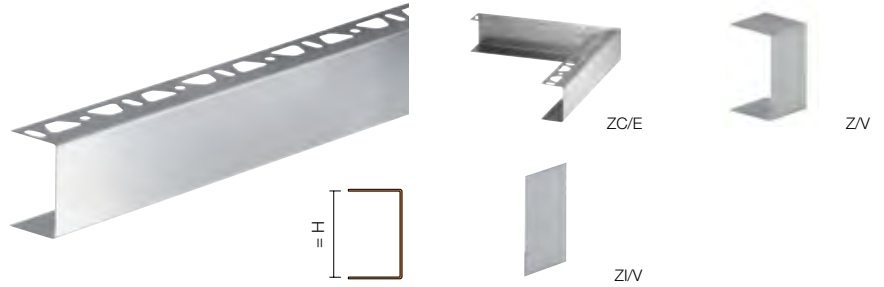

Schluter®-KERDI-BOARD-ZC		
U-shaped brushed stainless steel profile with 1 perforated anchoring leg		
H = mm - in.	Item No.	\$ / Length
Length = 2.50 m - 8' 2-1/2"		
38 - 1-1/2	KB ZC 38 EB	66.22
50 - 2	KB ZC 50 EB	72.36

Schluter®-KERDI-BOARD-ZC/E		
Brushed stainless steel outside corner piece for ZC		
H = mm - in.	Item No.	\$ / Unit
38 - 1-1/2	E/KB ZC 38 EB	23.87
50 - 2	E/KB ZC 50 EB	23.87

Schluter®-KERDI-BOARD-Z/V		
Brushed stainless steel connector for ZC and ZA		
H = mm - in.	Item No.	\$ / Unit
38 - 1-1/2	V/KB Z 38 EB	7.52
50 - 2	V/KB Z 50 EB	7.52

Schluter®-KERDI-BOARD-ZI/V		
Stainless steel internal connector for ZC and ZA		
H = mm - in.	Item No.	\$ / Unit
38 - 1-1/2	V/KB ZI 38 E	4.66
50 - 2	V/KB ZI 50 E	4.66

### Schluter®-KERDI-BOARD-ZA

Schluter®-KERDI-BOARD-ZA is a brushed stainless steel, U-shaped profile with two perforated anchoring legs. It is used to finish visible edges of partition walls and shelves.

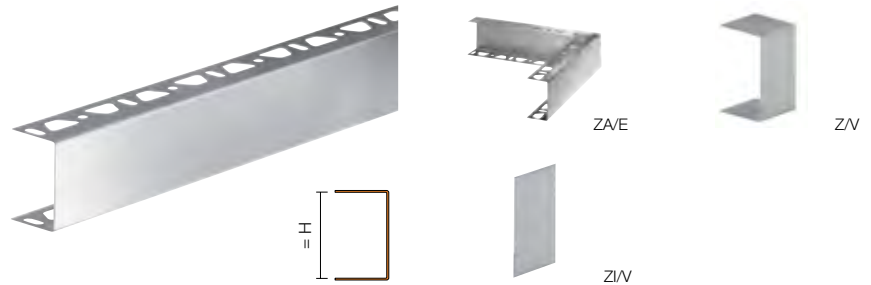

Schluter®-KERDI-BOARD-ZA		
U-shaped brushed stainless steel profile with 2 perforated anchoring legs		
H = mm - in.	Item No.	\$ / Length
Length = 2.50 m - 8' 2-1/2"		
19 - 3/4	KB ZA 19 EB	56.22
25 - 1	KB ZA 25 EB	60.71
38 - 1-1/2	KB ZA 38 EB	66.22
50 - 2	KB ZA 50 EB	72.36

Schluter®-KERDI-BOARD-ZA/E		
Brushed stainless steel outside corner piece for ZA		
H = mm - in.	Item No.	\$ / Unit
38 - 1-1/2	E/KB ZA 38 EB	23.87
50 - 2	E/KB ZA 50 EB	23.87

Schluter®-KERDI-BOARD-Z/V		
Brushed stainless steel connector for ZC and ZA		
H = mm - in.	Item No.	\$ / Unit
19 - 3/4	V/KB Z 19 EB	7.52
25 - 1	V/KB Z 25 EB	7.52
38 - 1-1/2	V/KB Z 38 EB	7.52
50 - 2	V/KB Z 50 EB	7.52

Schluter®-KERDI-BOARD-ZI/V		
Stainless steel internal connector for ZC and ZA		
H = mm - in.	Item No.	\$ / Unit
19 - 3/4	V/KB ZI 19 E	4.66
25 - 1	V/KB ZI 25 E	4.66
38 - 1-1/2	V/KB ZI 38 E	4.66
50 - 2	V/KB ZI 50 E	4.66



### Schluter®-KERDI-BOARD-ZB

Schluter®-KERDI-BOARD-ZB is a stainless steel, U-shaped profile with three-sided perforation. It is used to fasten and stabilize partition walls and other structures made of KERDI-BOARD panels. The surfaces of the profile are hidden by the tile covering.

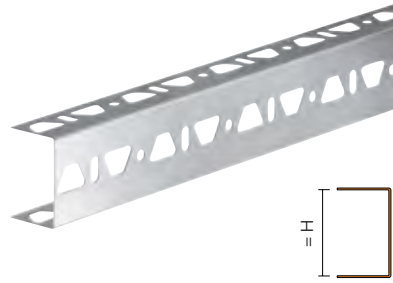

Schluter®-KERDI-BOARD-ZB		
U-shaped stainless steel profile with 3 perforated anchoring legs		
H = mm - in.	Item No.	\$ / Length
Length = 2.50 m - 8' 2-1/2"		
19 - 3/4	KB ZB 19 E	48.45
25 - 1	KB ZB 25 E	52.32
38 - 1-1/2	KB ZB 38 E	56.62
50 - 2	KB ZB 50 E	62.14

### Schluter®-KERDI-BOARD-ZW

Schluter®-KERDI-BOARD-ZW is a stainless steel angle profile with two trapezoid perforated anchoring legs. It is used to fasten and stabilize structures made of KERDI-BOARD panels. It is attached to the substrate with either screws or thin-set mortar.

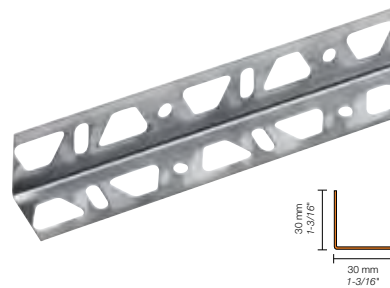

Schluter®-KERDI-BOARD-ZW	
Stainless steel angle profile	
Item No.	\$ / Length
Length = 15 cm - 6"	
KB ZW 30 E/15	1.88
Length = 2.50 m - 8' 2-1/2"	
KB ZW 30 E	28.01

### Schluter®-KERDI-BOARD-ZSD

Schluter®-KERDI-BOARD-ZSD are anchors used to provide additional mechanical attachment of KERDI-BOARD when the bond between the thin-set mortar and the substrate is questionable.

Appropriate drill bit size: 8 mm - 5/16".  
Drill hole 10 mm - 3/8" deeper than anchor length.



Schluter®-KERDI-BOARD-ZSD			
Stainless steel anchor			
Size = cm - in.	Item No.	Anchors / Box	\$ / Box
9 - 3-1/2	KB ZSD 90 E	25	32.30
11 - 4-5/16	KB ZSD 110 E	25	37.29
Galvanized steel anchor			
9 - 3-1/2	KB ZSD 90 Z	25	17.34
11 - 4-5/16	KB ZSD 110 Z	25	19.95





**Schluter®-KERDI-BOARD-ZT/-ZS**

**Schluter®-KERDI-BOARD-ZT** are galvanized steel washers used to fasten KERDI-BOARD to stud framing. They feature tabs that penetrate the surface of the KERDI-BOARD and temporarily hold the washers in place to enable quick installation of the corresponding screws. **Schluter®-KERDI-BOARD-ZS** are screws used to fasten KERDI-BOARD to stud framing with the corresponding washers.

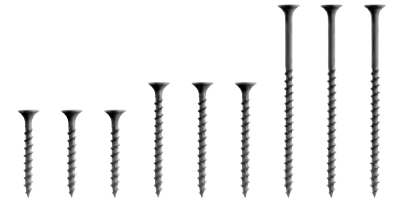

<b>Schluter®-KERDI-BOARD-ZT</b>			
Galvanized steel attachment washer			
Size = mm - in.	Item No.	Washers / Box	\$ / Box
32 - 1-1/4	KB ZT 32 Z	100	12.82
32 - 1-1/4	KB ZT 32 Z/L	1000	106.27

<b>Schluter®-KERDI-BOARD-ZS</b>			
Threaded screw for stud framing			
Size = mm - in.	Item No.	Screws / Box	\$ / Box
41 - 1-5/8	KB ZS 35 G	200	17.49
50 - 2	KB ZS 55 G	100	12.82
75 - 3	KB ZS 75 G	100	19.57



Convenient retail packaging.

<b>Schluter®-KERDI-BOARD-ZT/-ZS</b>			
Washer and Screw Set			
Size = mm - in.	Item No.	Pieces / Box	\$ / Box
41 - 1-5/8	KB ZS 35 GT 32 Z	40 each	14.58
41 - 1-5/8	KB ZS 35 GT 32 Z 100	100 each	27.51

**Schluter®-KERDI-BOARD-ZFP**

**Schluter®-KERDI-BOARD-ZFP** is a flat plastic profile, which is adhered behind the KERDI-BOARD-ZA U-shaped profile to improve fastening of hardware with screws.



<b>Schluter®-KERDI-BOARD-ZFP</b>		
Flat plastic profile		
Width mm - in.	Item No.	\$ / Length
Length = 2.50 m - 8' 2-1/2"		
35 - 1-3/8	KB ZFP 35	12.27



### Schluter®-KERDI-BAND

Schluter®-KERDI-BAND is a waterproofing strip used to seal joints, corners, and fastener penetrations with the Schluter®-KERDI-BOARD building panels, as well as butt joints and floor/wall connections with the Schluter®-KERDI, DITRA, and DITRA-HEAT membranes.

**Note:** 1 mil = 1 one-thousandth of an inch

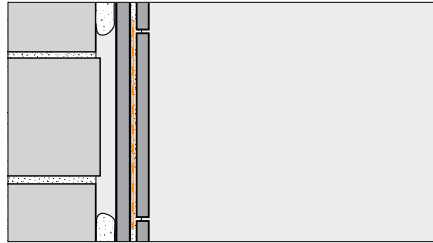

Schluter®-KERDI-BAND					
Waterproofing strip					
Item No.	Width	Length	Thickness	\$ / ft *	\$ / Roll
<b>125 mm - 5" width</b>					
KEBA 100/125/5M	125 mm - 5"	5 m - 16' 5"	4 mil	1.40	23.01
KEBA 100/125/10M	125 mm - 5"	10 m - 33'	4 mil	1.32	43.71
KEBA 100/125	125 mm - 5"	30 m - 98' 5"	4 mil	1.10	108.01
KEBA100/125/300	125 mm - 5"	300 m - 984' 3"	4 mil	0.99	972.16
<b>185 mm - 7-1/4" width</b>					
KEBA 100/185/5M	185 mm - 7-1/4"	5 m - 16' 5"	4 mil	1.84	30.14
KEBA 100/185	185 mm - 7-1/4"	30 m - 98' 5"	4 mil	1.52	149.32
<b>250 mm - 10" width</b>					
KEBA 100/250/5M	250 mm - 10"	5 m - 16' 5"	4 mil	2.29	37.56
KEBA 100/250	250 mm - 10"	30 m - 98' 5"	4 mil	1.95	191.99

\* The price per foot is for estimation purposes only. Please order using the price per roll.

### Schluter®-KERDI-BOARD-ZSA

Schluter®-KERDI-BOARD-ZSA is an adhesive tape for reinforcing the joint areas of KERDI-BOARD panels.



Schluter®-KERDI-BOARD-ZSA			
Joint reinforcement tape			
Item No.	Width	Length	\$ / Roll
KB ZSA 100/45 M	100 mm - 4"	45 m - 148'	19.05

### Schluter®-KERDI-BOARD-ZDK

Schluter®-KERDI-BOARD-ZDK is a double-sided adhesive tape used to attach KERDI-BOARD panels in joint areas or similar.



Schluter®-KERDI-BOARD-ZDK			
Double-sided tape			
Item No.	Width	Length	\$ / Roll
KB ZDK 12/10 M	12.5 mm - 1/2"	10 m - 33'	10.72
KB ZDK 19/10 M	19 mm - 3/4"	10 m - 33'	16.60
KB ZDK 30/10 M	30 mm - 1-3/16"	10 m - 33'	26.08



# Schluter®-Systems

## Waterproofing & uncoupling membranes

Ceramic and stone tiles are durable, easy to maintain, and hygienic, representing the ideal surface coverings. However, today's lightweight construction methods can make the installation of hard surface coverings particularly challenging. Schluter Systems has developed state-of-the-art installation systems that address the problems associated with today's construction methods, allowing the installation of ceramic and stone tiles on virtually any surface.

DITRA provides uncoupling to prevent cracked tiles and grout, while providing effective waterproofing to protect moisture-sensitive substrates. KERDI is a pliable, sheet-applied waterproofing membrane and vapor-retarder ideal for use in tiled showers, bathtub surrounds, and other wet areas.



## Schluter®-DITRA and Schluter®-DITRA-XL

**Schluter®-DITRA** and **Schluter®-DITRA-XL** are polyethylene uncoupling membranes with a grid structure of square cutback cavities and an anchoring fleece laminated to the underside. DITRA and DITRA-XL provide uncoupling through the open rib structure, which allows for in-plane movement that effectively neutralizes the differential movement stresses between the substrate and the tile, thus eliminating the major cause of cracking and delaminating of the tiled surface. In conjunction with tile coverings, DITRA and DITRA-XL form an uncoupling, waterproofing, and vapor management layer, while providing support/load distribution. The combination of these four essential functions allows for the successful installation of tile over a wide range of substrates, including plywood/OSB, concrete, gypsum, heated floors, etc.

**DITRA** is 1/8" (3.5 mm) thick, which minimizes tile assembly thickness and reduces transitions to lower surface coverings (e.g., carpet, engineered wood, and vinyl). DITRA allows for ceramic tile application over single-layer plywood or OSB subfloors on joists spaced up to 19.2" (488 mm) o.c. DITRA is listed by cUPC®.

**DITRA-XL** is 5/16" (7 mm) thick, which permits even transitions between tile and 3/4"-thick hardwood flooring. DITRA-XL allows for ceramic tile application over single-layer plywood/OSB subfloors on joists spaced up to 24" (610 mm) o.c.

DITRA and DITRA-XL were evaluated according to the "Standard Method for the Testing and Evaluation of Volatile Organic Chemical Emissions from Indoor Sources Using Environmental Chambers, Version 1.1 for California Specification 01350 and found to comply with the VOC requirements. California Specification 01350 is referenced by various green building standards and rating systems.

For complete information, a step-by-step installation video and the DITRA Installation Handbook are available for download at: [www.schluter.com](http://www.schluter.com) or by contacting our Customer Service.

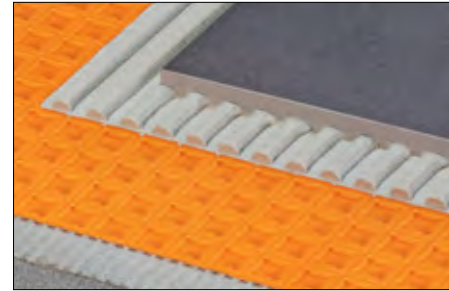
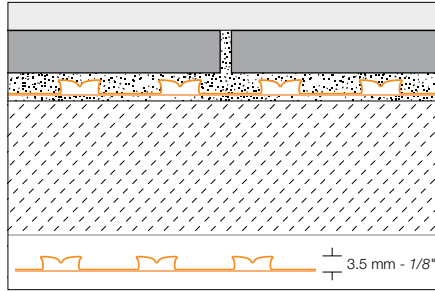

Schluter®-DITRA			
Uncoupling and waterproofing membrane 3.5 mm - 1/8"			
Item No.	Dimensions	\$ / ft² *	\$ / Roll
DITRA 5M	0.995 m x 5.1 m = 5 m² - 3' 3" x 16' 8" = 54 ft²	2.35	127.08
DITRA 150	0.995 m x 14.1 m = 14 m² - 3' 3" x 46' 3" = 150 ft²	2.18	327.29

\* The price per square foot is for estimation purposes only. Please order using the price per roll.

### DITRA By Pallet

DITRA 30M is shipped as full pallets only. Please order in multiples of the pallet quantity.

Schluter®-DITRA					
Uncoupling and waterproofing membrane 3.5 mm - 1/8"					
Item No.	Dimensions	\$ / ft² *	\$ / Roll	Rolls / Pallet	\$ / Pallet
DITRA 30M	0.995 m x 30.4 m = 30 m² 3' 3" x 99' 8" = 323 ft²	2.06	664.85	9	5,983.65

\* The price per square foot is for estimation purposes only. Please order using the price per roll.

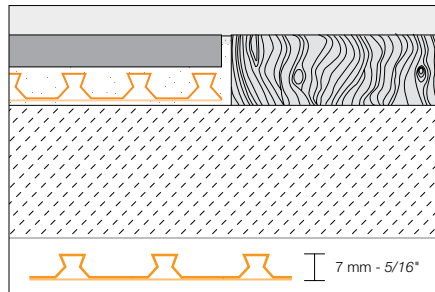

Schluter®-DITRA-XL			
Uncoupling and waterproofing membrane 7 mm - 5/16"			
Item No.	Dimensions	\$ / ft² *	\$ / Roll
DITRA-XL/175	1 m x 16.25 m = 16.25 m² - 3' 3" x 53' 3" = 175 ft²	2.41	421.81

\* The price per square foot is for estimation purposes only. Please order using the price per roll.



**Schluter®-SET, Schluter®-ALL-SET, and Schluter®-FAST-SET**  
See page 176



**Schluter®-DITRA-TROWEL and Schluter®-DITRA-HEAT/-DITRA-XL-TROWEL**  
See page 179



# Schluter®-DITRA THE ORIGINAL. NOW EVEN BETTER.

**Easy Cut**  
Cutting grooves provide a guide for straight and precise cuts.

**Easy Fill**  
Air release vents at the corners allow for faster filling of the membrane with fewer trowel passes.

## Schluter®-KERDI-FLEX

**Schluter®-KERDI-FLEX** is a flexible polyethylene waterproofing strip used to seal movement joints over Schluter®-DITRA in specialty applications where large movements are expected, i.e. over expansion joints or construction joints.

**Note:** 1 mil = 1 one-thousandth of an inch

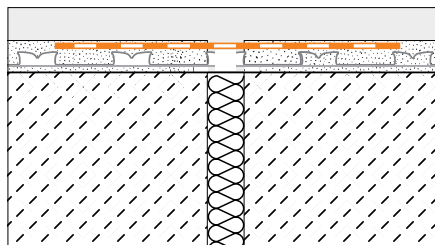

Schluter®-KERDI-FLEX					
Waterproofing strip for use above movement joints					
Item No.	Width	Length	Thickness	\$ / ft *	\$ / Roll
FLEX 125/5M	125 mm - 5"	5 m - 16' 5"	12 mil	2.65	43.49
FLEX 250/5M	250 mm - 10"	5 m - 16' 5"	12 mil	4.29	70.48
FLEX 125/30	125 mm - 5"	30 m - 98' 5"	12 mil	2.02	198.39
FLEX 250/30	250 mm - 10"	30 m - 98' 5"	12 mil	3.67	360.70

\* The price per foot is for estimation purposes only. Please order using the price per roll.

**Schluter®-KERDI and Schluter®-KERDI-DS**

**Schluter®-KERDI** is a pliable sheet-applied polyethylene waterproofing membrane and vapor retarder that guarantees uniform thickness. It is covered with an anchoring fleece on both sides to anchor the membrane in thin-set mortar and is suitable for waterproofing in conjunction with tiled surfaces on walls and floors. KERDI is 8-mil thick and has a water vapor permeance of 0.90 perms, when tested according to ASTM E96, using Procedure E at 90% relative humidity.

**Schluter®-KERDI-DS** is a bonded waterproofing membrane and vapor retarder with very low water vapor permeance for use in continuous use steam rooms and similar applications. KERDI-DS is 20-mil thick and features additives to produce a water vapor permeance of 0.19 perms, when tested according to ASTM E96, using Procedure E at 90% relative humidity.

KERDI and KERDI-DS meet the American National Standard for Load Bearing, Bonded, Waterproof Membranes for Thin-Set Ceramic Tile and Dimension Stone Installations (ANSI A118.10). The membranes are listed by cUPC® and evaluated by ICC-ES (Report Nos. ESR-2467 and PMG-1204).

KERDI and KERDI-DS have been evaluated according to the "Standard Method for the Testing and Evaluation of Volatile Organic Chemical Emissions from Indoor Sources Using Environmental Chambers, Version 1.1" for California Specification 01350 and found to comply with the VOC requirements. California Specification 01350 is referenced by various green building standards and rating systems.

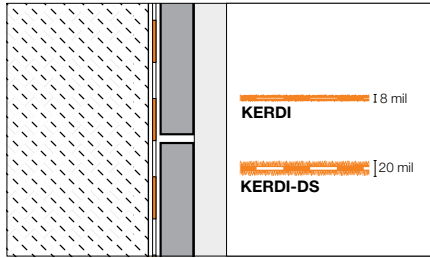

**Note:** 1 mil = 1 one-thousandth of an inch

<b>Schluter®-KERDI</b>			
<b>Waterproofing membrane</b>			
Item No.	Dimensions	\$ / ft <sup>2</sup> *	\$ / Roll
<b>Roll width: 1 m - 3' 3"</b>			
KERDI 200/5M	1 m x 5 m = 5 m <sup>2</sup> - 3' 3" x 16' 5" = 54 ft <sup>2</sup>	2.35	127.08
KERDI 200/7M	1 m x 7 m = 7 m <sup>2</sup> - 3' 3" x 23' = 75 ft <sup>2</sup>	2.32	174.05
KERDI 200/10M	1 m x 10 m = 10 m <sup>2</sup> - 3' 3" x 33' = 108 ft <sup>2</sup>	2.28	246.75
KERDI 200/20M	1 m x 20 m = 20 m <sup>2</sup> - 3' 3" x 65' 7" = 215 ft <sup>2</sup>	2.19	471.57
KERDI 200	1 m x 30 m = 30 m <sup>2</sup> - 3' 3" x 98' 5" = 323 ft <sup>2</sup>	2.06	664.85
<b>Roll width: 2 m - 6' 7"</b>			
KERDI 200200/15M	2 m x 15 m = 30 m <sup>2</sup> - 6' 7" x 49' 2-1/2" = 323 ft <sup>2</sup>	2.06	664.85
KERDI 200200	2 m x 30 m = 60 m <sup>2</sup> - 6' 7" x 98' 5" = 646 ft <sup>2</sup>	1.97	1,273.83

<b>Schluter®-KERDI-DS</b>			
<b>Waterproofing membrane</b>			
Item No.	Dimensions	\$ / ft <sup>2</sup> *	\$ / Roll
KERDI-DS	1 m x 30 m = 30 m <sup>2</sup> - 3' 3" x 98' 5" = 323 ft <sup>2</sup>	2.73	880.27

\* The price per square foot is for estimation purposes only. Please order using the price per roll.



**Schluter®-SET, Schluter®-ALL-SET, and Schluter®-FAST-SET**  
See page 176



**Schluter®-KERDI-TROWEL**  
See page 179

The **WIDE** Roll

- ✓ Wide roll available in two lengths:  
6' 7" x 49' 2-1/2" = **323 ft<sup>2</sup>** and 6' 7" x 98' 5" = **646 ft<sup>2</sup>**
- ✓ Fewer seams
- ✓ Faster installation
- ✓ Wide format covers wall area from floor to standard shower head height





### Schluter®-KERDI-BAND

**Schluter®-KERDI-BAND** is a waterproofing strip used to seal butt joints and floor/wall connections with the Schluter®-KERDI, DITRA, and DITRA-HEAT membranes, as well as joints, corners, and fastener penetrations with the Schluter®-KERDI-BOARD building panels.

**Note:** 1 mil = 1 one-thousandth of an inch

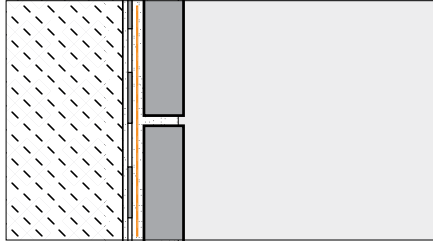

<b>Schluter®-KERDI-BAND</b>					
Waterproofing strip					
Item No.	Width	Length	Thickness	\$ / ft *	\$ / Roll
<b>125 mm - 5" width</b>					
KEBA 100/125/5M	125 mm - 5"	5 m - 16' 5"	4 mil	1.40	23.01
KEBA 100/125/10M	125 mm - 5"	10 m - 33'	4 mil	1.32	43.71
KEBA 100/125	125 mm - 5"	30 m - 98' 5"	4 mil	1.10	108.01
KEBA100/125/300	125 mm - 5"	300 m - 984' 3"	4 mil	0.99	972.16
<b>185 mm - 7-1/4" width</b>					
KEBA 100/185/5M	185 mm - 7-1/4"	5 m - 16' 5"	4 mil	1.84	30.14
KEBA 100/185	185 mm - 7-1/4"	30 m - 98' 5"	4 mil	1.52	149.32
<b>250 mm - 10" width</b>					
KEBA 100/250/5M	250 mm - 10"	5 m - 16' 5"	4 mil	2.29	37.56
KEBA 100/250	250 mm - 10"	30 m - 98' 5"	4 mil	1.95	191.99

\* The price per foot is for estimation purposes only. Please order using the price per roll.

### Schluter®-KERDI-KERECK-F

**Schluter®-KERDI-KERECK-F** are preformed, seamless corners made of Schluter®-KERDI for waterproofing inside and outside corners.

**Note:** 1 mil = 1 one-thousandth of an inch

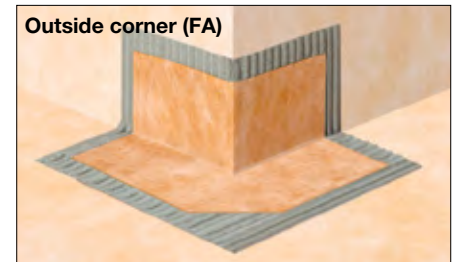
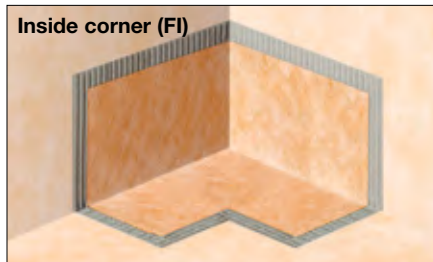

<b>Schluter®-KERDI-KERECK-F</b>			
Waterproofing for 90° corners			
Item No.	Thickness	Packaging	\$ / Package
KERECK/FI 2	4 mil	2 Inside corners	17.76
KERECK/FA 2	4 mil	2 Outside corners	17.76
Waterproofing for 135° corners			
KERECK 135 FI 2	4 mil	2 Inside corners	19.68

<b>Schluter®-KERDI-KERECK-F</b>			
Waterproofing for 90° corners			
Item No.	Thickness	Packaging	\$ / Package
KERECK/FI 10	4 mil	10 Inside corners	84.54
KERECK/FA 10	4 mil	10 Outside corners	84.54
Waterproofing for 135° corners			
KERECK 135 FI 10	4 mil	10 Inside corners	93.42

### Schluter®-KERDI-KERS-B

Schluter®-KERDI-KERS-B are preformed, seamless corners for waterproofing 135° angles between triangular shower benches and walls or for curb corners in neo-angle shower applications.

**Note:** 1 mil = 1 one-thousandth of an inch

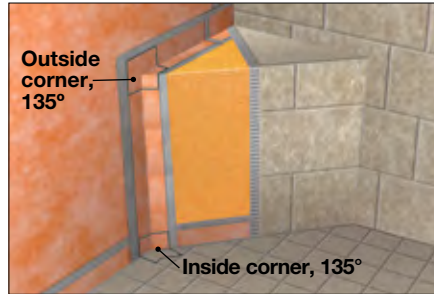

Schluter®-KERDI-KERS-B				
Waterproofing corners				
Item No.	Thickness	Description	Packaging	\$ / Package
KERECK 135 FI 2	4 mil	Inside corner, 135°	2 units	19.68
KERECK 135 FI 10	4 mil	Inside corner, 135°	10 units	93.42
KERSB 135 K LR	4 mil	Outside corner, 135°	1 right and 1 left	41.50
KERSB 135 K 5LR	4 mil	Outside corner, 135°	5 right and 5 left	197.06
KERSB 135 K	4 mil	Bench/neo-angle corner kit	1 right and 1 left 135° outside corner, and 2 135° inside corners	61.15

### Schluter®-KERDI-KERS

Schluter®-KERDI-KERS are preformed, seamless corners made of Schluter®-KERDI for waterproofing floor/wall/shower base connections in curbless shower applications where the Schluter®-KERDI-LINE linear drain is installed adjacent to the wall.

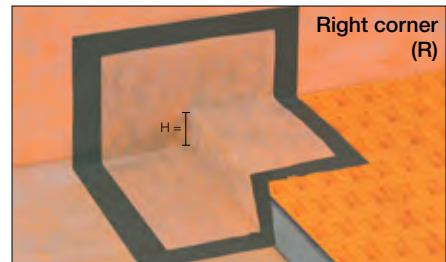
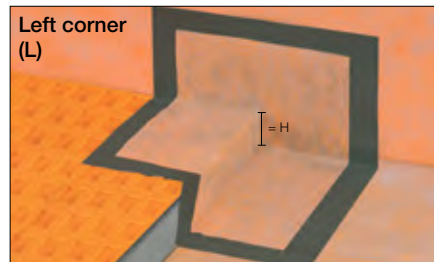

Schluter®-KERDI-KERS				
Waterproofing for corners				
Item No.	H = mm - in.	Thickness	Description	\$ / Unit
KERS 20 L	20 - 3/4	4 mil	Left inside corner	23.87
KERS 28 L	28 - 1-3/32	4 mil	Left inside corner	23.87
KERS 20 R	20 - 3/4	4 mil	Right inside corner	23.87
KERS 28 R	28 - 1-3/32	4 mil	Right inside corner	23.87





### Schluter®-KERDI-SEAL-PS/-MV

**Schluter®-KERDI-SEAL-PS/-MV** pre-fabricated seals are cut sections of the Schluter®-KERDI waterproofing membrane designed to seal protrusions through the Schluter®-KERDI or Schluter®-DITRA/DITRA-XL, as well as Schluter®-KERDI-BOARD building panels. Schluter®-KERDI-SEAL-PS and -MV feature overmolded rubber gaskets and are used to seal pipe protrusions and protect moisture-sensitive solid backing panels at the mixing valve.

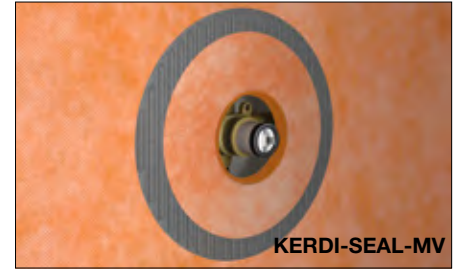
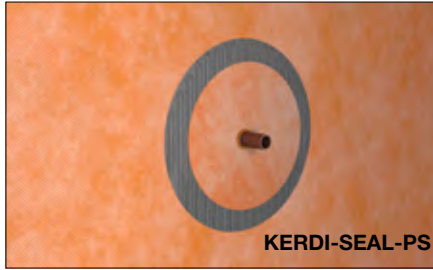

**Note:** 1 mil = 1 one-thousandth of an inch

<b>Schluter®-KERDI-SEAL-PS</b>				
Pipe seal with overmolded rubber gasket				
Item No.	Pipe nipple opening diam.	Thickness	Packaging	\$ / Package
KMS172/12	12.5 mm - 1/2"	4 mil	1 unit	8.75
KMS172/20	20 mm - 3/4"	4 mil	1 unit	8.75
KMS10172/12	12.5 mm - 1/2"	4 mil	10 units	78.72
KMS10172/20	20 mm - 3/4"	4 mil	10 units	78.72

<b>Schluter®-KERDI-SEAL-MV</b>				
Mixing valve seal with overmolded rubber gasket				
Item No.	Mixing valve opening diam.	Thickness	Packaging	\$ / Package
KMSMV235/114	114 mm - 4-1/2"	4 mil	1 unit	10.09
KMSMV10235/114	114 mm - 4-1/2"	4 mil	10 units	90.84

### Schluter®-KERDI-KM

**Schluter®-KERDI-KM** prefabricated seal is cut sections of the Schluter®-KERDI waterproofing membrane designed to seal protrusions through the KERDI or Schluter®-DITRA/DITRA-XL membranes. KERDI-KM is designed to be used in conjunction with Schluter®-KERDI-FIX or equivalent sealant to seal around pipes or other similar elements.



<b>Schluter®-KERDI-KM</b>				
Pipe seal				
Item No.	Pipe nipple opening diam.	Thickness	Packaging	\$ / Package
KM5117/22	22 mm - 7/8"	4 mil	5 units	10.30

### Schluter®-KERDI-FIX

**Schluter®-KERDI-FIX** is a single-component sealing and bonding compound with a silane-modified polymer base. It is odor-neutral, UV- and weather-resistant, and contains no solvents. KERDI-FIX is elastomeric and bonds well to most materials, such as wood, stone, concrete, metal, glass, and many plastics. KERDI-FIX is suitable for bonding the Schluter®-KERDI waterproofing membrane and Schluter®-KERDI-BAND to fixed building elements. KERDI-FIX is also suitable for use as a sealant.



<b>Schluter®-KERDI-FIX</b>	
Cartridge (290 ml – 9.81 fl oz)	
Item No.	\$ / Unit
KERDIFIX / + color*	29.75

<b>Schluter®-KERDI-FIX</b>	
Tube (100 ml – 3.38 fl oz) - Grey (G)	
Item No.	\$ / Unit
KERDIFIX 100 G	17.28

**\*Color Codes**

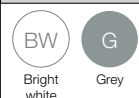

**⚠ WARNING:** Reproductive Harm [www.P65Warnings.ca.gov](http://www.P65Warnings.ca.gov)



# Schluter®-REFLEECE

## Removable fleece

Whether you want to cover an existing hard surface floor covering for a fresh new look or want to create a temporary floor covering that will be easy to remove in the future, REFLEECE offers a practical solution. The self-adhesive fleece enables the simple removal of coverings without leaving any residue or damaging the subfloor.





### Schluter®-REFLEECE

**Schluter®-REFLEECE** is a removable fleece used to create temporary floor coverings. Made of recycled PET with a self-adhesive coating on the back, REFLEECE measures 1/32" (0.8 mm) thick and is suitable for the application of temporary, removable tile and natural stone coverings. REFLEECE is easy to install and can be removed during deconstruction without causing damage to the existing subfloor. An impact sound improvement value up to 9dB was measured (according to DIN EN ISO 10140) for this assembly. Install with the Schluter®-KERDI-BOARD-ZSA adhesive tape for connecting REFLEECE at the seams.

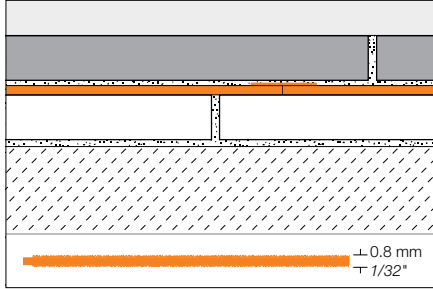

<b>Schluter®-REFLEECE</b>		
Underlayment for temporary floor coverings 0.8 mm - 1/32"		
Item No.	Dimensions	\$ / Roll
REFL 30M	1 m x 30 m = 30 m <sup>2</sup> 3' 3" x 98' 5" = 323 ft <sup>2</sup>	652.56

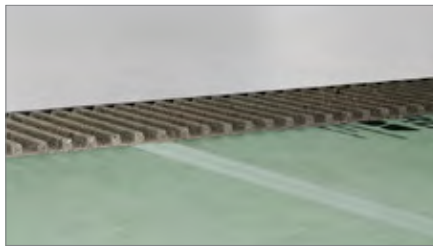

<b>Schluter®-KERDI-BOARD-ZSA</b>			
Joint reinforcement tape			
Item No.	Width	Length	\$ / Roll
KB ZSA 100/45 M	100 mm - 4"	45 m - 148'	19.05



# Schluter®-DITRA-HEAT-E

## Electric floor warming system with integrated uncoupling technology

Ceramic and stone tiles are the ideal surface coverings because they are durable, easy to maintain, and hygienic. However, two common barriers to the selection of tile as a floor covering are concerns about cracking and the perception that tiles are cold.

DITRA-HEAT integrates customizable, comfortable electric floor warming with the functions associated with DITRA: uncoupling, waterproofing, vapor management and support to ensure a long lasting installation, thereby addressing the two most common concerns.



**NEW!** Schluter®-DITRA-HEAT-PS (page 116)

All the benefits of our original electric floor warming system, now with a peel & stick self-adhesive backing to get the job done even faster.



## Schluter®-DITRA-HEAT and DITRA-HEAT-DUO

**Schluter®-DITRA-HEAT** and **DITRA-HEAT-DUO** are polypropylene membranes with a cut-back stud structure and an anchoring fleece laminated to the underside. Both membranes are designed to secure the DITRA-HEAT-E-HK electric floor heating cables and provide uncoupling, waterproofing, vapor management and support to ensure a long lasting installation.

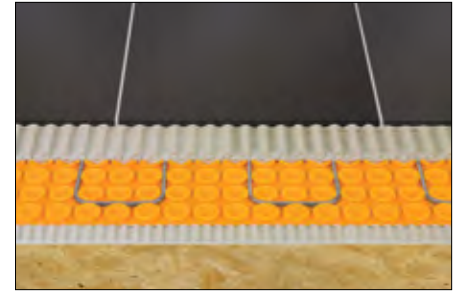
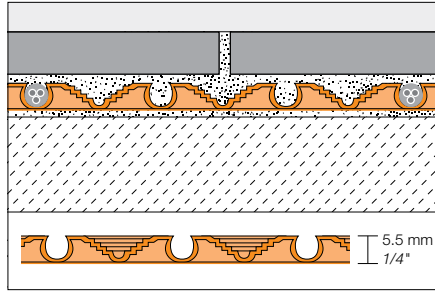

DITRA-HEAT-DUO offers the same functions as DITRA-HEAT, but features a thicker bonding fleece that adds two more benefits, while still supporting the covering to ensure a lasting installation:

### Sound Control

DITRA-HEAT-DUO reduces impact sound transmission through floor-ceiling assemblies, making it ideal for multi-story construction. DITRA-HEAT-DUO provides a ΔIIC contribution of 20, when tested per ASTM E2179 in a thin-set assembly with porcelain tile.

### Thermal Break

DITRA-HEAT-DUO reduces heat loss to the substrate to improve the floor warming response time over concrete substrates by up to 70%.

The thickness of the mat, including the stud structure, of DITRA-HEAT is 1/4" (5.5 mm) and DITRA-HEAT-DUO is 5/16" (8 mm).

The DITRA-HEAT and DITRA-HEAT-DUO membranes feature cutting grooves, which provide an easy-cut guide and enhanced membrane flexibility.

<b>Schluter®-DITRA-HEAT</b>				
Uncoupling and waterproofing membrane				
Item No.	Dimensions	Format	\$ / ft <sup>2</sup> *	\$ / Unit
DH5 12M	0.98 m x 12.76 m = 12.5 m <sup>2</sup> 3' 2-5/8" x 41' 10-3/4" = 134.5 ft <sup>2</sup>	Roll	2.85	383.82
DH5 MA	0.98 m x 0.8 m = 0.78 m <sup>2</sup> 3' 2-5/8" x 2' 7-3/8" = 8.4 ft <sup>2</sup>	Sheet	2.97	24.91

\* The price per square foot is for estimation purposes only. Please order using the price per roll or per sheet.  
**Note:** The case quantity of DITRA-HEAT sheets (DH5 MA) is 45.

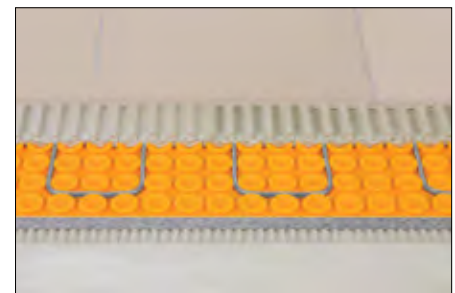
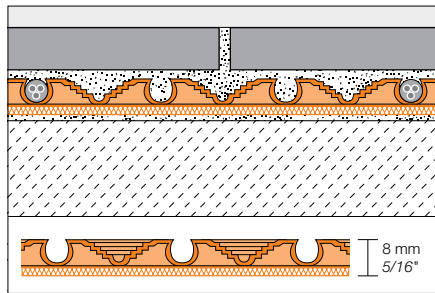

<b>Schluter®-DITRA-HEAT-DUO</b>				
Uncoupling and waterproofing membrane with sound control and thermal break				
Item No.	Dimensions	Format	\$ / ft <sup>2</sup> *	\$ / Unit
DHD8 10M	0.98 m x 10.2 m = 10 m <sup>2</sup> 3' 2-5/8" x 33' 6-1/2" = 108 ft <sup>2</sup>	Roll	4.09	442.18
DHD8 MA	0.98 m x 0.8 m = 0.78 m <sup>2</sup> 3' 2-5/8" x 2' 7-3/8" = 8.4 ft <sup>2</sup>	Sheet	4.28	35.97

\* The price per square foot is for estimation purposes only. Please order using the price per roll or per sheet.  
**Note:** The case quantity of DITRA-HEAT-DUO sheets (DHD8 MA) is 36.



**Schluter®-SET, Schluter®-ALL-SET, and Schluter®-FAST-SET**  
See page 176



**Schluter®-DITRA-HEAT/-DITRA-XL-TROWEL**  
See page 179



## Schluter®-DITRA-HEAT-PS and DITRA-HEAT-DUO-PS

**Schluter®-DITRA-HEAT-PS** and **DITRA-HEAT-DUO-PS** are peel and stick membranes that feature a pressure-sensitive adhesive (PSA) to bond the membrane to the substrate, replacing the need for thin-set mortar. Simply remove the transparent release film from the fleece side of the membrane to expose the layer of adhesive and embed into substrate using a float, screed trowel, or DITRA-ROLLER. The -PS versions offer the same core functions as DITRA-HEAT and DITRA-HEAT-DUO. Both peel and stick membranes are designed to secure the DITRA-HEAT-E-HK electric floor heating cables, and provide uncoupling, waterproofing, vapor management, and load support to ensure a long-lasting tile installation.

DITRA-HEAT-DUO-PS features a thicker bonding fleece that additionally provides sound control to reduce impact sound transmission through floor-ceiling assemblies and a thermal break that reduces heat loss to the substrate to improve floor warming response time, particularly over concrete substrates.

DITRA-HEAT-PS is 1/4" (5.5 mm) -thick and DITRA-HEAT-DUO-PS is 5/16" (8 mm) -thick. Both membranes feature cutting grooves, which provide an easy-cut guide and enhanced membrane flexibility.

A primer is not required to install DITRA-HEAT-PS/-DUO-PS, however, a primer such as Schluter®-PRIMER-U is recommended when installing on a difficult-to-bond-to substrate.

**Note:** For applications requiring compliance with or certification to the ANSI A118.10 American National Standard Specifications for Load Bearing, Bonded, Waterproof Membranes for Thin-Set Ceramic Tile and Dimension Stone Installation, select the DITRA-HEAT or DITRA-HEAT-DUO membranes that are installed with thin-set mortar. Alternatively, the DITRA-HEAT-PS or DITRA-HEAT-DUO-PS membranes may be covered with the Schluter®-KERDI membrane, which is certified to meet ANSI A118.10.

For complete information, a step-by-step installation video, Installation Handbook, and Technical Data Sheet are available for download at: [www.schluter.com](http://www.schluter.com) or by contacting our Customer Service.

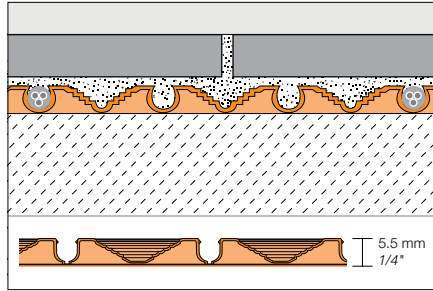

Schluter®-DITRA-HEAT-PS				
Peel and stick floor warming				
Item No.	Dimensions	Format	\$ / ft <sup>2</sup> *	\$ / Unit
DHPS5 12M	0.98 m x 12.76 m = 12.5 m <sup>2</sup> 3' 2-5/8" x 41' 10-3/4" = 134.5 ft <sup>2</sup>	Roll	3.57	479.77
DHPS5 MA	0.98 m x 0.8 m = 0.78 m <sup>2</sup> 3' 2-5/8" x 2' 7-3/8" = 8.4 ft <sup>2</sup>	Sheet	3.71	31.14

\* The price per square foot is for estimation purposes only. Please order using the price per roll or per sheet.  
**Note:** The case quantity of DITRA-HEAT-PS sheets (DHPS5 MA) is 45.

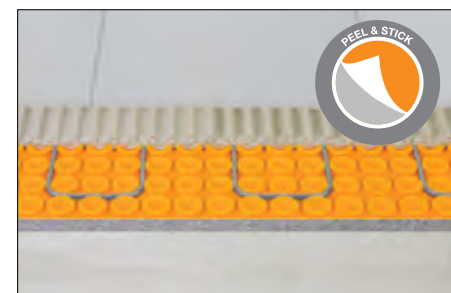
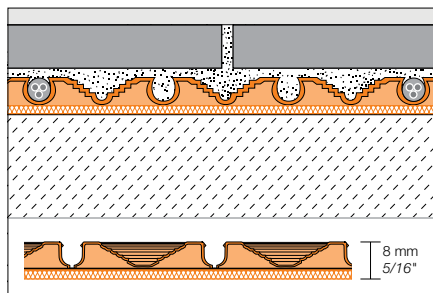

Schluter®-DITRA-HEAT-DUO-PS				
Peel and stick floor warming with sound control and thermal break				
Item No.	Dimensions	Format	\$ / ft <sup>2</sup> *	\$ / Unit
DHPS8 10M	0.98 m x 10.2 m = 10 m <sup>2</sup> 3' 2-5/8" x 33' 6-1/2" = 108 ft <sup>2</sup>	Roll	5.12	552.73
DHPS8 MA	0.98 m x 0.8 m = 0.78 m <sup>2</sup> 3' 2-5/8" x 2' 7-3/8" = 8.4 ft <sup>2</sup>	Sheet	5.35	44.97

\* The price per square foot is for estimation purposes only. Please order using the price per roll or per sheet.  
**Note:** The case quantity of DITRA-HEAT-DUO-PS sheets (DHPS8 MA) is 36.





**Schluter®-DITRA-HEAT-E-HK**

Schluter®-DITRA-HEAT-E-HK are twisted pair heating cables designed for integration with the DITRA-HEAT uncoupling membrane in interior floor warming applications. The cables can be installed without returning to the thermostat and produce virtually zero electromagnetic fields.

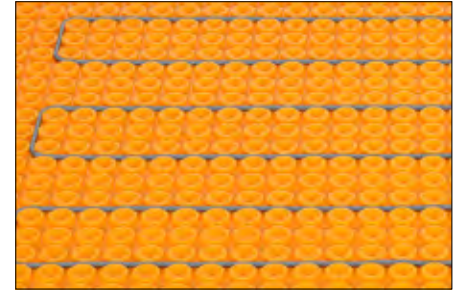

**BEFORE ordering heating cables, see IMPORTANT ordering information on page 119.**

<b>Schluter®-DITRA-HEAT-E-HK</b>													
<b>Heating cable</b>													
Item No.	Heating Cable Length		Area Covered per Cable Spacing				Total Power (W)	Avg. Power per Unit Area per Cable Spacing				Current (Amps)	\$ / Length
	(ft)	(m)	Regular 3 Stud		Alternating 3-2 Stud			Regular 3 Stud		Alternating 3-2 Stud			
<b>Heating Cable (120 V)</b>													
DHE HK 120 11	35.3	10.8	10.7	1.0	8.9	0.8	135	12.6	136	15.2	164	1.1	218.69
DHE HK 120 16	52.9	16.1	16.0	1.5	13.3	1.2	203	12.7	136	15.2	164	1.7	243.80
DHE HK 120 21	70.5	21.5	21.3	2.0	17.8	1.7	270	12.7	136	15.2	164	2.3	292.50
DHE HK 120 27	88.2	26.9	26.7	2.5	22.2	2.1	338	12.7	136	15.2	164	2.8	314.12
DHE HK 120 32	105.8	32.2	32.0	3.0	26.7	2.5	405	12.7	136	15.2	164	3.4	339.88
DHE HK 120 38	124.1	37.8	37.5	3.5	31.3	2.9	475	12.7	136	15.2	164	4.0	364.23
DHE HK 120 43	141.1	43.0	42.7	4.0	35.6	3.3	540	12.7	136	15.2	164	4.5	385.51
DHE HK 120 51	169.8	51.8	51.4	4.8	42.8	4.0	650	12.7	136	15.2	164	5.4	433.02
DHE HK 120 64	212.9	64.9	64.4	6.0	53.7	5.0	815	12.7	136	15.2	164	6.8	480.23
DHE HK 120 73	240.2	73.2	72.7	6.8	60.6	5.6	920	12.7	136	15.2	164	7.7	527.85
DHE HK 120 83	275.5	84.0	83.3	7.7	69.4	6.5	1055	12.7	136	15.2	164	8.8	592.01
DHE HK 120 92	303.0	92.4	91.7	8.5	76.4	7.1	1160	12.7	136	15.2	164	9.7	646.32
DHE HK 120 102	336.9	102.7	101.9	9.5	84.9	7.9	1290	12.7	136	15.2	164	10.7	711.21
DHE HK 120 113	372.2	113.4	112.6	10.5	93.8	8.7	1425	12.7	136	15.2	164	11.9	776.69
DHE HK 120 134	444.0	135.3	134.3	12.5	111.9	10.4	1700	12.7	136	15.2	164	14.2	849.78
<b>Heating Cable (240 V)</b>													
DHE HK 240 11	35.3	10.8	10.7	1.0	8.9	0.8	135	12.6	136	15.2	164	0.6	218.69
DHE HK 240 16	53.1	16.2	16.1	1.5	13.4	1.2	203	12.6	136	15.2	164	0.8	243.67
DHE HK 240 21	70.6	21.5	21.4	2.0	17.8	1.7	270	12.7	136	15.2	164	1.1	292.52
DHE HK 240 27	88.2	26.9	26.7	2.5	22.2	2.1	338	12.7	136	15.2	164	1.4	314.11
DHE HK 240 32	105.8	32.2	32.0	3.0	26.7	2.5	405	12.7	136	15.2	164	1.7	339.88
DHE HK 240 38	124.1	37.8	37.5	3.5	31.3	2.9	475	12.7	136	15.2	164	2.0	364.28
DHE HK 240 43	141.0	43.0	42.6	4.0	35.5	3.3	540	12.7	136	15.2	164	2.3	385.58
DHE HK 240 53	176.3	53.7	53.3	5.0	44.4	4.0	675	12.7	136	15.2	164	2.8	432.88
DHE HK 240 64	211.6	64.5	64.0	5.9	53.3	5.0	810	12.7	136	15.2	164	3.4	480.40
DHE HK 240 75	248.2	75.7	75.1	7.0	62.6	5.8	950	12.7	136	15.2	164	4.0	527.60
DHE HK 240 85	282.1	86.0	85.3	7.9	71.1	6.6	1080	12.7	136	15.2	164	4.5	576.54
DHE HK 240 103	339.4	103.4	102.7	9.5	85.6	7.9	1300	12.7	136	15.2	164	5.4	648.37
DHE HK 240 129	425.8	129.8	128.8	12.0	107.3	10.0	1630	12.7	136	15.2	164	6.8	724.21
DHE HK 240 145	480.5	146.5	145.3	13.5	121.1	11.3	1840	12.7	136	15.2	164	7.7	787.54
DHE HK 240 167	551.0	167.9	166.7	15.5	138.9	12.9	2110	12.7	136	15.2	164	8.8	849.11
DHE HK 240 183	605.9	184.7	183.3	17.0	152.7	14.2	2320	12.7	136	15.2	164	9.7	927.49
DHE HK 240 204	673.8	205.4	203.8	18.9	169.9	15.8	2580	12.7	136	15.2	164	10.7	998.75
DHE HK 240 225	744.4	226.9	225.2	20.9	187.7	17.4	2850	12.7	136	15.2	164	11.9	1,073.09

Each heating cable includes 2 floor temperature sensors compatible with the Schluter®-DITRA-HEAT-E thermostats and features an approximately 7 ft (2.1 m) long cold lead.



## Schluter®-DITRA-HEAT-E-HK Heating Cables 208 V Applications

Schluter®-DITRA-HEAT offers complete flexibility when creating warm floors in any application. DITRA-HEAT-E-HK heating cables are designed for use with common 120 V and 240 V power sources. 208 V power sources are used in some cases to handle larger loads (e.g., HVAC equipment, motors, etc.) or to improve energy efficiency.

Schluter-Systems recommends using the DITRA-HEAT-E-HK 240 V heating cables when a 208 V power source is present. However, this will reduce the heating power by 25% to 9.5 W/ft<sup>2</sup> at the standard 3-stud cable spacing, which may not be sufficient power to warm the floor in these applications. To offset the effect

of the lower voltage, we recommend installing the heating cable at a 2-stud spacing in these applications. This results in an increased heating power of 14.2 W/ft<sup>2</sup>, which will ensure adequate performance.

The heating cable will cover 33% less area when spaced at 2 studs compared to 3 studs. Therefore, a longer heating cable must be selected to cover a given area in these applications. Coverage for each 240 V heating cable spaced at 2 studs can be found in the table below.

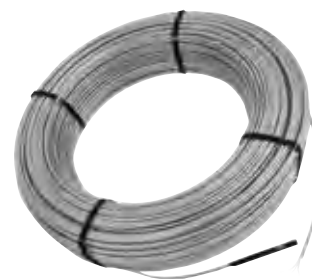

### DITRA-HEAT-E-HK 240 V Heating Cables in 208 V Applications at 2 Stud Spacing

Item No.	Length (ft - m)	Area (ft <sup>2</sup> - m <sup>2</sup> )	Power (W)	Average Power (W/ft <sup>2</sup> - W/m <sup>2</sup> )	Current (A)
DHE HK 240 11	35.3 – 10.8	7.1 – 0.7	101	14.2 - 152.8	0.5
DHE HK 240 16	53.1 – 16.2	10.7 – 1.0	152	14.2 - 152.8	0.7
DHE HK 240 21	70.5 – 21.5	14.2 – 1.3	203	14.2 - 152.8	1.0
DHE HK 240 27	88.2 – 26.9	17.8 – 1.7	254	14.2 - 152.8	1.2
DHE HK 240 32	105.8 – 32.2	21.3 – 2.0	304	14.2 - 152.8	1.5
DHE HK 240 38	124.1 – 37.8	25.0 – 2.3	356	14.2 - 152.8	1.7
DHE HK 240 43	141 – 43.0	28.4 – 2.6	405	14.2 - 152.8	1.9
DHE HK 240 53	176.3 – 53.7	35.5 – 3.3	506	14.2 - 152.8	2.4
DHE HK 240 64	211.6 – 64.5	42.7 – 4.0	608	14.2 - 152.8	2.9
DHE HK 240 75	248.2 – 75.7	50.0 – 4.7	713	14.2 - 152.8	3.4
DHE HK 240 85	282.1 – 86.0	56.9 – 5.3	810	14.2 - 152.8	3.9
DHE HK 240 103	339.4 – 103.4	68.4 – 6.4	975	14.2 - 152.8	4.7
DHE HK 240 129	425.8 – 129.8	85.8 – 8.0	1223	14.2 - 152.8	5.9
DHE HK 240 145	480.5 – 146.5	96.9 – 9.0	1380	14.2 - 152.8	6.6
DHE HK 240 167	551 – 167.9	111.1 – 10.3	1583	14.2 - 152.8	7.6
DHE HK 240 183	605.9 – 184.7	122.1 – 11.4	1740	14.2 - 152.8	8.4
DHE HK 240 204	673.8 – 205.4	135.8 – 12.6	1935	14.2 - 152.8	9.3
DHE HK 240 225	744.4 – 226.9	150.1 – 13.9	2138	14.2 - 152.8	10.3

We recommend consulting with a qualified electrician for design and installation of your DITRA-HEAT system on a 208 V power source. Keep in mind during design of the system that the DITRA-HEAT-E thermostats have an electrical current limit of 15 A.





## IMPORTANT Ordering Information for Schluter®-DITRA-HEAT Cables

- Do not purchase a heating cable the same size as the area to be tiled; this will be too much heating cable!
- Very important: **Never CUT or modify the heating cable in any way.** This would change the cable resistance, will cause damage to the cable, and could cause cable overheating.
- A cable spacing of 3 studs is standard
- Cable may also be spaced at continuously alternating 3 stud – 2 stud – 3 stud intervals in isolated areas or over the entire floor. This practice may be desirable to increase heat output (e.g., over uninsulated on or below grade concrete subfloors) or to consume more cable length in a given area (e.g., when using the standard 3 stud spacing doesn't allow the selected cable to fit the floor area and respect minimum spacing requirements from walls, partitions, etc.)
- A cable spacing of 4 studs is not recommended, as it can produce inconsistent floor surface temperatures
- Minimum spacing from walls, partitions, and fixed cabinets is 2" (50 mm).
- Minimum spacing from other heat sources (baseboard heaters, fireplaces, etc.) is 8" (200 mm).
- Minimum spacing from any plumbing drain and forced air heating ducts is 4" (100 mm).
- Minimum spacing from the centerline of toilet drain is 7" (180 mm).
- The heating section of the cable must be entirely installed under the floor covering. The installation is characterized as a Type C (Embedded Floor Warming) application. In order to prevent a fire hazard, do not install it anywhere else (e.g. in a wall).
- NEVER install the heating cable under vanities with no air space beneath, bathtub platforms, free-standing bathtubs with no air space beneath, kitchen cabinets or any other fixtures or in clothing closets. Excessive heat will build up in these confined spaces and may cause cable overheating.
- It is helpful to plan the location of a buffer zone, as it is not possible to predict where the heating cable will end. The buffer zone is an area where heating is not essential and heating cable installation is not planned (e.g., behind a toilet or adjacent to a door opening). This area allows for placement of excess heating cable. Heating cables may also be installed 6" (150 mm) from the wall to create a buffer zone.
- Heating cable testing is required while the heating cable is on the spool and at two subsequent steps during installation to ensure cable quality and for warranty purposes.

## Schluter®-DITRA-HEAT-E-HK-RK Heating Cable Repair Kit and Schluter®-DITRA-HEAT-E-HK-SK Heating Cable Splice Kit

**Schluter®-DITRA-HEAT-E-HK-RK** is a repair kit for DITRA-HEAT-E-HK heating cables. The kit contains all the material to replace one section of heating cable (gray section) up to 10" (25 cm) long or less in the event of damage, such as cuts by other trades during installation.

**Schluter®-DITRA-HEAT-E-HK-SK** is a splice kit for DITRA-HEAT-E-HK heating cables. The kit contains all the material to replace one factory splice of the heating cable.

**Please visit [www.schluter.com](http://www.schluter.com) for ordering information.**

### WARNINGS

- Heating cable repairs must be conducted by a qualified electrician in accordance with this heating cable repair procedure, the National Electric Code (USA) or Canadian Electric Code Part I (CAN) as applicable and the Schluter®-DITRA-HEAT Installation Handbook. All electrical connections must be made by a qualified electrician, according to the electrical and building codes effective in your region.
- **Prior to commencing a repair:** Any known deviations from the Schluter®-DITRA-HEAT Installation Handbook and/or applicable code(s) must be corrected. All cable installation and repair instructions must be followed in order to avoid personal injuries or property damage.
- Do not use these kits to splice different heating cables together. These kits are only intended for making repairs to a single cable.

- The heating cable cannot be shortened or altered to fit.
- **Very important:** Never CUT the heating cable. This could change the cable resistance and could lead to a fire.
- **WARRANTY DISCLAIMER:** Any deviation from the DITRA-HEAT Installation Handbook (which includes damage to the DITRA-HEAT-E-HK heating cables) voids the Schluter®-DITRA-HEAT Limited limited Warranty and warranty coverage is not reinstated upon repair of the heating cable. SCHLUTER SYSTEMS FURTHER DISCLAIMS ANY AND ALL WARRANTIES EXPRESSED OR IMPLIED, INCLUDING BUT NOT LIMITED TO THE IMPLIED WARRANTIES OF MERCHANTABILITY OR FITNESS FOR A PARTICULAR PURPOSE AND ANY AND ALL LIABILITY ARISING FROM THE ELECTRICIAN SERVICES.



## Schluter®-DITRA-HEAT-E Thermostats

**Schluter®-DITRA-HEAT-E digital thermostats** control the DITRA-HEAT-E-HK heating cables (both 120 V and 240 V). All thermostats feature a 5 mA built-in ground fault circuit interrupter (GFCI) with indicator light, and have an electrical current limit of 15 amps.

**Schluter®-DITRA-HEAT-E-WiFi** programmable Wi-Fi thermostat offers all the same features as the Programmable Touchscreen model, with additional Wi-Fi functionality that enables the user to control the DITRA-HEAT electric floor warming system from a mobile app or online.

**Schluter®-DITRA-HEAT-E-RT programmable touchscreen thermostat** features six programming periods per day, a set-up wizard, energy log, and a QR code for quick access to system settings.

**Schluter®-DITRA-HEAT-E-R non-programmable** version features simple on/off functionality.

Schluter®-DITRA-HEAT-E-WiFi		
Touchscreen programmable Wi-Fi digital floor thermostat		
Item No.	Description	\$ / Unit
DHE RT 104/BW	Touchscreen programmable Wi-Fi thermostat in bright white	341.96

according to the following standards: UL 60730-1, UL 60730-2-9, CSA E60730-1, CSA E60730-2-9, UL E-file: E157297, GFCI: UL 943 4th ed., CSA C22.2 No. 144.1-06



Wi-Fi

Schluter®-DITRA-HEAT-E-RT		
Touchscreen programmable digital floor thermostat		
Item No.	Description	\$ / Unit
DHE RT 102/BW	Touchscreen programmable thermostat in bright white	268.85

according to the following standards: UL 60730, CSA E60730-1, UL E-file: E157297, GFCI: UL 943, CSA C22.2 No.144.1-06



RT

Schluter®-DITRA-HEAT-E-R		
Non-programmable digital floor thermostat		
Item No.	Description	\$ / Unit
DHE RT 103/BW	Non-programmable thermostat in bright white	188.66

according to the following standards: UL 60730, CSA E60730-1, UL E-file: E157297, GFCI: UL 943, CSA C22.2 No.144.1-06



R

## Schluter®-DITRA-HEAT-E-RR

**Schluter®-DITRA-HEAT-E-RR** is a power module that extends power output when used in conjunction with the DITRA-HEAT-E-WiFi, -RT, or -R thermostats. The power module is designed to be used in large floor applications where the heating load exceeds 15 amps, in order to maintain a single point of control. Up to 16 DITRA-HEAT-E-RR power modules may be connected in series via low voltage signal wire to a single DITRA-HEAT-E-WiFi, -RT, or -R thermostat. The power module also features a 5 mA built-in GFCI.

Schluter®-DITRA-HEAT-E-RR		
Power module		
Item No.	Description	\$ / Unit
DHE RR 1/BW	Power module	165.08

according to the following standards: CSA E60730-1, GFCI: UL 943, CSA C22.2 No.144.1-06





**NEW!**  
Smart Thermostat  
for the DITRA-HEAT  
Floor Warming System



**Schluter®-DITRA-HEAT-E-RS1 Smart Thermostat**

**Schluter®-DITRA-HEAT-E-RS1 smart thermostat** features a sleek, versatile design with a mirror finish, and third-party integration with popular voice and home assistants to easily include floor warming into your smart home capabilities. Works with Apple Home, Google Home, and Alexa. Download the Schluter Smart Thermostat app to get convenient, remote access to your DITRA-HEAT floor warming system. The DITRA-HEAT-E-RS1 thermostat controls both the 120 V and 240 V DITRA-HEAT-E-HK heating cables. It features a Class A (5 mA) built-in ground fault circuit interrupter (GFCI) with indicator light and has an electrical current limit of 15 amps.



RS1

Schluter®-DITRA-HEAT-E-RS1		
Smart digital floor thermostat		
Item No.	Description	\$ / Unit
DHE RT 105/BW	Smart thermostat with Wi-Fi, app, & voice control	349.00



Certified to the following standards: UL 60730-1, UL 60730-2-9, UL 943, CAN/CSA E60730-1, CAN/CSA-E60730-2-9, CSA C22.2 No.144.1



**Schluter®-DITRA-HEAT-E-RRS**

**Schluter®-DITRA-HEAT-E-RRS** is a power module specifically designed for the DITRA-HEAT-E-RS1 smart thermostat. The power module may be used when the heating load exceeds 15 amps (e.g., in large floor applications) to maintain a single point of control. Features an input and output voltage of 120 V, 208 V, or 240 V, and a control input from the thermostat of 24 Vdc. The power module also includes a built-in class A GFCI.

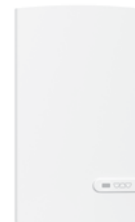

Schluter®-DITRA-HEAT-E-RRS		
Power module		
Item No.	Description	\$ / Unit
DHE RR 2/BW	Power module	186.00



Certified to the following standards: UL 60730-1, UL 60730-2-9, UL 943, CAN/CSA E60730-1, CAN/CSA-E60730-2-9, CSA C22.2 No.144.1



# Schluter®-Shower System

Complete waterproofing system for tiled showers

Schluter Systems provides an integrated family of products in which the individual components collectively form a bonded watertight assembly. The Schluter-Shower System eliminates the risk of failures due to both vapor and water penetration, is maintenance-free, and dramatically reduces total installation time.





# Waterproofing

Waterproofing membranes provide protection—and peace-of-mind—behind your shower walls and other tiled elements subject to moisture.

KERDI and KERDI-DS are pliable, sheet-applied, bonded waterproof membranes and vapor retarders with limited crack-bridging capabilities. Accessories made out of KERDI, including waterproofing strips, seamless corners, and pipe and mixing valve seals help complete the waterproofing process to ensure that your shower or bath surround is well-protected against mold and mildew.

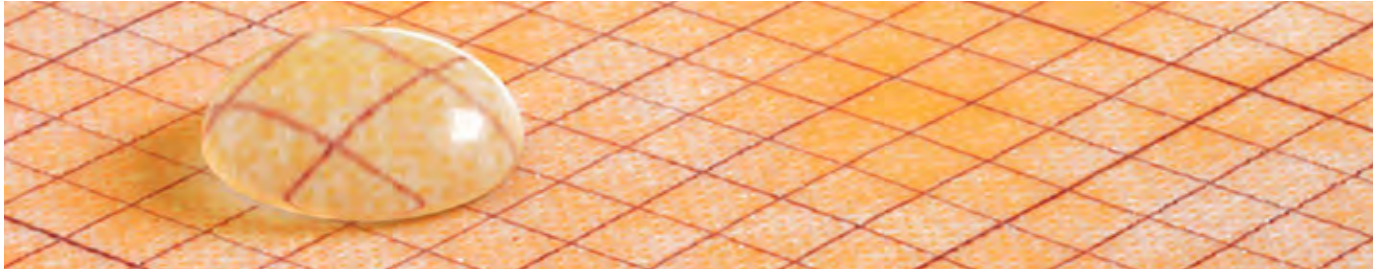

## Schluter®-KERDI and Schluter®-KERDI-DS

**Schluter®-KERDI** is a pliable sheet-applied polyethylene waterproofing membrane and vapor retarder that guarantees uniform thickness. It is covered with an anchoring fleece on both sides to anchor the membrane in thin-set mortar and is suitable for waterproofing in conjunction with tiled surfaces on walls and floors. KERDI is 8-mil thick and has a water vapor permeance of 0.90 perms, when tested according to ASTM E96, using Procedure E at 90% relative humidity.

**Schluter®-KERDI-DS** is a bonded waterproofing membrane and vapor retarder with very low water vapor permeance for use in continuous use steam rooms and similar applications. KERDI-DS is 20-mil thick and features additives to produce a water vapor permeance of 0.19 perms, when tested according to ASTM E96, using Procedure E at 90% relative humidity.

KERDI and KERDI-DS meet the American National Standard for Load Bearing, Bonded, Waterproof Membranes for Thin-Set Ceramic Tile and Dimension Stone Installations (ANSI A118.10). The membranes are listed by cUPC® and evaluated by ICC-ES (Report Nos. ESR-2467 and PMG-1204).

KERDI and KERDI-DS have been evaluated according to the "Standard Method for the Testing and Evaluation of Volatile Organic Chemical Emissions from Indoor Sources Using Environmental Chambers, Version 1.1" for California Specification 01350 and found to comply with the VOC requirements. California Specification 01350 is referenced by various green building standards and rating systems.

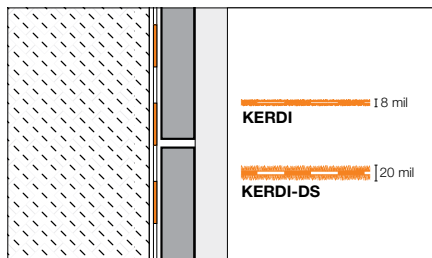

**Note:** 1 mil = 1 one-thousandth of an inch

Schluter®-KERDI				
Waterproofing membrane				
Item No.	Dimensions	\$ / ft² *	\$ / Roll	
<b>Roll width: 1 m - 3' 3"</b>				
KERDI 200/5M	1 m x 5 m = 5 m² - 3' 3" x 16' 5" = 54 ft²	2.35	127.08	
KERDI 200/7M	1 m x 7 m = 7 m² - 3' 3" x 23' = 75 ft²	2.32	174.05	
KERDI 200/10M	1 m x 10 m = 10 m² - 3' 3" x 33' = 108 ft²	2.28	246.75	
KERDI 200/20M	1 m x 20 m = 20 m² - 3' 3" x 65' 7" = 215 ft²	2.19	471.57	
KERDI 200	1 m x 30 m = 30 m² - 3' 3" x 98' 5" = 323 ft²	2.06	664.85	
<b>Roll width: 2 m - 6' 7"</b>				
KERDI 200200/15M	2 m x 15 m = 30 m² - 6' 7" x 49' 2-1/2" = 323 ft²	2.06	664.85	
KERDI 200200	2 m x 30 m = 60 m² - 6' 7" x 98' 5" = 646 ft²	1.97	1,273.83	

Schluter®-KERDI-DS				
Waterproofing membrane				
Item No.	Dimensions	\$ / ft² *	\$ / Roll	
KERDI-DS	1 m x 30 m = 30 m² - 3' 3" x 98' 5" = 323 ft²	2.73	880.27	

\* The price per square foot is for estimation purposes only. Please order using the price per roll.



**Schluter®-SET, Schluter®-ALL-SET, and Schluter®-FAST-SET**  
See page 176



**Schluter®-KERDI-TROWEL**  
See page 179

### Schluter®-KERDI-BAND

**Schluter®-KERDI-BAND** is a waterproofing strip used to seal butt joints and floor/wall connections with the Schluter®-KERDI, DITRA, and DITRA-HEAT membranes, as well as joints, corners, and fastener penetrations with the Schluter®-KERDI-BOARD building panels.

**Note:** 1 mil = 1 one-thousandth of an inch

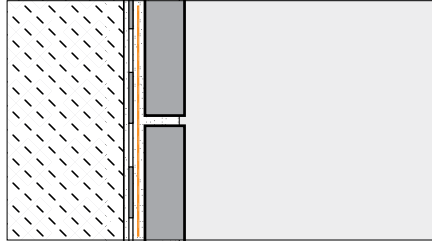

Schluter®-KERDI-BAND					
Waterproofing strip					
Item No.	Width	Length	Thickness	\$/ft*	\$/Roll
<b>125 mm - 5" width</b>					
KEBA 100/125/5M	125 mm - 5"	5 m - 16' 5"	4 mil	1.40	23.01
KEBA 100/125/10M	125 mm - 5"	10 m - 33'	4 mil	1.32	43.71
KEBA 100/125	125 mm - 5"	30 m - 98' 5"	4 mil	1.10	108.01
KEBA100/125/300	125 mm - 5"	300 m - 984' 3"	4 mil	0.99	972.16
<b>185 mm - 7-1/4" width</b>					
KEBA 100/185/5M	185 mm - 7-1/4"	5 m - 16' 5"	4 mil	1.84	30.14
KEBA 100/185	185 mm - 7-1/4"	30 m - 98' 5"	4 mil	1.52	149.32
<b>250 mm - 10" width</b>					
KEBA 100/250/5M	250 mm - 10"	5 m - 16' 5"	4 mil	2.29	37.56
KEBA 100/250	250 mm - 10"	30 m - 98' 5"	4 mil	1.95	191.99

\* The price per foot is for estimation purposes only. Please order using the price per roll.

### Schluter®-KERDI-KERECK-F

**Schluter®-KERDI-KERECK-F** are preformed, seamless corners made of Schluter®-KERDI for waterproofing inside and outside corners.

**Note:** 1 mil = 1 one-thousandth of an inch

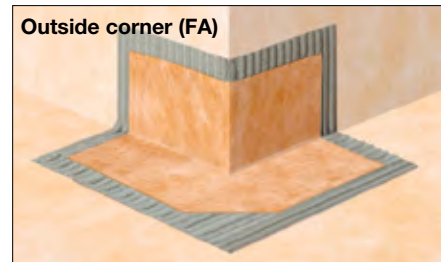
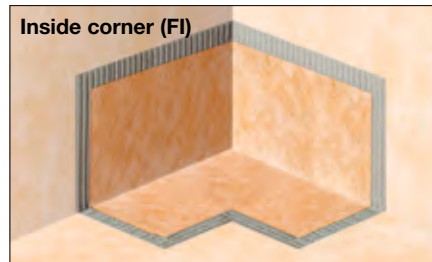

Schluter®-KERDI-KERECK-F			
Waterproofing for 90° corners			
Item No.	Thickness	Packaging	\$/Package
KERECK/FI 2	4 mil	2 Inside corners	17.76
KERECK/FA 2	4 mil	2 Outside corners	17.76
<b>Waterproofing for 135° corners</b>			
KERECK 135 FI 2	4 mil	2 Inside corners	19.68

Schluter®-KERDI-KERECK-F			
Waterproofing for 90° corners			
Item No.	Thickness	Packaging	\$/Package
KERECK/FI 10	4 mil	10 Inside corners	84.54
KERECK/FA 10	4 mil	10 Outside corners	84.54
<b>Waterproofing for 135° corners</b>			
KERECK 135 FI 10	4 mil	10 Inside corners	93.42



**Schluter®-KERDI-KERS-B**

Schluter®-KERDI-KERS-B are preformed, seamless corners for waterproofing 135° angles between triangular shower benches and walls or for curb corners in neo-angle shower applications.

**Note:** 1 mil = 1 one-thousandth of an inch



Schluter®-KERDI-KERS-B				
Waterproofing corners				
Item No.	Thickness	Description	Packaging	\$ / Package
KERECK 135 FI 2	4 mil	Inside corner, 135°	2 units	19.68
KERECK 135 FI 10	4 mil	Inside corner, 135°	10 units	93.42
KERSB 135 K LR	4 mil	Outside corner, 135°	1 right and 1 left	41.50
KERSB 135 K 5LR	4 mil	Outside corner, 135°	5 right and 5 left	197.06
KERSB 135 K	4 mil	Bench/neo-angle corner kit	1 right and 1 left 135° outside corner, and 2 135° inside corners	61.15

**Schluter®-KERDI-KERS**

Schluter®-KERDI-KERS are preformed, seamless corners made of Schluter®-KERDI for waterproofing floor/wall/shower base connections in curbless shower applications where the Schluter®-KERDI-LINE linear drain is installed adjacent to the wall.

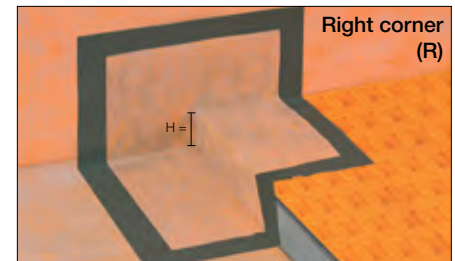
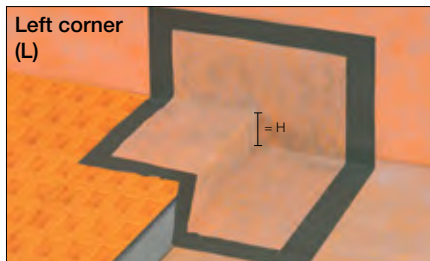

Schluter®-KERDI-KERS				
Waterproofing for corners				
Item No.	H = mm - in.	Thickness	Description	\$ / Unit
KERS 20 L	20 - 3/4	4 mil	Left inside corner	23.87
KERS 28 L	28 - 1-3/32	4 mil	Left inside corner	23.87
KERS 20 R	20 - 3/4	4 mil	Right inside corner	23.87
KERS 28 R	28 - 1-3/32	4 mil	Right inside corner	23.87

**Schluter®-KERDI-SEAL-PS/-MV**

**Schluter®-KERDI-SEAL-PS/-MV** prefabricated seals are cut sections of the Schluter®-KERDI waterproofing membrane designed to seal protrusions through the Schluter®-KERDI or Schluter®-DITRA/DITRA-XL, as well as Schluter®-KERDI-BOARD building panels. Schluter®-KERDI-SEAL-PS and -MV feature overmolded rubber gaskets and are used to seal pipe protrusions and protect moisture-sensitive solid backing panels at the mixing valve.

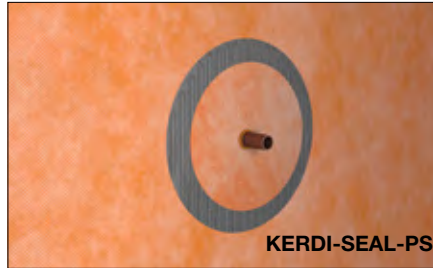

KERDI-SEAL-PS

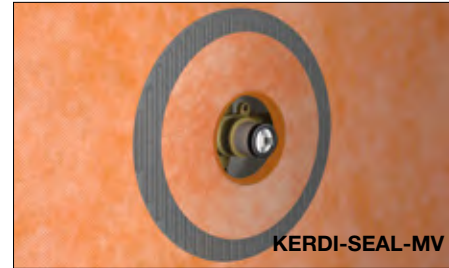

KERDI-SEAL-MV

**Note:** 1 mil = 1 one-thousandth of an inch

**Schluter®-KERDI-SEAL-PS****Pipe seal with overmolded rubber gasket**

Item No.	Pipe nipple opening diam.	Thickness	Packaging	\$ / Package
KMS172/12	12.5 mm - <b>1/2"</b>	4 mil	1 unit	<b>8.75</b>
KMS172/20	20 mm - <b>3/4"</b>	4 mil	1 unit	<b>8.75</b>
KMS10172/12	12.5 mm - <b>1/2"</b>	4 mil	10 units	<b>78.72</b>
KMS10172/20	20 mm - <b>3/4"</b>	4 mil	10 units	<b>78.72</b>

**Schluter®-KERDI-SEAL-MV****Mixing valve seal with overmolded rubber gasket**

Item No.	Mixing valve opening diam.	Thickness	Packaging	\$ / Package
KMSMV235/114	114 mm - <b>4-1/2"</b>	4 mil	1 unit	<b>10.09</b>
KMSMV10235/114	114 mm - <b>4-1/2"</b>	4 mil	10 units	<b>90.84</b>

**Schluter®-KERDI-KM**

**Schluter®-KERDI-KM** prefabricated seal is cut sections of the Schluter®-KERDI waterproofing membrane designed to seal protrusions through the KERDI or Schluter®-DITRA/DITRA-XL membranes. KERDI-KM is designed to be used in conjunction with Schluter®-KERDI-FIX or equivalent sealant to seal around pipes or other similar elements.

**Schluter®-KERDI-KM****Pipe seal**

Item No.	Pipe nipple opening diam.	Thickness	Packaging	\$ / Package
KM5117/22	22 mm - <b>7/8"</b>	4 mil	5 units	<b>10.30</b>





# Schluter®-KERDI-DRAIN

Point drain with integrated bonding flange



Schluter®-KERDI-DRAIN is a shower drain with an integrated bonding flange that provides a large contact area for a secure connection to the KERDI waterproofing membrane at the top of the assembly. The grate assembly can be seamlessly adjusted to the thickness and layout of the ceramic tile or stone covering. KERDI-DRAIN is available with several grate designs, including a frameless tileable covering support, and offered in six TRENDLINE colors to match with Schluter®-SHELF (page 158), trim profiles, and fixtures.



## Schluter®-KERDI-DRAIN and Schluter®-KERDI-DRAIN-H

**Schluter®-KERDI-DRAIN** and **Schluter®-KERDI-DRAIN-H** are floor drains with an integrated bonding flange that provides a large contact area for a secure connection to the Schluter®-KERDI waterproofing membrane at the top of the assembly. Both KERDI-DRAIN and KERDI-DRAIN-H are appropriate for both mortar bed and Schluter®-KERDI-SHOWER-T/-TS/-TT shower tray applications. The bonding flange is sloped to simplify installation of the mortar bed.

The KERDI-DRAIN flange provides a vertical connection to the drain pipe and is available in ABS or PVC with a 2" or 3" (50 or 75 mm) outlet, and stainless steel with a 2" or 3" (50 or 75 mm) no-hub outlet or 2" (50 mm) threaded outlet.

The KERDI-DRAIN-H flange provides a horizontal connection to the drain pipe and is available in ABS or PVC with a 2" (50 mm) outlet. It is ideal for applications where the use of a vertical connection to the drain pipe is not possible or practical (e.g., suspended or post-tension concrete floors, basement slabs, or wood floor installations where relocating the hole in the floor is not practical). The horizontal outlet allows the positioning of the drain in the desired area regardless of drain pipe location.

A compensation board is available for use with KERDI-DRAIN-H in conjunction the KERDI-SHOWER-T/-TS/-TT shower trays.

KERDI-DRAIN and KERDI-DRAIN-H feature a fully adjustable grate (available in stainless steel and anodized aluminum in various finishes) that accommodates a wide range of tile thicknesses: 1/4" (6 mm) to 1-1/4" (32 mm); or a tileable covering support that accommodates any tile thickness and creates a virtually invisible drainage line. The grate assembly allows lateral and tilt adjustment as well. Please note that grate assemblies used with the plastic KERDI-DRAIN featuring 3" (75 mm) outlets only allow vertical and tilt adjustment (no lateral adjustment). 6" (150 mm)-square stainless steel covers are also available for installations where KERDI-DRAIN or KERDI-DRAIN-H are to be used in a cleanout application.

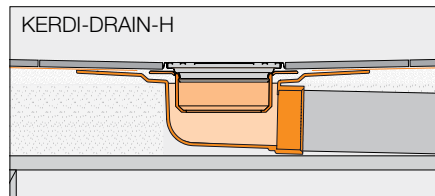
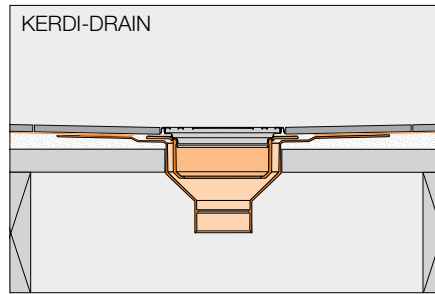



## Selecting your Schluter®-KERDI-DRAIN

Schluter®-KERDI-DRAIN flanges and grates are sold separately.

**1** Select your grate from pages 130-133.

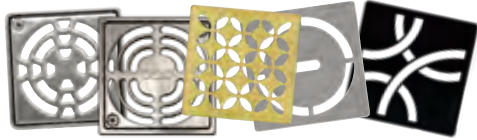

**2** Select the flange appropriate for your application from the tables on pages 134-137.



- When using a flange with a 3" (75 mm) outlet, a 6" (150 mm) grate is recommended.
- When using the KERDI-DRAIN-F flange or the KERDI-DRAIN-A flange with 5-1/4" (133.4 mm) adaptor ring, the 4" (100 mm) tileable grate and 6" (150 mm) round and square grates are not suitable.

Schluter®-KERDI-DRAIN - Listings and Certifications									
Flanges	Grates	Grate - 4" (100 mm)				Grate - 6" (150 mm)			
		CLASSIC Stainless steel (All finishes except EOB)	CLASSIC Stainless steel EOB	CONTOUR Anodized aluminum (All finishes)	TILE	STYLE PURE, CURVE and FLORAL Stainless steel (All finishes)	Stainless steel		
							Square 6E	Round 6RE	Cover 6CE
2" (50 mm) PVC		1	-	1	1	1	1	2	
2" (50 mm) ABS		1	-	1	1	1	1	2	
2" (50 mm) PVC Horizontal		1	-	1	1	1	1	2	
2" (50 mm) ABS Horizontal		1	-	1	1	1	1	2	
2" (50 mm) Stainless steel		1	-	1	1	1	1	2	
2" (50 mm) Stainless steel Threaded		1	-	1	1	1	1	2	
3" (75 mm) PVC		-	-	-	-	1	1	2	
3" (75 mm) ABS		-	-	-	-	1	1	2	
3" (75 mm) Stainless steel		-	-	-	-	1	1	2	
5-1/4" (133.4 mm) Adaptor		-	-	-	-	-	-	-	
7-1/2" (191 mm) Adaptor		-	-	-	-	-	-	-	

Various configurations of KERDI-DRAIN are listed by ICC-ES (Report No. PMG-1204), UPC® and CSA as shown in the table above.

**1** - Listed by ICC-ES (Report No. PMG-1204), UPC® and CSA.

**2** - Listed by CSA

For copies of these documents, please contact Schluter®-Systems at 800-472-4588 or by email at info@schluter.com. Links to the documents can also be accessed at www.schluter.com.



**GRATES FOR USE WITH FLANGES WITH 2" (50 MM) OUTLET**

Schluter®-KERDI-DRAIN-STYLE - Metallic finishes

Stainless Steel





PURE		100 mm - 4"
Grate finish	Item No.	\$ / Unit
Brushed stainless steel (EB)	KDIF4 GRK EB D8	100.04
Brushed nickel (EBT)	KDIF4 GRK EBT D8	157.68
Brushed rose gold (EBRG)	KDIF4 GRK EBRG D8	157.68
Brushed vintage gold (EBVG)	KDIF4 GRK EBVG D8	157.68
Brushed classic gold (EBCG)	KDIF4 GRK EBCG D8	157.68

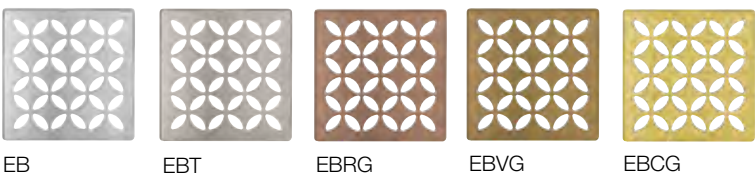

CURVE		100 mm - 4"
Grate finish	Item No.	\$ / Unit
Brushed stainless steel (EB)	KDIF4 GRK EB D6	100.04
Brushed nickel (EBT)	KDIF4 GRK EBT D6	157.68
Brushed rose gold (EBRG)	KDIF4 GRK EBRG D6	157.68
Brushed vintage gold (EBVG)	KDIF4 GRK EBVG D6	157.68
Brushed classic gold (EBCG)	KDIF4 GRK EBCG D6	157.68



FLORAL		100 mm - 4"
Grate finish	Item No.	\$ / Unit
Brushed stainless steel (EB)	KDIF4 GRK EB D5	100.04
Brushed nickel (EBT)	KDIF4 GRK EBT D5	157.68
Brushed rose gold (EBRG)	KDIF4 GRK EBRG D5	157.68
Brushed vintage gold (EBVG)	KDIF4 GRK EBVG D5	157.68
Brushed classic gold (EBCG)	KDIF4 GRK EBCG D5	157.68

Contents	
	<b>1x</b> Grate and frame
	<b>1x</b> Height adjustment collar
	<b>1x</b> Lateral adjustment ring



**GRATES FOR USE WITH FLANGES WITH 2" (50 MM) OUTLET**

**Schluter®-KERDI-DRAIN-STYLE - TRENDLINE**

Stainless Steel



MBW TSC TSBG TSSG TSOB MGS

PURE		100 mm - 4"
Grate finish	Item No.	\$ / Unit
Matte white (MBW)	KDIF4 GRK MBW D8	157.68
Cream (TSC)	KDIF4 GRK TSC D8	157.68
Greige (TSBG)	KDIF4 GRK TSBG D8	157.68
Stone grey (TSSG)	KDIF4 GRK TSSG D8	157.68
Bronze (TSOB)	KDIF4 GRK TSOB D8	157.68
Matte black (MGS)	KDIF4 GRK MGS D8	157.68





MBW TSC TSBG TSSG TSOB MGS

CURVE		100 mm - 4"
Grate finish	Item No.	\$ / Unit
Matte white (MBW)	KDIF4 GRK MBW D6	157.68
Cream (TSC)	KDIF4 GRK TSC D6	157.68
Greige (TSBG)	KDIF4 GRK TSBG D6	157.68
Stone grey (TSSG)	KDIF4 GRK TSSG D6	157.68
Bronze (TSOB)	KDIF4 GRK TSOB D6	157.68
Matte black (MGS)	KDIF4 GRK MGS D6	157.68

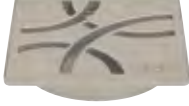

MBW TSC TSBG TSSG TSOB MGS

FLORAL		100 mm - 4"
Grate finish	Item No.	\$ / Unit
Matte white (MBW)	KDIF4 GRK MBW D5	157.68
Cream (TSC)	KDIF4 GRK TSC D5	157.68
Greige (TSBG)	KDIF4 GRK TSBG D5	157.68
Stone grey (TSSG)	KDIF4 GRK TSSG D5	157.68
Bronze (TSOB)	KDIF4 GRK TSOB D5	157.68
Matte black (MGS)	KDIF4 GRK MGS D5	157.68

Contents	
	<b>1x</b> Grate and frame
	<b>1x</b> Height adjustment collar
	<b>1x</b> Lateral adjustment ring



**GRATES FOR USE WITH FLANGES WITH 2" (50 MM) OUTLET**

Schluter®-KERDI-DRAIN

Stainless Steel



CLASSIC		100 mm - 4"		
Grate finish	1 UNIT		10-PACKS*	
	Item No.	\$ / Unit	Item No.	\$ / 10-Pack
Stainless steel (E)	KD4 GRK E	61.33	KD4 GRK E 10	551.89
Chrome (EP)	KD4 GRK EP	61.33	-	-
Oil-rubbed bronze (EOB)	KD4 GRK EOB	86.03	-	-
Nickel (ET)	KD4 GRK ET	99.28	-	-
Rose gold (ERG)	KD4 GRK ERG	99.28	-	-
Vintage gold (EVG)	KD4 GRK EVG	99.28	-	-
Classic gold (ECG)	KD4 GRK ECG	99.28	-	-

\*Note: 10-packs are packaged in bulk, not individually boxed.

Anodized Aluminum



CONTOUR		100 mm - 4"	
Grate finish	Item No.	\$ / Unit	
Brushed nickel (ATGB)	KD4 GRK ATGB	86.03	
Brushed copper (AKGB)	KD4 GRK AKGB	86.03	
Brushed brass (AMGB)	KD4 GRK AMGB	86.03	

**Contents**

- 1x** Grate and frame
- 1x** Height adjustment collar
- 1x** Lateral adjustment ring

Tileable Grate



TILE		100 mm - 4"	
Grate finish	Item No.	\$ / Unit	
TILE	KD4 GRK ECS	61.33	

**Contents**

- 1x** Tileable covering support
- 1x** Spacer
- 1x** Lateral adjustment ring



The tileable grate is not suitable for use with the KERDI-DRAIN-F flange and the KERDI-DRAIN-A flange with 5-1/4" (133.4 mm) adaptor ring.



**GRATES FOR USE WITH FLANGES WITH 2" (50 MM) or 3" (75 MM) OUTLET**

Schluter®-KERDI-DRAIN

Stainless Steel



CLASSIC SQUARE		150 mm - 6"
Grate finish	Item No.	\$ / Unit
Stainless steel (E)	KD6 GRK E	82.23

CLASSIC ROUND		150 mm - 6"
Grate finish	Item No.	\$ / Unit
Stainless steel (E)	KD6 GRK RE	82.23

Contents



**1x**  
Grate and frame  
with integrated height  
adjustment collar



**1x**  
Lateral  
adjustment ring

**i**

The 6" (150 mm) grates are not suitable for use with the KERDI-DRAIN-F flange and the KERDI-DRAIN-A flange with 5-1/4" (133.4 mm) adaptor ring.



Schluter®-KERDI-DRAIN PURE grate in greige (page 131)



## FLANGE KITS WITH SEALS AND CORNERS

### Schluter®-KERDI-DRAIN

#### Schluter®-KERDI-DRAIN - Flanges with vertical outlet



Material	Outlet	1 UNIT		10-PACKS*	
		Item No.	\$ / Unit	Item No.	\$ / 10-Pack
ABS	50 mm - 2"	KD2 FLK ABS	86.78	KD2 FLK ABS 10	781.05
ABS	75 mm - 3"	KD3 FLK ABS	98.10	-	-
PVC	50 mm - 2"	KD2 FLK PVC	86.78	KD2 FLK PVC 10	781.05
PVC	75 mm - 3"	KD3 FLK PVC	98.10	-	-
Stainless Steel	50 mm - 2" no-hub	KD2 FLK E	249.09	-	-
Stainless Steel	50 mm - 2" threaded	KD2 FLK ETH	277.15	-	-
Stainless Steel	75 mm - 3" no-hub	KD3 FLK E	249.09	-	-

\*Note: 10-packs are packaged in bulk, not individually boxed.

### Schluter®-KERDI-DRAIN-H

#### Schluter®-KERDI-DRAIN-H - Flanges with horizontal outlet



Material	Outlet	1 UNIT	
		Item No.	\$ / Unit
ABS	50 mm - 2"	KDH2 FLK ABS	86.78
PVC	50 mm - 2"	KDH2 FLK PVC	86.78

#### Additional components included with all flanges



**4x**  
Inside corners



**2x**  
Outside corners



**1x**  
Pipe seal  
(20 mm - 3/4")



**1x**  
Mixing valve seal  
(114 mm - 4-1/2")

#### Also included with stainless steel flanges



**1x**  
KERDI-FIX  
sealing and bonding compound (100 ml - 3.38 fl oz)

**⚠ WARNING:** Reproductive Harm  
[www.P65Warnings.ca.gov](http://www.P65Warnings.ca.gov)



When using a flange with 3" (75 mm) outlet, a 6" (150 mm) grate is recommended.





## FLANGE MEASUREMENTS

### Schluter®-KERDI-DRAIN

#### ABS or PVC

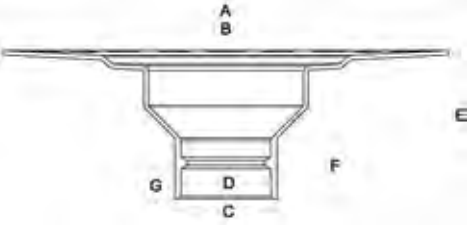
	50 mm - 2" drain outlet	75 mm - 3" drain outlet
		
A	300 mm - 11-13/16"	300 mm - 11-13/16"
B	115.2 mm - 4-17/32"	115.2 mm - 4-17/32"
C	68.6 mm - 2-45/64"	100 mm - 3-15/16"
D	60.5 mm - 2-3/8"	88.8 mm - 3-1/2"
E	100 mm - 3-15/16"	100 mm - 3-15/16"
F	40.6 mm - 1-39/64"	50.8 mm - 2"
G	22.5 mm - 7/8"	38.1 mm - 1-1/2"

#### Stainless steel

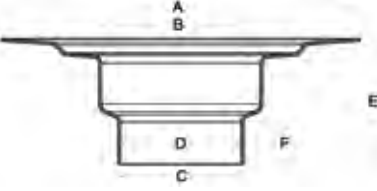
	50 mm - 2" no-hub outlet	75 mm - 3" no-hub outlet
		
A	250 mm - 9-27/32"	250 mm - 9-27/32"
B	115.4 mm - 4-1/2"	114 mm - 4-1/2"
C	61.3 mm - 2-13/32"	87.4 mm - 3-7/16"
D	60.6 mm - 2-13/32"	84.2 mm - 3-5/16"
E	85 mm - 3-11/32"	87.4 mm - 3-7/16"
F	21 mm - 53/64"	29.4 mm - 1-5/32"

### Schluter®-KERDI-DRAIN-H

#### ABS or PVC

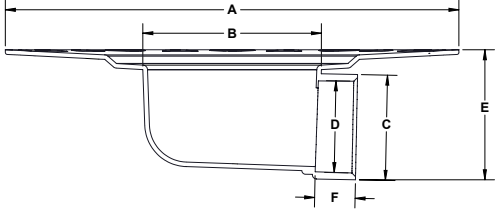
	50 mm - 2" horizontal drain outlet
	
A	300 mm - 11-13/16"
B	118.3 mm - 4-21/32"
C	69.5 mm - 2-47/64"
D	60.5 mm - 2-3/8"
E	85.7 mm - 3-3/8"
F	27 mm - 1-1/16"

### Schluter®-KERDI-SHOWER-CB

**Schluter®-KERDI-SHOWER-CB** is a height compensation board made of lightweight expanded polystyrene used to accommodate the drain body and waste pipe height, when installing the Schluter®-KERDI-DRAIN-H in conjunction with the Schluter®-KERDI-SHOWER-T/TS/TT shower trays. The compensation board can easily be cut to size to fit around the drain and waste pipe, and multiple boards can be used to fit the size and shape of the shower.

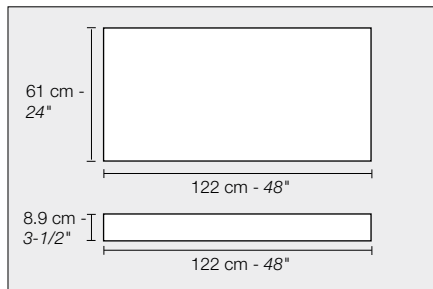

#### Schluter®-KERDI-SHOWER-CB

##### Compensation board

Item No.	Dimensions	\$ / Unit
KSCB 90 610 1220	122 cm x 61 cm x 8.9 cm - 48" x 24" x 3-1/2"	104.55



**ADAPTOR KITS — 5-1/4" or 7-1/2" (133.4 or 191 mm)**

**Schluter®-KERDI-DRAIN-A**

**Schluter®-KERDI-DRAIN-A ADAPTOR KITS** are used to convert traditional clamping ring drains to integrated bonding flange drains when removal of the clamping ring drain is not practical. A stainless steel adaptor ring with an overmolded rubber gasket replaces the clamping ring and is sealed to the existing drain body using Schluter®-KERDI-FIX. The bonding flange then slides into the adaptor ring and seals against the rubber gasket. Adaptor kits are suitable for both mortar bed and Schluter®-KERDI-SHOWER-T/-TS/-TT shower tray applications.

133.4 mm - 5-1/4" adaptor kit		
Flange and ring	1 UNIT	
	Item No.	\$ / Unit
<p>133.4 mm 5-1/4"</p> <p><b>Also included:</b> Height adjustment collar for KERDI-DRAIN grate</p>	KDA5 FLK ABS	86.78
	10-PACK*	
	Item No.	\$ / 10-Pack
	KDA5 FLK ABS 10	781.05

191 mm - 7-1/2" adaptor kit		
Flange and ring	1 UNIT	
	Item No.	\$ / Unit
<p>191 mm 7-1/2"</p> <p><b>Also included:</b> Lateral adjustment ring for KERDI-DRAIN grate</p>	KDA7 FLK ABS	119.01
	Item No.	\$ / 10-Pack
	KDA7 FLK ABS 10	781.05

\*Note: 10-packs are packaged in bulk, not individually boxed.

**Additional components included**

	<b>4x</b> Inside corners		<b>2x</b> Outside corners		<b>1x</b> Pipe seal (20 mm - 3/4")		<b>1x</b> Mixing valve seal (114 mm - 4-1/2")		<b>1x</b> KERDI-FIX sealing and bonding compound (100 ml - 3.38 fl oz)
--	-----------------------------	--	------------------------------	--	--	--	---	--	---

**WARNING:**  
Reproductive Harm  
[www.P65Warnings.ca.gov](http://www.P65Warnings.ca.gov)

Flange and adaptor ring measurements	
	133.4 mm - 5-1/4"
	A 300 mm - 11-13/16"
	B 60.7 mm - 2-13/32"
	C 69.3 mm - 2-23/32"
	D 133.4 mm - 5-1/4"
	E 74 mm - 2-29/32"
	F 25.9 mm - 1-1/64"
	G 52.6 mm - 2-1/16"

Flange and adaptor ring measurements	
	191 mm - 7-1/2"
	A 300 mm - 11-13/16"
	B 111.8 mm - 4-13/32"
	C 118.9 mm - 4-11/16"
	D 191 mm - 7-1/2"
	E 130 mm - 5-7/64"
	F 77.8 mm - 3-1/16"
	G 92.4 mm - 3-41/64"



The tileable grate and the 6" (150 mm) round/square grates are not compatible with the flange with 5-1/4" (133.4 mm) adaptor ring.



## FLANGE KITS WITHOUT SEALS AND CORNERS

### Schluter®-KERDI-DRAIN

#### Schluter®-KERDI-DRAIN - Flanges with vertical outlet



ABS



PVC



Stainless steel

Material	Outlet	1 UNIT		10-PACKS*	
		Item No.	\$ / Unit	Item No.	\$ / 10-Pack
ABS	50 mm - 2"	KD2/ABS/FL	30.22	KD2/ABS/FL10	271.94
ABS	75 mm - 3"	KD3/ABS/FL	41.54	-	-
PVC	50 mm - 2"	KD2/PVC/FL	30.22	KD2/PVC/FL10	271.94
PVC	75 mm - 3"	KD3/PVC/FL	41.54	-	-
Stainless Steel	50 mm - 2" no-hub	KD2/E/FL	204.65	KD2/E/FL10	1,671.81
Stainless Steel	50 mm - 2" threaded	KD2/ETH/FL	208.47	-	-
Stainless Steel	75 mm - 3" no-hub	KD3/E/FL	204.65	-	-

**\*Notes:**

- 10-packs are packaged in bulk, not individually boxed.
- The stainless steel flange 10-pack does not include KERDI-FIX.

#### Also included with stainless steel flanges



**1x**

KERDI-FIX  
sealing and bonding compound (100 ml - 3.38 fl oz)  
**(not included with 10-pack)**

**⚠ WARNING:** Reproductive Harm  
[www.P65Warnings.ca.gov](http://www.P65Warnings.ca.gov)



When using a flange with 3" (75 mm) outlet,  
a 6" (150 mm) grate is recommended.

### Schluter®-KERDI-DRAIN-H

#### Schluter®-KERDI-DRAIN-H - Flanges with horizontal outlet



ABS

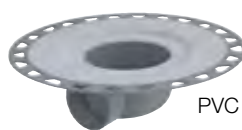

PVC









Material	Outlet	Item No.	\$ / Unit
ABS	50 mm - 2"	KDH2/ABS/FL	30.22
PVC	50 mm - 2"	KDH2/PVC/FL	30.22



## COMPLETE DRAIN KITS









### Schluter®-KERDI-DRAIN

Flange		Grate - 100 mm - 4"		Item No.	\$ / Unit
Material	Outlet	Grate Design	Grate Finish		
ABS	50 mm - 2"	CLASSIC	Stainless steel (E)	KD2/ABS/E	148.10
PVC	50 mm - 2"	CLASSIC	Stainless steel (E)	KD2/PVC/E	148.10

Contents							
	<b>1x</b> Flange		<b>1x</b> Grate and frame		<b>1x</b> Height adjustment collar		<b>1x</b> Lateral adjustment ring
	<b>4x</b> Inside corners		<b>2x</b> Outside corners		<b>1x</b> Pipe seal (20 mm - 3/4")		<b>1x</b> Mixing valve seal (114 mm - 4-1/2")

### Schluter®-KERDI-DRAIN-A

Schluter®-KERDI-DRAIN-A Adaptor Kit – 133.4 mm - 5-1/4"				
Adaptor	Grate - 100 mm - 4"		Item No.	\$ / Unit
Ring Size	Grate Design	Grate Finish		
133.4 mm - 5-1/4"	CLASSIC	Stainless steel (E)	KDAR/ABS/E	148.10

Contents							
	<b>1x</b> Flange		<b>1x</b> Grate and frame		<b>1x</b> Height adjustment collar		<b>1x</b> Adaptor ring
	<b>4x</b> Inside corners		<b>2x</b> Outside corners		<b>1x</b> Pipe seal (20 mm - 3/4")		<b>1x</b> Mixing valve seal (114 mm - 4-1/2")
	<b>1x</b> KERDI-FIX sealing and bonding compound (100 ml - 3.38 fl oz)	<b>⚠ WARNING: Reproductive Harm – <a href="http://www.P65Warnings.ca.gov">www.P65Warnings.ca.gov</a></b>					



## FLOOR DRAIN WITH INTEGRATED KERDI COLLAR

### Schluter®-KERDI-DRAIN-F

**Schluter®-KERDI-DRAIN-F** is a floor drain specifically designed to allow connections to Schluter®-DITRA and DITRA-HEAT uncoupling membranes in floor applications. The drain body is available in polypropylene or stainless steel, each with a laminated Schluter®-KERDI collar that ensures a simple connection to the uncoupling membrane on the floor and at wall transitions. KERDI-DRAIN-F features a flat, narrow bonding flange to allow for placement against walls or in corners. It can be combined with virtually any KERDI-DRAIN grate assembly, with the exception of the tileable grate and the 6" (150 mm) square and round grates. The grate assembly is sold separately, please refer to pages 130-132.

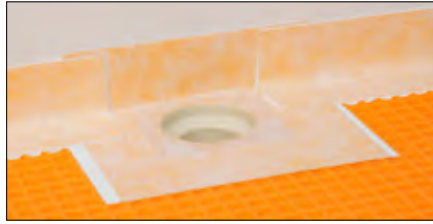

### Schluter®-KERDI-DRAIN-F - Floor drain with narrow bonding flange and integrated KERDI collar

#### Polypropylene



ABS and PVC couplings included

#### Stainless steel with no-hub outlet



#### Stainless steel with threaded outlet

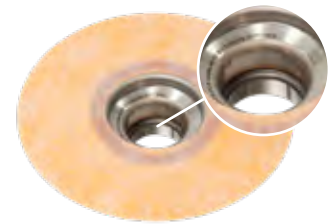

Material	Outlet	Item No.	\$ / Unit
Polypropylene	50 mm - 2" NPT	KDF2FL	52.76
Stainless Steel	50 mm - 2" no-hub	KDF2EFL	239.87
Stainless Steel	50 mm - 2" threaded	KDF2ETHFL	266.97

Listed by ICC-ES (Report No. PMG-1204), UPC® and CSA.

### Additional components included



**1x**

Vertical height adjustment collar



**1x**

Construction cover

**i**

The tileable grate and the 6" (150 mm) round/square grates are not compatible with KERDI-DRAIN-F.

### Drain measurements

<b>Polypropylene 50 mm (2") outlet</b>		<b>Stainless steel 50 mm (2") no-hub outlet</b>		<b>Stainless steel 50 mm (2") threaded outlet</b>	
A	268 mm - 10-9/16"	A	280 mm - 11-1/32"	A	280 mm - 11-1/32"
B	128 mm - 5-1/32"	B	139 mm - 5-15/32"	B	139 mm - 5-15/32"
C	101.1 mm - 3-31/32"	C	98 mm - 3-27/32"	C	98 mm - 3-27/32"
D	75.4 mm - 2-31/32"	D	77.2 mm - 3-1/32"	D	73.7 mm - 2-29/32"
E	3 mm - 1/8"	E	1.5 mm - 1/16"	E	1.5 mm - 1/16"



## Schluter®-KERDI-DRAIN

### 6" SQUARE CLEAN OUT COVER

The **Schluter®-KERDI-DRAIN Clean Out Cover** is a 6" (150 mm) stainless steel cover available for installations where the KERDI-DRAIN bonding flange is to be used in a cleanout application. The KERDI-DRAIN bonding flange is sold separately.



Clean out cover 150 mm - 6"		
Item No.	Finish	\$ / Unit
KD-GR6C-E	Stainless steel	166.24

### TAMPER PROOF SCREWS

**Schluter®-KERDI-DRAIN Tamper Proof Screws** are designed as a high security accessory for the KERDI-DRAIN. Ideal for loss prevention and anti-theft, these tamper proof screws are used in environments where tamper resistance is desired or required (e.g., healthcare or education facilities, etc.). Phillips head screws are included with the KERDI-DRAIN. The tamper-proof screws as well as the driver bit must be purchased separately.



Tamper proof screw and driver bit		
Item No.	Description	\$ / Unit
KD/TPSCRW	Tamper proof screw (1)	2.89
KD/TPWRCH	Driver bit (1)	14.09

### STRAINER

The **Schluter®-KERDI-DRAIN Strainer** is a hair catcher customized to fit inside the KERDI-DRAIN flange to trap and collect hair. Simple to remove and clean, the hair catcher fits discreetly into the drain to prevent hair clogs that can lead to blocked pipes.

**Note:** The KERDI-DRAIN strainer is only suitable for use with flanges with 2" (50 mm) vertical outlets (ABS, PVC, and stainless steel with no-hub or threaded outlet).



Strainer for KERDI-DRAIN		
Item No.	Description	\$ / Unit
KD-STR	Strainer	3.21



# Schluter®-KERDI-LINE & KERDI-LINE-STYLE

Elegant low-profile linear floor drains



Schluter®-KERDI-LINE SQUARE grate  
in matte black (page 145)

The Schluter®-KERDI-LINE low-profile linear drain takes your tiled shower to the next level. KERDI-LINE is available with several grate designs, including a frameless tileable covering support, which virtually disappears in the field tile.



- ✓ Available in multiple lengths
- ✓ Stainless steel channel body
- ✓ Installation adjacent to walls or at intermediate locations
- ✓ Floors can be sloped on single plane, enabling use of large-format tile
- ✓ Suitable for wheelchair accessible showers

## Schluter®-KERDI-LINE

The **Schluter®-KERDI-LINE** is a low profile linear floor drain specifically designed for bonded waterproofing assemblies. KERDI-LINE can be installed adjacent to walls or at intermediate locations in showers, wet rooms, and other applications that require waterproofing and drainage. The floor can be sloped on a single plane to KERDI-LINE, which enables the use of large-format tiles and creates interesting design opportunities.

The KERDI-LINE channel body is made of formed stainless steel 316L (1.4404 = V4A) and features a collar made of Schluter®-KERDI for a secure waterproof connection. The grate assembly is available in six design options:

- A - SOLID
- B - SQUARE
- D - TILE
- E - FLORAL
- F - CURVE
- G - PURE

If KERDI-LINE is placed at shower entrance, it is recommended that grate assembly A (SOLID), G (PURE), or D (TILE) is chosen and that the drainage openings span the maximum width of the shower entrance to limit potential overflow; secondary drainage (e.g., KERDI-DRAIN) may be required in the drying area.

Grate and frame assemblies A and B are available in brushed stainless steel, or stainless steel with chrome finish, and can be adjusted for use with tile coverings from 1/8" to 1" (3 mm to 25 mm)-thick. The TILE grate (D) is frameless and can accommodate any thickness of tile covering. Grate and frame assemblies E, F and G (KERDI-LINE-STYLE) are available in brushed stainless steel and can accommodate tile coverings from 1/4" to 11/16" (6 - 18 mm)-thick.

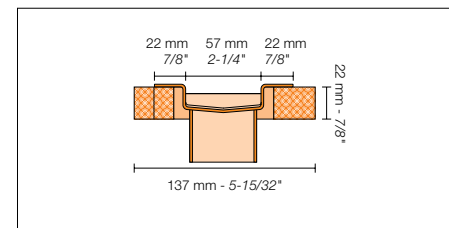
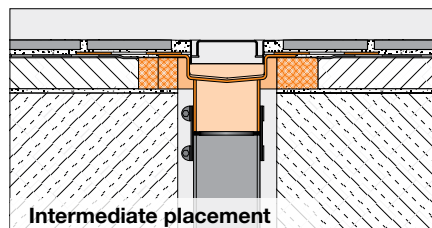
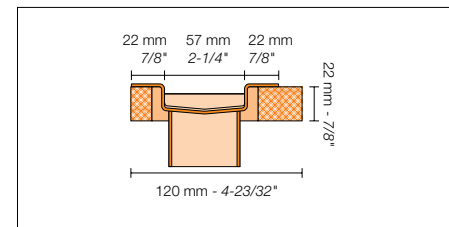
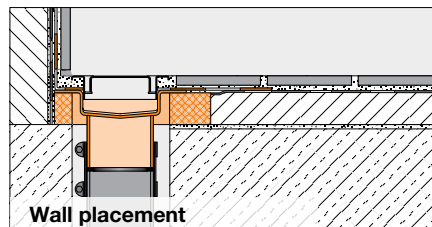
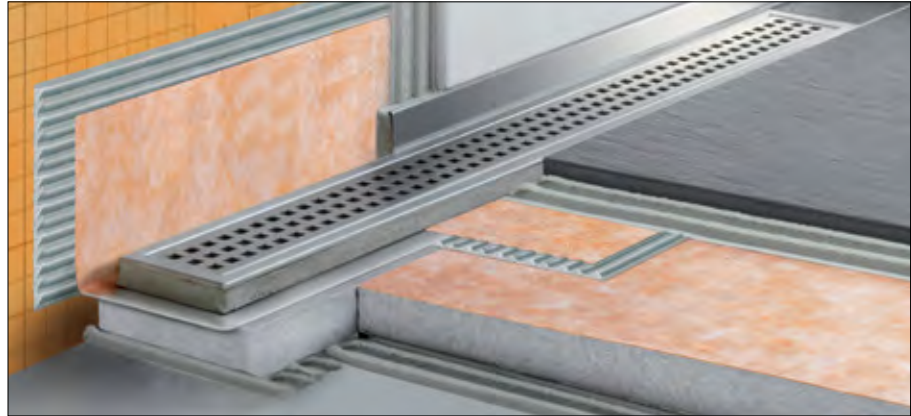

## Selecting your Schluter®-KERDI-LINE

Schluter®-KERDI-LINE channel bodies and grates are sold separately.

- 1 Select the appropriate channel body length and outlet placement from the tables on page 143.
- 2 Proceed to grate selection accordingly from pages 144 to 147, keeping in mind there are two frame height options for the SQUARE and SOLID grates.

**i**

All configurations of KERDI-LINE are listed by ICC-ES (Report No. PMG-1204), UPC®, and CSA. For copies of these documents, please contact Schluter®-Systems at 800-472-4588 or by email at [info@schluter.com](mailto:info@schluter.com). Links to the documents can also be accessed at [www.schluter.com](http://www.schluter.com).





Schluter®-KERDI-LINE

**CHANNEL BODY**

**Contents**

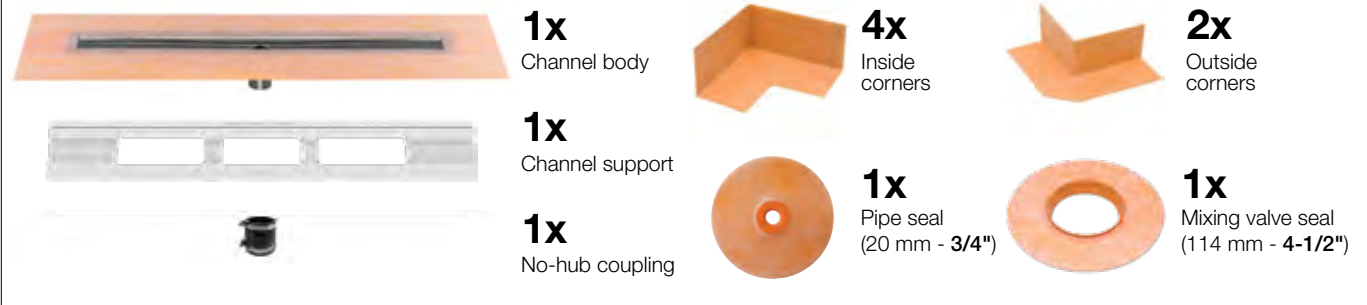

Channel body center outlet

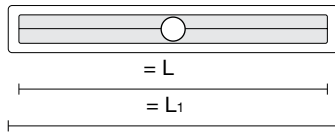

Channel body off-set outlet

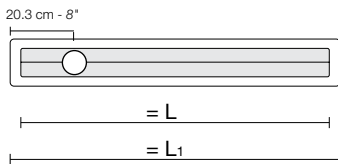

**Schluter®-KERDI-LINE**

**Channel body - stainless steel - center outlet**

L = cm - in.	L <sub>1</sub> = cm - in.	Item No.	\$ / Unit
50 - 19-11/16	55 - 21-11/16	KL1V 60 E 50	351.57
60 - 23-5/8	65 - 25-5/8	KL1V 60 E 60	362.73
70 - 27-9/16	75 - 29-9/16	KL1V 60 E 70	394.00
80 - 31-1/2	85 - 33-1/2	KL1V 60 E 80	397.80
90 - 35-7/16	95 - 37-7/16	KL1V 60 E 90	415.46
100 - 39-3/8	105 - 41-3/8	KL1V 60 E 100	427.06
110 - 43-5/16	115 - 45-5/16	KL1V 60 E 110	435.97
120 - 47-1/4	125 - 49-1/4	KL1V 60 E 120	456.28
130 - 51-3/16	135 - 53-3/16	KL1V 60 E 130	552.92
140 - 55-1/8	145 - 57-1/8	KL1V 60 E 140	566.96
150 - 59-1/16	155 - 61-1/16	KL1V 60 E 150	580.52
160 - 62-15/16	165 - 64-15/16	KL1V 60 E 160	591.78
170 - 66-7/8	175 - 68-7/8	KL1V 60 E 170	601.02
180 - 70-13/16	185 - 72-13/16	KL1V 60 E 180	611.42

**Channel body - stainless steel - off-set outlet**

L = cm - in.	L <sub>1</sub> = cm - in.	Item No.	\$ / Unit
70 - 27-9/16	75 - 29-9/16	KL1VO 60 E 70	398.84
80 - 31-1/2	85 - 33-1/2	KL1VO 60 E 80	402.71
90 - 35-7/16	95 - 37-7/16	KL1VO 60 E 90	421.14
100 - 39-3/8	105 - 41-3/8	KL1VO 60 E 100	448.31
110 - 43-5/16	115 - 45-5/16	KL1VO 60 E 110	466.48
120 - 47-1/4	125 - 49-1/4	KL1VO 60 E 120	488.63



Schluter®-KERDI-LINE

**GRATE ASSEMBLY - BRUSHED STAINLESS STEEL**

**CONTENTS**

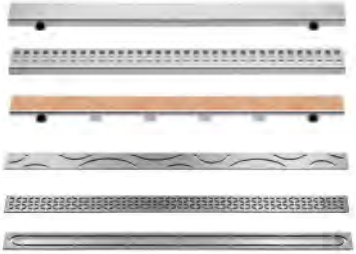

**1x**  
Grate  
6 design options:

- SOLID
- SQUARE
- TILE
- CURVE
- FLORAL
- PURE



**1x**  
Grate frame with height adjustment spacers. See product tables for frame height options (not included with TILE grate).





**SOLID (A)**

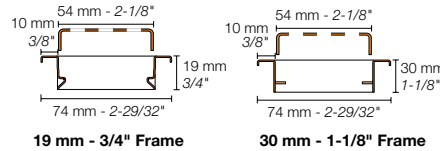
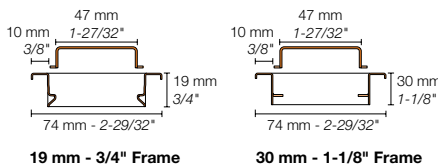

**SQUARE (B)**



Grate assemblies - Brushed stainless steel					
 19 mm - 3/4" frame height for 3 mm to 15 mm - 1/8" to 9/16" -thick coverings					
Length = cm - in.	SOLID (A)		SQUARE (B)		
	Item No.	\$ / Unit	Item No.	\$ / Unit	
50 - 19-11/16	KL1AR 19 EB 50	326.84	KL1B 19 EB 50	297.43	
60 - 23-5/8	KL1AR 19 EB 60	336.21	KL1B 19 EB 60	303.11	
70 - 27-9/16	KL1AR 19 EB 70	350.02	KL1B 19 EB 70	319.87	
80 - 31-1/2	KL1AR 19 EB 80	359.07	KL1B 19 EB 80	325.68	
90 - 35-7/16	KL1AR 19 EB 90	375.95	KL1B 19 EB 90	343.41	
100 - 39-3/8	KL1AR 19 EB 100	398.44	KL1B 19 EB 100	353.34	
110 - 43-5/16	KL1AR 19 EB 110	408.23	KL1B 19 EB 110	365.98	
120 - 47-1/4	KL1AR 19 EB 120	415.61	KL1B 19 EB 120	372.93	
130 - 51-3/16	KL1AR 19 EB 130	541.87	KL1B 19 EB 130	541.87	
140 - 55-1/8	KL1AR 19 EB 140	569.03	KL1B 19 EB 140	569.03	
150 - 59-1/16	KL1AR 19 EB 150	598.85	KL1B 19 EB 150	598.85	
160 - 62-15/16	KL1AR 19 EB 160	637.58	KL1B 19 EB 160	637.58	
170 - 66-7/8	KL1AR 19 EB 170	664.71	KL1B 19 EB 170	664.71	
180 - 70-13/16	KL1AR 19 EB 180	702.80	KL1B 19 EB 180	702.80	
 30 mm - 1-1/8" frame height for 13 mm to 25 mm - 1/2" to 1" -thick coverings					
50 - 19-11/16	KL1AR 30 EB 50	336.26	KL1B 30 EB 50	306.00	
60 - 23-5/8	KL1AR 30 EB 60	347.74	KL1B 30 EB 60	313.51	
70 - 27-9/16	KL1AR 30 EB 70	363.63	KL1B 30 EB 70	332.28	
80 - 31-1/2	KL1AR 30 EB 80	374.04	KL1B 30 EB 80	339.22	
90 - 35-7/16	KL1AR 30 EB 90	394.11	KL1B 30 EB 90	360.01	
100 - 39-3/8	KL1AR 30 EB 100	418.62	KL1B 30 EB 100	371.22	
110 - 43-5/16	KL1AR 30 EB 110	429.67	KL1B 30 EB 110	385.19	
120 - 47-1/4	KL1AR 30 EB 120	437.04	KL1B 30 EB 120	392.13	



Schluter®-KERDI-LINE

**GRATE ASSEMBLY - CHROME**

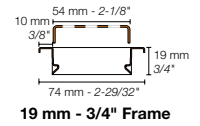
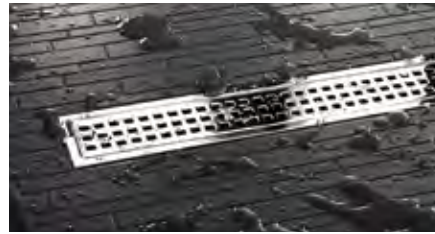
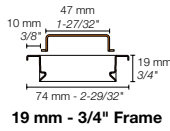
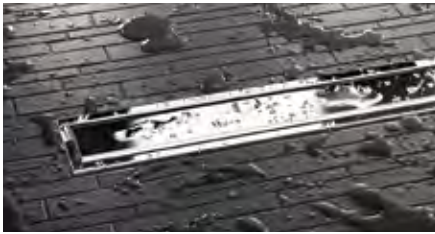

SOLID (A)

SQUARE (B)

Grate assemblies - Chrome



19 mm - 3/4" frame height for  
3 mm to 15 mm - 1/8" to 9/16" -thick coverings

Length = cm - in.	SOLID (A)		SQUARE (B)	
	Item No.	\$ / Unit	Item No.	\$ / Unit
50 - 19-11/16	KL1AR 19 EP 50	359.53	KL1B 19 EP 50	327.18
60 - 23-5/8	KL1AR 19 EP 60	369.83	KL1B 19 EP 60	333.43
70 - 27-9/16	KL1AR 19 EP 70	385.01	KL1B 19 EP 70	351.86
80 - 31-1/2	KL1AR 19 EP 80	394.97	KL1B 19 EP 80	358.24
90 - 35-7/16	KL1AR 19 EP 90	413.54	KL1B 19 EP 90	377.75
100 - 39-3/8	KL1AR 19 EP 100	438.29	KL1B 19 EP 100	388.66
110 - 43-5/16	KL1AR 19 EP 110	449.04	KL1B 19 EP 110	402.57
120 - 47-1/4	KL1AR 19 EP 120	457.18	KL1B 19 EP 120	410.22

**GRATE ASSEMBLY - MATTE BLACK**

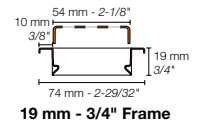
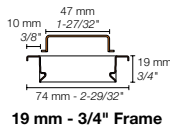
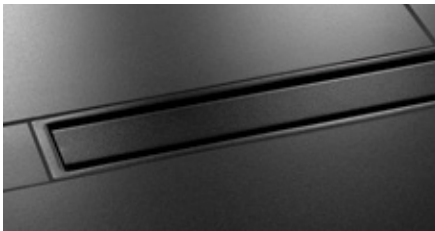

SOLID (A)

SQUARE (B)

Grate assemblies - Matte black



19 mm - 3/4" frame height for  
3 mm to 15 mm - 1/8" to 9/16" -thick coverings

Length = cm - in.	SOLID (A)		SQUARE (B)	
	Item No.	\$ / Unit	Item No.	\$ / Unit
50 - 19-11/16	KL1AR 19 MGS 50	378.29	KL1B 19 MGS 50	344.25
60 - 23-5/8	KL1AR 19 MGS 60	389.13	KL1B 19 MGS 60	350.84
70 - 27-9/16	KL1AR 19 MGS 70	405.12	KL1B 19 MGS 70	370.22
80 - 31-1/2	KL1AR 19 MGS 80	415.59	KL1B 19 MGS 80	376.94
90 - 35-7/16	KL1AR 19 MGS 90	435.13	KL1B 19 MGS 90	397.47
100 - 39-3/8	KL1AR 19 MGS 100	461.16	KL1B 19 MGS 100	408.95
110 - 43-5/16	KL1AR 19 MGS 110	472.49	KL1B 19 MGS 110	423.58
120 - 47-1/4	KL1AR 19 MGS 120	481.04	KL1B 19 MGS 120	431.63
130 - 51-3/16	KL1AR 19 MGS 130	627.17	KL1B 19 MGS 130	627.17
140 - 55-1/8	KL1AR 19 MGS 140	658.60	KL1B 19 MGS 140	658.60
150 - 59-1/16	KL1AR 19 MGS 150	693.11	KL1B 19 MGS 150	693.11
160 - 62-15/16	KL1AR 19 MGS 160	737.94	KL1B 19 MGS 160	737.94
170 - 66-7/8	KL1AR 19 MGS 170	769.35	KL1B 19 MGS 170	769.35
180 - 70-13/16	KL1AR 19 MGS 180	813.42	KL1B 19 MGS 180	813.42



## GRATE ASSEMBLY - TILE



TILE (D)

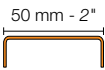

Grate assemblies - TILE			
Length = cm - in.	Item No.		\$ / Unit
	TILE (D)		
	For use with center outlet channel body	For use with off-set outlet channel body	
50 - 19-11/16	KL1DRE 50	-	151.34
60 - 23-5/8	KL1DRE 60	-	158.70
70 - 27-9/16	KL1DRE 70	KL1DRO E 70	166.04
80 - 31-1/2	KL1DRE 80	KL1DRO E 80	173.40
90 - 35-7/16	KL1DRE 90	KL1DRO E 90	185.92
100 - 39-3/8	KL1DRE 100	KL1DRO E 100	206.78
110 - 43-5/16	KL1DRE 110	KL1DRO E 110	214.08
120 - 47-1/4	KL1DRE 120	KL1DRO E 120	221.39
130 - 51-3/16	KL1DRE 130	-	266.96
140 - 55-1/8	KL1DRE 140	-	269.26
150 - 59-1/16	KL1DRE 150	-	272.01
160 - 62-15/16	KL1DRE 160	-	298.78
170 - 66-7/8	KL1DRE 170	-	301.73
180 - 70-13/16	KL1DRE 180	-	304.20

## Schluter®-KERDI-LINE-STYLE

## GRATE ASSEMBLY - BRUSHED STAINLESS STEEL STYLE DESIGNS



CURVE

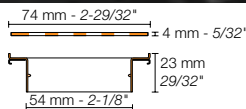

FLORAL

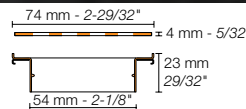

PURE

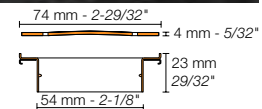

Grate assemblies - Brushed stainless steel						
23 mm - 29/32" frame height for 6 - 18 mm - 1/4" - 11/16" -thick coverings						
Length = cm - in.	CURVE		FLORAL		PURE	
	Item No.	\$ / Unit	Item No.	\$ / Unit	Item No.	\$ / Unit
50 - 19-11/16	KL11FF 23 EB 50	338.61	KL11FE 23 EB 50	351.89	KL11FG 23 EB 50	378.45
60 - 23-5/8	KL11FF 23 EB 60	351.89	KL11FE 23 EB 60	365.18	KL11FG 23 EB 60	391.73
70 - 27-9/16	KL11FF 23 EB 70	365.18	KL11FE 23 EB 70	378.45	KL11FG 23 EB 70	408.33
80 - 31-1/2	KL11FF 23 EB 80	385.10	KL11FE 23 EB 80	405.01	KL11FG 23 EB 80	424.92
90 - 35-7/16	KL11FF 23 EB 90	405.01	KL11FE 23 EB 90	431.55	KL11FG 23 EB 90	444.85
100 - 39-3/8	KL11FF 23 EB 100	424.92	KL11FE 23 EB 100	458.13	KL11FG 23 EB 100	464.77
110 - 43-5/16	KL11FF 23 EB 110	444.85	KL11FE 23 EB 110	484.68	KL11FG 23 EB 110	491.32
120 - 47-1/4	KL11FF 23 EB 120	464.77	KL11FE 23 EB 120	511.23	KL11FG 23 EB 120	517.86



Schluter®-KERDI-LINE

**SQUARE GRATE WITH LOCKING MECHANISM**

The Schluter®-KERDI-LINE SQUARE grate assembly (B) with 3/4" (19 mm) frame height is available with a locking mechanism for applications where tamper resistance is required.



SQUARE grate assembly with locking mechanism		
Length = cm - in.	Item No.	\$ / Unit
50 - 19-11/16	KL1BL 19 EB 50	329.14
60 - 23-5/8	KL1BL 19 EB 60	333.44
70 - 27-9/16	KL1BL 19 EB 70	349.62
80 - 31-1/2	KL1BL 19 EB 80	354.44
90 - 35-7/16	KL1BL 19 EB 90	373.32
100 - 39-3/8	KL1BL 19 EB 100	380.72
110 - 43-5/16	KL1BL 19 EB 110	393.51
120 - 47-1/4	KL1BL 19 EB 120	398.66
130 - 51-3/16	KL1BL 19 EB 130	584.31
140 - 55-1/8	KL1BL 19 EB 140	611.48
150 - 59-1/16	KL1BL 19 EB 150	641.28
160 - 62-15/16	KL1BL 19 EB 160	680.02
170 - 66-7/8	KL1BL 19 EB 170	707.16
180 - 70-13/16	KL1BL 19 EB 180	745.24

Note: Driver bit for tamper-proof screws sold separately. Please see page 140.

**COVER PLATE**

Schluter®-KERDI-LINE-FC

Schluter®-KERDI-LINE-FC is a stainless steel cover plate for use with the Schluter®-KERDI-LINE linear floor drain to create a seamless look in applications where multiple drains are installed end to end. KERDI-LINE-FC is designed for use with either the SOLID or SQUARE grates.

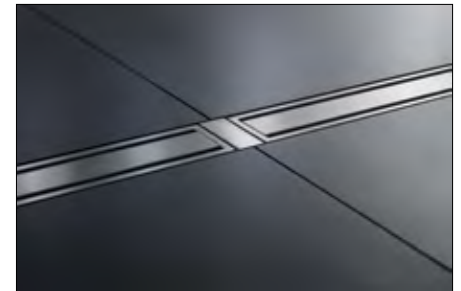
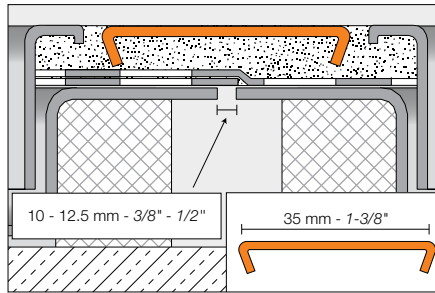

Schluter®-KERDI-LINE-FC Cover Plate					
Brushed stainless steel		Chrome		Matte black	
Item No.	\$ / Unit	Item No.	\$ / Unit	Item No.	\$ / Unit
V / KLEB 35	17.60	V / KLEP 35	17.60	V / KLMGS 35	20.37

**STRAINER**

The Schluter®-KERDI-LINE Strainer is a hair catcher customized to fit inside the KERDI-LINE channel body to trap and collect hair. Simple to remove and clean, the hair catcher fits discreetly into the drain to prevent hair clogs that can lead to blocked pipes.



Strainer for KERDI-LINE		
Item No.	Description	\$ / Unit
KL VZ SF	Strainer	3.21



## Prefabricated Substrates



Prefabricated shower trays, curbs, ramps, benches, and niches integrate seamlessly with KERDI and KERDI-BOARD shower assemblies, and are ideal solutions for including mortar-free shower components in any tiled shower. Quick and easy to install, Schluter prefabricated substrates combine comfort, convenience, and design and are available in multiple sizes and shapes to fit any décor.





## Schluter®-KERDI-SHOWER-T/-TS/-TT

**Schluter®-KERDI-SHOWER-T/-TS/-TT** are sloped shower trays with integrated KERDI waterproofing. The trays are made of lightweight, expanded polystyrene (PS 40) for constructing mortar-free shower bases. Each of these prefabricated shower trays is designed to integrate with the Schluter®-KERDI-DRAIN.

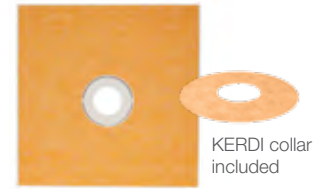

The **KERDI-SHOWER-T** is the standard tray with center drain placement.

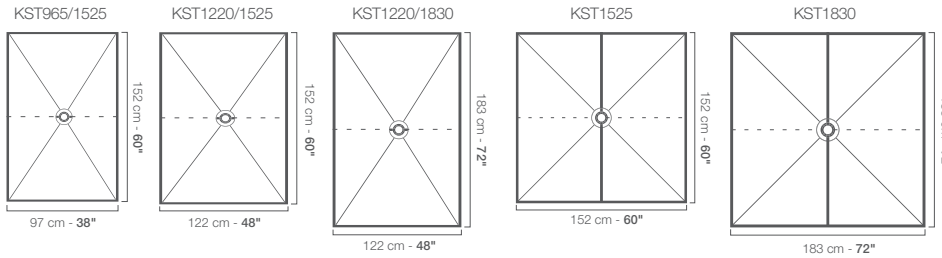

Schluter®-KERDI-SHOWER-T				
Tray with center drain placement				
Item No.	Dimensions	Perimeter height	Drain placement	\$ / Unit
KST 965/1525	97 cm x 152 cm - 38" x 60"	29 mm - 1-1/8"	center	141.33
KST 1220/1525	122 cm x 152 cm - 48" x 60"	28 mm - 1-3/32"	center	210.48
KST 1220/1830	122 cm x 183 cm - 48" x 72"	32 mm - 1-1/4"	center	225.52
KST 1525	152 cm x 152 cm - 60" x 60"	30 mm - 1-3/16"	center	276.63
KST 1830	183 cm x 183 cm - 72" x 72"	32 mm - 1-1/4"	center	300.68

The **KERDI-SHOWER-TS** is the standard tray with off-center drain placement.

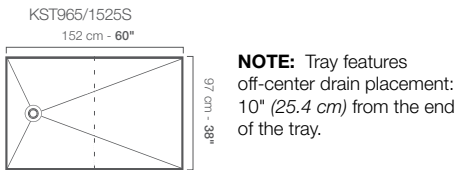

Schluter®-KERDI-SHOWER-TS				
Tray with off-center drain placement				
Item No.	Dimensions	Perimeter height	Drain placement	\$ / Unit
KST 965/1525 S	97 cm x 152 cm - 38" x 60"	29 mm - 1-1/8"	off-center	141.33

The **KERDI-SHOWER-TT** features a thin perimeter height that simplifies the construction of curbless showers.

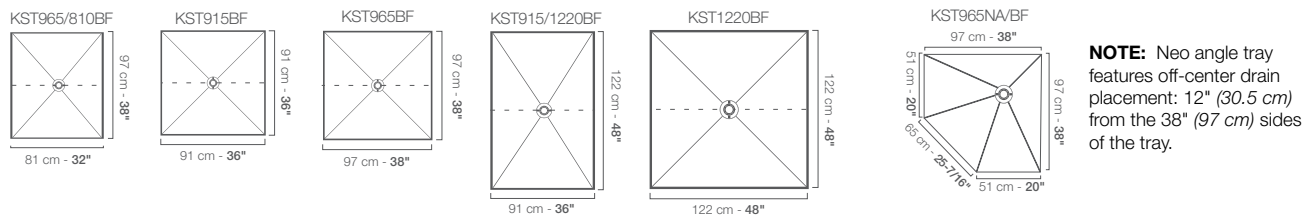

Schluter®-KERDI-SHOWER-TT				
Thin tray				
Item No.	Dimensions	Perimeter height	Drain placement	\$ / Unit
KST 965/810 BF	81 cm x 97 cm - 32" x 38"	23 mm - 29/32"	center	138.32
KST 915 BF	91 cm x 91 cm - 36" x 36"	22 mm - 7/8"	center	105.24
KST 965 BF	97 cm x 97 cm - 38" x 38"	23 mm - 29/32"	center	117.26
KST 915/1220 BF	91 cm x 122 cm - 36" x 48"	25 mm - 1"	center	162.37
KST 1220 BF	122 cm x 122 cm - 48" x 48"	25 mm - 1"	center	129.30
KST 965NA/ BF	97 cm x 97 cm - 38" x 38" Neo angle	26 mm - 1-1/32"	off-center	144.33



## Schluter®-KERDI-SHOWER-LT/LTS

Schluter®-KERDI-SHOWER-LT/-LTS are polystyrene sloped trays with integrated Schluter®-KERDI waterproofing. Each of these prefabricated shower trays is designed to integrate with the Schluter®-KERDI-LINE.



The **KERDI-SHOWER-LT** allows for the installation of a center drain.

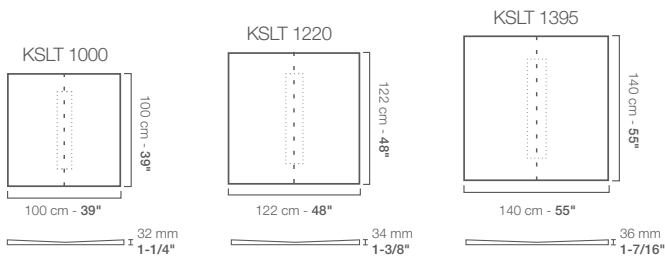

Schluter®-KERDI-SHOWER-LT				
Tray with center linear drain placement				
Item No.	Dimensions	Height at ends	Drain placement	\$ / Unit
KSLT 1000	100 cm x 100 cm - 39" x 39"	32 mm - 1-1/4"	center	<b>212.40</b>
KSLT 1220	122 cm x 122 cm - 48" x 48"	34 mm - 1-3/8"	center	<b>283.25</b>
KSLT 1395	140 cm x 140 cm - 55" x 55"	36 mm - 1-7/16"	center	<b>356.90</b>

The **KERDI-SHOWER-LTS** accommodates the installation of the drain along the perimeter of the shower.

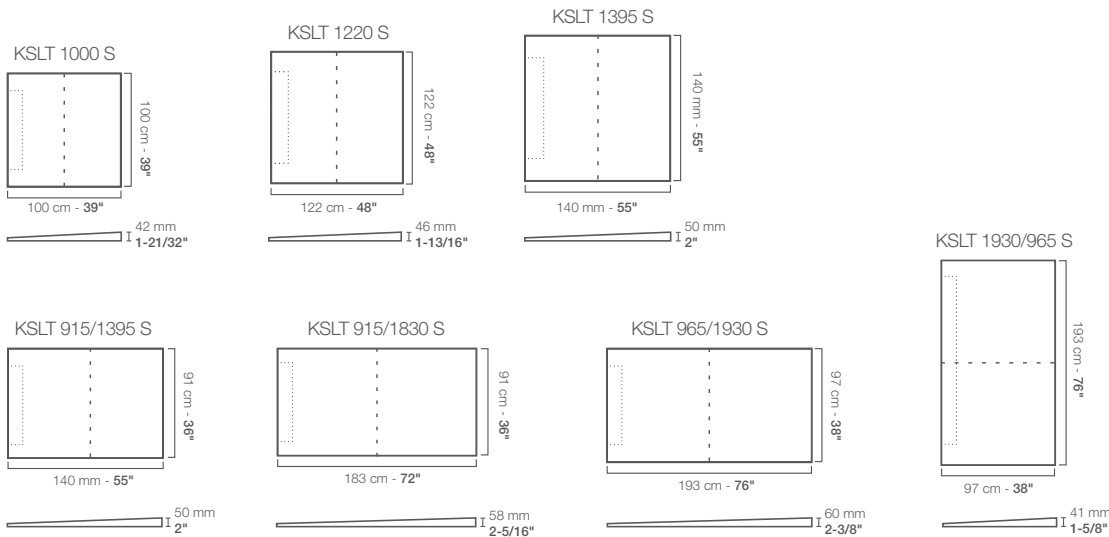

Schluter®-KERDI-SHOWER-LTS				
Tray with perimeter linear drain placement				
Item No.	Dimensions	Height at end	Drain placement	\$ / Unit
KSLT 1000 S	100 cm x 100 cm - 39" x 39"	42 mm - 1-21/32"	perimeter	<b>212.40</b>
KSLT 1220 S	122 cm x 122 cm - 48" x 48"	46 mm - 1-13/16"	perimeter	<b>283.25</b>
KSLT 1395 S	140 cm x 140 cm - 55" x 55"	50 mm - 2"	perimeter	<b>356.90</b>
KSLT 915/1395 S	91 cm x 140 cm - 36" x 55"	50 mm - 2"	perimeter	<b>249.25</b>
KSLT 915/1830 S	91 cm x 183 cm - 36" x 72"	58 mm - 2-5/16"	perimeter	<b>334.23</b>
KSLT 965/1930 S	97 cm x 193 cm - 38" x 76"	60 mm - 2-3/8"	perimeter	<b>368.22</b>
KSLT 1930/965 S	193 cm x 97 cm - 76" x 38"	41 mm - 1-5/8"	perimeter	<b>368.22</b>





### Schluter®-KERDI-BOARD-SC

**Schluter®-KERDI-BOARD-SC** is a prefabricated shower curb made of KERDI-BOARD that is designed to integrate with the Schluter®-Shower System. The curb is lightweight, stable, and load bearing. It can be used in conjunction with the KERDI-SHOWER prefabricated shower trays as well as in mortar bed applications. KERDI-BOARD-SC is quick and easy to install, waterproof and ready to tile, making it a simple solution for tiled shower curbs.

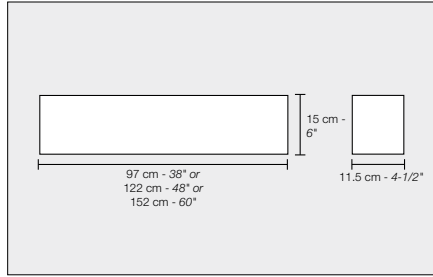

Schluter®-KERDI-BOARD-SC				
Curb				
Item No.	Length	Width	Height	\$ / Unit
KBSC 115 150 970	97 cm - 38"	11.5 cm - 4-1/2"	15 cm - 6"	64.24
KBSC 115 150 1220	122 cm - 48"	11.5 cm - 4-1/2"	15 cm - 6"	70.08
KBSC 115 150 1524	152 cm - 60"	11.5 cm - 4-1/2"	15 cm - 6"	102.78

**⚠ WARNING:** Cancer and Reproductive Harm - [www.P65Warnings.ca.gov](http://www.P65Warnings.ca.gov)

### Schluter®-KERDI-SHOWER-R

**Schluter®-KERDI-SHOWER-R** is a lightweight, expanded polystyrene shower ramp with integrated Schluter®-KERDI waterproofing designed to facilitate the construction of access ramps for tiled showers. The ramp integrates with the Schluter®-Shower System to create accessible, curbless showers and adheres to the ADA's slope ratio.

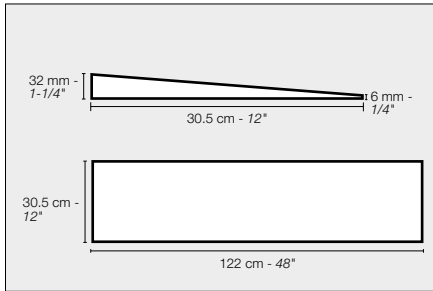

Schluter®-KERDI-SHOWER-R			
Ramp			
Item No.	Length	Width	\$ / Unit
KSR 305/1220	122 cm - 48"	30.5 cm - 12"	108.05

### Schluter®-KERDI-BOARD-SB

**Schluter®-KERDI-BOARD-SB** is a prefabricated shower bench made of KERDI-BOARD that is designed to integrate with the Schluter®-Shower System. The bench is lightweight, stable, and load bearing. It features a sloped surface to prevent the accumulation of water. KERDI-BOARD-SB is quick and easy to install, waterproof and ready to tile, making it a simple solution for tiled shower benches.

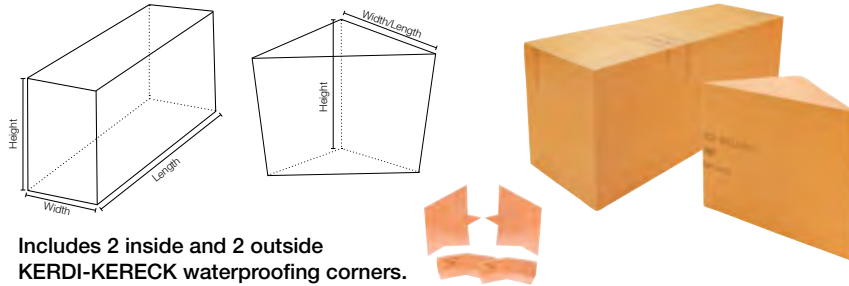

Includes 2 inside and 2 outside KERDI-KERECK waterproofing corners.

Schluter®-KERDI-BOARD-SB					
Bench					
Item No.	Length	Width	Height	Shape	\$/ Unit
KBSB 410 TA	41 cm - 16"	41 cm - 16"	51 cm - 20"	Triangular	177.53
KBSB 610 TA	61 cm - 24"	61 cm - 24"	51 cm - 20"	Triangular	231.27
KBSB 290 970 RA	97 cm - 38"	29 cm - 11-1/2"	51 cm - 20"	Rectangular	286.17
KBSB 410 1220 RA	122 cm - 48"	41 cm - 16"	51 cm - 20"	Rectangular	379.61

**⚠ WARNING:** Cancer and Reproductive Harm - [www.P65Warnings.ca.gov](http://www.P65Warnings.ca.gov)

### Schluter®-KERDI-BOARD-SN

**Schluter®-KERDI-BOARD-SN** is a prefabricated shower niche made of Schluter®-KERDI-BOARD that can be installed in both Schluter®-KERDI and KERDI-BOARD wall assemblies. The shower niche features a 1/2" (12.5 mm) -thick by 2" (50 mm) -wide integrated bonding flange and is available in 4 different sizes. Larger sizes include a prefabricated KERDI-BOARD shelf that can be installed at any height to create separate compartments within the shower niche if desired.

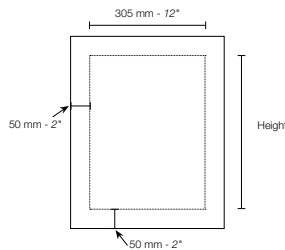

Schluter®-KERDI-BOARD-SN					
Niche					
Item No.	Height	Width	Depth	Shelf	\$/ Unit
KB 12 SN 305 152 A	152 mm - 6"	305 mm - 12"	89 mm - 3-1/2"	-	63.67
KB 12 SN 305 305 A	305 mm - 12"	305 mm - 12"	89 mm - 3-1/2"	-	76.25
KB 12 SN 305 508 A1	508 mm - 20"	305 mm - 12"	89 mm - 3-1/2"	1	103.07
KB 12 SN 305 711 A1	711 mm - 28"	305 mm - 12"	89 mm - 3-1/2"	1	123.19

**⚠ WARNING:** Cancer and Reproductive Harm - [www.P65Warnings.ca.gov](http://www.P65Warnings.ca.gov)



# Shower & Tub Kits

Our kits are convenient solutions to providing all the components required to build waterproof showers and bathtub surrounds. With various sizes, options, and configurations, there's a perfect kit for virtually every bathroom project.



## Schluter®-KERDI-SHOWER-KIT

The **Schluter®-KERDI-SHOWER-KIT** is an all-inclusive package containing each of the integrated family of components required to create a maintenance-free, watertight shower assembly without a mortar bed.

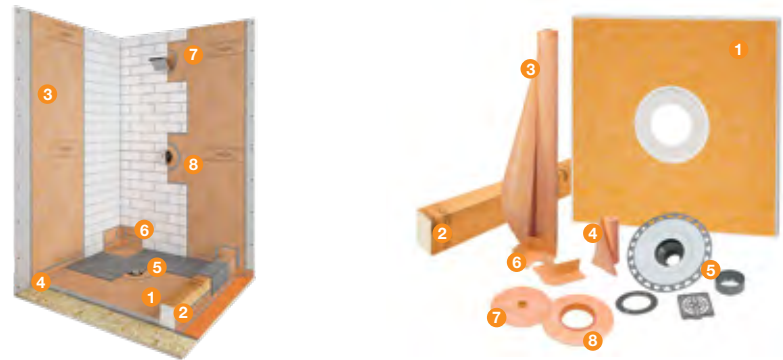

Includes		Description	Quantity	
			48" x 48"	38" x 60"
1	KERDI-SHOWER-T/-TS/-TT	Shower Tray	1	1
2	KERDI-BOARD-SC	Shower Curb 122 cm x 15 cm x 11.5 cm - 48" x 6" x 4-1/2"	1	
	KERDI-BOARD-SC	Shower Curb 97 cm x 15 cm x 11.5 cm - 38" x 6" x 4-1/2"		2
3	KERDI 10 M	Waterproofing membrane 1 m x 10 m = 10 m <sup>2</sup> - 3' 3" x 33' = 108 ft <sup>2</sup>	1	1
4	KERDI-BAND	Waterproofing strip 125 mm x 10 m - 5" x 33'	1	1
5	KERDI-DRAIN	Flange with 50 mm – 2" outlet and stainless steel grate (E)	1	1
6	KERDI-KERECK-F	Preformed waterproofing corners	4 inside and 2 outside	
7	KERDI-SEAL-PS	Pipe seal 20 mm – 3/4"	1	
8	KERDI-SEAL-MV	Mixing valve seal 114 mm – 4-1/4"	1	

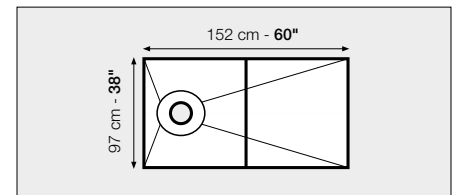
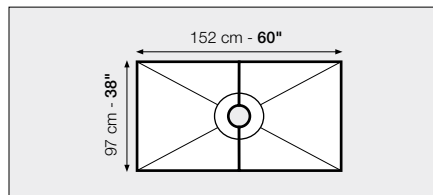
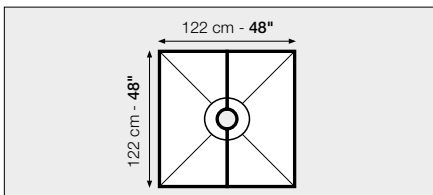

48" x 48" Kit - ABS or PVC			
Item No.	Drain Material	Grate finish	\$ / Kit
KSK 1220 ABS E	ABS	E	<b>613.34</b>
KSK 1220 PVC E	PVC	E	<b>613.34</b>

38" x 60" Kit - ABS or PVC			
Item No.	Drain Material	Grate finish	\$ / Kit
KSK 965 1525 ABS E	ABS	E	<b>665.70</b>
KSK 965 1525 PVC E	PVC	E	<b>665.70</b>

38" x 60" Kit off-center - ABS or PVC			
Item No.	Drain Material	Grate finish	\$ / Kit
KSK 965 1525S ABSE	ABS	E	<b>665.70</b>
KSK 965 1525S PVCE	PVC	E	<b>665.70</b>

**⚠ WARNING:** Cancer and Reproductive Harm - [www.P65Warnings.ca.gov](http://www.P65Warnings.ca.gov)

**Note:** Tray features off-center drain placement: 10" (25.4 cm) o.c. from end of tray.

## Schluter®-KERDI-SHOWER-KIT

### WITHOUT THE GRATE

This kit contains all the elements of the complete KERDI-SHOWER-KIT except the drain grate. This simplifies the stocking of a wide variety of KERDI-SHOWER-T/-TS/-TT tray and KERDI-DRAIN grate combinations.

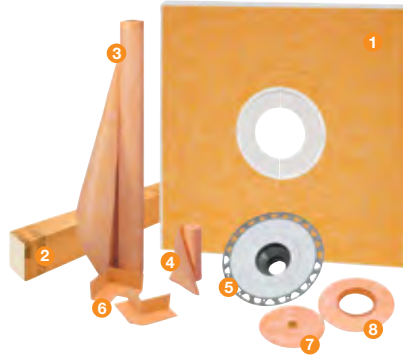

**KERDI-DRAIN Grates**  
sold separately

See pages 130-133

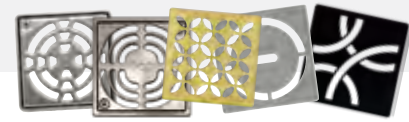

Includes	Description	Quantity			
		48" x 48"	38" x 60"	48" x 72"	72" x 72"
1 KERDI-SHOWER-T/-TS/-TT	Shower Tray	1	1	1	1
2 KERDI-BOARD-SC	Shower Curb 122 cm x 15 cm x 11.5 cm - 48" x 6" x 4-1/2"	1			
	KERDI-BOARD-SC		2	2	2
3 KERDI 5 M	Waterproofing membrane 1 m x 5 m = 5 m <sup>2</sup> - 3' 3" x 16' 5" = 54 ft <sup>2</sup>				1
	KERDI 10 M	1	1		1
	KERDI 12 M			1	
4 KERDI-BAND	Waterproofing strip 125 mm x 10 m - 5" x 33'	1	1	2	2
5 KERDI-DRAIN Flange	Flange with 50 mm - 2" outlet	1	1	1	1
6 KERDI-KERECK-F	Preformed waterproofing corners	4 inside and 2 outside			
7 KERDI-SEAL-PS	Pipe seal 20 mm - 3/4"	1			
8 KERDI-SEAL-MV	Mixing valve seal 114 mm - 4-1/4"	1			

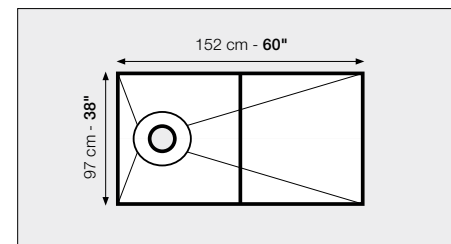
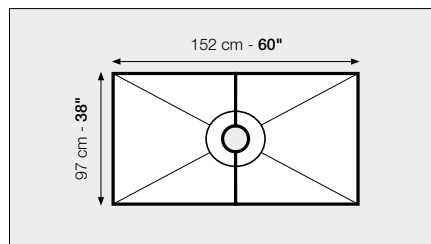
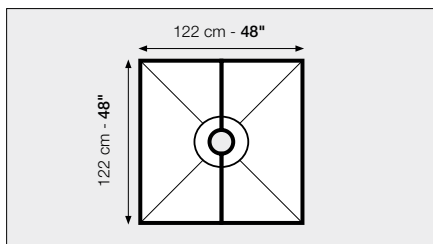

48" x 48" Kit - ABS or PVC		
Item No.	Drain Material	\$ / Kit
KSK 1220 ABS	ABS	557.95
KSK 1220 PVC	PVC	557.95

38" x 60" Kit - ABS or PVC		
Item No.	Drain Material	\$ / Kit
KSK 965 1525 ABS	ABS	610.04
KSK 965 1525 PVC	PVC	610.04

38" x 60" Kit off-center - ABS or PVC		
Item No.	Drain Material	\$ / Kit
KSK 965 1525S ABS	ABS	610.04
KSK 965 1525S PVC	PVC	610.04

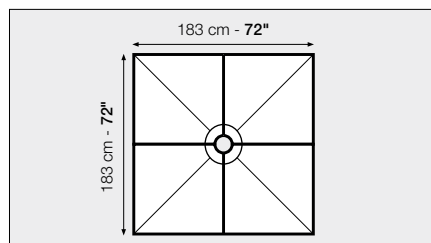
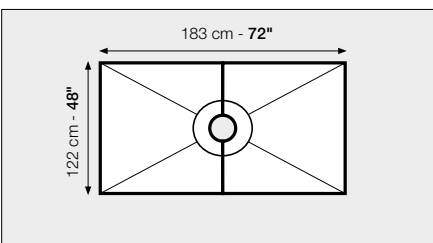

48" x 72" Kit - ABS or PVC		
Item No.	Drain Material	\$ / Kit
KSK 1220 1830 ABS	ABS	820.67
KSK 1220 1830 PVC	PVC	820.67

72" x 72" Kit - ABS or PVC		
Item No.	Drain Material	\$ / Kit
KSK 1830 ABS	ABS	956.96
KSK 1830 PVC	PVC	956.96

**Note:** Tray features off-center drain placement: 10" (25.4 cm) o.c. from end of tray.

**WARNING:** Cancer and Reproductive Harm - [www.P65Warnings.ca.gov](http://www.P65Warnings.ca.gov)



### Schluter®-KERDI-SHOWER-KIT

#### WITHOUT THE DRAIN

This kit contains all the elements of the complete KERDI-SHOWER-KIT except the KERDI-DRAIN. This simplifies the stocking of a wide variety of KERDI-SHOWER-T/-TS/-TT trays and KERDI-DRAIN combinations.

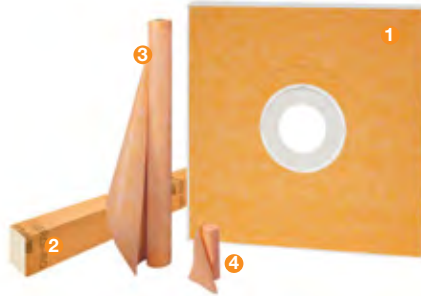

**KERDI-DRAIN grates and flanges sold separately**

Grates - See pages 130-133  
Flanges - See pages 134-137



Includes		Description	Quantity			
			48" x 48"	38" x 60"	48" x 72"	72" x 72"
1	KERDI-SHOWER-T/-TS/-TT	Shower Tray	1	1	1	1
2	KERDI-BOARD-SC	Shower Curb 122 cm x 15 cm x 11.5 cm - 48" x 6" x 4-1/2"	1			
	KERDI-BOARD-SC	Shower Curb 97 cm x 15 cm x 11.5 cm - 38" x 6" x 4-1/2"		2	2	2
3	KERDI 5 M	Waterproofing membrane 1 m x 5 m = 5 m <sup>2</sup> - 3' 3" x 16' 5" = 54 ft <sup>2</sup>				1
	KERDI 10 M	Waterproofing membrane 1 m x 10 m = 10 m <sup>2</sup> - 3' 3" x 33' = 108 ft <sup>2</sup>	1	1		1
	KERDI 12 M	Waterproofing membrane 1 m x 12 m = 12 m <sup>2</sup> - 3' 3" x 39' 4" = 128 ft <sup>2</sup>			1	
4	KERDI-BAND	Waterproofing strip 125 mm x 10 m - 5" x 33'	1	1	2	2

Tray size	Item No.	\$ / Kit
122 cm x 122 cm - 48" x 48"	KSK 1220	471.17
97 cm x 152 cm - 38" x 60"	KSK 965 1525	523.25
97 cm x 152 cm - 38" x 60" off-center drain	KSK 965 1525S	523.25
122 cm x 183 cm - 48" x 72"	KSK 1220 1830	733.88
183 cm x 183 cm - 72" x 72"	KSK 1830	870.18

**⚠ WARNING:** Cancer and Reproductive Harm - [www.P65Warnings.ca.gov](http://www.P65Warnings.ca.gov)

### Schluter®-KERDI-TUBKIT

The Schluter®-KERDI-TUBKIT contains all the components necessary to create a fully waterproof and vapor tight bathtub surround assembly.



Includes		Description	Quantity
1	KERDI 7M	Waterproofing membrane 1 m x 7 m = 7 m <sup>2</sup> - 3' 3" x 23' = 75 ft <sup>2</sup>	1
2	KERDI-BAND	Waterproofing strip 125 mm x 5 m - 5" x 16' 5"	1
3	KERDI-SEAL-PS	Pipe seal 20 mm - 3/4"	1
4	KERDI-SEAL-MV	Mixing valve seal 114 mm - 4-1/4"	1
5	KERDI-FIX	Sealing and bonding compound, bright white (290 ml - 9.81 fl oz)	1

Item No.	\$ / Kit
KKB7	256.97

**⚠ WARNING:** Reproductive Harm - [www.P65Warnings.ca.gov](http://www.P65Warnings.ca.gov)

### Schluter®-KERDI-BOARD-KIT

The **Schluter®-KERDI-BOARD-KIT** contains KERDI-BOARD panels and all the other components necessary to create a fully waterproof and vapor tight tile application around bathtubs and acrylic shower bases, all in one convenient package.



Schluter®-KERDI-BOARD-KIT		
Includes	Description	Quantity
1 KERDI-BOARD	Waterproof building panel 1.25 cm x 122 cm x 97 cm - 1/2" x 48" x 38" Total coverage = 9.4 m <sup>2</sup> - 101 ft <sup>2</sup>	8
2 KERDI-BAND	Waterproofing strip 125 mm x 30 m - 5" x 98' 5"	1
3 KERDI-SEAL-PS	Pipe seal	1x 12.5 mm - 1/2" 1x 20 mm - 3/4"
4 KERDI-SEAL-MV	Mixing valve seal 114 mm - 4-1/4"	1
5 KERDI-BOARD-ZT/-ZS	Screws and washers	140
6 KERDI-FIX	Sealing and bonding compound, bright white (290 ml - 9.81 fl oz)	2

Item No.	\$ / Kit
KBKIT	697.31

**⚠ WARNING:** Cancer and Reproductive Harm [www.P65Warnings.ca.gov](http://www.P65Warnings.ca.gov)





# Shower Accessories

Accessories are used to enhance tiled shower applications, providing shelving, splashguards at the entrances to curbless showers, support channels for glass walls, and wall finishing that eliminates the need to cut wedges of tile in KERDI-LINE applications.





**Schluter®-SHELF-W**

**Schluter®-SHELF-W** is a rectangular shelf designed for tiled walls. The shelf is made of either brushed stainless steel, or color-coated aluminum in a choice of 6 TRENDLINE colors. SHELF-W features a double anchoring leg for installation in tandem with tile. Matching KERDI-DRAIN and KERDI-LINE grates are also available.

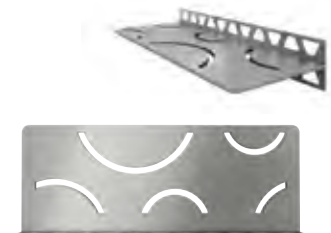
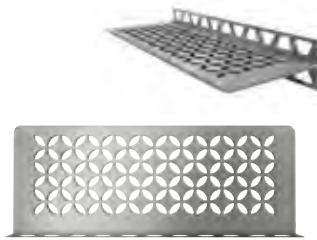
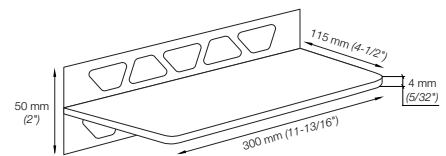
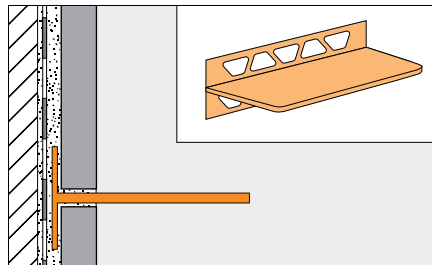

<b>Schluter®-SHELF-W</b>		
<b>FLORAL</b>		
Item No.	Finish	\$ / Unit
<b>Stainless steel</b>		
SWS1 D5 EB	Brushed stainless steel (EB)	<b>133.05</b>
<b>Color-coated aluminum</b>		
SWS1 D5 MBW	Matte white (MBW)	<b>113.38</b>
SWS1 D5 TSC	Cream (TSC)	<b>113.38</b>
SWS1 D5 TSBG	Greige (TSBG)	<b>113.38</b>
SWS1 D5 TSSG	Stone grey (TSSG)	<b>113.38</b>
SWS1 D5 TSOB	Bronze (TSOB)	<b>113.38</b>
SWS1 D5 MGS	Matte black (MGS)	<b>113.38</b>

<b>Schluter®-SHELF-W</b>		
<b>CURVE</b>		
Item No.	Finish	\$ / Unit
<b>Stainless steel</b>		
SWS1 D6 EB	Brushed stainless steel (EB)	<b>127.25</b>
<b>Color-coated aluminum</b>		
SWS1 D6 MBW	Matte white (MBW)	<b>94.87</b>
SWS1 D6 TSC	Cream (TSC)	<b>94.87</b>
SWS1 D6 TSBG	Greige (TSBG)	<b>94.87</b>
SWS1 D6 TSSG	Stone grey (TSSG)	<b>94.87</b>
SWS1 D6 TSOB	Bronze (TSOB)	<b>94.87</b>
SWS1 D6 MGS	Matte black (MGS)	<b>94.87</b>



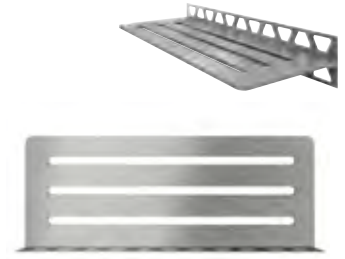
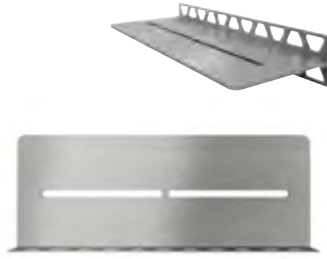

Schluter®-SHELF-W		
PURE		
Item No.	Finish	\$ / Unit
Stainless steel		
SWS1 D7 EB	Brushed stainless steel (EB)	127.25
Color-coated aluminum		
SWS1 D7 MBW	Matte white (MBW)	94.87
SWS1 D7 TSC	Cream (TSC)	94.87
SWS1 D7 TSBG	Greige (TSBG)	94.87
SWS1 D7 TSSG	Stone grey (TSSG)	94.87
SWS1 D7 TSOB	Bronze (TSOB)	94.87
SWS1 D7 MGS	Matte black (MGS)	94.87

Schluter®-SHELF-W		
WAVE		
Item No.	Finish	\$ / Unit
Stainless steel		
SWS1 D10 EB	Brushed stainless steel (EB)	133.05
Color-coated aluminum		
SWS1 D10 MBW	Matte white (MBW)	113.38
SWS1 D10 TSC	Cream (TSC)	113.38
SWS1 D10 TSBG	Greige (TSBG)	113.38
SWS1 D10 TSSG	Stone grey (TSSG)	113.38
SWS1 D10 TSOB	Bronze (TSOB)	113.38
SWS1 D10 MGS	Matte black (MGS)	113.38

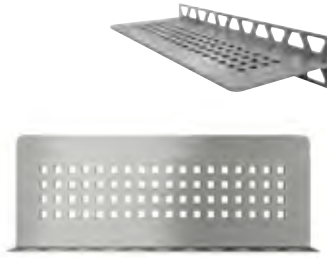

Schluter®-SHELF-W		
SQUARE		
Item No.	Finish	\$ / Unit
Stainless steel		
SWS1 D3 EB	Brushed stainless steel (EB)	133.05
Color-coated aluminum		
SWS1 D3 MBW	Matte white (MBW)	113.38
SWS1 D3 TSC	Cream (TSC)	113.38
SWS1 D3 TSBG	Greige (TSBG)	113.38
SWS1 D3 TSSG	Stone grey (TSSG)	113.38
SWS1 D3 TSOB	Bronze (TSOB)	113.38
SWS1 D3 MGS	Matte black (MGS)	113.38

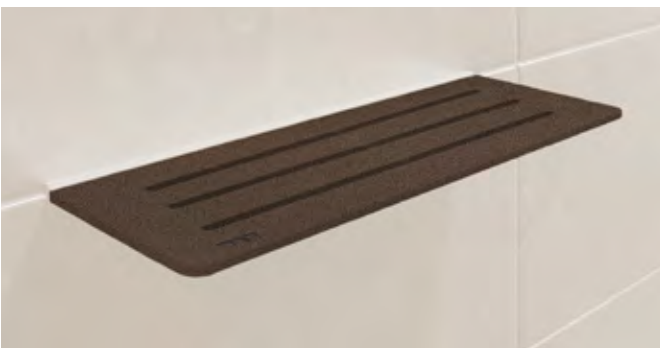

Stainless steel

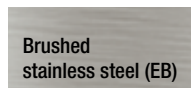

Color-coated aluminum

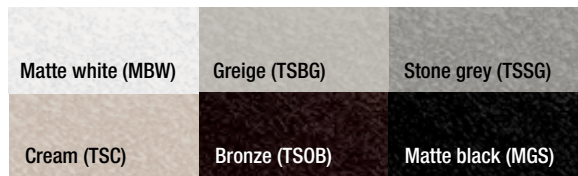



### Schluter®-SHELF-E

**Schluter®-SHELF-E** is a corner shelf designed for tiled walls. The shelf is made of either brushed stainless steel, or color-coated aluminum in a choice of 6 TRENDLINE colors. SHELF-E features 3/32" (2 mm) -thick anchoring tabs which allow for easy installation either in tandem with tile or as a retrofit application. Matching KERDI-DRAIN and KERDI-LINE grates are also available.

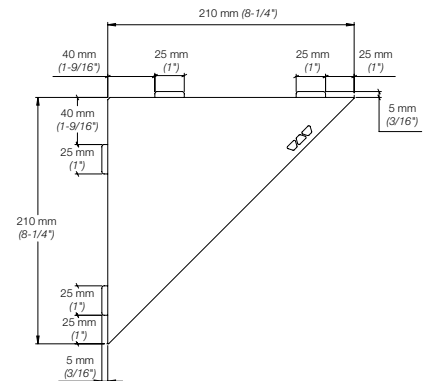
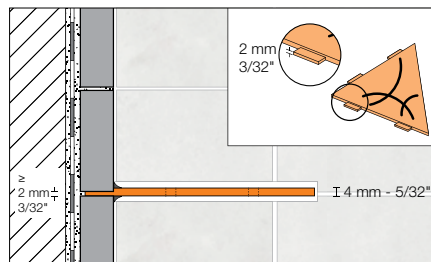

### Triangular Corner Shelf



Schluter®-SHELF-E		
FLORAL		
Item No.	Finish	\$ / Unit
<b>Stainless steel</b>		
SES1 D5 EB	Brushed stainless steel (EB)	<b>114.54</b>
<b>Color-coated aluminum</b>		
SES1 D5 MBW	Matte white (MBW)	<b>86.77</b>
SES1 D5 TSC	Cream (TSC)	<b>86.77</b>
SES1 D5 TSBG	Greige (TSBG)	<b>86.77</b>
SES1 D5 TSSG	Stone grey (TSSG)	<b>86.77</b>
SES1 D5 TSOB	Bronze (TSOB)	<b>86.77</b>
SES1 D5 MGS	Matte black (MGS)	<b>86.77</b>

Schluter®-SHELF-E		
CURVE		
Item No.	Finish	\$ / Unit
<b>Stainless steel</b>		
SES1 D6 EB	Brushed stainless steel (EB)	<b>109.91</b>
<b>Color-coated aluminum</b>		
SES1 D6 MBW	Matte white (MBW)	<b>80.98</b>
SES1 D6 TSC	Cream (TSC)	<b>80.98</b>
SES1 D6 TSBG	Greige (TSBG)	<b>80.98</b>
SES1 D6 TSSG	Stone grey (TSSG)	<b>80.98</b>
SES1 D6 TSOB	Bronze (TSOB)	<b>80.98</b>
SES1 D6 MGS	Matte black (MGS)	<b>80.98</b>



Schluter®-SHELF-E		
PURE		
Item No.	Finish	\$ / Unit
Stainless steel		
SES1 D7 EB	Brushed stainless steel (EB)	109.91
Color-coated aluminum		
SES1 D7 MBW	Matte white (MBW)	80.98
SES1 D7 TSC	Cream (TSC)	80.98
SES1 D7 TSBG	Greige (TSBG)	80.98
SES1 D7 TSSG	Stone grey (TSSG)	80.98
SES1 D7 TSOB	Bronze (TSOB)	80.98
SES1 D7 MGS	Matte black (MGS)	80.98



Schluter®-SHELF-E		
WAVE		
Item No.	Finish	\$ / Unit
Stainless steel		
SES1 D10 EB	Brushed stainless steel (EB)	114.54
Color-coated aluminum		
SES1 D10 MBW	Matte white (MBW)	86.77
SES1 D10 TSC	Cream (TSC)	86.77
SES1 D10 TSBG	Greige (TSBG)	86.77
SES1 D10 TSSG	Stone grey (TSSG)	86.77
SES1 D10 TSOB	Bronze (TSOB)	86.77
SES1 D10 MGS	Matte black (MGS)	86.77

Schluter®-SHELF-E		
SQUARE		
Item No.	Finish	\$ / Unit
Stainless steel		
SES1 D3 EB	Brushed stainless steel (EB)	114.54
Color-coated aluminum		
SES1 D3 MBW	Matte white (MBW)	86.77
SES1 D3 TSC	Cream (TSC)	86.77
SES1 D3 TSBG	Greige (TSBG)	86.77
SES1 D3 TSSG	Stone grey (TSSG)	86.77
SES1 D3 TSOB	Bronze (TSOB)	86.77
SES1 D3 MGS	Matte black (MGS)	86.77

Stainless steel

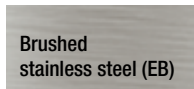

Color-coated aluminum

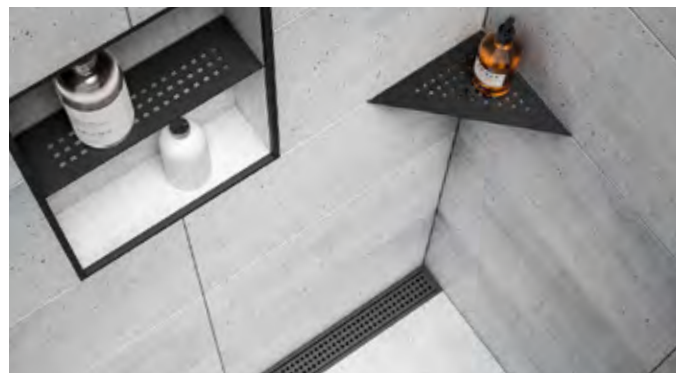

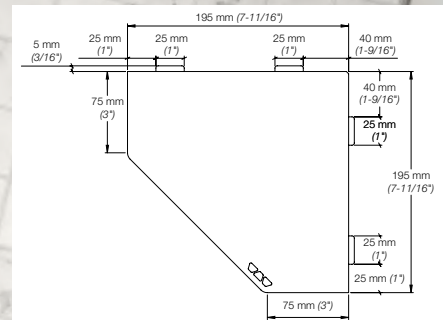

**Pentagonal Corner Shelf**



<b>Schluter®-SHELF-E</b>		
<b>FLORAL</b>		
Item No.	Finish	\$ / Unit
<b>Stainless steel</b>		
SES2 D5 EB	Brushed stainless steel (EB)	<b>114.54</b>
<b>Color-coated aluminum</b>		
SES2 D5 MBW	Matte white (MBW)	<b>98.33</b>
SES2 D5 TSC	Cream (TSC)	<b>98.33</b>
SES2 D5 TSBG	Greige (TSBG)	<b>98.33</b>
SES2 D5 TSSG	Stone grey (TSSG)	<b>98.33</b>
SES2 D5 TSOB	Bronze (TSOB)	<b>98.33</b>
SES2 D5 MGS	Matte black (MGS)	<b>98.33</b>

<b>Schluter®-SHELF-E</b>		
<b>CURVE</b>		
Item No.	Finish	\$ / Unit
<b>Stainless steel</b>		
SES2 D6 EB	Brushed stainless steel (EB)	<b>109.91</b>
<b>Color-coated aluminum</b>		
SES2 D6 MBW	Matte white (MBW)	<b>91.40</b>
SES2 D6 TSC	Cream (TSC)	<b>91.40</b>
SES2 D6 TSBG	Greige (TSBG)	<b>91.40</b>
SES2 D6 TSSG	Stone grey (TSSG)	<b>91.40</b>
SES2 D6 TSOB	Bronze (TSOB)	<b>91.40</b>
SES2 D6 MGS	Matte black (MGS)	<b>91.40</b>



Schluter®-SHELF-E		
PURE		
Item No.	Finish	\$ / Unit
Stainless steel		
SES2 D7 EB	Brushed stainless steel (EB)	109.91
Color-coated aluminum		
SES2 D7 MBW	Matte white (MBW)	91.40
SES2 D7 TSC	Cream (TSC)	91.40
SES2 D7 TSBG	Greige (TSBG)	91.40
SES2 D7 TSSG	Stone grey (TSSG)	91.40
SES2 D7 TSOB	Bronze (TSOB)	91.40
SES2 D7 MGS	Matte black (MGS)	91.40

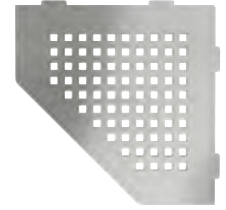

Schluter®-SHELF-E		
WAVE		
Item No.	Finish	\$ / Unit
Stainless steel		
SES2 D10 EB	Brushed stainless steel (EB)	114.54
Color-coated aluminum		
SES2 D10 MBW	Matte white (MBW)	98.33
SES2 D10 TSC	Cream (TSC)	98.33
SES2 D10 TSBG	Greige (TSBG)	98.33
SES2 D10 TSSG	Stone grey (TSSG)	98.33
SES2 D10 TSOB	Bronze (TSOB)	98.33
SES2 D10 MGS	Matte black (MGS)	98.33

Schluter®-SHELF-E		
SQUARE		
Item No.	Finish	\$ / Unit
Stainless steel		
SES2 D3 EB	Brushed stainless steel (EB)	114.54
Color-coated aluminum		
SES2 D3 MBW	Matte white (MBW)	98.33
SES2 D3 TSC	Cream (TSC)	98.33
SES2 D3 TSBG	Greige (TSBG)	98.33
SES2 D3 TSSG	Stone grey (TSSG)	98.33
SES2 D3 TSOB	Bronze (TSOB)	98.33
SES2 D3 MGS	Matte black (MGS)	98.33

Stainless steel

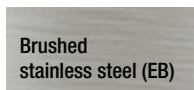

Color-coated aluminum





**Quadrilateral Corner Shelf**

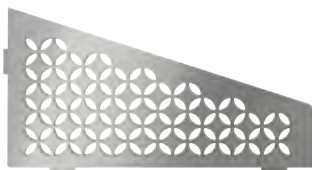
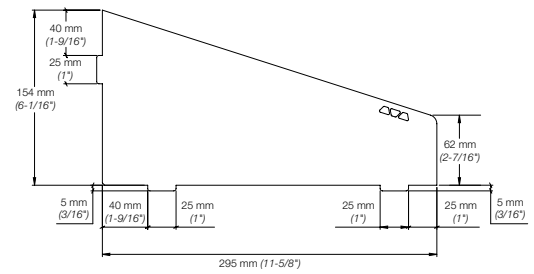
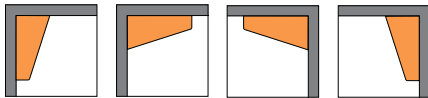

<b>Schluter®-SHELF-E</b>		
<b>FLORAL</b>		
Item No.	Finish	\$ / Unit
<b>Stainless steel</b>		
SES3 D5 EB	Brushed stainless steel (EB)	<b>149.24</b>
<b>Color-coated aluminum</b>		
SES3 D5 MBW	Matte white (MBW)	<b>114.54</b>
SES3 D5 TSC	Cream (TSC)	<b>114.54</b>
SES3 D5 TSBG	Greige (TSBG)	<b>114.54</b>
SES3 D5 TSSG	Stone grey (TSSG)	<b>114.54</b>
SES3 D5 TSOB	Bronze (TSOB)	<b>114.54</b>
SES3 D5 MGS	Matte black (MGS)	<b>114.54</b>

<b>Schluter®-SHELF-E</b>		
<b>CURVE</b>		
Item No.	Finish	\$ / Unit
<b>Stainless steel</b>		
SES3 D6 EB	Brushed stainless steel (EB)	<b>149.24</b>
<b>Color-coated aluminum</b>		
SES3 D6 MBW	Matte white (MBW)	<b>102.96</b>
SES3 D6 TSC	Cream (TSC)	<b>102.96</b>
SES3 D6 TSBG	Greige (TSBG)	<b>102.96</b>
SES3 D6 TSSG	Stone grey (TSSG)	<b>102.96</b>
SES3 D6 TSOB	Bronze (TSOB)	<b>102.96</b>
SES3 D6 MGS	Matte black (MGS)	<b>102.96</b>



Schluter®-SHELF-E		
PURE		
Item No.	Finish	\$ / Unit
Stainless steel		
SES3 D7 EB	Brushed stainless steel (EB)	149.24
Color-coated aluminum		
SES3 D7 MBW	Matte white (MBW)	102.96
SES3 D7 TSC	Cream (TSC)	102.96
SES3 D7 TSBG	Greige (TSBG)	102.96
SES3 D7 TSSG	Stone grey (TSSG)	102.96
SES3 D7 TSOB	Bronze (TSOB)	102.96
SES3 D7 MGS	Matte black (MGS)	102.96

Schluter®-SHELF-E		
WAVE		
Item No.	Finish	\$ / Unit
Stainless steel		
SES3 D10 EB	Brushed stainless steel (EB)	149.24
Color-coated aluminum		
SES3 D10 MBW	Matte white (MBW)	114.54
SES3 D10 TSC	Cream (TSC)	114.54
SES3 D10 TSBG	Greige (TSBG)	114.54
SES3 D10 TSSG	Stone grey (TSSG)	114.54
SES3 D10 TSOB	Bronze (TSOB)	114.54
SES3 D10 MGS	Matte black (MGS)	114.54

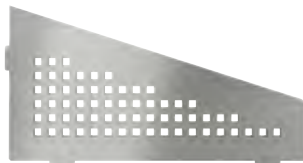

Schluter®-SHELF-E		
SQUARE		
Item No.	Finish	\$ / Unit
Stainless steel		
SES3 D3 EB	Brushed stainless steel (EB)	149.24
Color-coated aluminum		
SES3 D3 MBW	Matte white (MBW)	114.54
SES3 D3 TSC	Cream (TSC)	114.54
SES3 D3 TSBG	Greige (TSBG)	114.54
SES3 D3 TSSG	Stone grey (TSSG)	114.54
SES3 D3 TSOB	Bronze (TSOB)	114.54
SES3 D3 MGS	Matte black (MGS)	114.54

Stainless steel

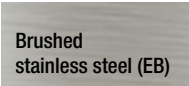

Color-coated aluminum

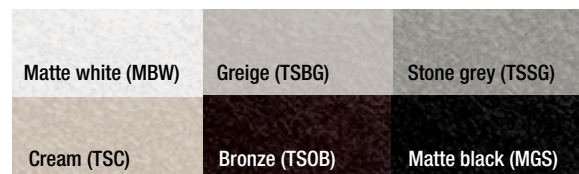



### Schluter®-SHELF-N

**Schluter®-SHELF-N** is a rectangular shelf designed to fit into Schluter®-KERDI-BOARD-SN prefabricated niches. The shelf is made of either brushed stainless steel, or color-coated aluminum in a choice of 6 TRENDLINE colors. SHELF-N can be easily installed in tandem with tile. Matching KERDI-DRAIN and KERDI-LINE grates are also available.

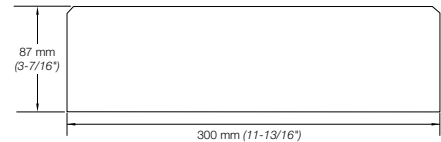
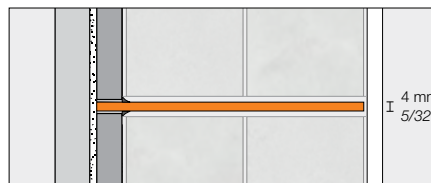

Schluter®-SHELF-N		
FLORAL		
Item No.	Finish	\$ / Unit
<b>Stainless steel</b>		
SNS1 D5 EB	Brushed stainless steel (EB)	<b>127.25</b>
<b>Color-coated aluminum</b>		
SNS1 D5 MBW	Matte white (MBW)	<b>98.33</b>
SNS1 D5 TSC	Cream (TSC)	<b>98.33</b>
SNS1 D5 TSBG	Greige (TSBG)	<b>98.33</b>
SNS1 D5 TSSG	Stone grey (TSSG)	<b>98.33</b>
SNS1 D5 TSOB	Bronze (TSOB)	<b>98.33</b>
SNS1 D5 MGS	Matte black (MGS)	<b>98.33</b>

Schluter®-SHELF-N		
CURVE		
Item No.	Finish	\$ / Unit
<b>Stainless steel</b>		
SNS1 D6 EB	Brushed stainless steel (EB)	<b>121.47</b>
<b>Color-coated aluminum</b>		
SNS1 D6 MBW	Matte white (MBW)	<b>92.55</b>
SNS1 D6 TSC	Cream (TSC)	<b>92.55</b>
SNS1 D6 TSBG	Greige (TSBG)	<b>92.55</b>
SNS1 D6 TSSG	Stone grey (TSSG)	<b>92.55</b>
SNS1 D6 TSOB	Bronze (TSOB)	<b>92.55</b>
SNS1 D6 MGS	Matte black (MGS)	<b>92.55</b>





Schluter®-SHELF-N		
PURE		
Item No.	Finish	\$ / Unit
Stainless steel		
SNS1 D7 EB	Brushed stainless steel (EB)	121.47
Color-coated aluminum		
SNS1 D7 MBW	Matte white (MBW)	92.55
SNS1 D7 TSC	Cream (TSC)	92.55
SNS1 D7 TSBG	Greige (TSBG)	92.55
SNS1 D7 TSSG	Stone grey (TSSG)	92.55
SNS1 D7 TSOB	Bronze (TSOB)	92.55
SNS1 D7 MGS	Matte black (MGS)	92.55



Schluter®-SHELF-N		
WAVE		
Item No.	Finish	\$ / Unit
Stainless steel		
SNS1 D10 EB	Brushed stainless steel (EB)	127.25
Color-coated aluminum		
SNS1 D10 MBW	Matte white (MBW)	98.33
SNS1 D10 TSC	Cream (TSC)	98.33
SNS1 D10 TSBG	Greige (TSBG)	98.33
SNS1 D10 TSSG	Stone grey (TSSG)	98.33
SNS1 D10 TSOB	Bronze (TSOB)	98.33
SNS1 D10 MGS	Matte black (MGS)	98.33



Schluter®-SHELF-N		
SQUARE		
Item No.	Finish	\$ / Unit
Stainless steel		
SNS1 D3 EB	Brushed stainless steel (EB)	127.25
Color-coated aluminum		
SNS1 D3 MBW	Matte white (MBW)	98.33
SNS1 D3 TSC	Cream (TSC)	98.33
SNS1 D3 TSBG	Greige (TSBG)	98.33
SNS1 D3 TSSG	Stone grey (TSSG)	98.33
SNS1 D3 TSOB	Bronze (TSOB)	98.33
SNS1 D3 MGS	Matte black (MGS)	98.33



Stainless steel

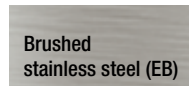

Color-coated aluminum





### Schluter®-SHOWERPROFILE-S

The **Schluter®-SHOWERPROFILE-S** is a two-part profile with a tapered edge, designed to cover adjoining tile edges that become exposed as the shower floor slopes to accommodate drainage to the Schluter®-KERDI-LINE. The tapered profile features a visible surface of brushed stainless steel and a fleece fabric on the reverse for bonding with the tile adhesive. It is designed to be inserted into the U-shaped groove of the matching hard PVC support profile. The profile can be used for lateral transitions to the wall or the adjoining floor.

**Note:** Tapered profiles with higher support profiles in the heights 9/16" (15 mm), 23/32" (18 mm), and 7/8" (22 mm) are available upon request for greater tile thicknesses. Please contact Customer Service for price and delivery times.

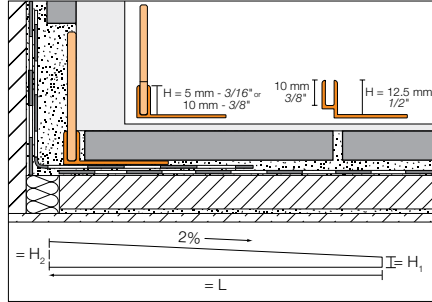

<b>Schluter®-SHOWERPROFILE-SA</b>				
<b>Two-part tapered edging profile</b>				
H = mm - in.	Item No.	H <sub>1</sub> = mm - in.	H <sub>2</sub> = mm - in.	\$ / Length
Length = 1.2 m - 47-1/4"				
5 - 3/16	SPSA 50 EB/120	6 - 1/4	30 - 1-3/16	74.23
Length = 1.6 m - 63"				
5 - 3/16	SPSA 50 EB/160	6 - 1/4	38 - 1-1/2	97.19
Length = 2 m - 78-3/4"				
5 - 3/16	SPSA 50 EB/200	6 - 1/4	46 - 1-13/16	216.36

<b>Schluter®-SHOWERPROFILE-SB</b>				
<b>Two-part tapered edging profile</b>				
H = mm - in.	Item No.	H <sub>1</sub> = mm - in.	H <sub>2</sub> = mm - in.	\$ / Length
Length = 1.2 m - 47-1/4"				
10 - 3/8	SPSB 100 EB/120	10 - 3/8	34 - 1-11/32	74.23
12.5 - 1/2	SPSB 125 EB/120	10 - 3/8	34 - 1-11/32	82.70
Length = 1.6 m - 63"				
10 - 3/8	SPSB 100 EB/160	10 - 3/8	42 - 1-21/32	97.19
12.5 - 1/2	SPSB 125 EB/160	10 - 3/8	42 - 1-21/32	107.65
Length = 2 m - 78-3/4"				
10 - 3/8	SPSB 100 EB/200	10 - 3/8	50 - 2	241.43
12.5 - 1/2	SPSB 125 EB/200	10 - 3/8	50 - 2	241.43

### Schluter®-SHOWERPROFILE-R

The **Schluter®-SHOWERPROFILE-R** is a two part wall transition profile made of brushed stainless steel for covering the exposed wall area where the floor slopes down to a perimeter linear drain. A fleece fabric is laminated on the reverse of the profile for bonding with the tile adhesive. The two-part design of Schluter®-SHOWERPROFILE-R can be seamlessly adjusted to any height between 29/32" (23 mm) and 1-25/32" (45 mm) (available in two versions). The profile is available in lengths of 39" (1 m) and 55" (1.4 m) and can be cut to the desired length.

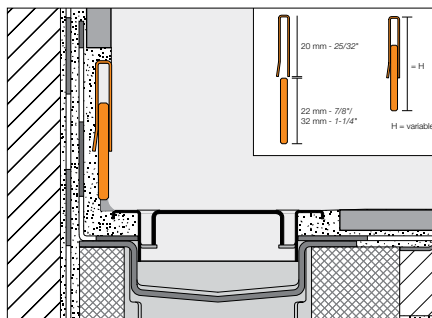

<b>Schluter®-SHOWERPROFILE-R</b>		
<b>Two-part wall transition profile</b>		
H = mm - in.	Item No.	\$ / Length
Length = 1 m - 39"		
23 - 35 - 29/32 - 1-3/8	SPRA 23 EB/100	90.32
33 - 45 - 1-5/16 - 1-25/32	SPRA 33 EB/100	98.43
Length = 1.4 m - 55"		
23 - 35 - 29/32 - 1-3/8	SPRA 23 EB/140	103.93
33 - 45 - 1-5/16 - 1-25/32	SPRA 33 EB/140	116.32



### Schluter®-SHOWERPROFILE-WS

The **Schluter®-SHOWERPROFILE-WS** is a two-part profile that forms a splashguard at the entrance of barrier-free showers. The anodized aluminum support profile is set in conjunction with the tile covering and can be combined with either a semi-circular lip made of rigid PVC or a collapsible upright lip made of transparent polyurethane. Both variants allow for wheelchair accessibility.

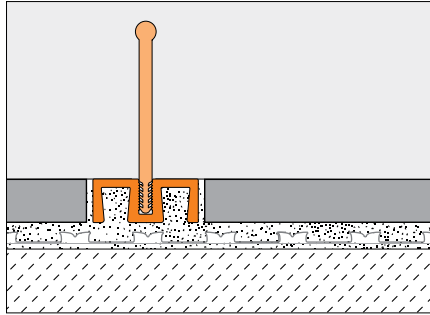

Schluter®-SHOWERPROFILE-WS		
Satin anodized aluminum support profile		
H = mm - in.	Item No.	\$ / Length
Length = 1 m - 39"		
8 - 5/16	SPWS 19 AE / 100	25.23
Length = 2.5 m - 8' 2-1/2"		
8 - 5/16	SPWS 19 AE	56.42

Schluter®-SHOWERPROFILE-WSC		
Semi-circular lip		
H = mm - in.	Item No.	\$ / Length
Length = 1 m - 39"		
8 - 5/16	SPWSC 16 GS / 100	13.18
Length = 2.5 m - 8' 2-1/2"		
8 - 5/16	SPWSC 16 GS	28.99

Schluter®-SHOWERPROFILE-WSL		
Straight lip		
H = mm - in.	Item No.	\$ / Length
Length = 1 m - 39"		
8 - 5/16	SPWSL 30 T / 100	15.92
Length = 2.5 m - 8' 2-1/2"		
8 - 5/16	SPWSL 30 T	35.02

**ADA-Compliant**

**Note:** SHOWERPROFILE-WS with the WSL straight lip insert is not ADA-compliant.

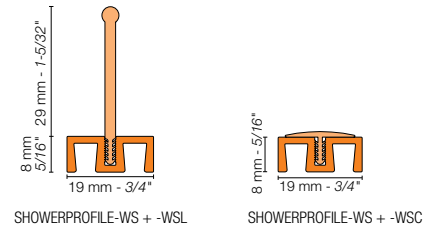

### Schluter®-SHOWERPROFILE-WSK

The **Schluter®-SHOWERPROFILE-WSK** is a two-part profile that forms a splashguard at the entrance of barrier-free showers. The anodized aluminum support profile is adhered to existing coverings and can be combined with either a semi-circular lip made of rigid PVC or a collapsible upright lip made of transparent polyurethane. Both variants allow for wheelchair accessibility.

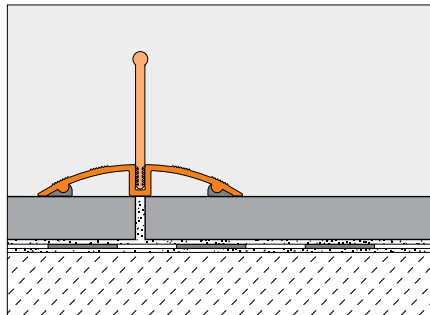

Schluter®-SHOWERPROFILE-WSK		
Satin anodized aluminum support profile		
H = mm - in.	Item No.	\$ / Length
Length = 1 m - 39"		
8 - 5/16	SPWSK 52 AE / 100	29.60
Length = 2.5 m - 8' 2-1/2"		
8 - 5/16	SPWSK 52 AE	67.50

Schluter®-SHOWERPROFILE-WSC		
Semi-circular lip		
H = mm - in.	Item No.	\$ / Length
Length = 1 m - 39"		
8 - 5/16	SPWSC 16 GS / 100	13.18
Length = 2.5 m - 8' 2-1/2"		
8 - 5/16	SPWSC 16 GS	28.99

Schluter®-SHOWERPROFILE-WSL		
Straight lip		
H = mm - in.	Item No.	\$ / Length
Length = 1 m - 39"		
8 - 5/16	SPWSL 30 T / 100	15.92
Length = 2.5 m - 8' 2-1/2"		
8 - 5/16	SPWSL 30 T	35.02

### Schluter®-SHOWERPROFILE-WSK-EK

Schluter®-SHOWERPROFILE-WSK-EK		
End cap		
H = mm - in.	Item No.	\$ / Unit
8 - 5/16	EK / SPWSK 52 AE	5.41

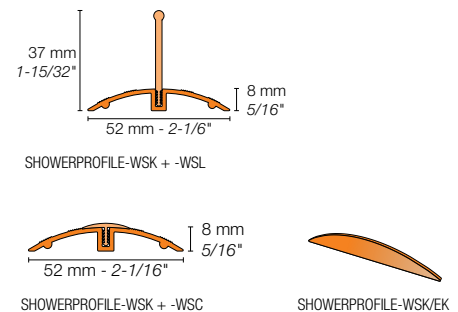

**ADA-Compliant**

**Note:** SHOWERPROFILE-WSK with the WSL straight lip insert is not ADA-compliant.



### Schluter®-DECO-SG

**Schluter®-DECO-SG** is a decorative profile featuring a 1/2" (12.5 mm) or 9/16" (15 mm) -wide channel that creates a shadow gap between tile courses or other wall covering. The profile may also be used as a support channel for glass walls. The 1/2" wide channel accommodates glass walls up to a thickness of 3/8" (10 mm), and the 9/16" wide channel accommodates glass walls up to a thickness of 1/2" (12.5 mm). DECO-SG features a trapezoid-perforated anchoring leg that is secured in the bond coat beneath the tile.

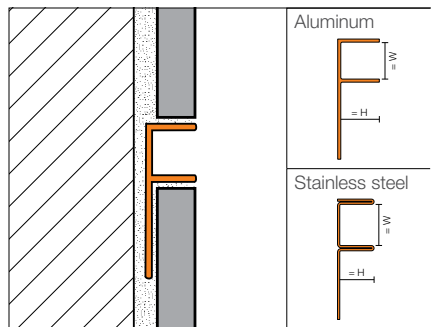

Schluter®-DECO-SG						
Length = 2.5 m - 8' 2-1/2"	Brushed stainless steel 304 (1.4301 = V2A) (EB)		Satin anodized aluminum (AE)		Bright chrome anod. alu. (ACB)	
H = mm - in.	Item No.	\$ / Length	Item No.	\$ / Length	Item No.	\$ / Length
<b>W: 12.5 mm - 1/2"</b>						
8 - 5/16	SG 80 EB 12	78.03	SG 80 AE 12	21.55	SG 80 ACB 12	22.42
10 - 3/8	SG 100 EB 12	83.34	SG 100 AE 12	22.66	SG 100 ACB 12	23.47
11 - 7/16	SG 110 EB 12	86.20	SG 110 AE 12	23.28	SG 110 ACB 12	24.15
12.5 - 1/2	SG 125 EB 12	90.77	SG 125 AE 12	24.07	SG 125 ACB 12	24.94
<b>W: 15 mm - 9/16"</b>						
8 - 5/16	SG 80 EB 15	80.46	SG 80 AE 15	22.62	SG 80 ACB 15	23.53
10 - 3/8	SG 100 EB 15	85.71	SG 100 AE 15	23.80	SG 100 ACB 15	24.65
11 - 7/16	SG 110 EB 15	88.91	SG 110 AE 15	24.44	SG 110 ACB 15	25.36
12.5 - 1/2	SG 125 EB 15	92.28	SG 125 AE 15	25.28	SG 125 ACB 15	26.20



### Schluter®-DECO-SGC

**Schluter®-DECO-SGC** is a decorative profile featuring a 1/2" (12.5 mm) or 9/16" (15 mm) -wide channel used as a vertical support for glass panels in recessed showers that border on untiled walls that are plastered, creating a 90° angle between the glass partition and the untiled wall. The 1/2" (12.5 mm) wide channel accommodates glass panels up to a thickness of 3/8" (10 mm), and the 9/16" (15 mm) wide channel accommodates glass panels up to a thickness of 1/2" (12.5 mm). DECO-SGC features a trapezoid-perforated anchoring leg that is secured in the bond coat beneath the tile.

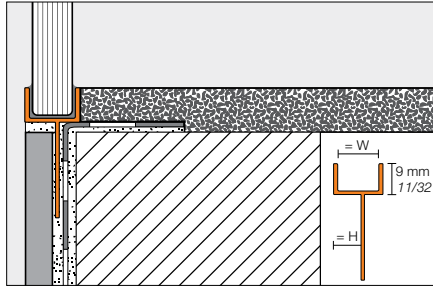

Schluter®-DECO-SGC			
Length = 2.5 m - 8' 2-1/2"	Satin anodized aluminum (AE)		
H = mm - in.	Item No.	\$/ Length	
<b>W: 12.5 mm - 1/2"</b>			
8 - 5/16	SGC 80 AE 12	23.28	
10 - 3/8	SGC 100 AE 12	24.48	
11 - 7/16	SGC 110 AE 12	25.14	
12.5 - 1/2	SGC 125 AE 12	26.00	
<b>W: 15 mm - 9/16"</b>			
8 - 5/16	SGC 80 AE 15	24.43	
10 - 3/8	SGC 100 AE 15	25.71	
11 - 7/16	SGC 110 AE 15	26.39	
12.5 - 1/2	SGC 125 AE 15	27.31	

### Schluter®-KERDI-FIX

**Schluter®-KERDI-FIX** is a single-component sealing and bonding compound with a silane-modified polymer base. It is odor-neutral, UV- and weather-resistant, and contains no solvents. KERDI-FIX is elastomeric and bonds well to most materials, such as wood, stone, concrete, metal, glass, and many plastics. KERDI-FIX is suitable for bonding and Schluter®-KERDI waterproofing membrane and Schluter®-KERDI-BAND to fixed building elements. KERDI-FIX is also suitable for use as a sealant.



*Color Codes
<div style="display: flex; justify-content: space-around; align-items: center;"> <div style="text-align: center;"> <p>Bright white</p> </div> <div style="text-align: center;"> <p>Grey</p> </div> </div>

Schluter®-KERDI-FIX	
Cartridge (290 ml – 9.81 fl oz)	
Item No.	\$/ Unit
KERDIFIX / + color*	29.75

Schluter®-KERDI-FIX	
Tube (100 ml – 3.38 fl oz) - Grey (G)	
Item No.	\$/ Unit
KERDIFIX 100 G	17.28

**⚠ WARNING:** Reproductive Harm - [www.P65Warnings.ca.gov](http://www.P65Warnings.ca.gov)



## Schluter®-BEKOTEC

### Modular screed system for conventional & radiant-heated screeds

BEKOTEC is a modular screed system that produces permanent flooring assemblies that are free from internal stresses. The BEKOTEC system is based on a studded polystyrene screed panel. The studs confine curing stresses to small modules, which eliminates curling and allows the installation of continuous screed surfaces without any wire reinforcement or control joints. BEKOTEC is ideal for hydronic radiant heating applications, as it provides thermal insulation, allows for hydronic radiant tube application without fasteners, and reduces thermal mass to produce a responsive system that can operate at a low temperature range. The BEKOTEC system can also be used in conjunction with common sound insulation materials to produce a flooring system with excellent sound attenuation properties.





**Schluter®-BEKOTEC and Schluter®-BEKOTEC-F**

The **Schluter®-BEKOTEC** family of products are lightweight modular screed systems that are used to create continuous screed surfaces without control joints or reinforcement and can also accommodate hydronic radiant heating tubes 3/8"-5/8" (10-16 mm) O.D. They produce permanent flooring assemblies that are free from internal stresses by confining the shrinkage and curing stresses to smaller modules, which controls deformations such as curling and continuous cracks that are common in traditional screeds. Since they are floating systems, the assemblies can be customized to meet a range of heat and sound requirements. For use with ceramic tile, natural stone, or other surface coverings.

**Schluter®-BEKOTEC** is 1-3/8" (35 mm) -thick, and is made of expanded polystyrene.

**Schluter®-BEKOTEC-F** is 29/32" (23 mm) -thick, and is made of polystyrene foil.

EN/US/P = Screed panel

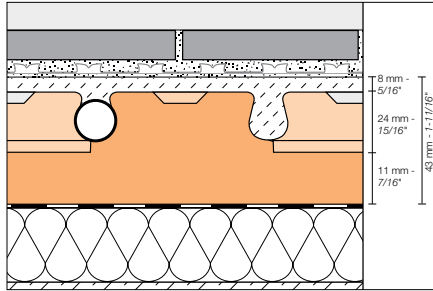
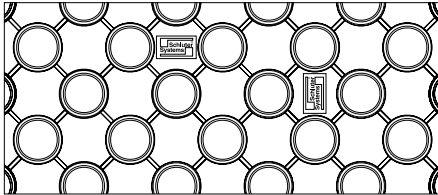

<b>Schluter®-BEKOTEC</b>			
Studded screed panel			35 mm - 1-3/8"
Item No.	Dimensions/Sheet	Packaging	\$ / Box
EN/US/P	61 x 122 cm = 0.74 m <sup>2</sup> - 24" x 48" = 8 ft <sup>2</sup>	12 sheets / box	235.07

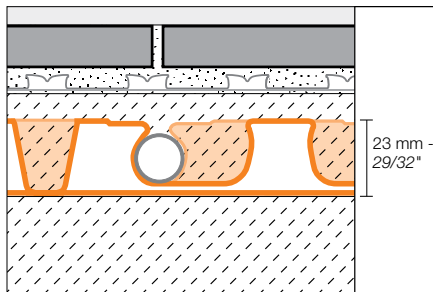

<b>Schluter®-BEKOTEC-F</b>			
Studded screed panel			23 mm - 29/32"
Item No.	Dimensions/Sheet	Packaging	\$ / Box
EN23F10	120 x 90 cm = 1.08 m <sup>2</sup> 47-1/4" x 35-7/16" = 11.63 ft <sup>2</sup>	10 sheets / box	364.38



**BRS**



**BRSK**



**BRS/KF**



**BRS/KSF**



<b>Schluter®-BEKOTEC-BRS</b>		
Edge strip for conventional screed		
Item No.	Dimensions	\$ / Roll
BRS 810	50 m roll: 10 cm wide x 8 mm thick 164' roll: 4" wide x 5/16" thick	87.44

<b>Schluter®-BEKOTEC-BRSK</b>		
Edge strip for conventional screed, with adhesive strip		
Item No.	Dimensions	\$ / Roll
BRSK 810	50 m roll: 10 cm wide x 8 mm thick 164' roll: 4" wide x 5/16" thick	113.67

<b>Schluter®-BEKOTEC-BRS/KF</b>		
Edge strip for poured screeds, with PE-adhesive leg		
Item No.	Dimensions	\$ / Roll
BRS 808 KF	25 m roll: 8 cm wide x 8 mm thick 82' roll: 3-1/8" wide x 5/16" thick	165.13

<b>Schluter®-BEKOTEC-BRS/KSF</b>		
Self-supporting edge strip for poured screed, with PE-adhesive leg		
Item No.	Dimensions	\$ / Roll
BRS 808 KSF	25 m roll: 8 cm wide x 8 mm thick 82' roll: 3-1/8" wide x 5/16" thick	222.95

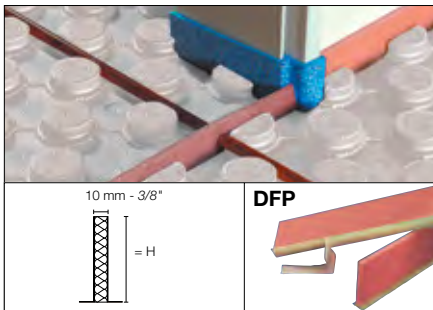

<b>Schluter®-DILEX-DFP</b>		
Length = 1 m - 3' 3"		
Movement joint profile for installation at door areas or for dividing screed surfaces		
H = mm - in.	Item No.	\$ / Length
60 - 2-3/8	DFP 6/100	16.85
80 - 3-1/8	DFP 8/100	20.21
100 - 4	DFP 10/100	23.56

**Schluter®-BEKOTEC-THERM-RH 75**

**Schluter®-BEKOTEC-THERM-RH 75** is a PVC clamp used to attach radiant heating tubes to the BEKOTEC-EN/US/P (1-3/8" - 35 mm)-thick panels. While the studs on the BEKOTEC panel are designed to hold the tubes in place, the clamp is especially useful for forming 45° angles with heating tubes in the studded panel.



<b>Schluter®-BEKOTEC-THERM-RH 75</b>		
Heating Clamps		
Item No.	Quantity	\$ / pkg
BTZRH75/100	100 units / pkg	70.32





## Schluter® Setting Materials

### Premium quality thin-set mortars & primer

Schluter Systems' thin-set mortars are specifically formulated for use with Schluter membranes and boards. Unmodified, modified, and rapid-setting versions are available. All are sag-resistant, smooth and creamy, easy to handle and spread, and suitable for use with ceramic, porcelain, and stone tile, including large and heavy tile, in conjunction with Schluter Systems' uncoupling and waterproofing membranes (e.g., DITRA, DITRA-HEAT, and KERDI), the Schluter Shower System, and KERDI-BOARD.

PRIMER-U is a ready-to-use universal primer used to enhance adhesion of mortars for hard-to-bond substrates such as gypsum underlayment, existing tile, terrazzo, steel (e.g. raised access panels), flooring adhesive residue, concrete with curing compounds, latex paint, and glass tile.



## Schluter®-SET

**Schluter®-SET** is a premium unmodified thin-set mortar specifically formulated for use with Schluter® membranes and boards. It is sag-resistant, smooth and creamy, and easy to handle and spread. Schluter®-SET is suitable for use with ceramic, porcelain, and stone tile, including large and heavy tile, in conjunction with Schluter®-Systems' uncoupling and waterproofing membranes (e.g., DITRA, DITRA-HEAT, and KERDI), the Schluter®-Shower System, and Schluter®-KERDI-BOARD.

Schluter®-SET meets the requirements of ANSI A118.1T, and is available in both grey and white.



<b>Schluter®-SET</b>			
Premium unmodified mortar			
Item No.	Color	Weight	\$
SET50G	Grey	22.7 kg - 50 lbs	Please contact your local Schluter supplier for pricing.
SET50W	White	22.7 kg - 50 lbs	

**⚠ WARNING:** Cancer and Reproductive Harm – [www.P65Warnings.ca.gov](http://www.P65Warnings.ca.gov)

## Schluter®-ALL-SET

**Schluter®-ALL-SET** is a specialized modified thin-set mortar specifically formulated for use with Schluter® membranes and boards. It is engineered for use both under and over all DITRA and KERDI products. It is sag-resistant, smooth and creamy, and easy to handle and spread. ALL-SET is suitable for use with ceramic, porcelain, and stone tile, including large and heavy tile, in conjunction with Schluter®-Systems' uncoupling and waterproofing membranes (e.g., DITRA, DITRA-HEAT, and KERDI), the Schluter®-Shower System, and Schluter®-KERDI-BOARD.

ALL-SET meets the requirements of ANSI A118.4T, A118.11, and A118.15T, and is available in both grey and white.



<b>Schluter®-ALL-SET</b>			
Specialized modified mortar			
Item No.	Color	Weight	\$
SETA50G	Grey	22.7 kg - 50 lbs	Please contact your local Schluter supplier for pricing.
SETA50W	White	22.7 kg - 50 lbs	

**⚠ WARNING:** Cancer and Reproductive Harm – [www.P65Warnings.ca.gov](http://www.P65Warnings.ca.gov)

## Schluter®-FAST-SET

**Schluter®-FAST-SET** is a specialized rapid-setting modified thin-set mortar specifically formulated for use with Schluter® membranes and boards. It is engineered for use both under and over all DITRA and KERDI products. FAST-SET is ready to grout in 4 hours for fast-track projects. It is sag-resistant, smooth and creamy, and easy to handle and spread. FAST-SET is suitable for use with ceramic, porcelain, and stone tile, including large and heavy tile, in conjunction with Schluter®-Systems' uncoupling and waterproofing membranes (e.g., DITRA, DITRA-HEAT, and KERDI), the Schluter®-Shower System, and Schluter®-KERDI-BOARD.

FAST-SET meets the requirements of ANSI A118.4TF, A118.11, and A118.15TF, and is available in both grey and white.



<b>Schluter®-FAST-SET</b>			
Specialized rapid-setting mortar			
Item No.	Color	Weight	\$
SETF50G	Grey	22.7 kg - 50 lbs	Please contact your local Schluter supplier for pricing.
SETF50W	White	22.7 kg - 50 lbs	

**⚠ WARNING:** Cancer and Reproductive Harm – [www.P65Warnings.ca.gov](http://www.P65Warnings.ca.gov)



**Quantity per pallet is 56 bags. Minimum order is 4 pallets.**  
**Special freight conditions apply, please see Conditions of Sale on pages 191-192 for details.**  
**Bundle offers for thin-set pallets with other products (i.e. DITRA and KERDI) are available, and are eligible for free shipping.**  
**Please consult a Schluter Sales Representative for more details.**



### Suitable Uses

Schluter®-DITRA and DITRA-HEAT over	Schluter®-SET	Schluter®-ALL-SET	Schluter®-FAST-SET
Plywood/OSB	X	✓	✓
Concrete	✓	✓	✓
Gypsum	✓	✓	✓
Vinyl flooring	X	X	✓
Schluter®-KERDI over			
Gypsum board	✓	✓	✓
Cement backerboard	✓	✓	✓
Fiber-cement board	✓	✓	✓
Portland cement mortar	✓	✓	✓
KERDI-SHOWER prefabricated substrates	✓	✓	✓
TILE over DITRA, DITRA-HEAT, KERDI and KERDI-BOARD			
Ceramic	✓	✓	✓
Porcelain	✓	✓	✓
Natural stone (e.g., granite, marble, etc.)	✓	✓	✓

- For Schluter®-Systems applications, refer to the Schluter®-DITRA, Schluter®-DITRA-HEAT, and Schluter®-Shower System Installation Handbooks.
- For other applications, refer to TCNA Handbook for Ceramic, Glass, and Stone Tile Installation and TTMAC Specification Guide 09 30 00 Tile Installation Manual.
- Contact Schluter®-Systems Technical Services for installation of glass tile, resin-backed tile, and/or moisture sensitive stone.

✓ = Approved use    X = Not recommended

### Coverage

Membrane-to-substrate		
Schluter®-DITRA-TROWEL 4.5 mm x 4.5 mm - 11/64" x 11/64"	Schluter®-DITRA-HEAT/-XL-TROWEL 6 mm x 6 mm - 1/4" x 1/4"	Schluter®-KERDI-TROWEL 3 mm x 3 mm - 1/8" x 1/8"
13.9 m <sup>2</sup> - 150 ft <sup>2</sup>	9.3 m <sup>2</sup> - 100 ft <sup>2</sup>	18.6 m <sup>2</sup> - 200 ft <sup>2</sup>

Tile-to-membrane			
Trowel	Schluter®-DITRA/DITRA-HEAT	Schluter®-DITRA-XL	Schluter®-KERDI/KERDI-BOARD
6 mm x 6 mm - 1/4" x 1/4"	5.6 - 6.5 m <sup>2</sup> - 60 - 70 ft <sup>2</sup>	4.2 - 5.1 m <sup>2</sup> - 45 - 55 ft <sup>2</sup>	8.4 - 9.3 m <sup>2</sup> - 90 - 100 ft <sup>2</sup>
6 mm x 9.5 mm - 1/4" x 3/8"	3.7 - 4.6 m <sup>2</sup> - 40 - 50 ft <sup>2</sup>	3.3 - 4.2 m <sup>2</sup> - 35 - 45 ft <sup>2</sup>	5.1 - 6.0 m <sup>2</sup> - 55 - 65 ft <sup>2</sup>
12.5 mm x 12.5 mm - 1/2" x 1/2"	2.8 - 3.7 m <sup>2</sup> - 30 - 40 ft <sup>2</sup>	2.3 - 3.3 m <sup>2</sup> - 25 - 35 ft <sup>2</sup>	3.7 - 4.6 m <sup>2</sup> - 40 - 50 ft <sup>2</sup>
19 mm - 3/4"	2.3 - 3.3 m <sup>2</sup> - 25 - 35 ft <sup>2</sup>	1.9 - 2.8 m <sup>2</sup> - 20 - 30 ft <sup>2</sup>	2.8 - 3.7 m <sup>2</sup> - 30 - 40 ft <sup>2</sup>

Values are approximate

## Schluter®-PRIMER-U

**Schluter®-PRIMER-U** is a ready-to-use, one-component, solvent-free, 100% acrylic, water-based, universal primer. It is used to enhance adhesion properties when applying Schluter thin-set mortars to difficult-to-bond-to surfaces such as gypsum underlayment, raised access panels, and existing tile. PRIMER-U is suitable for use with Schluter SET, ALL-SET, and FAST-SET thin-set mortars, as well as DITRA-HEAT-PS and DITRA-HEAT-DUO-PS peel and stick membranes in interior applications where increased adhesion is required over various porous and non-porous substrates. PRIMER-U is freeze/thaw stable.

PRIMER-U was evaluated according to Rule 1168 from the South Coast Air Quality Management District and found to comply with the VOC requirements.

### Suitable Substrates:

- Gypsum underlayment
- Concrete
- Existing tile
- Glass tile
- Plywood and OSB
- Terrazzo
- Steel
- VCT flooring
- Well-bonded flooring adhesive residue
- Latex paint
- Epoxy
- Aluminum
- Resin-backed mosaic tiles
- Asphalt-based cutback adhesive



<b>Schluter®-PRIMER-U</b>			
<b>Universal primer</b>			
<b>Item No.</b>	<b>Quantity</b>	<b>Coverage</b>	<b>\$ / Unit</b>
PRMU1	3.78 L – 1 Gal.	23 - 51 m <sup>2</sup> – 250 - 550 ft <sup>2</sup>	71.60
PRMU5	18.9 L – 5 Gal.	116 - 255 m <sup>2</sup> – 1250 - 2750 ft <sup>2</sup>	286.42

**⚠ WARNING:** Cancer and Reproductive Harm – [www.P65Warnings.ca.gov](http://www.P65Warnings.ca.gov)



**The case quantity of the 1 gallon (3.78 L) format of PRIMER-U (PRMU1) is 4 units.**



### Schluter®-TROWEL

The **Schluter®-DITRA-TROWEL**, **KERDI-TROWEL**, and **DITRA-HEAT/-DITRA-XL-TROWEL** feature square-notched designs to effectively install DITRA, KERDI, DITRA-XL, DITRA-HEAT, and DITRA-HEAT-DUO, respectively.

DITRA-TROWEL features a 11/64" x 11/64" (4.5 mm x 4.5 mm) square notch.

KERDI-TROWEL features a 1/8" x 1/8" (3 mm x 3 mm) square notch.

DITRA-HEAT/-DITRA-XL-TROWEL features a 1/4" x 1/4" (6 mm x 6 mm) square notch.

All Schluter® Trowels are made of uncoated stainless steel, making them even more durable.



Schluter®-TROWEL			
Item No.	Notch Size	Units / Pkg	\$ / Pkg
<b>KERDI</b>			
TRL-KER	3 mm x 3 mm - 1/8" x 1/8"	1 unit	33.32
TRL-KER6	3 mm x 3 mm - 1/8" x 1/8"	6 units	199.92
<b>DITRA</b>			
TRL-DIT	4.5 mm x 4.5 mm - 11/64" x 11/64"	1 unit	33.32
TRL-DIT6	4.5 mm x 4.5 mm - 11/64" x 11/64"	6 units	199.92
<b>DITRA-HEAT/-DITRA-XL</b>			
TRL-DHXL	6 mm x 6 mm - 1/4" x 1/4"	1 unit	33.32
TRL-DHXL6	6 mm x 6 mm - 1/4" x 1/4"	6 units	199.92

### Schluter®-DITRA-ROLLER

**Schluter®-DITRA-ROLLER** is used to embed DITRA and DITRA-HEAT membranes in the bond coat during installation. The lightweight DITRA-ROLLER features a 14-1/2" (37 cm) wide roller and a shelf for placing 50 to 75 lbs of weight (e.g., bag of thin-set mortar or grout, box of tiles, etc.). Between uses, it can be conveniently disassembled for transport and storage.



Schluter®-DITRA-ROLLER	
Item No.	\$ / Unit
DIRO	257.94



### Schluter®-SNIPS

Schluter®-SNIPS are specifically designed to cut PVC trim profiles.



Schluter®-SNIPS	
Item No.	\$ / Unit
PSF	89.04
Replacement blade	
PS 90/45 EK	27.25

### Schluter®-PROCUT-TSM

Schluter®-PROCUT-TSM is a cutting wheel with a diameter of 4-1/2" (115 mm) for conventional angle grinders. It produces especially clean cuts of stainless steel, aluminum, and brass.



Schluter®-PROCUT-TSM	
Item No.	\$ / Unit
TSM 115/1	14.36



## Schluter®-Systems Tools 2-Year Limited Warranty

**COVERAGE AND CONDITIONS:** Subject to the conditions and limitations as stated hereinafter, Schluter®-Systems\* warrants that Schluter®-Systems Tools (the "Products")\*\* will be free from manufacturing defects in materials and workmanship for a period of two (2) years from the date of purchase only when the Products have been used for their intended purpose in accordance with the Schluter®-Systems Illustrated Price List. Abnormal use, including but not limited to, misuse, accident, modification, unreasonable use, abuse, neglect, lack of maintenance, or use after the product is significantly worn, is not covered by this warranty. Consumable Products or consumable parts of Products are warranted, at the time of sale, only against defects in workmanship or materials that prevent their use. Consumable products or parts are goods reasonably expected to be used up or damaged during normal use, including but not limited to trowels, cutting blades, and cutting wheels. This warranty does not cover normal wear and tear or defects revealed by normal wear and tear.

**RESOLUTION:** If the Products fail to meet this warranty, then the owner's exclusive remedy and the sole obligation of Schluter®-Systems, at its election, shall be to a) repair or replace the failed Products or b) pay an amount not to exceed the original cost of the Products verified to be defective.

**DISCLAIMER:** THERE ARE NO WARRANTIES BEYOND THIS EXPRESSED WARRANTY AS STATED ABOVE. ALL OTHER WARRANTIES, REPRESENTATIONS OR CONDITIONS, EXPRESSED OR IMPLIED, ARE DISCLAIMED AND EXCLUDED, INCLUDING WARRANTIES, REPRESENTATIONS OR CONDITIONS OF **MERCHANTABILITY** OR FITNESS FOR A PARTICULAR PURPOSE ARISING BY STATUTE OR OTHERWISE BY LAW OR FROM A COURSE OF DEALING OR USAGE OF TRADE. SCHLUTER®-SYSTEMS EXCLUDES AND IN NO EVENT SHALL HAVE ANY LIABILITY FOR LOST PROFITS OR ANY OTHER INDIRECT, SPECIAL, INCIDENTAL, PUNITIVE, EXEMPLARY, OR CONSEQUENTIAL DAMAGES, ARISING OUT OF OR OTHERWISE CONNECTED TO FAILURE OF THE PRODUCTS, NOR MISUSE OF THE PRODUCTS, REGARDLESS OF ANY STRICT LIABILITY, ACTIVE OR PASSIVE NEGLIGENCE OF SCHLUTER®-SYSTEMS, AND REGARDLESS OF THE LEGAL THEORY (CONTRACT OR TORT OR EXTRA-CONTRACTUAL OR OTHER), NOR FROM ACTS OF WAR, TERRORISM, FIRES, EXPLOSIONS, ACTS OF GOD, INTENTIONAL ACTS OF DESTRUCTION OR ANY LOSSES DUE TO CAUSES UNRELATED TO THE PRODUCT OR DELAYS, OR ANY OTHER INCIDENTAL OR CONSEQUENTIAL DAMAGES. THIS WARRANTY IS GIVEN IN LIEU OF ANY OTHER WARRANTY EXPRESSED OR IMPLIED. THE REMEDIES CONTAINED HEREIN ARE THE ONLY REMEDIES AVAILABLE FOR BREACH OF THIS WARRANTY. THIS LIMITED WARRANTY GIVES YOU SPECIFIC LEGAL RIGHTS, SOME STATES AND PROVINCES DO NOT ALLOW DISCLAIMERS OR OTHER RESTRICTIONS OF IMPLIED WARRANTIES SO SOME OF THE ABOVE LIMITATIONS MAY NOT APPLY TO YOU.

**TRANSFERRABILITY:** This Limited Warranty extends ONLY to the original intended owner (defined as original purchaser of the tool – herein after referred to as "Owner") and is not transferable or assignable, unless otherwise prohibited by specific state or provincial law.

**MODIFICATIONS TO WARRANTY:** No changes or modification of any terms or conditions of this warranty are allowed unless authorized by written agreement and signed by the Technical Director or an Officer of Schluter®-Systems.

**EFFECTIVE DATE:** This warranty shall supersede and replace any and all prior oral or written warranties, agreements, or other such representations made by or on behalf of Schluter®-Systems relative to the Products or the use of the Products and shall apply to any purchase occurring on or after January 1, 2013.

**CLAIMS ON THIS LIMITED WARRANTY:** To make a claim under this Limited Warranty, the owner must provide Schluter®-Systems with written notice within 30 days of any alleged defect in the Products covered by this Limited Warranty, together with date and proof of purchase of the Products, failing which this Limited Warranty shall be of no legal effect. Schluter®-Systems reserves the right at its election and as a condition of this Limited Warranty to inspect the alleged failed and defective condition.

All U.S. Claims shall be sent to:

Schluter Systems L.P.  
Attn: Warranty Claims Dept.  
194 Pleasant Ridge Road  
Plattsburgh, NY 12901-5841

All Canadian Claims shall be sent to:

Schluter Systems (Canada), Inc.  
Attn: Warranty Claims Dept.  
21100 ch. Ste-Marie  
Ste-Anne-de-Bellevue, QC H9X 3Y8

\*For the purpose of this warranty Schluter Systems, L.P. shall provide the warranty for all products for end users located in the United States, and SchluterSystems (Canada) Inc. shall provide the warranty for all products for end users located in Canada. This warranty is limited to sales of the products made in and intended for use in the United States and Canada.

\*\*Schluter®-Systems Tools (the "Products"): The products are defined to include all Schluter®-Systems tools referred to in the Schluter®-Systems Illustrated Price List.

## Material Properties and Areas of Application

Schluter® profiles are resistant to most chemicals encountered in tiled environments. In special cases, the suitability of a proposed type of material must be verified based on the anticipated chemical, mechanical, and/or other stresses. Exceptions and special considerations are listed below.

**Stainless steel** profiles are roll-formed, resulting in a slightly different contour from those made of extruded brass or aluminum. Stainless steel can sustain high mechanical stresses and is particularly well suited for applications requiring resistance against chemicals and acids; for example in the food industry, breweries, dairies, commercial kitchens, and hospitals, as well as in residential applications. Typically, the profiles are formed using stainless steel 304 (1.4301 = V2A). For more severe chemical exposure, such as de-icing salts and chemicals used in swimming pools, we recommend the use of stainless steel 316 L (1.4404 = V4A), which offers even higher corrosion resistance than the 304. Even stainless steel cannot withstand all chemical exposures, such as hydrochloric acid, hydrofluoric acid or certain chlorine, chloride and brine concentrations.

**Solid brass** sustains high levels of mechanical stress; for example, as edge protection for outside wall corners or edges of surface coverings. Brass is resistant to most chemicals used in tiled environments. Solid brass that is

exposed to air will oxidize, resulting in a natural patina. If exposed to moisture or aggressive substances, heavy oxidation and spotting may occur.

**Chrome-plated brass** is especially suited for wall corners and finishing applications. It is ideal for matching chrome fixtures. Surface areas must be protected against abrasion or scratching.

**Aluminum** profiles must be tested to verify their suitability if chemical stresses are anticipated. Cementitious materials, in conjunction with moisture, become alkaline. Since aluminum is sensitive to alkaline substances, exposure to the alkali (depending on the concentration and duration of exposure) may result in corrosion (aluminum hydroxide formation). Therefore, it is important to remove mortar or grout residue from visible surfaces. In addition, ensure that the profile is solidly embedded in the setting material and that all cavities are filled to prevent the collection of alkaline water.

**Anodized aluminum** profiles feature an anodized layer that retains a uniform appearance during normal use. The surface, however, is susceptible to scratching and wear and may be damaged by grout or setting material. Therefore, these materials must be removed immediately. Otherwise, the description regarding aluminum applies.

**Color-coated aluminum** and **textured color-coated aluminum** are pretreated (chromated) aluminum that is color-coated with a polyurethane powder coat. The coating is color-stable, UV-resistant, and suitable for exterior use. Protect the profile against abrasion or scratching.

**PVC** profiles are made of pre-colored, rigid PVC that resists bending or scratching. The material is UV-resistant, though not permanently color-stable, in exterior applications. PVC profiles are not suited for corners or transitions subjected to heavy mechanical stresses (e.g., at step edges or floor transitions).

**Note:** Due to variations in raw materials and manufacturing, the exact color, shade, and/or texture of individual profiles and related components (e.g., corners, end caps, connectors, etc.) may vary. The customer must inspect the products upon delivery and notify Schluter in writing of any physical damage to the products or nonconformity with the purchase order or invoice.



## STAINLESS STEEL, CHROME-PLATED BRASS, AND SOLID BRASS

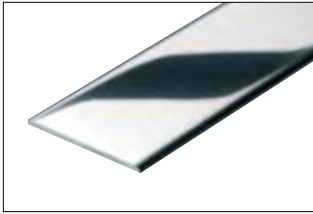

**E** Stainless steel 304 (1.4301=V2A)  
High-grade stainless steel 316 L  
(1.4404=V4A)

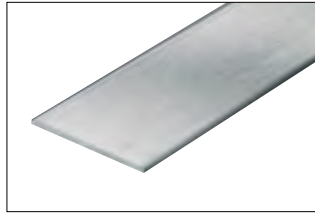

**EB** Brushed stainless steel

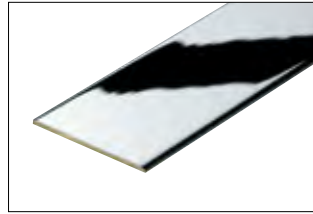

**MC** Chrome-plated solid brass

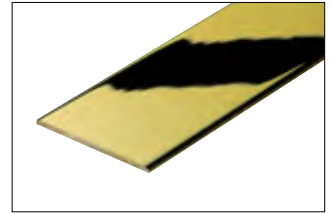

**M** Solid brass

## ALUMINUM



**A** Aluminum

## ANODIZED ALUMINUM

### Polished and bright anodized aluminum

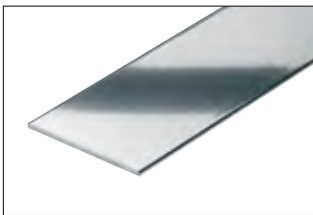

**ACG** Polished chrome  
anodized aluminum  
**ACB** Bright chrome  
anodized aluminum

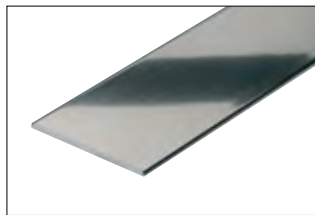

**ATG** Polished nickel  
anodized aluminum

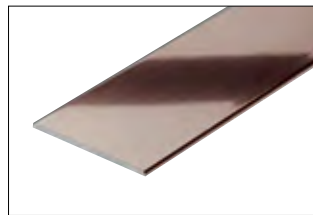

**AKG** Polished copper  
anodized aluminum

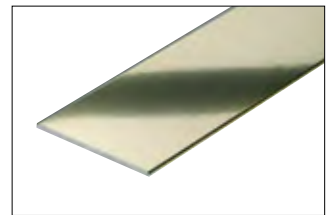

**AMG** Polished brass  
anodized aluminum

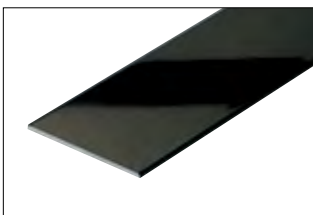

**AGSG** Bright black  
anodized aluminum

**Note:** Due to variations in raw materials and manufacturing, the exact color, shade, and/or texture of individual profiles and related components (e.g., corners, end caps, connectors, etc.) may vary. The customer must inspect the products upon delivery and notify Schluter in writing of any physical damage to the products or nonconformity with the purchase order or invoice.

## Satin anodized aluminum

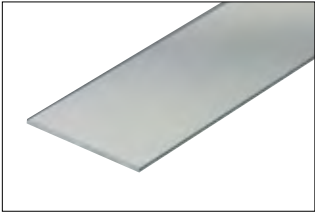

**AE** Satin anodized aluminum

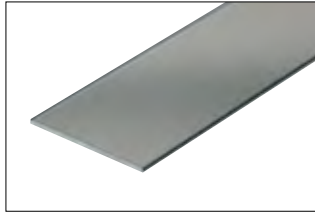

**AT** Satin nickel anodized aluminum

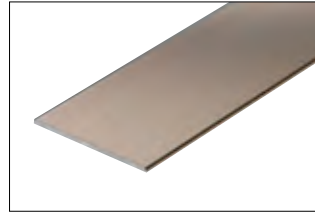

**AK** Satin copper anodized aluminum

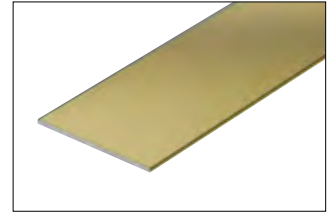

**AM** Satin brass anodized aluminum

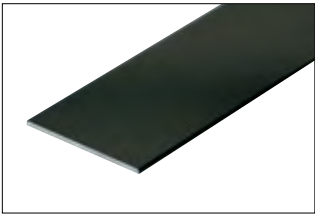

**AGR** Graphite anodized aluminum

## Brushed anodized aluminum



**ACGB** Brushed chrome anodized aluminum



**ATGB** Brushed nickel anodized aluminum



**AKGB** Brushed copper anodized aluminum



**AMGB** Brushed brass anodized aluminum



**ABGB** Brushed antique bronze anodized aluminum

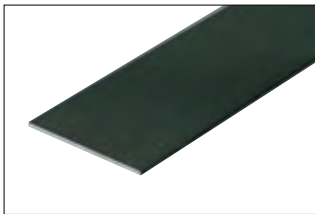

**AGRB** Brushed graphite anodized aluminum



**AGSB** Brushed black anodized aluminum

**Note:** Due to variations in raw materials and manufacturing, the exact color, shade, and/or texture of individual profiles and related components (e.g., corners, end caps, connectors, etc.) may vary. The customer must inspect the products upon delivery and notify Schluter in writing of any physical damage to the products or nonconformity with the purchase order or invoice.

## TEXTURED COLOR-COATED ALUMINUM



**MBW** Matte white textured color-coated aluminum RAL 9003



**TSI** Ivory textured color-coated aluminum



**TSBG** Greige textured color-coated aluminum



**TSC** Cream textured color-coated aluminum



**TSB** Beige textured color-coated aluminum



**TSR** Rustic brown textured color-coated aluminum



**TSOB** Bronze textured color-coated aluminum

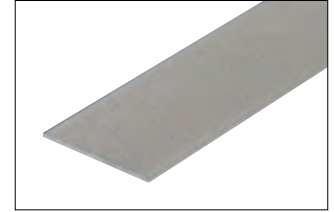

**TSSG** Stone grey textured color-coated aluminum



**TSG** Pewter textured color-coated aluminum



**TSLA** Light anthracite textured color-coated aluminum



**TSDA** Dark anthracite textured color-coated aluminum

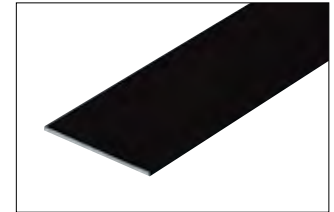

**MGS** Matte black textured color-coated aluminum RAL 9005

**Note:** Due to variations in raw materials and manufacturing, the exact color, shade, and/or texture of individual profiles and related components (e.g., corners, end caps, connectors, etc.) may vary. The customer must inspect the products upon delivery and notify Schluter in writing of any physical damage to the products or nonconformity with the purchase order or invoice.

## COLOR-COATED ALUMINUM

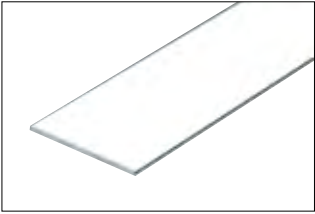

**BW** Bright white  
color-coated aluminum  
RAL 9003

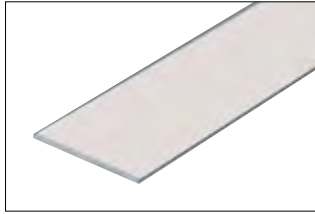

**W** White  
color-coated aluminum  
RAL 9010

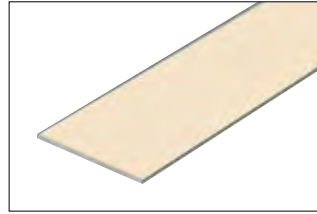

**SP** Sand pebble  
color-coated aluminum  
RAL N/A

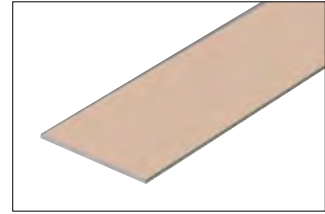

**BH** Bahama  
color-coated aluminum  
RAL N/A

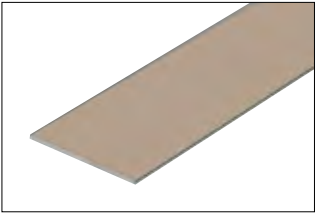

**HB** Light beige  
color-coated aluminum  
RAL 1019

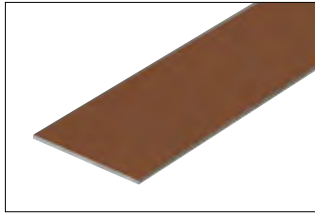

**RB** Red brown  
color-coated aluminum  
RAL 8003



**SB** Black brown  
color-coated aluminum  
RAL 8019

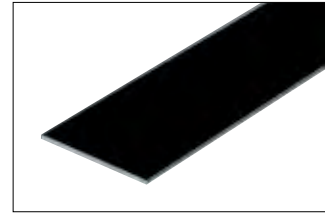

**GS** Black  
color-coated aluminum  
RAL 9011

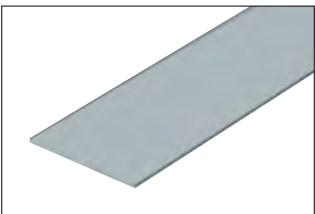

**HG** Light grey  
color-coated aluminum  
RAL 7035



**PG** Classic grey  
color-coated aluminum  
RAL N/A

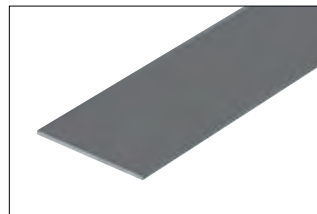

**G** Grey  
color-coated aluminum  
RAL 7030

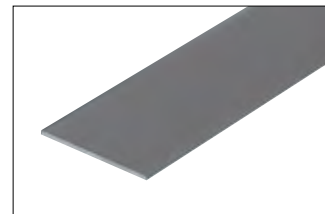

**GM** Metallic grey  
color-coated aluminum  
RAL 9006

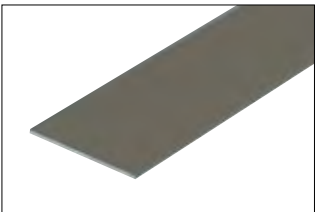

**QG** Quartz grey  
color-coated aluminum  
RAL 7039

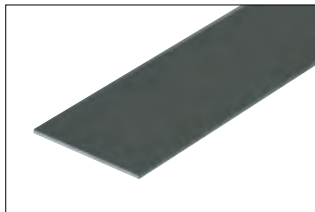

**VG** Traffic grey  
color-coated aluminum  
RAL 7043

**Note:** Due to variations in raw materials and manufacturing, the exact color, shade, and/or texture of individual profiles and related components (e.g., corners, end caps, connectors, etc.) may vary. The customer must inspect the products upon delivery and notify Schluter in writing of any physical damage to the products or nonconformity with the purchase order or invoice.

# PVC

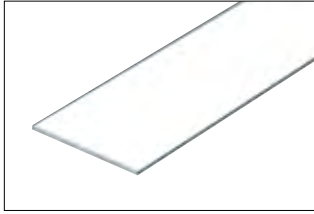

**BW** Bright white  
PVC  
RAL 9003

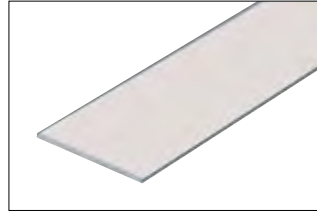

**W** White  
PVC  
RAL 9010

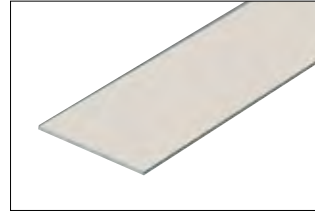

**C** Cream  
PVC  
RAL N/A

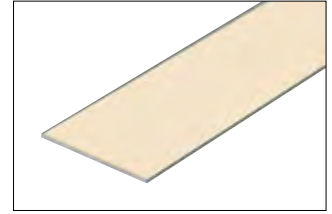

**SP** Sand pebble  
PVC  
RAL N/A

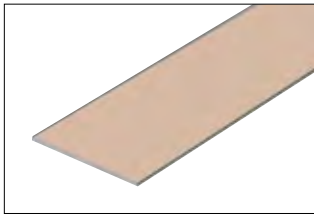

**BH** Bahama  
PVC  
RAL N/A

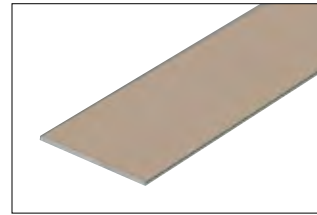

**HB** Light beige  
PVC  
RAL 1019

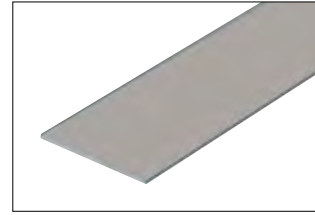

**FG** Grout grey  
PVC  
RAL N/A



**SG** Stone grey  
PVC  
RAL N/A

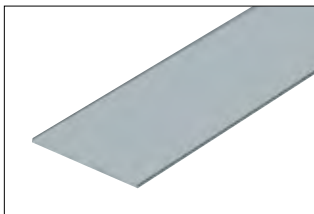

**HG** Light grey  
PVC  
RAL 7035

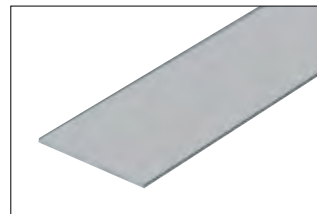

**PG** Classic grey  
PVC  
RAL N/A



**G** Grey  
PVC  
RAL 7030

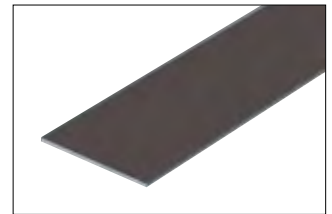

**DA** Dark anthracite  
PVC  
RAL N/A

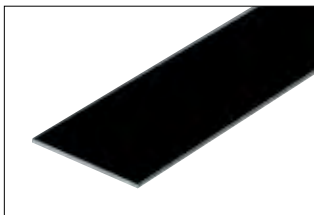

**GS** Black  
PVC  
RAL 9011

**Note:** Due to variations in raw materials and manufacturing, the exact color, shade, and/or texture of individual profiles and related components (e.g., corners, end caps, connectors, etc.) may vary. The customer must inspect the products upon delivery and notify Schluter in writing of any physical damage to the products or nonconformity with the purchase order or invoice.



Products	Anodized Aluminum													Stainless steel					Insert Color																
	Finishes	A	ABGB	ACB	ACG	ACGB	AE	AGR	AGRB	AGSB	AGSG	AK	AKG	AKGB	AM	AMG	AMGB	AT	ATG	ATGB	E	EB	CG	G	GS	HB	NB	T							
Stair-nosing profiles																																			
RONDEC-STEP																																			
SCHIENE-STEP																																			
TREP-FL																																			
TREP-E/-EK																																			
TREP-G/-GK																																			
TREP-SE/-S/-B																																			
TREP-TAP																																			
PVC and Color-coated Aluminum																																			
Products	Colors	BH	BW	C	DA	FG	G	GM	GS	HB	HG	PG	QG	RB	SB	SG	SP	VG	W																
				(PVC only)				(Alum only)						(Alum only)		(PVC only)		(Alum only)																	
Movement joint and cove-shaped profiles																																			
DILEX-EKE																																			
DILEX-BWA																																			
DILEX-HKW																																			
DILEX-HK																																			
DILEX-PHK																																			
DILEX-BWS																																			
DILEX-BWB																																			
DILEX-AS																																			
Textured color-coated aluminum																																			
Products	Finishes	A	ABGB	ACB	ACG	ACGB	AE	AGR	AGRB	AGSB	AGSG	AK	AKG	AKGB	AM	AMG	AMGB	AT	ATG	ATGB	E	EB	MC	MBW	MGS	TSB	TBBG	TSC	TSDA	TSG	TSI	TSLA	TSOB	TSR	TSSG
Movement joint and cove-shaped profiles																																			
DILEX-AHK																																			
DILEX-AHKA																																			
DILEX-EHK/-HKU																																			
DILEX-EDP																																			
DILEX-HKS																																			
DILEX-KSN																																			
DILEX-AKWS																																			
DILEX-KSA																																			
DILEX-EKSB																																			
Profiles for resilient floor and wall coverings																																			
VINPRO-S																																			
VINPRO-T																																			
VINPRO-U																																			
VINPRO-RO																																			
VINPRO-STEP																																			
VINPRO-STEP-R																																			

## Warranty Program Summary

All Schluter®-Systems products are covered under our warranty program. Products are warranted for the applicable term from the date of purchase only when the products are used and installed in accordance with the terms and conditions of the applicable Schluter®-Systems technical literature and industry standard guidelines that are not in conflict with the technical literature.

There are four different categories of warranties as follows:

### Systems

Systems are application based and include a variety of products that form an integrated system. Systems are defined by installation handbooks.

- Schluter®-DITRA and Schluter®-DITRA-XL uncoupling membranes
- Schluter®-DITRA-HEAT and Schluter®-DITRA-HEAT-PS electric floor warming system with integrated uncoupling technology
- Schluter®-Shower System

### Lifetime

When you install Schluter®-DITRA/DITRA-XL, the Schluter®-Shower System, KERDI/KERDI-DS, DITRA-HEAT/DITRA-HEAT-DUO or DITRA-HEAT-PS/DITRA-HEAT-DUO-PS with one of our Schluter thin-set mortars, your installation may be eligible for limited lifetime warranty coverage.

### Consolidated Products

Consolidated products are products with similar characteristics or functions that are grouped under a single warranty document. These product groups are defined by technical data sheets.

- Floor profiles
- Wall and countertop profiles
- Stair-nosing profiles
- Movement joints and cove-shaped profiles
- Resilient floor and wall covering profiles
- Schluter®-BEKOTEC modular screed panels
- Schluter®-KERDI-DRAIN and Schluter®-KERDI-LINE floor drains
- Schluter®-KERDI and Schluter®-KERDI-DS waterproofing membranes
- Schluter®-SET, Schluter®-ALL-SET and Schluter®-FAST-SET thin-set mortars

### Individual Products

Individual products are those that do not fit into a current consolidated product group and therefore have a separate warranty document. These products are defined by technical data sheets.

- Schluter®-KERDI-BOARD building panels
- Schluter®-REFLEECE removable fleece
- Schluter®-DITRA-HEAT-E thermostats
- Schluter®-KERDI-FIX adhesive/sealant
- Schluter®-PRIMER-U universal primer
- Tools

For complete warranty information, please see our website: [www.schluter.com/warranty](http://www.schluter.com/warranty).



# CONDITIONS OF SALE

## 1. Terms and Conditions

These terms and conditions of sale (hereinafter referred to as the "Terms") govern the sale of Products from Schluter Systems L.P. ("Schluter") to Customer where such products are to be used within the United States and its territories. "Products" is defined to mean the products identified on the order confirmation or invoice, whichever is issued later by Schluter to Customer; and "Customer" is defined to mean the purchasing entity identified on such documents. The Terms herein, the terms and conditions contained on any order confirmation and/or invoice, and the terms and conditions contained in any applicable Credit Application, and/or supply agreement between Schluter and Customer, if any, represent the final and complete agreement of Schluter and Customer as to the sale and purchase of Products (the "Agreement"). In the event of any conflicting terms or conditions in the Agreement, the supply agreement, if any, shall be deemed to control; in the absence of a supply agreement, the order confirmation shall be deemed to control. Any and all different or additional terms than those contained in the Agreement are rejected unless expressly accepted in writing by an authorized representative of Schluter.

## 2. Price and Payment

Payment terms are net thirty (30) days from invoice date. No payments shall be subject to any setoffs, deductions or claims. For any amounts not paid by Customer as of the due date, Customer shall be liable to pay interest on the amount due at a rate of 1.5% per month from due date until date of payment in addition to the principal amount. Regardless of any statement appearing on a check or otherwise, Schluter's acceptance of a payment in an amount less than that due shall in no way be an accord and satisfaction or prejudice Schluter's rights and remedies to collect the full amount due. Prices do not include sales taxes or other charges levied by any governmental authority upon the sale, use or transportation of the Products, all of which shall be paid by Customer, including, without limitation, applicable customs duties and tariffs. Prices quoted in the Price List Catalog are subject to change without prior notice.

For the most current version of the Price List, please visit [www.schluter.com](http://www.schluter.com).

## 3. Shipping/Title/Risk of Loss

Unless otherwise expressly set forth in writing by Schluter, all Products will be delivered Ex Works (as defined in Incoterms 2017 revision). Dates of shipments are estimated and not guaranteed. Title and risk of loss to Products shall transfer to Customer upon delivery in accordance with the applicable delivery terms. Any handling of the Products after transfer of risk of loss shall be at Customer's sole risk.

## 4. Freight and Shipping Charges

Prices quoted in the Price List Catalog include ground freight (best way) charges within the continental USA, save and except for purchase orders under \$10,000 gross at retail, to which freight charges according to the table below will be added thereto.

Ground Freight (Best Way) Charges				
Orders up to \$500	\$500 to \$1,500	\$1,500 to \$3,000	\$3,000 to \$5,000	\$5,000 to \$10,000
\$65	\$85	\$125	\$200	\$300

Schluter offers express shipping to the continental USA; please see applicable table below for options and pricing. Next day and second day shipping is also applicable for Alaska and Hawaii. Please note that "shipping days" represent business days.

Express Handling Freight Charges				
Gross order value at retail	up to \$500	\$500 to \$1,500	\$1,500 to \$3,000	\$3,000 to \$5,000
Next day	\$125	\$220	\$300	\$400
Second day	\$100	\$180	\$275	\$350
Third day	\$85	\$140	\$200	\$260

Express orders greater than \$5,000 gross at retail are charged actual freight.

Certain items with oversized shipping dimensions are not eligible for express shipping. Additionally, certain items (such as 10' profiles) are not eligible for parcel shipping and are subject to an additional \$300 charge unless combined with an order exceeding \$10,000 gross at retail.

Freight charges including air express handling charges are subject to change without prior notice. Please note that we are unable to accommodate third party transport billing.

Accessories:

Accessories include corners and caps for profiles and Rema kits up to \$500 gross at retail:

Regular ground handling	Next-day express handling
\$30	\$50

Accessory orders over \$500 gross at retail are subject to standard shipping charges.

KERDI-BOARD panels:

- 1 to 5 full pallets: \$150/pallet
- 6+ full pallets: free shipping

THIN-SET pallets: minimum order equals 4 full pallets (1 pallet equals 56 bags per item number)

- 4 to 14 full pallets: \$500 freight charge per order
- 15 pallets: free shipping

Bundle offers for thin-set pallets with other products (i.e. DITRA and KERDI) are available and are eligible for free shipping. Please consult with a Schluter Sales Representative for more details.

3rd party shipping (drop shipping):

- Orders to a third party will incur a 10% handling fee.
- THIN-SET only orders to a third party will incur a \$200 handling fee.

## 5. Product Inspection; Non-conformity

Customer must inspect the Products upon delivery and notify Schluter in writing of any physical damage to the Products or nonconformity with the purchase order or invoice. FAILURE TO INSPECT AND DELIVER WRITTEN NOTICE OF SUCH DAMAGE OR NONCONFORMITY WITHIN SUCH FORTY EIGHT (48) HOUR PERIOD SHALL CONSTITUTE IRREVOCABLE ACCEPTANCE OF THE DELIVERED PRODUCTS AND A WAIVER OF ANY DAMAGE OR NONCONFORMITY THAT WAS OR SHOULD HAVE BEEN DETECTED. Any use of the Products or any portion thereof shall constitute irrevocable acceptance of such Products. As Customer's sole remedy for any damaged or nonconforming Products of which Customer has delivered to Schluter timely notice of damaged or nonconforming Products, Schluter, at Schluter's sole election, shall either: (a) replace the damaged or nonconforming Products, or (b) refund the price paid by Customer to Schluter for such damaged or nonconforming Products. In no event shall Schluter be liable for costs of procurement or substitute Products by Customer, or for injury or damage to business, or loss of profits, nor shall Schluter be liable for any incidental, special, indirect, or consequential damages. Any Product images are for illustrative purposes only; any differences between Product images and actual Product received shall not constitute nonconforming Product.

## 6. Cancellations

If Customer fails to make payment in accordance, or otherwise comply, with all terms of the Agreement, Schluter may, at its option (and in addition to all other remedies), cancel any unshipped portion of Customer's order, without liability to Schluter, and Customer shall remain liable for all unpaid amounts. Subject only to Section 5 herein, orders, once accepted by Schluter, cannot be cancelled without Schluter's prior written consent, which may be granted or withheld in Schluter's sole and absolute discretion. In no event shall Schluter authorize the cancellation or deferment of shipment unless Schluter is indemnified against the loss resulting therefrom. Orders issued a tracking number are considered shipped; any cancellation or deferment will incur a 25% restocking fee.

## 7. Returns

Schluter shall not accept any returns unless it specifically authorizes such in writing, which may be granted or withheld in Schluter's sole and absolute discretion. Under no circumstances shall Schluter accept any returned Products after thirty (30) days from such Products' invoice date. Any authorized returns must be in resellable condition subject to inspection by Schluter prior to acceptance of same. All authorized returns shall incur a handling charge of 25%.

## 8. Special Orders

Customer will defend, at its own expense, any suit which may be brought against Schluter by reason of the manufacture or sale of special or non-stock Products made to Customer's specifications, including any third party proceedings. In the case of cancellation of orders of special or non-stock Products, Customer's cancellation may be conditioned upon Customer's payment in full of the price of finished Products. Schluter shall not accept any returns of special or non-stock Products.

## 9. Warranty and Damages Disclaimer

**a. Warranty** The Products are covered by product-specific warranties, available at [www.schluter.com](http://www.schluter.com) or Schluter's Warranties Page. The warranty that applies is the applicable warranty in effect for the Products as of the date of the proforma invoice, or if no proforma invoice, as of the date of the order acknowledgement for the Products (the "Written Warranty").

**b. Disclaimer** THE WRITTEN WARRANTY IS THE ONLY WARRANTY APPLICABLE TO THE PRODUCTS AND EXCLUDES ALL OTHER WARRANTIES, INCLUDING, WITHOUT LIMITATION, ANY IMPLIED WARRANTY OF MERCHANTABILITY OR FITNESS FOR A PARTICULAR PURPOSE, AND ANY IMPLIED WARRANTIES OTHERWISE ARISING FROM A COURSE OF DEALING OR USAGE OF TRADE, EXCEPT WHERE PURCHASE OF THE PRODUCTS IS SUBJECT TO CONSUMER PRODUCT WARRANTY LAWS, IN WHICH INSTANCES ANY APPLICABLE IMPLIED WARRANTIES ARE LIMITED TO THE PERIOD OF THE APPLICABLE WRITTEN WARRANTY, OR SUCH SHORTER PERIOD AS PERMITTED OR REQUIRED UNDER APPLICABLE LAW. IN NO EVENT WILL SCHLUTER BE LIABLE FOR ANY INCIDENTAL, SPECIAL, INDIRECT, OR CONSEQUENTIAL DAMAGES, HOWEVER CAUSED, WHETHER FOR BREACH OF CONTRACT, BREACH OF WARRANTY, TERMINATION, NEGLIGENCE, OR OTHERWISE, EVEN IF SCHLUTER SHALL HAVE BEEN ADVISED OF THE POSSIBILITY OF SUCH DAMAGES. Recommendations, advice, representations, warranties, commitments or agreements that are inconsistent with the foregoing disclaimer shall not be binding on Schluter unless in a writing signed by an authorized representative of Schluter. Schluter's only obligation is to provide the Products in the quantities ordered by Customer (which order is accepted by Schluter) without regard to the Products' appropriateness to Customer's application. Customer represents and warrants that Customer is not a "consumer" as defined by any applicable usury or consumer protection laws.

## 10. Delay/Force Majeure

Delay in delivery or nondelivery by Schluter shall not be a breach or default by Schluter if performance is delayed or made impracticable or impossible by the occurrence of any one or more of the following: (a) fire, flood, or other casualty, (b) war, riot, embargo, governmental regulation or martial law, (c) inability to obtain necessary materials from usual sources of supply, (d) shortage of transportation or delays in transit, (e) strike or other labor issue, and (f) other conditions not reasonably within Schluter's control, whether or not of a kind mentioned herein.

## 11. Choice of Law

For sales made in the United States or its territories, the Agreement (including, without limitation, these Terms) shall be governed by the State of New York, without regard for its choice of law provisions.

## 12. Arbitration

a. Any controversy, claim or dispute arising out of or in connection with the Agreement shall be settled by final and binding arbitration administered by the American Arbitration Association in accordance with its Commercial Arbitration Rules in Plattsburgh, Clinton County, state of New York and judgment on the award rendered by the arbitrator may be entered in any court having jurisdiction. The arbitration shall be heard by a single arbitrator appointed in accordance with the Commercial Arbitration Rules, and shall be conducted in English.

b. If a controversy or claim relates to or is the subject of a mechanic's or construction lien, Schluter may proceed in accordance with applicable law to preserve and enforce its lien rights. TO THE FULLEST EXTENT PERMITTED BY LAW, NOTWITHSTANDING ANY ARBITRATION RULE OR PROCEDURE, (A) NO CONTROVERSY OR CLAIM ARISING OUT OF OR RELATING TO THE AGREEMENT SHALL BE CONSOLIDATED OR JOINED WITH ANY OTHER PERSON'S CLAIM AND NO CLASS ACTION OR REPRESENTATIVE ACTIONS SHALL BE PERMITTED UNDER THE AGREEMENT, AND (B) IF ANY CLASS OR REPRESENTATIVE ACTION CANNOT BE WAIVED UNDER APPLICABLE LAW, THE PARTIES AGREE THAT SUCH ACTION SHALL BE ARBITRATED.

## 13. Miscellaneous

No amendment, alteration, variation, deletion, addition, and/or cancellation of these Terms made by Customer shall be of any force or effect unless reduced to writing and signed by a director of Schluter. If any clause, subclause, or other provision of these Terms is invalid under any statute or rule of law, such provision, to that extent only, shall be deemed to be omitted without affecting the validity of the remainder of the Terms. Customer shall pay to Schluter all costs of collection, including, without limitation, reasonable attorneys' fees, incurred by Schluter in enforcing the Agreement, including, without limitation, collecting any money due from Customer and enforcing Schluter's lien rights. No waiver by Schluter of any term or any obligation of Customer shall constitute a waiver of any other term or obligation. Customer shall not assign or transfer its rights or obligations under the Agreement without the prior written consent of Schluter. All of Customer's representations, warranties and indemnities under the Agreement shall survive the consummation of or the termination or cancellation of any purchase and sale of Products. Which party prepared the Agreement shall have no bearing on the construction or interpretation of the Agreement. Buyer will defend, at its own expense, any suit or legal proceeding, including any third party proceedings, which may be brought against Schluter by reason of the manufacture or sale of any special product(s) made to Buyer's specifications. These Terms supersede all prior versions of Schluter's Conditions of Sale. Schluter reserves the right in its sole discretion to amend these Terms from time to time and any such amended terms and conditions shall be binding on Customer. For the most current version of the Terms, please visit [www.schluter.com/terms](http://www.schluter.com/terms).

## **Copyright Notice**

The Schluter®-Systems Illustrated Price List is protected by copyright laws. Its entire content, including images and text, may not be reproduced, distributed, modified, reused, or otherwise used without the express written permission of Schluter®-Systems.

© 2023 Schluter Systems L.P. and affiliates. All Rights Reserved.

## **Trademark Notice**

All product names, logos and/or designs, including but not limited to those listed on our website, [www.schluter.com/trademarks](http://www.schluter.com/trademarks), are owned by Schluter Systems L.P. and/or affiliates. It may not be a complete list of trademarks owned by Schluter®-Systems as it does not list all common law trademarks and trademark applications or registrations worldwide. The unauthorized use or misuse of these trademarks is expressly prohibited and may be in violation of intellectual property rights which shall be enforced.

Scan here  
to download  
a digital copy

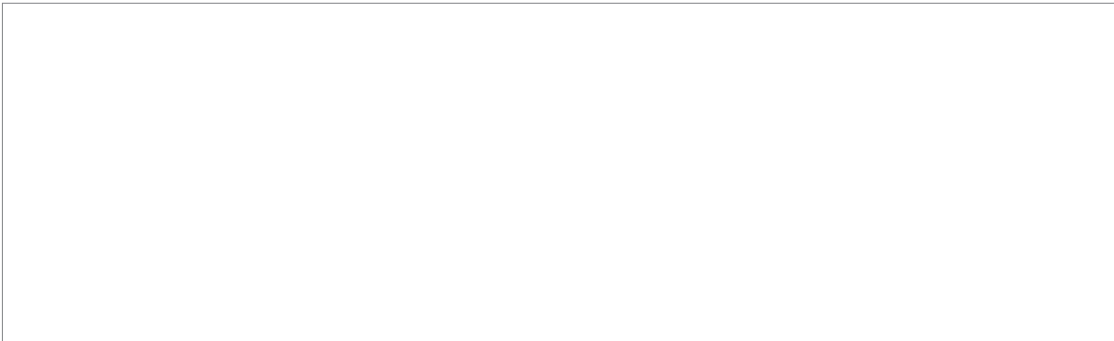

Schluter Systems L.P. • 194 Pleasant Ridge Road, Plattsburgh, NY 12901-5841  
Tel.: 800-472-4588 • Fax: 800-477-9783

[www.schluter.com](http://www.schluter.com)