

33 Meter Z-Fold Boom Pump

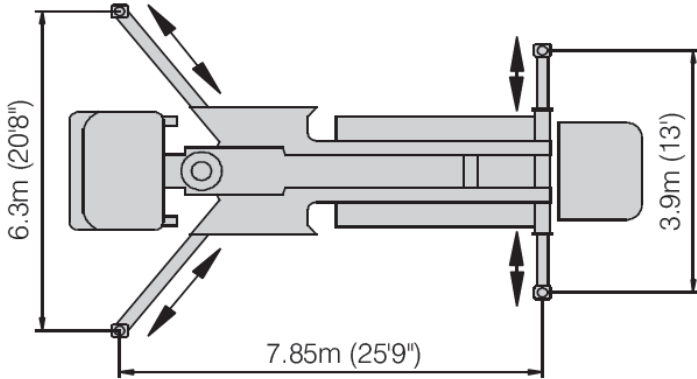

Specifications:

- Vertical Reach: 32.5 m (106'8")
- Horizontal Reach: 28.5 m (93'6")
- Reach from Front: 25.5 m (83'8")
- Unfolding Height: 7.6 m (24'11")
- 1st Section Length: 8.0 m (26'3")
- 2nd Section Length: 6.85 m (22'6")
- 3rd Section Length: 6.85 m (22'6")
- 4th Section Length: 6.8 m (22'4")
- Front Spread: 6.3 m (20'8")
- Rear Spread: 3.9 m (13')
- Vehicle Weight: 27,160 kg (59,880 lbs)
- Vehicle Length: 11.0 m (36'1")
- Max Outrigger Load: 37,000lbs (165KN)

