

The **essentials** and more, priced right



40 designs of knobs and pulls in the most popular styles and finishes

Complete line of steel bar pulls available in the Naples collection

Base Metal of cast zinc alloy, steel, aluminum or stainless steel for durability

Machine polished for consistent quality

Also ideal for the commercial, multi-family, retail and builder markets

Limited Lifetime Warranty

AIDEN



Item	Description	Overall Length or Diameter	Inner Box	Master Carton
993	knob	1-5/8"	30	300
993-3	3" CC	4-1/16"	25	250
993-96	96 mm (3-3/4") CC	4-3/4"	20	200
993-128	128 mm (5-1/16") CC	6-1/8"	15	150

DBE1039-GRY Aiden hardware on Designer Grey display board



Finishes





CHARMING

Charming and welcoming, Aiden offers a comfortable grip and ample hand clearance with its flowing arch profile. With its coordinating knob and extended sizes, this collection is a favorable choice for universal design needs. Shown in Brushed Oil Rubbed Bronze.

ARCADIA



Item	Description	Overall Length or Diameter	Inner Box	Master Carton
107	knob	1-5/16"	25	250
516	3" CC	5-1/2"	25	250

DBE1011-GRY Arcadia hardware on Designer Grey display board

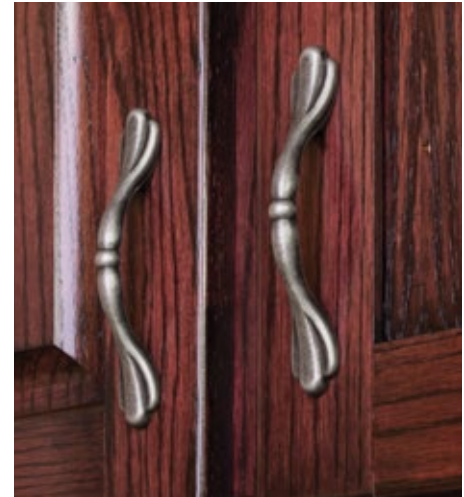

Finishes

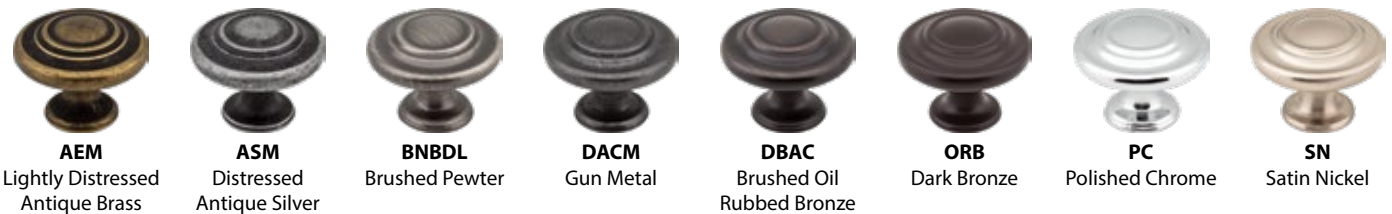

ASHER



Item	Description	Overall Length or Diameter	Inner Box	Master Carton
193-3	3" CC	3-1/4"	15	150
193-96	96 mm (3-3/4") CC	4"	15	150
193-4	4" CC	4-1/4"	15	150
193-128	128 mm (5-1/16") CC	5-1/4"	10	100
193-160	160 mm (6-5/16") CC	6-9/16"	10	100

DBE1023-GRY Asher hardware on Designer Grey display board

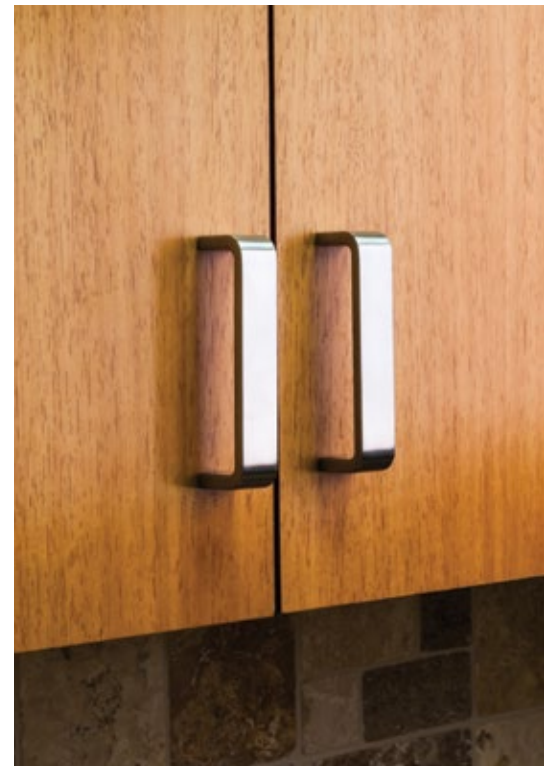

Finishes



BELEFAST



Item	Description	Overall Length or Diameter	Inner Box	Master Carton
308-128	128 mm (5-1/16") CC	5-9/16"	25	250
406-128	128 mm (5-1/16") CC	6-9/16"	20	200
745-128	128 mm (5-1/16") CC	5-11/16"	20	200
776-128	128 mm (5-1/16") CC	5-11/16"	20	200
976-128	128 mm (5-1/16") CC	6-3/16"	20	200

DBE1018-GRY Belfast hardware on Designer Grey display board

Finishes

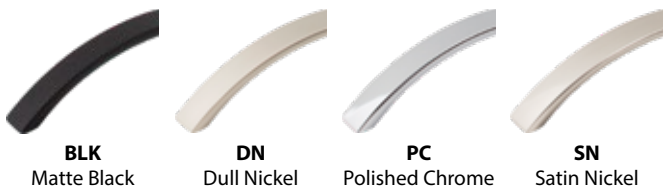

BRENTON



Item	Description	Overall Length or Diameter	Inner Box	Master Carton
239	knob	1"	30	300
239-96	96 mm (3-3/4") CC	4-5/16"	15	150
239-128	128 mm (5-1/16") CC	5-9/16"	15	150
239-160	160 mm (6-5/16") CC	6-13/16"	15	150
239-192	192 mm (7-9/16") CC	8-1/16"	10	100

DBE1024-GRY Brenton hardware on Designer Grey display board



Finishes



CALLOWAY



Item	Description	Overall Length or Diameter	Inner Box	Master Carton
331	small round knob	1-1/8"	25	250
351	small square knob	1-1/8"	25	250
331L	large round knob	1-1/4"	25	250
351L	large square knob	1-1/4"	25	250
331-96	96 mm (3-3/4") CC	4-1/2"	15	150
351-96	96 mm (3-3/4") CC	4-7/16"	15	150
331-128	128 mm (5-1/16") CC	5-3/4"	10	100
351-128	128 mm (5-1/16") CC	5-11/16"	10	100

DBE1026-GRY Calloway hardware on Designer Grey display board

Finishes



CAPRI

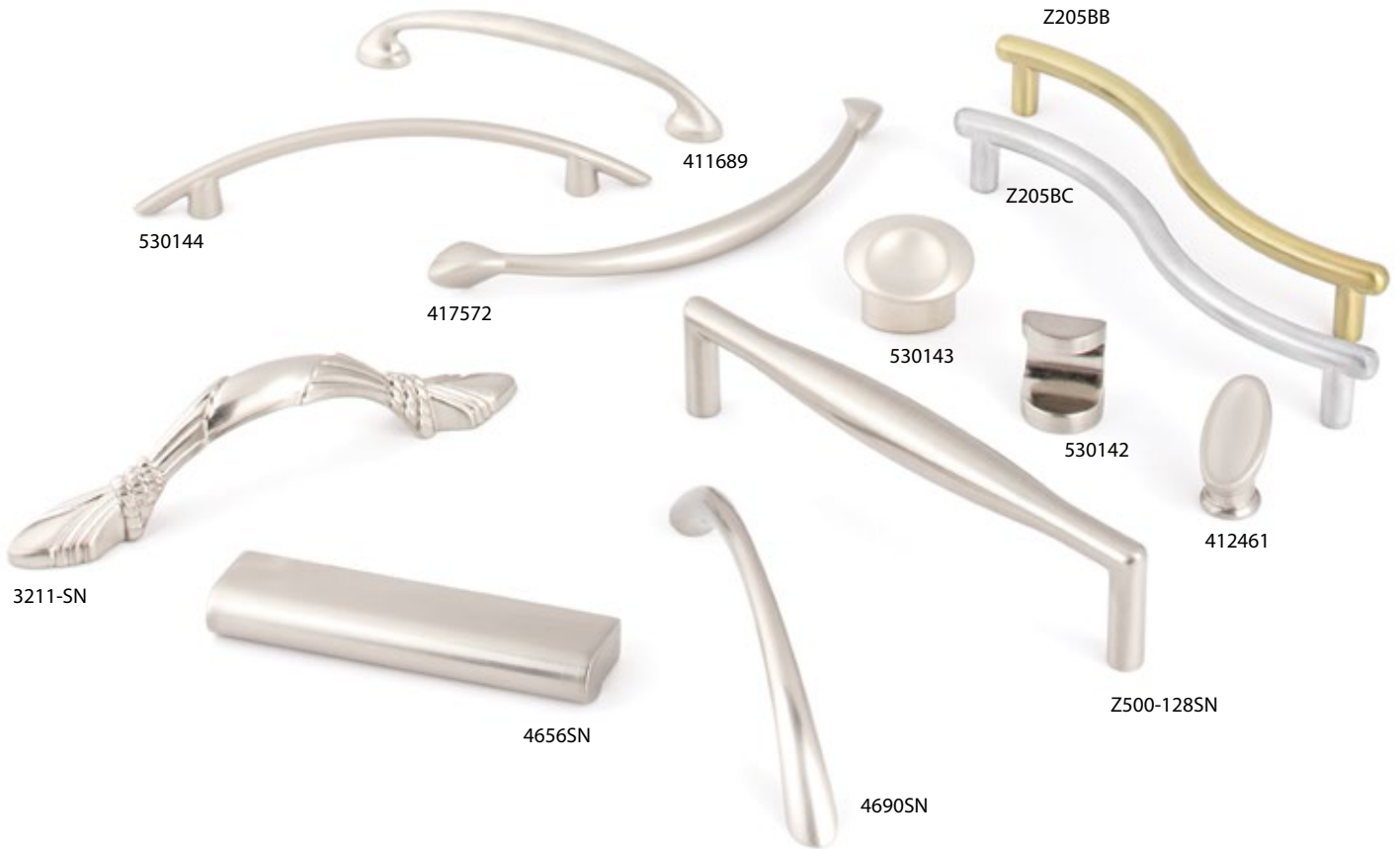

Item	Description	Overall Length or Diameter	Inner Box	Master Carton	Finishes
412461	knob	1-1/16"	50	500	SN
530142	knob	13/16"	25	250	SN
530143	knob	1-1/4"	25	250	DN
3211	3" CC	4-15/16"	25	250	SN
4656	3" CC	3-3/8"	25	250	SN
411689*	96 mm (3-3/4") CC	4-3/8"	50	500	DN
4690	96 mm (3-3/4") CC	4-1/2"	50	500	SN
530144	96 mm (3-3/4") CC	5-1/4"	50	500	DN
417572	128 mm (5-1/16") CC	5-7/16"	30	300	DN
Z205	128 mm (5-1/16") CC	5-3/4"	30	300	BB, BC
Z500-128	128 mm (5-1/16") CC	5-3/8"	15	150	SN

*M4 attachment screws included with 411689 pull

BB Brushed Brass
BC Brushed Chrome
DN Dull Nickel
SN Satin Nickel



COSGROVE



Item		Overall Length or Diameter	Inner Box	Master Carton
382	knob	1-1/2"	25	250
382-96	96 mm (3-3/4") CC	6-1/2"	15	150
382-128	128 mm (5-1/16") CC	7-3/4"	10	100
382-160	160 mm (6-5/16") CC	9"	10	100

DBE1025-GRY Cosgrove hardware on Designer Grey display board



Finishes



CYPRESS



Item	Description	Overall Length or Diameter	Inner Box	Master Carton
Z118	knob	1-1/4"	25	250
Z118-3	3" CC	3-7/16"	20	200
Z118-96	96 mm (3-3/4") CC	4-1/16"	20	200



Finishes



DRAKE



Item	Description	Overall Length or Diameter	Inner Box	Master Carton
423	faceted knob	1-3/16"	30	300
424	flat top knob	1-3/16"	25	250
423-3	3" CC	4"	25	250
423-96	96 mm (3-3/4") CC	4-3/4"	20	200

DBE1022-GRY Drake hardware on Designer Grey display board



Finishes



EDGEFIELD

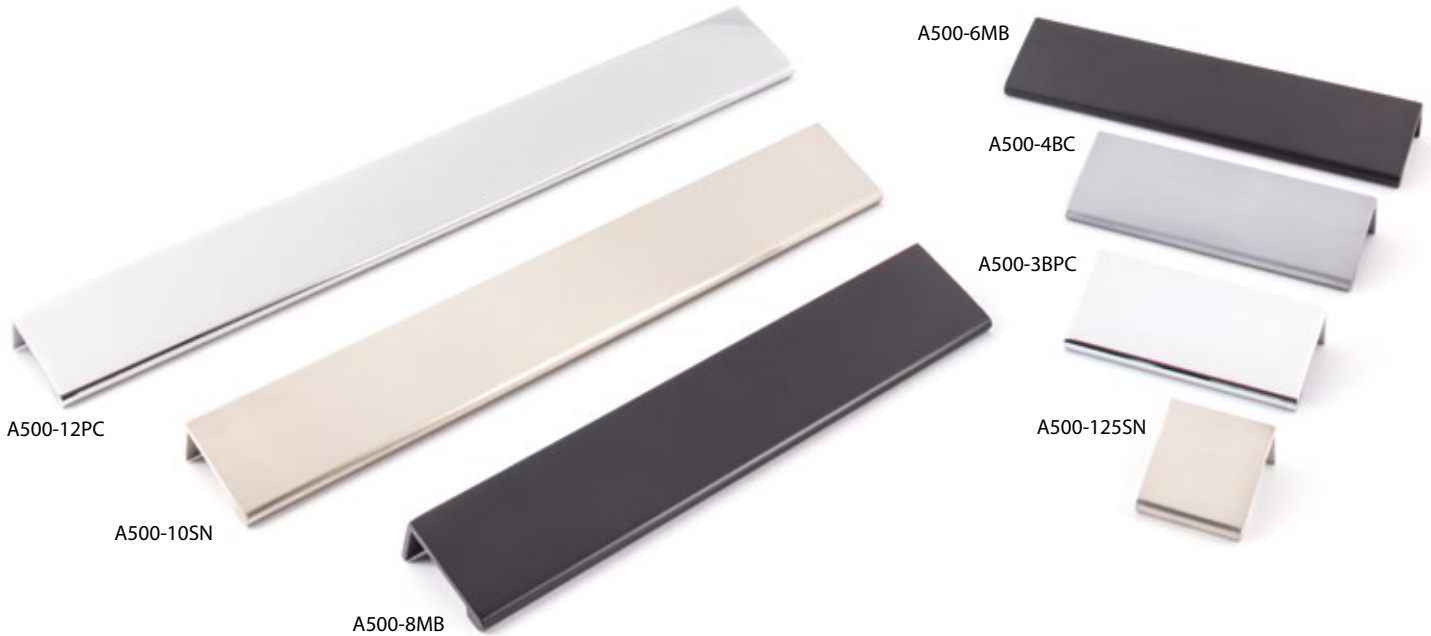

Item	Description	Overall Length	Inner Box	Master Carton
A500-125*	16 mm (5/8") CC tab pull	1-1/4"	50	500
A500-3*	60 mm (2-3/8") CC tab pull	3"	25	250
A500-4*	76 mm (3") CC tab pull	4"	25	250
A500-6*	127 mm (5") CC tab pull	6"	20	200
A500-8*	90 mm (3-9/16") CC tab pull (3 holes)	8"	20	200
A500-10*	114 mm (4-1/2") CC tab pull (3 holes)	10"	10	100
A500-12*	90 mm (3-9/16") CC tab pull (4 holes)	12"	10	100

DBE1029-GRY Edgefield hardware on Designer Grey display board

*Wood screws included with all tab pulls

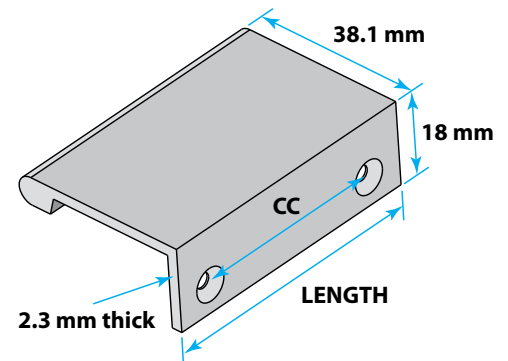

Finishes

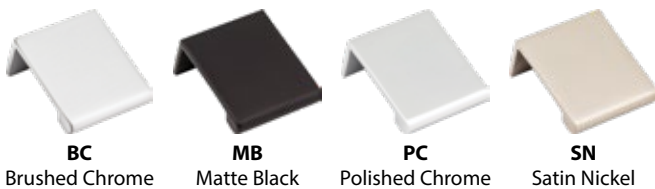

FLORENCE



Item	Description	Overall Length or Diameter	Inner Box	Master Carton
2980	knob	1-1/4"	20	200
2981	3" CC cup pull	3-11/16"	20	200

DBE1012-GRY Florence hardware on Designer Grey display board



Finishes



GATSBY



Item	Description	Overall Length or Diameter	Inner Box	Master Carton
3940	knob	1-3/16"	50	500
3950	knob	1-3/16"	50	500
3960	knob	1-1/4"	25	250
3970	knob	1-3/16"	25	250
3108	3" CC	5-5/16"	25	250
3208	3" CC	4-1/4"	25	250
3308	3" CC	4-1/2"	25	250



Finishes



GLENDALE



Item	Description	Overall Length or Diameter	Inner Box	Master Carton
525	knob	1-1/8"	50	500
525-96	96 mm (3-3/4") CC	4-15/16"	25	250

DBE1013-GRY Glendale hardware on Designer Grey display board



Finishes



HAMMOND



Item	Description	Overall Length or Diameter	Inner Box	Master Carton
525	knob	1-1/8"	50	500
937-3	3" CC	4-7/8"	20	200
937-96	96 mm (3-3/4") CC	5-11/16"	20	200

DBE1034-GRY Hammond hardware on Designer Grey display board



Finishes

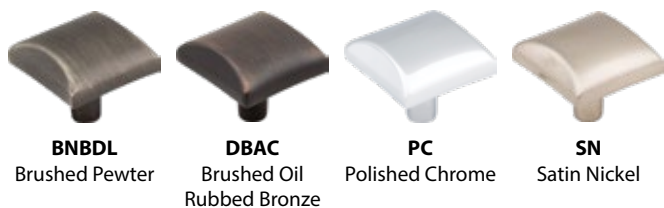

HADLY NEW ADDITIONS!

US Patents D833,249; D833,252

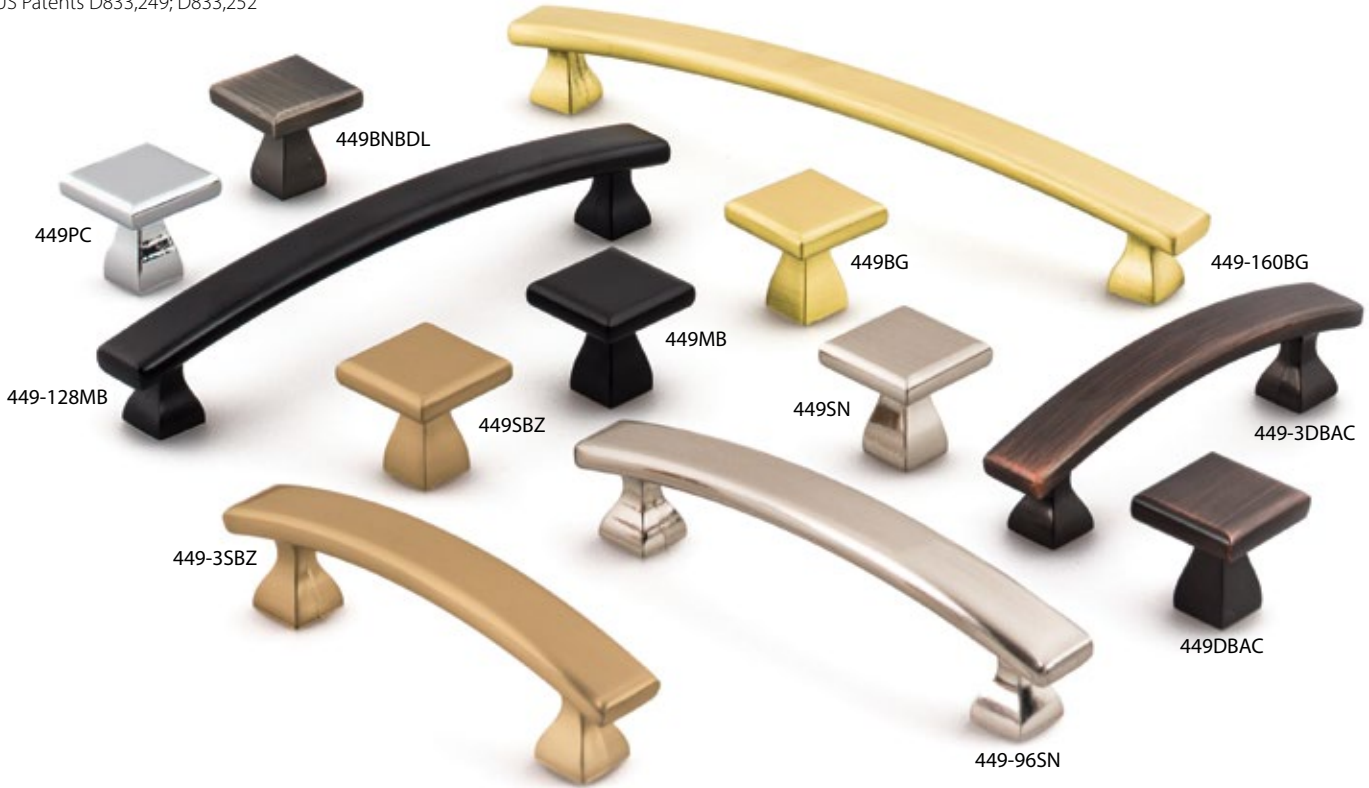

Item	Description	Overall Length or Diameter	Inner Box	Master Carton
449	knob	1"	25	250
449-3	3" CC	4"	15	150
449-96	96 mm (3-3/4") CC	4-3/4"	15	150
449-128 NEW	128 mm (5-1/16") CC	6-1/16"	10	100
449-160 NEW	160 mm (6-5/16") CC	7-5/16"	10	100

DBE1036-GRY Hadly hardware on Designer Grey display board



Finishes





FUN

Fun and lively, a soft square silhouette is echoed in Hadly's pull and knob. Flourishing quickly into a crowd favorite, extended lengths and finishes have been added to deepen its appeal. Shown in Satin Nickel.

KENNER



Item	Description	Overall Length or Diameter	Inner Box	Master Carton
3970	knob	1-3/16"	25	250
254-3	3" CC	5"	20	200
254-96	96 mm (3-3/4") CC	5-3/4"	20	200

DBE1032-GRY Kenner hardware on Designer Grey display board



Finishes



KINGSPORT



Item	Description	Overall Length or Diameter	Inner Box	Master Carton	Finishes
202	knob	1-1/4"	50	500	AB
875	knob	1-5/16"	100	1000	AB
878	knob	1-3/16"	50	500	AE
WK150	knob	1-1/4"	100	1000	AB
840	3" CC	4-13/16"	50	500	AB
1018	3" CC	4-7/16"	25	250	AB
3208	3" CC	4-1/4"	25	250	AB
4655	128 mm (5-1/16") CC	6-1/4"	25	250	AB
CH3503	3-1/2" CC	4-3/4"	25	250	AB
WP150	3" CC	4-1/4"	25	250	AB
WB150*	4-11/16" CC	6-1/16"	50	500	AB

*Two attachment nails included with WB150 backplate

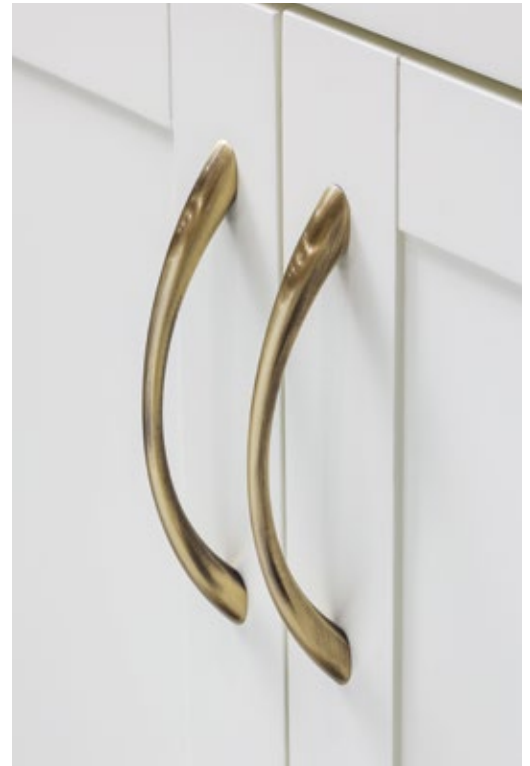

AB Brushed Antique Brass
AE Antique Brass

KNOX NEW!



Item	Description	Overall Length or Diameter	Inner Box	Master Carton
645-96 NEW	96 mm (3-3/4") CC	4-1/4"	10	100
645-128 NEW	128 mm (5-1/16") CC	5-9/16"	10	100
645-160 NEW	160 mm (6-5/16")	6-13/16"	10	100
645-192 NEW	192 mm (7-9/16")	8-1/16"	10	100
645-224 NEW	224 mm (8-13/16")	9-5/16"	10	100
645-320 NEW	320 mm (12-5/8") CC	13-1/16"	10	100

DBE1044-GRY Knox hardware on Designer Grey display board



Finishes



MB
Matte Black

PC
Polished Chrome

SN
Satin Nickel



SUBTLE

A subtle reflection of a warded lock key, Knox pairs leading lines and intentional curves for a simple yet distinctive look. This closed-ended bar pull series offers a generous 1" hand clearance for an aesthetically pleasing option for aging in place and ADA projects. Shown in Matte Black.



LINDOS



Item	Description	Overall Length or Diameter	Inner Box	Master Carton
Z115	round knob	1-1/4"	25	250
Z115L	oblong knob	1-3/8"	25	250
Z115-96	96 mm (3-3/4") CC	4-5/16"	20	200
Z115-128	128 mm (5-1/16") CC	5-9/16"	15	150

DBE1020-GRY Lindos hardware on Designer Grey display board

Finishes



BNBDL

Brushed Pewter



DBAC

Brushed Oil Rubbed Bronze



PC

Polished Chrome



SN

Satin Nickel



MADISON



Item	Description	Overall Length or Diameter	Inner Box	Master Carton	Finishes
3910	knob	1-3/16"	30	300	AB, ALM, BC, BG, BN, BNBDL, DACM, DBAC, MB, ORB, PB, PC, SB, SBZ, SN, WH
Z259-3	3" CC	3-3/8"	50	500	AB, BC, BN, BNBDL, DACM, DBAC, MB, ORB, PB, PC, SB, SBZ, SN
Z259-12	12" CC appliance pull	12-15/16"	5	20	AB, BC, BN, DACM, DBAC, ORB, PC, SN

DBE1040-GRY Madison hardware on Designer Grey display board

Finishes



MERRYVILLE



Item	Description	Overall Length or Diameter	Inner Box	Master Carton
897	small egg knob	1-1/8"	20	200
897L	large egg knob	1-1/4"	20	200
897-3	3" CC	5-1/8"	20	200

DBE1033-GRY Merryville hardware on Designer Grey display board

Finishes



PARK

Patents Pending

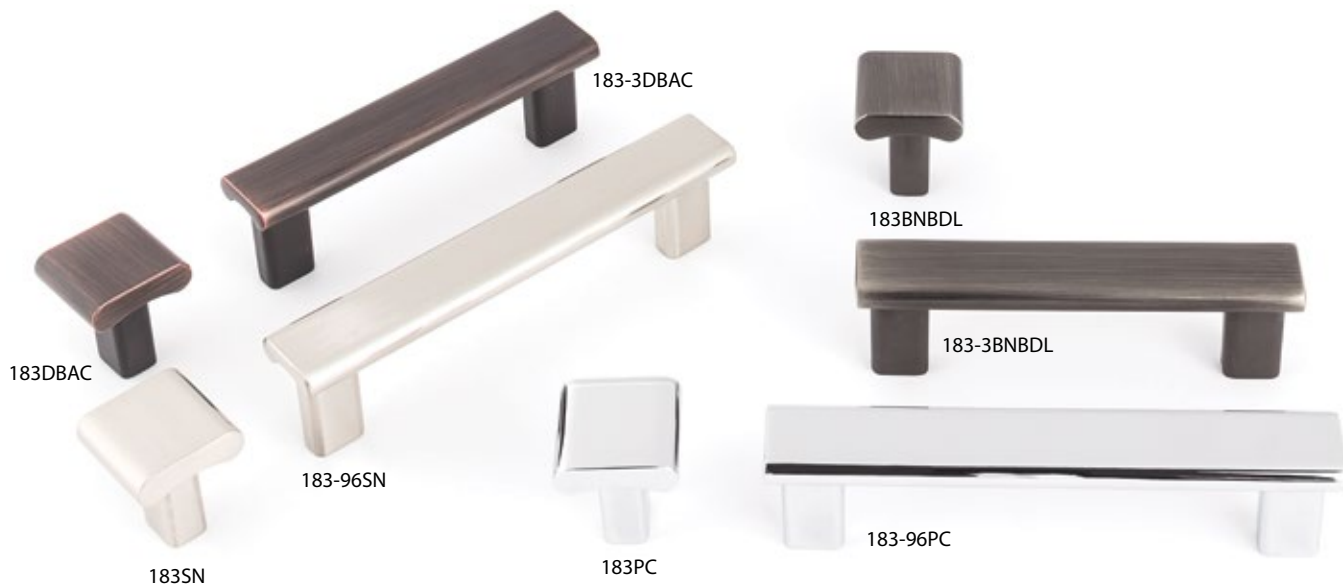

Item	Description	Overall Length or Diameter	Inner Box	Master Carton
183	knob	1"	25	250
183-3	3" CC	3-3/4"	15	150
183-96	96 mm (3-3/4") CC	4-1/2"	15	150

DBE1038-GRY Park hardware on Designer Grey display board



Finishes

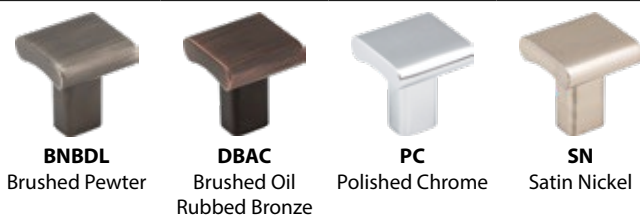

NAPLES

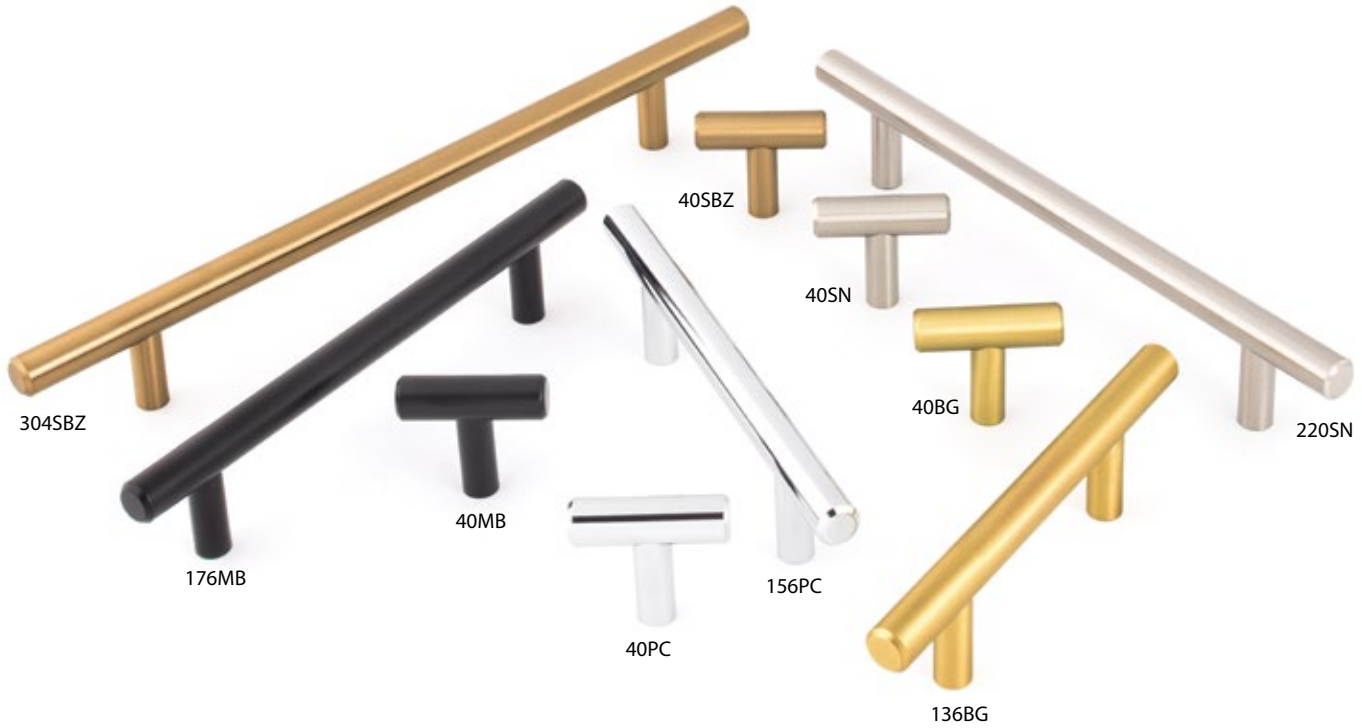

Item	Description	Overall Length or Diameter	Inner Box	Master Carton	Material
40*	T knob	1-9/16"	30	300	Steel
136*	3" CC	5-3/8"	10	50	Steel
156*	96 mm (3-3/4") CC	6-1/8"	10	50	Steel
176*	128 mm (5-1/16") CC	6-15/16"	10	50	Steel
206*	128 mm (5-1/16") CC	8-1/8"	10	50	Steel
220*	160 mm (6-5/16") CC	8-11/16"	10	50	Steel
272*	192 mm (7-9/16") CC	10-11/16"	10	50	Steel
304*	224 mm (8-13/16") CC	11-15/16"	10	50	Steel
336*	256 mm (10-1/16") CC	13-1/4"	10	40	Steel
368*	288 mm (11-5/16") CC	14-1/2"	10	40	Steel
399*	319 mm (12-9/16") CC	15-11/16"	10	40	Steel
496*	416 mm (16-3/8") CC	19-1/2"	10	20	Steel
560 [†]	480 mm (18-7/8") CC	22-1/16"	10	20	Steel
624 [†]	544 mm (21-7/16") CC	24-9/16"	10	20	Steel
720 [†]	640 mm (25-3/16") CC	28-3/8"	10	20	Steel
763 [‡]	673 mm (26-1/2") CC	30-1/16"	10	20	Steel

Finishes



DBE1014-GRY Single Naples hardware on Designer Grey display board (SN & MB finishes)

*Available in all finishes

[†]Available in Polished Chrome and Satin Nickel finishes

NAPLES

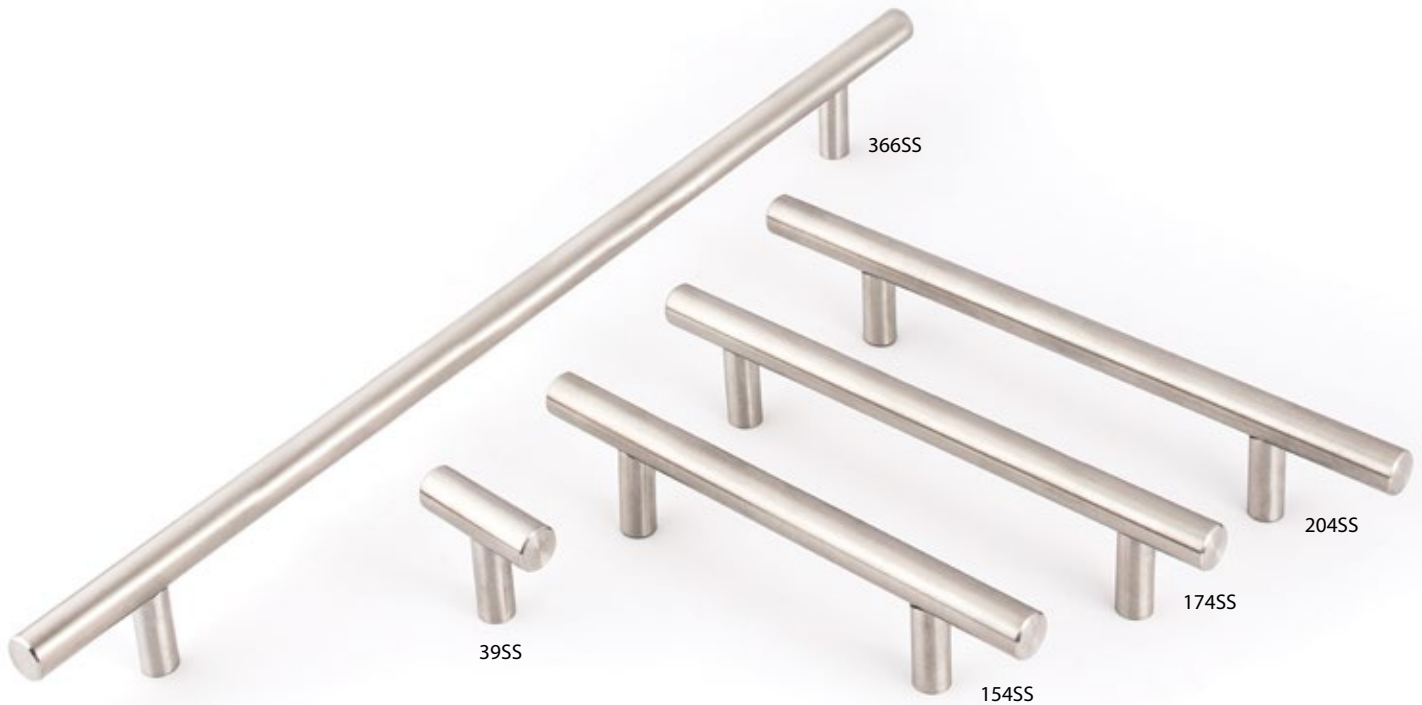

Item	Description	Overall Length or Diameter	Inner Box	Master Carton	Material
39	T knob	1-9/16"	40	400	Hollow Stainless Steel
154	96 mm (3-3/4") CC	6-1/16"	20	200	Hollow Stainless Steel
174	128 mm (5-1/16") CC	6-7/8"	20	200	Hollow Stainless Steel
204	128 mm (5-1/16") CC	8-1/16"	20	200	Hollow Stainless Steel
270	192 mm (7-9/16") CC	10-5/8"	20	200	Hollow Stainless Steel
302	224 mm (8-13/16") CC	11-7/8"	20	200	Hollow Stainless Steel
334	256 mm (10-1/16") CC	13-1/8"	20	200	Hollow Stainless Steel
366	288 mm (11-5/16") CC	14-7/16"	10	100	Hollow Stainless Steel
397	319 mm (12-9/16") CC	15-5/8"	10	100	Hollow Stainless Steel
494	416 mm (16-3/8") CC	19-7/16"	10	100	Hollow Stainless Steel
558	480 mm (18-7/8") CC	21-15/16"	10	100	Hollow Stainless Steel
622	544 mm (21-7/16") CC	24-1/2"	10	100	Hollow Stainless Steel
719	640 mm (25-3/16") CC	28-5/16"	10	100	Hollow Stainless Steel
761	673 mm (26-1/2") CC	29-15/16"	10	100	Hollow Stainless Steel

Finishes



DBE1014-GRY Single Naples hardware on Designer Grey display board

SEAVER



Item	Description	Overall Length or Diameter	Inner Box	Master Carton
511	knob	1-1/4"	25	250
511-3	3" CC	4-1/16"	15	150
511-96	96 mm (3-3/4") CC	4-7/8"	15	150

DBE1037-GRY Seaver hardware on Designer Grey display board



Finishes



SEDONA



Item	Description	Overall Length or Diameter	Inner Box	Master Carton
26	knob	1"	30	300
400	3" CC	4"	10	100
475	96 mm (3-3/4") CC	4-3/4"	10	100
600	128 mm (5-1/16") CC	6"	10	100

DBE1017-GRY Sedona hardware on Designer Grey display board



Finishes



SN
Satin Nickel

SLADE



Item	Description	Overall Length or Diameter	Inner Box	Master Carton
3915	knob	1"	50	500
984-3	3" CC	3-3/8"	30	300
984-96	96 mm (3-3/4") CC	4-1/8"	25	250
984-128	128 mm (5-1/16") CC	5-13/32"	25	250
984-160	160 mm (6-5/16") CC	6-11/16"	15	150
984-192	192 mm (7-9/16") CC	7-15/16"	15	150

DBE1028-GRY Slade hardware on Designer Grey display board

Finishes



SOMERSET



Item	Description	Overall Length or Diameter	Inner Box	Master Carton
8004	96 mm (3-3/4") CC	4-15/16"	30	300
81065	128 mm (5-1/16") CC	6-1/8"	25	250
80814	96 mm (3-3/4") CC	5"	30	300
80815	128 mm (5-1/16") CC	6-5/16"	25	250

DBE1008-GRY Somerset hardware on Designer Grey display board



Finishes

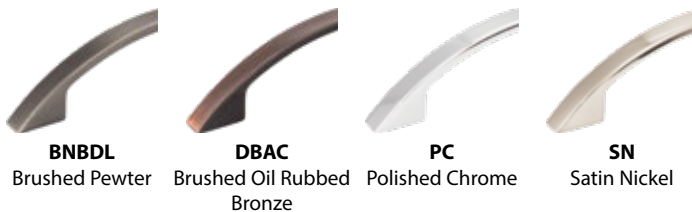

STANTON



Item	Description	Overall Length or Diameter	Inner Box	Master Carton
625-3	3" CC	3-3/8"	20	200
625-96	96 mm (3-3/4") CC	4-1/8"	25	150
625-128	128 mm (5-1/16") CC	5-3/8"	20	160
625-160	160 mm (6-5/16") CC	6-5/8"	10	100
625-192	192 mm (7-9/16") CC	7-15/16"	10	100
625-224	224 mm (8-13/16") CC	9-3/16"	10	100
625-320	320 mm (12-5/8") CC	12-15/16"	10	80
625-448	448 mm (17-5/8") CC	18"	10	60

DBE1021-GRY Stanton hardware on Designer Grey display board



Finishes

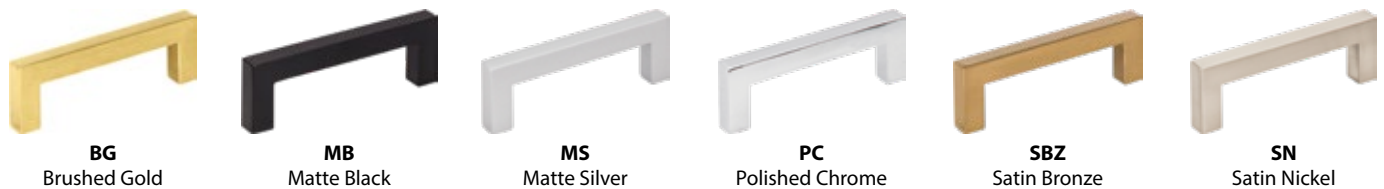

BG
Brushed Gold

MB
Matte Black

MS
Matte Silver

PC
Polished Chrome

SBZ
Satin Bronze

SN
Satin Nickel



CONFIDENT

Sleek, clean and confident, Stanton is a perfect alternative to the traditional rounded bar pull look. With extended lengths and six finishes to choose from, this pull series flawlessly suits all cabinet styles. Shown in Matte Black.

STRICKLAND



Item	Description	Overall Length or Diameter	Inner Box	Master Carton
771-3	3" CC	4-1/2"	20	200
771-96	96 mm (3-3/4") CC	5-3/16"	20	200
771-128	128 mm (5-1/16") CC	6-5/16"	20	200
771-160	160 mm (6-5/16") CC	7-11/16"	20	200

DBE1027-GRY Strickland hardware on Designer Grey display board

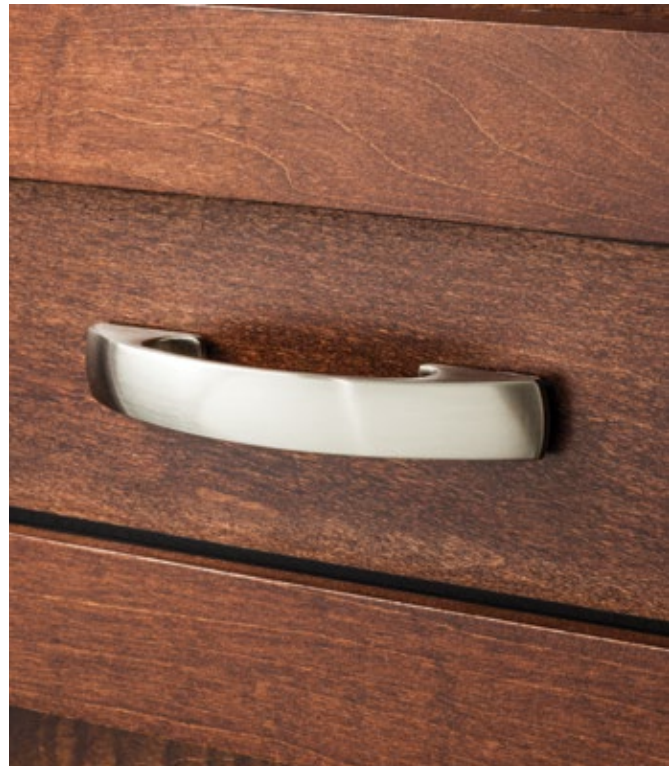

Finishes



SYRACUSE



Item	Description	Overall Length or Diameter	Inner Box	Master Carton
575	knob	1-3/16"	30	300
575-96	96 mm (3-3/4") CC	4-7/8"	20	200

DBE1019-GRY Syracuse hardware on Designer Grey display board

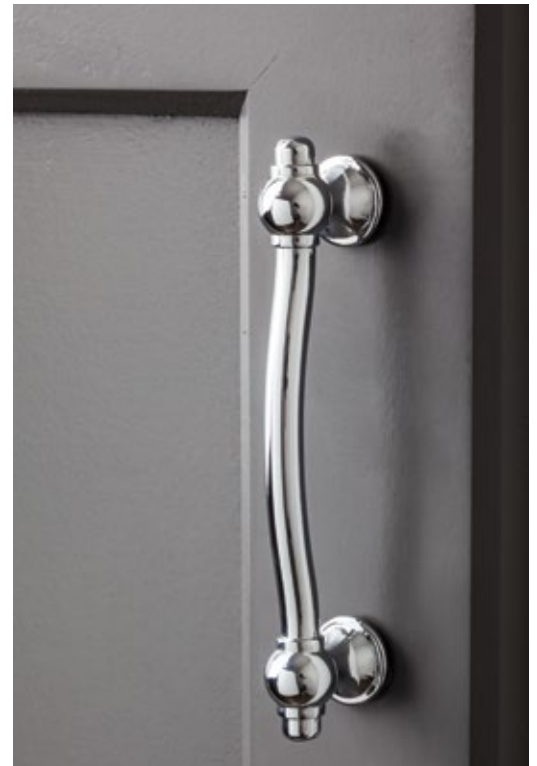

Finishes



THATCHER *NEW!*



Item	Description	Overall Length or Diameter	Inner Box	Master Carton
859T	knob	1-1/2"	25	200
859-3	3" CC	5-1/4"	25	100
859-96	96 mm (3-3/4") CC	6"	25	100
859-128	128 mm (5-1/16") CC	7-1/4"	25	100
859-160	160 mm (6-5/16") CC	8-1/2"	25	100

DBE1045-GRY Thatcher hardware on Designer Grey display board

Finishes





CASUAL

A slightly round strap sitting atop the rounded feet of Thatcher creates a casual, easy-going vibe. A matching T-knob combined with extended lengths and top trending finishes make this collection the perfect match for any style of cabinets. Shown in Brushed Gold.

TORINO



Item	Description	Overall Length or Diameter	Inner Box	Master Carton	Material	Finishes
A271-3AL	3" CC	3-5/16"	30	300	Aluminum	AL
K271-3SS	3" CC	3-5/16"	30	300	Stainless Steel	SS
S271-3	3" CC	3-5/16"	30	300	Steel	ALM, BC, DBAC, PB, PC, SN, WH
A271-3.5AL	3-1/2"	3-13/16"	30	300	Aluminum	AL
K271-3.5-SS	3-1/2"	3-13/16"	30	300	Stainless Steel	SS
S271-3.5	3-1/2"	3-13/16"	30	300	Steel	BC, DBAC, PB, PC, SN
A271-96AL	96 mm (3-3/4") CC	4-1/16"	30	300	Aluminum	AL
K271-96-SS	96 mm (3-3/4") CC	4-1/16"	30	300	Stainless Steel	SS
S271-96	96 mm (3-3/4") CC	4-1/16"	30	300	Steel	ALM, BC, DBAC, PB, PC, SN, WH
A271-4AL	4" CC	4-5/16"	30	300	Aluminum	AL
K271-4SS	4" CC	4-5/16"	30	300	Stainless Steel	SS
S271-4	4" CC	4-5/16"	30	300	Steel	BC, DBAC, PB, PC, SN
S271-128	128 mm (5-1/16") CC	5-3/8"	20	200	Steel	BC, DBAC, PB, PC, SN

AL	Aluminum	DBAC	Brushed Oil Rubbed Bronze
SS	Stainless Steel	PB	Polished Brass
WH	White	PC	Polished Chrome
ALM	Almond	SN	Satin Nickel
BC	Brushed Chrome		

VERONA



Item	Description	Overall Length or Diameter	Inner Box	Master Carton	Finishes
413322*	knob	1-9/16"	100	1000	MB
409222*	knob	1-9/16"	100	1000	MS, SN
Z105	3" CC	3-7/8"	50	500	MB, SN
4655	128 mm (5-1/16") CC	6-1/4"	25	250	AB, BLK, SN
346564	128 mm (5-1/16") CC	6"	30	300	MB, SN
4307305	192 mm (7-9/16") CC	8-5/8"	20	200	MB
413321*	128 mm (5-1/16") CC	7-3/8"	20	200	MB
409223*	128 mm (5-1/16") CC	7-3/8"	20	200	MS, SN
7210	3" CC cup pull	5-3/4"	50	500	MB
R1011**	3" CC pull & backplate	3-13/16"	15	150	MB
R1012**	2-1/4" CC vertical pull & backplate	3-13/16"	25	250	MB

*M4 attachment screws included with this collection

**Attachment screws not included



AB	Brushed Antique Brass
BLK/MB	Matte Black
MS	Matte Silver
SN	Satin Nickel

VIENNA



Item	Description	Overall Length or Diameter	Inner Box	Master Carton
110	knob	1-1/4"	30	300
202	knob	1-1/4"	50	500
110-3	3" CC	5-1/2"	25	250
P106	3" CC	5-1/16"	50	500

Finishes



DBAC
Brushed Oil
Rubbed Bronze



SN
Satin Nickel



WATERVALE



Item	Description	Overall Length or Diameter	Inner Box	Master Carton
647	knob	1-1/8"	20	200
647-3	3" CC	4-5/8"	15	150
647-96	96 mm (3-3/4") CC	5-3/8"	20	200

DBE1031-GRY Watervale hardware on Designer Grey display board

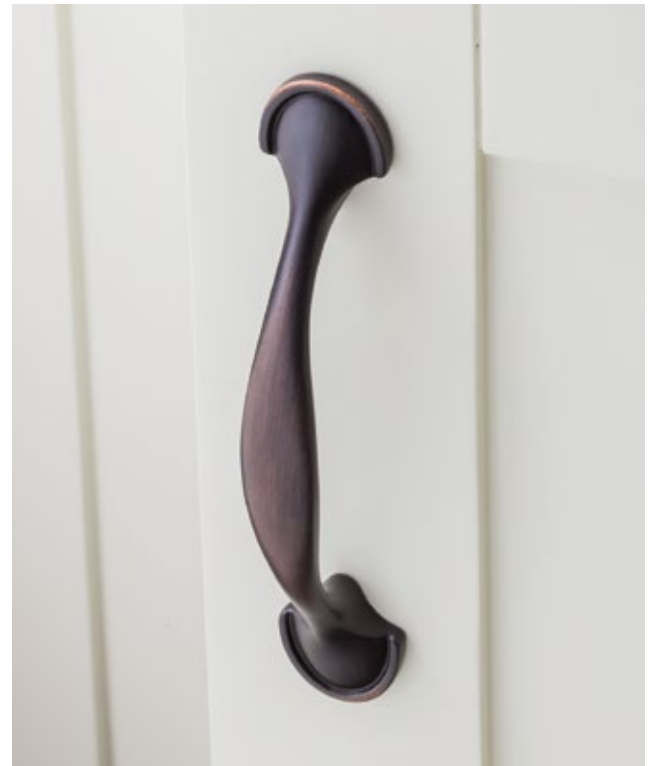

Finishes



WESTBURY



Item	Description	Overall Length or Diameter	Inner Box	Master Carton
3898	knob	1-3/16"	20	200
3899	3" CC	5-3/16"	25	250

DBE1016-GRY Westbury hardware on Designer Grey display board



Finishes



ZACHARY



Item	Description	Overall Length or Diameter	Inner Box	Master Carton
988	knob	1-1/16"	25	250
988-3	3" CC	3-3/4"	20	200
988-96	96 mm (3-3/4") CC	4-1/2"	20	200
988-128	128 mm (5-1/16") CC	5-3/4"	15	150
988-160	160 mm (6-5/16") CC	7-1/16"	10	100

DBE1030-GRY Zachary hardware on Designer Grey display board



Finishes



BNBDL

Brushed Pewter

DBAC

Brushed Oil Rubbed
Bronze

PC

Polished Chrome

SN

Satin Nickel