



DEEP SEA ELECTRONICS PLC

DSE331 ATS Controller Operators Manual

Document Number 057-146

Author: Allan Jones



Deep Sea Electronics Plc
 Highfield House
 Hunmanby
 North Yorkshire
 YO14 0PH
 ENGLAND

Sales Tel: +44 (0) 1723 890099
 Sales Fax: +44 (0) 1723 893303

E-mail: sales@deepseapl.com
 Website: www.deepseapl.com

DSE 331 ATS controller Operators Manual

© Deep Sea Electronics Plc
 All rights reserved. No part of this publication may be reproduced in any material form (including photocopying or storing in any medium by electronic means or other) without the written permission of the copyright holder except in accordance with the provisions of the Copyright, Designs and Patents Act 1988.
 Applications for the copyright holder’s written permission to reproduce any part of this publication should be addressed to Deep Sea Electronics Plc at the address above.

The DSE logo is a UK registered trademarks of Deep Sea Electronics PLC.

Any reference to trademarked product names used within this publication is owned by their respective companies.

Deep Sea Electronics Plc reserves the right to change the contents of this document without prior notice.

Amendments List

Issue	Comments	Minimum Module version required	Minimum Configuration Suite Version required
1	Initial release	1	5.10.13.0
2	Ammended Gasket part number	1	5.10.13.0
3	Ammended FPE Ac topology List	1	5.10.13.0

Typeface: The typeface used in this document is *Arial*. Care should be taken not to mistake the upper case letter I with the numeral 1. The numeral 1 has a top serif to avoid this confusion.

	NOTE: Highlights an essential element of a procedure to ensure correctness.
	CAUTION: Indicates a procedure or practice which, if not strictly observed, could result in damage or destruction of equipment.
	WARNING: Indicates a procedure or practice which could result in injury to personnel or loss of life if not followed correctly.
	Deep Sea Electronics Plc owns the copyright to this manual, which cannot be copied, reproduced or disclosed to a third party without prior written permission.
	Society of Automotive Engineers (USA)

TABLE OF CONTENTS

1 BIBLIOGRAPHY..... 5

2 INTRODUCTION..... 5

3 SPECIFICATIONS 6

3.1 PART NUMBERING6

3.1 POWER SUPPLY REQUIREMENTS7

3.2 TERMINAL SPECIFICATION7

3.3 S1/S2 VOLTAGE / FREQUENCY SENSING7

3.4 INPUTS.....8

 3.4.1 DIGITAL INPUTS8

3.5 OUTPUTS.....8

 3.5.1 CONFIGURABLE NORMALLY OPEN RELAY OUTPUTS A & B8

 3.5.2 CONFIGURABLE CHANGEOVER RELAY OUTPUTS C & D.....8

 3.5.3 CONFIGURABLE OUTPUTS E - H8

3.6 COMMUNICATION PORTS8

3.7 DIMENSIONS AND MOUNTING9

 3.7.1 DIMENSIONS.....9

 3.7.2 PANEL CUTOUT.....9

 3.7.3 WEIGHT.....9

 3.7.4 FIXING CLIPS.....9

 3.7.5 OPTIONAL SILICON SEALING GASKET.....9

3.8 APPLICABLE STANDARDS..... 10

3.9 ENCLOSURE CLASSIFICATIONS 11

 3.9.1 IP CLASSIFICATIONS11

 3.9.2 NEMA CLASSIFICATIONS12

4 INSTALLATION 13

4.1 TERMINAL DESCRIPTION 13

 4.1.1 DC SUPPLY & DC OUTPUTS.....13

 4.1.2 DIGITAL INPUTS.....13

 4.1.3 VOLT FREE OUTPUTS.....13

 4.1.4 S1 SENSING14

 4.1.5 S2 SENSING14

 4.1.6 PC CONFIGURATION INTERFACE CONNECTOR14

4.2 TYPICAL WIRING DIAGRAM..... 15

5 DESCRIPTION OF CONTROLS 16

QUICKSTART GUIDE 17

 5.1.1 MODE SELECTION OPERATION.....17

5.2 GRAPHICAL DISPLAY 18

 5.2.1 DISPLAY PAGES.....18

 5.2.1.1 STATUS.....18

 5.2.1.2 INSTRUMENTATION18

 5.2.1.3 ALARMS19

 5.2.1.4 SCHEDULER.....19

 5.2.2 ALARM ICONS.....19

5.3 CONTROLS.....20

 5.3.1 MODE SELECTION20

 5.3.2 DISPLAY.....20

 5.3.3 LOAD SWITCHING CONTROL.....20

6 OPERATION 21

6.1 AUTOMATIC MODE OF OPERATION.....21

6.1.1	WAITING IN AUTO MODE.....	21
6.1.2	STARTING SEQUENCE	21
6.1.3	S1 / S2 ON LOAD	21
6.1.4	STOPPING SEQUENCE	21
6.2	MANUAL OPERATION.....	22
6.2.1	STARTING SEQUENCE	22
6.2.2	S1 OFF LOAD.....	22
6.2.3	S2 ON LOAD.....	22
6.2.4	TRANSFER BUTTONS OPERATION	22
6.2.5	STOPPING SEQUENCE	22
6.3	TEST ON OPERATION	23
6.3.1	STARTING SEQUENCE	23
6.3.2	S2 ON LOAD.....	23
6.3.3	STOPPING SEQUENCE	23
6.4	LOAD SWITCHING CONTROL.....	24
6.4.1	BREAKER SCHEME A	24
6.4.2	S1 / S2 LOAD INHIBIT	24
6.4.3	LOAD SHEDDING.....	24
6.4.4	TIMING DIAGRAM	24
6.4.5	BREAKER SCHEME B	25
6.4.5.1	CHECK SYNCHRONISING IS DISABLED	25
6.4.5.1.1	TRANSFERRING TO S2.....	25
6.4.5.1.2	TRANSFERRING TO S1.....	25
6.4.5.1.3	LOAD SHED INPUT	25
6.4.5.1.4	TIMING DIAGRAM	25
6.4.5.2	CHECK SYNCHRONISING IS ENABLED	26
6.4.5.2.1	TRANSFER TO S2.....	26
6.4.5.2.2	TRANSFER TO S1.....	26
6.4.5.2.3	LOAD SHED INPUT	26
6.4.5.2.4	TIMING DIAGRAM	26
7	PROTECTIONS.....	27
7.1	S2.....	27
7.2	S1.....	27
7.3	PLANT BATTERY	27
8	FRONT PANEL CONFIGURATION.....	28
8.1	ACCESSING THE FRONT PANEL EDITOR (FPE).....	29
8.1.1	EDITING A PARAMETER	29
8.2	ADJUSTABLE PARAMETERS (CONFIGURATION EDITOR)	29
9	MAINTENANCE, SPARES, REPAIR AND SERVICING.....	34
9.1	PURCHASING ADDITIONAL CONNECTOR PLUGS FROM DSE	34
9.2	PURCHASING ADDITIONAL FIXING CLIPS FROM DSE.....	34
9.3	PURCHASING SEALING GASKET FROM DSE	34
10	WARRANTY	35
11	DISPOSAL.....	35
11.1	WEEE (WASTE ELECTRICAL AND ELECTRONIC EQUIPMENT).....	35
11.2	ROHS (RESTRICTION OF HAZARDOUS SUBSTANCES).....	35
12	APPENDIX.....	36
12.1	COMMUNICATIONS OPTION CONNECTIONS.....	36
12.1.1	DESCRIPTION.....	36
12.1.2	PC TO CONTROLLER (DIRECT) CONNECTION.....	36

1 BIBLIOGRAPHY

This document refers to and is referred to by the following DSE publications which can be obtained from the DSE website www.deepseapl.com

DSE PART	DESCRIPTION
053-131	DSE331 installation instructions
057-149	DSE331 Configuration Suite manual

2 INTRODUCTION

This document details the installation and operation requirements of the DSE331 Series modules, part of the DSEAts® range of products.

The manual forms part of the product and should be kept for the entire life of the product. If the product is passed or supplied to another party, ensure that this document is passed to them for reference purposes.

This is not a *controlled document*. You will not be automatically informed of updates. Any future updates of this document will be included on the DSE website at www.deepseapl.com

The **DSE 331** module has been designed to allow the operator to control the transfer of the load from one supply to another, typically the mains supply and a standby generator or two mains supplies.

The user also has the facility to view the system operating parameters via the LCD display.

The **DSE 331** module monitors the supplies, indicating the operational status and fault conditions, automatically transferring the load to the backup supply in case of mains supply failure. The LCD display indicates the status.

The powerful microprocessor contained within the module allows for incorporation of a range of enhanced features:

- *Text & Icon based LCD display (selectable in the software)*
- **True RMS** Voltage monitoring.
- *Supply parameter monitoring.*
- *Fully configurable inputs for use as alarms or a range of different functions.*

Using a PC and the DSE Configuration Suite software allows alteration of selected operational sequences, timers and alarm trips.

Additionally, the module's integral fascia configuration editor allows adjustment of this information.

A robust plastic case designed for front panel mounting houses the module. Connections are via locking plug and sockets.

3 SPECIFICATIONS

3.1 PART NUMBERING

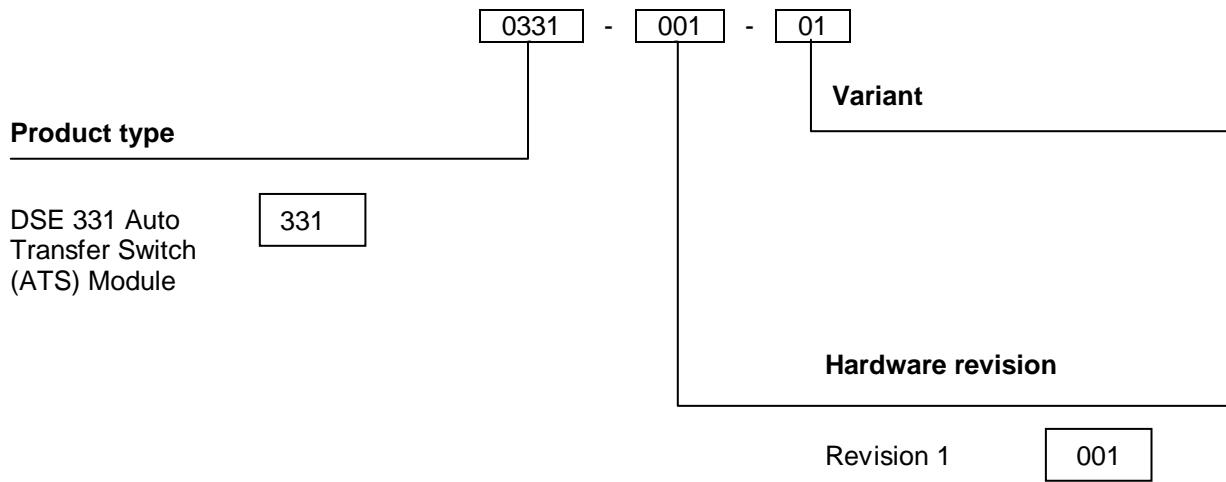

At the time of this document production, there have been no revisions to the module hardware.

3.1 POWER SUPPLY REQUIREMENTS

Minimum supply voltage	8V continuous, 5V for up to one minute.
Cranking dropouts	Able to survive 0V for 50mS providing the supply was at least 10V before the dropout and recovers to 5V afterwards.
Maximum supply voltage	35V continuous (60V protection for one minute)
Reverse polarity protection	-35V continuous
Maximum operating current Auto mode will all inputs active and all LEDs illuminated	168mA at 12V, 80mA at 24V
Maximum standby current (Stop mode with no active inputs)	39mA at 12V, 20mA at 24V

Plant supply instrumentation display

Range	0V-35V DC (note Maximum continuous operating voltage of 35V DC)
Resolution	0.1V
Accuracy	1% of full scale

3.2 TERMINAL SPECIFICATION

Connection type	Screw terminal, rising clamp, no internal spring
Min cable size	0.5mm ² (AWG 24)
Max cable size	2.5mm ² (AWG 10)

3.3 S1/S2 VOLTAGE / FREQUENCY SENSING

Measurement type	True RMS conversion
Sample Rate	5KHz or better
Harmonics	Up to 11 th or better
Input Impedance	300K Ω ph-N
Phase to Neutral	15V (minimum required for sensing frequency) to 333V AC (absolute maximum) Suitable for 110V to 277V nominal ($\pm 20\%$ for under/overvoltage detection)
Phase to Phase	25V (minimum required for sensing frequency) to 576V AC (absolute maximum) Suitable for 190V ph-ph to 479V ph-ph nominal ($\pm 20\%$ for under/overvoltage detection)
Common mode offset from Earth	100V AC (max)
Resolution	1V AC phase to neutral 2V AC phase to phase
Accuracy	$\pm 1\%$ of full scale phase to neutral $\pm 2\%$ of full scale phase to phase
Minimum frequency	3.5Hz
Maximum frequency	75.0Hz
Frequency resolution	0.1Hz
Frequency accuracy	± 0.2 Hz

3.4 INPUTS

3.4.1 DIGITAL INPUTS

Number	4
Arrangement	Contact between input terminal and the module's plant supply negative terminal
Low level threshold	3.0V minimum
High level threshold	4.1V maximum
Maximum input voltage	+60V DC with respect to module's plant supply negative terminal
Minimum input voltage	-2V DC with respect to module's plant supply negative terminal
Contact wetting current	6mA \pm 1mA
Open circuit voltage	12V \pm 1V

3.5 OUTPUTS

3.5.1 CONFIGURABLE NORMALLY OPEN RELAY OUTPUTS A & B

Number	2 (Configurable outputs A & B)
Type	Volts free normally open contacts
Rating	8A @ 35VDC

3.5.2 CONFIGURABLE CHANGEOVER RELAY OUTPUTS C & D

Number	2 (Configurable output C)
Type	Volts free change over contacts.
Rating	8A @ 35VDC

3.5.3 CONFIGURABLE OUTPUTS E - H

Number	4
Type	Fully configurable, DC outputs rated at DC voltage
Rating	8A @ 35VDC
Protection	Protected against over current & over temperature. Built in load dump feature.

3.6 COMMUNICATION PORTS

USB Port	USB2.0 Device for connection to PC running DSE configuration suite only
----------	---

3.7 DIMENSIONS AND MOUNTING

3.7.1 DIMENSIONS

180mm x 116mm x 42mm
(7.1" x 4.6" x 1.7")

3.7.2 PANEL CUTOUT

154mm x 98mm
(6" x 3.9")

3.7.3 WEIGHT

400g (0.4kg)



3.7.4 FIXING CLIPS

The module is held into the panel fascia using the supplied fixing clips.

- Withdraw the fixing clip screw (turn anticlockwise) until only the pointed end is protruding from the clip.
- Insert the three 'prongs' of the fixing clip into the slots in the side of the module case.
- Pull the fixing clip backwards (towards the back of the module) ensuring all three prongs of the clip are inside their allotted slots.
- Turn the fixing clip screws clockwise until they make contact with the panel fascia.
- Turn the screws a little more to secure the module into the panel fascia. Care should be taken not to over tighten the fixing clip screws.

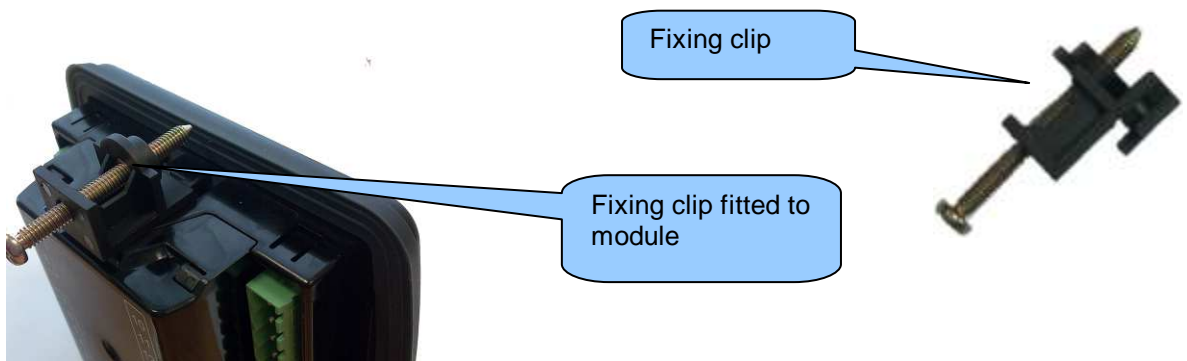

NOTE:- In conditions of excessive vibration, mount the panel on suitable anti-vibration mountings.

3.7.5 OPTIONAL SILICON SEALING GASKET

The optional silicon gasket provides improved sealing between the module and the panel fascia.

The gasket is fitted to the module before installation into the panel fascia.

Take care to ensure the gasket is correctly fitted to the module to maintain the integrity of the seal.

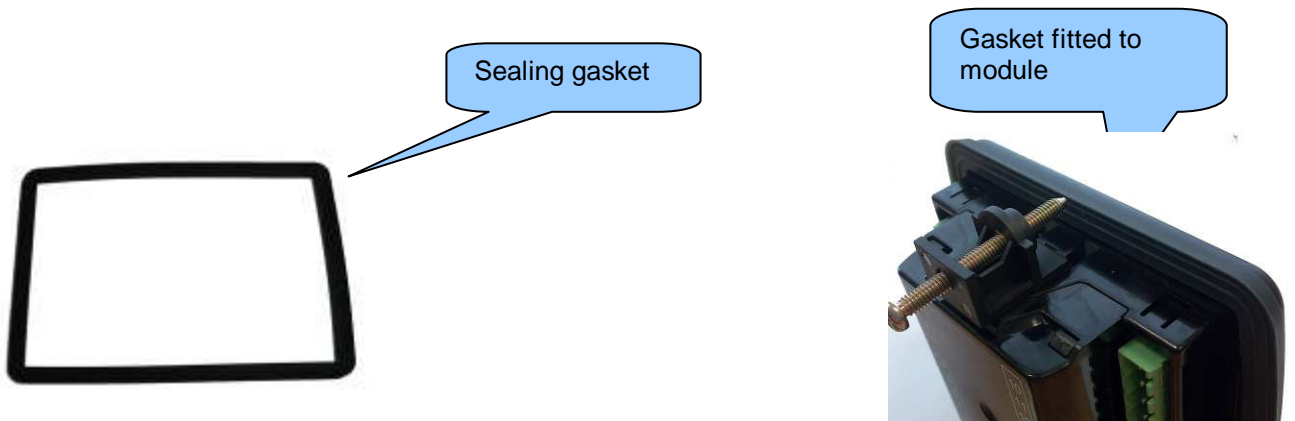

3.8 APPLICABLE STANDARDS

BS 4884-1	This document conforms to BS4884-1 1992 Specification for presentation of essential information.
BS 4884-2	This document conforms to BS4884-2 1993 Guide to content
BS 4884-3	This document conforms to BS4884-3 1993 Guide to presentation
BS EN 60068-2-1 (Minimum temperature)	-30°C (-22°F)
BS EN 60068-2-2 (Maximum temperature)	+70°C (158°F)
BS EN 60950	Safety of information technology equipment, including electrical business equipment
BS EN 61000-6-2	EMC Generic Immunity Standard (Industrial)
BS EN 61000-6-4	EMC Generic Emission Standard (Industrial)
BS EN 60529 (Degrees of protection provided by enclosures)	IP65 (front of module when installed into the control panel with the optional sealing gasket) IP42 (front of module when installed into the control panel WITHOUT being sealed to the panel)
UL508 NEMA rating (Approximate)	12 (Front of module when installed into the control panel with the optional sealing gasket). 2 (Front of module when installed into the control panel WITHOUT being sealed to the panel)
IEEE C37.2 (Standard Electrical Power System Device Function Numbers and Contact Designations)	Under the scope of IEEE 37.2, <i>function numbers can also be used to represent functions in microprocessor devices and software programs.</i> The 331 controller is device number 11L-331 (Multifunction device protecting Line (generator) – 331 series module). As the module is configurable by the generator OEM, the functions covered by the module will vary. Under the module's factory configuration, the device numbers included within the module are : 2 – Time delay starting or closing relay 30 – annunciator relay 42 – Running circuit breaker 62 – time delay stopping or opening relay 74– alarm relay 81 – frequency relay 86 – lockout relay

In line with our policy of continual development, Deep Sea Electronics, reserve the right to change specification without notice.

3.9 ENCLOSURE CLASSIFICATIONS

3.9.1 IP CLASSIFICATIONS

3xx series specification under BS EN 60529 Degrees of protection provided by enclosures

IP65 (Front of module when module is installed into the control panel with the supplied sealing gasket).

IP42 (front of module when module is installed into the control panel WITHOUT being sealed to the panel)

First Digit		Second Digit	
Protection against contact and ingress of solid objects		Protection against ingress of water	
0	No protection	0	No protection
1	Protected against ingress solid objects with a diameter of more than 50 mm. No protection against deliberate access, e.g. with a hand, but large surfaces of the body are prevented from approach.	1	Protection against dripping water falling vertically. No harmful effect must be produced (vertically falling drops).
2	Protected against penetration by solid objects with a diameter of more than 12 mm. Fingers or similar objects prevented from approach.	2	Protection against dripping water falling vertically. There must be no harmful effect when the equipment (enclosure) is tilted at an angle up to 15° from its normal position (drops falling at an angle).
3	Protected against ingress of solid objects with a diameter of more than 2.5 mm. Tools, wires etc. with a thickness of more than 2.5 mm are prevented from approach.	3	Protection against water falling at any angle up to 60° from the vertical. There must be no harmful effect (spray water).
4	Protected against ingress of solid objects with a diameter of more than 1 mm. Tools, wires etc. with a thickness of more than 1 mm are prevented from approach.	4	Protection against water splashed against the equipment (enclosure) from any direction. There must be no harmful effect (splashing water).
5	Protected against harmful dust deposits. Ingress of dust is not totally prevented but the dust must not enter in sufficient quantity to interfere with satisfactory operation of the equipment. Complete protection against contact.	5	Protection against water projected from a nozzle against the equipment (enclosure) from any direction. There must be no harmful effect (water jet).
6	Protection against ingress of dust (dust tight). Complete protection against contact.	6	Protection against heavy seas or powerful water jets. Water must not enter the equipment (enclosure) in harmful quantities (splashing over).

3.9.2 NEMA CLASSIFICATIONS

3xx series NEMA Rating (Approximate)

12 (Front of module when module is installed into the control panel with the optional sealing gasket).

2 (front of module when module is installed into the control panel WITHOUT being sealed to the panel)





NOTE: - There is no direct equivalence between IP / NEMA ratings. IP figures shown are approximate only.

1 IP30	Provides a degree of protection against contact with the enclosure equipment and against a limited amount of falling dirt.
2 IP31	Provides a degree of protection against limited amounts of falling water and dirt.
3 IP64	Provides a degree of protection against windblown dust, rain and sleet; undamaged by the formation of ice on the enclosure.
3R IP32	Provides a degree of protection against rain and sleet;; undamaged by the formation of ice on the enclosure.
4 (X) IP66	Provides a degree of protection against splashing water, windblown dust and rain, hose directed water; undamaged by the formation of ice on the enclosure. (Resist corrosion).
12/12K IP65	Provides a degree of protection against dust, falling dirt and dripping non corrosive liquids.
13 IP65	Provides a degree of protection against dust and spraying of water, oil and non corrosive coolants.

4 INSTALLATION

4.1 TERMINAL DESCRIPTION



4.1.1 DC SUPPLY & DC OUTPUTS.

	PIN No	DESCRIPTION	CABLE SIZE	NOTES
	1	DC Plant Supply Input (Negative)	2.5mm ² AWG 13	
	2	DC Plant Supply Input (Positive)	2.5 mm ² AWG 13	(Recommended Maximum Fuse 15A anti-surge) Supplies the module (2A anti-surge requirement) and all output relays
	3	Output A	1.0mm ² AWG 18	Volts free relay (8A rated)
	4	Output A	1.0mm ² AWG 18	Volts free relay (8A rated)
	5	Output B	1.0mm ² AWG 18	Volts free relay (8A rated)
	6	Output B	1.0mm ² AWG 18	Volts free relay (8A rated)
	7	Output E	1.0mm ² AWG 18	Plant Supply Positive from terminal 7. 2 Amp rated.
	8	Output F	1.0mm ² AWG 18	Plant Supply Positive from terminal 8. 2 Amp rated.
	9	Output G	1.0mm ² AWG 18	Plant Supply Positive from terminal 9. 2 Amp rated.
	10	Output H	1.0mm ² AWG 18	Plant Supply Positive from terminal 10 2 Amp rated.

4.1.2 DIGITAL INPUTS.

	PIN No	DESCRIPTION	CABLE SIZE	NOTES
	11	Input A	1.0mm ² AWG 18	Configurable input. Connects to plant supply negative
	12	Input B	1.0mm ² AWG 18	Configurable input. Connects to plant supply negative
	13	Input C	1.0mm ² AWG 18	Configurable input. Connects to plant supply negative
	14	Input D	1.0mm ² AWG 18	Configurable input. Connects to plant supply negative

4.1.3 VOLT FREE OUTPUTS.

	PIN No	DESCRIPTION	CABLE SIZE	NOTES
	23	Output C	1.0mm ² AWG 18	User configured volt free output (N/O)
	24	Output C	1.0mm ² AWG 18	User configured volt free output (Common)
	25	Output C	1.0mm ² AWG 18	User configured volt free output (N/C)
	26	Output D	1.0mm ² AWG 18	User configured volt free output (N/O)
	27	Output D	1.0mm ² AWG 18	User configured volt free output (Common)
	28	Output D	1.0mm ² AWG 18	User configured volt free output (N/C)

4.1.4 S1 SENSING



	PIN No	DESCRIPTION	CABLE SIZE	NOTES
	19	S1 L1 (R) voltage monitoring	1.0mm ² AWG 18	Connect to S1 L1 (R) output (AC) (Recommend 2A fuse)
	20	S1 L2 (S) voltage monitoring	1.0mm ² AWG 18	Connect to S1 L2 (S) output (AC) (Recommend 2A fuse)
	21	S1 31 (T) voltage monitoring	1.0mm ² AWG 18	Connect to S1 L3 (T) output (AC) (Recommend 2A fuse)
	22	S1 Neutral (N) input	1.0mm ² AWG 18	Connect to S1 Neutral terminal (AC)

4.1.5 S2 SENSING

	PIN No	DESCRIPTION	CABLE SIZE	NOTES
	15	S2 L1 (R) voltage monitoring	1.0mm ² AWG 18	Connect to S2 L1 (R) output (AC) (Recommend 2A fuse)
	16	S2 L2 (S) voltage monitoring	1.0mm ² AWG 18	Connect to S2 L2 (S) output (AC) (Recommend 2A fuse)
	17	S2 31 (T) voltage monitoring	1.0mm ² AWG 18	Connect to S2 L3 (T) output (AC) (Recommend 2A fuse)
	18	S2 Neutral (N) input	1.0mm ² AWG 18	Connect to S2 Neutral terminal (AC)

4.1.6 PC CONFIGURATION INTERFACE CONNECTOR

This configuration cable is the same as normally used between a PC and a USB printer.

	DESCRIPTION	CABLE SIZE	NOTES
	Socket for connection to PC with DSE Configuration Suite PC software.	0.5mm ² AWG 20	This is a standard USB type A to type B cable. 

NOTE:- The USB connection cable between the PC and the DSE331 module must not be extended beyond 5m (5yds). For distances over 5m, it is possible to use a third party USB extender. Typically, they extend USB up to 50m (yds). The supply and support of this type of equipment is outside the scope of Deep Sea Electronics PLC.

CAUTION! Care must be taken not to overload the PC's USB system by connecting more than the recommended number of USB devices to the PC. For further information, consult your PC supplier.

CAUTION! This socket must not be used for any other purpose.

4.2 TYPICAL WIRING DIAGRAM

As every system has different requirements, these diagrams show only a TYPICAL system and do not intend to show a complete system.

Genset manufacturers and panel builders may use these diagrams as a starting point, however you are referred to the completed system diagram provided by your system manufacturer for complete wiring detail.

Further wiring suggestions are available in the following DSE publication, available at www.deepseapl.com.

DSE PART	DESCRIPTION
056-022	Breaker Control (Training guide)

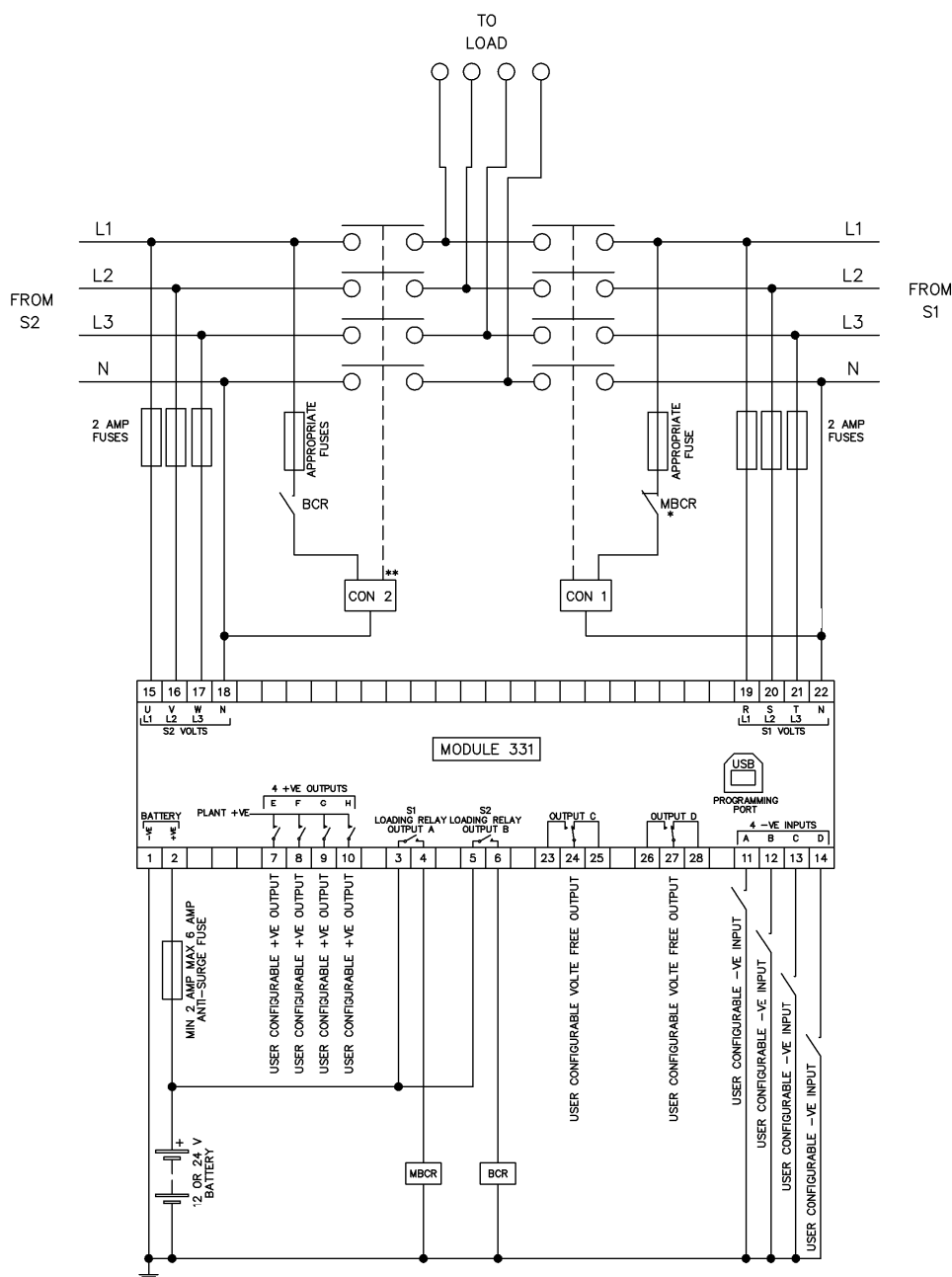

BATTERY NEGATIVE MUST BE GROUNDED
TERMINALS SUITABLE FOR 22-16 AWG
(0.6mm - 1.3mm) FIELD WIRING
TIGHTENING TORQUE = 0.8Nm (7lb-in)

* NOTE 1. MAINS BREAKER CLOSED OUTPUT SHOULD BE CONFIGURED FOR DE-ENERGISE, CLOSE MAINS, AND USE THE NORMALLY CLOSED CONTACTS OF MBCR

**NOTE 2. IT IS RECOMMENDED THAT THE S1 AND S2 SWITCHING DEVICES ARE MECHANICALLY AND ELECTRICALLY INTERLOCKED.

5 DESCRIPTION OF CONTROLS

The following section details the function and meaning of the various controls on the module.

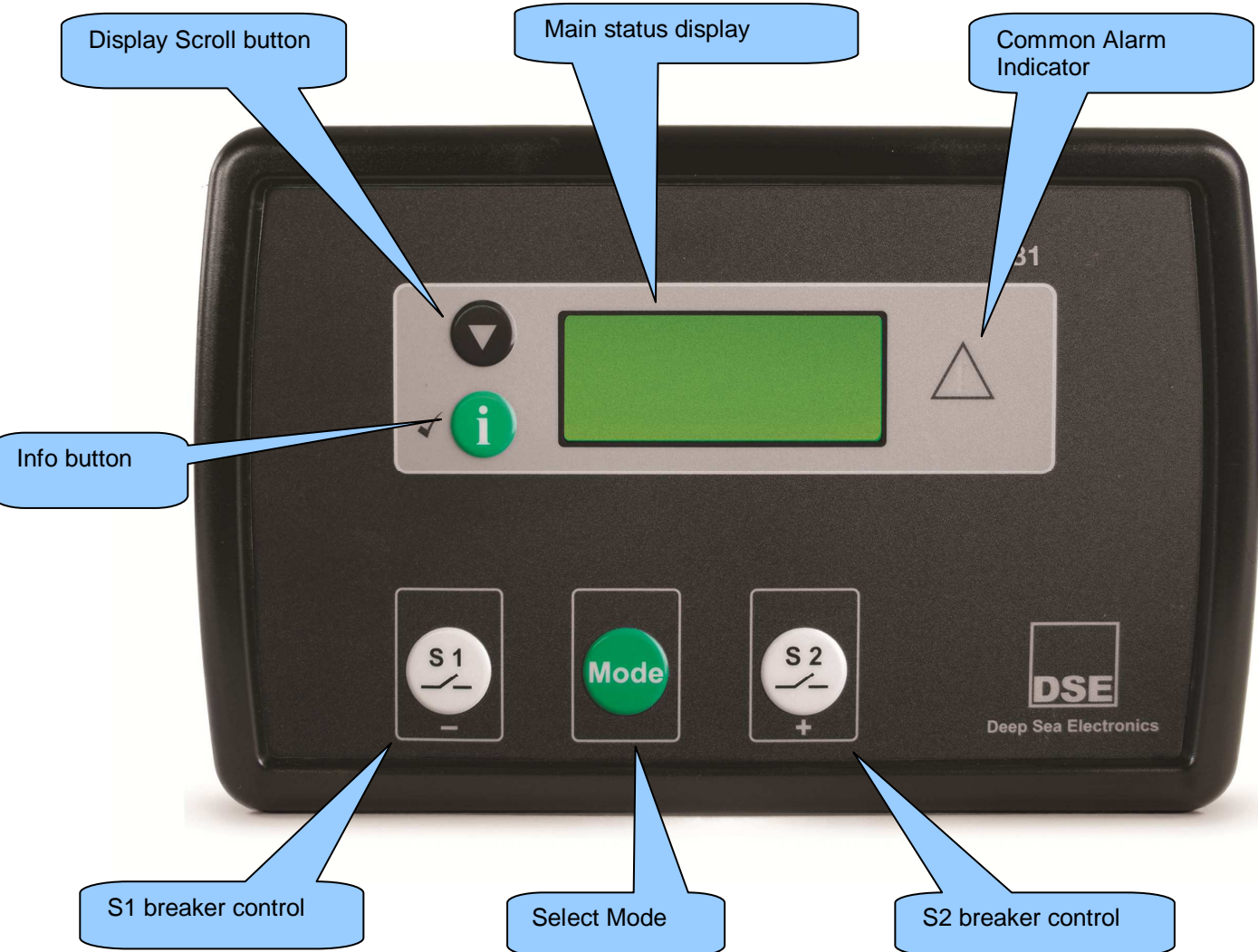

QUICKSTART GUIDE

This section provides a quick start guide to the module's operation.

5.1.1 MODE SELECTION OPERATION

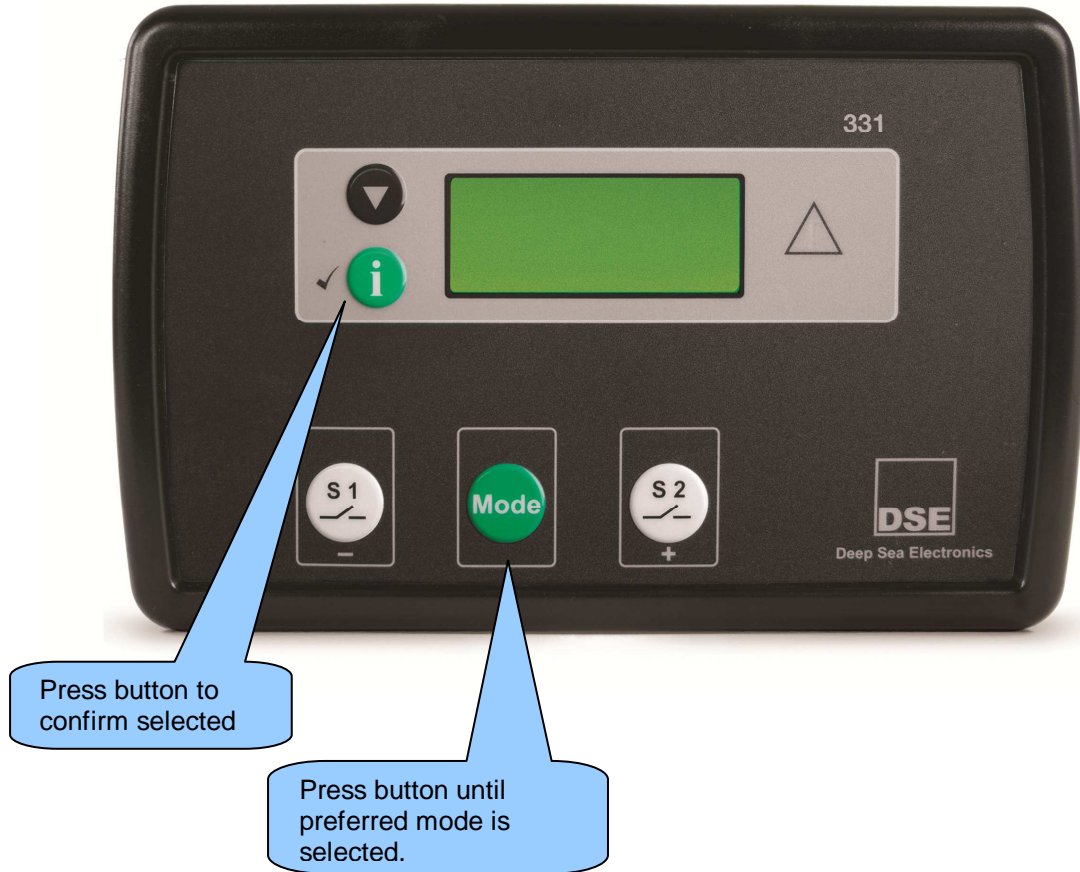

▲ NOTE:- For further details, see the section entitled 'MODE SELECTION' elsewhere in this manual.

5.2 GRAPHICAL DISPLAY

- 4- line, 64 x 132 small Graphic Display with LED Backlight
- Icon and numeric display. Switch to select 'Icon' or 'English' display
- Software controlled contrast
- Mimic of Text insert / 4x indicators via LCD

5.2.1 DISPLAY PAGES

It is possible to scroll to display the different pages of information by repeatedly operating the scroll button 

Once selected the page will remain on the LCD display until the user selects a different page or after an extended period of inactivity, the module will revert to the status display.

When scrolling manually, the display will automatically return to the Status page if no buttons are pressed for the duration of the configurable *LCD Page Timer*.

If an alarm becomes active while viewing the status page, the display shows the Alarms page to draw the operator's attention to the alarm condition.

At power up, the display will show the software version, and then display the default display screen, which will display Mains instrumentation.

5.2.1.1 STATUS

Displays voltage operational status information

Example :

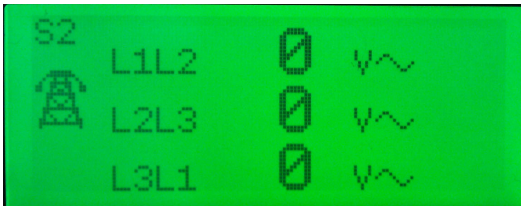

5.2.1.2 INSTRUMENTATION

The instrumentation page contains the following information

S1 Voltage L-N
S1 Voltage L-L
S1 Frequency
S2 Voltage L-N
S2 Voltage L-L
S2 Frequency
Battery Voltage
Scheduler

Example::

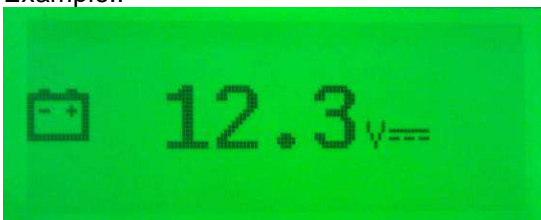

5.2.1.3 ALARMS

Lists any current alarms

Example (English)

(Icon)

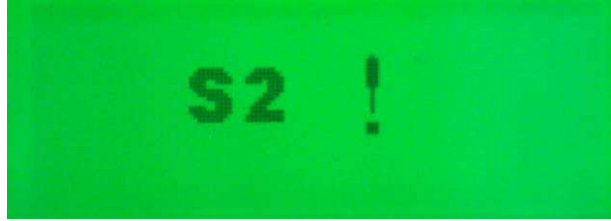
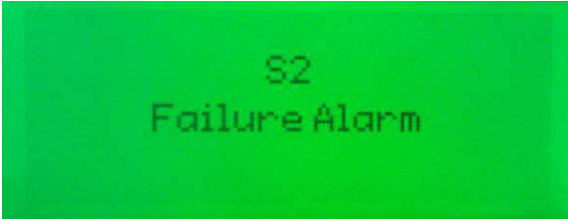

5.2.1.4 SCHEDULER.

Shows the settings of the exercise scheduler

Example:

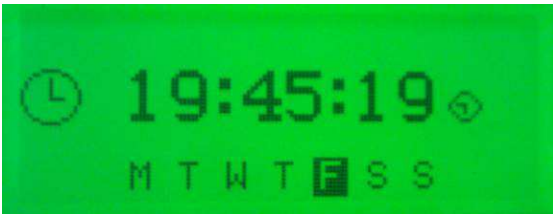

5.2.2 ALARM ICONS

In instances where more than one alarm is present the icon area will transition between icons to display all active alarm conditions. For information alarm conditions see section

Alarm	Icon	Reason
Switch fail alarm	!	The Switching device has failed to operate.
Failed to start	! L	The engine has not fired after the preset number of start attempts.
Failed to stop	⊖	The module has detected a condition that indicates that the engine is running when it has been instructed to stop.
Over Voltage	V ↑	S1 or S2 voltage has risen above the pre-set pre-alarm setting.
Under voltage	V ↓	S1 or S2 voltage has fallen below the pre-set pre-alarm setting.
Over frequency	Hz ↑	S1 or S2 frequency has risen above the pre-set pre-alarm setting.
Under frequency	Hz ↓	S1 or S2 frequency has fallen below the pre-set pre-alarm setting.

5.3 CONTROLS

5.3.1 MODE SELECTION

 **NOTE:-** Icons only apply when display mode in the software programme is set to `icons`

This button selects the preferred mode of operation.  to complete the selection press the  button.

Automatic mode.  This mode allows the module to control the function of the load switching completely automatically. The module will monitor the *remote start* input and mains supply status and once a start request is made, the set will be placed on load.

Upon removal of the starting signal (or S1 supply returns), the module will automatically transfer the load from the generator to the mains and remove the genset starting instruction.

Manual mode.  This mode allows manual control of the ATS functions. Once in this mode the module will send a start request to the generator.



Breakers can be opened and close using the transfer buttons detailed below.

Test mode.  Once in Test mode the module will send a start request to the generator and place the set on load or off load depending what is set in the software. The set will remain on load or off load when in this mode.

Start inhibit mode.  This mode is used to provide an over-ride function to prevent the controller from starting the generator in the event of a remote start/S1 out of limits condition occurring.



Prohibit return.  This mode is used to prevent the module from loading S1 even though S1 has returned.

5.3.2 DISPLAY

This button changes between the various pages About, Status, Instrumentation, Alarms, Event Log, LCD Indicators	
This buttons scrolls through the items in the currently displayed page.	

5.3.3 LOAD SWITCHING CONTROL

Two fascia mounted buttons are provided for load switching operation when in manual mode. These buttons are enabled/disabled in the modules PC configuration Suite so refer to your configuration file to ensure the configuration has enabled the buttons.

Pressing this button when the S1 is on load will open the S1 load switch. Pressing this button when S2 is on load and S1 is healthy, will open S2 load switch, wait for the duration of the <i>transfer delay</i> , then close the S1 load switch.	
Pressing this button when S2 is on load will open the S2 load switch. Pressing this button when the S1 is on load and S2 is available, will open the S1 load switch, wait for the duration of the <i>transfer delay</i> , then close S2 load switch.	

6 OPERATION

6.1 AUTOMATIC MODE OF OPERATION

 **NOTE:-** If a digital input configured to external *panel lock* is active, changing module modes will not be possible. Viewing the instruments is **NOT** affected by panel lock.

Activate auto mode by pressing the mode button until **Auto** is selected and then press  the button to confirm.

Auto mode will allow the transfer system to operate fully automatically, switching between S1 and S2 as required with no user intervention.

6.1.1 WAITING IN AUTO MODE

If a starting request is made and there is no input present for *Auto Start Inhibit*, the starting sequence will begin. Starting requests can be from the following sources :

- S1 failure
- Activation of an auxiliary input that has been configured to *remote start*
- Activation of the inbuilt exercise scheduler.

6.1.2 STARTING SEQUENCE

To allow for 'false' start requests, the *start delay* timer begins.

Should all start requests be removed during the *start delay* timer, the unit will return to a stand-by state.

When S2 is configured for a generator If a start request is still present at the end of the *start delay* timer the *Start and Run S2* output will be energised. After the generator has started, it will enter the warming up timer.

If S2 fails to become available before the *S2 Fail Delay* timer expires the module will alarm. This is indicated on the LCD display but the starting signal remains active.

6.1.3 S1 / S2 ON LOAD

Once S2 is measured as being within limits S1 is removed from the load, and after the *transfer timer* has expired, S2 is placed on load.

If all start requests are removed and there is no input present for *Auto Restore Inhibit*, the *stopping sequence* will begin.

6.1.4 STOPPING SEQUENCE

The *return delay* timer operates to ensure that the starting request has been permanently removed and isn't just a short term removal.

After the return delay timer, the generator load switch is opened, then after the transfer timers, the mains is placed back on load.

Should another start request be made during the cooling down period, the generator will be placed on load.

The *cooling* timer allows the set to run off load and cool sufficiently before being stopped. This is particularly important where turbo chargers are fitted to the engine.

After the *cooling* timer has expired, the set is stopped.

6.2 MANUAL OPERATION

NOTE:- If a digital input configured to *panel lock* is active, changing module modes will not be possible. Viewing the instruments and event logs is NOT affected by panel lock.

Manual mode allows the operator to change the state of the load switching devices.

6.2.1 STARTING SEQUENCE

NOTE:- There is no *start delay* in this mode of operation.

The start request is sent to the generator via a digital output configured to Start and Run S2.

If S2 fails to become available before the *S2 failure* timer expires. This is indicated on the LCD display, but the starting signal remains active.

6.2.2 S1 OFF LOAD

The generator will continue run OFF LOAD in this mode unless :

- S1 supply fails
- An input is given for *Auxiliary S1 fail*
- An input is given for *Transfer to S2*
- The fascia mounted transfer buttons are pressed (when configured)



6.2.3 S2 ON LOAD

Once on load, the generator will remain on load unless:

- An input is given for *Transfer to S1*
- The fascia mounted transfer buttons are pressed (when configured)
- The module mode is changed to AUTO mode. The system may then transfer back to mains supply automatically if conditions are suitable.

6.2.4 TRANSFER BUTTONS OPERATION

Two fascia mounted buttons are provided for load switching operation when in manual mode. These buttons are enabled/disabled in the modules PC configuration Suite so refer to your configuration file to ensure the configuration has enabled the buttons.

Pressing this button when S1 is on load will open S1 load switch. Pressing this button when S2 is on load and S1 is healthy, will open S2 load switch, wait for the duration of the <i>transfer delay</i> , then close the S1 load switch.	
Pressing this button when S2 is on load will open S2 load switch. Pressing this button when S1 is on load and S2 is available, will open S1 load switch, wait for the duration of the <i>transfer delay</i> , then close S2 load switch.	

6.2.5 STOPPING SEQUENCE

The set will not be stopped in this mode of operation.

To begin the stopping sequence, the module should be placed in the AUTO or START INHIBIT  mode.

6.3 TEST ON OPERATION

 **NOTE:-** If a digital input configured to *panel lock* is active, changing module modes will not be possible. Viewing the instruments and event logs is **NOT** affected by panel lock.

Test mode allows the operator to start and stop the set manually, and if required change the state of the load switching devices. Test on load and Test off load is selectable in the software.

6.3.1 STARTING SEQUENCE

 **NOTE:-** There is no *start delay* in this mode of operation.

The start request is sent to the generator via a digital output configured to Start and Run S2.

If S2 fails to become available before S2 fail delay timer expires. This is indicated on the LCD display, but the starting signal remains active.

6.3.2 S2 ON LOAD

S2 will continue run ON LOAD in this mode unless :

- S2 supply fails – S2 supply is placed back on load if available.
- An input is given for *Open/Close S1*

6.3.3 STOPPING SEQUENCE

The set will not be stopped in this mode of operation.

To begin the stopping sequence, the module should be placed in the AUTO or START INHIBIT mode.

6.4 LOAD SWITCHING CONTROL

The following timing diagrams detail the differences between the load switching control options.

6.4.1 BREAKER SCHEME A

NOTE : S2 Closed Auxiliary and S1 Closed Auxiliary inputs do not affect the operation of the load switching in *Breaker Scheme A*

6.4.2 S1 / S2 LOAD INHIBIT

Activation of an input configured to *S1 load inhibit* or *S2 load inhibit* inputs cause the corresponding breaker to be opened immediately. No other change in function will occur.

When the input is deactivated the breaker is closed again if appropriate.

6.4.3 LOAD SHEDDING

If an input configured to Load Shed is activated, outputs set to Open S1 and Open S2 will energise, and inputs configured to Open/CloseS1 and Open/CloseS2 will de-energise. Open S1 Output Pulse and Open S2 Output Pulse will only energise if the corresponding supply was on load before application of the Load Shed input.

When the Load Shed input is deactivated, the load will be transferred back to the supply that was disconnected before application of the input.

6.4.4 TIMING DIAGRAM

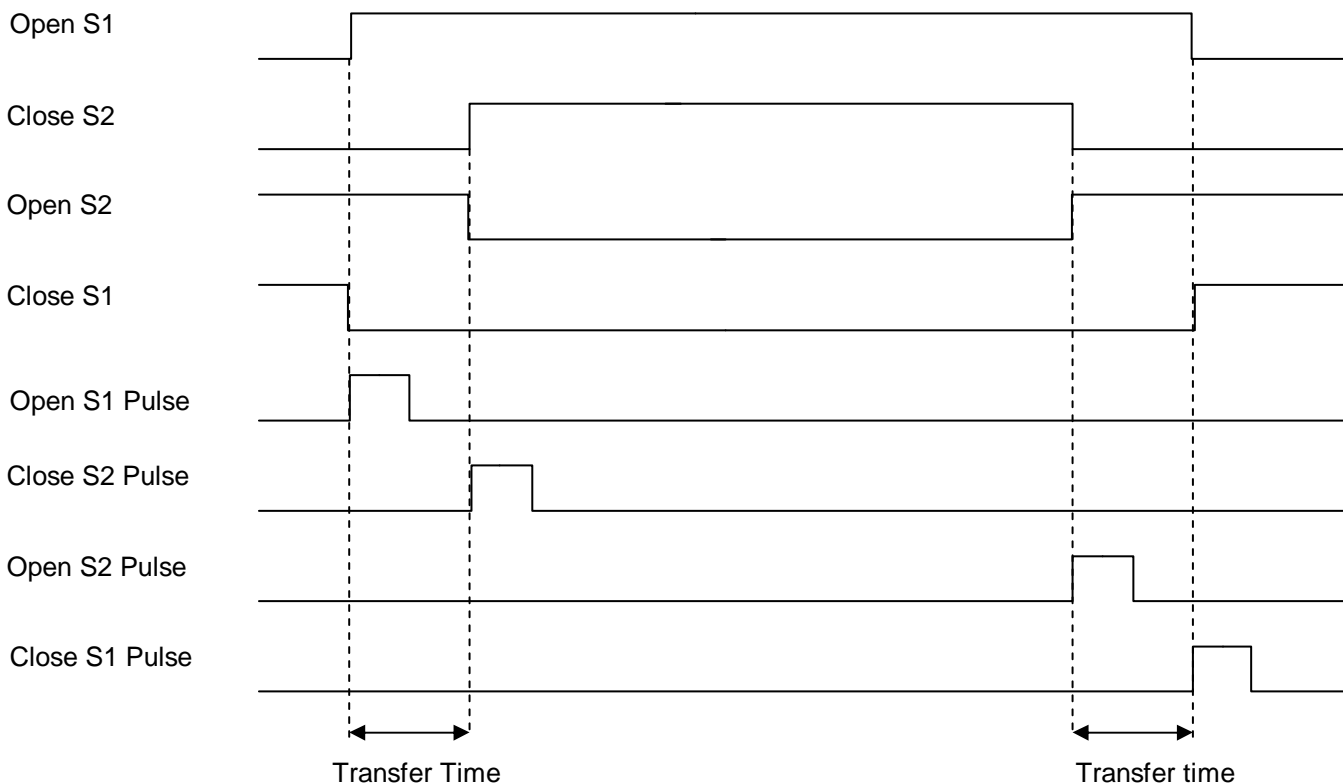

6.4.5 BREAKER SCHEME B

Breaker Scheme B is intended only for use with certain designs of transfer switch. If you are using contactors, you MUST select Breaker Scheme A.

6.4.5.1 CHECK SYNCHRONISING IS DISABLED

6.4.5.1.1 TRANSFERRING TO S2

To open S2 breaker the *Open S1* output energises, it then de-energises when the *S1 Closed Auxiliary* indicates it has successfully opened, or after 1s whichever occurs first.

When the 'S1 Closed Auxiliary' indicates the mains breaker has opened, the *transfer timer* begins.

When the *transfer timer* expires, the module attempts to close S2 breaker by energising the *Open S1* and *Close S2* outputs simultaneously, it then de-energises these outputs when the *S2 Closed Auxiliary* input indicates it has successfully closed, or after 1s whichever occurs first.

6.4.5.1.2 TRANSFERRING TO S1

To open S1 breaker the *Open S2* output energises, it then de-energises when the *S2 Closed Auxiliary* indicates it has successfully opened, or after 1s whichever occurs first.

When the 'S2 Closed Auxiliary' indicates S2 breaker has opened, the *transfer timer* begins.

When the *transfer timer* expires, the module attempts to close S1 breaker by energising the *Open S2* and *Close S1* outputs simultaneously, it then de-energises these outputs when *S1 Closed Auxiliary* input indicates it has successfully closed, or after 1s whichever occurs first

6.4.5.1.3 LOAD SHED INPUT

When the *Load Shed* input is activated while the generator is closed the *Open S2* output energises, it then de-energises when the *S2 Closed Auxiliary* input indicates that it has successfully opened, or after 1s whichever occurs first.

When the *Load Shed* input is activated while the mains is closed the *Open S1* output energises, it then de-energises when the *S1 Closed Auxiliary* input indicates that it has successfully opened, or after 1s whichever occurs first.

When the *Load shed* input is de-energised the load will be returned to the supply that was disconnected, providing that supply is healthy.

6.4.5.1.4 TIMING DIAGRAM

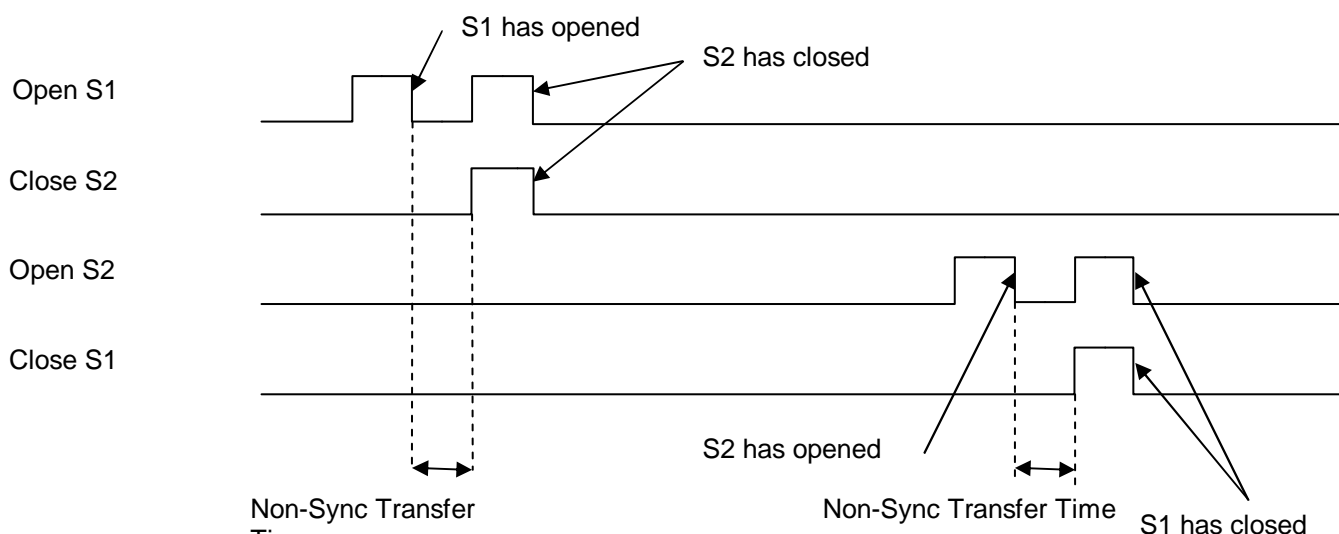

6.4.5.2 CHECK SYNCHRONISING IS ENABLED

NOTE : The module waits indefinitely for synchronisation unless the 'Return to programmed transition' function is active in which case after 2 minutes it performs a non-sync transfer as described in the previous section.

NOTE : The transfer time is ignored during a check-sync but is used if the transfer fails and it performs a non-sync transfer.

6.4.5.2.1 TRANSFER TO S2

When the module is about to transfer from S1 to S2 it activates the check sync function. When the S1 and S2 are within the phase and frequency window the module energises the *Open S1* and *Close S2* outputs simultaneously. These outputs are de-energised when the *S2 Closed Auxiliary* input indicates it has successfully closed, or after 1s whichever occurs first.

6.4.5.2.2 TRANSFER TO S1

When the module is about to transfer from S2 to S1 it activates the check sync function. When S1 and S1 are within the phase and frequency window the module energises the *Open S2* and *Close S1* outputs simultaneously. These outputs are de-energised when the *S2 Closed Auxiliary* input indicates it has successfully closed, or after 1s whichever occurs first.

6.4.5.2.3 LOAD SHED INPUT

When the *Load Shed* input is activated while the S2 is closed the *Open S2* output energises, it then de-energises when the *S2 Closed Auxiliary* input indicates that it has successfully opened, or after 1s whichever occurs first.

When the *Load Shed* input is activated while the mains is closed the *Open S1* output energises, it then de-energises when the *S1 Closed Auxiliary* input indicates that it has successfully opened, or after 1s whichever occurs first.

When the *Load shed* input is de-energised the load will be returned to the supply that was disconnected, providing that supply is healthy.

6.4.5.2.4 TIMING DIAGRAM

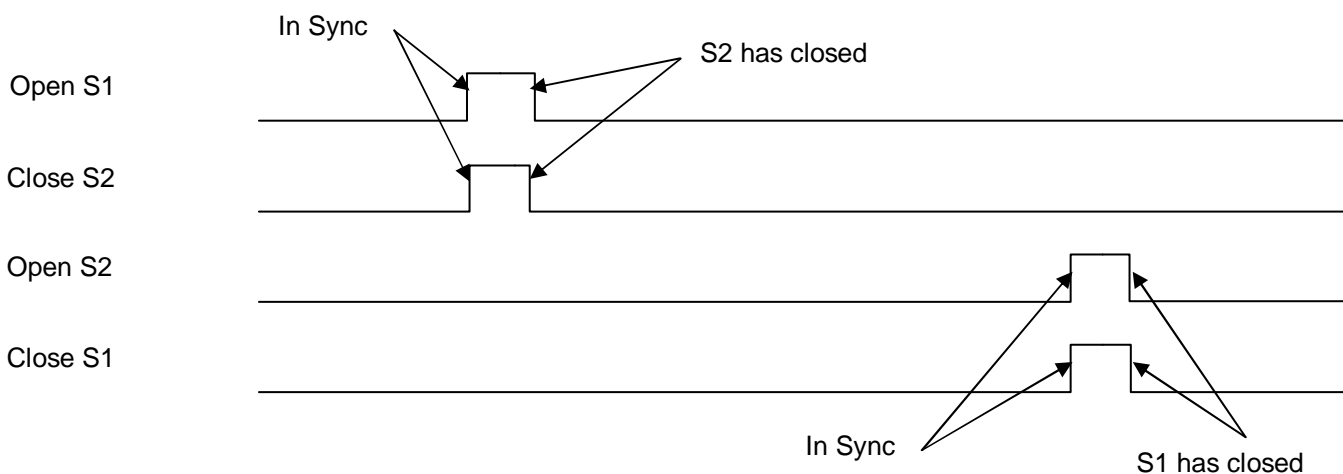

7 PROTECTIONS

7.1 S2

The 331 ATS module monitors the S2 supply to ensure that it remains within configured levels. If the S2 supply fails, it is taken off load and the start/run signal is removed.

S2 failure

S2 has not become available after the period of the *S2 Failure* timer has expired.

S2 Under Voltage shutdown

The S2 supply is below the configured *under voltage* trip level

S2 Under Frequency shutdown

The S2 supply is below the configured *under frequency* trip level

Failed to reach loading voltage

S2 is running and within under / over voltage trip points, but has failed to reach the configured *Loading Voltage*, hence it is unfit to take load.

Failed to reach loading frequency

S2 is running and within under / over frequency trip points, but has failed to reach the configured *Loading Frequency*, hence it is unfit to take load.

7.2 S1

S1 alarms signal that the mains supply is out of limits. In AUTO mode, the generator is called to start (if not already running) and will be placed on load when available.

If the S1 supply fails while the S2 is running in MANUAL mode, the 331 ATS module transfers load to S2 supply. Should an input configured to *Simulate S1 Available* be active, the mains failure detection is inhibited.

S1 failure

Combined message to indicate the failure of the mains supply or activation of an input configured to *Auxiliary S1 Failure*.

S1 Under Frequency trip

The S1 supply is below the configured *Under Frequency* trip level.

S1 Under Voltage trip

The S1 supply is below the configured *Under Voltage* trip level.

S1 Over Frequency trip

The S1 supply is above the configured *Over Frequency* trip level.

S1 Over Voltage trip

The S1 supply is above the configured *Over Voltage* trip level.

7.3 PLANT BATTERY

Plant battery alarms are *Warning* alarms only. The module displays the fault but no further action is taken.

Under Voltage warning

The battery supply is below the configured *Under Voltage* warning level.

Over Voltage warning

The battery supply is above the configured *Over Voltage* warning level.

8 FRONT PANEL CONFIGURATION

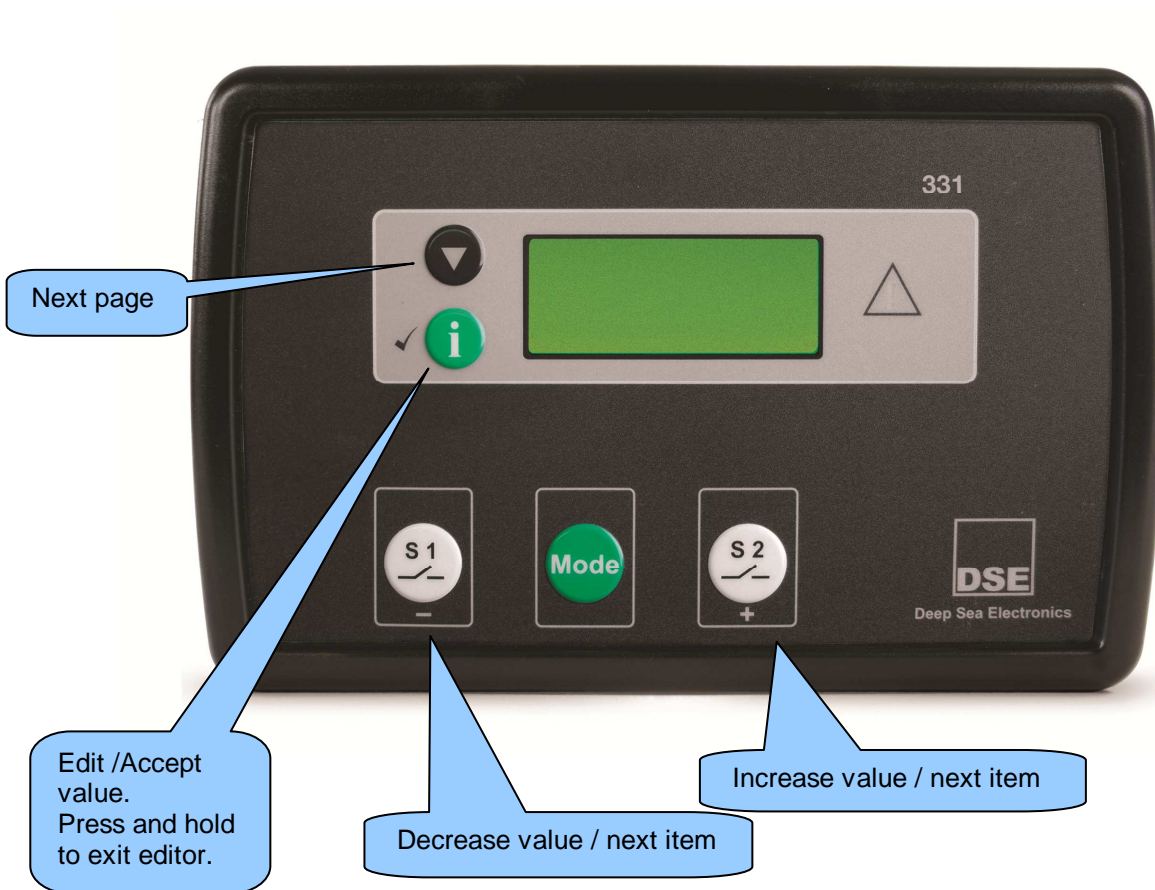

This configuration mode allows the operator limited customising of the way the module operates.

Use the module's navigation buttons to traverse the menu and make value changes to the parameters:





8.1 ACCESSING THE FRONT PANEL EDITOR (FPE)

To enter the 'configuration mode' press and hold the  button



 **NOTE:-** To exit the front panel configuration editor and activate your changes, press and hold the  button. Ensure you have saved any changes you have made by pressing the  button first.

 **NOTE:-** When the editor is visible, it is automatically exited after 5 minutes of inactivity to ensure security.



8.1.1 EDITING A PARAMETER

Press  (+) to select the next parameter or  (-) to select the previous parameter

When viewing the parameter to be changed, press the  button. The value begins to flash.

Press  (+) or  (-) to adjust the value to the required setting.

Press  the save the current value, the value ceases flashing.

Press and hold the  button to exit the editor, the configuration icon  will be removed from the display.

8.2 ADJUSTABLE PARAMETERS (CONFIGURATION EDITOR)

When viewing the configuration editor, Press  to select the required 'page' as listed below.

Front Panel Configuration Editor (Factory default settings are shown in bold italicised text)

CONFIGURATION PARAMETERS – MODULE (Page 1)		
101	Contrast	000 (%)
102	Display mode	Icon only (1), English (0)
103	S1 Option	Generator (1), Mains (0)
104	S1 Summary screen phase display	1-3
105	S2 Option	Generator (1), Mains (0)
106	S2 Summary screen phase display	1-3
107	Lamp test at power up	On (1), Off (0)
108	Power up in auto	On (1), Off (0)
109	Enable transfer by buttons	On (1), Off (0)
110	Test mode	On Load (1), Off Load (0)

CONFIGURATION PARAMETERS – APPLICATION (Page 2)		
201	Breaker Type	Scheme B (1), Scheme A(0)
202	Check Sync	On (1), Off (0)
203	Return to Programmed Transition	On (1), Off (0)
204	Display mode	Icon only (1), English (0)

Front Panel Configuration

CONFIGURATION PARAMETERS – INPUTS (Page 3)		
301	Digital Input A Source	0 (Input Source List)
302	Digital Input A Polarity	0 (Input Polarity List)
303	Digital Input B Source	0 (Input Source List)
304	Digital Input B Polarity	0 (Input Polarity List)
305	Digital Input C Source	0 (Input Source List)
306	Digital Input C Polarity	0 (Input Polarity List)
307	Digital Input D Source	0 (Input Source List)
308	Digital Input D Polarity	0 (Input Polarity List)

CONFIGURATION PARAMETERS – OUTPUTS (Page 4)		
401	Digital Output A Source	0 (Output Source List)
402	Digital Output A Polarity	0 (Output Source Polarity)
403	Digital Output B Source	0 (Output Source List)
404	Digital Output B Polarity	0 (Output Source Polarity)
405	Digital Output C Source	0 (Output Source List)
406	Digital Output C Polarity	0 (Output Source Polarity)
407	Digital Output D Source	0 (Output Source List)
408	Digital Output D Polarity	0 (Output Source Polarity)
409	Digital Output E Source	0 (Output Source List)
410	Digital Output E Polarity	0 (Output Source Polarity)
411	Digital Output F Source	0 (Output Source List)
412	Digital Output F Polarity	0 (Output Source Polarity)
413	Digital Output G Source	0 (Output Source List)
414	Digital Output G Polarity	0 (Output Source Polarity)
415	Digital Output H Source	0 (Output Source List)
416	Digital Output H Polarity	0 (Output Source Polarity)

CONFIGURATION PARAMETERS – TIMERS (Page 5)			
501	S1 Transient Delay	509	Breaker trip pulse
502	Start Delay	510	Return delay
503	Warming time	511	Cooling time
504	S2 Fail delay	512	S2 transient delay
505	Elevator Delay	513	Fail to stop enable
506	Non-sync transfer time	514	Fai to stop delay
507	Check sync transfer time	515	LCD Page timer
508	Breaker close pulse	516	LCD Scroll timer

CONFIGURATION PARAMETERS – S1 (Page 6)		
601	Immediate S1 dropout	On (1), Off (0)
602	AC system	0 (AC System)
603	Under voltage enable	On (1), Off (0)
604	Under voltage trip	0 V
605	Under voltage return	0 V
606	Over voltage enable	On (1), Off (0)
607	Over voltage return	0 V
608	Over voltage trip	0 V
609	Under frequency enable	On (1), Off (0)
610	Under frequency trip	0.0 Hz
611	Under frequency return	0.0 Hz
612	Over frequency enable	On (1), Off (0)
613	Over frequency return	0.0 Hz
614	Over frequency trip	0.0 Hz

Front Panel Configuration

CONFIGURATION PARAMETERS – S2 (Page 7)		
701	Immediate S2 dropout	On (1), Off (0)
702	Under voltage enable (Generator Option)	On (1), Off (0)
703	Under voltage trip (Generator Option)	0 V
704	Loading voltage (Generator Option)	0 V
705	Over voltage enable (Generator Option)	On (1), Off (0)
706	Over voltage trip (Generator Option)	0 V
707	Under frequency enable (Generator Option)	On (1), Off (0)
708	Under frequency trip (Generator Option)	0.0 Hz
709	Loading frequency (Generator Option)	0.0 Hz
710	Over frequency enable (Generator Option)	On (1), Off (0)
711	Over frequency trip (Generator Option)	0.0 Hz
712	Under voltage enable (Mains Option)	On (1), Off (0)
713	Under voltage (Mains Option)	0 V
714	Under voltage return (Mains Option)	0 V
715	Over voltage enable (Mains Option)	On (1), Off (0)
716	Over voltage return (Mains Option)	0 V
717	Over voltage trip (Mains Option)	0 V
718	Under frequency enable (Mains Option)	On (1), Off (0)
719	Under frequency (Mains Option)	0.0 Hz
720	Under frequency return (Mains Option)	0.0 Hz
721	Over frequency enable (Mains Option)	On (1), Off (0)
722	Over frequency return (Mains Option)	0.0 Hz
723	Over frequency trip (Mains Option)	0.0 Hz

CONFIGURATION PARAMETERS – PLANT BATTERY (Page 8)		
801	Under voltage enable	On (1), Off (0)
802	Under voltage	0.0 V
803	Under voltage return	0.0 V
804	Under voltage delay	0.00.00
805	Over voltage enable	On (1), Off (0)
806	Over voltage return	0.0 V
807	Over voltage trip	0.0 V
808	Over voltage delay	0.00.00

CONFIGURATION PARAMETERS – SCHEDULER (Page 9)		
901	Enable scheduler	On (1), Off (0)
902	On or off load	On (1), Off (0)
903	Start time	0:00
904	Day	1-7 (Day, 1=Monday)
905	Duration	0:00

CONFIGURATION PARAMETERS – TIME (Page 10)		
1001	Time of day	0:00
1002	Day of week	1-7 (Day, 1=Monday)
1003	Start time	0:00

Front Panel Configuration

Parameters with multiple choices use the following identification tables for the parameter values:

INPUT SOURCE LIST	
0	Not used
1	Alarm Reset
2	Alarm Mute
3	Auto Restore Inhibit
4	Auto Start Inhibit
5	Auxiliary S2 Available
6	Auxiliary S1 Fail
7	S2 Load Inhibit
8	S2 Closed Auxiliary
9	Inhibit Scheduled Run
10	Lamp Test
11	Load Shedding
12	S1 Closed Auxiliary
13	S1 Load Inhibit
14	Open / Close S2
15	Open / Close S1
16	Panel Lock
17	Remote Start off-load
18	Remote Start on-load
19	Simulated S1 available
20	Simulated S2 available

INPUT POLARITY LIST	
Index	Action
0	Close to Activate
1	Open to Activate

INPUT ARMING LIST	
Index	Arming
0	Always
1	From Safety On
2	From Starting
3	Never

OUTPUT POLARITY LIST	
Index	Arming
0	Energise
1	De-energise

INPUT ACTION LIST	
Index	Action
0	Electrical Trip
1	Shutdown
2	Warning

AC SYSTEM	
Index	Type
0	3 phase 4 wire
1	Single phase 2 wire
2	3 phase 3 wire
3	2 phase 3 wire (L1-L2)
4	2 phase 3 wire (L1-L3)
5	3 phase 4 wire (Delta)

Front Panel Configuration

OUTPUT SOURCE LIST	
0	Not Used
1	Audible Alarm
2	Battery High Voltage
3	Battery Low Voltage
4	Close S2 Output
5	Close S2 Output Pulse
6	Close S1 Output
7	Close S1 Output Pulse
8	Close to N Output
9	Close to N Output Pulse
10	Common Warning
11	Cooling Down
12	Digital Input A
13	Digital Input B
14	Digital Input C
15	Digital Input D
16	Elevator Control
17	Fail to start
18	Fail to stop
19	Fail to reach loading voltage
20	Fail to reach loading frequency
21	S2 Available
22	S2 Failure Latched
23	S2 Failure Unlatched
24	S2 In Limits
25	S2 Load Inhibited
26	S2 ready
27	S1 Failure unlatched
28	S1 Failure latched
29	S1 High Frequency
30	S1 High Voltage
31	S1 In Limits
32	S1 Load Inhibited
33	S1 Low Frequency
34	S1 Low Voltage
35	Return Delay
36	Open S2 Output
37	Open S2 Output Pulse
38	Open S1 Output
39	Open S1 Output Pulse
40	Scheduled Run
41	Start And Run S2
42	Start Delay
43	Waiting For S2
44	Waiting For Manual Restore
45	Warming Up



9 MAINTENANCE, SPARES, REPAIR AND SERVICING

The DSE331 Series controller is designed to be *Fit and Forget*. As such, there are no user serviceable parts within the controller.

In the case of malfunction, you should contact your original equipment supplier (OEM).

9.1 PURCHASING ADDITIONAL CONNECTOR PLUGS FROM DSE

If you require additional plugs from DSE, please contact our Sales department using the part numbers below.

Module terminal designation	Plug description	Part No.
1-10 	10 way 5.08mm	007-450
11-14 	4 way 5.08mm	007-444
15-22 S2 S1	8 way 7.62mm	007-454
23-28 	6 way 5.08mm	007-446

9.2 PURCHASING ADDITIONAL FIXING CLIPS FROM DSE

Item	Description	Part No.
	DSE331 / DSE3xx series fixing clips (packet of 2)	020-294

9.3 PURCHASING SEALING GASKET FROM DSE

The optional sealing gasket is not supplied with the controller but can be purchased separately.

Item	Description	Part No.
	DSE331 silicon sealing gasket	020-313

10 WARRANTY

DSE provides limited warranty to the equipment purchaser at the point of sale. For full details of any applicable warranty, you are referred to your original equipment supplier (OEM).

11 DISPOSAL

11.1 WEEE (WASTE ELECTRICAL AND ELECTRONIC EQUIPMENT)

Directive 2002/96/EC

If you use electrical and electronic equipment you must store, collect, treat, recycle and dispose of WEEE separately from your other waste.



11.2 ROHS (RESTRICTION OF HAZARDOUS SUBSTANCES)

Directive 2002/95/EC:2006

To remove specified hazardous substances (Lead, Mercury, Hexavalent Chromium, Cadmium, PBB & PBDE's)

Exemption Note: Category 9. (Monitoring & Control Instruments) as defined in Annex 1B of the WEEE directive will be exempt from the RoHS legislation. This was confirmed in the August 2005 UK's Department of Trade and Industry RoHS REGULATIONS Guide (Para 11).

Despite this exemption DSE has been carefully removing all non RoHS compliant components from our supply chain and products.

When this is completed a Lead Free & RoHS compatible manufacturing process will be phased into DSE production.

This is a process that is almost complete and is being phased through different product groups.

12 APPENDIX

12.1 COMMUNICATIONS OPTION CONNECTIONS

12.1.1 DESCRIPTION

The DSE Configuration Suite software allows the controller to communicate with a PC. The computer connects to the module as shown below and allows easy adjustment of the operating parameters and firmware update of the controller.

12.1.2 PC TO CONTROLLER (DIRECT) CONNECTION

To connect a 331 ATS module to a PC the following items are required: -

- DSE331 series module
- Configuration Suite software (Supplied on configuration suite software CD or available from www.deepseapl.com).
- USB cable Type A to Type B.



NOTE:- The DC supply must be connected to the module for configuration by PC.

NOTE:- Refer to DSE Configuration Suite software Manual (057-149) for further details on configuring the module by PC.

This Page is Intentionally blank

This Page is Intentionally blank