



DEEP SEA ELECTRONICS PLC

DSE334 ATS Controller Operators Manual

Document Number 057-154

Author: Allan Jones



Deep Sea Electronics Plc
 Highfield House
 Hunmanby
 North Yorkshire
 YO14 0PH
 ENGLAND

Sales Tel: +44 (0) 1723 890099
 Sales Fax: +44 (0) 1723 893303

E-mail: sales@deepseapl.com
 Website: www.deepseapl.com

DSE Model 334 ATS controller Operators Manual

© Deep Sea Electronics Plc

All rights reserved. No part of this publication may be reproduced in any material form (including photocopying or storing in any medium by electronic means or other) without the written permission of the copyright holder except in accordance with the provisions of the Copyright, Designs and Patents Act 1988.

Applications for the copyright holder's written permission to reproduce any part of this publication should be addressed to Deep Sea Electronics Plc at the address above.

The DSE logo is a UK registered trademarks of Deep Sea Electronics PLC.

Any reference to trademarked product names used within this publication is owned by their respective companies.

Deep Sea Electronics Plc reserves the right to change the contents of this document without prior notice.

Amendments List

Issue	Comments	Minimum Module version required	Minimum Configuration Suite Version required
1	Initial release	1	

Typeface: The typeface used in this document is *Arial*. Care should be taken not to mistake the upper case letter I with the numeral 1. The numeral 1 has a top serif to avoid this confusion.

	NOTE:	Highlights an essential element of a procedure to ensure correctness.
	CAUTION!:	Indicates a procedure or practice which, if not strictly observed, could result in damage or destruction of equipment.
	WARNING!:	Indicates a procedure or practice which could result in injury to personnel or loss of life if not followed correctly.
	©	Deep Sea Electronics Plc owns the copyright to this manual, which cannot be copied, reproduced or disclosed to a third party without prior written permission.
SAE		Society of Automotive Engineers (USA)

TABLE OF CONTENTS

1	BIBLIOGRAPHY	6
2	INTRODUCTION	6
3	SPECIFICATIONS.....	7
3.1	PART NUMBERING	7
3.1	POWER SUPPLY REQUIREMENTS	8
3.2	TERMINAL SPECIFICATION.....	8
3.3	S1 /S2 VOLTAGE / FREQUENCY SENSING	8
3.4	INPUTS.....	9
3.4.1	DIGITAL INPUTS.....	9
3.5	OUTPUTS.....	9
3.5.1	S1 / S2 LOADING OUTPUTS A & B.....	9
3.5.2	START/RUN OUTPUT C.....	9
3.5.3	CONFIGURABLE OUTPUTS D & E	9
3.6	COMMUNICATION PORTS	9
3.7	DIMENSIONS AND MOUNTING	10
3.7.1	DIMENSIONS	10
3.7.2	PANEL CUTOUT	10
3.7.3	WEIGHT.....	10
3.7.4	FIXING CLIPS.....	10
3.7.5	OPTIONAL SILICON SEALING GASKET	10
3.8	APPLICABLE STANDARDS	11
4	INSTALLATION	12
4.1	TERMINAL DESCRIPTION	12
4.1.1	DC SUPPLY AND OUTPUT C	12
4.1.2	OUTPUTS D & E AND FUNCTIONAL EARTH.....	12
4.1.3	DIGITAL INPUTS.....	12
4.1.4	LOAD SWITCHING AND S2 SENSING	13
4.1.5	S1 SENSING.....	13
4.1.6	CURRENT TRANSFORMERS.....	14
4.1.7	PC CONFIGURATION INTERFACE CONNECTOR.....	15
4.2	TYPICAL WIRING DIAGRAM	16
5	DESCRIPTION OF CONTROLS	17
5.1	QUICKSTART GUIDE	19
5.1.1	STANDBY OPERATION	19
5.2	GRAPHICAL DISPLAY	20
5.2.1	DISPLAY PAGES	20
5.2.1.1	STATUS.....	20
5.2.1.2	INSTRUMENTATION.....	20
5.2.1.3	ALARMS	21
5.2.1.4	EVENT LOG.....	21
5.2.1.5	LCD INDICATORS.....	21
5.2.1.6	SCHEDULE.....	21
5.2.1.7	ABOUT.....	22
5.2.1.8	ALARM ICONS	22
5.3	CONTROLS.....	24
5.3.1	MODE SELECTION.....	24
5.3.2	DISPLAY.....	24
5.3.3	LOAD SWITCHING CONTROL	24
6	OPERATION	25
6.1	AUTOMATIC MODE OF OPERATION.....	25

6.1.1	WAITING IN AUTO MODE	25
6.1.2	STARTING SEQUENCE	25
6.1.3	S2 ON LOAD.....	25
6.1.4	STOPPING SEQUENCE.....	25
6.2	MANUAL OPERATION.....	26
6.2.1	STARTING SEQUENCE.....	26
6.2.2	S2 OFF LOAD.....	26
6.2.3	S2 ON LOAD.....	26
6.2.4	TRANSFER BUTTONS OPERATION	26
6.2.5	STOPPING SEQUENCE.....	26
6.3	TEST ON LOAD OPERATION.....	27
6.3.1	STARTING SEQUENCE.....	27
6.3.2	S2 ON LOAD.....	27
6.3.3	STOPPING SEQUENCE.....	27
6.4	LOAD SWITCHING CONTROL	28
6.4.1	BREAKER SCHEME A.....	28
6.4.2	S1 / S2 LOAD INHIBIT.....	28
6.4.3	LOAD SHEDDING	28
6.4.4	TIMING DIAGRAM.....	28
6.4.5	BREAKER SCHEME B.....	29
6.4.5.1	CHECK SYNCHRONISING IS DISABLED	29
6.4.5.1.1	TRANSFERRING TO S2.....	29
6.4.5.1.2	TRANSFERRING TO S1.....	29
6.4.5.1.3	LOAD SHED INPUT	29
6.4.5.1.4	TIMING DIAGRAM	29
6.4.5.2	CHECK SYNCHRONISING IS ENABLED	30
6.4.5.2.1	TRANSFER TO S2.....	30
6.4.5.2.2	TRANSFER TO S1.....	30
6.4.5.2.3	LOAD SHED INPUT	30
6.4.5.2.4	TIMING DIAGRAM	30
7	MODULE DISPLAY.....	31
7.1	BACKLIGHT	31
7.2	PROTECTIONS	31
7.2.1	S2.....	31
7.2.2	S1.....	31
7.2.3	PLANT BATTERY.....	32
8	FRONT PANEL CONFIGURATION.....	33
8.1	ACCESSING THE FRONT PANEL EDITOR (FPE).....	34
8.1.1	EDITING A PARAMETER.....	34
8.2	ADJUSTABLE PARAMETERS (CONFIGURATION EDITOR).....	34
8.2.1	SCHEDULER SETTING	36
9	MAINTENANCE, SPARES, REPAIR AND SERVICING.....	37
9.1	PURCHASING ADDITIONAL CONNECTOR PLUGS FROM DSE	37
9.2	PURCHASING ADDITIONAL FIXING CLIPS FROM DSE	37
9.3	PURCHASING SEALING GASKET FROM DSE	37
10	WARRANTY	38
11	DISPOSAL.....	38
11.1	WEEE (WASTE ELECTRICAL AND ELECTRONIC EQUIPMENT).....	38
11.2	ROHS (RESTRICTION OF HAZARDOUS SUBSTANCES)	38
12	APPENDIX.....	39
12.1	COMMUNICATIONS OPTION CONNECTIONS.....	39
12.1.1	DESCRIPTION.....	39
12.1.2	PC TO CONTROLLER (DIRECT) CONNECTION	39
12.2	ENCLOSURE CLASSIFICATIONS.....	40

12.2.1	IP CLASSIFICATIONS	40
12.2.2	NEMA CLASSIFICATIONS	41

1 BIBLIOGRAPHY

This document refers to and is referred to by the following DSE publications which can be obtained from the DSE website www.deepseapl.com

DSE PART	DESCRIPTION
053-135	DSE334 installation instructions
057-156	DSE334 Configuration Suite manual

2 INTRODUCTION

This document details the installation and operation requirements of the DSE334 Series modules, part of the DSEAts® range of products.

The manual forms part of the product and should be kept for the entire life of the product. If the product is passed or supplied to another party, ensure that this document is passed to them for reference purposes.

This is not a *controlled document*. You will not be automatically informed of updates. Any future updates of this document will be included on the DSE website at www.deepseapl.com

The **DSE 334 series** module has been designed to allow the operator to control the transfer of the load from one supply to another, typically the mains supply and a standby generator.

The user also has the facility to view the system operating parameters via the LCD display.

The **DSE 334** module monitors the supplies, indicating the operational status and fault conditions, automatically transferring the load to the backup supply in case of mains supply failure. The LCD display indicates the status.

The powerful microprocessor contained within the module allows for incorporation of a range of enhanced features:

- *Text & Icon based LCD display*
- **True RMS** Voltage monitoring.
- *Supply parameter monitoring.*
- *Fully configurable inputs for use as alarms or a range of different functions.*

Using a PC and the DSE Configuration Suite software allows alteration of selected operational sequences, timers and alarm trips.

Additionally, the module's integral fascia configuration editor allows adjustment of this information.

A robust plastic case designed for front panel mounting houses the module. Connections are via locking plug and sockets.

3 SPECIFICATIONS

3.1 PART NUMBERING

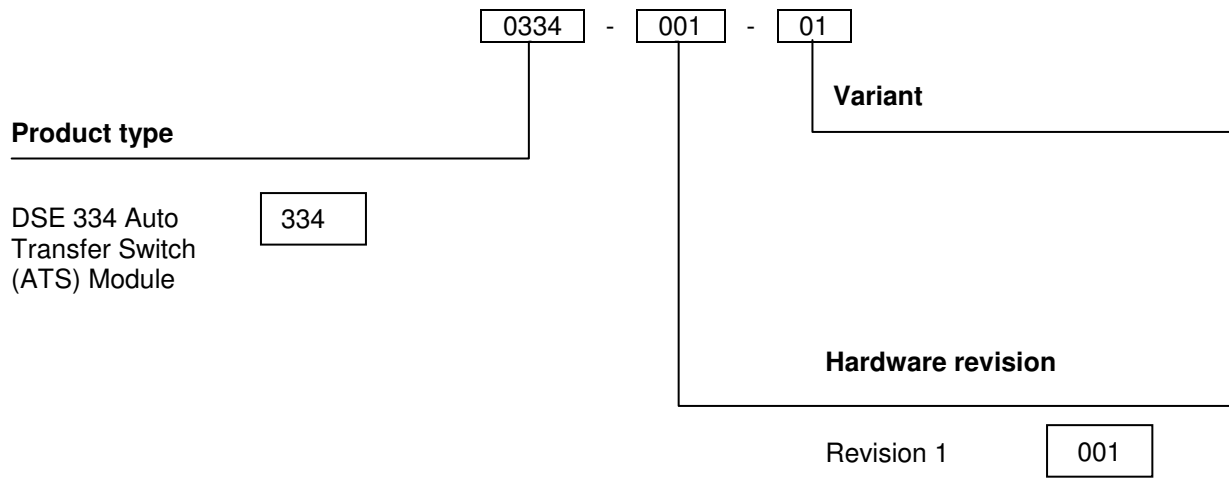

At the time of this document production, there have been no revisions to the module hardware.

3.1 POWER SUPPLY REQUIREMENTS

Minimum supply voltage	8V continuous, 5V for up to one minute.
Cranking dropouts	Able to survive 0V for 50mS providing the supply was at least 10V before the dropout and recovers to 5V afterwards.
Maximum supply voltage	35V continuous (60V protection for one minute)
Reverse polarity protection	-35V continuous
Maximum operating current Auto mode will all inputs active and all LEDs illuminated	292mA at 12V, 167mA at 24V
Maximum standby current (Stop mode with no active inputs)	101mA at 12V, 66mA at 24V

Plant supply instrumentation display

Range	0V-35V DC (note Maximum continuous operating voltage of 35V DC)
Resolution	0.1V
Accuracy	1% of full scale

3.2 TERMINAL SPECIFICATION

Connection type	Screw terminal, rising clamp, no internal spring
Min cable size	0.5mm ² (AWG 24)
Max cable size	2.5mm ² (AWG 10)

3.3 S1 /S2 VOLTAGE / FREQUENCY SENSING

Measurement type	True RMS conversion
Sample Rate	5KHz or better
Harmonics	Up to 11 th or better
Input Impedance	300K Ω ph-N
Phase to Neutral	15V (minimum required for sensing frequency) to 333V AC (absolute maximum) Suitable for 110V to 277V nominal ($\pm 20\%$ for under/overvoltage detection)
Phase to Phase	26V (minimum required for sensing frequency) to 576V AC (absolute maximum) Suitable for 190V ph-ph to 479V ph-ph nominal ($\pm 20\%$ for under/overvoltage detection)
Common mode offset from Earth	100V AC (max)
Resolution	1V AC phase to neutral 2V AC phase to phase
Accuracy	$\pm 1\%$ of full scale phase to neutral $\pm 2\%$ of full scale phase to phase
Minimum frequency	3.5Hz
Maximum frequency	75.0Hz
Frequency resolution	0.1Hz
Frequency accuracy	± 0.2 Hz

3.4 INPUTS

3.4.1 DIGITAL INPUTS

Number	9 Negative 1 Positive switching.
Arrangement	Contact between input terminal and the module's plant supply negative / positive terminal
Low level threshold	3.2V minimum
High level threshold	8.1V maximum
Maximum input voltage	+60V DC with respect to module's plant supply negative terminal
Minimum input voltage	-2V DC with respect to module's plant supply negative terminal
Contact wetting current	7mA \pm 1mA
Open circuit voltage	12V \pm 1V

3.5 OUTPUTS

3.5.1 S1 / S2 LOADING OUTPUTS A & B

Number	2 (Configurable outputs A & B)
Type	Volts free contacts. Output C Normally closed, Output D Normally open
Rating	8A 250V AC resistive

3.5.2 START/RUN OUTPUT C

Number	1 (Configurable output C)
Type	Volts free normally closed contact
Rating	8A @ 35V

3.5.3 CONFIGURABLE OUTPUTS D & E

Number	2 (Configurable outputs D & E)
Type	Fully configurable, volts free relays. D=change over, E=normally open
Rating	8A @ 250V AC resistive
Protection	Protected against over current & over temperature. Built in load dump feature.

3.6 COMMUNICATION PORTS

USB Port	USB2.0 Device for connection to PC running DSE configuration suite only
----------	---

3.7 DIMENSIONS AND MOUNTING

3.7.1 DIMENSIONS

216mm x 158mm x 42mm
(8.5" x 6.2" x 1.6")

3.7.2 PANEL CUTOUT

182mm x 137mm
(7.2" x 5.4")

3.7.3 WEIGHT

510g (0.51kg)

3.7.4 FIXING CLIPS

The module is held into the panel fascia using the supplied fixing clips.

- Withdraw the fixing clip screw (turn anticlockwise) until only the pointed end is protruding from the clip.
- Insert the three 'prongs' of the fixing clip into the slots in the side of the module case.
- Pull the fixing clip backwards (towards the back of the module) ensuring all three prongs of the clip are inside their allotted slots.
- Turn the fixing clip screws clockwise until they make contact with the panel fascia.
- Turn the screws a little more to secure the module into the panel fascia. Care should be taken not to over tighten the fixing clip screws.

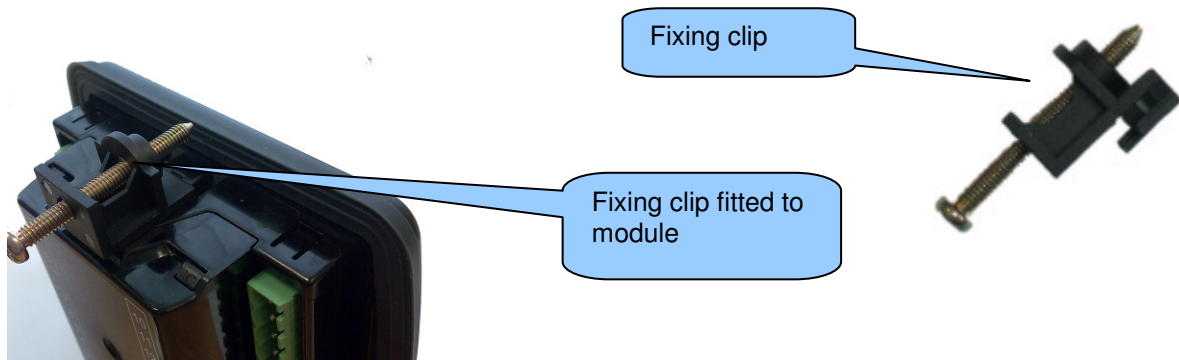

NOTE:- In conditions of excessive vibration, mount the panel on suitable anti-vibration mountings.

3.7.5 OPTIONAL SILICON SEALING GASKET

The optional silicon gasket provides improved sealing between the module and the panel fascia. The gasket is fitted to the module before installation into the panel fascia. Take care to ensure the gasket is correctly fitted to the module to maintain the integrity of the seal.

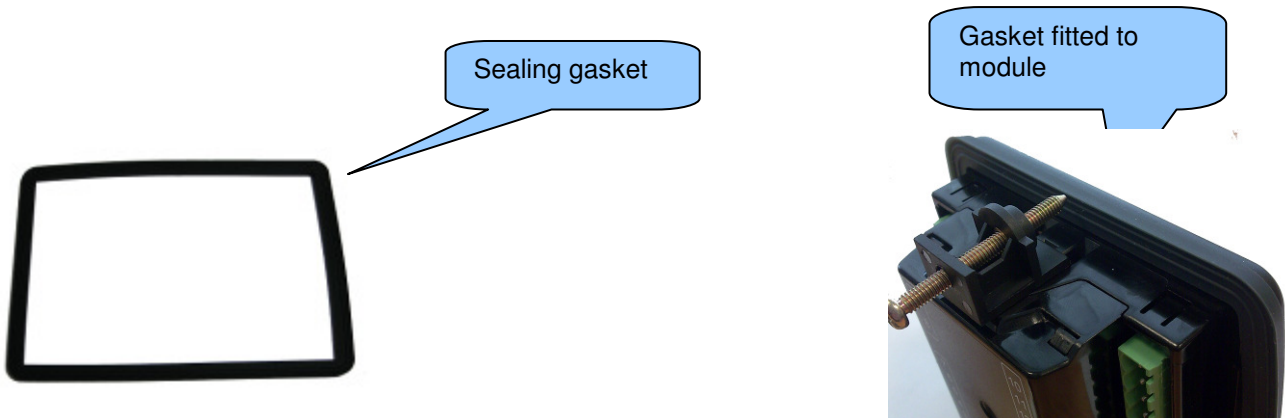

3.8 APPLICABLE STANDARDS



BS 4884-1	This document conforms to BS4884-1 1992 Specification for presentation of essential information.
BS 4884-2	This document conforms to BS4884-2 1993 Guide to content
BS 4884-3	This document conforms to BS4884-3 1993 Guide to presentation
BS EN 60068-2-1 (Minimum temperature)	-30°C (-22°F)
BS EN 60068-2-2 (Maximum temperature)	+70°C (158°F)
BS EN 60950	Safety of information technology equipment, including electrical business equipment
BS EN 61000-6-2	EMC Generic Immunity Standard (Industrial)
BS EN 61000-6-4	EMC Generic Emission Standard (Industrial)
BS EN 60529 (Degrees of protection provided by enclosures)	IP65 (front of module when installed into the control panel with the optional sealing gasket) IP42 (front of module when installed into the control panel WITHOUT being sealed to the panel)
UL508 NEMA rating (Approximate)	12 (Front of module when installed into the control panel with the optional sealing gasket). 2 (Front of module when installed into the control panel WITHOUT being sealed to the panel)
IEEE C37.2 (Standard Electrical Power System Device Function Numbers and Contact Designations)	<p>Under the scope of IEEE 37.2, <i>function numbers can also be used to represent functions in microprocessor devices and software programs.</i></p> <p>The 334 series controller is device number 11L-334 (Multifunction device protecting Line (generator) – 334 series module).</p> <p>As the module is configurable by the generator OEM, the functions covered by the module will vary. Under the module's factory configuration, the device numbers included within the module are :</p> <ul style="list-style-type: none"> 2 – Time delay starting or closing relay 30 – annunciator relay 42 – Running circuit breaker 62 – time delay stopping or opening relay 74– alarm relay 81 – frequency relay 86 – lockout relay

In line with our policy of continual development, Deep Sea Electronics, reserve the right to change specification without notice.



4 INSTALLATION

4.1 TERMINAL DESCRIPTION



4.1.1 DC SUPPLY AND OUTPUT C

	PIN No	DESCRIPTION	CABLE SIZE	NOTES
	1	DC Plant Supply Input (Negative)	2.5mm ² AWG 13	
	2	DC Plant Supply Input (Positive)	2.5 mm ² AWG 13	(Recommended Maximum Fuse 15A anti-surge) Supplies the module (2A anti-surge requirement) and all output relays
	3	Output C	1.0mm ² AWG 18	Volts free relay normally configured to START/RUN generator (2A rated)
	4	Output C	1.0mm ² AWG 18	



4.1.2 OUTPUTS D & E AND FUNCTIONAL EARTH

	PIN No	DESCRIPTION	CABLE SIZE	NOTES
	5	Output D Normally Open	1.0mm ² AWG 18	Volts free relay change-over relay user configured (2A rated)
	6	Output D Common	1.0mm ² AWG 18	
	7	Output D Normally Closed	1.0mm ² AWG 18	
	8	Output E	1.0mm ² AWG 18	Volts free relay user configured (2A rated)
	9	Output E	1.0mm ² AWG 18	
	10	System Earth	1.0mm ² AWG 18	

4.1.3 DIGITAL INPUTS

	PIN No	DESCRIPTION	CABLE SIZE	NOTES
	11	Input A	1.0mm ² AWG 18	Configurable input. Connects to plant supply negative
	12	Input B	1.0mm ² AWG 18	Configurable input. Connects to plant supply negative
	13	Input C	1.0mm ² AWG 18	Configurable input. Connects to plant supply negative
	14	Input D	1.0mm ² AWG 18	Configurable input. Connects to plant supply negative
	15	Input E	1.0mm ² AWG 18	Configurable input. Connects to plant supply negative
	16	Input F	1.0mm ² AWG 18	Configurable input. Connects to plant supply negative
	17	Input G	1.0mm ² AWG 18	Configurable input. Connects to plant supply negative
	18	Input H	1.0mm ² AWG 18	Configurable input. Connects to plant supply negative
	19	Input I	1.0mm ² AWG 18	Configurable input. Connects to plant supply negative
	20	Input J	1.0mm ² AWG 18	Configurable input. Connects to plant supply negative
	21	Input K	1.0mm ² AWG 18	Generator ready input. Connects to plant supply Positive

4.1.4 LOAD SWITCHING AND S2 SENSING

	PIN No	DESCRIPTION	CABLE SIZE	NOTES
	22	Output A	1.0mm ² AWG 18	Normally configured to control mains contactor coil (Recommend 10A fuse)
	23	Output A	1.0mm ² AWG 18	Normally configured to control mains contactor coil
	24	Output B	1.0mm ² AWG 18	Normally configured to control generator contactor coil (Recommend 10A fuse)
	25	Output B	1.0mm ² AWG 18	Normally configured to control generator contactor coil
	26	S2 L1 (U) voltage monitoring	1.0mm ² AWG 18	Connect to S2 L1 (U) output (AC) (Recommend 2A fuse)
	27	S2 L2 (V) voltage monitoring	1.0mm ² AWG 18	Connect to S2 L2 (V) output (AC) (Recommend 2A fuse)
	28	S2 31 (W) voltage monitoring	1.0mm ² AWG 18	Connect to S2 L3 (W) output (AC) (Recommend 2A fuse)
	29	S2 Neutral (N) input	1.0mm ² AWG 18	Connect to S2 Neutral terminal (AC)

4.1.5 S1 SENSING

	PIN No	DESCRIPTION	CABLE SIZE	NOTES
	30	S1 L1 (R) voltage monitoring	1.0mm ² AWG 18	Connect to S1 L1 (R) output (AC) (Recommend 2A fuse)
	31	S1 L2 (S) voltage monitoring	1.0mm ² AWG 18	Connect to S1 L2 (S) output (AC) (Recommend 2A fuse)
	32	S1 31 (T) voltage monitoring	1.0mm ² AWG 18	Connect to S1 L3 (T) output (AC) (Recommend 2A fuse)
	33	S1 Neutral (N) input	1.0mm ² AWG 18	Connect to S1 Neutral terminal (AC)

4.1.6 CURRENT TRANSFORMERS

Current transformers are fitted in the feed from the transfer switch to the load. They are used to give S1 instrumentation when S1 is on load, and S2 instrumentation when S2 is on load.

WARNING!:- Do not disconnect this plug when the CTs are carrying current. Disconnection will open circuit the secondary of the C.T.'s and dangerous voltages may then develop. Always ensure the CTs are not carrying current and the CTs are short circuit connected before making or breaking connections to the module.

NOTE:- The DSE334 series module has a burden of 0.5VA on the CT. Ensure the CT is rated for the burden of the DSE334 series controller, the cable length being used and any other equipment sharing the CT. If in doubt, consult your CT supplier.

NOTE:- When not required, the CT function can be disabled using the DSE Configuration Suite PCSoftware.

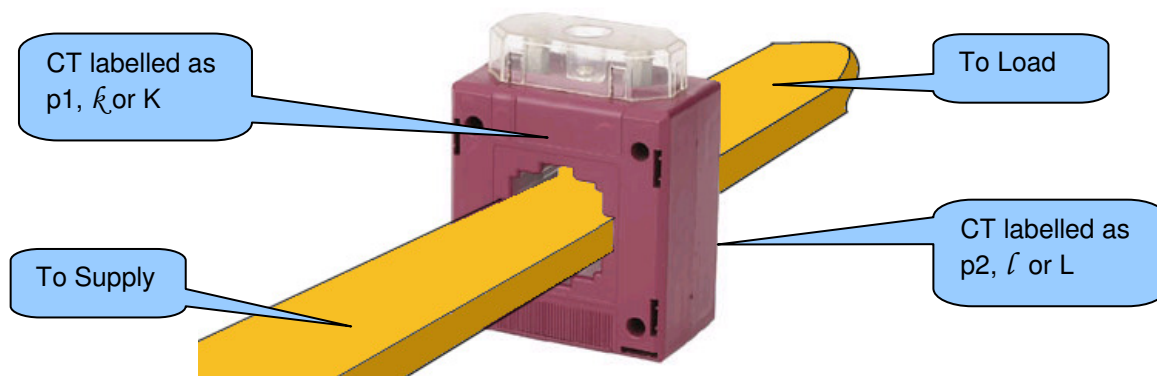

PIN No	DESCRIPTION	CABLE SIZE	NOTES
34	I1 Current Transformer	1.0mm ² AWG 18	Connect to CT 1 (s1 / K)
35	I2 Current Transformer	1.0mm ² AWG 18	Connect to CT 2 (s1 / K)
36	I3 Current Transformer	1.0mm ² AWG 18	Connect to CT 3 (s1 / K)
37	Current Transformer common connection	1.0mm ² AWG 18	Connect to CT common (s2 / L) 37 & 38 are internally connected to each other.
38			

NOTE:- Take care to ensure correct polarity of the CT primary as shown below. If in doubt, check with the CT supplier.



This configuration cable is the same as normally used between a PC and a USB printer.

4.1.7 PC CONFIGURATION INTERFACE CONNECTOR

	DESCRIPTION	CABLE SIZE	NOTES
	Socket for connection to PC with DSE Configuration Suite PC software.	0.5mm ² AWG 20	This is a standard USB type A to type B cable. 

NOTE:- The USB connection cable between the PC and the DSE334 module must not be extended beyond 5m (5yds). For distances over 5m, it is possible to use a third party USB extender. Typically, they extend USB up to 50m (yds). The supply and support of this type of equipment is outside the scope of Deep Sea Electronics PLC.

CAUTION!: Care must be taken not to overload the PCs USB system by connecting more than the recommended number of USB devices to the PC. For further information, consult your PC supplier.

CAUTION!: This socket must not be used for any other purpose.

4.2 TYPICAL WIRING DIAGRAM

As every system has different requirements, these diagrams show only a TYPICAL system and do not intend to show a complete system.

Genset manufacturers and panel builders may use these diagrams as a starting point, however you are referred to the completed system diagram provided by your system manufacturer for complete wiring detail.

Further wiring suggestions are available in the following DSE publication, available at www.deepseapl.com.

DSE PART	DESCRIPTION
056-022	Breaker Control (Training guide)

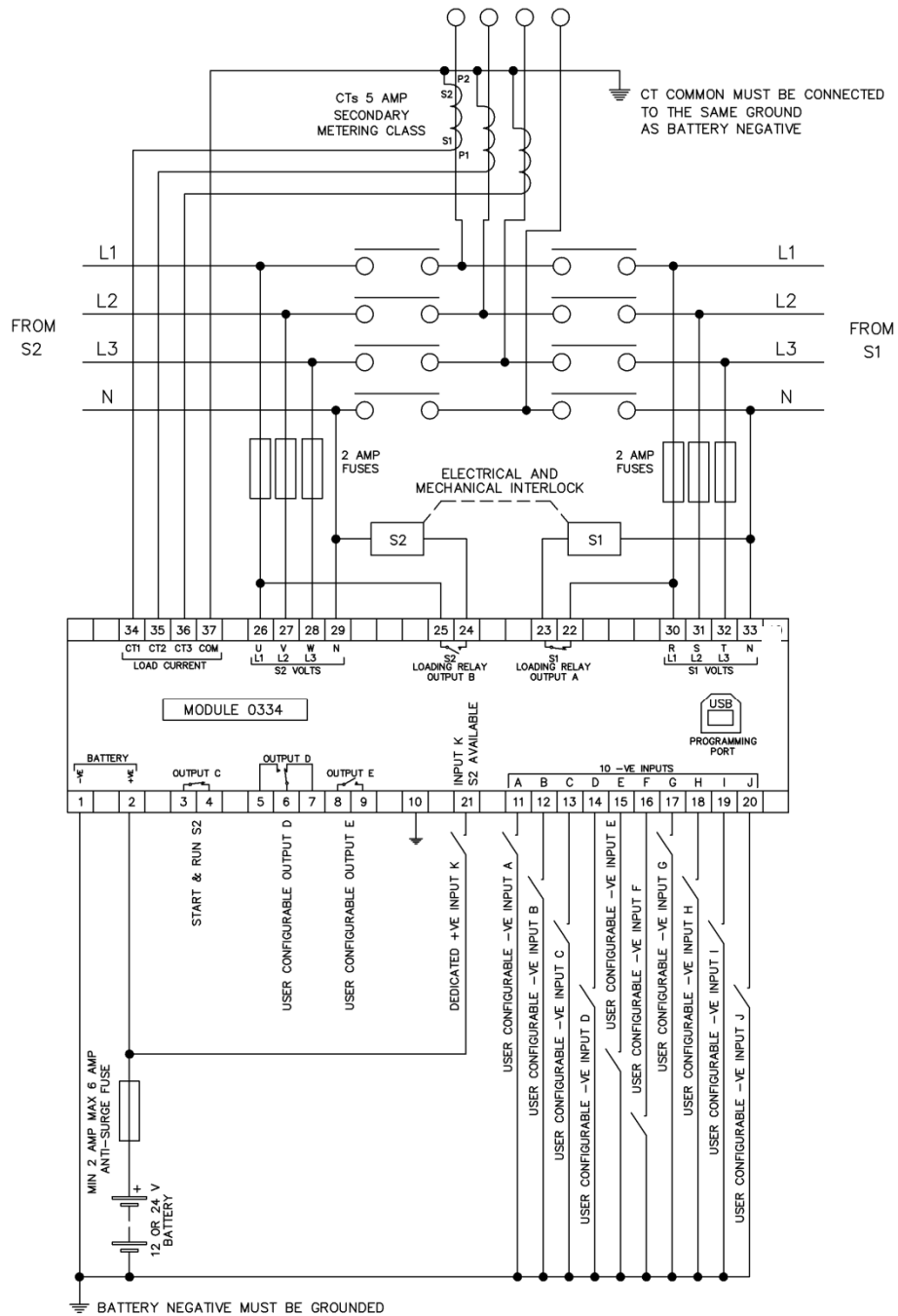

TERMINALS SUITABLE FOR 22-16 AWG
(0.6mm - 1.3mm) FIELD WIRING
TIGHTENING TORQUE = 0.8Nm (7lb-in)

5 DESCRIPTION OF CONTROLS

The following section details the function and meaning of the various controls on the module.

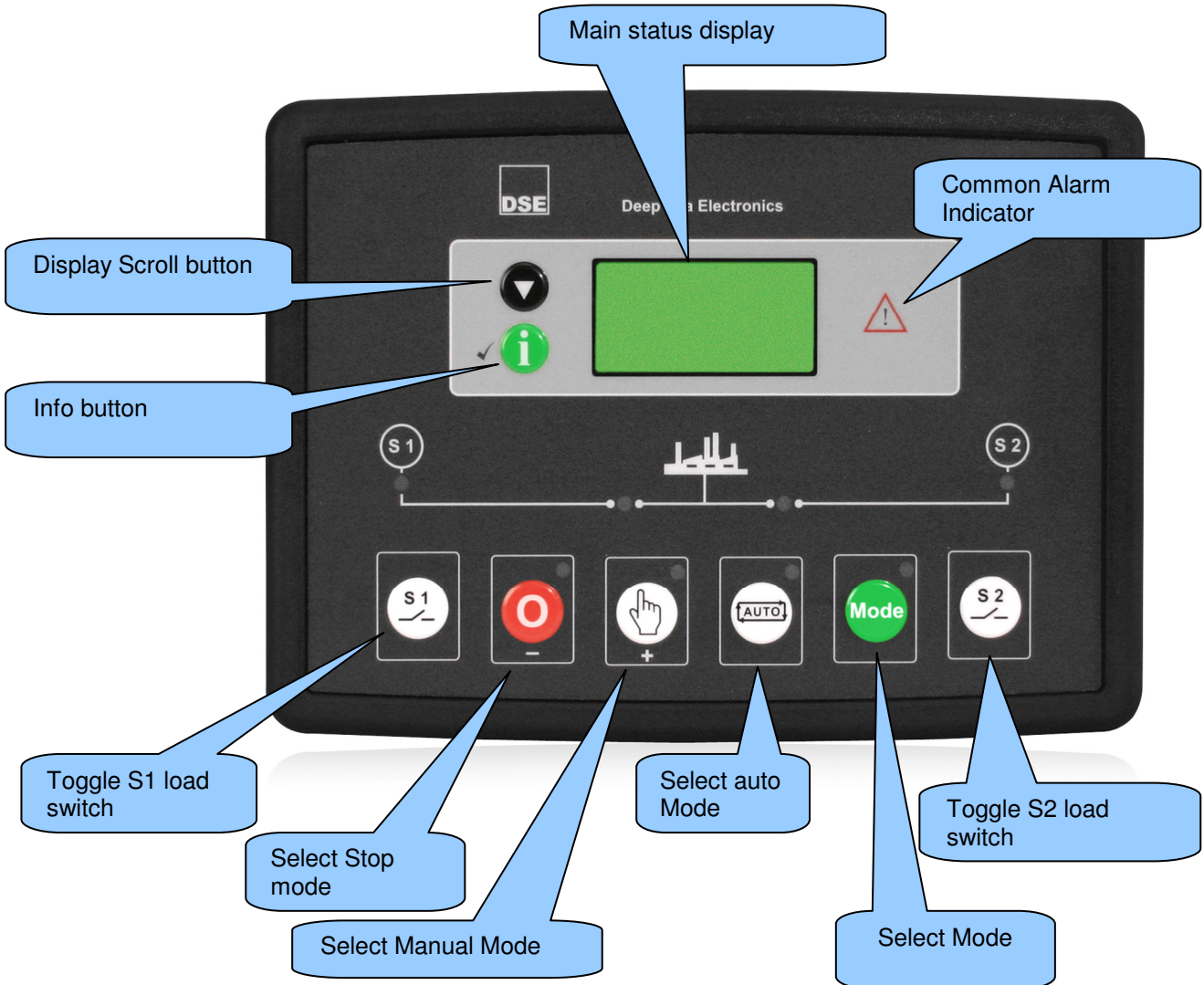

Description of Controls

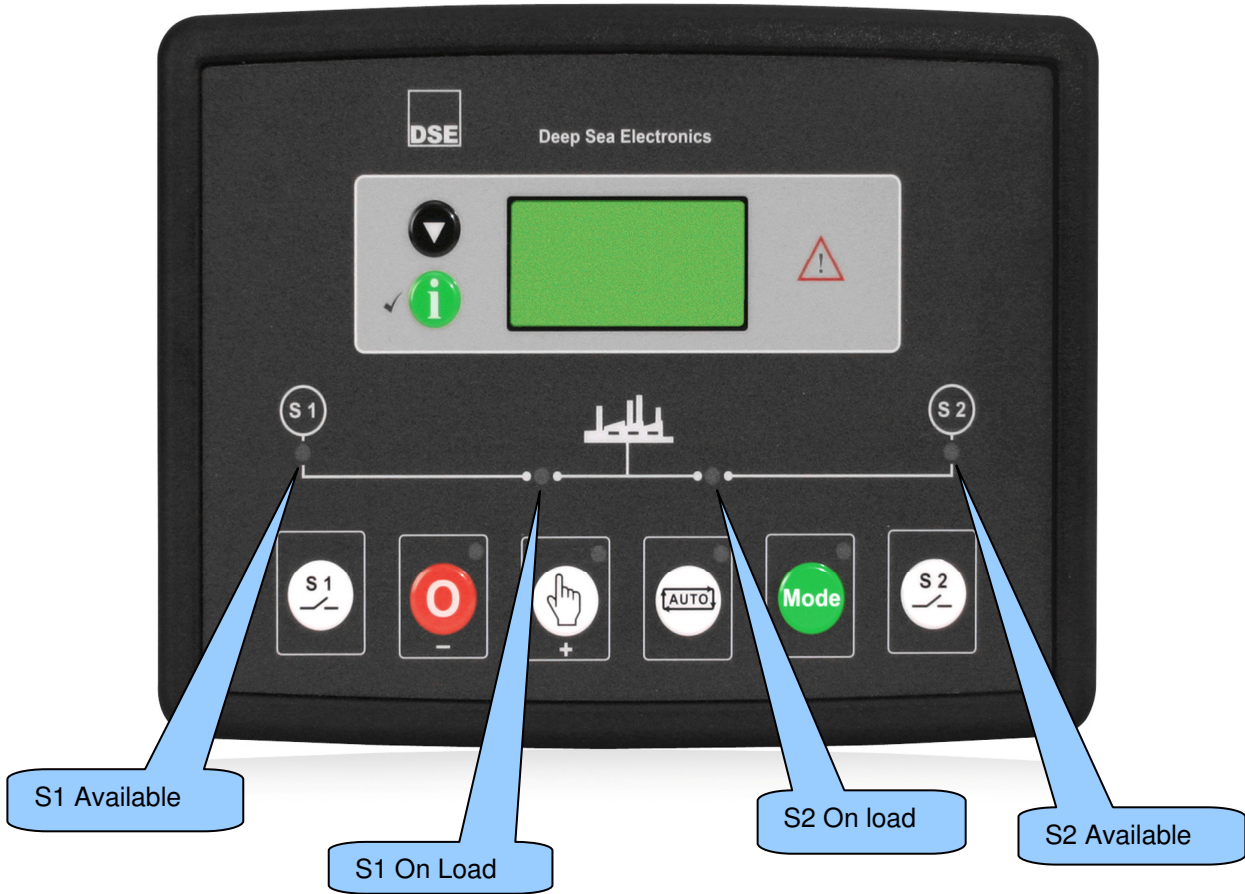

5.1 QUICKSTART GUIDE

This section provides a quick start guide to the module's operation.

5.1.1 STANDBY OPERATION



▲ NOTE:- For further details, see the section entitled 'OPERATION' elsewhere in this manual.

▲ NOTE:- If module power is removed, it will 'remember' the last operating mode and return to that mode next time power is applied.

5.2 GRAPHICAL DISPLAY

- 4- line, 64 x 132 small Graphic Display with LED Backlight
- Icon and numeric display. Switch to select 'Icon' or 'English' display
- Software controlled contrast
- Mimic of Text insert / 4x indicators via LCD

5.2.1 DISPLAY PAGES

It is possible to scroll to display the different pages of information by repeatedly operating the scroll button 

Once selected the page will remain on the LCD display until the user selects a different page or after an extended period of inactivity, the module will revert to the status display.

When scrolling manually, the display will automatically return to the Status page if no buttons are pressed for the duration of the configurable *LCD Page Timer*.

If an alarm becomes active while viewing the status page, the display shows the Alarms page to draw the operator's attention to the alarm condition.

At power up, the display will show the software version, and then display the default display screen, which will display Mains instrumentation.

5.2.1.1 STATUS

Displays current operational status information

Example :

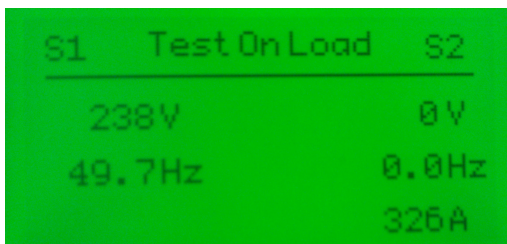

5.2.1.2 INSTRUMENTATION

The instrumentation page contains the following information

- S2 Voltage L1-N
- S2 Voltage L-L
- S2 Frequency
- S1 Voltage L1-N
- S1 Voltage L-L
- S1 Frequency
- Load current (A)
- Battery Voltage

Example::

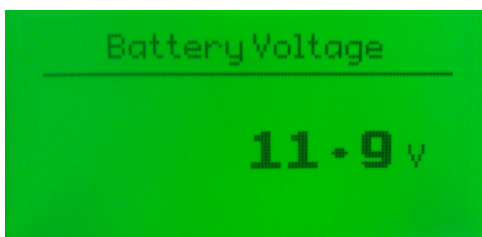

5.2.1.3 ALARMS

Lists any current alarms

Example: (English)

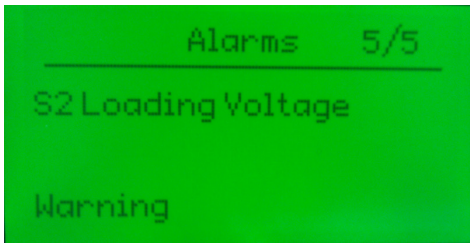

(Icon)

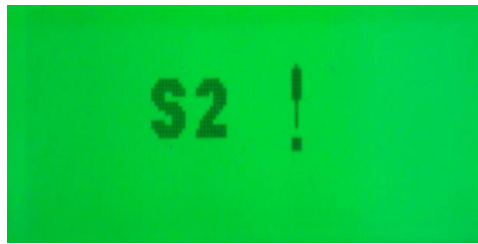

5.2.1.4 EVENT LOG

Displays the entire event log

Example:

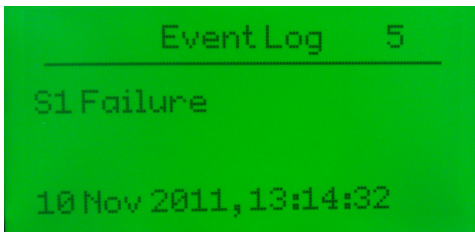

5.2.1.5 LCD INDICATORS

Shows the status of the configurable LCD indicators

Example:

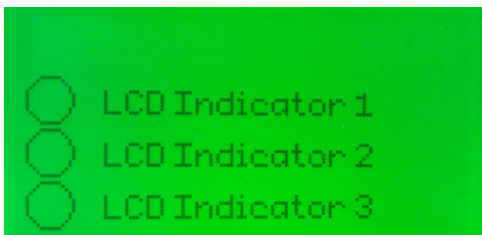

5.2.1.6 SCHEDULE

Shows the settings of the exercise scheduler

Example:

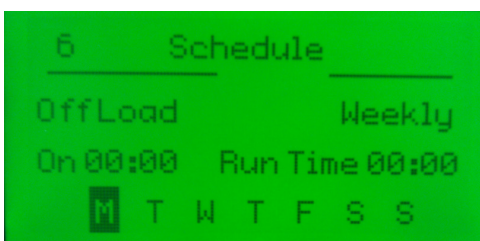

5.2.1.7 ABOUT

Displays the module firmware versions.

Example:

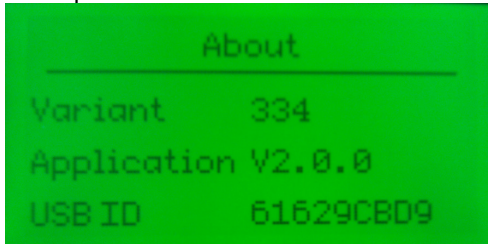









5.2.1.8 ALARM ICONS

In instances where more than one alarm is present the icon area will transition between icons to display all active alarm conditions. For information alarm conditions see section



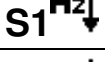
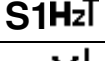
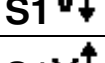
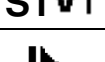

Alarm	Icon	Reason
Battery Low Voltage		The DC supply has fallen below the low volts setting level for the duration of the low battery volts timer
Battery High Voltage		The DC supply has risen above the high volts setting level for the duration of the high battery volts timer
Failed to start		The engine has not fired after the preset number of start attempts.
Failed to stop		The module has detected a condition that indicates that the engine is running when it has been instructed to stop.
Over Voltage	S1V↑	S1 or S2 voltage has risen above the pre-set pre-alarm setting.
Under voltage	S1V↓	S1 or S2 voltage has fallen below the pre-set pre-alarm setting.
Over frequency	S1Hz↓	S1 or S2 frequency has risen above the pre-set pre-alarm setting.
Under frequency	S1Hz↓	S1 or S2 frequency has fallen below the pre-set pre-alarm setting.
S2 Failure	S2!	S2 supply has failed
S1 Failure	S1!	S1 supply has failed
Fail to reach loading voltage		Loading Voltage has failed to reach setting
Fail to reach loading frequency		Loading frequency has failed to reach setting
S2 as Generator Under Frequency	S2	S2 (generator) output frequency has fallen below the preset level
S2 as Generator Loading Frequency	S2	S2 loading frequency has failed to reach setting
S2 as Generator Over Frequency	S2	S2 output frequency has risen above the preset level
S2 as Generator Under Voltage	S2	S2 output voltage has fallen below the preset level

Description of Controls



S2 as Generator Loading Voltage	S2 	S2 loading voltage has not achieved the level to load
S2 as Generator Over Voltage	S2 	S2 output voltage has risen above the preset level
S2 as Mains Under Frequency	S2 	S1 output frequency has fallen below the preset level
S2 as Mains Over Frequency	S2 	S2 output frequency has risen above the preset level
S2 as Mains Under Voltage	S2 	S1 output voltage has fallen below the preset level
S2 as Mains Over Voltage	S2 	S1 output voltage has risen above the preset level
S1 Under Frequency	S1 	S1 output frequency has fallen below the preset level
S1 Over Frequency	S1 	S1 output frequency has risen above the preset level
S1 Under Voltage	S1 	S1 output voltage has fallen below the preset level
S1 Over Voltage	S1 	S1 output voltage has risen above the preset level
Digital Input A-K		Auxiliary Digital inputs can be user configured as Digital inputs and will display the relevant icon.

5.3 CONTROLS

5.3.1 MODE SELECTION



<p>This button places the module into its 'Automatic' mode. This mode allows the module to control the function of the load switching completely automatically. The module monitors the <i>remote start</i> input and S1 supply status and once a start request is made, S2 is placed on load. Upon removal of the starting signal (or the S1 supply returns), the module will automatically transfers the load from S2 to the S1.</p> <p><i>For further details, please see the more detailed description of 'Auto operation' elsewhere in this manual.</i></p>	
<p>Stop This button places the module into its Stop mode preventing the module from transferring over to S2 on a S1 fail or prevent a start request if using a generator.</p>	
<p>Once in Test on load mode the module sends a start request to the generator and places the set on load. The set remains on load when in this mode.</p>	
<p>This mode allows manual control of the ATS functions. Once in Manual mode the module sends a start request to the generator if selected.</p> <p>Breakers are opened and close using the transfer buttons detailed below.</p>	

5.3.2 DISPLAY

<p>This button changes between the various pages About, Status, Instrumentation, Alarms, Event Log, LCD Indicators</p>	
<p>This buttons scrolls through the items in the currently displayed page.</p>	

5.3.3 LOAD SWITCHING CONTROL

Two fascia mounted buttons are provided for load switching operation when in manual mode. These buttons are enabled/disabled in the modules PC configuration Suite so refer to your configuration file to ensure the configuration has enabled the buttons.

<p>Pressing this button when S1 is on load opens the S1 load switch. Pressing this button when S2 is on load and the S1 is healthy, opens S2 load switch, waits for the duration of the <i>transfer delay</i>, then closes S1 load switch.</p>	
<p>Pressing this button when S2 is on load opens S2 load switch. Pressing this button when S1 is on load and S2 is available, will open S1 load switch, waits for the duration of the <i>transfer delay</i>, then closes S2 load switch.</p>	

6 OPERATION

6.1 AUTOMATIC MODE OF OPERATION

 **NOTE:-** If a digital input configured to *panel lock* is active, changing module modes is not possible. Viewing the instruments and event logs is **NOT** affected by panel lock.

Activate auto mode by pressing the **Auto** pushbutton.

Auto mode will allow the transfer system to operate fully automatically, starting and stopping the generator as required with no user intervention.

6.1.1 WAITING IN AUTO MODE

If a starting request is made and there is no input present for *Auto Start Inhibit*, the starting sequence will begin. Starting requests can be from the following sources :

- S1 failure
- Activation of an auxiliary input that has been configured to *remote start*
- Activation of the inbuilt exercise scheduler.

6.1.2 STARTING SEQUENCE

To allow for 'false' start requests, the *start delay* timer begins.

Should all start requests be removed during the *start delay* timer, the unit will return to a stand-by state.

If a start request is still present at the end of the *start delay* timer, start signal is given to the generator set by the start/run output.

If the generator fails to become available before the *generator failure* timer expires. This is indicated on the LCD display, but the starting signal remains active.

6.1.3 S2 ON LOAD

Once S2 is measured as being within limits (and the *Auxiliary Generator Ready* signal is received, the mains is removed from the load, and after the *transfer timer* has expired, the generator is placed on load.

If all start requests are removed and there is no input present for *Auto Restore Inhibit*, the *stopping sequence* begins.

6.1.4 STOPPING SEQUENCE

The *return delay* timer operates to ensure that the starting request has been permanently removed and isn't just a short term removal.

After the return delay timer, the generator load switch is opened, then after the transfer timers, the mains is placed back on load.

Should another start request be made during the cooling down period, the generator is placed on load.

The *cooling* timer allows the set to run off load and cool sufficiently before being stopped. This is particularly important where turbo chargers are fitted to the engine.

After the *cooling* timer has expired, the set is stopped.

 **NOTE:-** If module power is removed, it 'remembers' the operating mode and returns to that mode next time power is applied.

6.2 MANUAL OPERATION

NOTE:- If a digital input configured to *panel lock* is active, changing module modes is not possible. Viewing the instruments and event logs is **NOT** affected by panel lock.

Manual mode allows the operator to start and stop the set manually, and if required change the state of the load switching devices. Manual off load mode is active when the **Manual** button is pressed.

6.2.1 STARTING SEQUENCE

NOTE:- There is no *start delay* in this mode of operation.

The start request is sent to the generator via the start/run relay output.

If the generator fails to become available before the *generator failure* timer expires. This is indicated on the LCD display, but the starting signal remains active.

6.2.2 S2 OFF LOAD

The generator continues to run OFF LOAD in this mode unless :

- S1 supply fails
- An input is given for *Auxiliary Mains Failure*
- An input is given for *Transfer to S2*
- The fascia mounted transfer buttons are pressed (when configured)



6.2.3 S2 ON LOAD

Once on load, the generator remains on load unless:

- An input is given for *Transfer to S1*
- The fascia mounted transfer buttons are pressed (when configured)
- The module mode is changed to STOP/RESET or AUTO mode. The system may then transfer back to mains supply automatically if conditions are suitable.

6.2.4 TRANSFER BUTTONS OPERATION

Two fascia mounted buttons are provided for load switching operation when in manual mode. These buttons are enabled/disabled in the modules PC configuration Suite so refer to your configuration file to ensure the configuration has enabled the buttons.

Pressing this button when the mains is on load opens the mains load switch.	
Pressing this button when the generator is on load and the mains is healthy, opens the generator load switch, wait for the duration of the <i>transfer delay</i> , then close the mains load switch.	
Pressing this button when the generator is on load opens the generator load switch.	
Pressing this button when the mains is on load and the generator is available, opens the mains load switch, wait for the duration of the <i>transfer delay</i> , then closes the generator load switch.	

6.2.5 STOPPING SEQUENCE

The set is not be stopped in this mode of operation.

To begin the stopping sequence, the module should be placed in the AUTO or PROHIBIT RETURN mode.

NOTE:- If module power is removed, it 'remembers' the operating mode and returns to that mode next time power is applied.

6.3 TEST ON LOAD OPERATION

 **NOTE:-** If a digital input configured to *panel lock* is active, changing module modes is not possible. Viewing the instruments and event logs is **NOT** affected by panel lock.

Manual mode allows the operator to start and stop the set manually, and if required change the state of the load switching devices. Manual off load mode is active when the **Test on Load** button is pressed.

6.3.1 STARTING SEQUENCE

 **NOTE:-** There is no *start delay* in this mode of operation.

The start request is sent to S2 via the start/run relay output.

If S2 fails to become available before the S2 failure timer expires. This is indicated on the LCD display, but the starting signal remains active.

6.3.2 S2 ON LOAD

The generator continues to run ON LOAD in this mode unless :

- S2 supply fails – S1 supply is placed back on load if available.
- An input is given for *Transfer to S1*

6.3.3 STOPPING SEQUENCE

The set is not be stopped in this mode of operation.

To begin the stopping sequence, the module should be placed in the AUTO or PROHIBIT RETURN mode.

 **NOTE:-** If module power is removed, it 'remembers' the operating mode and return to that mode next time power is applied.

6.4 LOAD SWITCHING CONTROL

The following timing diagrams detail the differences between the load switching control options.

6.4.1 BREAKER SCHEME A

NOTE : S2 Closed Auxiliary and S1 Closed Auxiliary inputs do not affect the operation of the load switching in Breaker Scheme A

6.4.2 S1 / S2 LOAD INHIBIT

Activation of an input configured to *S1 load inhibit* or *S2 load inhibit* inputs cause the corresponding breaker to be opened immediately. No other change in function will occur.

When the input is deactivated the breaker is closed again if appropriate.

6.4.3 LOAD SHEDDING

If an input configured to Load Shed is activated, outputs set to Open S1 and Open S2 will energise, and inputs configured to Close S1 and Close S2 will de-energise. Open Mains Pulse and Open Gen Pulse outputs will only energise if the corresponding supply was on load before application of the Load Shed input.

When the Load Shed input is deactivated, the load is transferred back to the supply that was disconnected before application of the input.

6.4.4 TIMING DIAGRAM

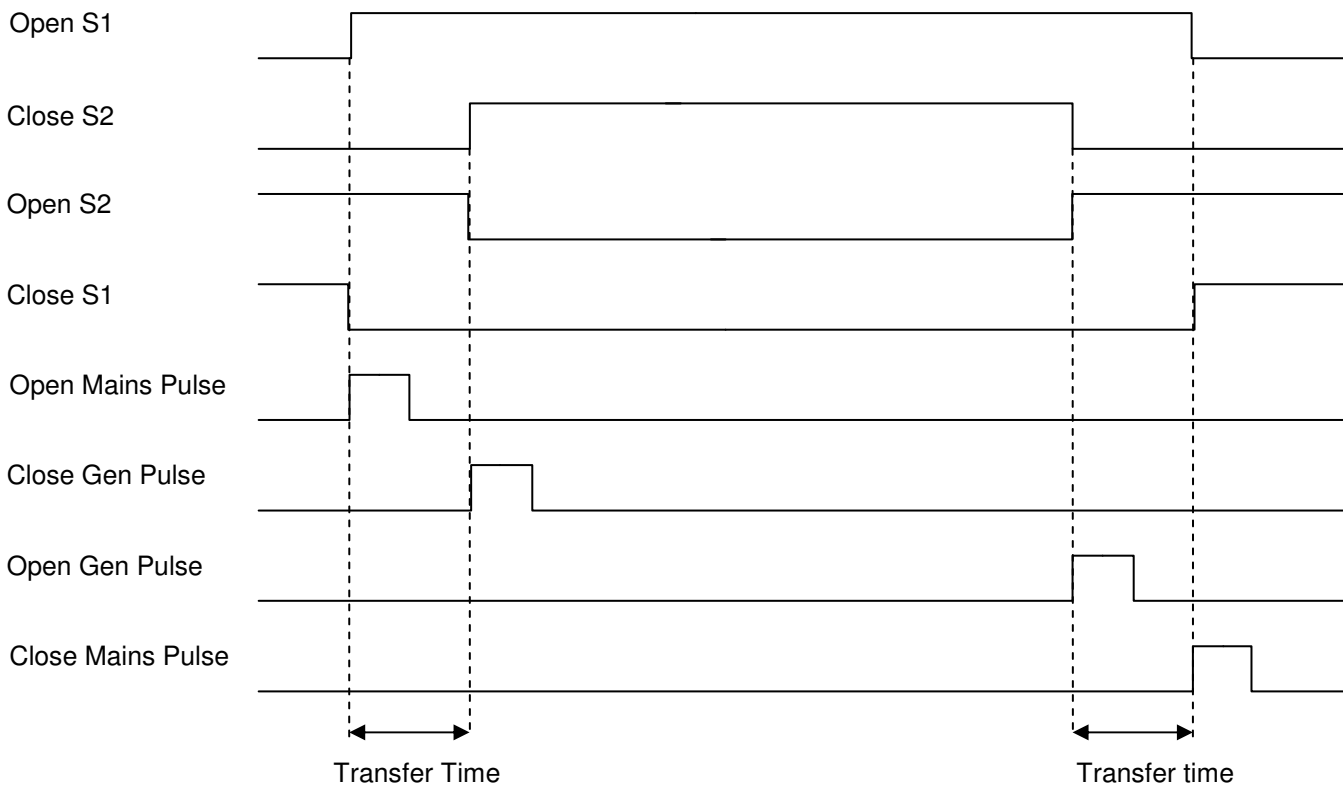

6.4.5 BREAKER SCHEME B

Breaker Scheme B is intended only for use with certain designs of transfer switch. If you are using contactors, you MUST select Breaker Scheme A.

6.4.5.1 CHECK SYNCHRONISING IS DISABLED

6.4.5.1.1 TRANSFERRING TO S2

To open S1 breaker the *Open S1* output energises, it then de-energises when the *S1 Closed Auxiliary* indicates it has successfully opened, or after 1s whichever occurs first.

When 'S1 Closed Auxiliary' indicates the S1 breaker has opened, the *transfer timer* begins.

When the *transfer timer* expires, the module attempts to close S2 breaker by energising the *Open S1* and *Close S2* outputs simultaneously, it then de-energises these outputs when the *S2 Closed Auxiliary* input indicates it has successfully closed, or after 1s whichever occurs first.

6.4.5.1.2 TRANSFERRING TO S1

To open S2 breaker the *Open S2* output energises, it then de-energises when the *S2 Closed Auxiliary* indicates it has successfully opened, or after 1s whichever occurs first.

When the 'S2 Closed Auxiliary' indicates the generator breaker has opened, the *transfer timer* begins.

When the *transfer timer* expires, the module attempts to close S1 breaker by energising the *Open S2* and *Close S1* outputs simultaneously, it then de-energises these outputs when the *S1 Closed Auxiliary* input indicates it has successfully closed, or after 1s whichever occurs first

6.4.5.1.3 LOAD SHED INPUT

When the *Load Shed* input is activated while the generator is closed the *Open S2* output energises, it then de-energises when the *S2 Closed Auxiliary* input indicates that it has successfully opened, or after 1s whichever occurs first.

When the *Load Shed* input is activated while the mains is closed the *Open S1* output energises, it then de-energises when the *S1 Closed Auxiliary* input indicates that it has successfully opened, or after 1s whichever occurs first.

When the *Load shed* input is de-energised the load is returned to the supply that was disconnected, providing that supply is healthy.

6.4.5.1.4 TIMING DIAGRAM

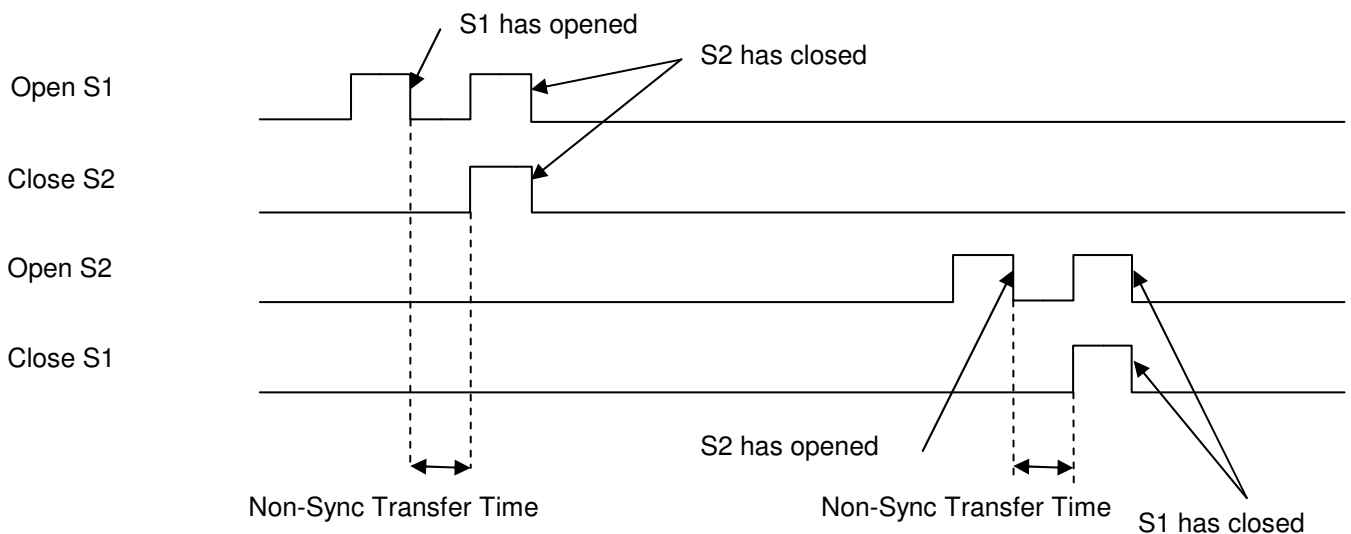

6.4.5.2 CHECK SYNCHRONISING IS ENABLED

NOTE : The module waits indefinitely for synchronisation unless the 'Return to programmed transition' function is active in which case after 2 minutes it performs a non-sync transfer as described in the previous section.

NOTE : The transfer time is ignored during a check-sync but is used if the transfer fails and it performs a non-sync transfer.

6.4.5.2.1 TRANSFER TO S2

When the module is about to transfer from S1 to S2 it activates the check sync function. When the S1 and S2 are within the phase and frequency window the module energises the *Open S1* and *Close S2* outputs simultaneously. These outputs are de-energised when the *S2 Closed Auxiliary* input indicates it has successfully closed, or after 1s whichever occurs first.

6.4.5.2.2 TRANSFER TO S1

When the module is about to transfer from S2 to mains it activates the check sync function. When S1 and S2 are within the phase and frequency window the module energises the *Open S2* and *Close S1* outputs simultaneously. These outputs are de-energised when the *S2 Closed Auxiliary* input indicates it has successfully closed, or after 1s whichever occurs first.

6.4.5.2.3 LOAD SHED INPUT

When the *Load Shed* input is activated while the generator is closed the *Open S2* output energises, it then de-energises when the *S2 Closed Auxiliary* input indicates that it has successfully opened, or after 1s whichever occurs first.

When the *Load Shed* input is activated while the mains is closed the *Open S1* output energises, it then de-energises when the *S1 Closed Auxiliary* input indicates that it has successfully opened, or after 1s whichever occurs first.

When the *Load shed* input is de-energised the load is returned to the supply that was disconnected, providing that supply is healthy.

6.4.5.2.4 TIMING DIAGRAM

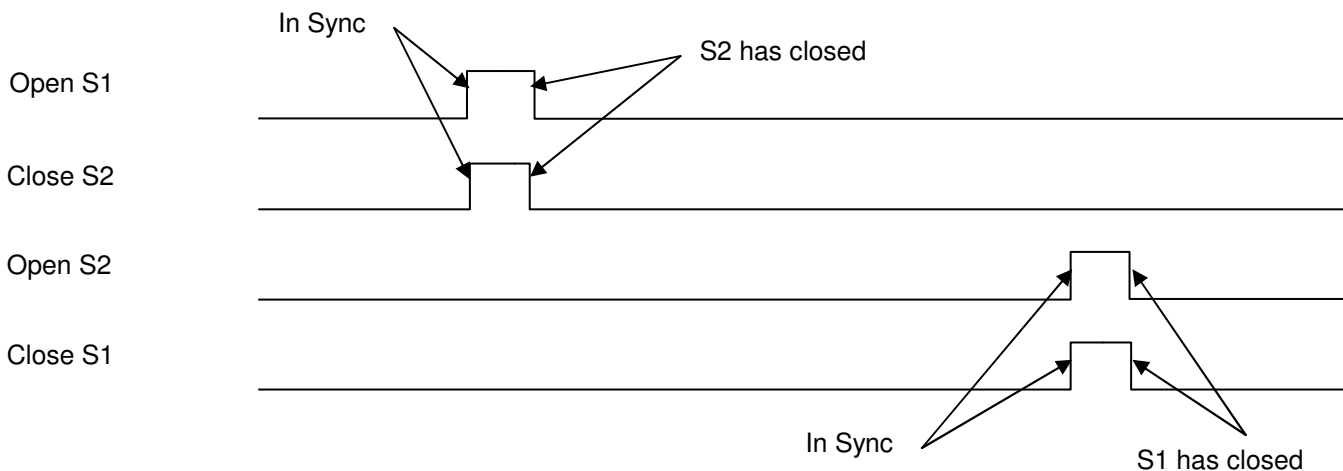

7 MODULE DISPLAY

7.1 BACKLIGHT

The backlight will be on if the unit has sufficient voltage on the power connection while the unit is turned on.

7.2 PROTECTIONS

7.2.1 S2

The 334 ATS module monitors S2 supply to ensure that it remains within configured levels. If S2 supply fails, it is taken off load and the start/run signal is removed.

S2 failure

S2 has not become available after the period of the *S2 Failure* timer has expired.

S2 Under Voltage shutdown

The S2 supply is below the configured *under voltage* trip level

S2 Under Frequency shutdown

S2 supply is below the configured *under frequency* trip level

Failed to reach loading voltage

S2 is running and within under / over voltage trip points, but has failed to reach the configured *Loading Voltage*, hence it is unfit to take load.

Failed to reach loading frequency

S2 is running and within under / over frequency trip points, but has failed to reach the configured *Loading Frequency*, hence it is unfit to take load.

7.2.2 S1

S1 alarms signal that the S1 supply is out of limits. In AUTO mode, S2 is called to start (if not already running) and will be placed on load when available.

If S1 supply fails while S2 is running in MANUAL mode, the 334 ATS module transfers load to the S2 supply. Should an input configured to *Simulate S1 Available* be active, the mains failure detection is inhibited.

S1 failure

Combined message to indicate the failure of the S1 supply or activation of an input configured to *Auxiliary S1 Failure*.

S1 Under Frequency trip

The S1 supply is below the configured *Under Frequency* trip level.

S1 Under Voltage trip

The S1 supply is below the configured *Under Voltage* trip level.

S1 Over Frequency trip

The S1 supply is above the configured *Over Frequency* trip level.

S1 Over Voltage trip

S1 supply is above the configured *Over Voltage* trip level.

7.2.3 PLANT BATTERY

Plant battery alarms are *Warning* alarms only. The module displays the fault but no further action is taken.

Under Voltage warning

The battery supply is below the configured *Under Voltage* warning level.

Under Voltage warning

The battery supply is above the configured *Over Voltage* warning level.



8 FRONT PANEL CONFIGURATION

This configuration mode allows the operator limited customising of the way the module operates.

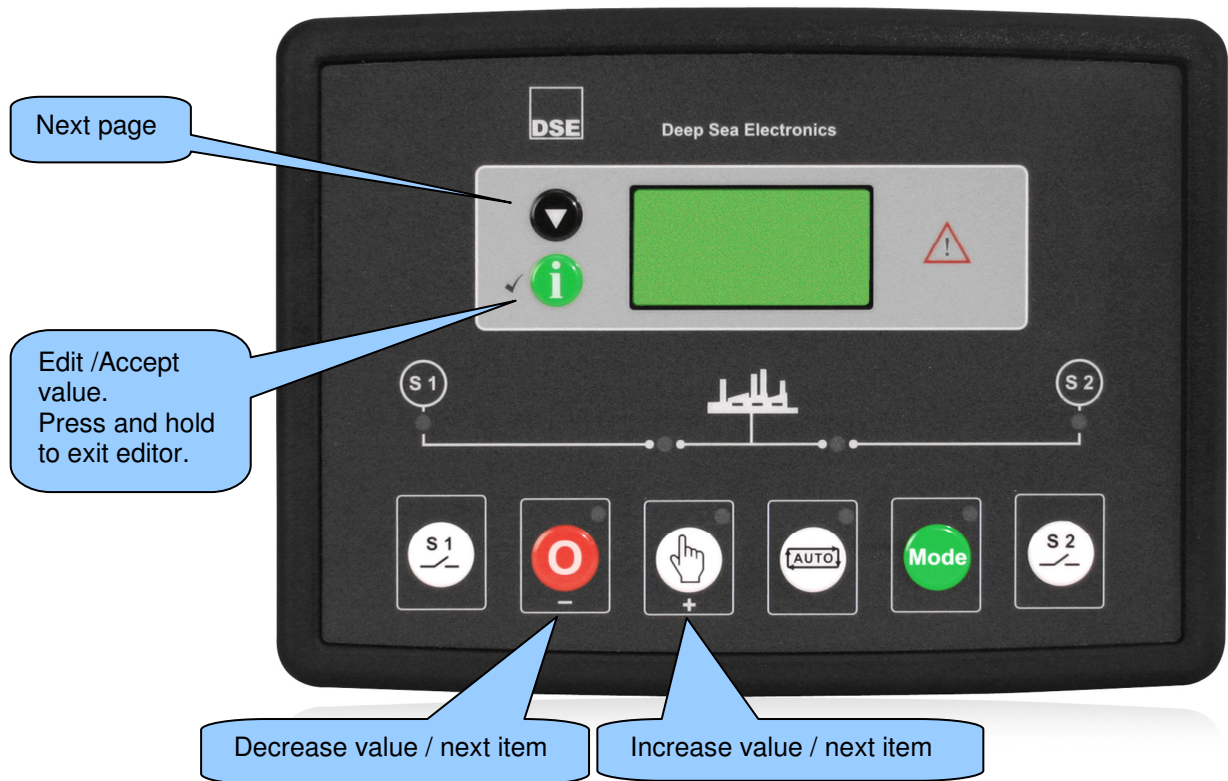
Use the module's navigation buttons to traverse the menu and make value changes to the parameters:









8.1 ACCESSING THE FRONT PANEL EDITOR (FPE)



To enter the 'configuration mode' press both the **DOWN**  and **INFO**  buttons together.

NOTE:- To exit the front panel configuration editor and activate your changes, press and hold the  button. Ensure you have saved any changes you have made by pressing the  button first.

NOTE:- When the editor is visible, it is automatically exited after 5 minutes of inactivity to ensure security.

8.1.1 EDITING A PARAMETER

- Enter the editor as described above.
- Press  to select the required 'page' as detailed in the configuration suite tables.
- Press  (+) to select the next parameter or  (-) to select the previous parameter within the current page.
- When viewing the parameter to be changed, press the  button. The value begins to flash.
- Press  (+) or  (-) to adjust the value to the required setting.
- Press  to save the current value, the value ceases flashing.

Press and hold the  button to activate the changes you have made and exit the editor. the configuration icon  is removed from the display.

8.2 ADJUSTABLE PARAMETERS (CONFIGURATION EDITOR)

When viewing the configuration editor, Press  to select the required 'page' as listed below.











Front Panel Configuration Editor (Factory default settings are shown in bold italicised text)

Page	FPE ID	Parameter	Values
DISPLAY	101	LCD Contrast	0%
	102	Display Mode	English (0), Icon Only (1)
	103	Date and Time	dd-mm-yyyy, hh:mm:ss
	104	S1 Option	Mains (0), Generator (1)
	105	S2 Option	Mains (0) Generator (1)
S2	201	Immediate S2 Dropout	Off (0) On (1)
	202	Under Voltage Trip (Generator Option)	0 V
	203	Over Voltage Trip (Generator Option)	0 V
	204	Under Frequency Trip (Generator Option)	0.0 Hz
	205	Over Frequency Trip (Generator Option)	0.0 Hz
	206	Under Voltage Trip (Mains Option)	0 V
	207	Over Voltage Trip (Mains Option)	0 V
	208	Under Frequency Trip (Mains Option)	0.0 Hz
	209	Over Frequency Trip (Mains Option)	0.0 Hz
S1	301	Immediate S1 Dropout	Off (0) On (1)
	302	Under Voltage Trip	0 V
	303	Over Voltage Trip	0 V
	304	Under Frequency Trip	0 Hz
	305	Over Frequency Trip	0 Hz
TIMERS	401	S1 Transient Delay	mm:ss
	402	Start Delay	hh:mm:ss
	403	Warming Up Time	hh:mm:ss
	404	S2 Fail Delay	mm:ss
	405	Elevator Delay	mm:ss
	406	Non-sync Transfer Time	mm:ss.s
	407	Check-Sync Transfer time	mm:ss.s
	408	Return Delay	hh:mm:ss
	409	Cooling Time	hh:mm:ss
	410	Fail to Stop Enable	Disabled (0) Enabled (1)
	411	Fail to Stop Delay	mm:ss
	412	S2 Transient Delay	s.s
	413	LCD Scroll Timer	hh:mm:ss

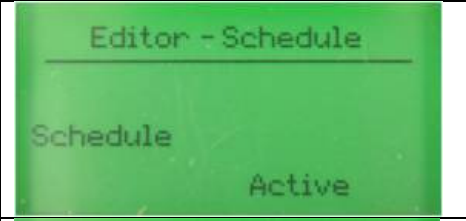
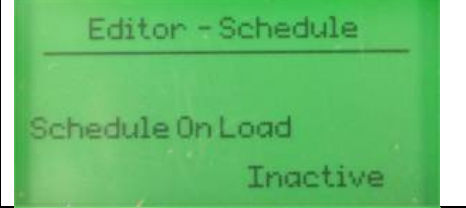
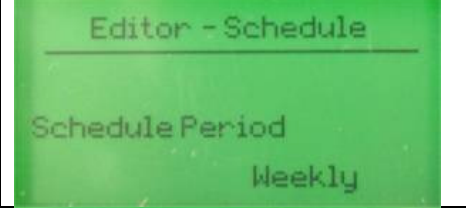
Front Panel Configuration

Page	FPE ID	Parameter	Values
	414	LCD Page Timer	hh:mm:ss
	413	LCD Scroll Timer	hh:mm:ss
SCHEDULER	501	Scheduler Enable	Disabled (0) Enabled (1)
	502	Scheduler Bank 1 Run Mode	Off Load (0) On Load (1) Do Not Transfer (2)
	503	Scheduler Bank 1 Period	Weekly (0) Monthly (1)
	504	Scheduler Bank 1 Event 1 Day	1-7 (Day, 1=Monday)
	505	Scheduler Bank 1 Event 1 Start Time	hh:mm
	506	Scheduler Bank 1 Event 1 Duration	hh:mm
	507	Scheduler Bank 1 Event 2 Day	1-7 (Day, 1=Monday)
	508	Scheduler Bank 1 Event 2 Start Time	hh:mm
	509	Scheduler Bank 1 Event 2 Duration	hh:mm
	510	Scheduler Bank 1 Event 3 Day	1-7 (Day, 1=Monday)
	511	Scheduler Bank 1 Event 3 Start Time	hh:mm
	512	Scheduler Bank 1 Event 3 Duration	hh:mm
	513	Scheduler Bank 1 Event 4 Day	1-7 (Day, 1=Monday)
	514	Scheduler Bank 1 Event 4 Start Time	hh:mm
	515	Scheduler Bank 1 Event 4 Duration	hh:mm
	516	Scheduler Bank 1 Event 5 Day	1-7 (Day, 1=Monday)
	517	Scheduler Bank 1 Event 5 Start Time	hh:mm
	518	Scheduler Bank 1 Event 5 Duration	hh:mm
	519	Scheduler Bank 1 Event 6 Day	1-7 (Day, 1=Monday)
	520	Scheduler Bank 1 Event 6 Start Time	hh:mm
	521	Scheduler Bank 1 Event 6 Duration	hh:mm
	522	Scheduler Bank 1 Event 7 Day	1-7 (Day, 1=Monday)
	523	Scheduler Bank 1 Event 7 Start Time	hh:mm
	524	Scheduler Bank 1 Event 7 Duration	hh:mm
	525	Scheduler Bank 1 Event 8 Day	1-7 (Day, 1=Monday)
	526	Scheduler Bank 1 Event 8 Start Time	hh:mm
	527	Scheduler Bank 1 Event 8 Duration	hh:mm
	528	Scheduler Bank 2 Run Mode	Off Load (0) On Load (1) Do Not Transfer (2)
	529	Scheduler Bank 2 Period	Weekly (0) Monthly (1)
	530	Scheduler Bank 2 Event 1 Day	1-7 (Day, 1=Monday)
	531	Scheduler Bank 2 Event 1 Start Time	hh:mm
	532	Scheduler Bank 2 Event 1 Duration	hh:mm
	533	Scheduler Bank 2 Event 2 Day	1-7 (Day, 1=Monday)
	534	Scheduler Bank 2 Event 2 Start Time	hh:mm
	535	Scheduler Bank 2 Event 2 Duration	hh:mm
	536	Scheduler Bank 2 Event 3 Day	1-7 (Day, 1=Monday)
	537	Scheduler Bank 2 Event 3 Start Time	hh:mm
	538	Scheduler Bank 2 Event 3 Duration	hh:mm
	539	Scheduler Bank 2 Event 4 Day	1-7 (Day, 1=Monday)
	540	Scheduler Bank 2 Event 4 Start Time	hh:mm
	541	Scheduler Bank 2 Event 4 Duration	hh:mm
	542	Scheduler Bank 2 Event 5 Day	1-7 (Day, 1=Monday)
	543	Scheduler Bank 2 Event 5 Start Time	hh:mm
	544	Scheduler Bank 2 Event 5 Duration	hh:mm
	545	Scheduler Bank 2 Event 6 Day	1-7 (Day, 1=Monday)
	546	Scheduler Bank 2 Event 6 Start Time	hh:mm
	547	Scheduler Bank 2 Event 6 Duration	hh:mm
	548	Scheduler Bank 2 Event 7 Day	1-7 (Day, 1=Monday)
	549	Scheduler Bank 2 Event 7 Start Time	hh:mm
	550	Scheduler Bank 2 Event 7 Duration	hh:mm
	551	Scheduler Bank 2 Event 8 Day	1-7 (Day, 1=Monday)
	552	Scheduler Bank 2 Event 8 Start Time	hh:mm
	553	Scheduler Bank 2 Event 8 Duration	hh:mm

8.2.1 SCHEDULER SETTING

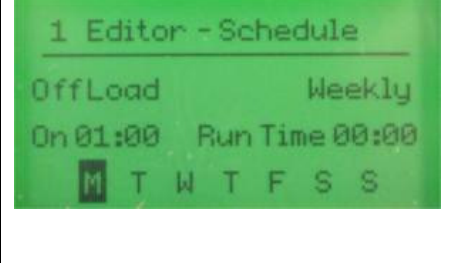
<p>Enter the editor as described above and press the  button to access the Scheduler page.</p> <p>Press   to enter edit mode and use the + / i buttons to make the Schedule function active. Press   to save your change.</p>	 <p>Editor - Schedule</p> <hr/> <p>Schedule</p> <p style="text-align: right;">Active</p>
<p>Press + to move to the next item. Review the current setting and choose if the Scheduler is to perform an 'on load' test (active) or 'off load' test (inactive)</p>	 <p>Editor - Schedule</p> <hr/> <p>Schedule On Load</p> <p style="text-align: right;">Inactive</p>
<p>Press + to move to the next item. Review the current setting and choose if the Scheduler is to perform a weekly schedule (repeats every 7 days) or monthly (repeats every 28 days)</p>	 <p>Editor - Schedule</p> <hr/> <p>Schedule Period</p> <p style="text-align: right;">Weekly</p>
<p>Press + to move to the next item.</p> <p>Press  to select which schedule entry to edit (there are up to 16 entries indicated by the number in the top left corner)</p> <p>Press   to edit the schedule. The item being edited flashes.</p> <p>Press + / - to change the flashing item.</p> <p>Press  to move to the next editable value. (On, Day, Run Time etc)</p> <p>Press   to save your change</p>	 <p>1 Editor - Schedule</p> <hr/> <p>OffLoad Weekly</p> <p>On 01:00 Run Time 00:00</p> <p>M T W T F S S</p>



9 MAINTENANCE, SPARES, REPAIR AND SERVICING

The DSE333 Series controller is designed to be *Fit and Forget*. As such, there are no user serviceable parts within the controller.

In the case of malfunction, you should contact your original equipment supplier (OEM).

9.1 PURCHASING ADDITIONAL CONNECTOR PLUGS FROM DSE

If you require additional plugs from DSE, please contact our Sales department using the part numbers below.

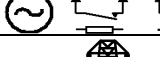
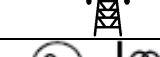
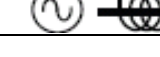
333 series terminal designation	Plug description	Part No.
1-4	 4 way 5.08mm	007-444
5-10	 6 way 5.08mm	007-446
11-21	 11 way 5.08mm	007-451
22-29	 8 way 7.62mm	007-454
30-33	 4 way 7.62mm	007-171
34-38	 5 way 5.08mm	007-445

9.2 PURCHASING ADDITIONAL FIXING CLIPS FROM DSE

Item	Description	Part No.
	DSE334 / DSE6000 series fixing clips (packet of 4)	020-294

9.3 PURCHASING SEALING GASKET FROM DSE

The optional sealing gasket is not supplied with the controller but can be purchased separately.

Item	Description	Part No.
	DSE334 \ DSE6000 silicon sealing gasket	020-389

10 WARRANTY

DSE provides limited warranty to the equipment purchaser at the point of sale. For full details of any applicable warranty, you are referred to your original equipment supplier (OEM).

11 DISPOSAL

11.1 WEEE (WASTE ELECTRICAL AND ELECTRONIC EQUIPMENT)

Directive 2002/96/EC

If you use electrical and electronic equipment you must store, collect, treat, recycle and dispose of WEEE separately from your other waste.



11.2 ROHS (RESTRICTION OF HAZARDOUS SUBSTANCES)

Directive 2002/95/EC:2006

To remove specified hazardous substances (Lead, Mercury, Hexavalent Chromium, Cadmium, PBB & PBDE's)

Exemption Note: Category 9. (Monitoring & Control Instruments) as defined in Annex 1B of the WEEE directive will be exempt from the RoHS legislation. This was confirmed in the August 2005 UK's Department of Trade and Industry RoHS REGULATIONS Guide (Para 11).

Despite this exemption DSE has been carefully removing all non RoHS compliant components from our supply chain and products.

When this is completed a Lead Free & RoHS compatible manufacturing process will be phased into DSE production.

This is a process that is almost complete and is being phased through different product groups.

12 APPENDIX

12.1 COMMUNICATIONS OPTION CONNECTIONS

12.1.1 DESCRIPTION

The DSE Configuration Suite software allows the controller to communicate with a PC. The computer connects to the module as shown below and allows easy adjustment of the operating parameters and firmware update of the controller.

12.1.2 PC TO CONTROLLER (DIRECT) CONNECTION

To connect a 334 ATS module to a PC the following items are required: -

- DSE334 series module



Configuration Suite software (Supplied on configuration suite software CD or available from www.deepseapl.com).



- USB cable Type A to Type B.



NOTE:- The DC supply must be connected to the module for configuration by PC.

NOTE:- Refer to DSE Configuration Suite software Manual for further details on configuring the module by PC.

12.2 ENCLOSURE CLASSIFICATIONS

12.2.1 IP CLASSIFICATIONS

334 series specification under BS EN 60529 Degrees of protection provided by enclosures

IP65 (Front of module when module is installed into the control panel with the supplied sealing gasket).

IP42 (front of module when module is installed into the control panel WITHOUT being sealed to the panel)

First Digit		Second Digit	
Protection against contact and ingress of solid objects		Protection against ingress of water	
0	No protection	0	No protection
1	Protected against ingress solid objects with a diameter of more than 50 mm. No protection against deliberate access, e.g. with a hand, but large surfaces of the body are prevented from approach.	1	Protection against dripping water falling vertically. No harmful effect must be produced (vertically falling drops).
2	Protected against penetration by solid objects with a diameter of more than 12 mm. Fingers or similar objects prevented from approach.	2	Protection against dripping water falling vertically. There must be no harmful effect when the equipment (enclosure) is tilted at an angle up to 15° from its normal position (drops falling at an angle).
3	Protected against ingress of solid objects with a diameter of more than 2.5 mm. Tools, wires etc. with a thickness of more than 2.5 mm are prevented from approach.	3	Protection against water falling at any angle up to 60° from the vertical. There must be no harmful effect (spray water).
4	Protected against ingress of solid objects with a diameter of more than 1 mm. Tools, wires etc. with a thickness of more than 1 mm are prevented from approach.	4	Protection against water splashed against the equipment (enclosure) from any direction. There must be no harmful effect (splashing water).
5	Protected against harmful dust deposits. Ingress of dust is not totally prevented but the dust must not enter in sufficient quantity to interface with satisfactory operation of the equipment. Complete protection against contact.	5	Protection against water projected from a nozzle against the equipment (enclosure) from any direction. There must be no harmful effect (water jet).
6	Protection against ingress of dust (dust tight). Complete protection against contact.	6	Protection against heavy seas or powerful water jets. Water must not enter the equipment (enclosure) in harmful quantities (splashing over).

12.2.2 NEMA CLASSIFICATIONS

333 series NEMA Rating (Approximate)

12 (Front of module when module is installed into the control panel with the optional sealing gasket).

2 (front of module when module is installed into the control panel WITHOUT being sealed to the panel)

 **NOTE: - There is no direct equivalence between IP / NEMA ratings. IP figures shown are approximate only.**

1 IP30	Provides a degree of protection against contact with the enclosure equipment and against a limited amount of falling dirt.
2 IP31	Provides a degree of protection against limited amounts of falling water and dirt.
3 IP64	Provides a degree of protection against windblown dust, rain and sleet; undamaged by the formation of ice on the enclosure.
3R IP32	Provides a degree of protection against rain and sleet;; undamaged by the formation of ice on the enclosure.
4 (X) IP66	Provides a degree of protection against splashing water, windblown dust and rain, hose directed water; undamaged by the formation of ice on the enclosure. (Resist corrosion).
12/12K IP65	Provides a degree of protection against dust, falling dirt and dripping non corrosive liquids.
13 IP65	Provides a degree of protection against dust and spraying of water, oil and non corrosive coolants.

This page is intentionally left blank