



# DEEP SEA ELECTRONICS PLC DSE335 Operator Manual

(Applicable to module version 4.2 and upwards)

**Document Number: 057-233**

Author: Fady Atallah



057-233 ISSUE: 1

## **DEEP SEA ELECTRONICS PLC**

Highfield House  
Hunmanby  
North Yorkshire  
YO14 0PH  
ENGLAND



Sales Tel: +44 (0) 1723 890099  
Sales Fax: +44 (0) 1723 893303

E-mail: sales@deepseapl.com  
Website: www.deepseapl.com

### **DSE335 Operator Manual**

© Deep Sea Electronics Plc

All rights reserved. No part of this publication may be reproduced in any material form (including photocopying or storing in any medium by electronic means or other) without the written permission of the copyright holder except in accordance with the provisions of the Copyright, Designs and Patents Act 1988.

Applications for the copyright holder's written permission to reproduce any part of this publication must be addressed to Deep Sea Electronics Plc at the address above.

The DSE logo is a UK registered trademarks of Deep Sea Electronics PLC.

Any reference to trademarked product names used within this publication is owned by their respective companies.



Deep Sea Electronics Plc reserves the right to change the contents of this document without prior notice.

### **Amendments List**

<b>Issue</b>	<b>Comments</b>	<b>Minimum Module Version Required</b>	<b>Minimum Configuration Suite Version Required</b>
1	Initial release	V4.2.22	2014.101 V1.212.3
2	Updates to Breaker Scheme C		

Typeface: The typeface used in this document is Arial. Care must be taken not to mistake the upper case letter I with the numeral 1. The numeral 1 has a top serif to avoid this confusion.

### **Clarification of notation used within this publication.**

	<b>NOTE</b>	Highlights an essential element of a procedure to ensure correctness.
	<b>CAUTION!</b>	Indicates a procedure or practice, which, if not strictly observed, results in damage or destruction of equipment.
	<b>WARNING!</b>	Indicates a procedure or practice, which results in injury to personnel or loss of life if not followed correctly.

## TABLE OF CONTENTS

SECTION	PAGE
<b>1 INTRODUCTION.....</b>	<b>6</b>
<b>1.1 BIBLIOGRAPHY.....</b>	<b>7</b>
1.1.1 INSTALLATION INSTRUCTIONS.....	7
1.1.2 TRAINING GUIDES.....	7
1.1.3 MANUALS.....	7
1.1.4 THIRD PARTY DOCUMENTS.....	7
<b>2 SPECIFICATIONS .....</b>	<b>8</b>
<b>2.1 SHORT NAMES.....</b>	<b>8</b>
<b>2.2 REQUIREMENTS FOR UL CERTIFICATION.....</b>	<b>8</b>
<b>2.3 TERMINAL SPECIFICATION.....</b>	<b>9</b>
<b>2.4 POWER SUPPLY REQUIREMENTS.....</b>	<b>9</b>
2.4.1 MODULE SUPPLY INSTRUMENTATION DISPLAY.....	9
<b>2.5 S1 &amp; S2 VOLTAGE / FREQUENCY SENSING.....</b>	<b>10</b>
<b>2.6 CURRENT SENSING.....</b>	<b>10</b>
2.6.1 V A RATING OF THE CTS .....	11
2.6.2 CT POLARITY.....	12
2.6.3 CT PHASING .....	12
2.6.4 CT CLASS.....	12
<b>2.7 INPUTS.....</b>	<b>13</b>
2.7.1 DIGITAL INPUTS .....	13
<b>2.8 OUTPUTS.....</b>	<b>13</b>
2.8.1 CONFIGURABLE OUTPUTS A & E.....	13
2.8.2 CONFIGURABLE OUTPUTS B & F.....	13
2.8.3 CONFIGURABLE OUTPUTS C & D.....	13
2.8.4 CONFIGURABLE OUTPUTS G, H, I, J, K & L.....	13
<b>2.9 COMMUNICATION PORTS.....</b>	<b>14</b>
2.9.1 COMMUNICATION PORT USAGE.....	15
2.9.1.1 USB CONNECTION.....	15
2.9.1.2 RS232.....	16
2.9.1.3 RECOMMENDED PC RS232 SERIAL PORT ADD-ONS .....	16
2.9.1.4 RECOMMENDED EXTERNAL MODEMS.....	17
2.9.1.5 RS485.....	18
2.9.1.6 RECOMMENDED PC RS485 SERIAL PORT ADD-ONS .....	18
2.9.2 DSENET® FOR EXPANSION MODULES.....	19
<b>2.10 ADDING AN EXTERNAL SOUNDER TO THE APPLICATION.....</b>	<b>19</b>
<b>2.11 DIMENSIONS AND MOUNTING.....</b>	<b>20</b>
2.11.1 DIMENSIONS.....	20
2.11.2 PANEL CUTOUT.....	20
2.11.3 WEIGHT.....	20
2.11.4 FIXING CLIPS.....	21
2.11.5 CABLE TIE FIXING POINTS .....	22
2.11.6 SILICON SEALING GASKET.....	22
2.11.8 APPLICABLE STANDARDS.....	23
2.11.9 ENCLOSURE CLASSIFICATIONS.....	25
2.11.9.1 IP CLASSIFICATIONS.....	25
2.11.9.2 NEMA CLASSIFICATIONS.....	26
<b>3 INSTALLATION .....</b>	<b>27</b>
<b>3.1 TERMINAL DESCRIPTION.....</b>	<b>27</b>
3.1.1 DC SUPPLY, OUTPUTS G-L.....	28
3.1.2 CONFIGURABLE DIGITAL INPUTS A-I.....	28
3.1.3 CONFIGURABLE DIGITAL INPUTS J-L, DSENET .....	29
3.1.4 CONFIGURABLE VOLT-FREE OUTPUTS E & F.....	29
3.1.5 LOAD SWITCHING AND S2 VOLTAGE SENSING.....	29
3.1.6 S1 VOLTAGE SENSING .....	30

3.1.7	LOAD CURRENT TRANSFORMERS .....	30
3.1.7.1	CT CONNECTIONS .....	31
3.1.8	CONFIGURABLE VOLT-FREE CHANGEOVER OUTPUTS C & D .....	32
3.1.9	PC CONFIGURATION INTERFACE CONNECTOR.....	32
3.1.10	RS485 CONNECTOR.....	33
3.1.11	RS232 CONNECTOR.....	33
<b>3.2</b>	<b>TYPICAL WIRING DIAGRAM .....</b>	<b>34</b>
3.2.1	3 PHASE, 4 WIRE .....	36
<b>3.3</b>	<b>ALTERNATIVE TOPOLOGIES .....</b>	<b>36</b>
3.3.1	SINGLE PHASE .....	37
3.3.2	2 PHASE (L1 & L2) 3 WIRE.....	38
3.3.3	2 PHASE (L1 & L3) 3 WIRE.....	38
<b>3.4</b>	<b>EARTH SYSTEMS.....</b>	<b>39</b>
3.4.1	NEGATIVE EARTH .....	39
3.4.2	POSITIVE EARTH.....	39
3.4.3	FLOATING EARTH .....	39
<b>3.5</b>	<b>TYPICAL ARRANGEMENT OF DSENET®.....</b>	<b>39</b>
<b>4</b>	<b>DESCRIPTION OF CONTROLS.....</b>	<b>40</b>
<b>4.1</b>	<b>CONTROL PUSH-BUTTONS.....</b>	<b>42</b>
<b>4.2</b>	<b>VIEWING THE INSTRUMENT PAGES.....</b>	<b>44</b>
4.2.1	STATUS .....	45
4.2.2	S1 .....	46
4.2.3	S2 .....	46
4.2.4	MODULE.....	46
4.2.5	EXPANSION .....	47
4.2.6	ALARMS .....	47
4.2.7	EVENT LOG.....	47
4.2.8	SERIAL PORT.....	48
4.2.8.1	RS232 SERIAL PORT .....	48
4.2.8.2	RS485 SERIAL PORT .....	52
4.2.9	SCHEDULER .....	53
4.2.10	ABOUT.....	53
<b>4.3</b>	<b>VIEWING LATEST TRANSFER INFORMATION PAGE.....</b>	<b>54</b>
<b>4.4</b>	<b>USER CONFIGURABLE INDICATORS .....</b>	<b>55</b>
<b>4.5</b>	<b>OPERATION.....</b>	<b>56</b>
4.5.1.1	BREAKER SCHEME A.....	56
4.5.1.2	BREAKER SCHEME B.....	56
4.5.1.3	BREAKER SCHEME C.....	56
<b>4.6</b>	<b>QUICKSTART GUIDE.....</b>	<b>57</b>
4.6.1	STARTING S2.....	57
4.6.2	STOPPING S2 .....	58
<b>4.7</b>	<b>STOP/RESET .....</b>	<b>59</b>
<b>4.8</b>	<b>MANUAL MODE.....</b>	<b>60</b>
4.8.1	STARTING SEQUENCE.....	60
4.8.2	S2 AVAILABLE.....	60
4.8.3	STOPPING SEQUENCE .....	61
<b>4.9</b>	<b>AUTOMATIC MODE .....</b>	<b>62</b>
4.9.1	WAITING IN AUTO MODE .....	62
4.9.2	STARTING SEQUENCE.....	62
4.9.3	S2 AVAILABLE.....	63
4.9.4	STOPPING SEQUENCE .....	63
<b>4.10</b>	<b>MODE SELECTION.....</b>	<b>64</b>
4.10.1	TEST ON LOAD .....	64
4.10.1.1	STARTING SEQUENCE.....	64
4.10.1.2	S2 AVAILABLE.....	64
4.10.1.3	STOPPING SEQUENCE .....	64
4.10.2	TEST OFF LOAD .....	65
4.10.2.1	STARTING SEQUENCE.....	65
4.10.2.2	S2 AVAILABLE.....	65

4.10.2.3	STOPPING SEQUENCE .....	65
4.10.3	PROHIBIT RETURN.....	66
4.10.3.1	WAITING IN PROHIBIT RETURN.....	66
4.10.3.2	STARTING SEQUENCE.....	66
4.10.3.3	S2 AVAILABLE.....	67
4.10.3.4	STOPPING SEQUENCE .....	67
<b>4.11</b>	<b>SCHEDULER .....</b>	<b>68</b>
4.11.1	STOP MODE.....	68
4.11.2	MANUAL MODE.....	68
4.11.3	AUTO MODE.....	68
<b>4.12</b>	<b>LOAD SHEDDING CONTROL.....</b>	<b>69</b>
4.12.1	LOAD SHEDDING CONTROL.....	69
<b>5</b>	<b>PROTECTIONS.....</b>	<b>70</b>
5.1	INDICATIONS.....	71
5.2	WARNINGS .....	72
5.3	ELECTRICAL TRIPS .....	73
<b>6</b>	<b>FRONT PANEL CONFIGURATION.....</b>	<b>74</b>
6.1	ACCESSING THE MAIN FRONT PANEL CONFIGURATION EDITOR.....	75
6.1.1	EDITING A PARAMETER.....	76
6.2	ADJUSTABLE PARAMETERS.....	77
<b>7</b>	<b>COMMISSIONING.....</b>	<b>80</b>
<b>8</b>	<b>FAULT FINDING .....</b>	<b>81</b>
8.1	STARTING.....	81
8.2	LOADING .....	81
8.3	ALARMS.....	81
8.4	COMMUNICATIONS.....	82
8.5	INSTRUMENTS .....	82
8.6	MISCELLANEOUS .....	83
<b>9</b>	<b>MAINTENANCE, SPARES, REPAIR AND SERVICING .....</b>	<b>84</b>
9.1	PURCHASING ADDITIONAL CONNECTOR PLUGS FROM DSE .....	84
9.1.1	PACK OF PLUGS.....	84
9.1.2	INDIVIDUAL PLUGS .....	84
9.2	PURCHASING ADDITIONAL FIXING CLIPS FROM DSE.....	84
9.3	PURCHASING ADDITIONAL SEALING GASKET FROM DSE.....	84
9.4	DSENET EXPANSION MODULES.....	85
<b>10</b>	<b>WARRANTY .....</b>	<b>86</b>
<b>11</b>	<b>DISPOSAL .....</b>	<b>86</b>
11.1	WEEE (WASTE ELECTRICAL AND ELECTRONIC EQUIPMENT) .....	86

## 1 INTRODUCTION

This document details the installation and operation requirements of the DSE335 module version 4.2 and later, part of the DSEATS® range of products.

A separate document covers the DSE335 modules with firmware version prior to version 4.2.

The manual forms part of the product and must be kept for the entire life of the product. If the product is passed or supplied to another party, ensure that this document is passed to them for reference purposes.

This is not a *controlled document*. Updates are not automatically informed. Any future updates of this document are included on the DSE website at [www.deepseapl.com](http://www.deepseapl.com)

The module is designed to provide differing levels of functionality across a common platform. This allows the OEM greater flexibility in the choice of controller to use for a specific application.

The module has been designed to allow the operator to control the transfer of the load from Source 1 (S1) to Source 2 (S2), typically the mains supply and a standby generator either manually (via fascia mounted push-buttons) or automatically upon S1 failure. Additionally if configured too, the module automatically starts and stops the generator set (S2) depending upon the status of S1.

The user also has the facility to view the system operating parameters via the LCD display to monitor the supplies and indicating the operational status and fault conditions of the module.

The powerful ARM microprocessor contained within the module allows for incorporation of a range of complex features:

- *Text based LCD display (supporting multiple languages)*
- ***True RMS** Voltage, Current and Power monitoring*
- *Communications capability (RS485 or RS232)*
- *Multiple AC supply monitoring*
- *Fully configurable inputs for use as alarms or a range of different functions.*

Using a PC and the DSE Configuration Suite software allows alteration of selected operational sequences, timers, alarms and operational sequences. Additionally, the module's integral front panel configuration editor allows adjustment of this information.

A robust plastic case designed for front panel mounting houses the module. Connections are via locking plug and sockets.

Access to critical operational sequences and timers for use by qualified engineers, can be protected by a security code. Module access can also be protected by PIN code. Selected parameters can be changed from the module's front panel.

The module is housed in a robust plastic case suitable for panel mounting. Connections to the module are via locking plug and sockets.

## 1.1 BIBLIOGRAPHY

This document refers to and is referred to by the following DSE publications are obtained from the DSE website: [www.deepseapl.com](http://www.deepseapl.com)

### 1.1.1 INSTALLATION INSTRUCTIONS

Installation instructions are supplied with the product in the box and are intended as a 'quick start' guide only.

DSE Part	Description
053-135	DSE335 Installation Instructions
053-032	DSE2548 LED Expansion Annunciator Installation Instructions
053-033	DSE2130 Input Expansion Installation Instructions
053-034	DSE2157 Output Expansion Installation Instructions

### 1.1.2 TRAINING GUIDES

Training Guides are produced to give 'handout' sheets on specific subjects during training sessions.

DSE Part	Description
056-005	Using CTs With DSE Products
056-022	Breaker Control
056-024	GSM Modem
056-030	Module PIN Codes

### 1.1.3 MANUALS

Product manuals are are downloaded from the DSE website: [www.deepseapl.com](http://www.deepseapl.com).

DSE Part	Description
057-237	DSE335 Configuration Suite PC Software Manual
057-082	DSE2130 Input Expansion Manual
057-083	DSE2157 Output Expansion Manual
057-084	DSE2548 Annunciator Expansion Manual
057-158	DSE335 Operators Manual – prior to v4.2

### 1.1.4 THIRD PARTY DOCUMENTS

The following third party documents are also referred to:

Reference	Description
ISBN 1-55937-879-4	IEEE Std C37.2-1996 IEEE Standard Electrical Power System Device Function Numbers and Contact Designations. Institute of Electrical and Electronics Engineers Inc
ISBN 0-7506-1147-2	Diesel generator handbook. L.L.J.Mahon
ISBN 0-9625949-3-8	On-Site Power Generation. EGSA Education Committee.

## 2 SPECIFICATIONS

### 2.1 SHORT NAMES

Short Name	Description
DSE3xx	All modules/controllers in the DSEATS range
DSE335	DSE335 module/controller

### 2.2 REQUIREMENTS FOR UL CERTIFICATION

Description	Specification
Screw Terminal Tightening Torque	<ul style="list-style-type: none"> <li>4.5 lb-in (0.5 Nm)</li> </ul>
Conductors	<ul style="list-style-type: none"> <li>Terminals suitable for connection of conductor size 12 AWG to 26 AWG (0.5 mm<sup>2</sup> to 2.0 mm<sup>2</sup>).</li> <li>Conductor protection must be provided in accordance with NFPA 70, Article 240</li> <li>Low voltage circuits (35 V or less) must be supplied from the engine starting battery or an isolated secondary circuit.</li> <li>The communication, sensor, and/or battery derived circuit conductors shall be separated and secured to maintain at least ¼" (6 mm) separation from the generator and mains connected circuit conductors unless all conductors are rated 600 V or greater.</li> </ul>
Current Inputs	<ul style="list-style-type: none"> <li>Must be connected through UL Listed or Recognized isolating current transformers with the secondary rating of 5 A maximum.</li> </ul>
Communication Circuits	<ul style="list-style-type: none"> <li>Must be connected to communication circuits of UL Listed equipment</li> </ul>
Output Pilot Duty	<ul style="list-style-type: none"> <li>0.5 A</li> </ul>
Mounting	<ul style="list-style-type: none"> <li>Suitable for use in type 1 Enclosure Type rating with surrounding air temperature -22 °F to +158 °F (-30 °C to +70 °C)</li> <li>Suitable for pollution degree 3 environments when voltage sensing inputs do not exceed 300 V. When used to monitor voltages over 300 V, a device is to be installed in an unventilated or filtered ventilation enclosure to maintain a pollution degree 2 environment.</li> </ul>
Operating Temperature	<ul style="list-style-type: none"> <li>-22 °F to +158 °F (-30 °C to +70 °C)</li> </ul>
Storage Temperature	<ul style="list-style-type: none"> <li>-40 °F to +176 °F (-40 °C to +80 °C)</li> </ul>



## 2.3 TERMINAL SPECIFICATION

**NOTE:** For purchasing additional connector plugs from DSE, see the section entitled **Maintenance, Spares, Repair and Servicing** elsewhere in this document.

Description	Specification	
Connection Type	Two part connector. <ul style="list-style-type: none"> <li>• Male part fitted to module</li> <li>• Female part supplied in module packing case - Screw terminal, rising clamp, no internal spring.</li> </ul>	 <p>Example showing cable entry and screw terminals of a 10 way connector</p>
Minimum Cable Size	0.5 mm <sup>2</sup> (AWG 24)	
Maximum Cable Size	2.5 mm <sup>2</sup> (AWG 10)	

## 2.4 POWER SUPPLY REQUIREMENTS

Description	Specification
Minimum supply voltage	8V continuous
Cranking dropouts	Able to survive 0V for 50mS providing the supply was at least 10V before the dropout and recovers to 5V afterwards.
Maximum supply voltage	35V continuous (60V protection)
Reverse polarity protection	-35V continuous
Maximum operating current	360mA at 24V 480mA at 12V
Maximum standby current	96mA at 24V 126mA at 12V

### 2.4.1 MODULE SUPPLY INSTRUMENTATION DISPLAY

Description	Specification
Range	0 V to 70 V DC Maximum continuous operating voltage of 35 V DC
Resolution	0.1 V
Accuracy	1% full scale ( $\pm 0.7$ V)

## 2.5 S1 & S2 VOLTAGE / FREQUENCY SENSING

Description	Specification
Measurement type	True RMS conversion
Sample Rate	5KHz or better
Harmonics	Up to 10 <sup>th</sup> or better
Input Impedance	300K $\Omega$ ph-N
Phase to Neutral	15V (minimum required for sensing frequency) to 333V AC (absolute maximum) Suitable for 110V to 277V nominal ( $\pm 20\%$ for under/overvoltage detection)
Phase to Phase	26V (minimum required for sensing frequency) to 576V AC (absolute maximum) Suitable for 190V ph-ph to 479V ph-ph nominal ( $\pm 20\%$ for under/overvoltage detection)
Common mode offset from Earth	100V AC (max)
Resolution	1V AC phase to neutral 2V AC phase to phase
Accuracy	$\pm 1\%$ of full scale phase to neutral $\pm 2\%$ of full scale phase to phase
Minimum frequency	3.5Hz
Maximum frequency	75.0Hz
Frequency resolution	0.1Hz
Frequency accuracy	$\pm 0.2\text{Hz}$

## 2.6 CURRENT SENSING

Description	Specification
Measurement type	True RMS conversion
Sample Rate	5KHz or better
Harmonics	Up to 10 <sup>th</sup> or better
Nominal CT secondary rating	5A
Maximum continuous current	5A
Overload Measurement	15A for 100ms
Absolute maximum overload	50A for 1 second
Burden	0.5VA (0.02 $\Omega$ current shunts)
common mode offset	$\pm 2\text{V}$ peak plant ground to CT common terminal
Resolution	25ma
Accuracy	$\pm 1\%$ of Nominal (5A) (excluding CT error)

### 2.6.1 V A RATING OF THE CTS

**NOTE:** Details for 4 mm<sup>2</sup> cables are shown for reference only. The connectors on the DSE modules are only suitable for cables up to 2.5 mm<sup>2</sup>.

The V A burden of the module on the CTs is 0.5 V A. However depending upon the type and length of cabling between the CTs and the module, CTs with a greater V A rating than the module are required.

The distance between the CTs and the measuring module must be calculated and cross-referenced against the chart opposite to find the V A burden of the cable itself.

If the CTs are fitted within the alternator top box, the star point (common) of the CTs must be connected to system ground (earth) as close as possible to the CTs. This minimises the length of cable used to connect the CTs to the DSE module.

**Example.**

If 1.5 mm<sup>2</sup> cable is used and the distance from the CT to the measuring module is 20 m, then the burden of the cable alone is approximately 15 V A. As the burden of the DSE controller is 0.5 V A, then a CT with a rating of at least 15 + 0.5 V = 15.5 V A must be used.

If 2.5 mm<sup>2</sup> cables are used over the same distance of 20 m, then the burden of the cable on the CT is approximately 7 V A. CT's required in this instance is at least 7.5 V A (7 + 0.5).

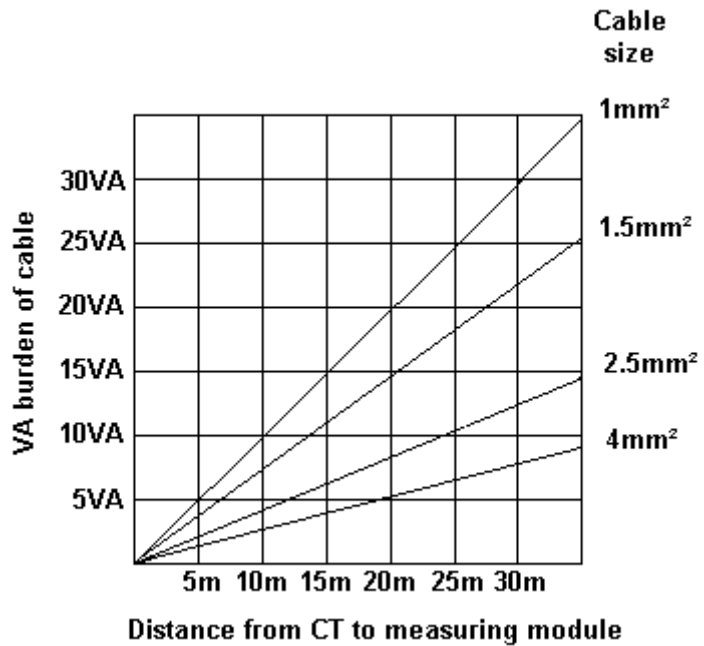

### 2.6.2 CT POLARITY

**NOTE:** Take care to ensure correct polarity of the CT primary as shown above. If in doubt, check with the CT supplier.

Take care to ensure the correct polarity of the CTs. Incorrect CT orientation leads to negative kW readings when the set is supplying power. Take note that paper stick-on labels on CTs that show the orientation are often incorrectly placed on the CT (!). It is more reliable to use the labelling in the case moulding as an indicator to orientation (if available).

To test orientation, run the generator in island mode (not in parallel with any other supply) and load the generator to around 10% of the set rating. Ensure the DSE module shows positive kW for all three individual phase readings.

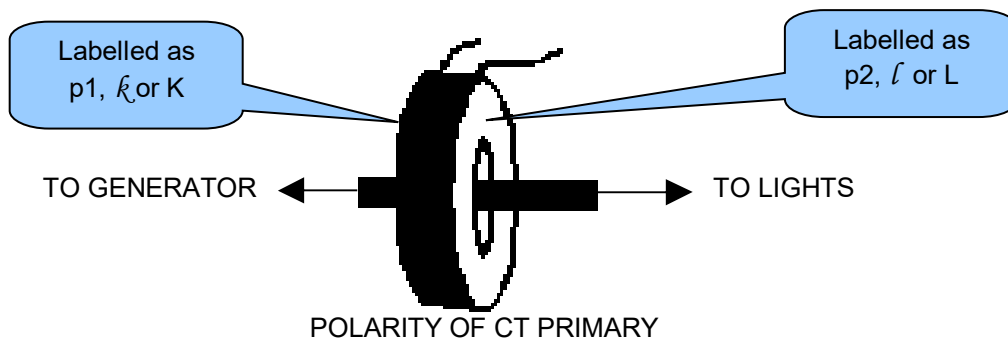

### 2.6.3 CT PHASING

Take particular care that the CTs are connected to the correct phases. For instance, ensure that the CT on phase 1 is connected to the terminal on the DSE module intended for connection to the CT for phase 1.

Additionally ensure that the voltage sensing for phase 1 is actually connected to generator phase 1. Incorrect connection of the phases as described above results in incorrect power factor (PF) measurements, which in turn results in incorrect kW measurements.

One way to check for this is to make use of a single-phase load. Place the load on each phase in turn, run the generator and ensure the kW value appears in the correct phase. For instance if the load is connected to phase 3, ensure the kW figure appears in phase 3 display and not in the display for phase 1 or 2.

### 2.6.4 CT CLASS

Ensure the correct CT type is chosen. For instance if the DSE module is providing overcurrent protection, ensure the CT is capable of measuring the overload level required to be protected against, and at the accuracy level required.

For instance, this may mean fitting a protection class CT (P10 type) to maintain high accuracy while the CT is measuring overload currents.

Conversely, if the DSE module is using the CT for instrumentation only (current protection is disabled or not fitted to the controller) then measurement class CTs can be used. Again, bear in mind the accuracy required. The DSE module is accurate to better than 1% of the full-scale current reading. To maintain this accuracy fit Class 0.5 or Class 1 CTs.

Check with the CT manufacturer for further advice on selecting the CTs.

## 2.7 INPUTS

### 2.7.1 DIGITAL INPUTS

Description	Specification
Number	12 Configurable negative or positive switching inputs in banks of 3 through PC Software
Arrangement	Contact between input terminal and the module's plant supply negative or positive terminal.
Low level threshold	3.2V minimum
High level threshold	8.1V maximum
Maximum input voltage	+60V DC with respect to module's plant supply negative terminal
Minimum input voltage	-2V DC with respect to module's plant supply negative terminal
Contact wetting current	7mA typical
Open circuit voltage	12V typical for negative activation. 0V typical for positive activation.

## 2.8 OUTPUTS

 **NOTE: Refer to Breaker Control Training Document (DSE part 056-022) for further details on configuring and control different type of load switching devices.**

There are twelve outputs fitted to the controller

### 2.8.1 CONFIGURABLE OUTPUTS A & E

Description	Specification
Number	2
Type	Fully configurable normally closed volt-free contacts.
Rating	8A resistive at 250V AC

### 2.8.2 CONFIGURABLE OUTPUTS B & F

Description	Specification
Number	2
Type	Fully configurable normally open volt-free contacts.
Rating	8A resistive at 250V AC

### 2.8.3 CONFIGURABLE OUTPUTS C & D

Description	Specification
Number	2
Type	Fully configurable volt-free changeover contacts.
Rating	8A resistive at 250V AC

### 2.8.4 CONFIGURABLE OUTPUTS G, H, I, J, K & L

Description	Specification
Number	6
Type	Fully configurable, supplied from DC positive terminal 2
Rating	2 A resistive continuous at 35 V

## 2.9 COMMUNICATION PORTS

Description	Specification
USB Port	USB2.0 Device for connection to PC running DSE configuration suite only Max distance 6m (yards)
Serial Communication	RS232 and RS485 are both fitted but provide independent operation
RS232 Serial port	Non – Isolated port Max Baud rate 115200 baud subject to S/W TX, RX, RTS, CTS, DSR, DTR, DCD Male 9 way D type connector Max distance 15m (50 feet)
RS485 Serial port	Isolated Data connection 2 wire + common Half Duplex Data direction control for Transmit (by s/w protocol) Max Baud Rate 115200 External termination required (120Ω) Max common mode offset 70V (on board protection transorb) Max distance 1.2km (¾ mile)



## Specifications

### 2.9.1.2 RS232

The RS232 port on the controller supports the Modbus RTU protocol. The Gencomm register table for the controller is available upon request from the DSE Technical Support Department.

RS232 is for short distance communication (max 15m) and is typically used to connect the controller to a telephone or GSM modem for more remote communications.

Many PCs are not fitted with an internal RS232 serial port. DSE DOES NOT recommend the use of USB to RS232 converters but can recommend PC add-ons to provide the computer with an RS232 port.

### 2.9.1.3 RECOMMENDED PC RS232 SERIAL PORT ADD-ONS

Remember to check these parts are suitable for your PC. Consult your PC supplier for further advice.

- Brainboxes PM143 PCMCIA RS232 card (for laptop PCs)
- Brainboxes VX-001 Express Card RS232 (for laptops and nettops PCs)
- Brainboxes UC246 PCI RS232 card (for desktop PCs)
- Brainboxes PX-246 PCI Express 1 Port RS232 1 x 9 Pin (for desktop PCs)



Supplier:

**Brainboxes**

**Tel:** +44 (0)151 220 2500

**Web:** <http://www.brainboxes.com>

**Email:** Sales: [sales@brainboxes.com](mailto:sales@brainboxes.com)

**NB** DSE Have no business tie to Brainboxes. Over many years, our own engineers have used these products and are happy to recommend them.



#### 2.9.1.4 RECOMMENDED EXTERNAL MODEMS

**NOTE: For GSM modems a SIM card is required, supplied by your GSM network provider**

- Multitech Global Modem – MultiModem ZBA (PSTN)  
DSE Part Number 020-252  
(Contact DSE Sales for details of localisation kits for these modems)
- Sierra Fastrak Xtend GSM modem kit (PSU, Antenna and modem)\*  
DSE Part number 0830-001-01



- For SMS only, a 'normal' voice SIM card is required. This enables the controller to send SMS messages to designated mobile phones upon status and alarm conditions.
- For a data connection to a PC running the DSE Configuration Suite software, a 'special' CSD (Circuit Switched Data) SIM card is required in order for the modem to answer an incoming data call. Many 'pay as you go' services do not provide a CSD (Circuit Switched Data) SIM card.

### 2.9.1.5 RS485

**NOTE: For a single module to PC connection and distances up to 6m (8yds) the USB connection method is more suitable and provides for a lower cost alternative to RS485 (which is more suited to longer distance connections).**

The RS485 port on the series controller supports the Modbus RTU protocol. The DSE Gencomm register table for the controller is available upon request from the DSE Technical Support Department.

RS485 is used for point-to-point cable connection of more than one device (maximum 32 devices) and allows for connection to PCs, PLCs and Building Management Systems (to name just a few devices).

One advantage of the RS485 interface is the large distance specification (1.2km when using Belden 9841 (or equivalent) cable. This allows for a large distance between the module and a PC running the DSE Configuration Suite software. The operator is then able to control the module, selecting operating modes, etc.

The various operating parameters (such as output volts, currents, etc.) of the remote ATS can be viewed or changed.

### 2.9.1.6 RECOMMENDED PC RS485 SERIAL PORT ADD-ONS

Remember to check these parts are suitable for your PC. Consult your PC supplier for further advice.

- Brainboxes PM154 PCMCIA RS485 card (for laptops PCs)  
Set to 'Half Duplex, Autogating" with 'CTS True' set to 'enabled'
- Brainboxes VX-023 ExpressCard 1 Port RS422/485 (for laptops and nettop PCs)
- Brainboxes UC320 PCI Velocity RS485 card (for desktop PCs)  
Set to 'Half Duplex, Autogating" with 'CTS True' set to 'enabled'
- Brainboxes PX-324 PCI Express 1 Port RS422/485 (for desktop PCs)



Supplier:

**Brainboxes**

**Tel:** +44 (0)151 220 2500

**Web:** <http://www.brainboxes.com>

**Email:** Sales: [sales@brainboxes.com](mailto:sales@brainboxes.com)

NB DSE have no business tie to Brainboxes. Over many years,our own engineers have used these products and are happy to recommend them.

## 2.9.2 DSENET® FOR EXPANSION MODULES

**NOTE:** As a termination resistor is internally fitted to the host controller, the host controller must be the ‘first’ unit on the DSENet®. A termination resistor **MUST** be fitted to the ‘last’ unit on the DSENet®. For connection details, you are referred to the section entitled ‘typical wiring diagram’ elsewhere in this document.

DSENet® is the interconnection cable between the host controller and the expansion module(s) and must not be connect to any device other than DSE equipment designed for connection to the DSENet®

Description	Specification
Cable type	Two core screened twisted pair
Cable characteristic impedance	120Ω
Recommended cable	Belden 9841 Belden 9271
Maximum cable length	1200m (¾ mile) when using Belden 9841 or direct equivalent. 600m (666 yds) when using Belden 9271 or direct equivalent.
DSENet® topology	“Daisy Chain” Bus with no stubs (spurs)
DSENet® termination	120Ω. Fitted internally to host controller. Must be fitted externally to the ‘last’ expansion module by the customer.
Maximum expansion modules	Total 6 devices made up of DSE2130 (up to 2), DSE2157 (up to 2), DSE2548 (up to 2)  This gives the possibility of : Maximum 16 additional inputs (DSE2130) Maximum 20 additional relay outputs (DSE2157) Maximum 20 additional LED indicators (DSE2548)

## 2.10 ADDING AN EXTERNAL SOUNDER TO THE APPLICATION

When an external alarm or indicator is required, this can be achieved by using the DSE Configuration Suite PC software to configure an auxiliary output for “Audible Alarm”, and by configuring an auxiliary input for “Alarm Mute” (if required).

The audible alarm output activates and de-activates at the same time as the module’s internal sounder. The Alarm mute input and internal alarm mute button activate ‘in parallel’ with each other. Either signal mutes both the internal sounder and audible alarm output.

Example of configuration to achieve external sounder with external alarm mute button:

The screenshot shows two configuration panels from the DSE Configuration Suite software. The top panel, titled 'Outputs', has an 'Output' dropdown menu set to 'Audible Alarm' and a secondary dropdown menu set to 'Energise'. The bottom panel, titled 'Digital Input', has a 'Function' dropdown set to 'Alarm Mute', a 'Polarity' dropdown set to 'Close to Activate', and an 'Activation Delay' slider set to '0s'.

## 2.11 DIMENSIONS AND MOUNTING

### 2.11.1 DIMENSIONS

240.0 mm x 181.1 mm x 41.7 mm  
(9.4 " x 7.1 " x 1.6 ")

### 2.11.2 PANEL CUTOUT

220 mm x 160 mm  
(8.7 " x 6.3 ")

### 2.11.3 WEIGHT

0.7 kg  
(1.4 lb)

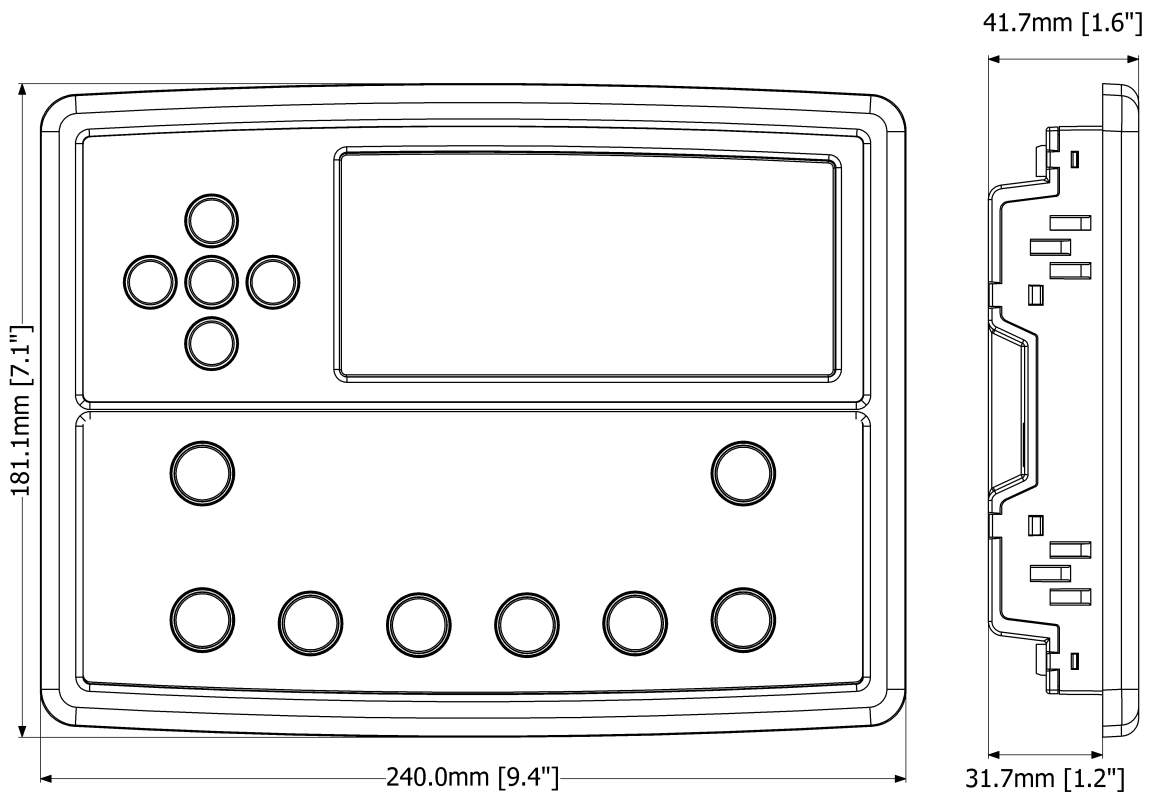

#### 2.11.4 FIXING CLIPS

**▲ NOTE:** In conditions of excessive vibration, mount the module on suitable anti-vibration mountings.

The module is held into the panel fascia using the supplied fixing clips.

- Withdraw the fixing clip screw (turn anticlockwise) until only the pointed end is protruding from the clip.
- Insert the three 'prongs' of the fixing clip into the slots in the side of the module case.
- Pull the fixing clip backwards (towards the back of the module) ensuring all three prongs of the clip are inside their allotted slots.
- Turn the fixing clip screws clockwise until they make contact with the panel fascia.
- Turn the screws a little more to secure the module into the panel fascia. Care must be taken not to over tighten the fixing clip screws.

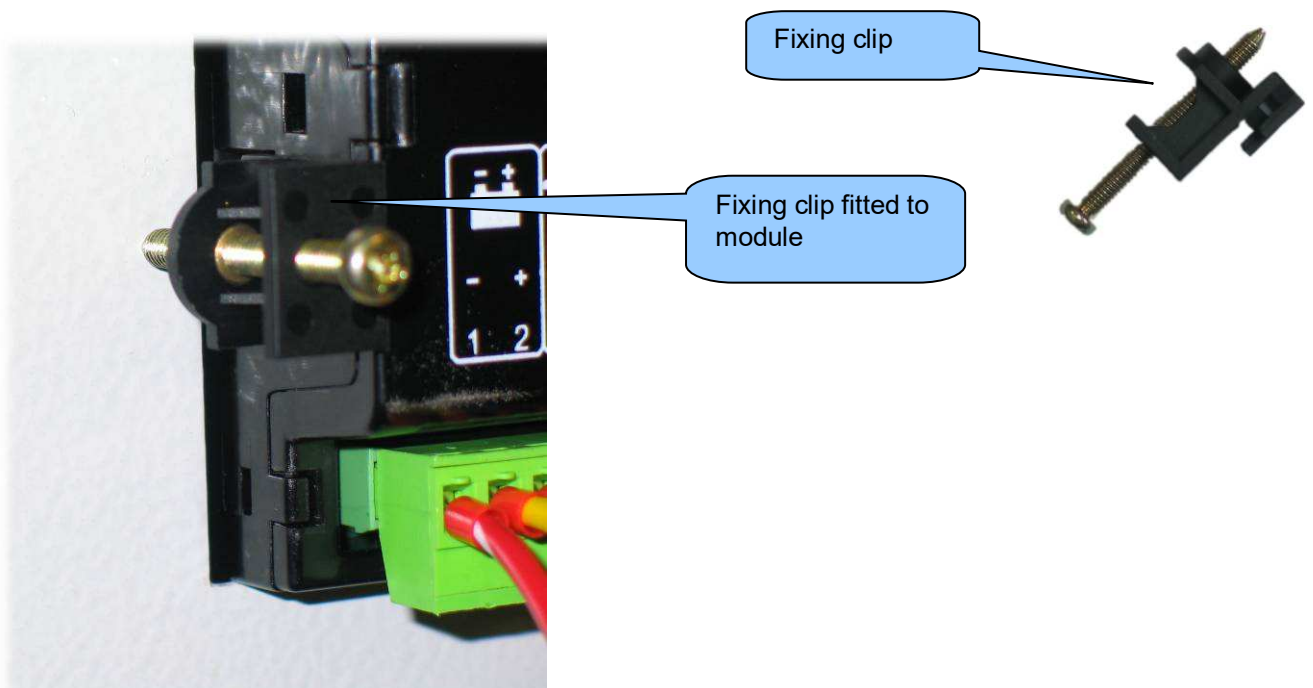

### 2.11.5 CABLE TIE FIXING POINTS

Integral cable tie fixing points are included on the rear of the module's case to aid wiring. This additionally provides strain relief to the cable loom by removing the weight of the loom from the screw connectors, thus reducing the chance of future connection failures. Care is to be taken not to over tighten the cable tie (for instance with cable tie tools) to prevent the risk of damage to the module case.

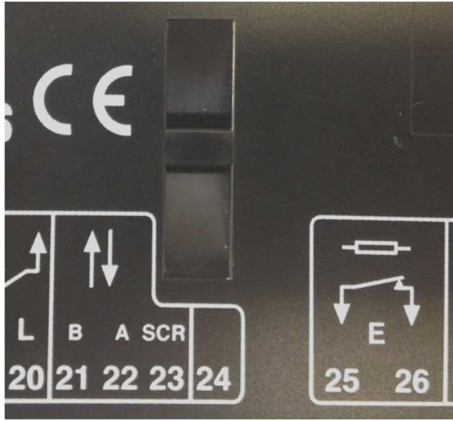

Cable tie fixing point

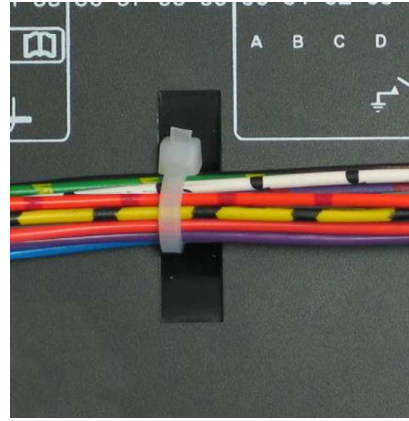

With cable and tie in place

### 2.11.6 SILICON SEALING GASKET

The supplied silicon gasket provides improved sealing between module and the panel fascia. The gasket is fitted to the module before installation into the panel fascia. Take care to ensure the gasket is correctly fitted to the module to maintain the integrity of the seal.

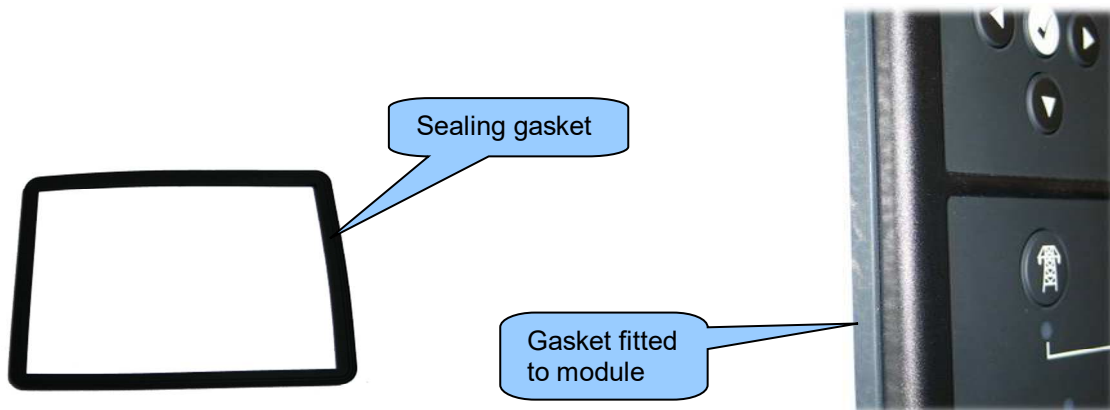

**2.11.8 APPLICABLE STANDARDS**

<b>Standard</b>	<b>Description</b>
<b>BS 4884-1</b>	This document conforms to BS4884-1 1992 Specification for presentation of essential information.
<b>BS 4884-2</b>	This document conforms to BS4884-2 1993 Guide to content
<b>BS 4884-3</b>	This document conforms to BS4884-3 1993 Guide to presentation
<b>BS EN 60068-2-1</b> (Minimum temperature)	-30 °C (-22 °F)
<b>BS EN 60068-2-2</b> (Maximum temperature)	+70 °C (158 °F)
<b>BS EN 60950</b>	Safety of information technology equipment, including electrical business equipment
<b>BS EN 61000-6-2</b>	EMC Generic Immunity Standard (Industrial)
<b>BS EN 61000-6-4</b>	EMC Generic Emission Standard (Industrial)
<b>BS EN 60529</b> (Degrees of protection provided by enclosures)	IP65 (front of module when installed into the control panel with the optional sealing gasket) IP42 (front of module when installed into the control panel WITHOUT being sealed to the panel)
<b>UL508</b> <b>NEMA rating</b> (Approximate)	12 (Front of module when installed into the control panel with the supplied sealing gasket). 2 (Front of module when installed into the control panel WITHOUT being sealed to the panel)
<b>IEEE C37.2</b> (Standard Electrical Power System Device Function Numbers and Contact Designations)	<p>Under the scope of IEEE 37.2, <i>function numbers can also be used to represent functions in microprocessor devices and software programs.</i> The controller is device number 11L-8000 (Multifunction device protecting Line (generator) –module).</p> <p>As the module is configurable by the generator OEM, the functions covered by the module vary. Under the module’s factory configuration, the device numbers included within the module are :</p> <ul style="list-style-type: none"> <li>2 – Time Delay Starting Or Closing Relay</li> <li>3 – Checking Or Interlocking Relay</li> <li>8 – Control Power Disconnecting Device</li> <li>11 – Multifunction Device</li> <li>23 – Temperature control device (<b>USING EXPANSION MODULE</b>)</li> <li>26 – Apparatus thermal device (<b>USING EXPANSION MODULE</b>)</li> <li>27AC – AC Undervoltage Relay</li> <li>27DC – DC Undervoltage Relay</li> <li>29 – Isolating Contactor Or Switch</li> <li>30 – Annunciator Relay</li> <li>37 – Undercurrent Or Underpower Relay (<b>USING INTERNAL PLC EDITOR</b>)</li> <li>42 – Running Circuit Breaker</li> <li>44 – Unit sequence relay</li> <li>48 – Incomplete Sequence Relay</li> </ul>

Continued overleaf...

Specifications

Standard	Description
<b>IEEE C37.2</b> (Standard Electrical Power System Device Function Numbers and Contact Designations)	Continued...  49 – Machine Or Transformer Thermal Relay ( <b>USING EXPANSION MODULE</b> ) 50 – Instantaneous Overcurrent Relay 52 – AC Circuit Breaker 55 – Power Factor Relay ( <b>USING INTERNAL PLC EDITOR</b> ) 59AC – AC Overvoltage Relay 59DC – DC Overvoltage Relay 62 – Time Delay Stopping Or Opening Relay 63 – Pressure Switch 71 – Level Switch 74 – Alarm Relay 78 – Phase-angle measuring relay 79 – Reclosing relay ( <b>USING INTERNAL PLC EDITOR</b> ) 81 – Frequency Relay 83 – Automatic Selective Control Or Transfer Relay 86 – Lockout Relay

In line with our policy of continual development, Deep Sea Electronics, reserve the right to change specification without notice.



## 2.11.9 ENCLOSURE CLASSIFICATIONS

### 2.11.9.1 IP CLASSIFICATIONS

The modules specification under **BS EN 60529** Degrees of protection provided by enclosures

**IP65** (Front of module when module is installed into the control panel with the optional sealing gasket).

**IP42** (front of module when module is installed into the control panel WITHOUT being sealed to the panel)

First Digit Protection against contact and ingress of solid objects	Second Digit Protection against ingress of water
0 No protection	0 No protection
1 Protected against ingress solid objects with a diameter of more than 50 mm. No protection against deliberate access, e.g. with a hand, but large surfaces of the body are prevented from approach.	1 Protection against dripping water falling vertically. No harmful effect must be produced (vertically falling drops).
2 Protected against penetration by solid objects with a diameter of more than 12 mm. Fingers or similar objects prevented from approach.	2 Protection against dripping water falling vertically. There must be no harmful effect when the equipment (enclosure) is tilted at an angle up to 15° from its normal position (drops falling at an angle).
3 Protected against ingress of solid objects with a diameter of more than 2.5 mm. Tools, wires etc. with a thickness of more than 2.5 mm are prevented from approach.	3 Protection against water falling at any angle up to 60° from the vertical. There must be no harmful effect (spray water).
4 Protected against ingress of solid objects with a diameter of more than 1 mm. Tools, wires etc. with a thickness of more than 1 mm are prevented from approach.	4 Protection against water splashed against the equipment (enclosure) from any direction. There must be no harmful effect (splashing water).
5 Protected against harmful dust deposits. Ingress of dust is not totally prevented but the dust must not enter in sufficient quantity to interface with satisfactory operation of the equipment. Complete protection against contact.	5 Protection against water projected from a nozzle against the equipment (enclosure) from any direction. There must be no harmful effect (water jet).
6 Protection against ingress of dust (dust tight). Complete protection against contact.	6 Protection against heavy seas or powerful water jets. Water must not enter the equipment (enclosure) in harmful quantities (splashing over).

**2.11.9.2 NEMA CLASSIFICATIONS**

The modules NEMA Rating (Approximate)

<b>12</b> (Front of module when module is installed into the control panel with the optional sealing gasket).
<b>2</b> (front of module when module is installed into the control panel WITHOUT being sealed to the panel)

 **NOTE: There is no direct equivalence between IP / NEMA ratings. IP figures shown are approximate only.**

<b>1</b> <b>IP30</b>	Provides a degree of protection against contact with the enclosure equipment and against a limited amount of falling dirt.
<b>2</b> <b>IP31</b>	Provides a degree of protection against limited amounts of falling water and dirt.
<b>3</b> <b>IP64</b>	Provides a degree of protection against windblown dust, rain and sleet; undamaged by the formation of ice on the enclosure.
<b>3R</b> <b>IP32</b>	Provides a degree of protection against rain and sleet;; undamaged by the formation of ice on the enclosure.
<b>4 (X)</b> <b>IP66</b>	Provides a degree of protection against splashing water, windblown dust and rain, hose directed water; undamaged by the formation of ice on the enclosure. (Resist corrosion).
<b>12/12K</b> <b>IP65</b>	Provides a degree of protection against dust, falling dirt and dripping non corrosive liquids.
<b>13</b> <b>IP65</b>	Provides a degree of protection against dust and spraying of water, oil and non corrosive coolants.

### 3 INSTALLATION

The module is designed to be mounted on the panel fascia. For dimension and mounting details, see the section entitled *Specification, Dimension and mounting* elsewhere in this document.

#### 3.1 TERMINAL DESCRIPTION

To aid user connection, icons are used on the rear of the module to help identify terminal functions. An example of this is shown below.

**NOTE:** Availability of some terminals depends upon module version. Full details are given in the section entitled *Terminal Description* elsewhere in this manual.

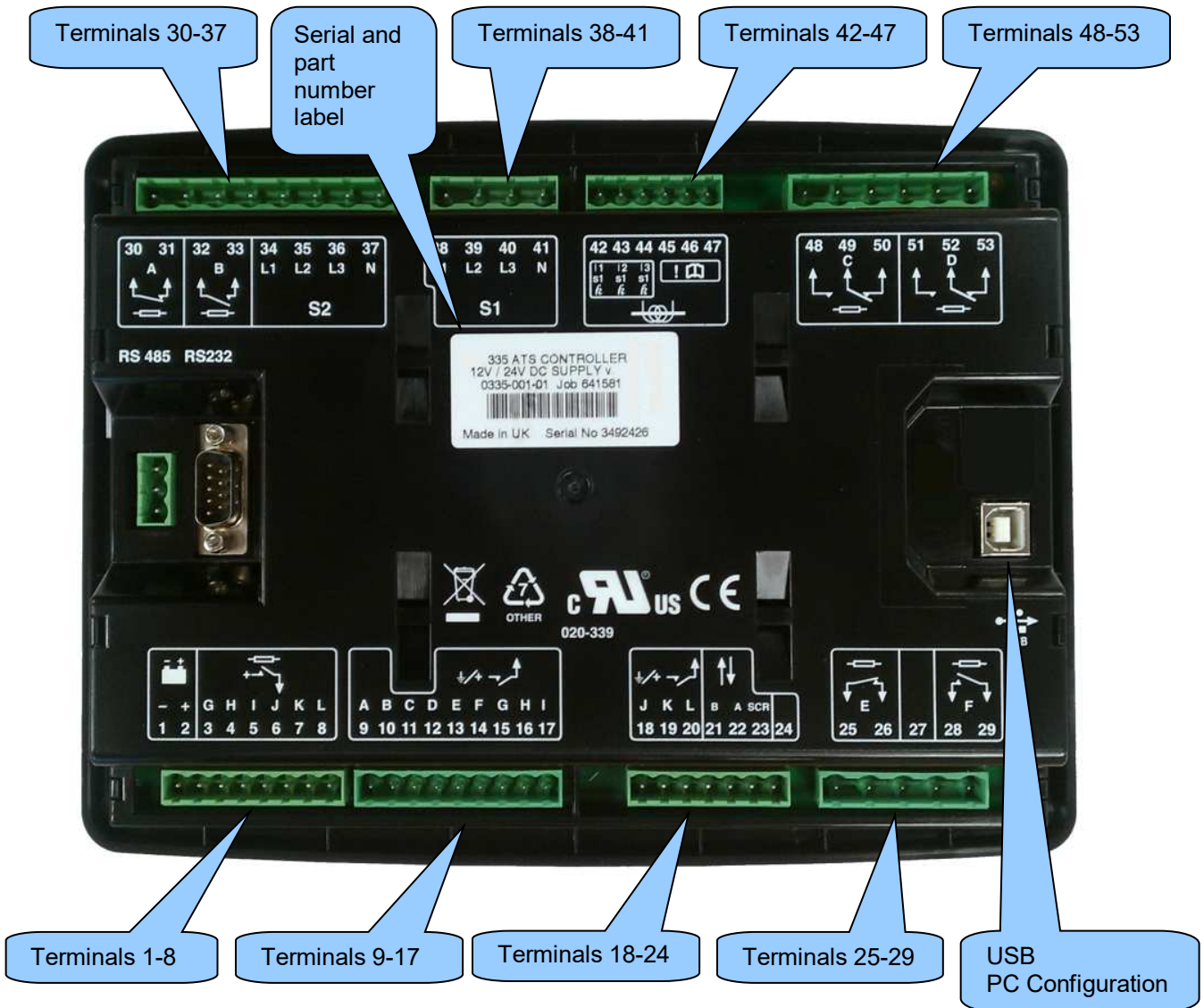

### 3.1.1 DC SUPPLY, OUTPUTS G-L

 **NOTE: For further details of module configuration, refer to DSE Publication: 057-237 DSE335 Configuration Software Manual.**

Pin No	Description	Cable Size	Notes
1	DC Plant Supply Input (Negative)	2.5 mm <sup>2</sup> AWG 13	
2	DC Plant Supply Input (Positive)	2.5 mm <sup>2</sup> AWG 13	Supplies the module and DC Outputs A, B, C, D, E & F
3	Output relay G	1.0 mm <sup>2</sup> AWG 18	Plant Supply Positive from terminal 2. 2 Amp rated.
4	Output relay H	1.0 mm <sup>2</sup> AWG 18	Plant Supply Positive from terminal 2. 2 Amp rated.
5	Output relay I	1.0 mm <sup>2</sup> AWG 18	Plant Supply Positive from terminal 2. 2 Amp rated.
6	Output relay J	1.0 mm <sup>2</sup> AWG 18	Plant Supply Positive from terminal 2. 2 Amp rated.
7	Output relay K	1.0 mm <sup>2</sup> AWG 18	Plant Supply Positive from terminal 2. 2 Amp rated.
8	Output relay L	1.0 mm <sup>2</sup> AWG 18	Plant Supply Positive from terminal 2. 2 Amp rated.

### 3.1.2 CONFIGURABLE DIGITAL INPUTS A-I

Pin No	Description	Cable Size	Notes
9	Configurable digital input A	0.5 mm <sup>2</sup> AWG 20	Switch to negative or positive depending on configuration
10	Configurable digital input B	0.5 mm <sup>2</sup> AWG 20	Switch to negative or positive depending on configuration
11	Configurable digital input C	0.5 mm <sup>2</sup> AWG 20	Switch to negative or positive depending on configuration
12	Configurable digital input D	0.5 mm <sup>2</sup> AWG 20	Switch to negative or positive depending on configuration
13	Configurable digital input E	0.5 mm <sup>2</sup> AWG 20	Switch to negative or positive depending on configuration
14	Configurable digital input F	0.5 mm <sup>2</sup> AWG 20	Switch to negative or positive depending on configuration
15	Configurable digital input G	0.5 mm <sup>2</sup> AWG 20	Switch to negative or positive depending on configuration
16	Configurable digital input H	0.5 mm <sup>2</sup> AWG 20	Switch to negative or positive depending on configuration
17	Configurable digital input I	0.5 mm <sup>2</sup> AWG 20	Switch to negative or positive depending on configuration

### 3.1.3 CONFIGURABLE DIGITAL INPUTS J-L, DSENET

 **NOTE: Terminal 24 is not used, do not connect.**

Pin No	Description	Cable Size	Notes
18	Configurable digital input J	0.5 mm <sup>2</sup> AWG 20	Switch to negative or positive depending on configuration
19	Configurable digital input K	0.5 mm <sup>2</sup> AWG 20	Switch to negative or positive depending on configuration
20	Configurable digital input L	0.5 mm <sup>2</sup> AWG 20	Switch to negative or positive depending on configuration
21	DSENet expansion B (+)	0.5 mm <sup>2</sup> AWG 20	Use only 120 Ω RS485 approved cable
22	DSENet expansion A (-)	0.5 mm <sup>2</sup> AWG 20	Use only 120 Ω RS485 approved cable
23	DSENet expansion SCR	0.5 mm <sup>2</sup> AWG 20	Use only 120 Ω RS485 approved cable

### 3.1.4 CONFIGURABLE VOLT-FREE OUTPUTS E & F

 **NOTE: Terminal 27 is not used, do not connect.**

Pin No.	Description	Cable Size	Notes
25	Output relay E	1.0 mm <sup>2</sup> AWG 18	Normally closed volt-free relay user configured (8 A resistive at 250 V AC rated)
26	Output relay E	1.0 mm <sup>2</sup> AWG 18	Normally closed volt-free relay user configured (8 A resistive at 250 V AC rated)
28	Output relay F	1.0 mm <sup>2</sup> AWG 18	Normally open volt-free relay user configured (8 A resistive at 250 V AC rated)
29	Output relay F	1.0 mm <sup>2</sup> AWG 18	Normally open volt-free relay user configured (8 A resistive at 250 V AC rated)

### 3.1.5 LOAD SWITCHING AND S2 VOLTAGE SENSING

 **NOTE: The above table describes connections to a three phase, four wire alternator. For alternative wiring topologies, please see the ALTERNATIVE AC TOPOLOGIES section of this manual.**

Pin No.	Description	Cable Size	Notes
30	Output relay A	1.0 mm <sup>2</sup> AWG 18	Normally configured to control S1 contactor coil (Recommend 10A fuse)
31	Output relay A	1.0 mm <sup>2</sup> AWG 18	Normally configured to control S1 contactor coil
32	Output relay B	1.0 mm <sup>2</sup> AWG 18	Normally configured to control S2 contactor coil (Recommend 10A fuse)
33	Output relay B	1.0 mm <sup>2</sup> AWG 18	Normally configured to control S2 contactor coil
34	S2 L1 (U) voltage monitoring	1.0 mm <sup>2</sup> AWG 18	Connect to S2 L1 (U) output (AC) (Recommend 2A fuse)
35	S2 L2 (V) voltage monitoring input	1.0 mm <sup>2</sup> AWG 18	Connect to S2 L2 (V) output (AC) (Recommend 2A fuse)
36	S2 L3 (W) voltage monitoring input	1.0 mm <sup>2</sup> AWG 18	Connect to S2 L3 (W) output (AC) (Recommend 2A fuse)
37	S2 Neutral (N) input	1.0 mm <sup>2</sup> AWG 18	Connect to S2 Neutral terminal (AC)

### 3.1.6 S1 VOLTAGE SENSING

**NOTE:** The above table describes connections to a three phase, four wire alternator. For alternative wiring topologies, please see the ALTERNATIVE AC TOPOLOGIES section of this manual.

Pin No.	Description	Cable Size	Notes
38	S1 L1 (R) voltage monitoring	1.0 mm <sup>2</sup> AWG 18	Connect to S1 L1 (R) incoming supply (AC) (Recommend 2A fuse)
39	S1 L2 (S) voltage monitoring	1.0 mm <sup>2</sup> AWG 18	Connect to S1 L1 (S) incoming supply (AC) (Recommend 2A fuse)
40	S1 L3 (T) voltage monitoring	1.0 mm <sup>2</sup> AWG 18	Connect to S1 L1 (T) incoming supply (AC) (Recommend 2A fuse)
41	S1 Neutral (N) input	1.0 mm <sup>2</sup> AWG 18	Connect to S1 N incoming supply (AC)

### 3.1.7 LOAD CURRENT TRANSFORMERS

**WARNING!** Do not disconnect this plug when the CTs are carrying current. Disconnection does open circuit the secondary of the C.T.'s and dangerous voltages may then develop. Always ensure the CTs are not carrying current and the CTs are short circuit connected before making or breaking connections to the module.

**NOTE:** The module has a burden of 0.5VA on the CT. Ensure the CT is rated for the burden of the controller, the cable length being used and any other equipment sharing the CT. If in doubt, consult your CT supplier.

Pin No.	Description	Cable Size	Notes
42	CT Secondary for Load L1	2.5 mm <sup>2</sup> AWG 13	Connect to s1 secondary of L1 monitoring CT
43	CT Secondary for Load L2	2.5 mm <sup>2</sup> AWG 13	Connect to s1 secondary of L2 monitoring CT
44	CT Secondary for Load L3	2.5 mm <sup>2</sup> AWG 13	Connect to s1 secondary of L3 monitoring CT
45	Not Used	N/A	
46	CT Common	2.5 mm <sup>2</sup> AWG 13	Connect to s2 secondary of all CT's

### 3.1.7.1 CT CONNECTIONS

p1,  $\kappa$  or K is the primary of the CT that 'points' towards the SUPPLY

p2,  $\ell$  or L is the primary of the CT that 'points' towards the LOAD

s1 is the secondary of the CT that connects to the DSE Module's input for the CT measuring

s2 is the secondary of the CT that must be commoned with the s2 connections of all the other CTs and connected to the CT common terminal of the module.

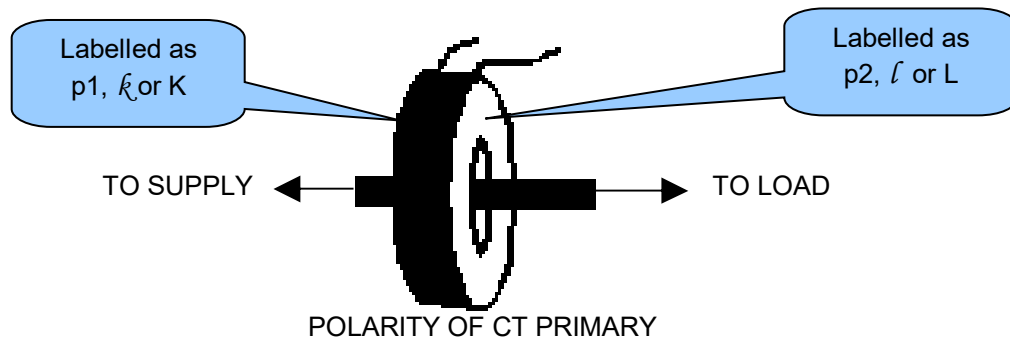

### 3.1.8 CONFIGURABLE VOLT-FREE CHANGEOVER OUTPUTS C & D

**NOTE:** For further details of module configuration, refer to DSE Publication: 057-237 *DSE335 Configuration Software Manual*.



Pin No.	Description	Cable Size	Notes
48	Output C Normally Open	1.0 mm <sup>2</sup> AWG 18	Volts free relay change-over relay user configured (8A resistive at 250V AC rated)
49	Output C Common	1.0 mm <sup>2</sup> AWG 18	
50	Output C Normally Closed	1.0 mm <sup>2</sup> AWG 18	
51	Output D Normally Open	1.0 mm <sup>2</sup> AWG 18	Volts free relay change-over relay user configured (8A resistive at 250V AC rated)
52	Output D Common	1.0 mm <sup>2</sup> AWG 18	
53	Output D Normally Closed	1.0 mm <sup>2</sup> AWG 18	

### 3.1.9 PC CONFIGURATION INTERFACE CONNECTOR

**NOTE:** For further details of module configuration, refer to DSE Publication: 057-237 *DSE335 Configuration Software Manual*.

**NOTE:** The USB connection cable between the PC and the module must not be extended beyond 6 m (20 feet). For distances over 6 m, it is possible to use a third party USB extender. Typically, they extend USB up to 50 m (55 yards). The supply and support of this type of equipment is outside the scope of Deep Sea Electronics PLC.

**CAUTION!:** Care must be taken not to overload the PC's USB system by connecting more than the recommended number of USB devices to the PC. For further information, consult the PC supplier.

Description	Cable Size	Notes
 <p>Socket for connection to PC with DSE Configuration Suite Software</p>	0.5 mm <sup>2</sup> AWG 20	<p>This is a standard USB type A to type B connector.</p> 



### 3.1.10 RS485 CONNECTOR

Pin No.	Notes
<b>A (-)</b>	Two core screened twisted pair cable. 120Ω impedance suitable for RS485 use.
<b>B (+)</b>	Recommended cable type - Belden 9841
<b>SCR</b>	Max distance 1200 m (1.2 km) when using Belden 9841 or direct equivalent.

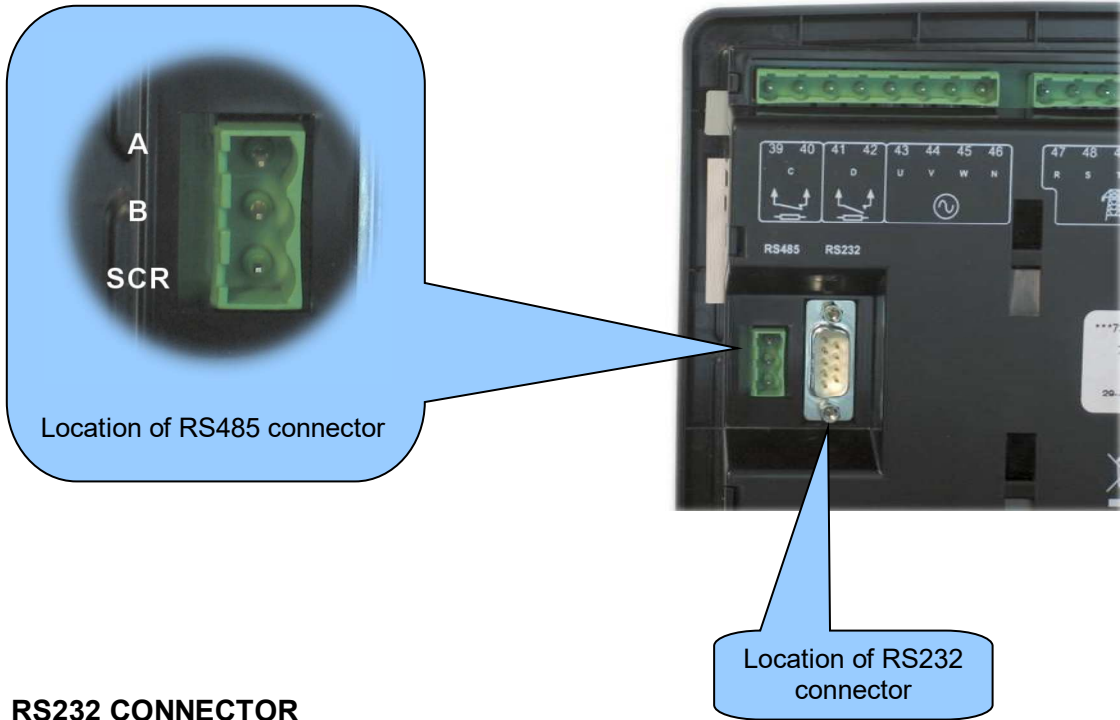

### 3.1.11 RS232 CONNECTOR

Pin No.	Notes
1	Received Line Signal Detector (Data Carrier Detect)
2	Received Data
3	Transmit Data
4	Data Terminal Ready
5	Signal Ground
6	Data Set Ready
7	Request To Send
8	Clear To Send
9	Ring Indicator

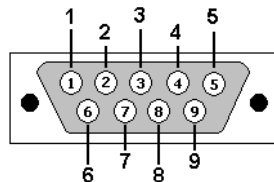

View looking into the male connector on the module

### 3.2 TYPICAL WIRING DIAGRAM

As every system has different requirements, these diagrams show only a typical system and do not intend to show a complete system.

Genset manufacturers and panel builders may use these diagrams as a starting point; however, refer to the completed system diagram provided by the system manufacturer for complete wiring detail.

Further wiring suggestions are available in the following DSE publications, available at [www.deepseapl.com](http://www.deepseapl.com).

DSE Part	Description
056-022	Breaker Control (Training guide)

 **NOTE: For further details of module configuration, refer to DSE Publication: 057-237 *DSE335 Configuration Software Manual*.**

The controller is factory configured to connect to a 3 phase, 4 wire Star connected alternator. This section details connections for alternative AC topologies. Ensure to configure the controller to suit the required topology.

3.2.1 DSE335 3 PHASE 4 WIRE

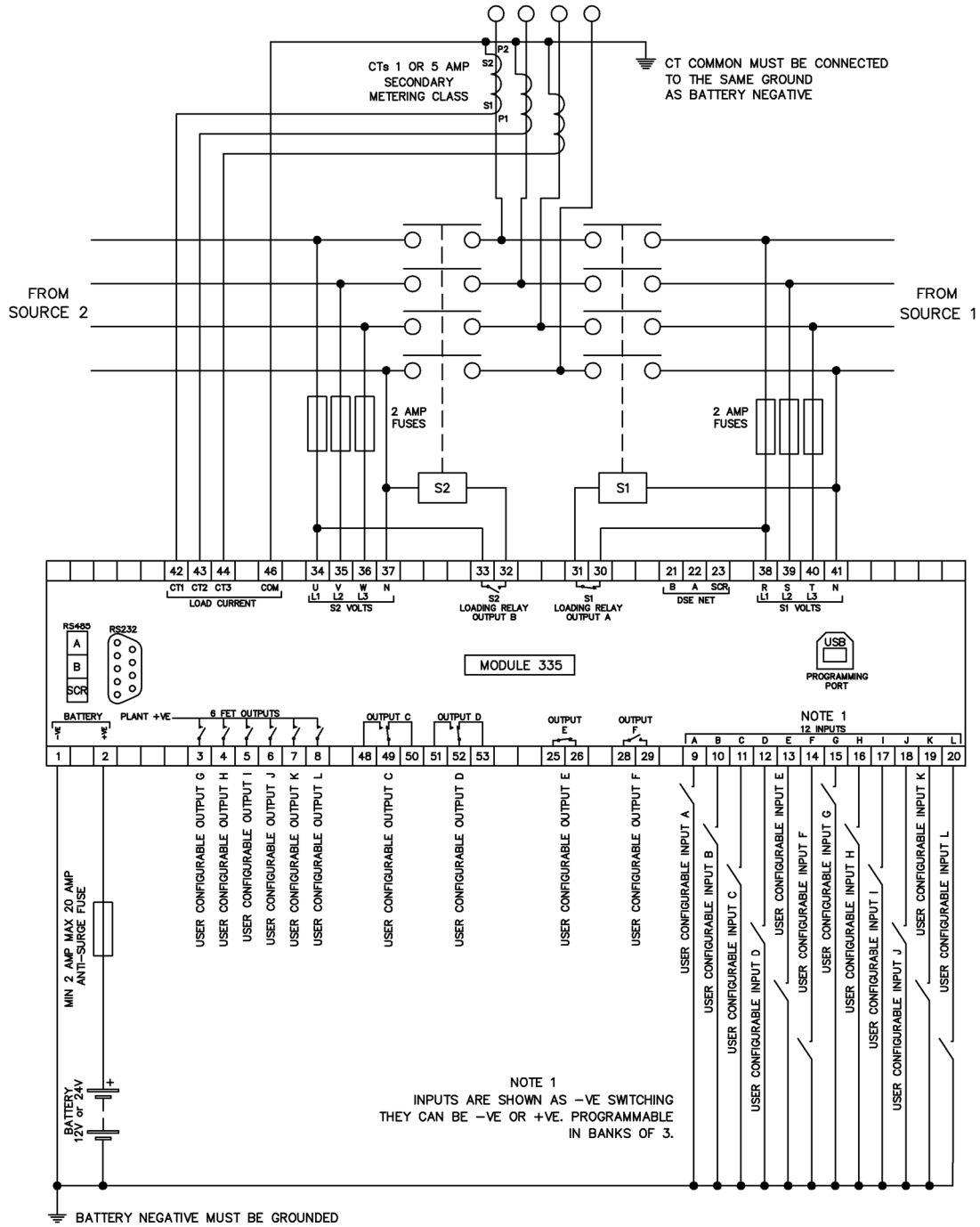

### 3.3 ALTERNATIVE TOPOLOGIES

#### 3.3.1 3 PHASE, 4 WIRE

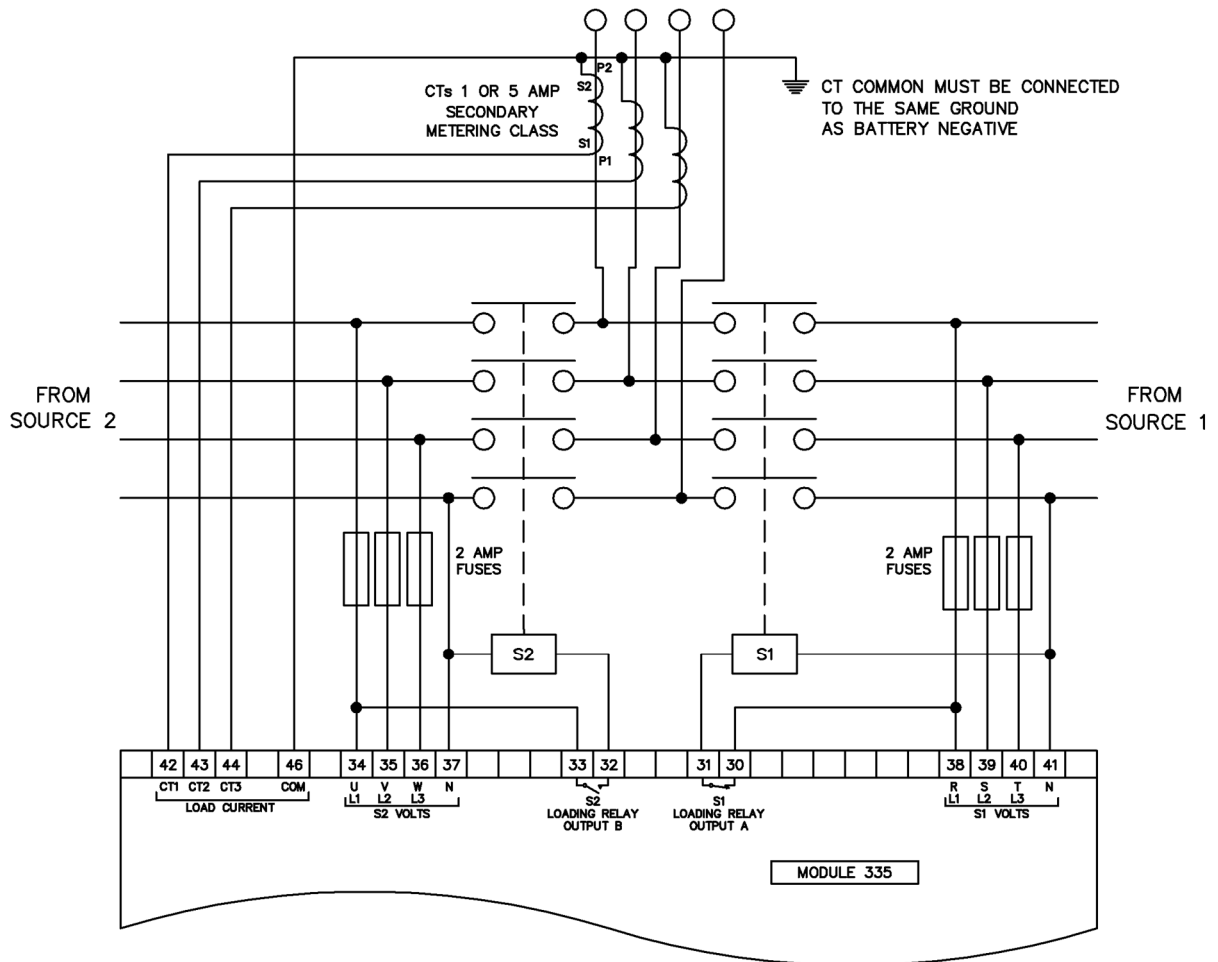

# Installation

## 3.3.2 3 PHASE 3 WIRE

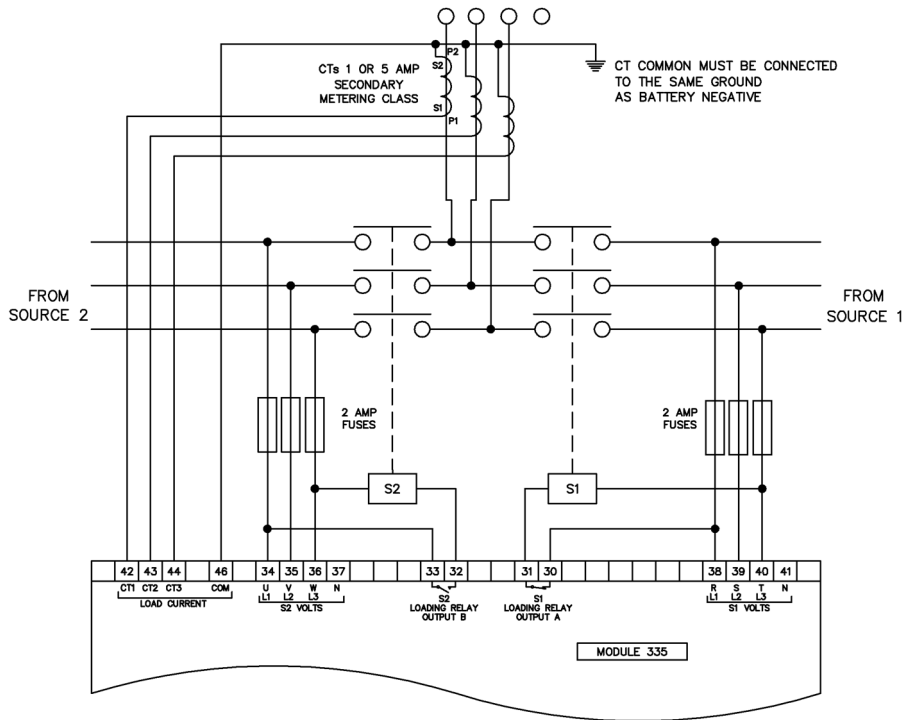

## 3.3.3 SINGLE PHASE

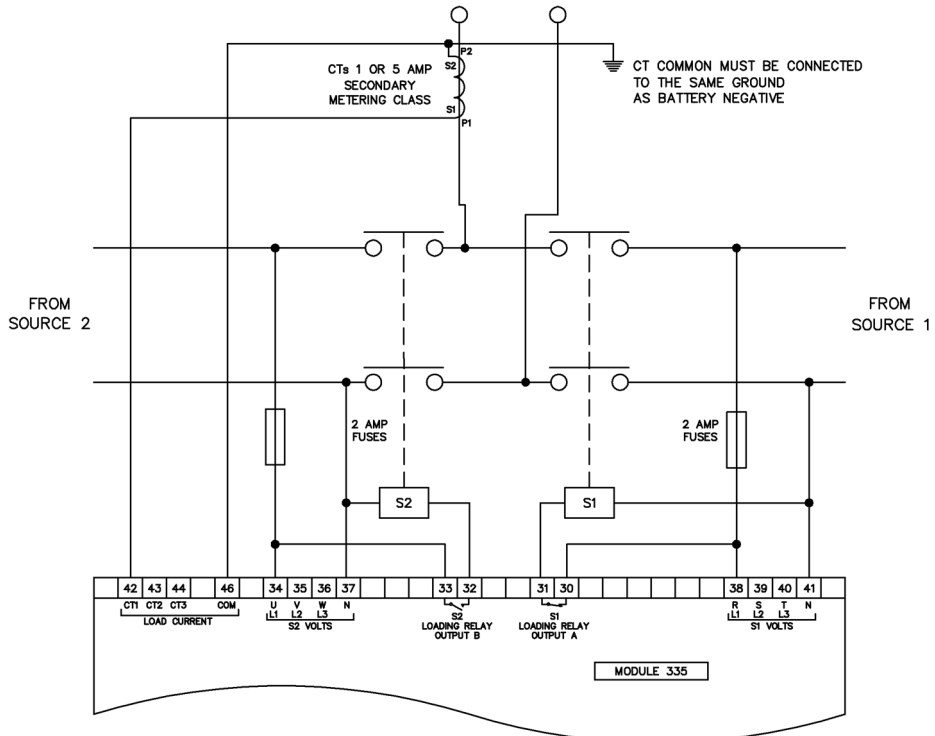

Installation

3.3.4 2 PHASE (L1 & L2) 3 WIRE

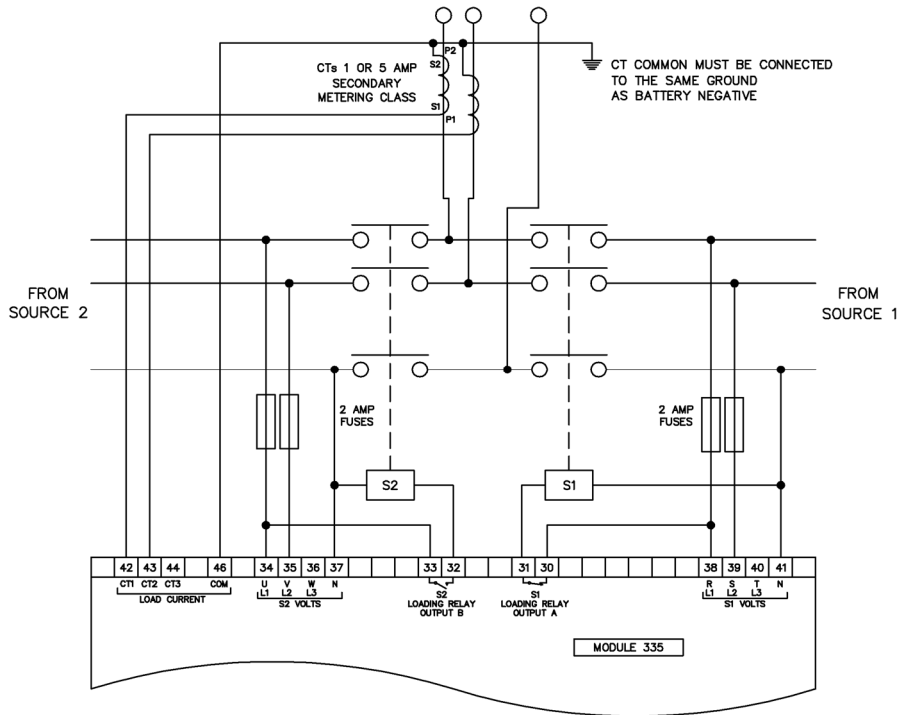

3.3.5 2 PHASE (L1 & L3) 3 WIRE

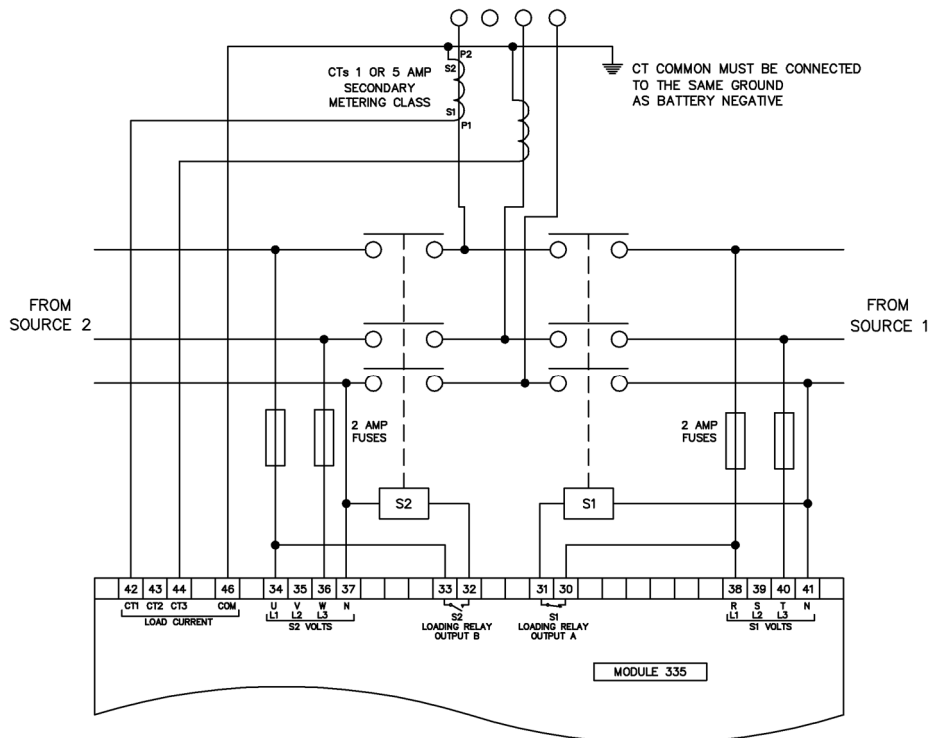

### 3.4 EARTH SYSTEMS

#### 3.4.1 NEGATIVE EARTH

The typical wiring diagrams located within this document show connections for a negative earth system (the battery negative connects to Earth)

#### 3.4.2 POSITIVE EARTH

When using a DSE module with a Positive Earth System (the battery positive connects to Earth), the following points must be followed:

- Follow the typical wiring diagram as normal for all sections EXCEPT the earth points
- All points shown as Earth on the typical wiring diagram must connect to BATTERY NEGATIVE (not earth).

#### 3.4.3 FLOATING EARTH

Where neither the battery positive nor battery negative terminals are connected to earth the following points must be followed

- Follow the typical wiring diagram as normal for all sections EXCEPT the earth points
- All points shown as Earth on the typical wiring diagram must connect to BATTERY NEGATIVE (not earth).

### 3.5 TYPICAL ARRANGEMENT OF DSENET®

Six (6) devices can be connected to the DSENet®, made up of the following devices :

Device	Max Number Supported
DSE2130 Input Expansion	2
DSE2157 Relay Output Expansion	2
DSE2548 LED Expansion	2



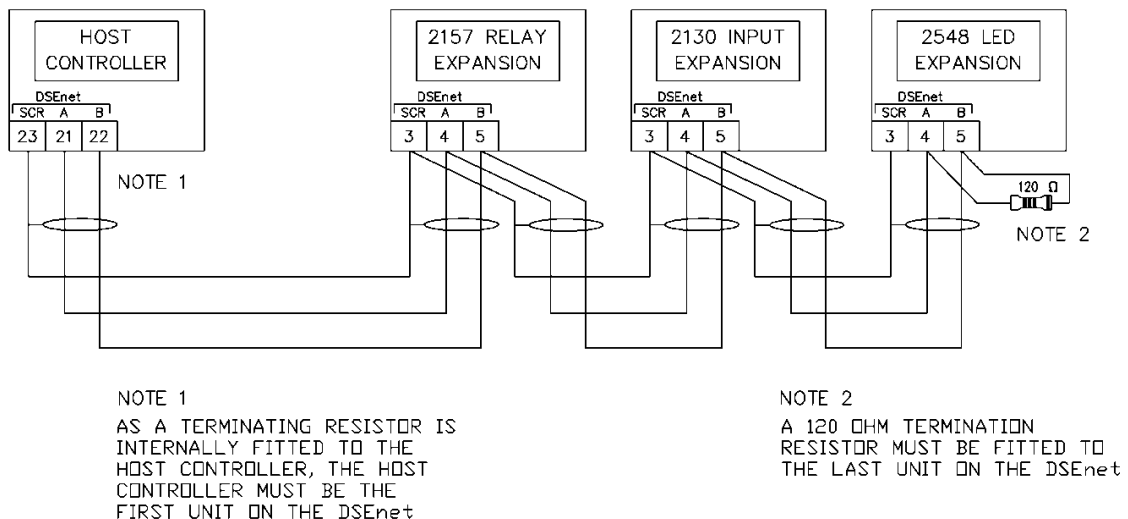





For part numbers of the expansion modules and their documentation, see section entitled *DSENet Expansion Modules* elsewhere in this manual.



## 4 DESCRIPTION OF CONTROLS

 **NOTE:** The following descriptions detail the sequences followed by a module containing the standard 'factory configuration'. Always refer to the configuration source for the exact sequences and timers observed by any particular module in the field.

 **CAUTION:** The module may instruct an engine start event due to external influences. Therefore, it is possible for the engine to start at any time without warning. Prior to performing any maintenance on the system, it is recommended that steps are taken to remove the battery and isolate supplies.







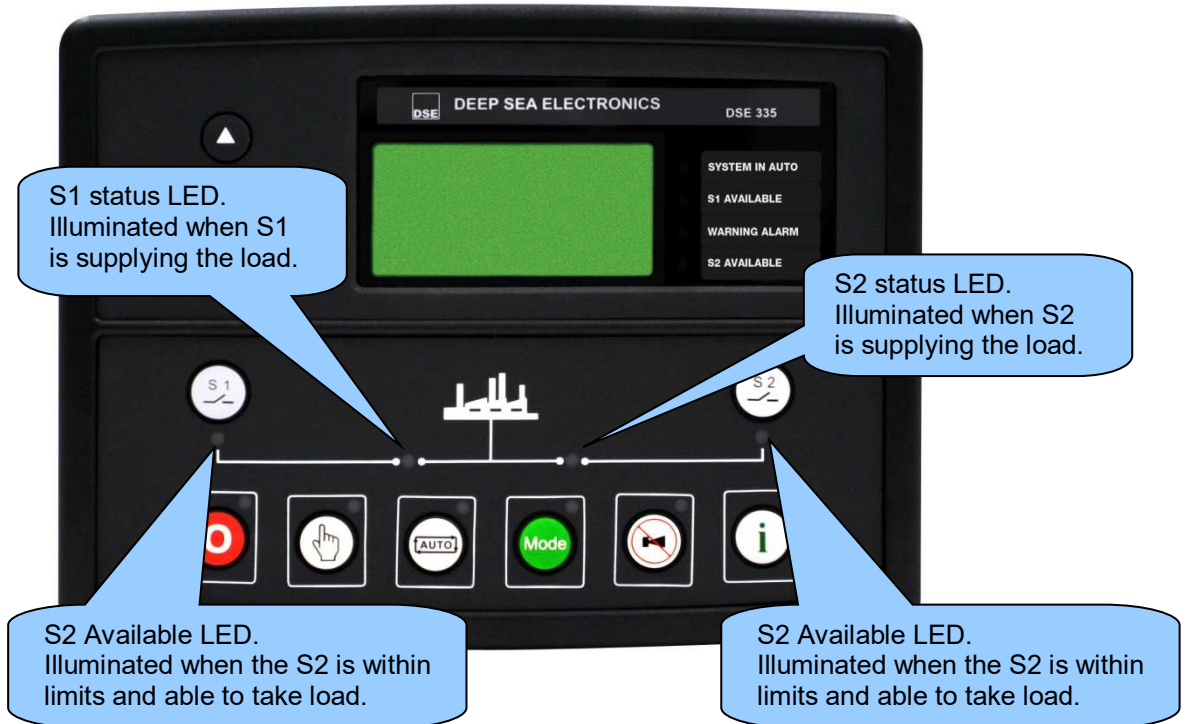
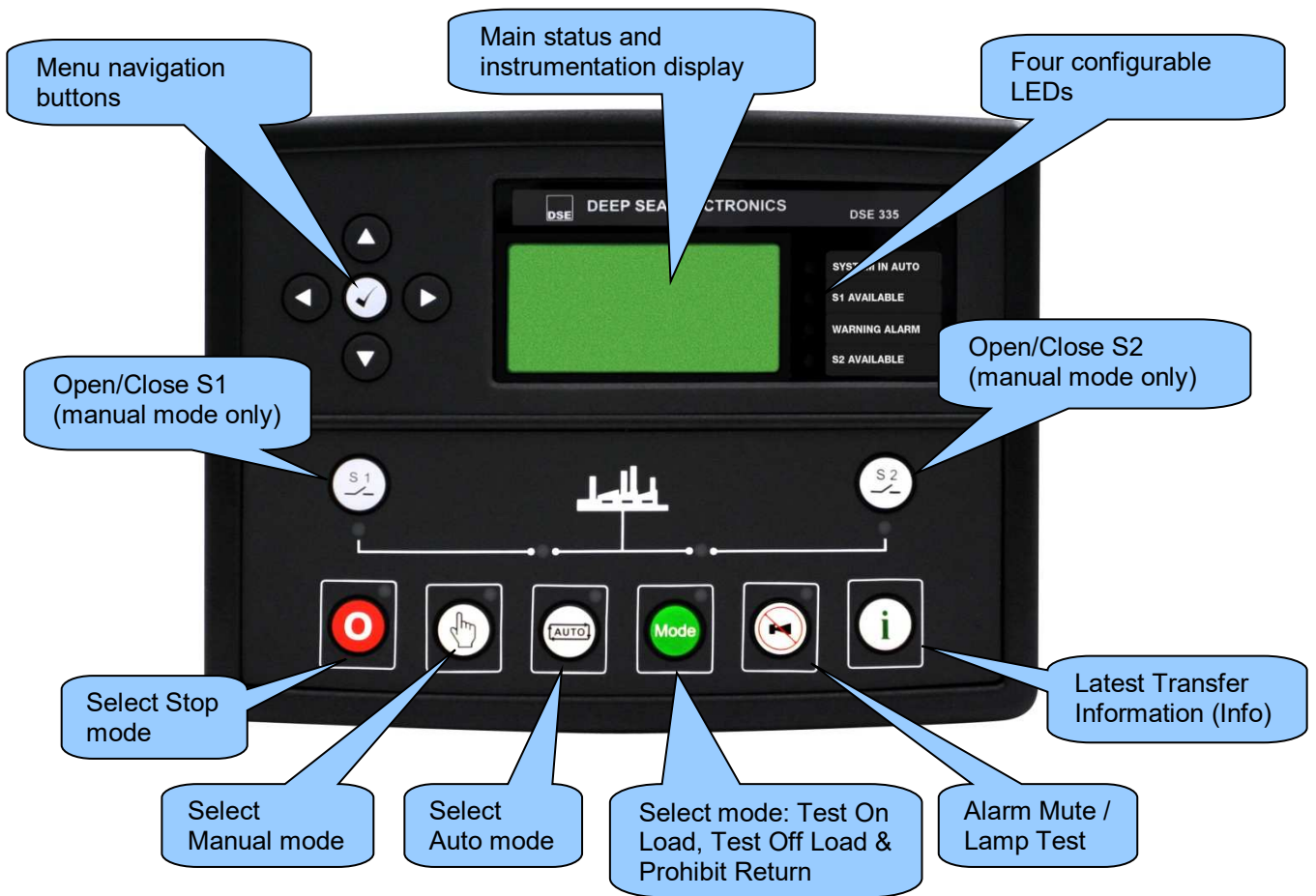

Control of the module is via push buttons mounted on the front of the module with  
*Start Inhibit/Reset* , *Manual* , *Auto* , *Mode* , *Alarm Mute* , *Latest Transfer Information* , *Close/Open S1*  and *Close/Open S2*  functions. For normal operation, these are the only controls which need to be operated. Details of their operation are provided later in this document.











Description of Controls



## 4.1 CONTROL PUSH-BUTTONS

Icon	Description
	<p><b>Stop / Reset</b></p> <p>This button places the module into its <i>Stop / Reset</i>  mode. This clears any alarm conditions for which the triggering criteria have been removed. If S2 is on load and the module is placed into Stop mode, the module automatically instructs the changeover device to unload the S2 source (<i>Close S2 Output</i> becomes inactive (if used)). If S2 is configured for a generator, the start signal given to the generator controller is also removed. If a <i>Remote Start</i> signal is present while operating in this mode, the remote start does <u>not</u> occur.</p>
	<p><b>Manual</b></p> <p>This button places the module into its <i>Manual</i>  mode to allow manual control of the ATS functions. This starts S2 when configured as a generator, and runs it off load.</p> <p>For further details, please see the more detailed description of 'Manual operation' elsewhere in this document.</p>
	<p><b>Auto</b></p> <p>This button places the module into its <i>Auto</i>  mode. This mode allows the module to control the function of S1 and S2 automatically. The module monitors the <i>remote start</i> input and S1 supply status and once a start request is made, a start request is given to S2 if configured to a generator and once available, placed on load.</p> <p>Upon removal of the starting signal, the module automatically transfers the load from S2 and remove the start signal to the generator observing the <i>return delay</i> timer and <i>cooling</i> timer as necessary. The module then awaits for the next start event.</p> <p>For further details, please see the more detailed description of 'Auto operation' elsewhere in this manual.</p>
	<p><b>Mode</b></p> <p>This button allows the user to cycle through different operating <i>Mode</i>  and press the <i>Tick</i>  to accept the mode change.</p> <p>The modes available are:</p> <p><i>Test On Load:</i> This mode allows the module to start and load S2 for test purposes.</p> <p><i>Test Off Load:</i> This mode allows the module to start S2 and leave off load for test purposes.</p> <p><i>Prohibit Return:</i> This mode is used to prevent the module from returning load the S1 until instructed.</p> <p>For further details, please see the more detailed description of 'Mode operation' elsewhere in this manual.</p>



Icon	Description
	<p><b>Mute / Lamp Test</b></p> <p>This button silences the audible alarm if it is sounding and illuminates all of the LEDs as a lamp test feature.</p>
	<p><b>Latest Transfer Information</b></p> <p>Whilst pressing this button, the module displays the reason, time, date and duration for the latest transfer that occurred, holding this button cycles between the last S1 transfer and the last S2 transfer.</p> <p>For further details, please see the more detailed description of 'Viewing Latest Transfer Information Page' elsewhere in this manual.</p>
	<p><b>Close / Open to S1</b></p> <div style="border: 1px solid black; padding: 5px; margin-bottom: 10px;"> <p><b>▲ NOTE: This button only operates in manual mode.</b></p> </div> <p>Pressing the <i>Close / Open S1</i>  button when S1 is on load, opens the S1 load switch.</p> <p>Pressing the <i>Close / Open S1</i>  button when S2 is on load and S1 is healthy, the S2 load switch opens, wait for the duration of the <i>transfer delay</i>, then closes the S1 load switch.</p> <p>For further details, please see the more detailed description of 'Manual operation' elsewhere in this document.</p>
	<p><b>Close/Open to S2</b></p> <div style="border: 1px solid black; padding: 5px; margin-bottom: 10px;"> <p><b>▲ NOTE: This button only operates in manual mode.</b></p> </div> <p>Pressing the <i>Close / Open S2</i>  button when S2 is on load, opens the S2 load switch.</p> <p>Pressing the <i>Close / Open S2</i>  button when S1 is on load and S2 is healthy, the S1 load switch opens, wait for the duration of the <i>transfer delay</i>, then closes the S2 load switch.</p> <p>For further details, please see the more detailed description of 'Manual operation' elsewhere in this document.</p>
	<p><b>Menu navigation</b></p> <p>Used for navigating the instrumentation, event log and configuration screens. For further details, please see the more detailed description of these items elsewhere in this manual.</p>

## 4.2 VIEWING THE INSTRUMENT PAGES

It is possible to scroll to display the different pages of information by repeatedly operating the **Next /**

**Previous** page buttons 

**Example**

Status  S1  S2  Further presses of the **Next Page Button** returns the display to the Status page.

If you want to view one of the instrument pages towards the end of the list, it may be quicker to scroll left through the pages rather than right!

The complete order and contents of each information page are given in the following sections

Once selected the page remains on the LCD display until the user selects a different page, or after an extended period of inactivity (*LCD Page Timer*), the module reverts to the status display.

If no buttons are pressed upon entering an instrumentation page, the instruments are displayed automatically subject to the setting of the *LCD Scroll Timer*.

The *LCD Page* and *LCD Scroll* timers are configurable using the DSE Configuration Suite Software or by using the Front Panel Editor.

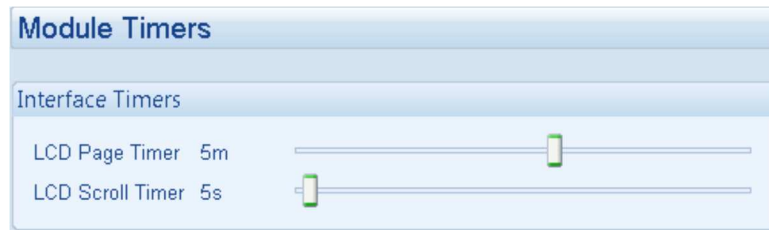

The screenshot shows the factory settings for the timers, taken from the DSE Configuration Suite Software.

Alternatively, to scroll manually through all instruments on the currently selected page, press the scroll

 buttons. The 'autoscroll' is disabled.

If you want to view one of the instruments towards the end of the list, it may be quicker to scroll up through the instruments rather than down!

To re-enable 'autoscroll' press the scroll  buttons to scroll to the 'title' of the instrumentation page (ie S1). A short time later (the duration of the *LCD Scroll Timer*), the instrumentation display begins to autoscroll.

When scrolling manually, the display automatically returns to the Status page if no buttons are pressed for the duration of the configurable *LCD Page Timer*.

If an alarm becomes active while viewing the status page, the display shows the Alarms page to draw the operator's attention to the alarm condition.

### 4.2.1 STATUS

This is the 'home' page, which is displayed when no other page has been selected, and the page that is automatically displayed after a period of inactivity (*LCD Page Timer*) of the module control buttons.

Contains summary information of both supplies along with different module status display.

- Main Summary (Backup source)
- Main Summary (Primary source)
- Source supply summary
- Supervisors summary
- Monitors summary

This page changes with the action of the controller, when S1 is on load, S1 parameters are seen and when changing to S2 on load, the S2 parameters are shown.

No Start Request S1 Closed		
L-N	230V	40A
L-L	400V	50.0Hz

Example of the first status screen showing no start request to S2 and S1 closed supplying the load...

S2 Available S2 Closed		
L-N	229V	40A
L-L	399V	50.1Hz

... and showing S2 on load.



Press  to access more status information about two supplies.

#### **4.2.2 S1**

Contains electrical values of S1 measured or derived from the module's voltage and current inputs.

- S1 Configuration
- S1 State
- S1 Summary
- S1 Voltage (ph-N)
- S1 Voltage (ph-ph)
- S1 Frequency
- S1 Current
- S1 Earth Current
- S1 Load (ph-N kW)
- S1 Load (Total kW)
- S1 Load (ph-N kV A)
- S1 Load (Total kV A)
- S1 Power Factor
- S1 Power Factor Average
- S1 Load (ph-N kvar)
- S1 Load (Total kvar)
- S1 Load (kW h, kV A h, kvar h)

#### **4.2.3 S2**

Contains electrical values of S2 measured or derived from the module's voltage and current inputs.

- S2 Configuration
- S2 State
- S2 Summary
- S2 Voltage (ph-N)
- S2 Voltage (ph-ph)
- S2 Frequency
- S2 Current
- S2 Earth Current
- S2 Load (ph-N kW)
- S2 Load (Total kW)
- S2 Load (ph-N kV A)
- S2 Load (Total kV A)
- S2 Power Factor
- S2 Power Factor Average
- S2 Load (ph-N kvar)
- S2 Load (Total kvar)
- S2 Load (kW h, kV A h, kvar h)
- Load Control

#### **4.2.4 MODULE**

Contains information on the module configuration.

- S1 Configuration
- S2 Configuration
- Date and Time
- Battery Voltage

#### 4.2.5 EXPANSION

Contains the measured value of the expansion module's analogue inputs, this is pressure, percentage or temperature for example *'Bulk Fuel Level'*.

#### 4.2.6 ALARMS

Contains the alarms currently active on the module. For more information please see the section entitled *'Protections'* else where in this manual.

#### 4.2.7 EVENT LOG

The module maintains a log of past alarms and/or selected status changes. At the time of writing, the modules log is capable of storing the last 250 log entries.

Under default factory settings, the event log only includes electrical trip alarms (The event log does not contain Warning alarms); however, this is configurable by the system designer using the DSE Configuration Suite software.

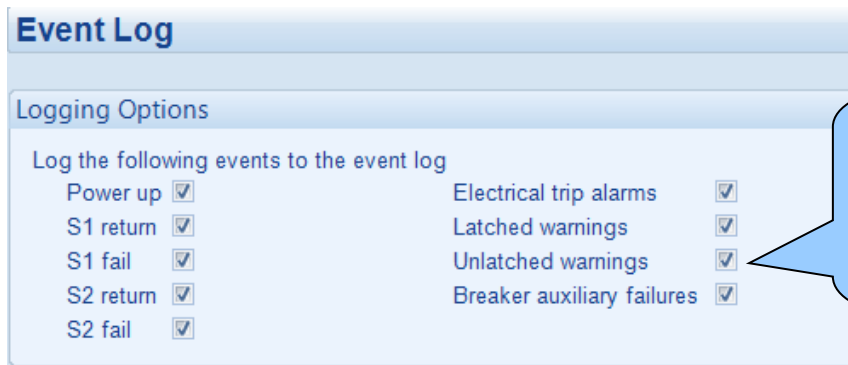

Example showing the possible configuration of the modules event log (DSE Configuration Suite Software) This also shows the factory settings of the module.

Once the log is full, any subsequent shutdown alarms overwrites the oldest entry in the log. Hence, the log always contains the most recent alarms. The module logs the alarm, along with the date and time of the event (or engine running hours if configured to do so). If the module is configured and connected to send SMS text

To view the event log, repeatedly press the next page button



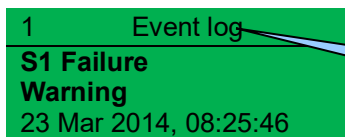

until the LCD screen displays the Event log :



This is event 1.

Press down  to view the next most recent shutdown alarm:

Continuing to press down  cycles through the past alarms after which the display shows the most recent alarm and the cycle begins again.

To exit the event log and return to viewing the instruments, press the next page  button to select the next instrumentation page.

## 4.2.8 SERIAL PORT

### 4.2.8.1 RS232 SERIAL PORT

**NOTE:** Factory Default settings are for the RS232 port to be enabled with no modem connected, operating at 19200 baud, Modbus slave address 10.

This section is included to give information about the RS232 serial port and external modem (if connected).

The items displayed on this page change depending upon configuration of the module. Refer to the system supplier for further details.

#### Module Connected To an RS232 Telephone Modem

**NOTE:** Not all alarms generate a dial out command; this is dependant upon module configuration of the event log. Any event configured to be recorded in the event log causes the modem to dial out to a PC.

When the module is powered up, it sends 'initialisation strings' to the connected modem. It is important therefore that the modem is already powered, or is powered up at the same time as the module. At regular intervals after power up, the modem is reset, and reinitialised, to ensure the modem does not 'hang up'.

If the module does not correctly communicate with the modem, "Modem initialising" appears on the Serial Port instrument screen as shown overleaf.

If the module is set for "incoming calls" or for "incoming and outgoing calls", once the modem is dialled, it answers after two rings (using the factory setting 'initialisation strings'). Once the call is established, all data is passed between the dialling PC and the module.

If the module is set for "outgoing calls" or for "incoming and outgoing calls", then the module dials out whenever an alarm is generated.

Serial Port	
Baud	9600
SlaveID	10
Modem	

Press the **Scroll Down**  button view the modem status....

Indicates that the RS232 port is configured for modem use. It displays 'RS232' if no modem is configured.



**Module Connected To an RS232 GSM Modem**

**NOTE:** Not all alarms generate a dial out command; this is dependant upon module configuration of the event log. Any event configured to be recorded in the event log causes the modem to dial out to a PC.

**NOTE:** In the case of GSM modems, it is important that a **DATA ENABLED SIM** is used. This is often a different number than the 'voice number' and is often called **Circuit Switched Data (CSD)** by the SIM provider.

When the module is powered up, it sends 'initialisation strings' to the connected modem. It is important therefore that the modem is already powered, or is powered up at the same time as the module. At regular intervals after power up, the modem is reset, and reinitialised, to ensure the modem does not 'hang up'.

If the module does not correctly communicate with the modem, "Modem initialising" appears on the Serial Port instrument screen as shown overleaf.

If the module is set for "incoming calls" or for "incoming and outgoing calls", once the modem is dialled, it answers after two rings (using the factory setting 'initialisation strings'). Once the call is established, all data is passed between the dialling PC and the module.

If the module is set for "outgoing calls" or for "incoming and outgoing calls", then the module dials out whenever an alarm is generated.

Many GSM modems are fitted with a status LED to show operator cell status and ringing indicator. These are a useful troubleshooting tool.

In the case of GSM connection problems, try calling the DATA number of the SIMCARD with an ordinary telephone. After two rings, the modem answers the call and then starts 'squealing'. If this does not happen, check all modem connections and double check with the SIM provider that it is a DATA SIM and can operate as a data modem. DATA is NOT the same as FAX or GPRS and is often called Circuit Switched Data (CSD) by the SIM provider.

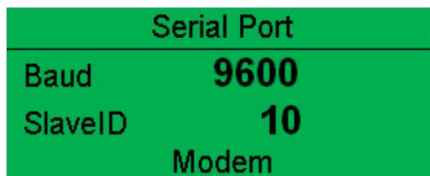

Press the **Scroll Down**  button view the modem GSM status....

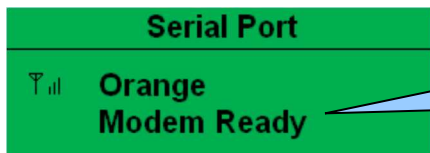

Currently connected GSM operator and signal strength.

If the GSM modem is not purchased from DSE, ensure that it has been correctly set to operate at 9600 baud.

**Modem Initialisation Sequence**

- 1) The modem attempts to communicate to the module

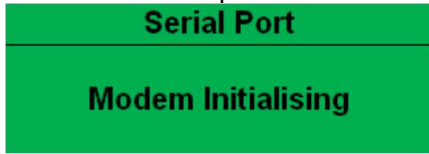

- 2) If the Modem and module communicate successfully:

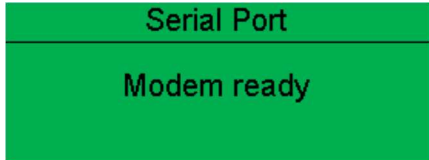

- 3) In case of communication failure between the modem and module, the modem is automatically reset and initialisation is attempted once more:

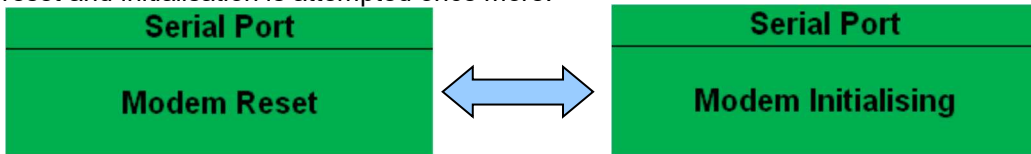

In the case of a module that is unable to communicate with the modem, the display continuously cycles between 'Modem Reset' and 'Modem Initialising' as the module resets the modem and attempts to communicate with it again, this continues until correct communication is established with the modem. In this instance, check connections and verify the modem operation.

**Module Modem Diagnostics**

Modem diagnostic screens are included; press the **Scroll Down**  button when viewing the *RS232 Serial Port* instruments to cycle to the available screens. If modem communication problems are experienced, this information aids troubleshooting.

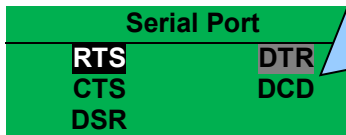

Shows the state of the modem communication lines. These can help diagnose connection problems.

**Example:**

**RTS** A dark background shows the line is active.

**RTS** A grey background shows that the line is toggling high and low

**RTS** No background indicates that the line is inactive

Line	Description	
RTS	Request to Send	Flow Control
CTS	Clear to Send	Flow Control
DSR	Data Set Ready	Ready to Communicate
DTR	Data Terminal Ready	Ready to Communicate
DCD	Data Carrier Detect	Modem is Connected

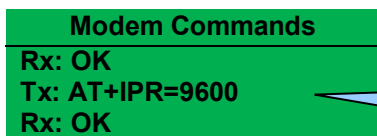

Shows the last command sent to the modem and the result of the command.

### **Module RS232 Port Configured For Connection to A Modbus Master**

The modules operate as a modbus RTU slave device. In a modbus system, there is only one Master, typically a PLC, HMI system or PC SCADA system.

This master requests for information from the modbus slave (The module) and may (in control systems) also send request to change operating modes etc. Unless the Master makes a request, the slave is 'quiet' on the data link.

The screenshot displays the configuration interface for the RS232 Port. It is divided into several sections:

- Serial Port Configuration:** Shows Slave ID set to 10, Baud Rate set to 19200, and Port Usage set to No Modem.
- Advanced:**
  - Initialisation Strings:** Includes fields for 'Init (not auto answer)' with value 'E057=6050=08:508:C1&D3', 'Init (auto answer)' with value 'E057=6050=28:508:C1&D3', and 'Hangup' with value 'H0'.
  - Connection Settings:** Features sliders and input fields for 'Master inactivity timeout' (5s), 'Connect delay' (60s), 'Retries' (4), 'Retry delay' (5s), and 'Repeat cycle delay' (10s).
  - Modbus:** Shows 'Inter-frame delay' set to 0ms and 'Parity checking' set to No Parity.

The factory settings are for the module to communicate at 19200 baud, modbus slave address 10.

To use the RS232 port, ensure that 'port usage' is correctly set using the DSE Configuration Suite Software.

'Master inactivity timeout' must be set to at least twice the value of the system scan time. For example if a modbus master PLC requests data from the module once per second, the timeout must be set to at least 2 seconds

The DSE MODBUS document containing register mappings inside the DSE module is available upon request from support@deepseapl.com. Email the request along with the serial number of the DSE module to ensure the correct information is sent.

#### 4.2.8.2 RS485 SERIAL PORT

**NOTE: Factory Default settings are for the RS485 port to operate at 19200 baud, modbus slave address 10.**

This section is included to give information about the currently selected serial port

The items displayed on this page change depending upon configuration of the module. Refer to the system supplier for further details.

#### Module RS485 Port Configured For Connection to A Modbus Master

The modules operate as a modbus RTU slave device. In a modbus system, there is only one Master, typically a PLC, HMI system or PC SCADA system.

Serial Port	
Baud	19200
SlaveID	1
RS485	

This master requests for information from the modbus slave (The module) and may (in control systems) also send request to change operating modes etc. Unless the Master makes a request, the slave is 'quiet' on the data link.

The factory settings are for the module to communicate at 19200 baud, modbus slave address 10.

'Master inactivity timeout' must be set to at least twice the value of the system scan time. For example if a modbus master PLC requests data from the module once per second, the timeout must be set to at least 2 seconds.

The DSE MODBUS document containing register mappings inside the DSE module is available upon request from support@deepseapl.com. Email the request along with the serial number of the DSE module to ensure the correct information is sent.

#### Typical Requests (Using Pseudo Code)

**BatteryVoltage=ReadRegister(10,0405,1):** reads register (hex) 0405 as a single register (battery volts) from slave address 10.

**WriteRegister(10,1008,2,35701, 65535-35701):** Puts the module into AUTO mode by writing to (hex) register 1008, the values 35701 (auto mode) and register 1009 the value 65535-35701 (the bitwise opposite of auto mode)

**Shutdown=(ReadRegister(10,0306,1) >> 12) & 1:** reads (hex) 0306 and looks at bit 13 (shutdown alarm present)

**Warning=(ReadRegister(10,0306,1) >> 11) & 1:** reads (hex) 0306 and looks at bit 12 (Warning alarm present)

**ControlledShutdown=(ReadRegister(10,0306,1) >> 10) & 1:** reads (hex) 0306 and looks at bit 11 (Controlled Shutdown alarm present)

**ControlMode=ReadRegister(10,0304,2):** reads (hex) register 0304 (control mode).

#### 4.2.9 SCHEDULER

Contains the current schedule plan for S2 configured in module.

2/3	Schedule	10:39
Off Load		Week 3
On 12:00	Run Time	00:30
	M T W T F S S	

Example of the 3<sup>rd</sup> scheduled operation in bank 2 for S2.

#### 4.2.10 ABOUT

Contains important information about the module and the firmware versions. This information may be asked for when contacting DSE Technical Support Department for advice.

About	
Variant	335
Application	V3.0.20
USB ID	BC614E

- Variant – 335
- Application Version – The version of the module's main firmware file (Updatable using the Firmware Update Wizard in the DSE Configuration Suite Software).
- USB ID – Unique identifier for PC USB connection



Press  to access more information about the module.

About	
Bootloader	V1.3.4
Analogue	V2.0.0

- Bootloader - Firmware Update bootloader software version

### 4.3 VIEWING LATEST TRANSFER INFORMATION PAGE

It is possible to view the reason, time, date and duration of the latest transfer by pressing and holding the *Latest Transfer Information* . Holding this button cycles between the last S1 transfer and the last S2 transfer.

**S1 Latest Transfer 16:53**  
**S2 Under voltage**  
**22 Oct 2014, 12:59:47**  
**00:27:13**

Example of the Latest Transfer page which shows that there was a transfer cause by an S1 Under Voltage failure which lasted for 27 minutes and 13 seconds.

#### 4.4 USER CONFIGURABLE INDICATORS

These LEDs can be configured by the user to indicate any one of **100+ different functions** based around the following:

- **Indications** - Monitoring of a digital input and indicating associated functioning user's equipment - *Such as Battery Charger On or Louvres Open, etc.*
- **Warning & Electrical Trips** - Specific indication of a particular warning or electrical trip condition, backed up by LCD indication - *Such as S2 Under Voltage Trip, Transformer Over Temperature, etc.*
- **Status Indications** - Indication of specific functions or sequences derived from the modules operating state - *Such as, Panel Locked, S2 Available, etc.*



## 4.5 OPERATION

**NOTE:** The following descriptions detail the sequences followed by a module containing the standard 'factory configuration'. Always refer to the configuration source for the exact sequences and timers observed by any particular module in the field.

### 4.5.1 LOAD SWITCHING FUNCTIONALITY

**NOTE:** For comprehensive detail of the load switching functionality of each *Breaker Scheme*, refer to DSE Publication: *057-237 DSE335 Configuration Suite PC Software Manual*.

The load switching functionality of the DSE335 is dependant on which *Breaker Scheme* the module is currently configured to adhere to. A brief description of the operation of each scheme is detailed below:

#### 4.5.1.1 BREAKER SCHEME A

**NOTE:** S1 Closed Auxiliary and S2 Closed Auxiliary inputs do not affect the operation of the load switching in Breaker Scheme A

*Breaker Scheme A* has been designed for use with contactors or ACB's. When this scheme is selected the DSE335 will always perform an open transition, with a pre-configured transfer delay between opening one load switch, and closing the other. *Breaker Scheme A* is suitable for load switching devices that require either pulsed or continuous close / open commands.

#### 4.5.1.2 BREAKER SCHEME B

*Breaker Scheme B* has been designed primarily for use with rotary transfer switches with a very fast changeover time. When this scheme is selected the DSE335 may be configured to perform either a normal open transition, with a pre-configured transfer delay between opening one load switch, and closing the other, or an open transition with *Check Sync*, in which the open and close commands are sent to each load switch simultaneously. For the latter option, *Check Sync* must be enabled within the DSE335. The module then proceeds to compare the phase angle and frequency difference between the two supplies. A transfer is then only allowed when these values are within pre-defined limits. *Breaker Scheme B* is suitable for a limited amount of load switching devices, all of which must be able to accept pulse signal for opening and closing.

#### 4.5.1.3 BREAKER SCHEME C

*Breaker Scheme C* has been designed for use with contactors or ACB's. This scheme can be used for open transition, open transition with *Check Sync*, or closed transition with *Check Sync*. The open transition functionality of *Breaker Scheme C* is identical to that of *Breaker Scheme A*. The open transition with *Check Sync* functionality is similar to that of *Breaker Scheme B*, but additionally supports continuous signal open and close commands, and so is compatible with contactors and ACB's. The closed transition with *Check Sync* functionality allows for both load switching devices to be closed, and thus both supplies in parallel, for the preconfigured *Parallel Time*. As soon as the DSE335 detects the load switching device of the supply the load is being transferred to has closed, the *Parallel Time* timer begins. Once this timer has expired, the DSE335 opens the load switching device of the supply the load has been transferred from. If at any time during this process a load switching device is detected to have not opened or closed as instructed, one or multiple alarms are generated. At this point the DSE335 configures the load switching devices to ensure continued supply of the site load where possible. Following such instances, load switch alarms may be cleared without putting the DSE335 into *Stop* mode by pressing and holding the *Mute* button on the front of the module for 5 seconds, or enabling a module input configured as *Reset Breaker Alarms*. Doing so only resets these alarms, leaving any other latched or active alarms still present. Pressing the *Stop* button when in *Stop* mode also clears the load switch alarms, along with any others present.



## 4.6 QUICKSTART GUIDE

This section provides a quick start guide to the module's operation.

### 4.6.1 STARTING S2

**NOTE:** This only applies when S2 is configured as a generator supply.





4.6.2 STOPPING S2

**NOTE:** This only applies when S2 is configured as a generator supply.



## 4.7 STOP/RESET

 **NOTE: If a digital input configured to *Panel Lock* is active, changing module modes is not possible. Viewing the instruments and event logs is NOT affected by panel lock.**



*Stop* mode is activated by pressing the  button.

In *Stop* mode , the module removes S2 from load (if necessary) and removes the start signal given to the generator controller (if S2 is configured as a generator and it is running).

If S2 is configured as a generator and it does not stop after the cooling down time, the *Fail To Stop* alarm is activated (subject to if the *Fail To Stop* timer is enabled and its duration). To detect the generator (S2) is at rest the following must occur:

- S2 Frequency must be zero
- S2 Voltage must be zero

Any latched alarms that have been cleared are reset when *Stop* mode  is entered.

S2 is not placed on load (or started if configured as a generator) when in *Stop* mode . If remote start signals are given, the input is ignored until *Auto*  mode is entered.

## 4.8 MANUAL MODE

 **NOTE:** If a digital input configured to *Panel Lock* is active, changing module modes is not possible. Viewing the instruments and event logs is NOT affected by panel lock.

*Manual* mode is activated by pressing the  button.

In *Manual*  mode, the module activates an output to give a start signal to an external generator controller (if S2 is configured as a generator supply), and if required, change the state of the load switching devices. An LED indicator beside the button confirms this action.

### 4.8.1 STARTING SEQUENCE

 **NOTE:** There is no *start delay* in this mode of operation.

As soon as the *Manual*  mode button is pressed, the output to give a start signal to an external generator controller is activated (if S2 is configured as a generator)

If the generator fails to start during the 'S2 Fail Delay' timer, an alarm appears on the display which shows *Fail to Start*. S2 is seen as available once the supply is within limits (if configured as a mains supply) or had achieved loading voltage and frequency (if configured as a generator).

### 4.8.2 S2 AVAILABLE

 **NOTE:** The load transfer signal remains inactive until S2 is seen as available. This prevents loading to a supply that has failed or is not yet available.

In *Manual*  mode, the load is not transferred to S2 unless a 'loading request' is made and the S2 supply is within limits (if configured as a mains supply) or achieve *Loading Voltage* and *Loading Frequency* (if configured as a generator).

A loading request can come from a number of sources.



- Pressing the *Close/Open S2*  button
- S1 supply out of limits
- Activation of an auxiliary input that has been configured to *remote start on load*
- Activation of the inbuilt exercise scheduler if configured for 'on load' runs.

As the load increases and decreases, the module may (depending upon configuration) remove non-essential loads. This is configured as part of the *Load Shedding* control settings in the DSE Configuration Suite Software.

See section entitled *Load Shedding* elsewhere in this document for further details.

## Description of Controls



Once the load has been transferred to S2, it is not automatically transferred back to the S1 supply. To manually transfer the load back to the mains either:

- Pressing the *Close/Open S1*  button
- Pressing the *Auto*  button to return to automatic mode.
- Pressing the *Start Inhibit*  button to return to start inhibit mode.

For further details of breaker control, see the section entitled “controls and indications” elsewhere in this manual.

### 4.8.3 STOPPING SEQUENCE

In manual mode, S2 continues to run until either:

- Pressing the *Start Inhibit*  button to return to start inhibit mode.
- Pressing the *Auto*  button to return to automatic mode.

## 4.9 AUTOMATIC MODE

 **NOTE:** If a digital input configured to *Panel Lock* is active, changing module modes is not possible. Viewing the instruments and event logs is NOT affected by panel lock.

Auto mode is activated by pressing the  button.

In *Auto*  mode, the module operates fully automatically, changing between the two supplies in case of failure without user intervention. An LED indicator beside the button confirms this action.

### 4.9.1 WAITING IN AUTO MODE

If a starting/loading request is made, the starting sequence begins. Starting/loading requests can be from the following sources:

- S1 supply out of limits
- Activation of an auxiliary input that has been configured to *remote start on load* or *remote start off load*.
- Activation of the inbuilt exercise scheduler.
- Instruction from external remote telemetry devices using the RS232 or RS485 interface

### 4.9.2 STARTING SEQUENCE

To allow for 'false' start/load requests such as S1 brownouts, the *Start Delay* timer begins. There are individual start delay timers for each of the different start/load request types.

When all start/load requests are removed during the *Start Delay* timer, the unit returns to a stand-by state.

If a start/load request is still present at the end of the *Start Delay* timer, an output to give a start signal to an external generator controller is activated (if S2 is configured as a generator).

If the generator fails to start during the 'S2 Fail Delay' timer, an alarm appears on the display which shows *Fail to Start*. S2 is seen as available once the supply is within limits (if configured as a mains supply) or had achieved *Loading Voltage* and *Loading Frequency* (if configured as a generator).

If a start/load request is present but the starting sequence has not begun, an input configured to '*Auto Start Inhibit*' could be active.

### 4.9.3 S2 AVAILABLE

In *Auto*  mode, the load is automatically transferred to S2 when it is within limits (if configured as a mains supply) or achieve loading voltage and frequency (if configured as a generator).

If a start/load request is present but S2 does not go on load, an input configured to 'S2 Load Inhibit' could be active.

A loading request can come from a number of sources.

- S1 supply out of limits
- Activation of an auxiliary input that has been configured to *remote start on load*
- Activation of the inbuilt exercise scheduler if configured for 'on load' runs.

 **NOTE: The load transfer signal remains inactive until S2 is seen as available. This prevents loading to a supply that has failed or is not yet available.**

As the load increases and decreases, the module may (depending upon configuration) remove non-essential loads. This is configured as part of the *Load Shedding* control settings in the DSE Configuration Suite Software.

See section entitled *Load Shedding* elsewhere in this document for further details.

If all start/load requests are removed, the *stopping sequence* begins.

### 4.9.4 STOPPING SEQUENCE

The *Return Delay* timer operates to ensure that the start/load request has been permanently removed and isn't just a short term removal. In case another start request is made during the *Return Delay* (or cooling down period when S2 is configured as a generator), the set returns on load.

If there are no starting requests at the end of the *Return Delay* timer, the load is transferred back from the S2 to the S1 supply and the *Cooling* timer is initiated (when S2 is configured as a generator).

The *Cooling* timer allows S2 (when configured as a generator) to run off load and cool sufficiently before the start signal to the external generator control unit is removed. This is particularly important where turbo chargers are fitted to the engine.



After the *Cooling* timer has expired, the start signal given to the external generator controller is removed..

## 4.10 MODE SELECTION

 **NOTE: If a digital input configured to *Panel Lock* is active, changing module modes is not possible. Viewing the instruments and event logs is NOT affected by panel lock.**



Pressing the *Mode*  button sets which of the three modes below to leave the controller in.

### 4.10.1 TEST ON LOAD

Activate by pressing the *Mode*  button repeatedly until *Test on Load* is shown on the display, then press the *Tick*  button to confirm the change. An LED indicator beside the button confirms this action.

The *Test on Load* mode starts S2 (if configured as a generator) and transfers the load to S2.

#### 4.10.1.1 STARTING SEQUENCE

As soon as the *Mode*  is selected and confirmed by pressing the *Tick*  button is pressed, the output to give a start signal to an external generator controller is activated (if S2 is configured as a generator)

If the generator fails to start during the 'S2 Fail Delay' timer, an alarm appears on the display which shows *Fail to Start*. S2 is seen as available once the supply is within limits (if configured as a mains supply) or had achieved *Loading Voltage* and *Loading Frequency* (if configured as a generator).

#### 4.10.1.2 S2 AVAILABLE

In *Test on Load* mode, the load is automatically transferred to S2 when it is within limits (if configured as a mains supply) or had achieved loading voltage and frequency (if configured as a generator).

If a start/load request is present but S2 does not go on load, an input configured to '*S2 Load Inhibit*' could be active.



 **NOTE: The load transfer signal remains inactive until S2 is seen as available. This prevents loading to a supply that has failed or is not yet available.**

As the load increases and decreases, the module may (depending upon configuration) remove non-essential loads. This is configured as part of the *Load Shedding* control settings in the DSE Configuration Suite Software.

See section entitled *Load Shedding* elsewhere in this document for further details.



#### 4.10.1.3 STOPPING SEQUENCE

In *Test on Load* mode, S2 continues to run on load until either:

- Pressing the *Start Inhibit*  button to return to start inhibit mode.
- Pressing the *Auto*  button to return to automatic mode.





#### 4.10.2 TEST OFF LOAD

Activate by pressing the *Mode*  button repeatedly until *Test off Load* is shown on the display, then press the *Tick*  button to confirm the change. An LED indicator beside the button confirms this action.

The *Test off Load* mode only starts S2 (if configured as a generator) and leave it off load.

##### 4.10.2.1 STARTING SEQUENCE

As soon as the *Mode*  is selected and confirmed by pressing the *Tick*  button is pressed, the output to give a start signal to an external generator controller is activated (if S2 is configured as a generator)

If the generator fails to start during the *S2 Fail Delay* timer, an alarm appears on the display which shows *Fail to Start*. S2 is seen as available once the supply is within limits (if configured as a mains supply) or had achieved *Loading Voltage* and *Loading Frequency* (if configured as a generator).

##### 4.10.2.2 S2 AVAILABLE

In *Test Off Load* mode, the load is not transferred to S2 unless a 'loading request' is made and the S2 supply is within limits (if configured as a mains supply) or has achieved loading voltage and frequency (if configured as a generator).

A loading request can come from a number of sources.

- S1 supply out of limits
- Activation of an auxiliary input that has been configured to *remote start on load*
- Activation of the inbuilt exercise scheduler if configured for 'on load' runs.



 **NOTE: The load transfer signal remains inactive until S2 is seen as available. This prevents loading to a supply that has failed or is not yet available.**

As the load increases and decreases, the module may (depending upon configuration) remove non-essential loads. This is configured as part of the *Load Shedding* control settings in the DSE Configuration Suite Software.



See section entitled *Load Shedding* elsewhere in this document for further details.

##### 4.10.2.3 STOPPING SEQUENCE

In *Test off Load* mode, S2 continues to run on load until either:

- Pressing the *Start Inhibit*  button to return to *Start Inhibit* mode.
- Pressing the *Auto*  button to return to *Automatic* mode.

### 4.10.3 PROHIBIT RETURN

Activate by pressing the *Mode*  button repeatedly until *Prohibit Return* is shown on the display, then press the *Tick*  button to confirm the change. An LED indicator beside the button confirms this action.

The *Prohibit Return* mode prevents the load being transfer back to the S1 from the S2 supply until the module is instructed to do so.

#### 4.10.3.1 WAITING IN PROHIBIT RETURN

If a starting/loading request is made, the starting sequence begins. Starting/loading requests can be from the following sources:

- S1 supply out of limits
- Activation of an auxiliary input that has been configured to *Remote Start On Load* or *Remote Start Off Load*.
- Activation of the inbuilt exercise scheduler.
- Instruction from external remote telemetry devices using the RS232 or RS485 interface

#### 4.10.3.2 STARTING SEQUENCE

To allow for 'false' start/load requests such as S1 brownouts, the *Start Delay* timer begins. There are individual *Start Delay* timers for each of the different start/load request types.

When all start/load requests are removed during the *Start Delay* timer, the unit returns to a stand-by state.

If a start/load request is still present at the end of the *Start Delay* timer, an output to give a start signal to an external generator controller is activated (if S2 is configured as a generator).

If the generator fails to start during the 'S2 Fail Delay' timer, an alarm appears on the display which shows *Fail to Start*. S2 is seen as available once the supply is within limits (if configured as a mains supply) or had achieved *Loading Voltage* and *Loading Frequency* (if configured as a generator).

If a start/load request is present but the starting sequence has not begun, an input configured to '*Auto Start Inhibit*' could be active.

#### 4.10.3.3 S2 AVAILABLE

In *Prohibit Return* mode, the load is automatically transferred to S2 when it is within limits (if configured as a mains supply) or has achieved *Loading Voltage* and *Loading Frequency* (if configured as a generator).

If a start/load request is present but S2 does not go on load, an input configured to 'S2 Load Inhibit' could be active.

A loading request can come from a number of sources.

- S1 supply out of limits
- Activation of an auxiliary input that has been configured to *Remote Start On Load*
- Activation of the inbuilt exercise scheduler if configured for 'on load' runs.

 **NOTE: The load transfer signal remains inactive until S2 is seen as available. This prevents loading to a supply that has failed or is not yet available.**



As the load increases and decreases, the module may (depending upon configuration) remove non-essential loads. This is configured as part of the *Load Shedding* control settings in the DSE Configuration Suite Software.

See section entitled *Load Shedding* elsewhere in this document for further details.

If all start/load requests are removed, the *Stopping sequence* begins.

#### 4.10.3.4 STOPPING SEQUENCE

In *Return Inhibit* mode, S2 continues to run on load even if S1 has return until either:

- Pressing the *Start Inhibit*  button to return to start inhibit mode.
- Pressing the *Auto*  button to return to automatic mode.

## 4.11 SCHEDULER

The controller contains an inbuilt exercise run scheduler, capable of automatically starting and stopping the set. Up to 16 scheduled start/stop sequences can be configured in banks of 8 to either repeat on a 7-day or 28-day cycle.

Scheduled runs may be on load or off load depending upon module configuration.

### Example

Screen capture from DSE Configuration Suite Software showing the configuration of the Exercise Scheduler.

In this example the set starts at 09:00 on the first Monday of each month and run for 5 hours, then start at 13:30 on every Tuesday and run for 30 minutes.

Week	Day	Transfer Mode	Target	Start Time	Duration	Clear
First	Monday	Off Load	S2	09:00	05:00	Clear
Second	Tuesday	Transfer	S2	13:30	00:30	Clear
First	Monday	Do Not Transfer	None	00:00	00:00	Clear
First	Monday	Do Not Transfer	None	00:00	00:00	Clear
First	Monday	Do Not Transfer	None	00:00	00:00	Clear
First	Monday	Do Not Transfer	None	00:00	00:00	Clear
First	Monday	Do Not Transfer	None	00:00	00:00	Clear
First	Monday	Do Not Transfer	None	00:00	00:00	Clear





### 4.11.1 STOP MODE

- Scheduled runs do not occur when the module is in *Stop*  mode.

### 4.11.2 MANUAL MODE

- Scheduled runs do not occur when the module is in *Manual*  mode.
- Activation of a Scheduled Run 'On Load' when the module is operating Off Load in Manual mode has no effect, the set continues to run Off Load

### 4.11.3 AUTO MODE

- Scheduled runs operate ONLY if the module is in *Auto*  mode with no Electrical Trip alarm present.
- If the module is in *Stop*  or *Manual*  mode when a scheduled run begins, S2 is not started (if configured as generator). However, if the module is moved into *Auto*  mode during a scheduled run, S2 is called to start.
- Depending upon configuration by the system designer, an external input can be used to inhibit a scheduled run.
- If S2 is Off Load in *Auto*  mode and a scheduled run configured to 'Transfer to S2' begins, S2 is placed On Load for the duration of the Schedule.

## 4.12 LOAD SHEDDING CONTROL

This feature may be enabled by the system designer to ensure the loading on S2 is kept to a nominal amount. Conversely as the load increases towards the maximum rating of the set, non-essential loads can be shed to prevent overload of S2.

### 4.12.1 LOAD SHEDDING CONTROL

 **NOTE: Refer to DSE335 Configuration Suite Manual (DSE part 057-237) for further details on configuring, monitoring and control.**

The *Load Shedding Control* feature (if enabled) allows for a maximum of five load shedding steps. When S2 is about to take load, the configured number of *Load Shedding Control Outputs at Startup* energises. This configurable setting allows (for instance) certain loads to be removed from S2 prior to the set's load switch being closed. This can be used to ensure the initial loading of the set is kept to a minimum, below the *Load Acceptance* specification of S2.

S2 is then placed on load. The *Load Shedding Control* scheme begins. When the load reaches the *Load Shedding Trip* level the *Trip Delay* timer starts. If S2 loading is still high when the timer expires, the first *Load shedding Control* output energises. When the load has been above the trip level for the duration of the timer the 'next' *Load shedding Control* output energises and so on until all *Load Shedding Control outputs are energised*.

If at any time the load falls back below the *Load Shedding Return* level, the *Return Time* starts. If the load remains below the return level when the timer has expired the 'highest' *Load Shedding Control* output that has been energised is de-energised. This process continues until all outputs have been de-energised.

When the set enters a stopping sequence for any reason the *Load Shedding control* outputs are de-energised at the same time as the S2 load switch is signalled to open.

## 5 PROTECTIONS

When an alarm is present, the Audible Alarm sounds and the Common alarm LED if configured illuminates.

The audible alarm can be silenced by pressing the *Alarm Mute* 

The LCD display jumps from the 'Information page' to display the Alarm Page

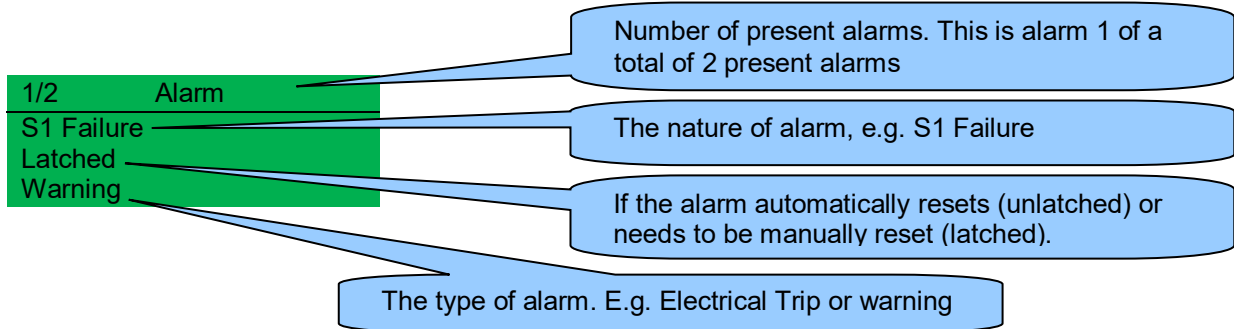

The LCD displays multiple alarms E.g. "S1 Failure Warning", "Fail to Stop Warning" and "Digital Input A Electrical Trip". These automatically scroll in the order that they occurred.

In the event of a warning alarm, the LCD displays the appropriate text. If an electrical trip then occurs, the module again displays the appropriate text.

Example:-

Alarm	1/2
Fail to Stop Unlatched Warning	

Alarm	2/2
Digital Input A Unlatched Electrical Trip	

## 5.1 INDICATIONS

Indications are non-critical and often status conditions. They do not appear on the LCD of the module as a text message. However, an output or LED indicator can be configured to draw the operator's attention to the event.

Example

- Input configured for indication.
- The LCD text does not appear on the module display but can be added in the configuration to remind the system designer what the input is used for.
- As the input is configured to *Indication* there is no alarm generated.
- LED Indicator to make LED1 illuminate when Digital Input A is active.
- The Insert Card Text allows the system designer to print an insert card detailing the LED function.
- Sample showing operation of the LED.



## 5.2 WARNINGS



Warnings are non-critical alarm conditions and do not affect the operation of the system, they serve to draw the operators attention to an undesirable condition.

Example

1/2	Alarm
S1 Failure	
Latched	
Warning	

In the event of an alarm the LCD jumps to the alarms page, and scroll through all active warnings and shutdowns.

By default, warning alarms are self-resetting when the fault condition is removed. However some warning alarms are latched and need to be reset manually.

Display	Reason
Auxiliary Inputs	If an auxiliary input has been configured as a warning the appropriate LCD message is displayed and the <b>COMMON ALARM LED</b> illuminates.
Battery Under Voltage	The DC supply has fallen below the low volts setting level for the duration of the low battery volts timer
Battery Over Voltage	The DC supply has risen above the high volts setting level for the duration of the high battery volts timer
Calibration Lost	The module has lost its calibration settings and must be sent back to DSE to be re-calibrated.
Expansion Inputs	If an expansion input has been configured as a warning the appropriate LCD message is displayed and the <b>COMMON ALARM LED</b> illuminates.
Fail To Start	S2 has not reached the configured limits or loading voltage and frequency before the S2 Fail Delay timer has expired.
Fail To Stop	The module has detected a condition that indicates that S2 is present when it has been instructed to stop.
Loading Voltage Not Reached	Indicates that the S2 voltage is not above the configured <i>loading voltage</i> . S2 does not take load when the alarm is present after the safety timer.  <div style="border: 1px solid black; padding: 5px;">  <b>NOTE: Only applicable when S2 is configured as a generator supply.</b> </div>
Loading Frequency Not Reached	Indicates that the S2 frequency is not above the configured <i>loading frequency</i> . S2 does not take load when the alarm is present after the safety timer.  <div style="border: 1px solid black; padding: 5px;">  <b>NOTE: Only applicable when S2 is configured as a generator supply.</b> </div>



Display	Reason
PLC Functions	If a PLC Function has been configured as a warning the appropriate LCD message is displayed and the <b>COMMON ALARM LED</b> illuminates.
S1 Breaker Auxiliary Fail	Indicates that the <i>S1 Closed Auxiliary</i> input has not activated along with the <i>Close S1 Output</i> or <i>Open S1 Output</i> , or the input has activated when the output was not energised.
S1 Failure Unlatched	The module has detected that S1 has failed for either an under/over voltage/frequency condition. The unlatched alarm is automatically cleared upon S1 returning to an available state.
S1 Phase Rotation	The module has detected a wrong phase sequence for S1.
S2 Breaker Auxiliary Fail	Indicates that the <i>S2 Closed Auxiliary</i> input has not activated along with the <i>Close S2 Output</i> or <i>Open S2 Output</i> , or the input has activated when the output was not energised.
S2 Failure Unlatched	The module has detected that S2 has failed for either an under/over voltage/frequency condition. The unlatched alarm is automatically cleared upon S2 returning to an available state.
S2 Phase Rotation	The module has detected a wrong phase sequence for S2.

### 5.3 ELECTRICAL TRIPS

Electrical trips are latching unload and stop S2 (if configured as a generator) but in a controlled manner. On initiation of the electrical trip condition the module de-energises the '**Close S2 Output**' to remove the load from S2. Once this has occurred the module starts the Cooling timer and allow the generator to cool down and shut off. The alarm must be accepted and cleared, and the fault removed to reset the module.

Example

1/2 Alarm
Digital Input A Latched
Electrical Trip

Electrical trips are latching alarms and unload and stop S2 (if configured as a generator). To clear these alarms the **STOP**  button is pressed

Display	Reason
Auxiliary Inputs	If an auxiliary input has been configured as an electrical trip, the appropriate LCD message is displayed and the <b>COMMON ALARM LED</b> illuminates.
Expansion Inputs	If an expansion input has been configured as an electrical trip, the appropriate LCD message is displayed and the <b>COMMON ALARM LED</b> illuminates.
PLC Functions	If a PLC Function has been configured as an electrical trip, the appropriate LCD message is displayed and the <b>COMMON ALARM LED</b> illuminates.
S1 Breaker Auxiliary Fail	Indicates that the <i>S1 Closed Auxiliary</i> input has not activated along with the <i>Close S1 Output</i> or <i>Open S1 Output</i> , or the input has activated when the output was not energised.
S1 Phase Rotation	The module has detected a wrong phase sequence for S1.
S2 Failure Unlatched	The module has detected that S2 has failed for either an under/over voltage/frequency condition. The unlatched alarm is automatically cleared upon S2 returning to an available state.
S2 Phase Rotation	The module has detected a wrong phase sequence for S2.



## 6 FRONT PANEL CONFIGURATION

This configuration mode allows the operator limited customising of the way the module operates.

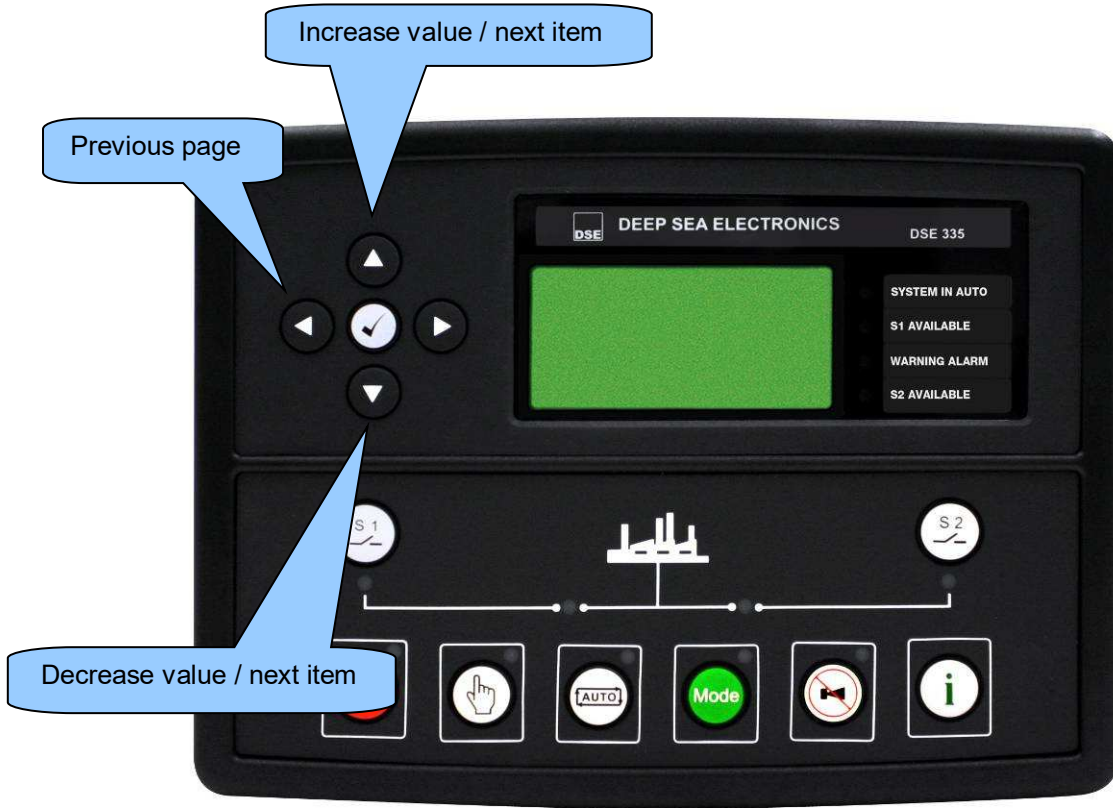
Use the module's navigation buttons to traverse the menu and make value changes to the parameters:





## 6.1 ACCESSING THE MAIN FRONT PANEL CONFIGURATION EDITOR

Press and hold the *Stop*  and *Tick*  buttons simultaneously to enter the editor.

If a module security PIN has been set, the PIN number request is then shown :



Press the *Tick*  button, the first '#' changes to '0'. Press  (up or down) to adjust it to the correct value.

Press  (right) when the first digit is correctly entered. The digit entered is now shown as '#' for security.

Repeat this process for the other digits of the PIN number. Press  (left) to move back and adjust one of the previous digits.

When the *Tick*  button is pressed after editing the final PIN digit, the PIN is checked for validity. If the number is not correct, re-enter the PIN.

If the PIN has been successfully entered (or the module PIN has not been enabled), the editor is displayed :

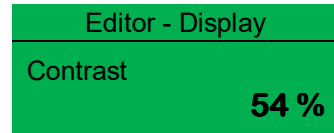

**NOTE:** The PIN number is not set by DSE when the module leaves the factory. If the module has a PIN code set, this has been affected by the ATS supplier who must be contacted if the code is required. If the code has been 'lost' or 'forgotten', the module must be returned to the DSE factory to have the module's code removed. A charge is applied for this procedure. **NB - This procedure cannot be performed away from the DSE factory.**



### 6.1.1 EDITING A PARAMETER

 **NOTE: The editor automatically exits after 5 minutes of inactivity to ensure security.**

 **NOTE: The PIN number is automatically reset when the editor is exited (manually or automatically) to ensure security.**

 **NOTE: Refer to DSE335 Configuration Suite Manual (DSE part 057-237) for further details on configuring, monitoring and control.**

Enter the editor as described above.

Press the  (left) or  (right) buttons to cycle to the section to view/change.

Press the  (up or down) buttons to select the parameter to view/change within the currently selected section.

To edit the parameter, press the *Tick*  button to enter edit mode. The parameter begins to flash to indicate that value is being edited.

Press the  (up or down) buttons to change the parameter to the required value.

Press the *Tick*  button to save the value. The parameter ceases flashing to indicate that it has been saved.

To exit the editor at any time, press and hold the *Tick*  button.

## 6.2 ADJUSTABLE PARAMETERS

 **NOTE:** Refer to DSE335 Configuration Suite Manual (DSE part 057-237) for further details on configuring, monitoring and control.

Section	Parameter As Shown On Display	Values
<b>Display</b>	LCD Contrast	0%
	Language	English
	LCD Page Timer	hh:mm:ss
	Scroll Delay	hh:mm:ss
	Date and Time	dd-mm-yyyy, hh:mm:ss
<b>S1</b>	S1 Option	Generator, Mains
	Immediate S1 Dropout	Inactive, Active
	Under Voltage Trip	0 V
	Over Voltage Trip	0 V
	Under Frequency Trip	0 Hz
	Over Frequency Trip	0 Hz
<b>S2</b>	S2 Option	Generator, Mains
	Immediate S2 Dropout	Inactive, Active
	Under Voltage Trip (Generator Option)	0 V
	Over Voltage Trip (Generator Option)	0 V
	Under Frequency Trip (Generator Option)	0.0 Hz
	Over Frequency Trip (Generator Option)	0.0 Hz
	Under Voltage Trip (Mains Option)	0 V
	Over Voltage Trip (Mains Option)	0 V
	Under Frequency Trip (Mains Option)	0.0 Hz
Over Frequency Trip (Mains Option)	0.0 Hz	
<b>Timers</b>	S1 Transient Delay	mm:ss
	Start Delay	hh:mm:ss
	Warming Up Time	hh:mm:ss
	S2 Fail Delay	mm:ss
	Elevator Delay	mm:ss
	Non-sync Transfer Time	mm:ss.s
	Check-Sync Transfer time	mm:ss.s
	Return Delay	hh:mm:ss
	Cooling Time	hh:mm:ss
	Fail to Stop Enable	Inactive, Active
	Fail to Stop Delay	mm:ss
	S2 Transient Delay	s.s

Parameters continue overleaf...

**NOTE:** Refer to DSE335 Configuration Suite Manual (DSE part 057-237) for further details on configuring, monitoring and control.

Section	Parameter As Shown On Display	Values
<b>Scheduler Bank 1</b>	Scheduler Enable	Inactive, Active
	Bank 1 Run Mode	Do Not Transfer Transfer to S1 Transfer to S2 S1 Off Load (When S1 = Gen) S2 Off Load (When S2 = Gen)
	Bank 1 Period	Weekly, Monthly
	Bank 1 Event 1 Week	1-4
	Bank 1 Event 1 Day	Monday to Sunday
	Bank 1 Event 1 Start Time	hh:mm
	Bank 1 Event 1 Duration	hh:mm
	Bank 1 Event 2 Week	1-4
	Bank 1 Event 2 Day	Monday to Sunday
	Bank 1 Event 2 Start Time	hh:mm
	Bank 1 Event 2 Duration	hh:mm
	Bank 1 Event 3 Week	1-4
	Bank 1 Event 3 Day	Monday to Sunday
	Bank 1 Event 3 Start Time	hh:mm
	Bank 1 Event 3 Duration	hh:mm
	Bank 1 Event 4 Week	1-4
	Bank 1 Event 4 Day	Monday to Sunday
	Bank 1 Event 4 Start Time	hh:mm
	Bank 1 Event 4 Duration	hh:mm
	Bank 1 Event 5 Week	1-4
	Bank 1 Event 5 Day	Monday to Sunday
	Bank 1 Event 5 Start Time	hh:mm
	Bank 1 Event 5 Duration	hh:mm
	Bank 1 Event 6 Week	1-4
	Bank 1 Event 6 Day	Monday to Sunday
	Bank 1 Event 6 Start Time	hh:mm
	Bank 1 Event 6 Duration	hh:mm
	Bank 1 Event 7 Week	1-4
	Bank 1 Event 7 Day	Monday to Sunday
	Bank 1 Event 7 Start Time	hh:mm
	Bank 1 Event 7 Duration	hh:mm
	Bank 1 Event 8 Week	1-4
	Bank 1 Event 8 Day	Monday to Sunday
Bank 1 Event 8 Start Time	hh:mm	
Bank 1 Event 8 Duration	hh:mm	

Parameters continue overleaf...

**NOTE:** Refer to DSE335 Configuration Suite Manual (DSE part 057-237) for further details on configuring, monitoring and control.

Section	Parameter As Shown On Display	Values
Scheduler Bank 2	Bank 2 Run Mode	Do Not Transfer Transfer to S1 Transfer to S2 S1 Off Load (When S1 = Gen) S2 Off Load (When S2 = Gen)
	Bank 2 Period	Weekly, Monthly
	Bank 2 Event 1 Week	1-4
	Bank 2 Event 1 Day	Monday to Sunday
	Bank 2 Event 1 Start Time	hh:mm
	Bank 2 Event 1 Duration	hh:mm
	Bank 2 Event 2 Week	1-4
	Bank 2 Event 2 Day	Monday to Sunday
	Bank 2 Event 2 Start Time	hh:mm
	Bank 2 Event 2 Duration	hh:mm
	Bank 2 Event 3 Week	1-4
	Bank 2 Event 3 Day	Monday to Sunday
	Bank 2 Event 3 Start Time	hh:mm
	Bank 2 Event 3 Duration	hh:mm
	Bank 2 Event 4 Week	1-4
	Bank 2 Event 4 Day	Monday to Sunday
	Bank 2 Event 4 Start Time	hh:mm
	Bank 2 Event 4 Duration	hh:mm
	Bank 2 Event 5 Week	1-4
	Bank 2 Event 5 Day	Monday to Sunday
	Bank 2 Event 5 Start Time	hh:mm
	Bank 2 Event 5 Duration	hh:mm
	Bank 2 Event 6 Week	1-4
	Bank 2 Event 6 Day	Monday to Sunday
	Bank 2 Event 6 Start Time	hh:mm
	Bank 2 Event 6 Duration	hh:mm
	Bank 2 Event 7 Week	1-4
	Bank 2 Event 7 Day	Monday to Sunday
	Bank 2 Event 7 Start Time	hh:mm
	Bank 2 Event 7 Duration	hh:mm
Bank 2 Event 8 Week	1-4	
Bank 2 Event 8 Day	Monday to Sunday	
Bank 2 Event 8 Start Time	hh:mm	
Bank 2 Event 8 Duration	hh:mm	

## 7 COMMISSIONING

**Before the system is started, it is recommended that the following checks are made:-**

- The unit is adequately cooled and all the wiring to the module is of a standard and rating compatible with the system. Check all mechanical parts are fitted correctly and that all electrical connections (including earths) are sound.
- The unit DC supply is fused and connected to the battery and that it is of the correct polarity.
- To check the start cycle operation, take appropriate measures to prevent S2 from starting (if configured as a generator by disconnecting the start output) and press the *Manual*  mode button. Check to see if the start signal energises.
- Set the modules internal clock/calendar to ensure correct operation of the scheduler and event logging functions. For details of this procedure see section entitled *Front Panel Configuration – Editing the date and time*.
- If, despite repeated checking of the connections between the controller and the customer's system, satisfactory operation cannot be achieved, then the customer is requested to contact the DSE Technical Support Department for further advice.



## 8 FAULT FINDING

### 8.1 STARTING

Symptom	Possible Remedy
Unit is inoperative Read/Write configuration does not operate	Check the battery and wiring to the unit. Check the DC supply. Check the DC fuse.
Unit shuts down	Check DC supply voltage is not above 35 Volts or below 9 Volts Check the operating temperature is not above 70 °C. Check the DC fuse.
Fail to Start is activated	Check wiring of the S2 sensing cables. Check the start output is correctly wired into the generator controller.
Continuous starting of S2 when in <i>Auto</i>  mode.	Check that there is no signal present on the "Remote Start" input. Check configured polarity is correct. Check the S2 supply available and within configured limits
S2 fails to start or go on load on receipt of Remote Start signal.	Check S2 Fail Delay timer has timed out.  Check signal is on "Remote Start" input. Confirm correct configuration of input is configured to be used as "Remote Start".

### 8.2 LOADING

Symptom	Possible Remedy
S2 supply present runs but does not take load	Ensure S2 is available and within configured limits and a load inhibit signal is not present on the module inputs. Check connections to the switching device. Note that S2 does not take load in manual mode unless there is an active remote start on load signal.

### 8.3 ALARMS

Symptom	Possible Remedy
Electrical Trip fault operates	Check relevant switch and wiring of fault indicated on LCD display. Check configuration of input.
Warning fault operates	Check relevant switch and wiring of fault indicated on LCD display. Check configuration of input.

## 8.4 COMMUNICATIONS

Symptom	Possible Remedy
RS485 inoperative	<p>Check :</p> <ul style="list-style-type: none"> <li>• Connection cable – Belden 9841 or equivalent</li> <li>• 120 Ω termination resistors are correctly fitted</li> <li>• Baud rate of controller and of master device are the same</li> <li>• Slave ID of the controller is the same as configured in the master device</li> </ul>
RS232 connection to PC inoperative	<p>Check :</p> <ul style="list-style-type: none"> <li>• RS232 maximum of 15 m is not exceeded</li> <li>• Direct to PC connection requires a Crossover (NULL modem) RS232 cable</li> <li>• Baud rate of controller and of master device are the same</li> <li>• Slave ID of the controller is the same as configured in the master device</li> </ul>
RS232 connection to GSM modem inoperative	<p>Check :</p> <ul style="list-style-type: none"> <li>• RS232 maximum of 15 m is not exceeded</li> <li>• Modem Initialisation strings in the DSE configuration is correct for the connected modem type</li> <li>• Modem is configured to 9600 baud</li> <li>• SIM card is CSD (circuit switched data) compatible</li> <li>• SIM card is not PIN locked</li> <li>• SIM card is correctly inserted</li> <li>• Antenna is correctly installed and is not inside an earthed metal cabinet / control panel</li> <li>• A good signal is available in the locality</li> </ul>
RS232 connection to landline modem inoperative	<p>Check :</p> <ul style="list-style-type: none"> <li>• RS232 maximum of 15 m is not exceeded</li> <li>• Modem Initialisation strings in the DSE configuration is correct for the connected modem type</li> <li>• Modem is configured to 9600 baud</li> </ul>

## 8.5 INSTRUMENTS

Symptom	Possible Remedy
Inaccurate S1 & S2 measurements on controller display	<p>Check that the CT primary, CT secondary and VT ratio settings are correct for the application.</p> <p>Check that the CTs are wired correctly with regards to the direction of current flow (p1,p2 and s1,s2) and additionally ensure that CTs are connected to the correct phase (errors occur if CT1 is connected to phase 2).</p> <p>Remember to consider the power factor. I.e (kW = kV A x powerfactor)</p> <p>The controller is true RMS measuring so gives more accurate display when compared with an 'averaging' meter such as an analogue panel meter or some lower specified digital multimeters.</p> <p>Accuracy of the controller is better than 1% of full scale. I.e S1 volts full scale is 333 V ph-n so accuracy is ±3.33 V (1% of 333 V).</p>

## 8.6 MISCELLANEOUS

**▲ NOTE:** The above fault finding is provided as a guide check-list only. As the module can be configured to provide a wide range of different features, always refer to the source of the module configuration if in doubt.

Symptom	Possible Remedy
Module appears to 'revert' to an earlier configuration	<p>When editing a configuration using the PC software it is vital that the configuration is first 'read' from the controller before editing it. This edited configuration must then be "written" back to the controller for the changes to take effect.</p> <p>When editing a configuration using the fascia editor, be sure to press the <i>Tick</i>  button to save the change before moving to another item or exiting the fascia editor</p>

## 9 MAINTENANCE, SPARES, REPAIR AND SERVICING

The controller is *Fit and Forget*. As such, there are no user serviceable parts within the controller. In the case of malfunction, contact the original equipment manufacturer (OEM).







### 9.1 PURCHASING ADDITIONAL CONNECTOR PLUGS FROM DSE

If additional plugs are required from DSE, please contact our sales department using the part numbers below.

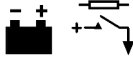
#### 9.1.1 PACK OF PLUGS

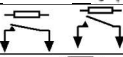
Module type	Plug Pack Part Number
DSE335	007-827

#### 9.1.2 INDIVIDUAL PLUGS

Module Terminal Designation	Plug Description	Part No.
1-8 	8 way 5.08 mm	007-164
9-17 	9 way 5.08 mm	007-167
18-24 	7 way 5.08 mm	007-447
25-29 	5 way 7.62 mm	007-473
30-37 	8 way 7.62 mm	007-454
38-41 <b>S1</b>	4 way 7.62 mm	007-171
42-47 	6 way 5.08 mm	007-446
48-53 	6 way 7.62 mm	007-162
<b>RS485</b>	3 way 5.08 mm	007-174

 **NOTE: Terminals 24 and 27 are fitted to controllers but must not be connected.**

### 9.2 PURCHASING ADDITIONAL FIXING CLIPS FROM DSE

Item	Description	Part No.
	Module fixing clips (packet of 4)	020-294



### 9.3 PURCHASING ADDITIONAL SEALING GASKET FROM DSE

Item	Description	Part No.
	Module silicon sealing gasket	020-507

## 9.4 DSENET EXPANSION MODULES

**NOTE:** A maximum of six (6) expansion modules can be connected to the DSEnet®.

**NOTE:** DSEnet® utilises an RS485 connection. Using Belden 9841 (or equivalent) cable allows for the expansion cable to be extended to a maximum of 1.2 km. DSE Stock and supply Belden 9841 cable. DSE Part Number 016-030.

Item	Max No. supported	Description	DSE Part Numbers			
			Model order number	Sales literature	Operator manual	Installation Instructions
	2	Model DSE2130 input module provides additional analogue and digital inputs for use with the controller.	2130-001-00	055-060	057-082	053-033
	2	Model DSE2157 expansion relay module provides eight additional voltage free relays for use with the controller	2157-001-00	055-061	057-083	053-034
	2	Model DSE2548 expansion LED module provides additional LED indications, internal sounder and remote lamp test/alarm mute for use with the controller.	2548-001-00	055-062	057-084	053-032

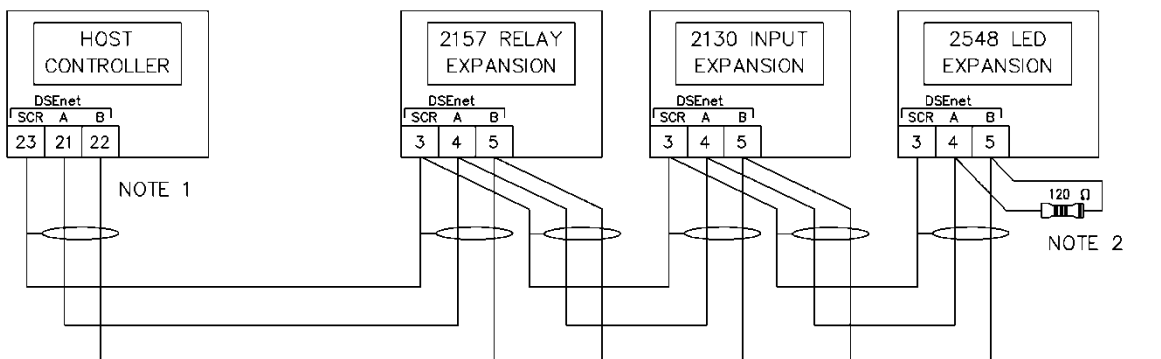

**NOTE 1**  
AS A TERMINATING RESISTOR IS INTERNALLY FITTED TO THE HOST CONTROLLER, THE HOST CONTROLLER MUST BE THE FIRST UNIT ON THE DSEnet

**NOTE 2**  
A 120 OHM TERMINATION RESISTOR MUST BE FITTED TO THE LAST UNIT ON THE DSEnet

## **10 WARRANTY**

DSE provides limited warranty to the equipment purchaser at the point of sale. For full details of any applicable warranty, refer to the original equipment supplier (OEM).

## **11 DISPOSAL**

### **11.1 WEEE (WASTE ELECTRICAL AND ELECTRONIC EQUIPMENT)**

If you use electrical and electronic equipment you must store, collect, treat, recycle and dispose of WEEE separately from your other waste.

*This Page is Intentionally Blank*

*This Page is Intentionally Blank*