



CSP2NX6D+QH6D Actual size

*QH6D Ratchet head
(Shown attached to the wrench is removable and sold separately)



Preset Type Interchangeable Head

Torque Wrenches

CSP6D

Series

Coordinating Interchangeable Heads

QH6D

SH6D

- Ideal for work in tight spaces
- QH6D and SH6D Interchangeable heads were designed specifically for the CSP6D series torque wrench with compact slimline dimensions
- Features torque set completion with distinctive feel and click
- CSP2NX6D: 0.4~2N·m
CSP5NX6D: 1~5N·m



Feature

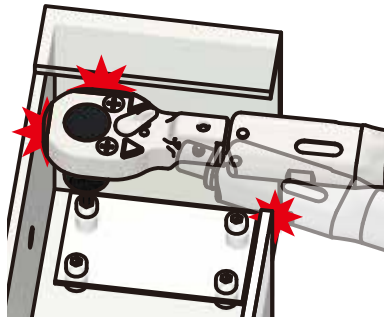

Long swing ratchet

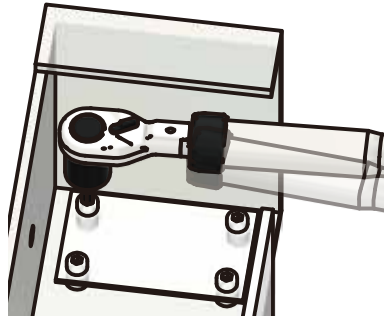

Interference Reduction

The slimmer body, smaller head, and halved swing angle drastically reduce the interference area of the tool.

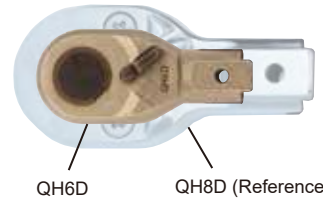

QH6D

QH8D (Reference)

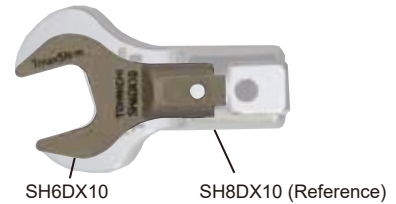

SH6DX10

SH8DX10 (Reference)



Clear Click Sound

The improved internal link design creates a more distinctive click making it easier to confirm torque completion.



48 Teeth Gear (QH6D)

The 48-tooth gear achieves a swing angle (7.5°) that is half of the conventional gear, preventing ratcheting loss and enabling quick tightening operations.



Precision Tightening Work

Knurling is effectively applied to visually and sensibly guide the user to the correct grip position.

*Correct grip position leads to accurate torque output.

CSP6D Series



CSP2NX6D

- Interchangeable, preset type torque wrench
- Use after torque setting
- Specify set torque value and torque unit when required initial torque setting

Accuracy $\pm 3\%$

Model	Torque Range			Force P [N]	Weight [kg]
	[N·m]	[kgf·cm]	[lbf·in]		
CSP2NX6D	0.4 ~ 2	4.0 ~ 20	3.5 ~ 17.7	17.5	0.06
CSP5NX6D	1 ~ 5	10 ~ 50	8.8 ~ 44.2	44	

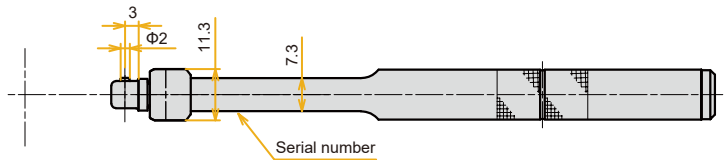
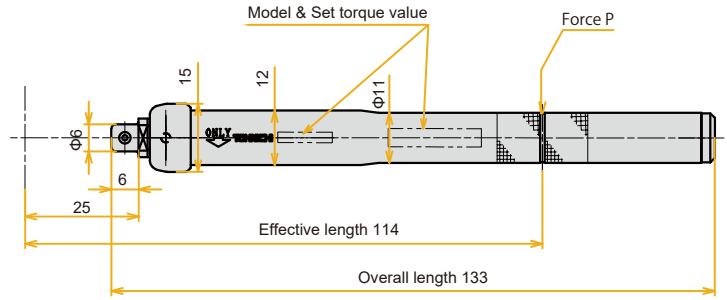

Optional accessories

Adjusting Tool

- Special tool for torque change.
- *A torque wrench tester is necessary for torque setting.

Part No.
931



Interchangeable Head for CSP6D Series

QH6D Ratchet head

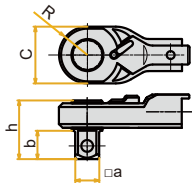

Head Size	Model	R (mm)	C (mm)	h (mm)	Sq. Drive □ a (mm)	b (mm)
	QH6D	7.5	15	15.5	6.35	7.5

- QH6D ratchet teeth 48 increments 7.5° swing angle improves workability (QH8D ratchet teeth in 24-tooth increments, swing angle of 15°)
- Improved accessibility makes it possible to accurately apply torque in narrow spaces.

SH6D Open Spanner Head

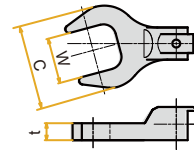

Head Size	Model (Body x AF size) (mm)	Outside Width C (mm)	Thickness t (mm)	Allowable Torque (N·m)
	SH6D× 5.5	13		1.5
	SH6D× 6	15	3	2.5
	SH6D× 7	17		3.5
	SH6D× 8	18		
	SH6D×10	20	4.5	
	SH6D×11	21		
	SH6D×12	22		
	SH6D×13	23		5
	SH6D×14	24		
	SH6D×16	26	5	
	SH6D×17	27		
SH6D×19	29			

Related New Product

Small Capacity Digital Torque Wrench Tester

- A wide range Tester that can calibrate all signal type torque wrenches of 10 Nm or less.
- For sensitive small-capacity torque measurement, developed loading mechanism with the square drive rotates.

Accuracy $\pm 1\% + 1$ digit

Model	Torque Range [N·m]		Inlet Drive [mm]	Weight [kg]
	Min. ~ Max.	1 Digit		
DOT10N4-G	0.2 ~ 10	0.001	6.35	7

* Multiple torque unit model: Metric unit: 2~100kgf·cm, 1 digit 0.01 kgf·cm, American unit 2~88lbf·in, 1 digit 0.01 lbf·in are selectable





Advanced Assembly, Critical Torque
& Ergonomic Handling Systems

844-KAS-TOOL - (844.527.8665)

www.keystoneassembly.com



■ TOHNICHI MFG.CO.,LTD.

E-mail: overseas@tohnichi.co.jp

Website: <http://www.global-tohnichi.com>

■ N.V. TOHNICHI EUROPE S.A.

■ TOHNICHI AMERICA CORP.

■ TOHNICHI SHANGHAI MFG. CO., LTD.

东仁扭矩仪器（上海）有限公司

■ Tohnichi Asia Technical Support Office (TATSO)

● Designs and specifications are subject to change without notice.
● All rights reserved. No reproduction or republication without written permission.
● ©Tohnichi Mfg. Co., Ltd. All Rights Reserved.