



Jets™ 59M Toilet is a wall hung pan design. With a focus on both simple elegant design and comfort, this wall mounted toilets contemporary look complements any installation.

**Technical Data**

Outside Dimensions.....540 x 365 x 420 mm (LxWxH)  
 General Tolerance.....Bowl dimensions ±2%  
 Discharge Valve Outlet.....Outside diameter Ø 50 mm  
 Water Connection.....½" male BSP  
 Generic Material.....Porcelain  
 Net Weight.....N/A  
 Coating.....Vitreous China

**Operating Data**

Flushing Time..... 5 seconds  
 Discharge Time..... 2 seconds  
 Water Pressure.....2-7 bar  
 Operating Vacuum.....Recommended 30-55 % Vacuum  
 Air Consumption.....Approx. 48 liters at 50% Vacuum  
 Water Consumption.....0.7L (2 bar)  
 Temperature Range..... Minimum 1°C  
 to Maximum 60°C  
 (unless frost protection measures are taken)

**Disclaimer**

Note: Our products and services are offered and sold subject to Jets Vacuum AS' General Sales Conditions, copies of which will be furnished upon request. Information provided herein is solely for information purposes, does not constitute any warranty or representation of any kind and is subject to change without notice. We strive to reproduce product colors reasonably accurate. Without prior written approval, this document or any part of may not be reproduced in any form. Jets™, Vacuumarator™, Helivac™, VC™, VOD™, CVS™ and Softsound™ are trademarks and/or registered trademarks of Jets. © Jets AS. All rights reserved.

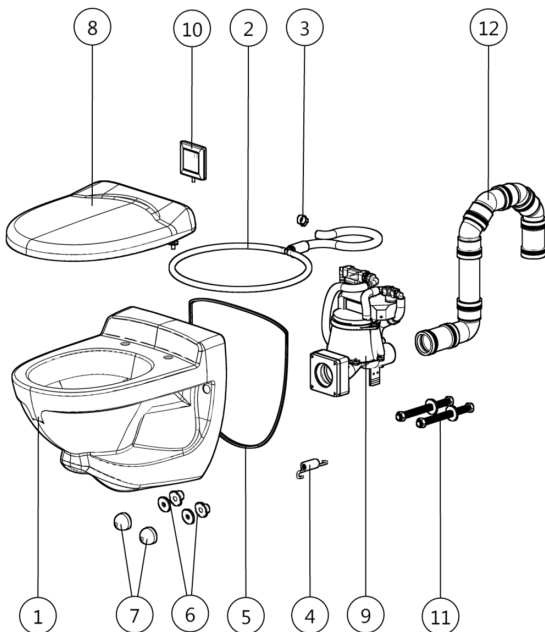

**Components**

1	Toilet Bowl JETS 59M .....	066005000*
2	Flushing ring .....	069510500*
3	Hose Clip 13-20mm .....	034233401*
4	Spring .....	053531725*
5	Coaming .....	037609312*
6	Fastening Kit, wall .....	069606400*
7	Cap .....	069606304*
8	Seat & Cover, Comfort .....	069608810*
9	CFV Valve 12VDC, Complete .....	055100150*
10	Release Button .....	100200150*
11	Fastening Kit, wall - Land .....	069606302*
12	Pipe Packet .....	034399400*

\* Component/s available as replacement parts.

Dimension Drawings

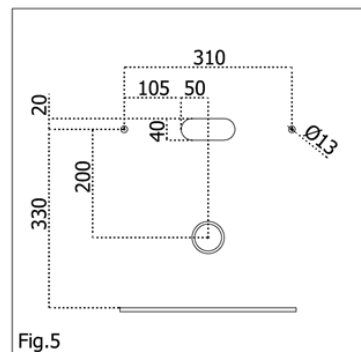
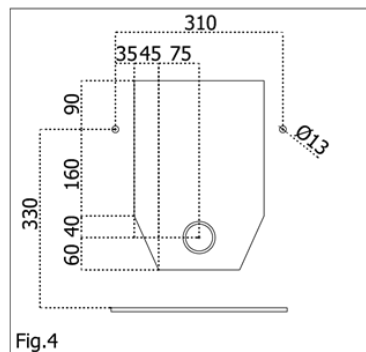
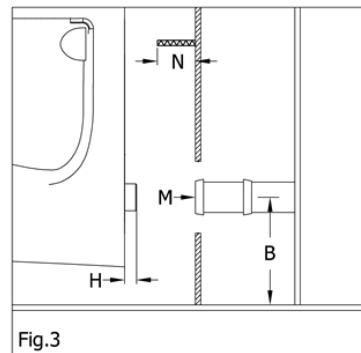
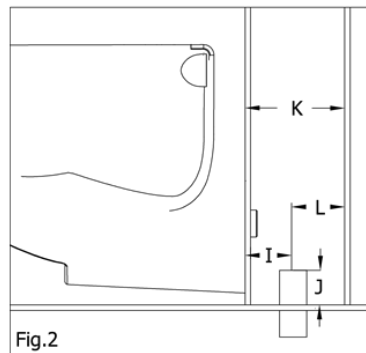
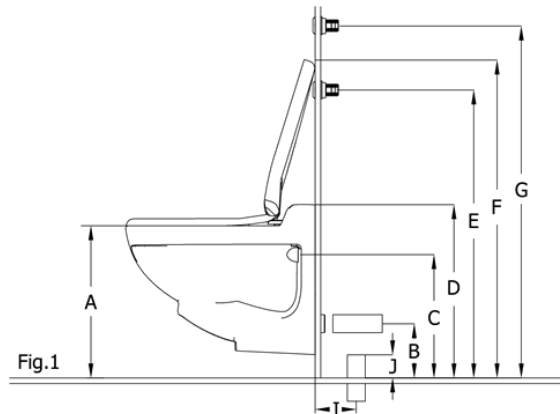

A.....	Approx. 410mm	H.....	25mm
B.....	130mm	I.....	70mm
C.....	330mm	J.....	95mm
D.....	475mm	K.....	I + L
E.....	Release button - normal height 670mm	L.....	Minimum 40mm
F.....	Approx. 860mm	M.....	(flush to wall) 0mm
G.....	Release button - public toilet height 950mm	N.....	Bolt length (outside exterior wall) 70mm

- Fig 1-3 Pipe Connection Dimensions - All measurements given are based on use of a Jets™ rubber elbow/pipe sleeve (required between the pipe and the valve).
- Fig 4 Full wall cutout  
This cutout should be used if the toilet valve protrudes from the bowl or if maintenance can be carried out from behind the toilet without removing the toilet bowl from the wall.
- Fig 5 Minimum wall cutout  
This cutout should be used for the water connection/vacuum breaker/release button and outlet pipe and if the toilet bowl is to be removed from the wall for maintenance.

## Important Health and Safety Information





Installation, operation and maintenance must be carried out in strict accordance with this guide and with all applicable regulations. For your own protection and the protection of others, it is necessary to familiarize yourself with, and always follow, the contained safety and environmental precautions for our products.

This manual is an integral part of the product/delivery. Always keep it in a safe place for future reference. It is entirely the owner's responsibility to ensure that all safety and environmental measures, in accordance with local, state and federal laws are followed. Jets Vacuum AS assumes no responsibility for equipment damage, personal injury or death and/or delays that result from a lack of respect for the instructions for installation and/or use as stated in this documentation. Disregarding these instructions may invalidate all warranties.











Safety information references are in accordance with Jets Vacuum AS documentation system. If you do not understand the warnings, stop work immediately and contact Jets Vacuum AS (citing the safety reference number) for further clarification.

For further information about the included warnings or any other safety concerns please contact Jets Vacuum AS.

## Safety Warning Symbols

-  General information to all users.
-  Symbol denotes required personal protective equipment is required.
-  CAUTION: Indicates a potentially hazardous situation which, if not avoided, may result in minor or moderate injury or equipment damage.
-  Symbol denotes required personal protective equipment is required.
-  DANGER: Indicates an imminently hazardous situation which, if not avoided, will result in death or serious injury or equipment damage.

## Important Health and Safety Warnings

-  **1.1 Warning**  
Jets Vacuum AS recommend qualified person(s) in accordance with all applicable codes and standards to carry out all installation work, electrical wiring, plumbing and operate this product. Equipment damage, injury to personnel or death could result from improper installation/use.
-  **1.2 Warning**  
Be thoroughly familiar with the controls and the proper use of the equipment prior to installing, starting or using the equipment. Know the equipment application, limitations and potential hazards.
-  **1.3 Warning**  
Failure to properly lift and support equipment can result in serious physical injury and/or equipment damage. Lift equipment only at specifically identified lifting points or as instructed in the current IOM. Note: Lifting devices (eyebolts, slings, spreaders, etc.) must be rated, selected, and used for the entire load being lifted.
-  **1.4 Caution**  
Safety equipment (PPE) necessary for the prevention of accidents at the installation and operating site must be provided in accordance with local regulations.
-  **1.5 Personal Protective Equipment - Goggles**  
Wear safety glasses with side shields at all times when working with equipment.
-  **1.6 Warning**  
Keep work area clean, uncluttered and ensure adequate lighting.
-  **1.7 Warning**  
Keep other persons at a safe distance from work area.
-  **1.9 Personal Protective Equipment - Gloves**  
Wear suitable protective gloves at all times when working with equipment.
-  **2.14 Warning**  
The equipment safety is guaranteed only if used in compliance with the instructions provided. Do not exceed the limits provided.
-   **12.5 Notice**  
Use this equipment only in the manner intended by Jets Vacuum AS. If you have questions after reading these instructions contact Jets Vacuum AS directly.

## Delivery, Receipt of Goods and Transportation

Goods to be protected against shock, dust, humidity and frost. Suitable adequately dimensioned transporting equipment is to be used. Note that the equipment may contain components that are easily damaged as a result of inappropriate handling. Jets Vacuum AS is not responsible for or liable for delivery delays resulting from occurrences outside of Jets Vacuum AS' immediate control. On receipt of goods, check for visual damage. Any damage detected after dispatch should be reported immediately to Jets Vacuum AS. Damages and/or discrepancies must be reported in writing no later than eight (8) days after receipt of goods. Commissioning must be postponed until the equipment has been inspected. Do not dispose of damaged items. Your direct supplier will advise you of the procedure to follow.

## Storage

Unless otherwise specified, goods are to be stored in a dry environment between -30°C and +40°C prior to installation. The storage location must be dust free, low humidity (≤95%) and be free from moisture. Keep clear of foreign objects.

## Installation to End Use

Site to be a dry environment between +0°C and +60°C. Use in environments below 0°C requires use of antifreeze in liquids. The site location is to be low vibration Vrms <0.2 mm/s) with vibration resistance to acceleration up to 0.7g. The site is to be dust free and protected from grinding and welding. Goods are to be stored as per the instructions for delivery, storage and transport. A visual inspection is to be carried out on receipt of goods as well as at the time of installation to ensure that storage and transport conditions after receipt have not compromised the quality of the product/s.

## Pre-Installation

### Standards and Regulations

To install a Jets™ product, it is first required that the room be prepared according to all local, state and federal standards and requirements. Industry specific standards must also be met. Considerations that must be made include but are not limited to:

- Appropriate dimensioned drain pipes.
- Water barrier or membrane.

Installations required to meet AS/NZS 3500 series of Standards must adhere to the following:

(Ref: Australian and New Zealand Standards: AS/NZS 3500 - AS3500 Part 2 Sanitary Plumbing and Drainage )

- Discharge by a vacuum toilet system shall be regarded as "pumped discharge" and shall be pumped according to AS/NZ3500 "Pumped Discharge" requirements.
- Installation of the vacuum toilet system shall be according to the requirements of AS/NZ 3500.2 Sanitary Plumbing and Drainage.

### Tools and Training

No special tools other than those used in standard plumbing installations are required. No special training is required to install this product.

### Water Barrier

Note that in some countries, and as per the majority of standards and regulations, it is prohibited to mount toilets directly onto the wall if mounting requires that the water barrier be compromised. Check requirements according to local codes and standards before beginning any installation work.

### Pre-Installation Considerations

It is recommended that items such as wall mounted release buttons, drainage and piping etc. is installed prior to installation of the toilet.

The toilet is delivered with a fastening kit aimed at installation on existing wall mounted bolts. If you do not have existing wall mounted bolts, a fastening kit that includes the mounting bolts may be purchased through your Jets Vacuum AS supplier.

Bolts should be installed on adequately dimensioned weight bearing studs or a suitable mounting frame. Ensure that mounting bolts are positioned horizontally.

### Connection with Mains Water

The toilet valve connection required is a 1/2" BSP standard connection. The water pressure must be a minimum of 2 bar and must not exceed 7 bar.

### Connection without Mains Water

The toilet valve may be connected to a local water supply such as a container, tank or can. A water pump must be used. Refer to the individual product data sheet for further instructions regarding connections.

### Backflow Prevention

Backflow Prevention

Please refer to local, state, federal and/or international regulations regarding the extent of backflow requirements for your specific installation.

For installations whereby the valve is to be connected to a drinking water supply, it is recommended that the water connection is installed with a backflow prevention device. Please refer to the local regulations in your area. If backflow prevention is required in Australia, refer to AS/NZ3500.1 Backflow Prevention.

### Pre-Installation Wall Preparation

The toilet is a wall mounted model which can be installed in locations where:

- a service hatch, cabinet or utilities room is available.
- the toilet bowl is to be removed from the wall for service.

For retrofit installations, contact your local approved supplier or Jets Vacuum AS for further information.

## Toilet Connections

Installation may vary depending on plumbing arrangements.

## General Installation Information

To avoid leakage between the toilet valve and the toilet bowl, it is important that the pipe installation is properly clamped and aligned. Water hoses must be secured with hose clips.

## Installation

### General Disclaimer

Drawings provided in the following examples are for illustration purposes only. Product details may vary from your individual purchase.

### Installation Instructions

Toilet installation requires the following procedures to be carried out. For more specific technical details, refer to the individual data sheet. For further information on any of the instructions supplied, any questions regarding installation or the products, please contact your local supplier or Jets™ Service Department.

1

### Prepare the Wall Mounting

Prepare the wall mounting as per the instructions above. Note that the toilet may be mounted on appropriately positioned pre-existing mounting bolts, bolts installed for the purpose of mounting this toilet or an appropriately dimensioned mounting frame.

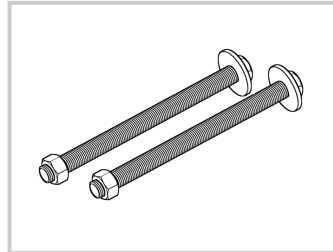

2

Install the fastening kit to the wall.  
To be used for hanging the toilet.

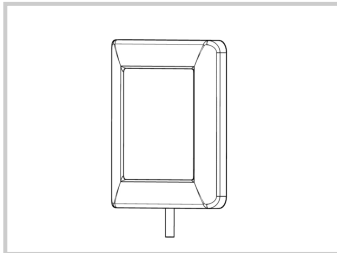

3

Install the release button to the wall.  
For installation information refer to the release button's technical data sheet.

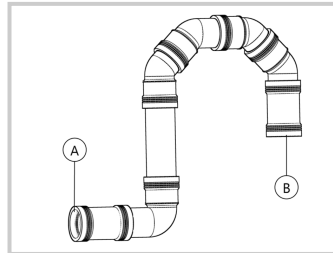

4

Connect the pipe packet/piping between the vacuum pump and the toilet.  
A - Toilet  
B - Vacuum Pump

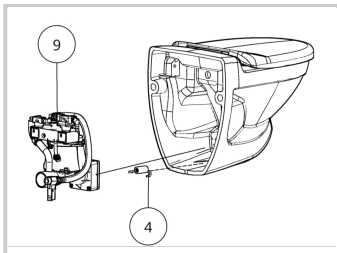

5

Install the toilet valve ⑨ and spring ④, as per the products installation instructions found in the products technical data. Note: Only for deliveries supplied without a pre-installed valve.

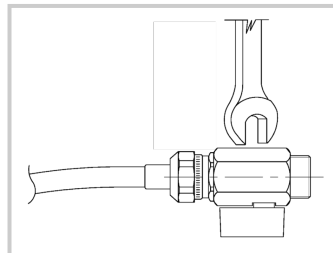

6

Move the toilet close to the wall.  
Connect the ball valve from the toilet valve to the water main.  
Note: Do not over tighten.

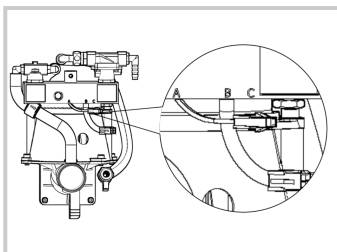

7

Toilet Valve Cable Connections.  
Connect as follows:

- A - for Release Button.
- B - for VTS Controller.

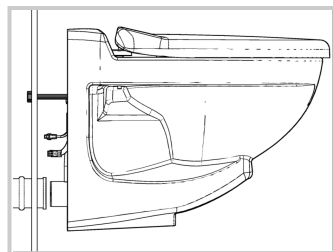

8

The toilet is to be positioned with the mounting bolts through the mounting holes in the porcelain bowl.

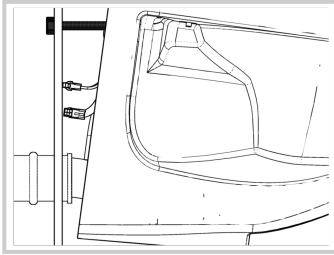

9

When lowering the toilet bowl into position on the bolts, ensure that the valve outlet is securely fitted in the outlet pipe in the wall.

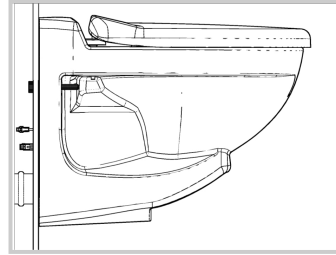

10

The bowl should be even and aligned with the wall surface.

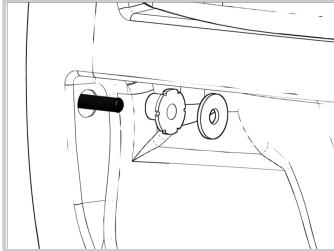

11

Fit the fastening kit to secure the toilet to the mounting bolts.

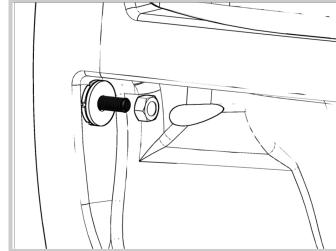

12

Secure the nut firmly without over-tightening.

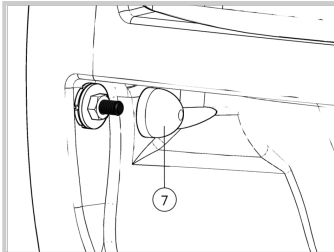

13

Apply the cap's ⑦ over the nuts.

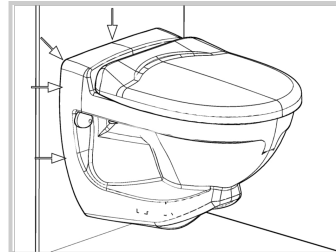

14

Apply the coaming between the finished wall surface and toilet bowl for a fine finish.

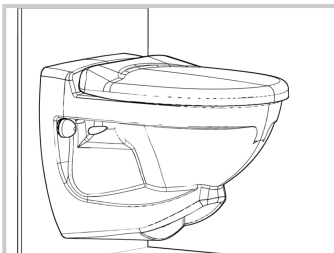

15

Completed.

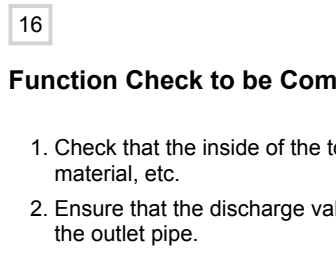

16

**Function Check to be Completed Prior to Use**

1. Check that the inside of the toilet bowl is empty of packaging material, etc.
2. Ensure that the discharge valve has been securely connected to the outlet pipe.
3. Check that the water supply is connected and water pressure is adequate.
4. Turn on the water supply.
5. Press the release button to activate the valve.
6. Check that the bowl fills with water.
7. Check that sufficient vacuum is created when activating the release button to release the contents of the bowl.
8. Check that the water level in the bowl is restored.
9. Check that water is dispersed on the bowl surface by the flushing mechanism.
10. Check that there are no water or air leaks.

## Service and Maintenance

### Out of Use

The following procedures are to be followed if a toilet is to be out of use over a longer period of time (i.e. for cabins and recreational houses).

1. Close the water supply to the toilet.
2. Activate the release button to run a flush cycle, emptying the toilet of water.
3. Close the toilet seat cover.
4. CAUTION: This toilet is not intended for use in temperatures below freezing without appropriate antifreeze measures being taken. For locations where freezing may occur, certain protection measures must be taken. For further information contact Jets Vacuum AS or your nearest supplier for a copy of technical information regarding freezing protection measures.
5. CAUTION: Never use automotive antifreeze (ethylene glycol) in the toilet system.
6. Turn off the power.

NOTE: Failure to adequately protect the toilet system from damages may result in void of your warranty coverage.

NOTE: Jets Vacuum AS reserves the right to deny any warranty claim submitted if the claim is caused by freezing damage.

### Cleaning Instructions

1. Mild soap or biological cleaners are recommended for cleaning the toilet. See Jets™ product range for suitable cleaning solutions.
2. Do not use cleaners that create foam.
3. The toilet is to be cleaned regularly to maintain hygiene. Also note that maintaining water in the toilet bowl will prevent odors.
4. Do not use drain cleaner, bleach or other caustic cleaners. These types of cleaners can damage components in the toilet system and damage the seat and cover hinges.
5. For mineral scale buildup, we recommend use of Jets Vacuum AS biological descale products. Contact your Jets Vacuum AS supplier for information.

### Spare Parts and Accessories

Available spare parts are indicated in the component list for the toilet. Spare parts and accessories can be ordered via your local Jets Vacuum AS supplier. For multi-toilet installations, a complete recommendation for spare parts is available. Contact your Jets Vacuum AS supplier for details.

### Service and Maintenance

Jets Vacuum AS provides all customers with 24 hour worldwide technical assistance. For urgent matters please contact Jets Vacuum AS service department directly at +47 70039100. For other matters, please contact your nearest Jets Vacuum AS supplier.

1. Disassembly of the toilet must be carried out by a licensed professional.
2. All local, state and federal regulations regarding water barriers and plumbing must be adhered to.
3. Refer to the individual product data sheets for more specific information. Refer to the products troubleshooting information for general maintenance.
4. It is recommended that service and maintenance routines be carried out in accordance with the information in this document.

When making enquiries, please have the following information available.

1. Toilet model number.
2. For valve enquiries: Valve serial number (the serial number identification is located on the label applied to the valve).
3. Part number, description, quantity (see the product component list for details).

### Locating a Water Leak

Make a practice of regularly checking around the toilet, piping and pump for any signs of a water leak. Check for wetness, mold or foul smells, as that might indicate a leak.

If you suspect a leak anywhere in your plumbing system, call in a professional to make a repair as soon as possible.

### Scheduled Maintenance

Interval	Action	Note
Regularly - dependent on frequency of use.	Clean the toilet.	Clean the toilet as per instructions provided in the products technical information.

As required.

Check for damage to equipment.  
Replace or repair damaged equipment  
and take measures to prevent future  
damage to the system.

Note that frost or freezing may damage sanitary systems if  
precautions have not been taken. Contact your nearest  
Jets™ supplier for information on Jets™ range of frost  
protection products for installations in cold climate  
locations.

### Troubleshooting

Jets Vacuum AS provides the following troubleshooting information to assist in resolving issues that may arise with your installation. For more detailed information or assistance, please contact Jets Vacuum AS.

Problem	Cause	Action
Water is refilled in the toilet, but the content is not discharged	Loss of vacuum in the toilet system or piping system.	Check the vacuum level to ensure that it is adequate.
		Check the water level in the pump to ensure that it is adequate.
		Check the pipes and any connected equipment including the valve, pump etc. for foreign objects. Remove any blockages in the system.
The normal water level in the toilet bowl is reducing or low.	Low water pressure.	Check that there is no damage to the piping system.
		Increase the water pressure.
The toilet bowl is slow to empty.	The pump or pipes are blocked.	Check the filter in the water connection or ball valve to ensure that it is not blocked. Replace the filter if required.
		Build up of urine scale in the pipes and/or pump.
Air bubbles in the toilet bowl.	Blocked pipe outlet.	Check for mineral scale build-up and descale the affected areas. See Jets™ selection of cleaning products for this purpose.
		Backflow in the installation.
	The Non-return Valve on the discharge line (if installed) is malfunctioning.	Check the pipes have been correctly installed.
	If connected to a tank, the tank could be full or the air overflow blocked.	Clean the Non-return Valve.
		Check that the air overflow is open.
		Empty the tank.