

Features:

- 650V Schottky Diode
- Zero Reverse Recovery Current
- High Frequency Operation
- Positive Temperature Coefficient
- Temperature independent

Switching

Benefits:

- Unipolar Rectifier
- Minimal switching loss
- Higher Efficiency
- Low cooling requirement

Symbol	Value	Unit
V_{RRM}	650	V
I_F ($T_C = 161^\circ\text{C}$)	6	A
Q_C	26	nC

Applications:

- Switch Mode Power Supply
- Booster diodes in PFC, DC/DC
- AC/DC converters

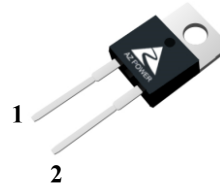
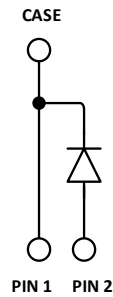
Outline

TO-220-2L
Circuit

Maximum Ratings

Symbol	Parameter	Value	Unit	Test Conditions
V_R	DC Peak Reverse Voltage	650	V	$T_J = 25^\circ\text{C}$
V_{RRM}	Repetitive Peak Reverse	650	V	$T_J = 25^\circ\text{C}$
V_{RSM}	Surge Peak Reverse Voltage	650	V	$T_J = 25^\circ\text{C}$
I_F	Continuous Forward Current	26	A	$T_C = 25^\circ\text{C}$
		14		$T_C = 135^\circ\text{C}$
		6		$T_C = 161^\circ\text{C}$
I_{FRM}	Repetitive Peak	56	A	$T_C = 25^\circ\text{C}, T_p = 10\text{ms}, \text{Half Sine Wave}$
	Forward Surge Current	50		$T_C = 125^\circ\text{C}, T_p = 10\text{ms}, \text{Half Sine Wave}$
I_{FSM}	Non-Repetitive Peak	74	A	$T_C = 25^\circ\text{C}, T_p = 10\text{ms}, \text{Half Sine Wave}$
	Forward Surge Current	67		$T_C = 125^\circ\text{C}, T_p = 10\text{ms}, \text{Half Sine Wave}$
P_D	Power Dissipation	120	W	$T_C = 25^\circ\text{C}$
		40		$T_C = 125^\circ\text{C}$
$T_{J,max}$	Operating Junction Temperature	175	$^\circ\text{C}$	
T_{stg}	Storage Temperature Range	-55 to 175	$^\circ\text{C}$	

Thermal characteristics

Symbol	Parameter	Min.	Typ.	Max.	Unit
R_{thJC}	Thermal Resistance		1.25		$^{\circ}C/W$

Electrical Characteristics

Symbol	Parameter	Value			Unit	Test Conditions
		Min.	Typ.	Max.		
V_{DC}	DC Blocking Voltage	650			V	$I_R = 100\mu A, T_J = 25^{\circ}C$
V_F	Forward Voltage		1.4 1.65	1.6 1.9	V	$I_F = 6A, T_J = 25^{\circ}C$ $I_F = 6A, T_J = 175^{\circ}C$
I_R	Reverse Current		1 10	30 100	μA	$V_R = 650V, T_J = 25^{\circ}C$ $V_R = 650V, T_J = 175^{\circ}C$
Q_C	Total Capacitive Charge		26		nC	$I_F = 6A, dI/dt = 400A/\mu s$ $T_J = 25^{\circ}C, V_R = 400V$
C	Total Capacitance		329 45 43		pF	$V_R = 1V, T_J = 25^{\circ}C, f = 1\text{ MHz}$ $V_R = 200V, T_J = 25^{\circ}C, f = 1\text{ MHz}$ $V_R = 400V, T_J = 25^{\circ}C, f = 1\text{ MHz}$

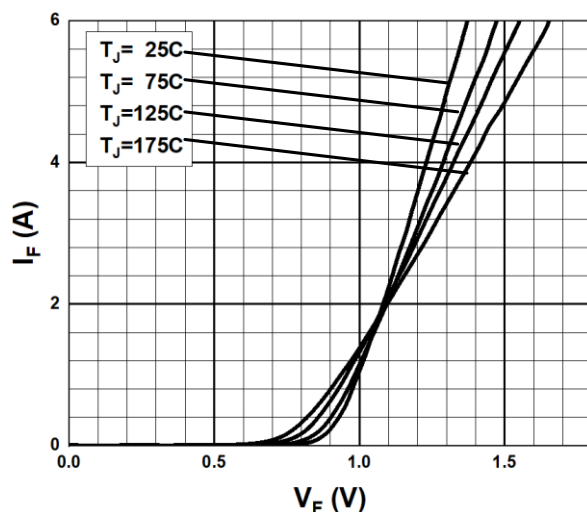
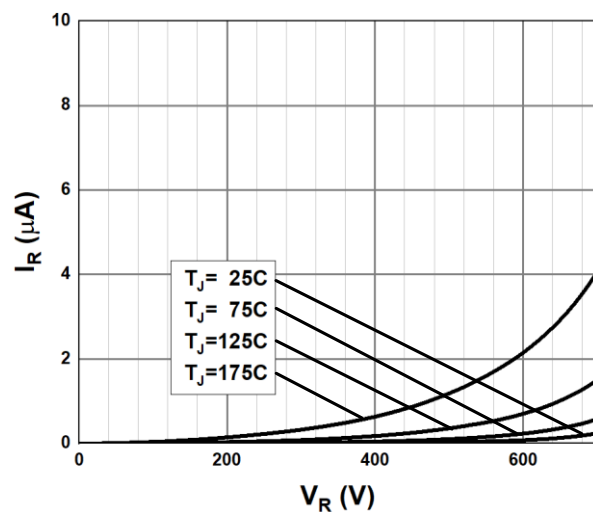
Typical Performance

Fig. 1 Forward Characteristics

Fig. 2 Reverse Characteristics

Typical Performance

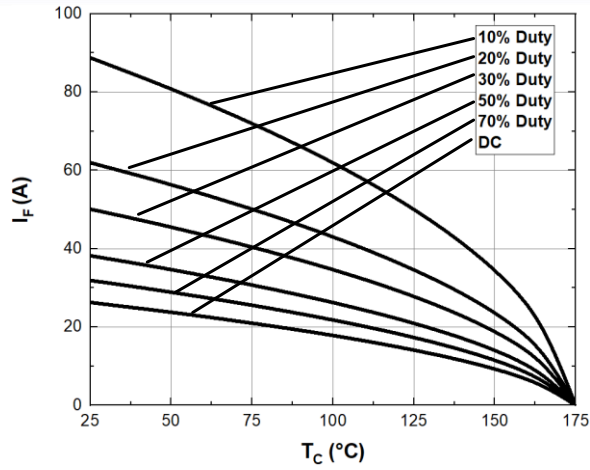

Fig. 3 Current Derating

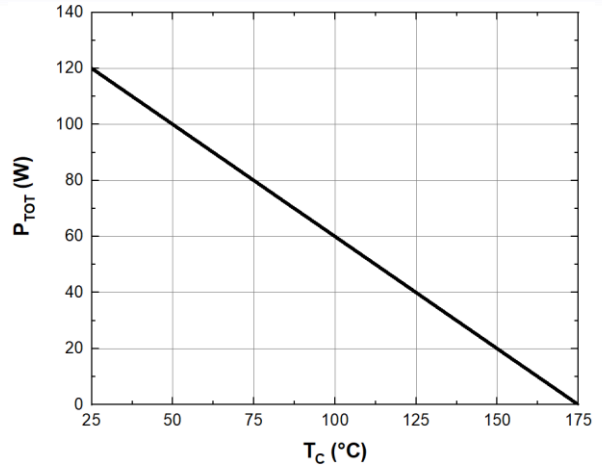

Fig. 4 Power Derating

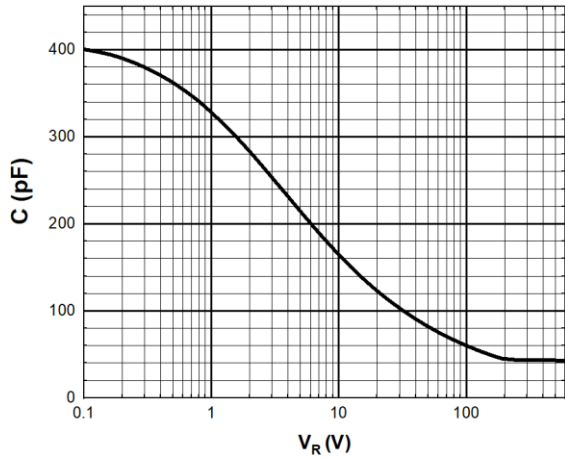

Fig. 5 Capacitance vs. Reverse Voltage

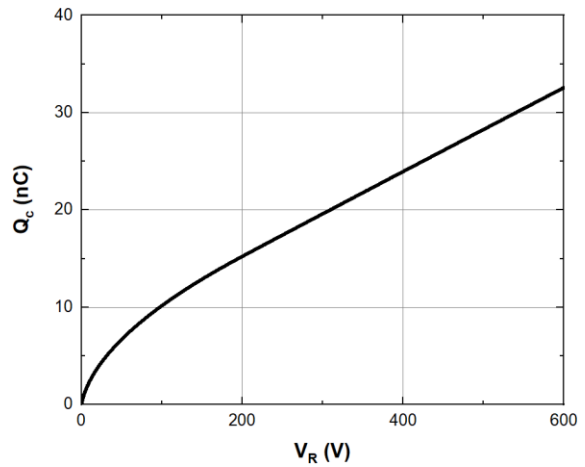

Fig. 6 Recovery Charge vs. Reverse Voltage

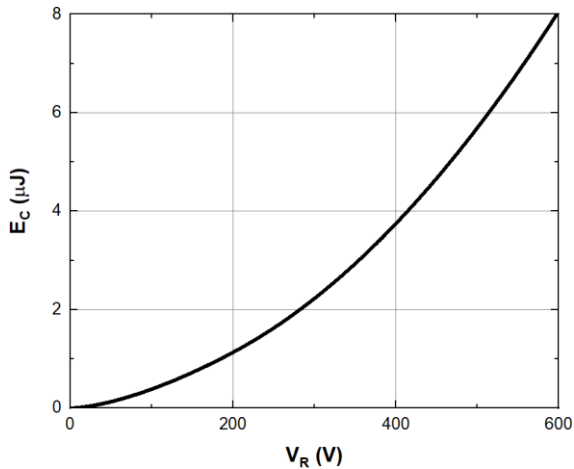

Fig. 7 Capacitance stored Energy

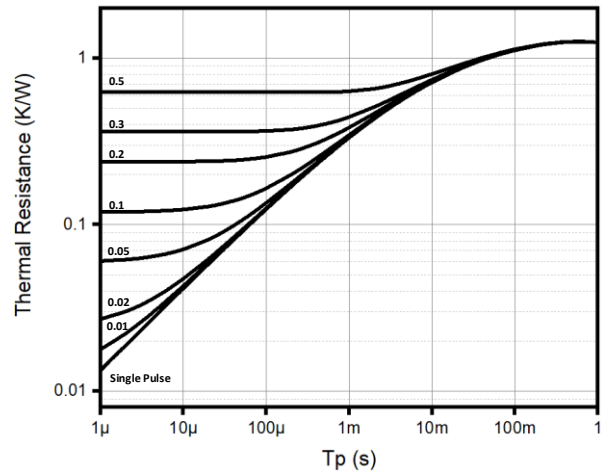
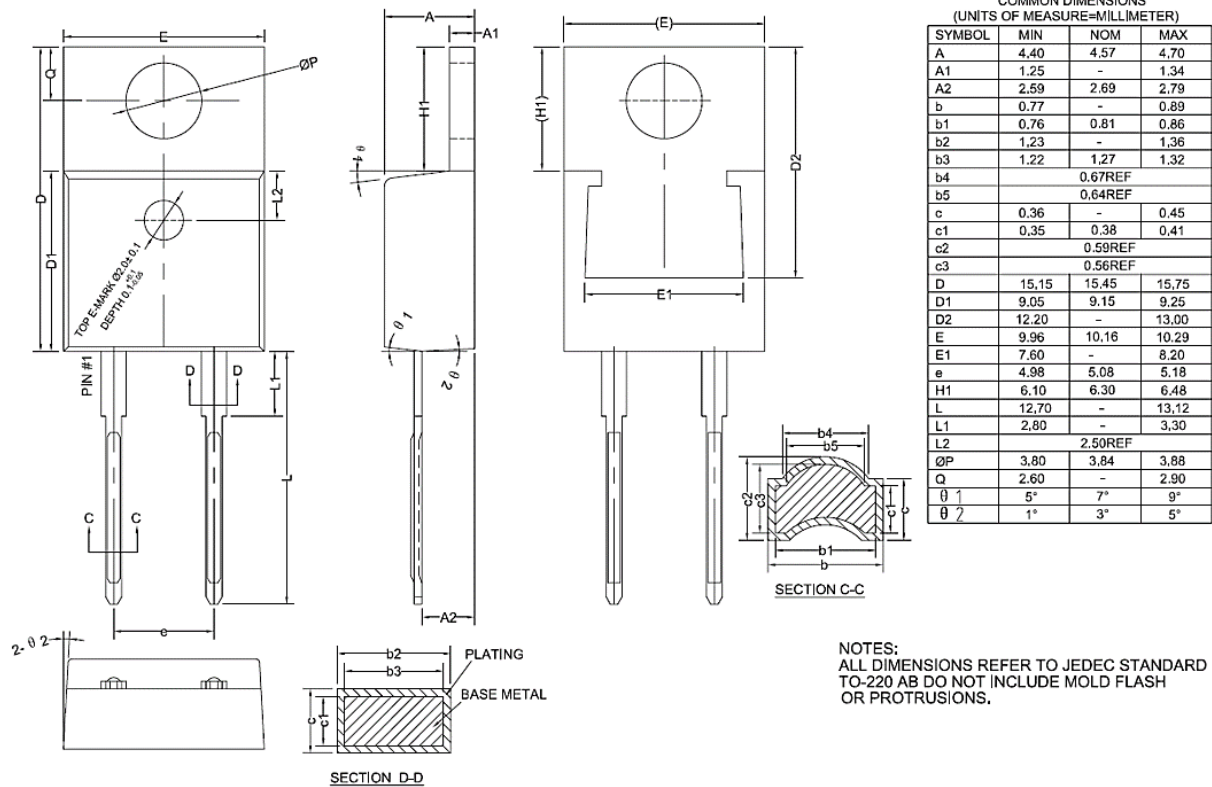

Fig. 8 Thermal Impedance

Package TO-220-2L (Unit: mm)



This Product has not been designed or tested for use in, and is not intended for use in, applications implanted into the human body nor in applications in which failure of the product could lead to death, personal injury or property damage, including but not limited to equipment used in the operation of nuclear facilities, life-support machines, systems, or air-traffic control systems.

The information given in this document shall in no event be regarded as a guarantee of conditions or characteristics. With respect to any examples, hints or any typical values stated herein and/or any information regarding the application of the product, AZ Power Inc. disclaims any and all warranties and liabilities of any kind, including without limitation warranties of non-infringement of intellectual property rights of any third party.