

TEXAS WOOD SUPPLY

MOULDING CATALOG

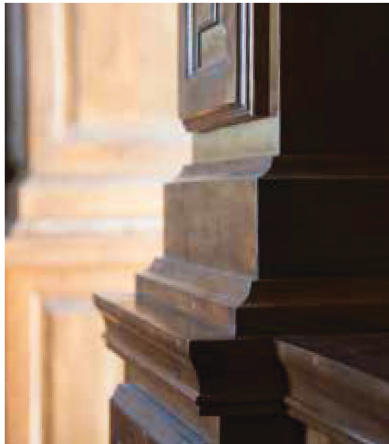

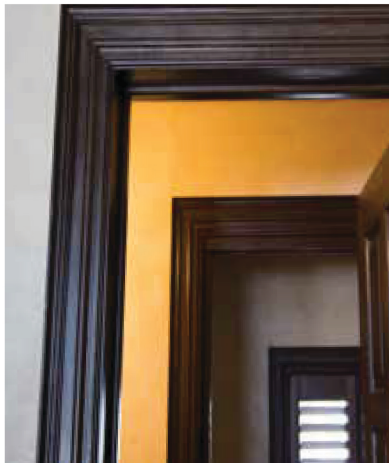

Texas Wood Supply wants to be known for the best product, the most dynamic range of product customization and the best customer service in Texas.

Come compare the quality of our products. Come see the difference working with a true specialist in quality wood products can make.

For location information and to find out more about our other products, visit us at:

www.texaswoodsupply.com

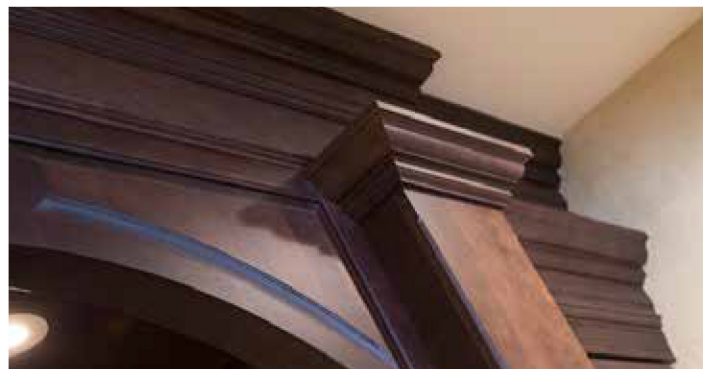



WE BRING CRAFTSMANSHIP & TECHNOLOGY TOGETHER.

MOULDING COLLECTIONS	PG 1
CROWNS	PG 9
BASE & CASING	PG 28
CHAIR RAILS	PG 64
PANEL MOULDS	PG 73
CABINET MOULDS	PG 80
COVES & CORNERS	PG 85
WINDOWS, DOORS, & SPECIAL USE	PG 89
FLOORING & SIDING	PG 98

**TEXAS
WOOD SUPPLY**

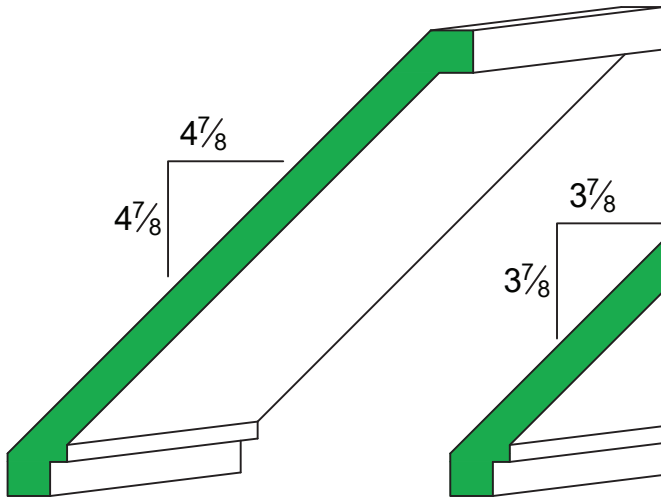

M1238
5/8 x 6 7/8

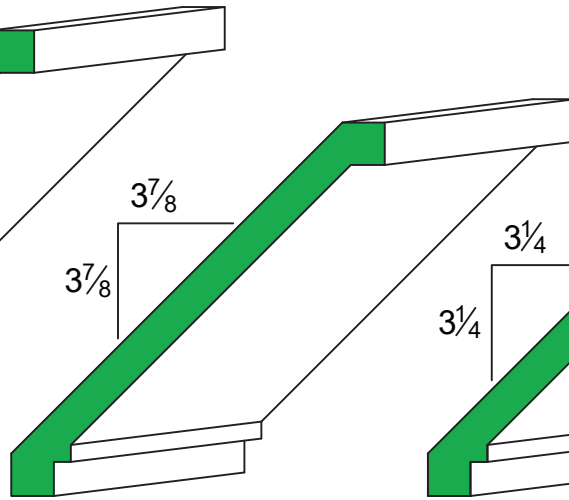

M1236
5/8 x 5 1/2

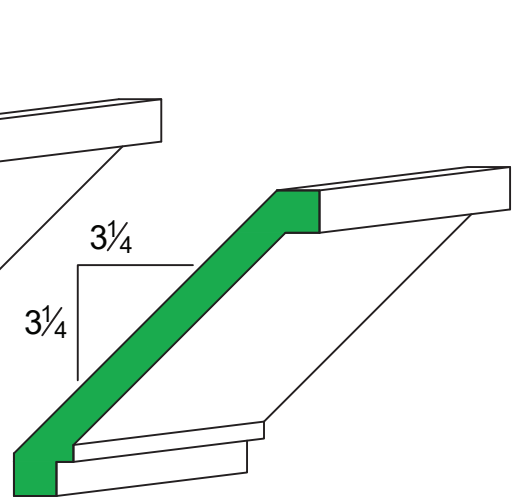

M1234
5/8 x 4 1/2

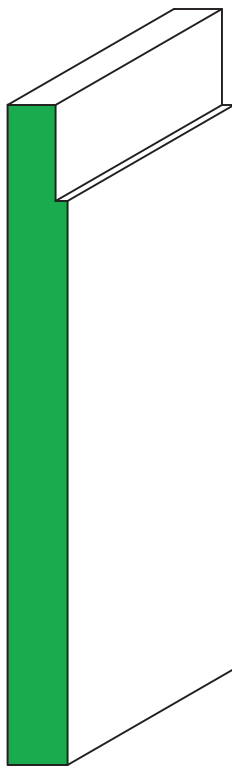

M2308
5/8 x 6 7/8

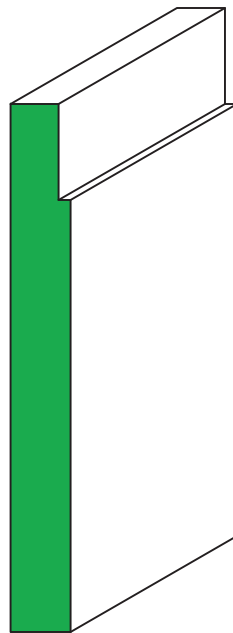

M2306
5/8 x 5 1/2

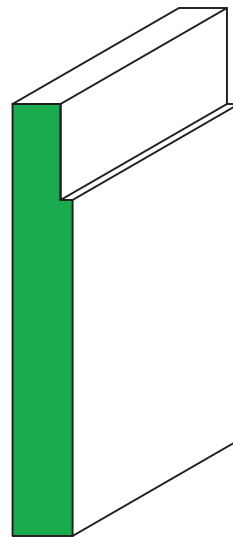

M2305
5/8 x 4 1/2

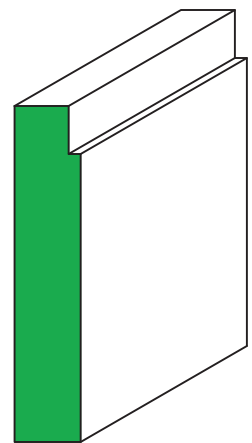

M2304
1 1/16 x 3 1/2

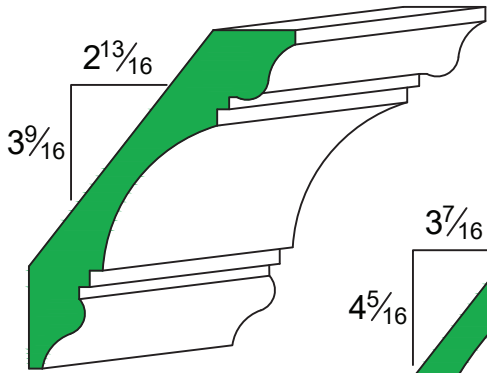

M1270
1 3/16 x 4 1/2

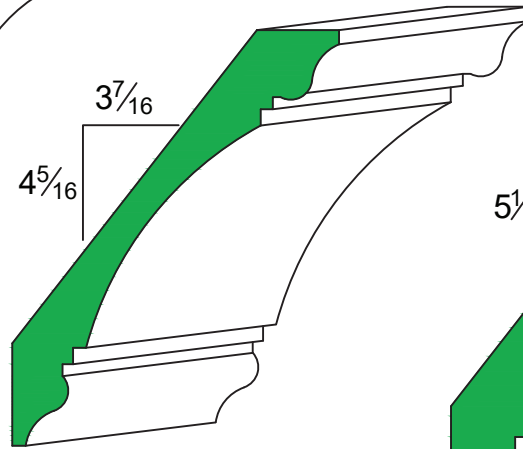

M1272
1 3/16 x 5 1/2

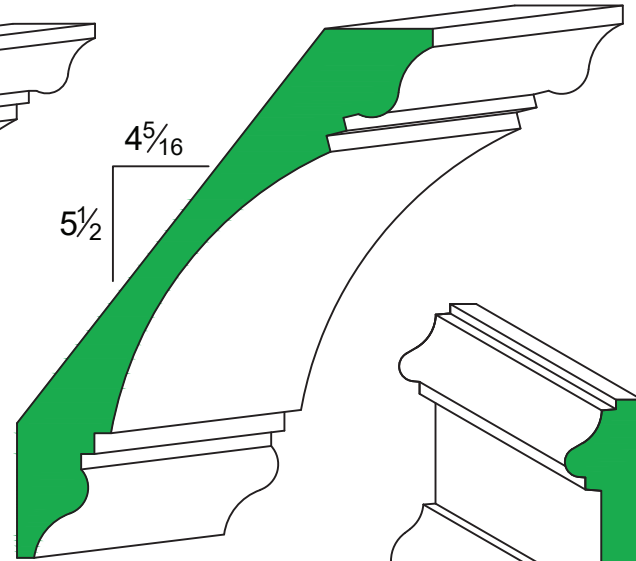

M1274
1 1/16 x 7

M2271
1 1/16 x 3 1/2

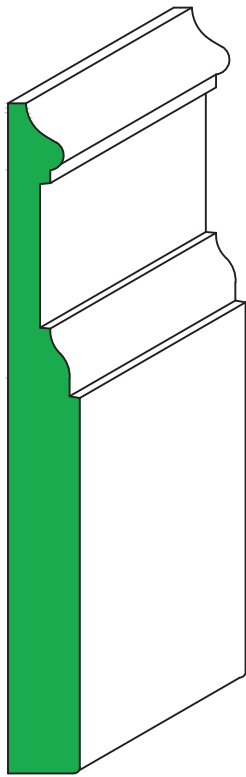

M2278
3/4 x 7

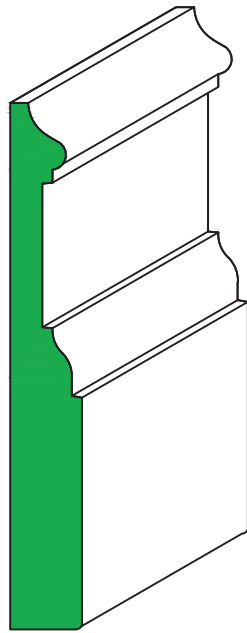

M2276
3/4 x 5 1/2

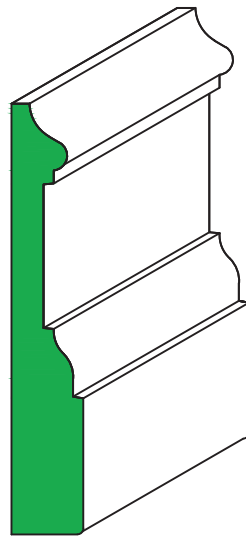

M2274
3/4 x 4 1/2

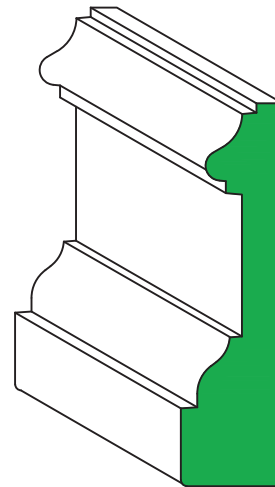

M2272
1 1/16 x 4

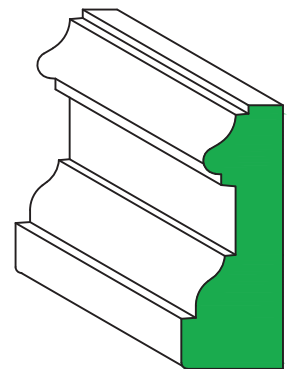

M2270
1 1/16 x 2 3/4

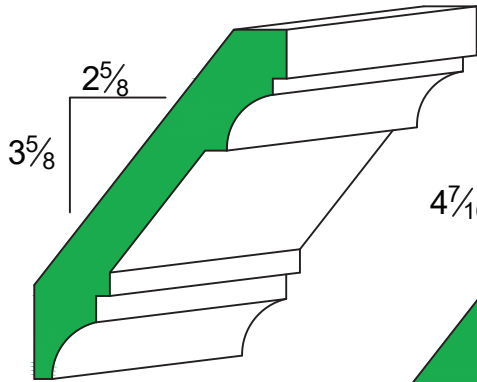

M1292
3/4 X 4 1/2

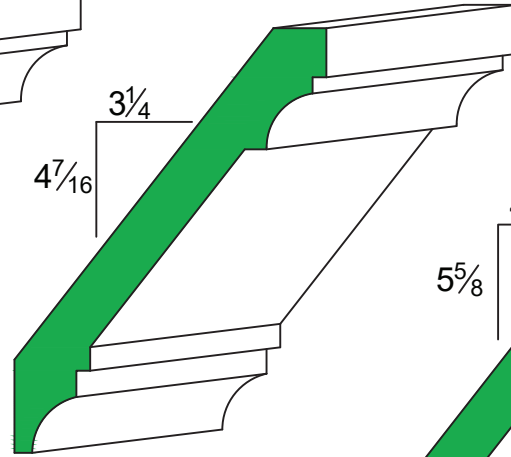

M1294
3/4 X 5 1/2

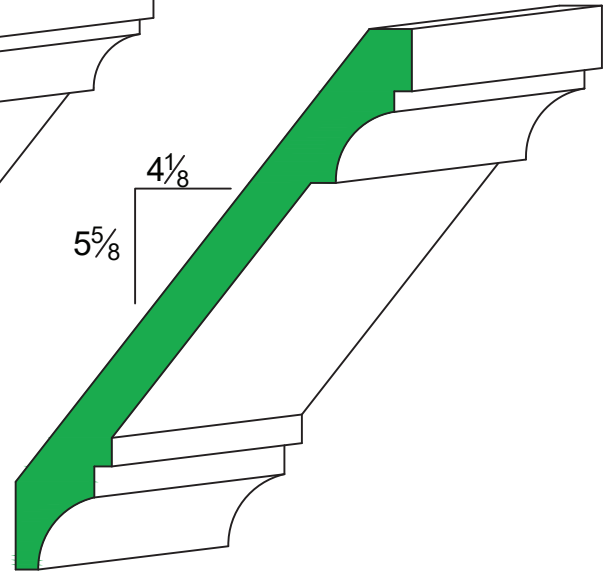

M1296
3/4 X 7

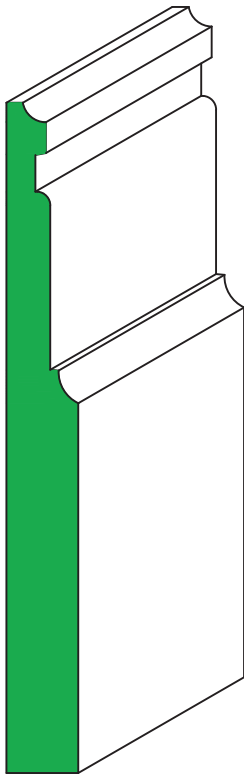

M2296
3/4 X 7

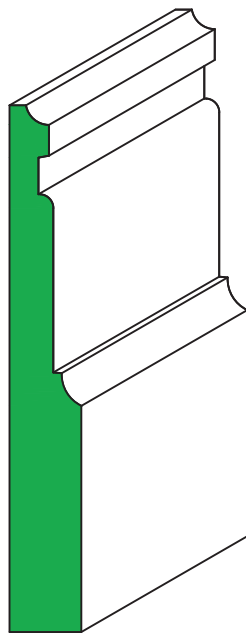

M2294
3/4 X 5 1/2

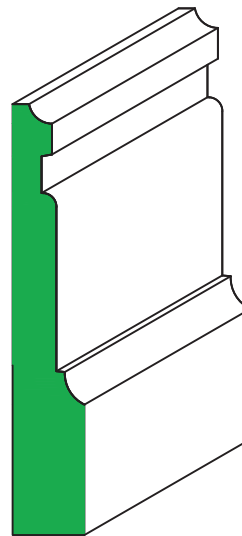

M2292
3/4 X 4 1/2

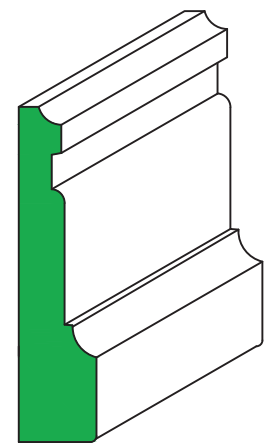

M2290
13/16 X 3 1/2

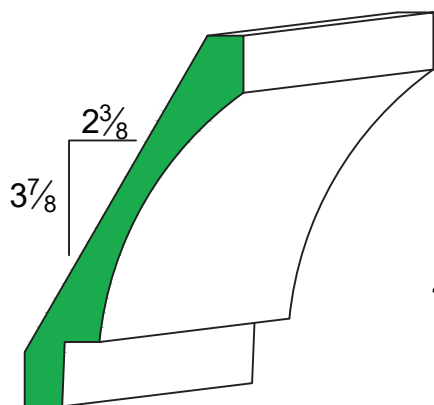

M1190
5/8 X 4 1/2

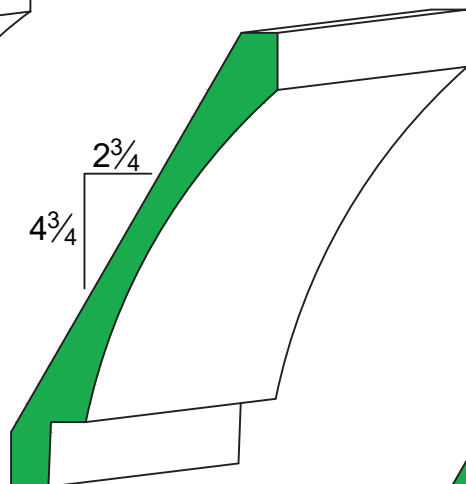

M1192
5/8 X 5 1/2

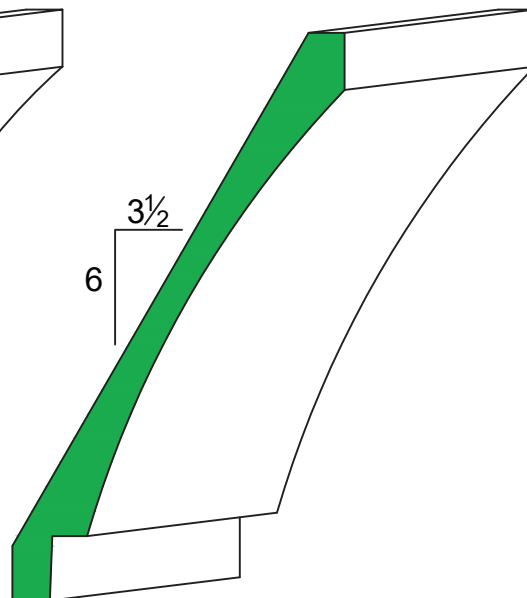

M1194
5/8 X 6 7/8

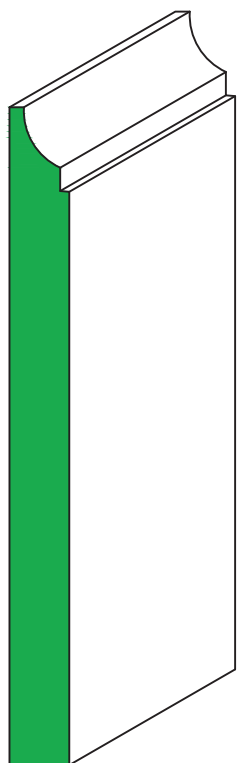

M2196
5/8 X 6 7/8

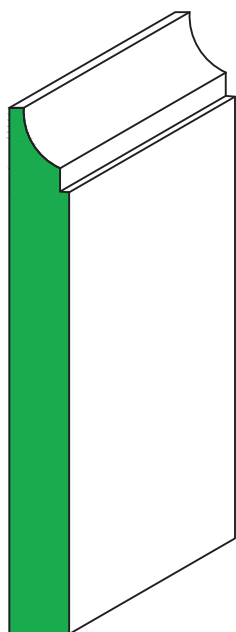

M2194
5/8 X 5 1/2

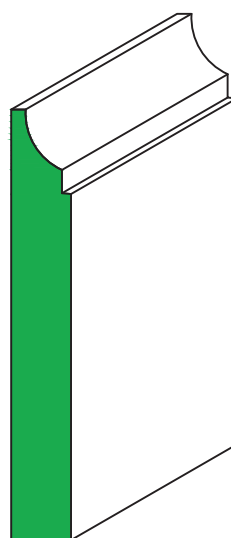

M2192
5/8 X 4 1/2

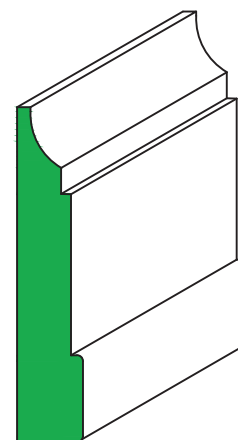

M2190
1 1/16 X 3 1/2

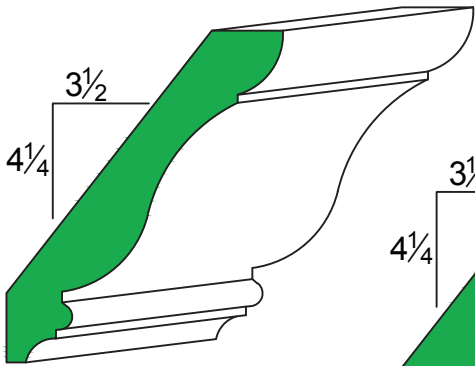

M1280
3/4 X 4 1/2

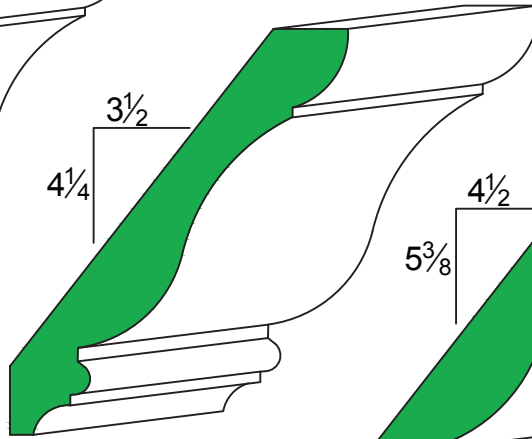

M1282
3/4 X 5 1/2

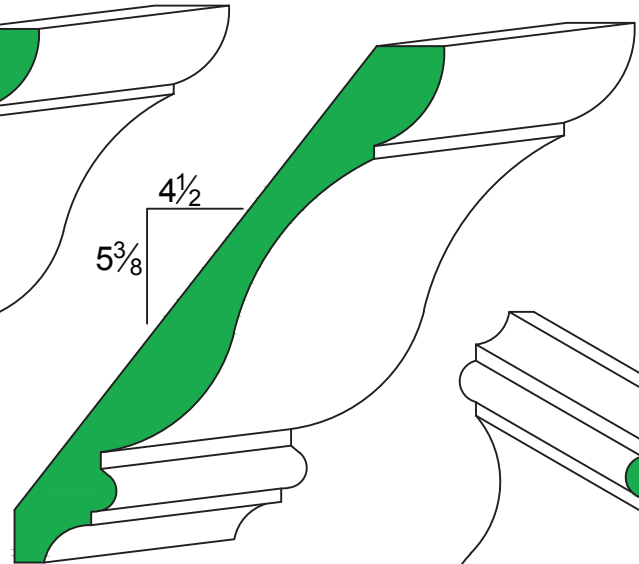

M1284
13/16 X 7

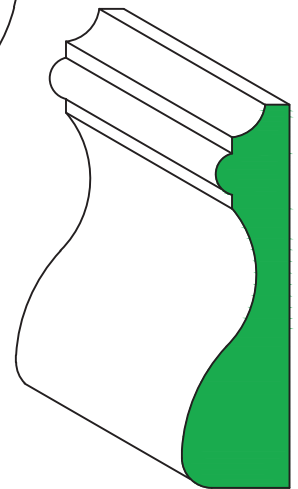

M2280
1 1/8 X 4

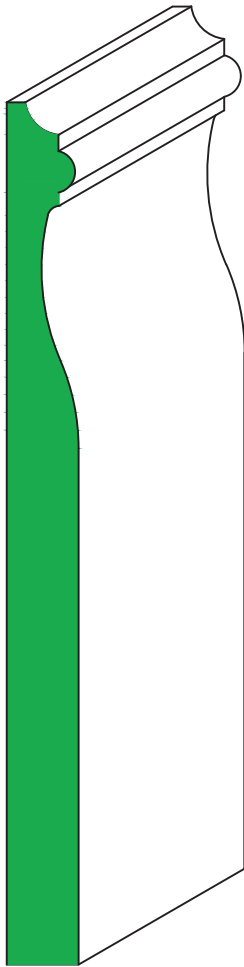

M2288
3/4 X 7

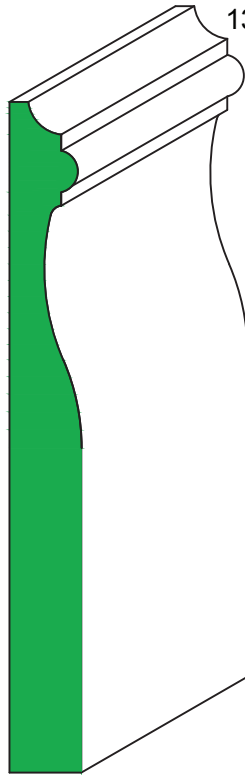

M2286
3/4 X 5 1/2

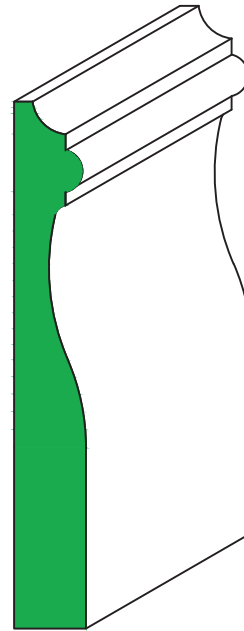

M2284
3/4 X 4 1/2

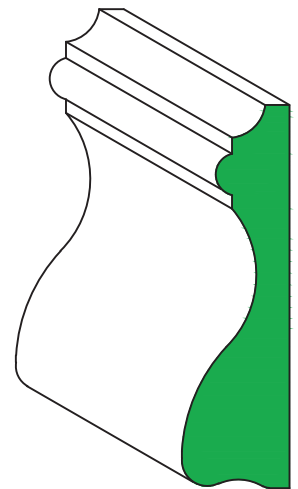

M2282
1 1/8 X 4

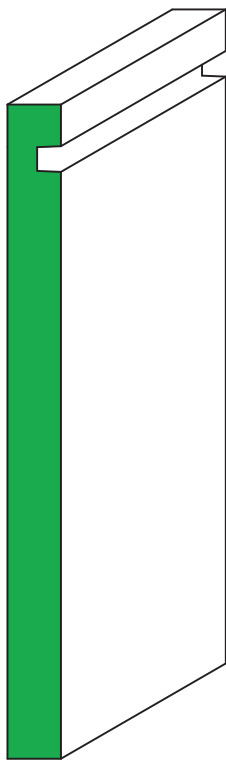

M2176
 $\frac{9}{16} \times 6\frac{7}{8}$

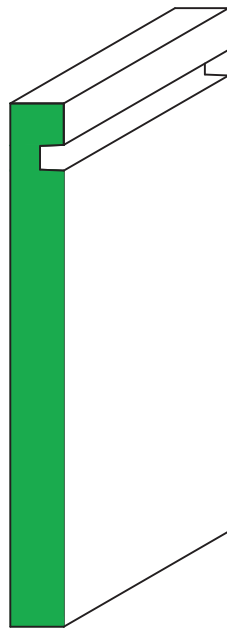

M2174
 $\frac{9}{16} \times 5\frac{1}{2}$

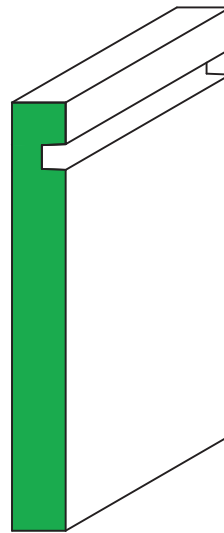

M2172
 $\frac{9}{16} \times 4\frac{1}{2}$

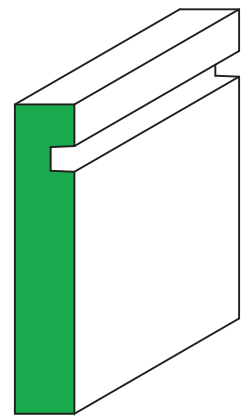

M2170
 $\frac{5}{8} \times 3\frac{1}{4}$

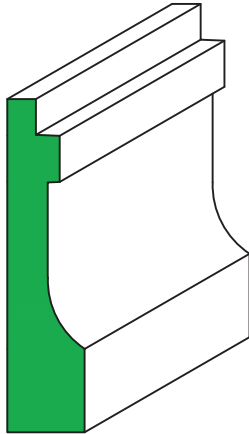

M2210
 $1\frac{3}{16} \times 3\frac{1}{2}$

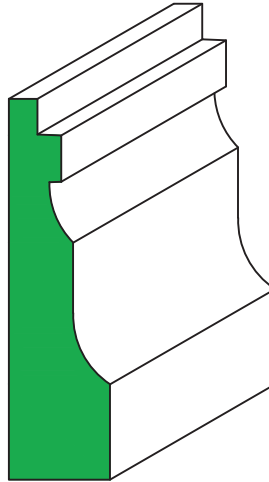

M2212
 $1\frac{1}{16} \times 4$

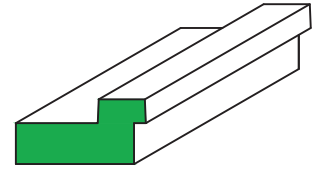

M5410
 $\frac{5}{8} \times 1\frac{3}{8}$

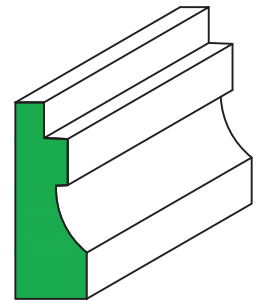

M5412
 $\frac{3}{4} \times 2\frac{1}{16}$

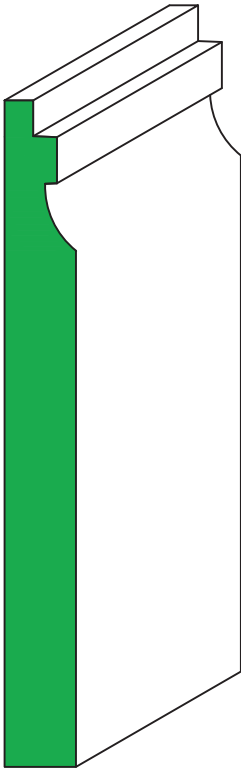

M2216
 $\frac{3}{4} \times 7$

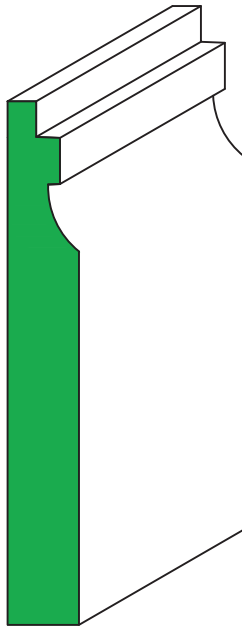

M2215
 $\frac{3}{4} \times 5\frac{1}{2}$

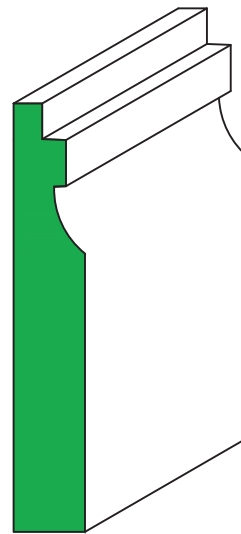

M2214
 $\frac{3}{4} \times 4\frac{1}{2}$

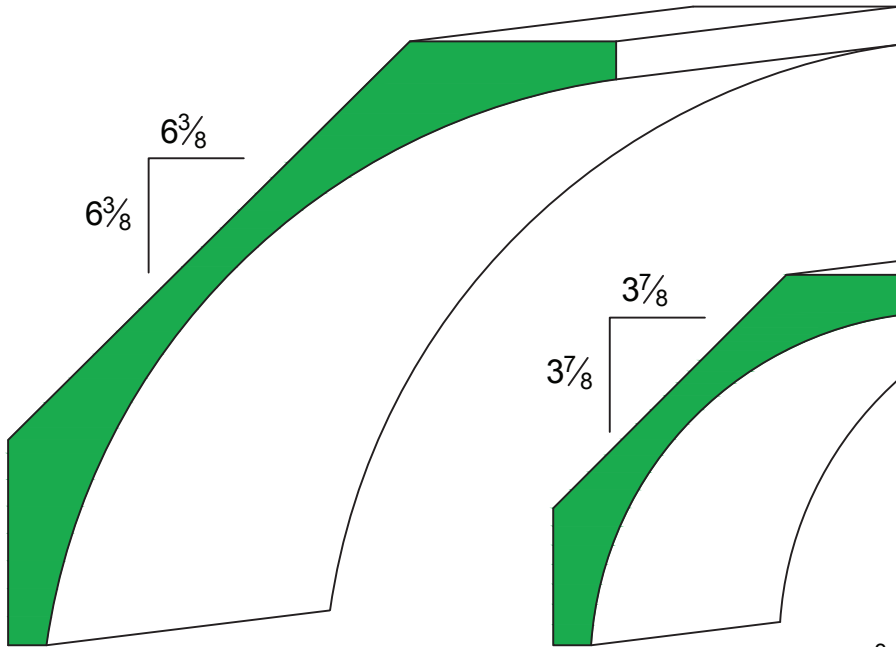

M1246
1 13/16 X 9

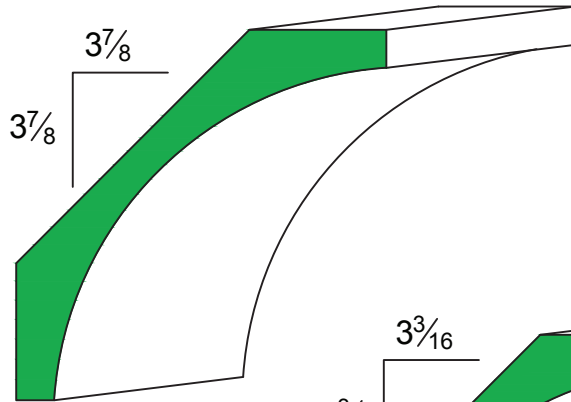

M1242
1 5/16 X 5 1/2

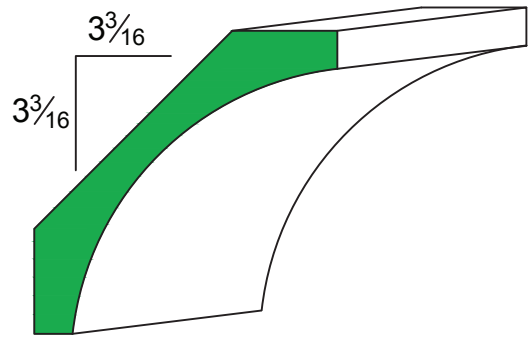

M1240
1 1/16 X 4 1/2

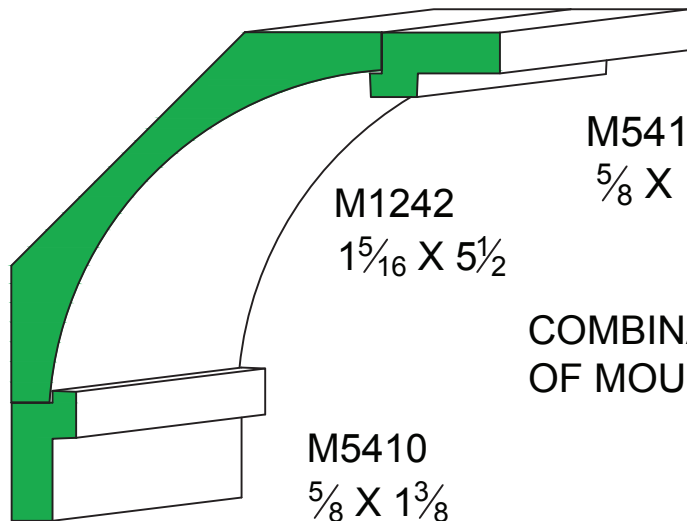

M1242
1 5/16 X 5 1/2

M5410
5/8 X 1 3/8

M5410
5/8 X 1 3/8

COMBINATION
OF MOULDINGS

M2214
3/4 X 4 1/2

M5412
3/4 X 2 1/16

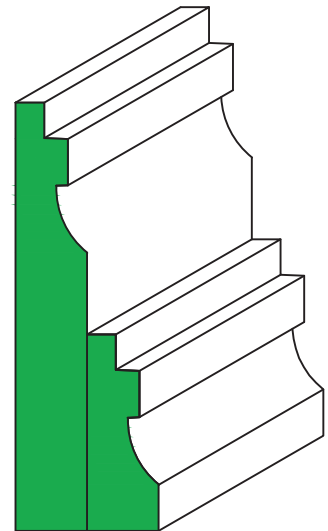

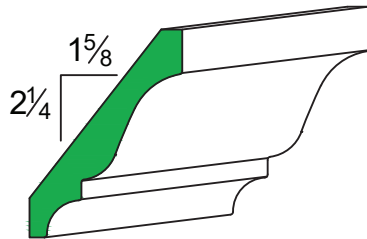

M1010
 $1\frac{5}{32} \times 2\frac{3}{4}$

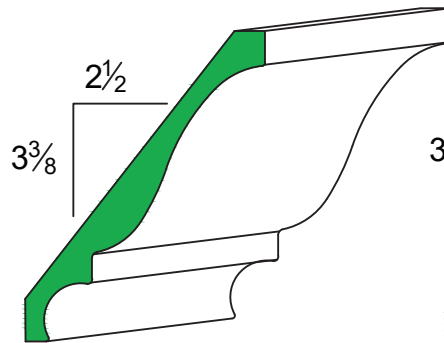

M1012
 $1\frac{5}{32} \times 4\frac{1}{4}$

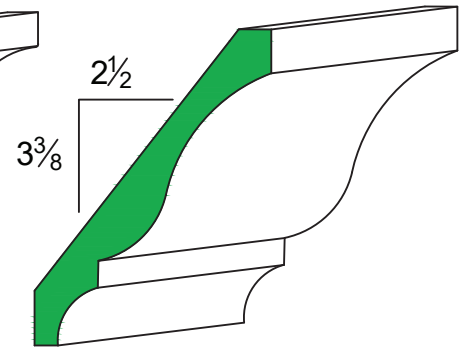

M1013
 $\frac{9}{16} \times 4\frac{1}{4}$

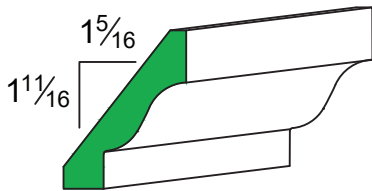

M1014
 $1\frac{5}{32} \times 2\frac{1}{4}$

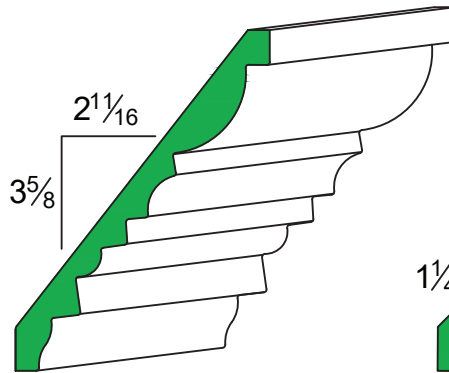

M1015
 $1\frac{5}{32} \times 4\frac{9}{16}$

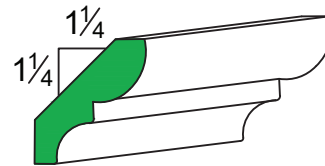

M1016
 $\frac{1}{2} \times 1\frac{3}{4}$

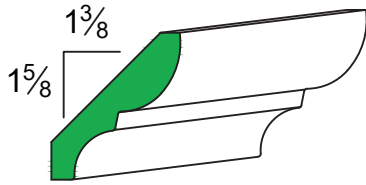

M1018
7/16 x 2 1/8

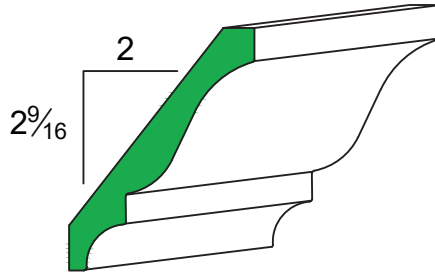

M1020
15/32 x 3 1/4

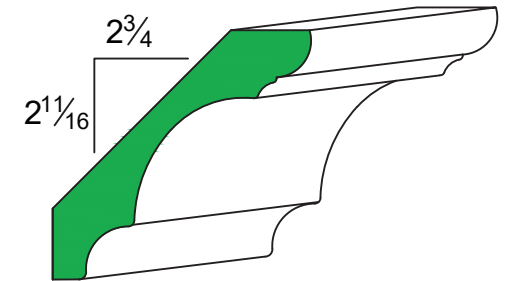

M1021
3/4 x 3 7/8

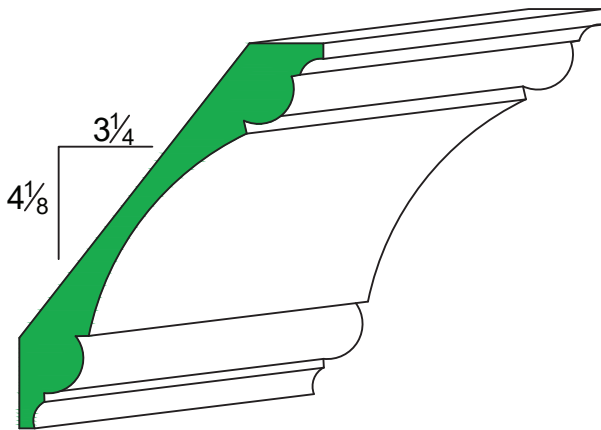

M1025
3/4 x 5 1/4

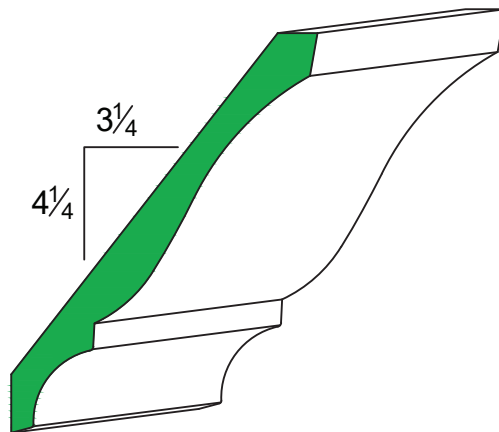

M1030
9/16 x 5 1/4

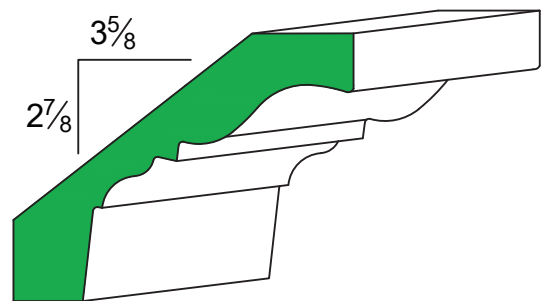

M1040
1 1/8 x 4 5/8

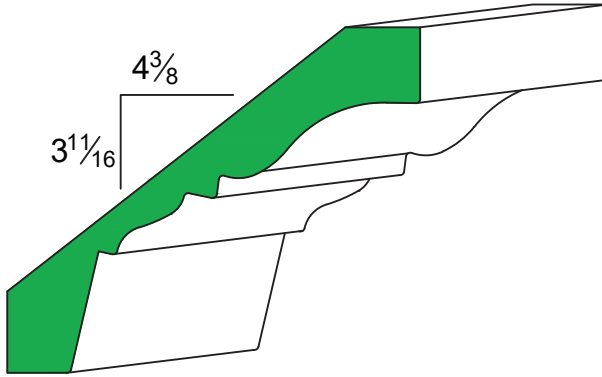

M1042
1 1/8 x 5 3/4

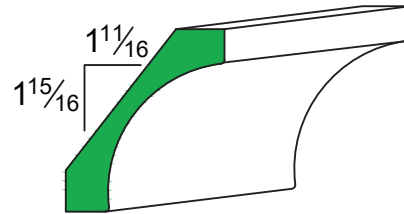

M1050
5/8 x 2 1/2

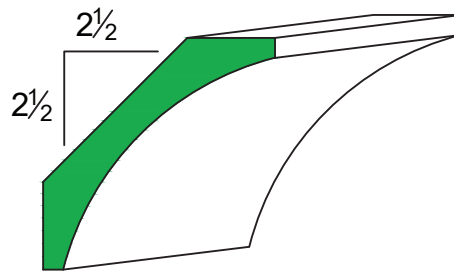

M1052
1 3/16 x 3 1/2

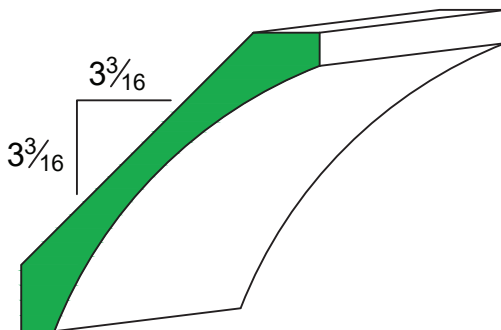

M1054
3/4 x 4 1/2

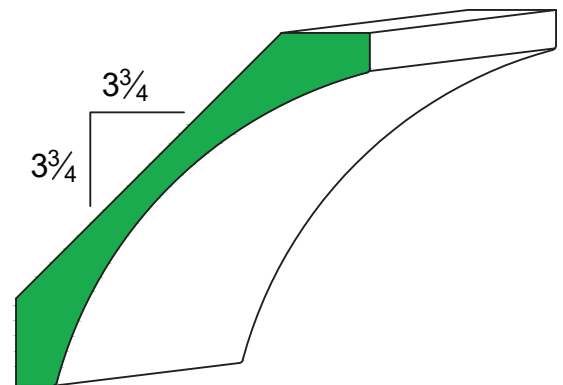

M1055
1 x 5 3/8

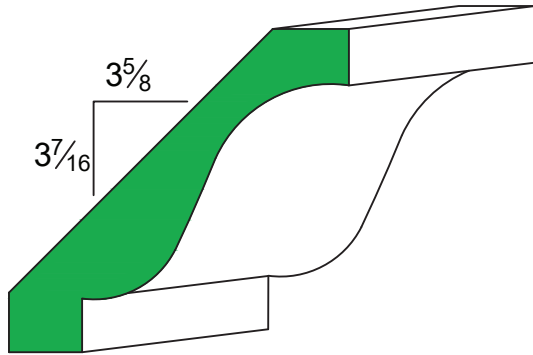

M1065
1 x 5

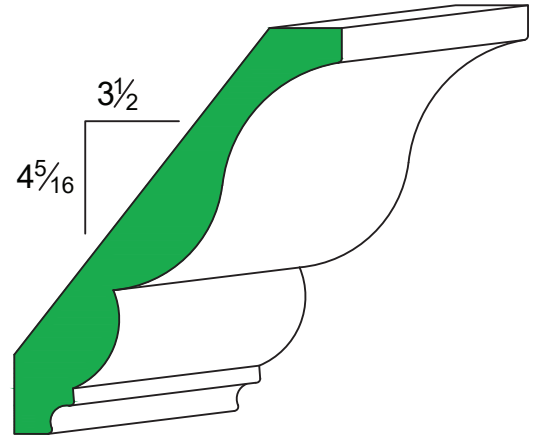

M1067
 $1\frac{3}{16} \times 5\frac{9}{16}$

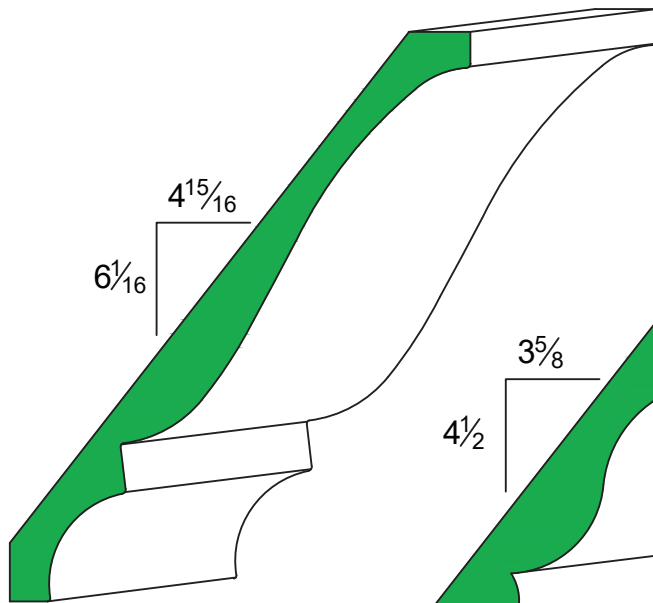

M1070
 $\frac{3}{4} \times 8$

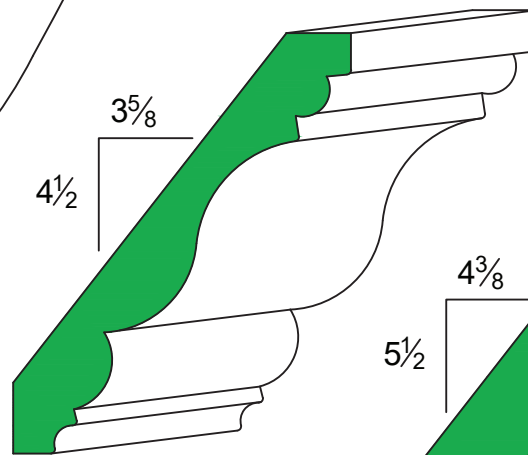

M1086
 $\frac{3}{4} \times 5\frac{3}{4}$

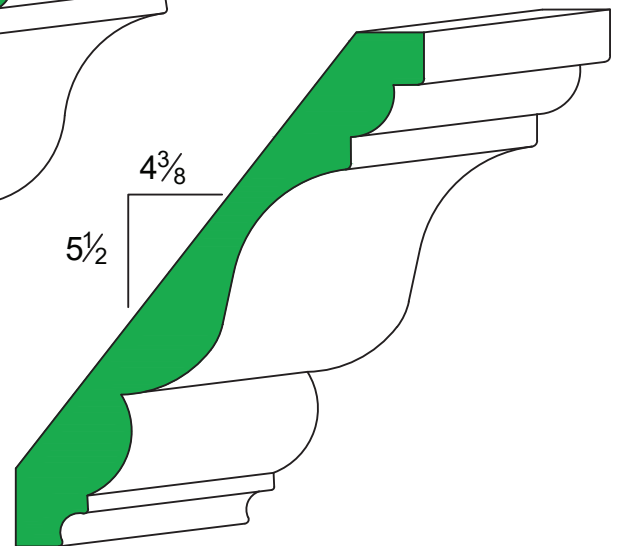

M1088
 $\frac{7}{8} \times 7$

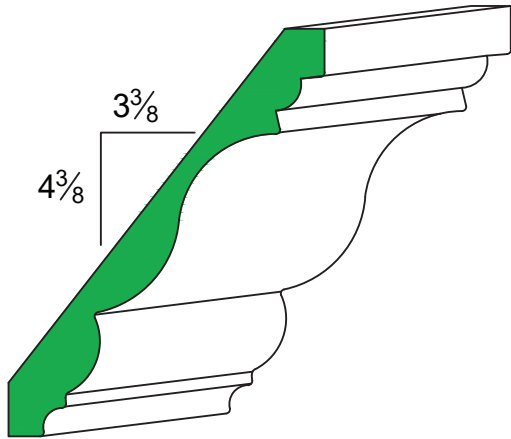

M1145
 $\frac{5}{8} \times 5\frac{1}{2}$

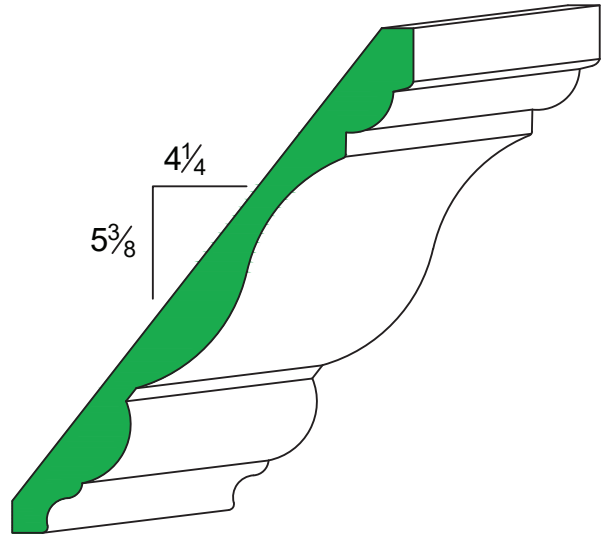

M1148
 $\frac{5}{8} \times 6\frac{7}{8}$

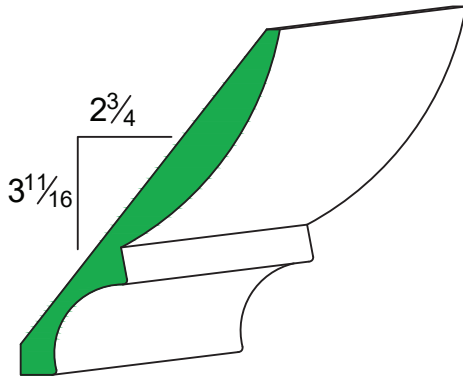

M1160
 $\frac{1}{2} \times 4\frac{5}{8}$

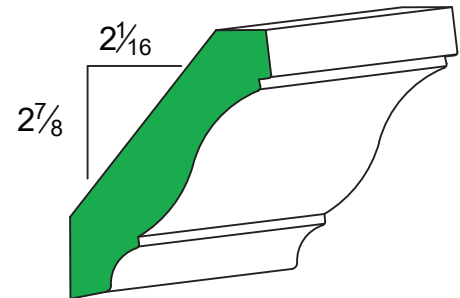

M1170
 $\frac{13}{16} \times 3\frac{1}{2}$

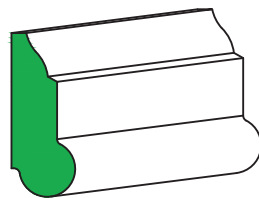

M1180
 $\frac{11}{16} \times 1\frac{3}{4}$

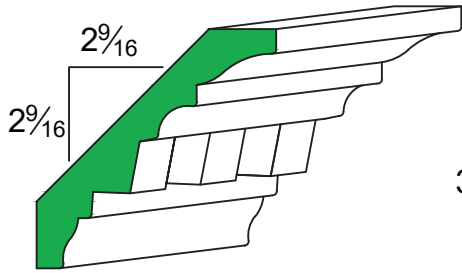

M1200
1 1/16 x 3 5/8

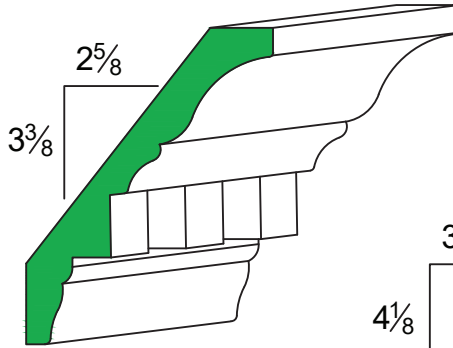

M1204
1 1/16 x 4 1/4

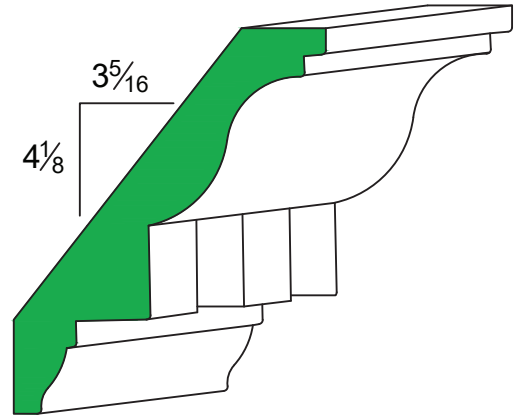

M1206
1 1/8 x 5 1/4

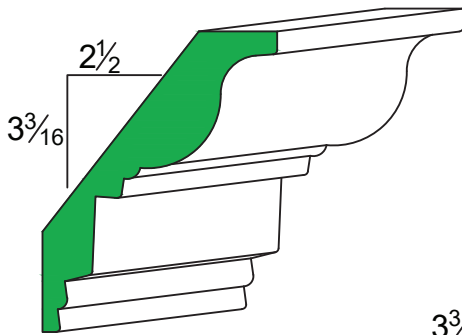

M1210
25/32 x 4

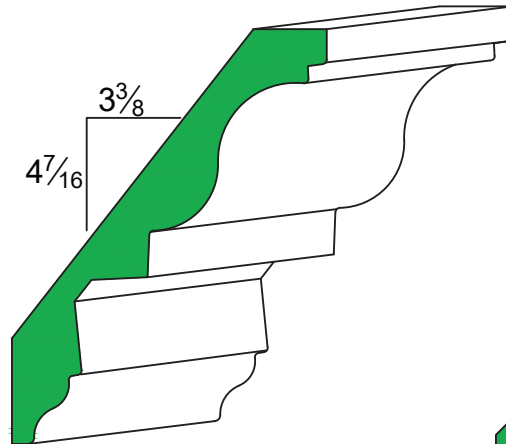

M1212
27/32 x 5 1/2

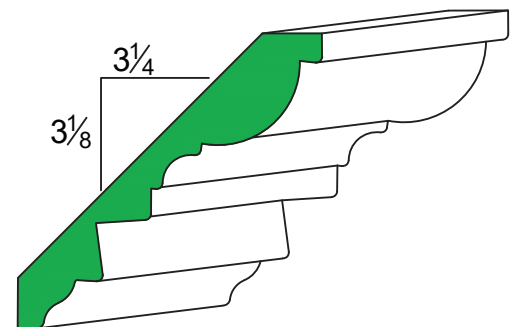

M1214
3/4 x 4 1/2

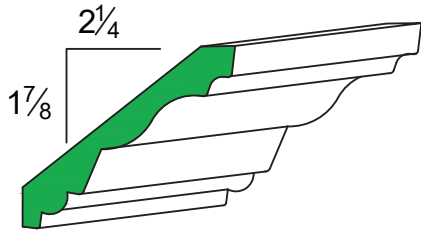

M1220
7/16 x 3

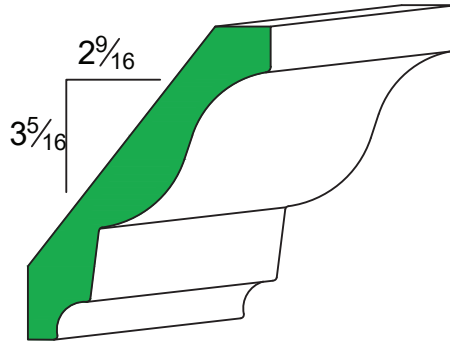

M1224
3/4 x 4 1/4

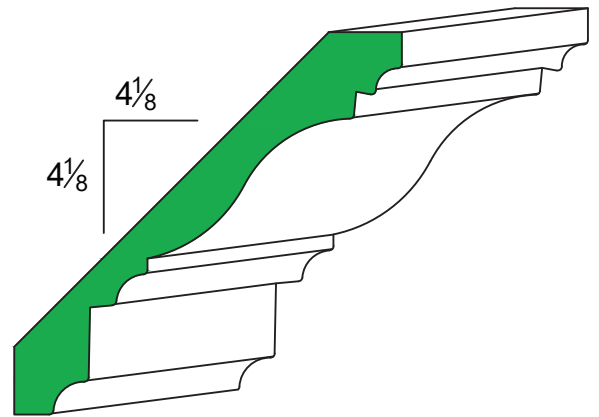

M1026
13/16 x 5 3/4

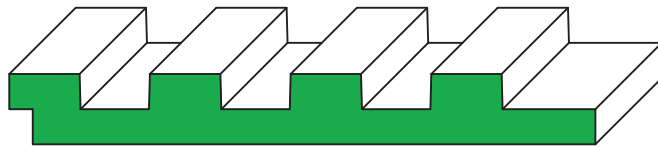

M1300
3/4 x 6 1/4

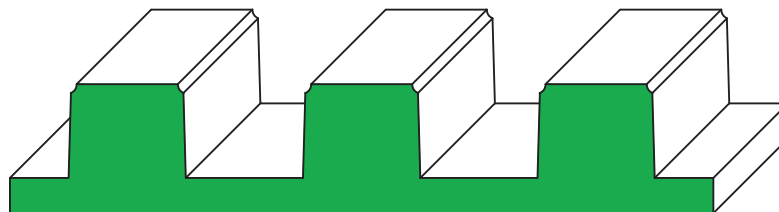

M1301
1 3/8 x 7 1/2

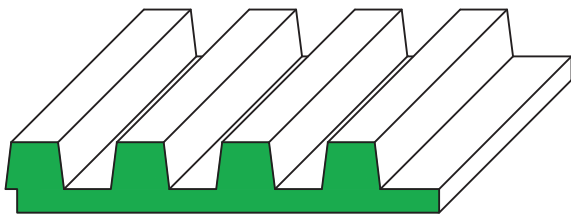

M1302
 $\frac{3}{4} \times 4\frac{5}{8}$

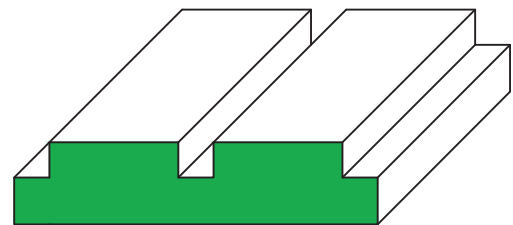

M1303
 $\frac{7}{8} \times 3\frac{7}{8}$

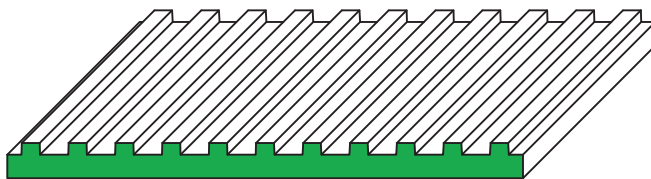

M1304
 $\frac{3}{8} \times 5\frac{1}{2}$

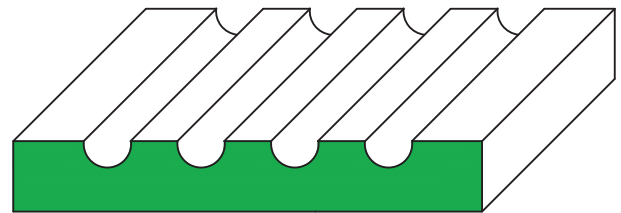

M1305
 $\frac{3}{4} \times 5$

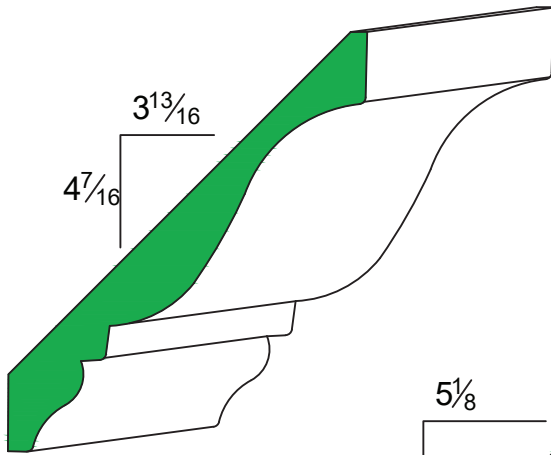

M1310
 $\frac{3}{4} \times 5\frac{7}{8}$

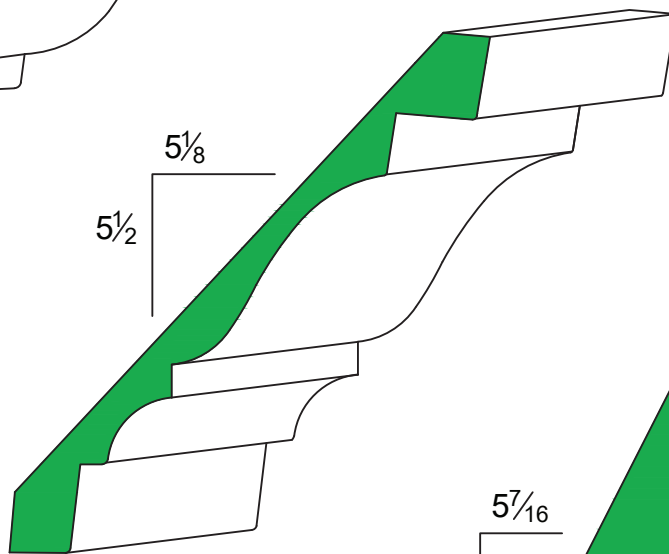

M1359
 $\frac{7}{8} \times 7\frac{1}{2}$

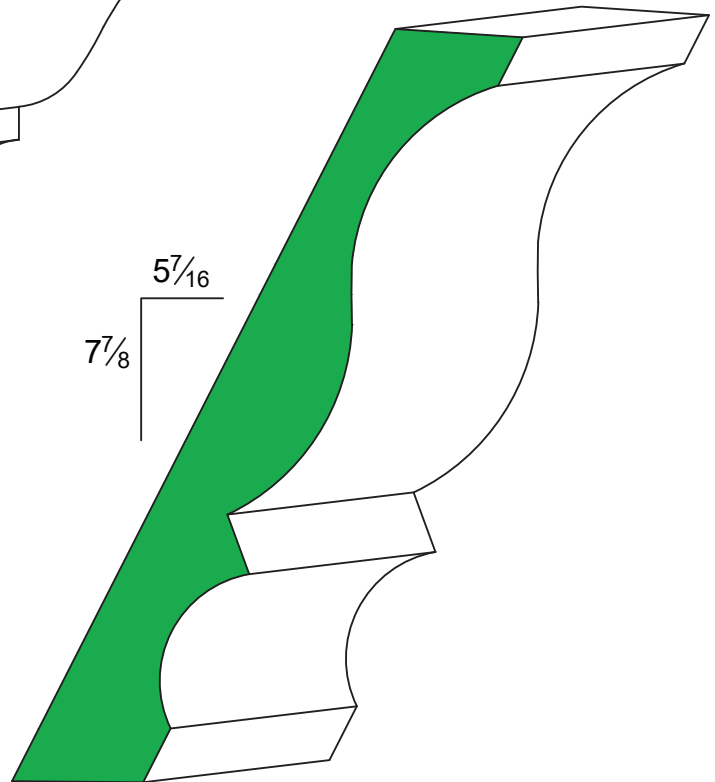

M1350
 $1\frac{1}{4} \times 9\frac{9}{16}$

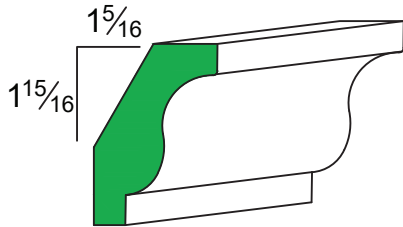

M1390
3/4 X 2 5/16

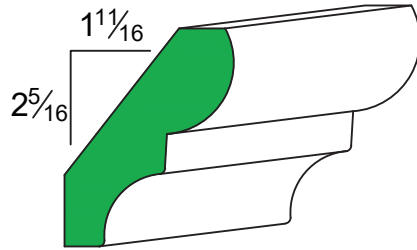

M1394
7/8 X 2 7/8

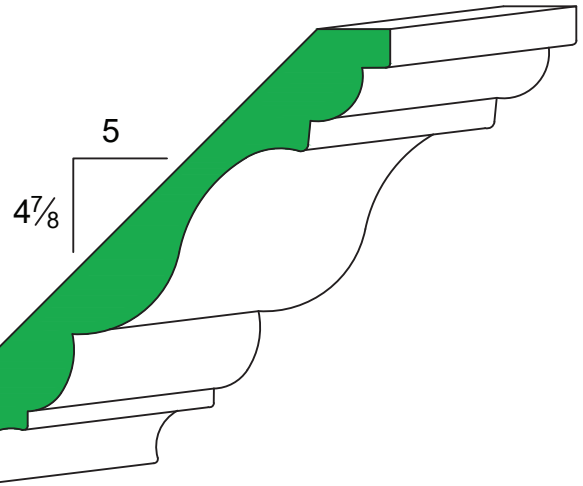

M1400
1 3/16 X 7



M1402
3/4 X 6 3/8

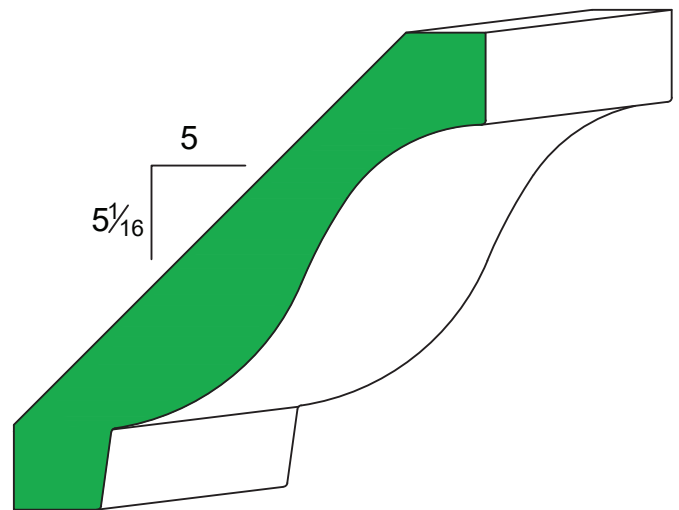

M1404
1 1/4 X 7 1/8

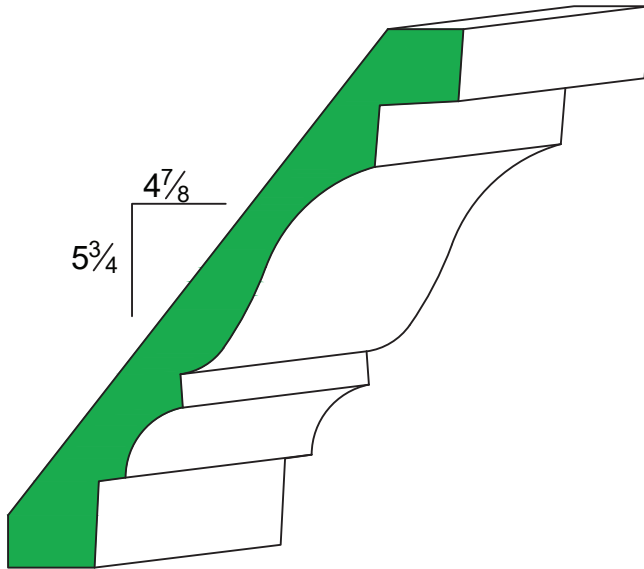

M1406
 $1\frac{1}{16} \times 7\frac{1}{2}$

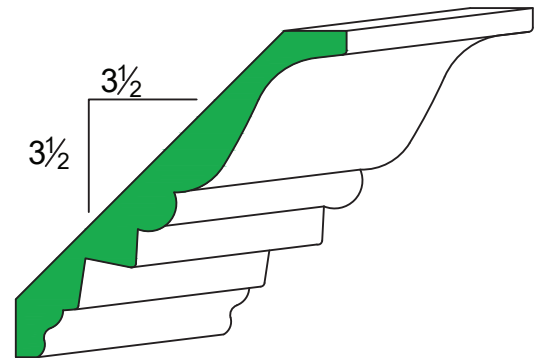

M1408
 $\frac{5}{8} \times 5$

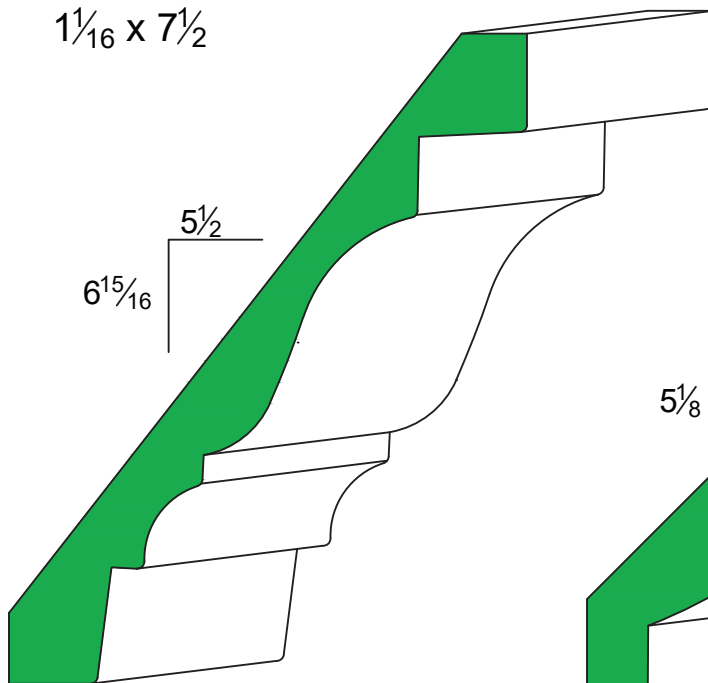

M1410
 $1\frac{3}{16} \times 8\frac{7}{8}$

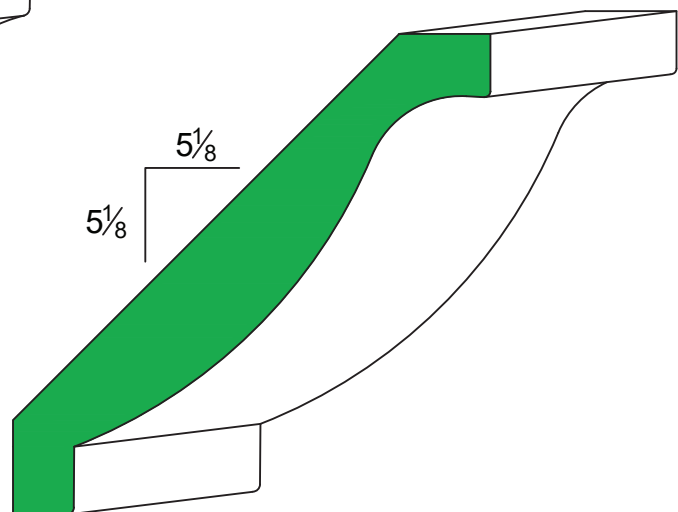

M1412
 $1\frac{1}{8} \times 7\frac{1}{4}$

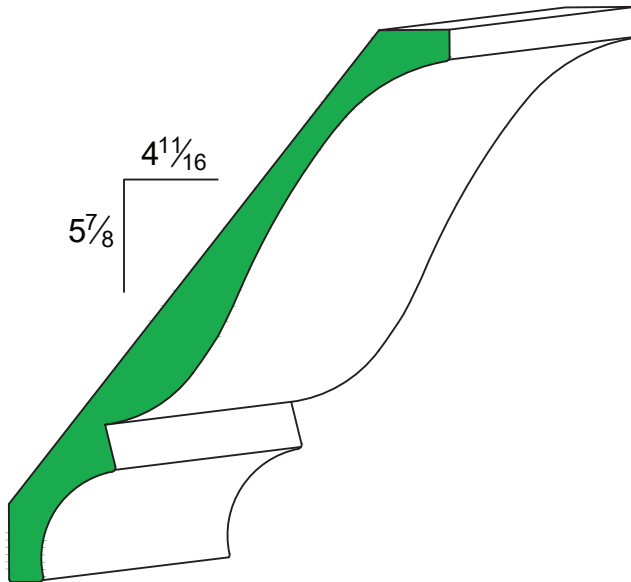

M1414
 $2\frac{5}{32} \times 7\frac{1}{2}$

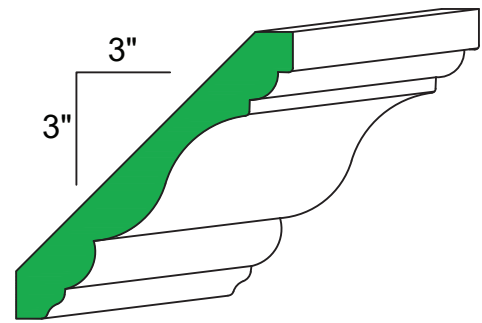

M1416
 $\frac{9}{16} \times 4\frac{1}{4}$

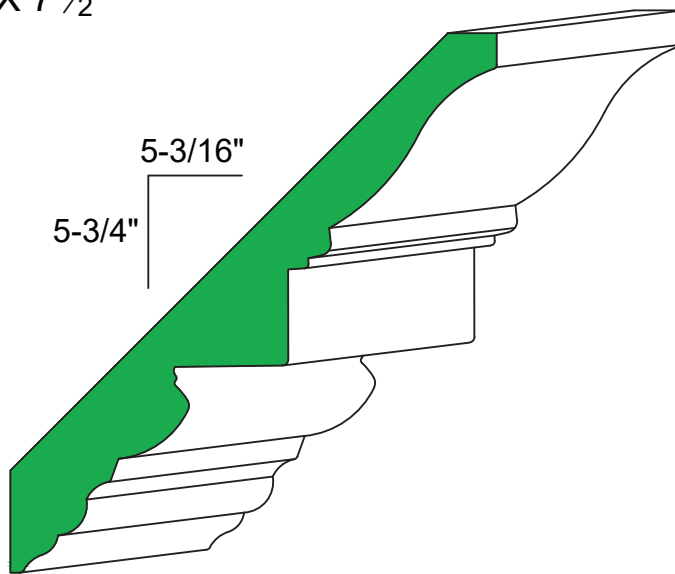

M1418
 $1\frac{1}{4} \times 7\frac{3}{4}$

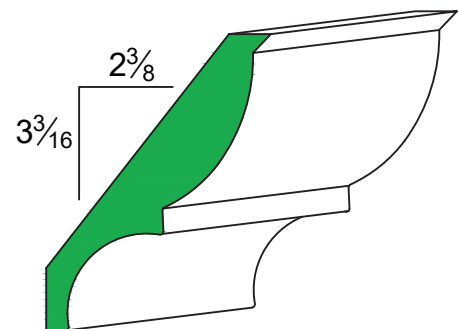

M1420
 $\frac{3}{4} \times 4$

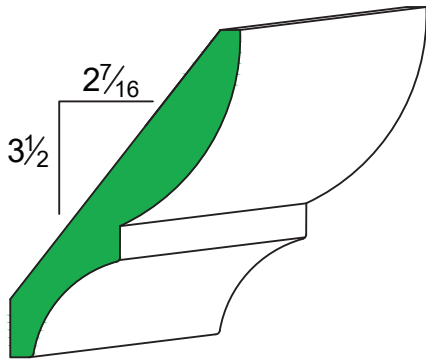

M1422
 $1\frac{1}{16} \times 4\frac{1}{4}$

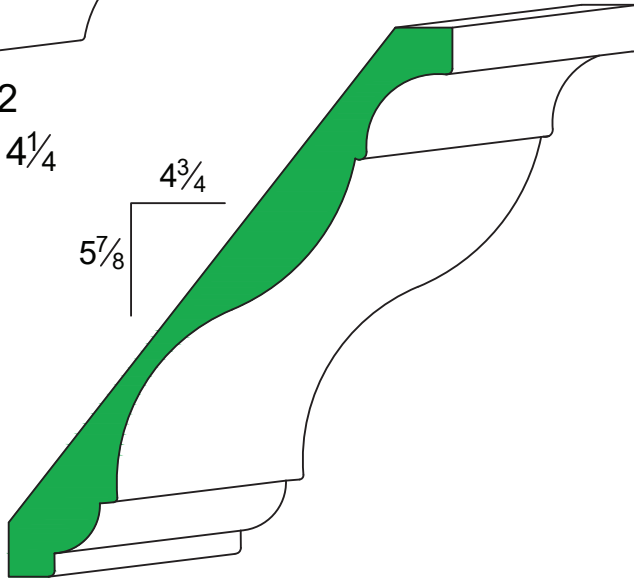

M1426
 $\frac{3}{4} \times 7\frac{1}{2}$

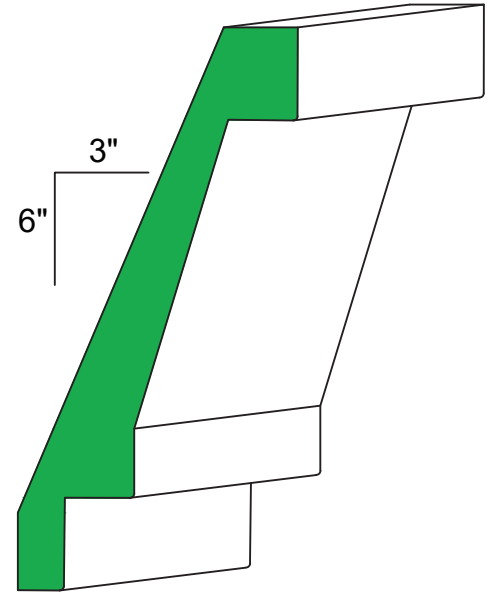

M1424
 $1\frac{3}{32} \times 6\frac{3}{4}$

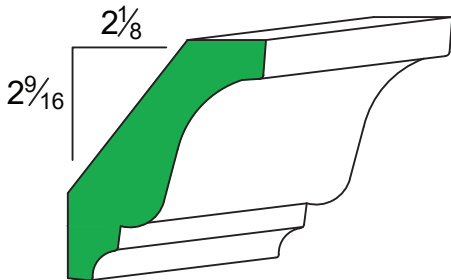

M1428
 $\frac{7}{8} \times 3\frac{5}{16}$

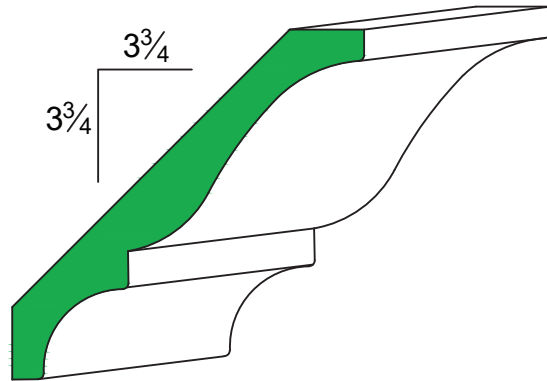

M1430
 $\frac{3}{4} \times 5\frac{1}{4}$

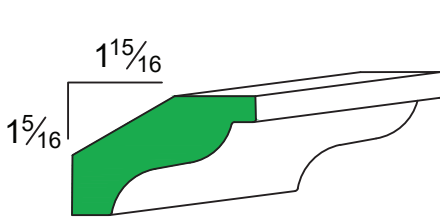

M1432
3/4 X 2 5/16

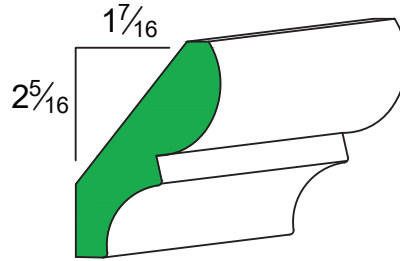

M1434
3/4 X 2 11/16

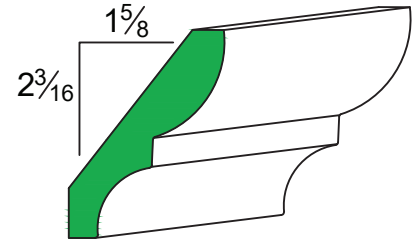

M1436
9/16 X 2 3/4

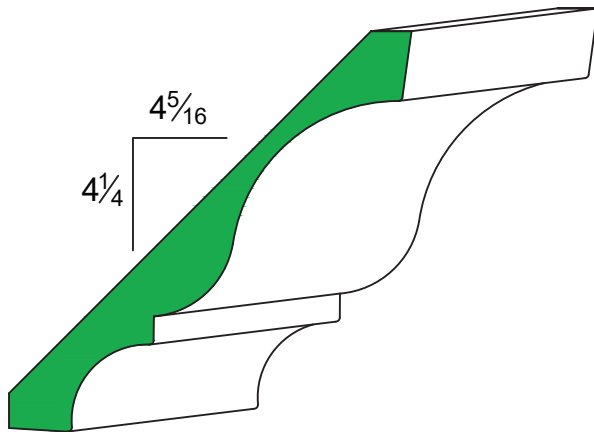

M1438
3/4 X 6"

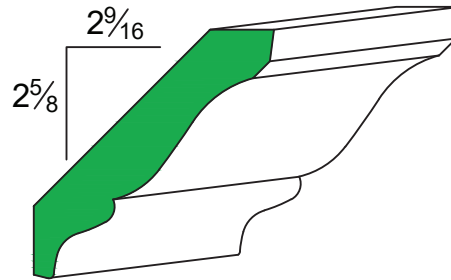

M1440
1 1/16 X 3 11/16

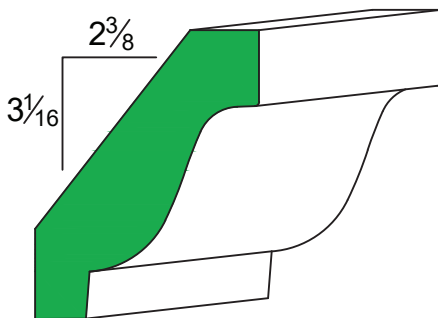

M1442
1 1/16 X 3 7/8

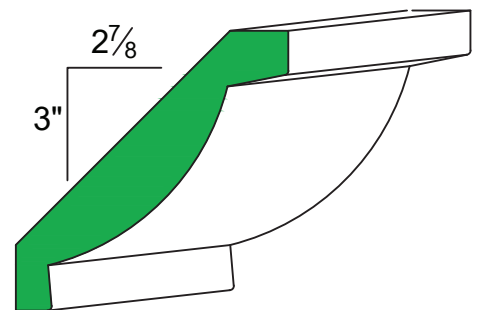

M1444
3/4 X 4 3/16

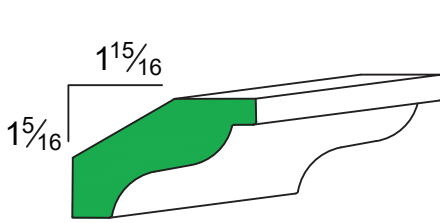

M1432
3/4 X 2 5/16

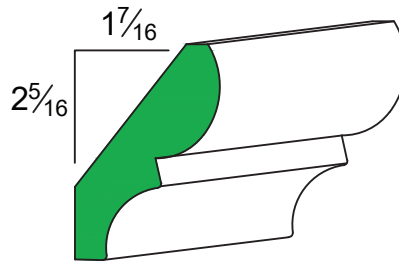

M1434
3/4 X 2 11/16

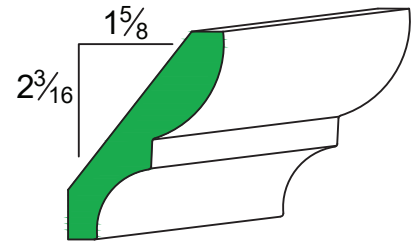

M1436
9/16 X 2 3/4

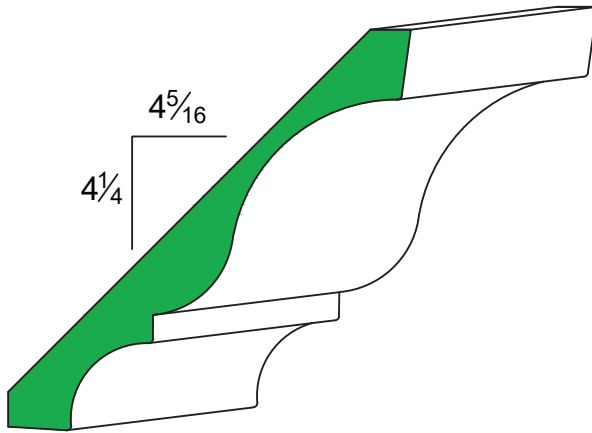

M1438
3/4 X 6"

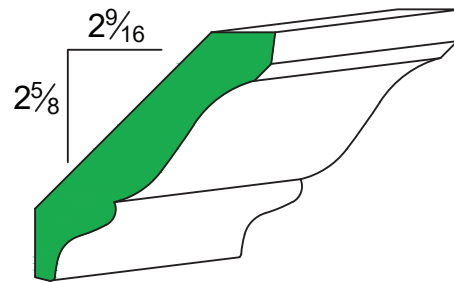

M1440
1 1/16 X 3 11/16

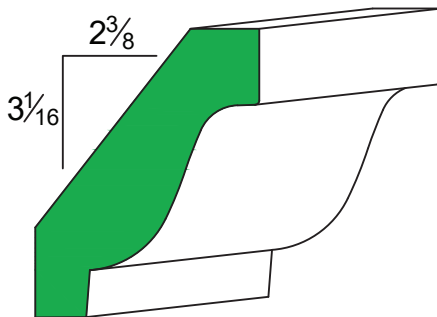

M1442
1 1/16 X 3 7/8

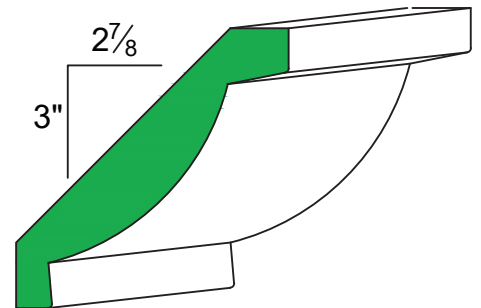

M1444
3/4 X 4 3/16

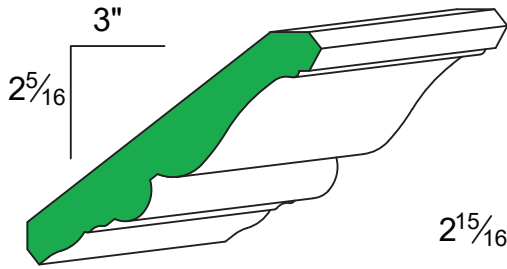

M1466
1 1/16 X 3 3/4

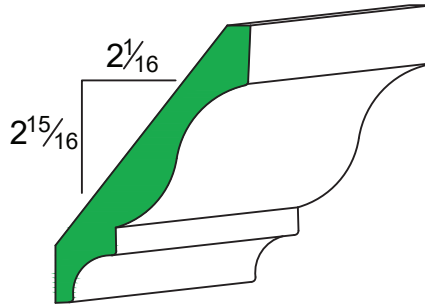

M1460
9/16 X 3 5/8

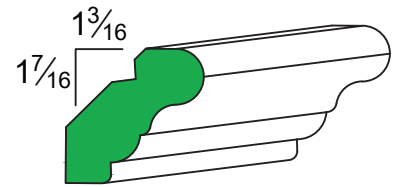

M1462
3/4 X 1 15/16

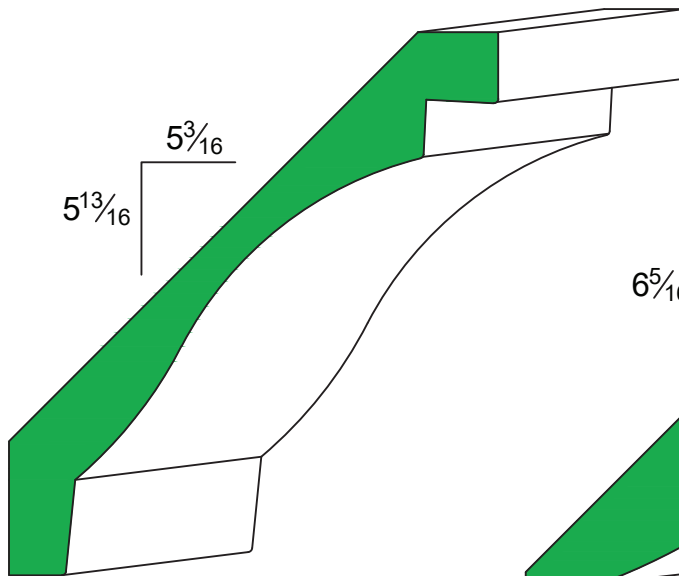

M1468
1 7/16 X 7 25/32

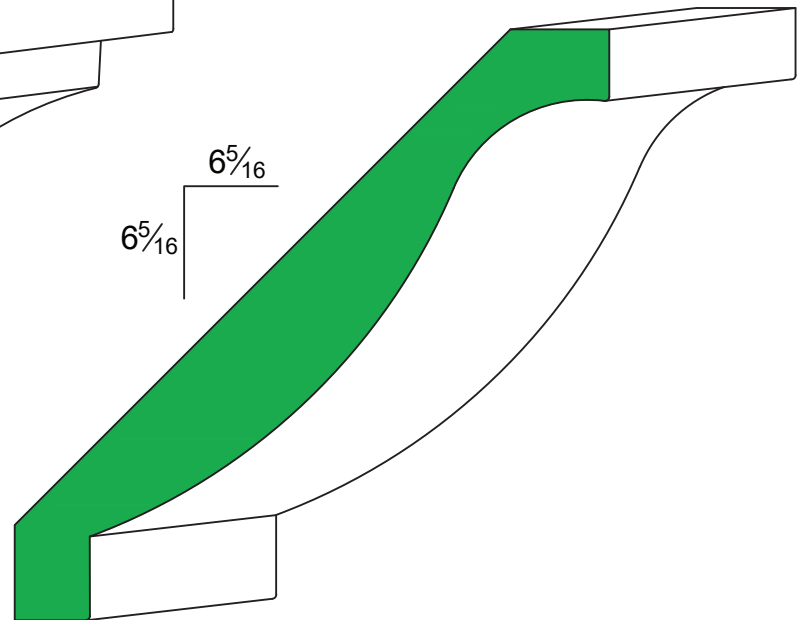

M1470
1 1/4 X 9

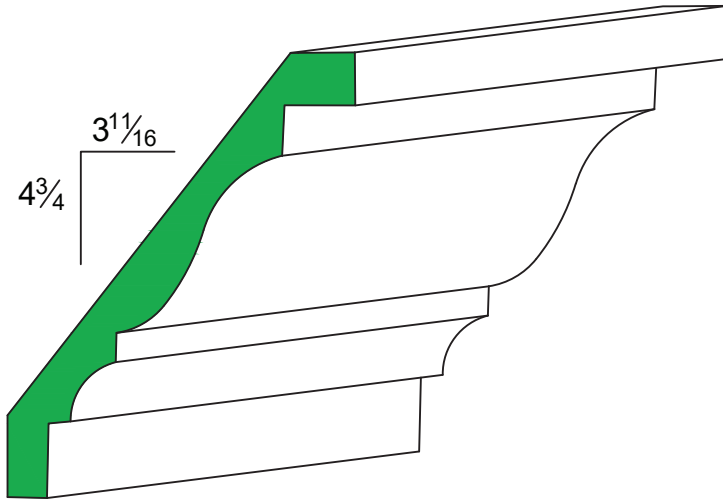

M1474
 $\frac{7}{8} \times 6"$

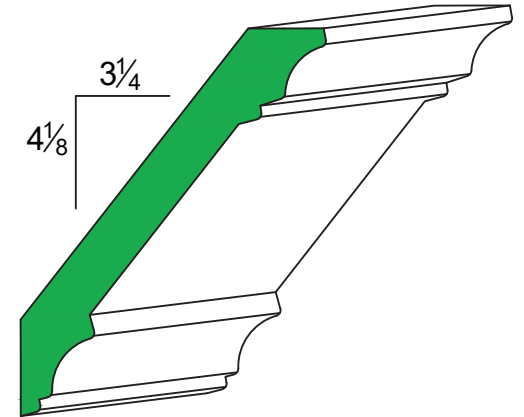

M1476
 $\frac{3}{4} \times 5\frac{1}{4}$

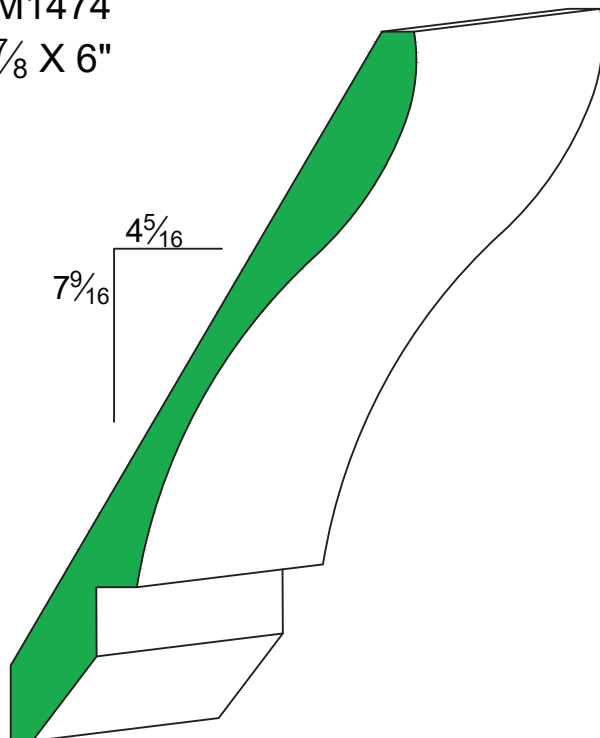

M1478
 $\frac{3}{4} \times 8\frac{1}{16}$

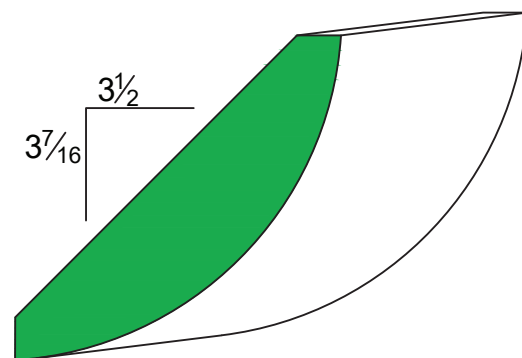

M1482
 $1\frac{1}{4} \times 4\frac{7}{8}$

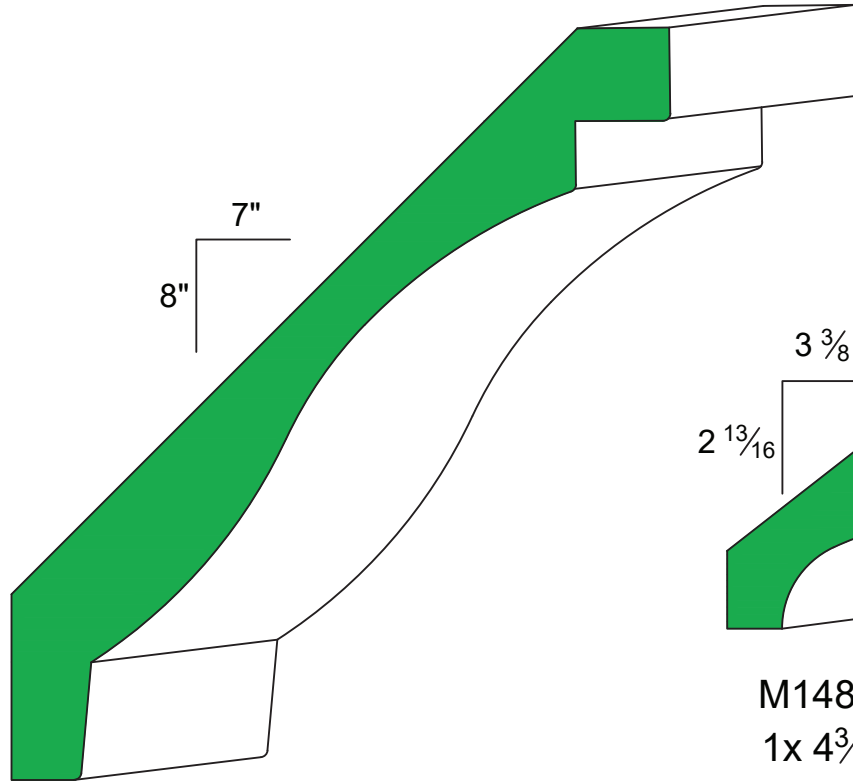

M1484
1⁷/₈ x 10⁵/₈

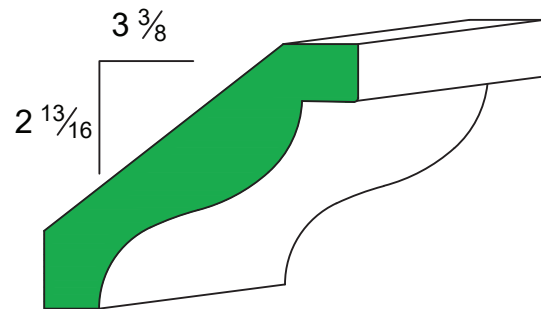

M1486
1 x 4³/₈

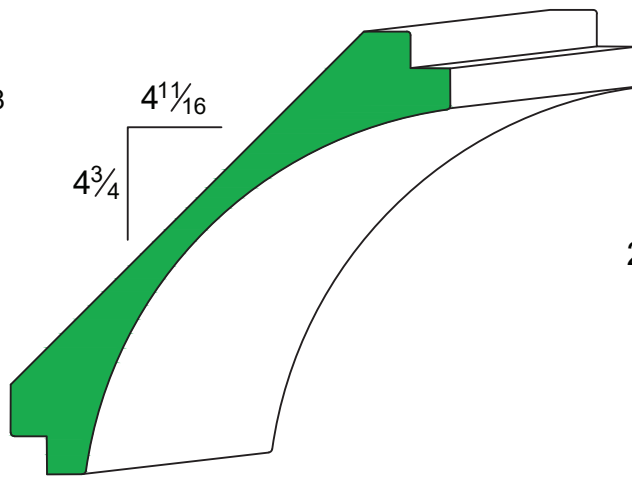

M1488
1¹/₄ x 6¹/₈

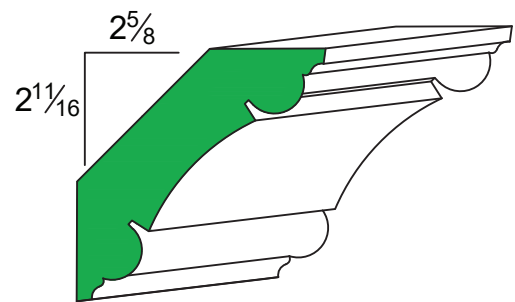

M1492
1¹/₁₆ x 3¹³/₁₆

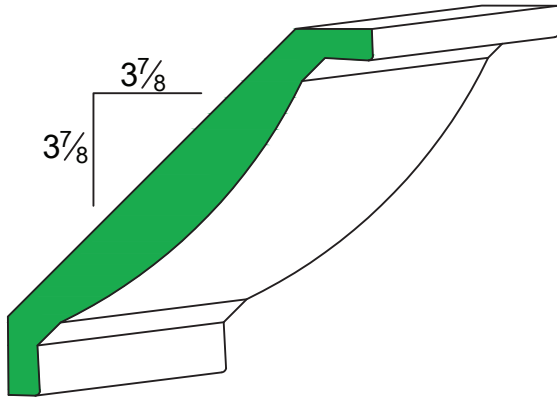

M1496
1 3/16 x 5 1/2

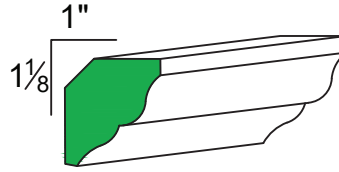

M1498
3/4 x 1 1/2

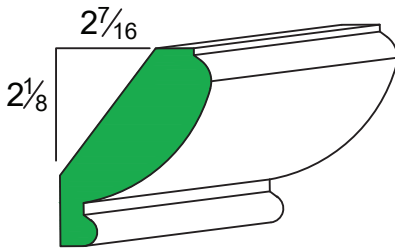

M1506
1 3/16 x 2 9/16

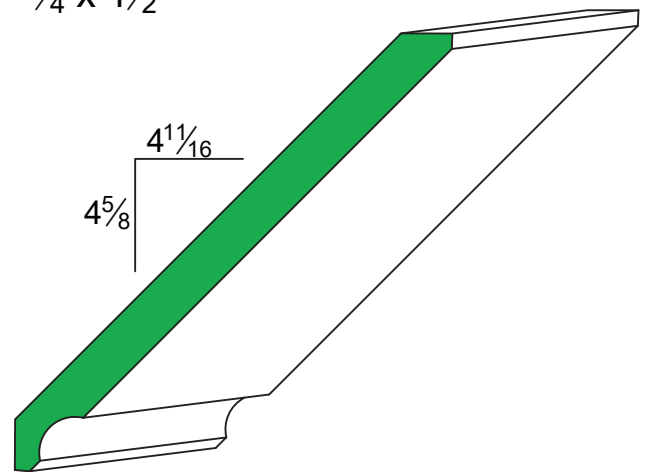

M1500
1/2 x 6 9/16

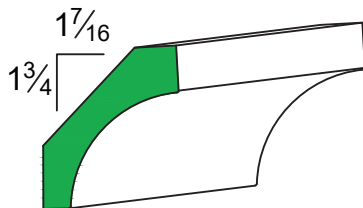

M1504
2 1/32 x 2 1/4

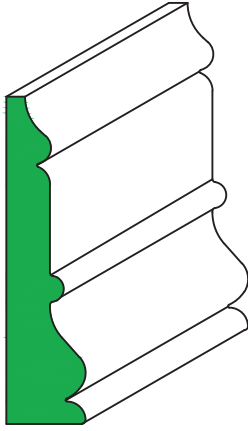

M2004
 $2\frac{3}{32} \times 3\frac{1}{2}$

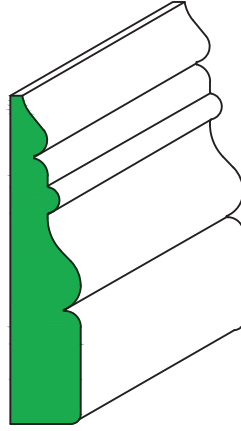

M2003
 $2\frac{3}{32} \times 3\frac{1}{2}$

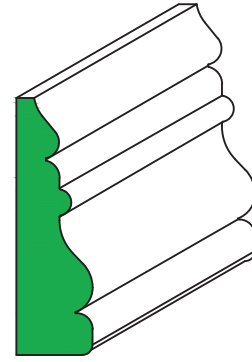

M2002
 $2\frac{3}{32} \times 2\frac{3}{4}$

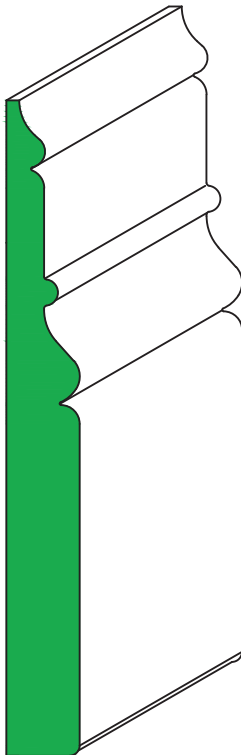

M2010
 $2\frac{3}{32} \times 7$

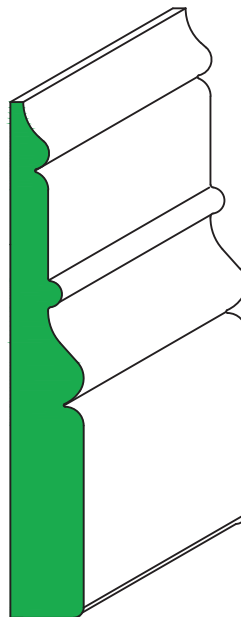

M2008
 $2\frac{3}{32} \times 5\frac{1}{2}$

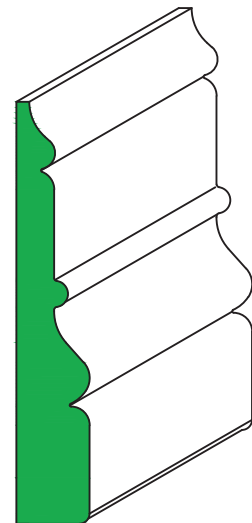

M2006
 $2\frac{3}{32} \times 4\frac{1}{2}$

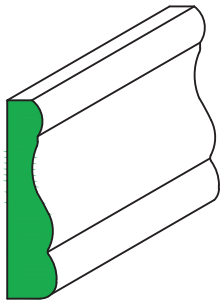

M2012
 $\frac{1}{2} \times 2\frac{1}{8}$

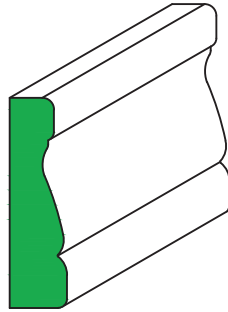

M2013
 $\frac{5}{8} \times 2\frac{1}{4}$

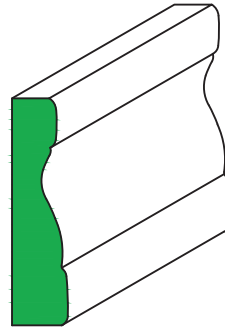

M2014
 $\frac{5}{8} \times 2\frac{1}{2}$

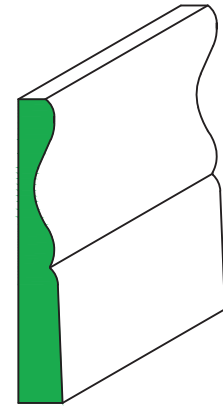

M2016
 $\frac{1}{2} \times 3\frac{1}{4}$

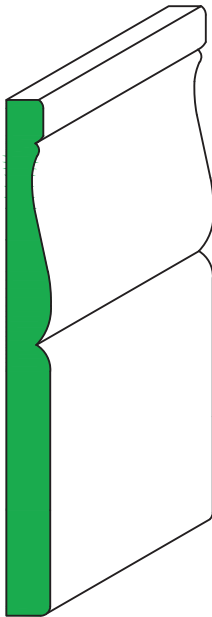

M2024
 $\frac{1}{2} \times 5\frac{1}{2}$

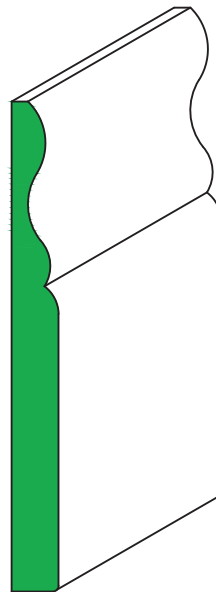

M2022
 $\frac{1}{2} \times 5\frac{1}{4}$

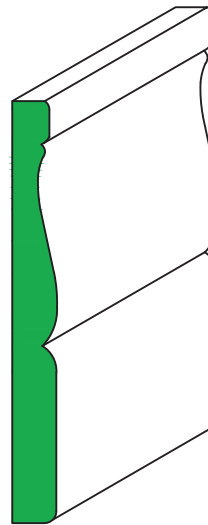

M2020
 $\frac{1}{2} \times 4\frac{1}{2}$

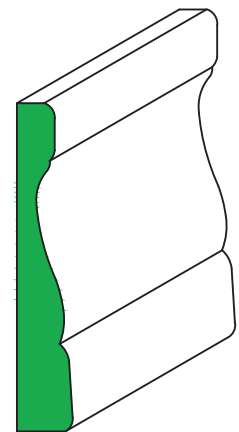

M2018
 $\frac{5}{8} \times 3\frac{1}{2}$

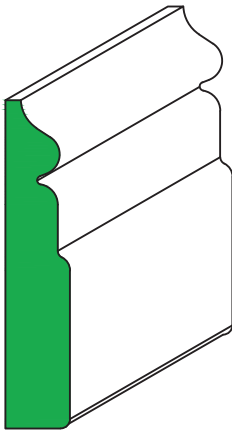

M2044
 $1\frac{1}{16} \times 3\frac{1}{2}$

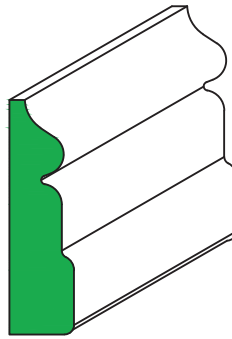

M2042
 $1\frac{1}{16} \times 2\frac{1}{2}$

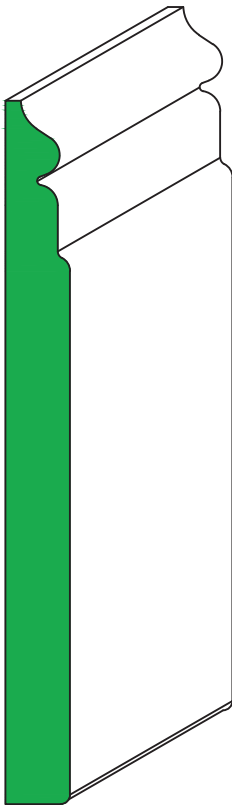

M2050
 $1\frac{1}{16} \times 7$

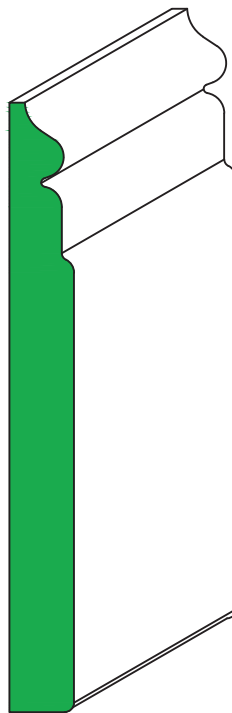

M2048
 $1\frac{1}{16} \times 5\frac{1}{2}$

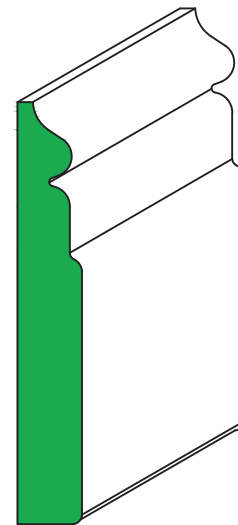

M2046
 $1\frac{1}{16} \times 4\frac{1}{2}$

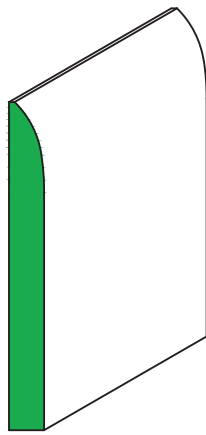

M2062
 $\frac{3}{8} \times 3\frac{1}{2}$

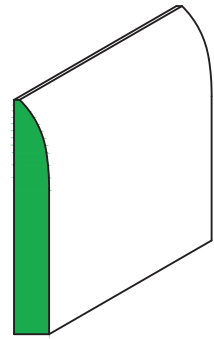

M2060
 $\frac{3}{8} \times 2\frac{1}{2}$

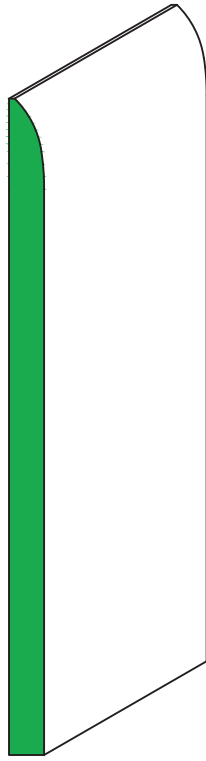

M2068
 $\frac{3}{8} \times 7$

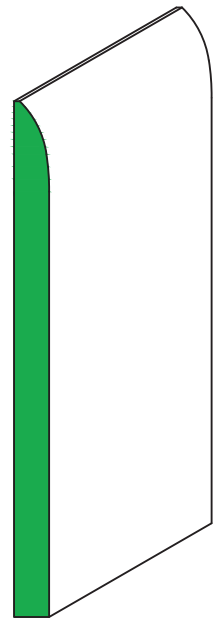

M2066
 $\frac{3}{8} \times 5\frac{1}{2}$

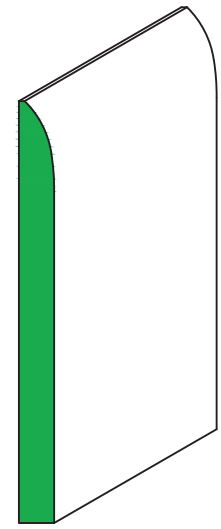

M2064
 $\frac{3}{8} \times 4\frac{1}{2}$

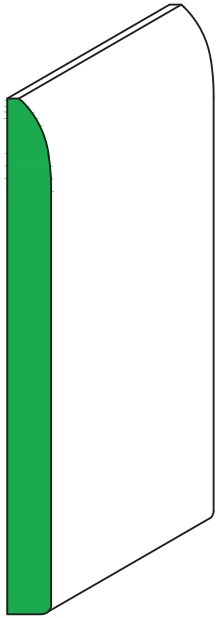

M2076
 $1\frac{15}{32} \times 5\frac{1}{2}$

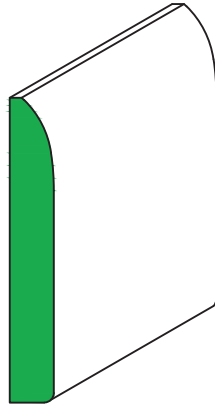

M2074
 $1\frac{15}{32} \times 3\frac{1}{4}$

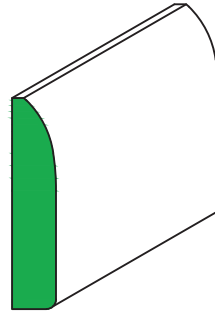

M2072
 $1\frac{15}{32} \times 2\frac{1}{4}$

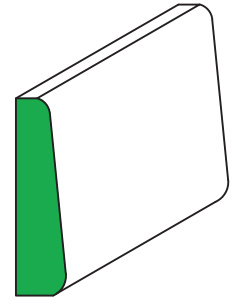

M2078
 $\frac{1}{2} \times 2\frac{1}{8}$

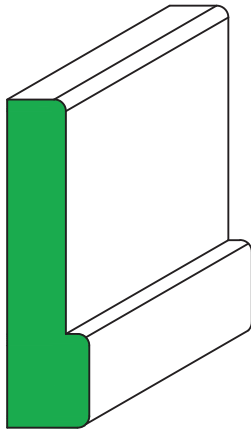

M2084
 $\frac{7}{8} \times 3\frac{1}{2}$

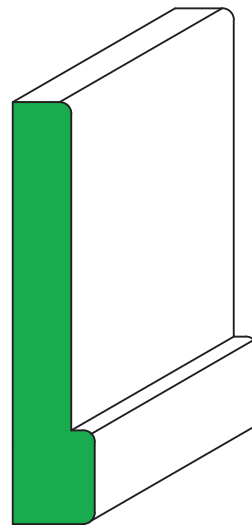

M2086
 $\frac{7}{8} \times 4\frac{1}{2}$

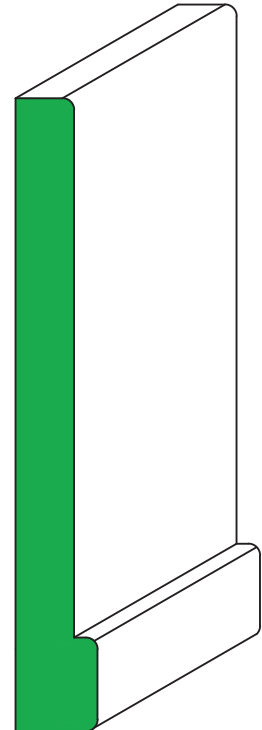

M2088
 $\frac{7}{8} \times 6\frac{3}{4}$

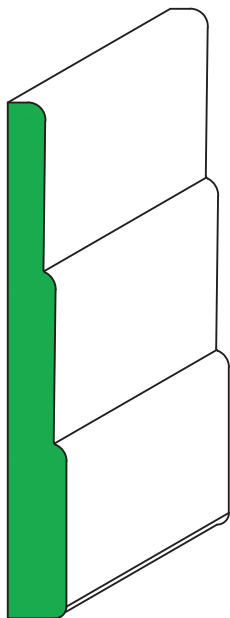

M2096
 $\frac{5}{8} \times 5\text{-}1/2$

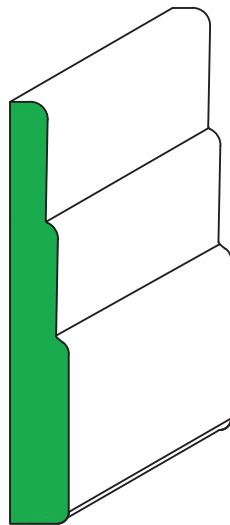

M2094
 $\frac{5}{8} \times 4\text{-}1/2$

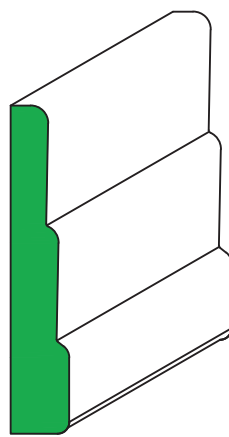

M2092
 $\frac{5}{8} \times 3\text{-}1/2$

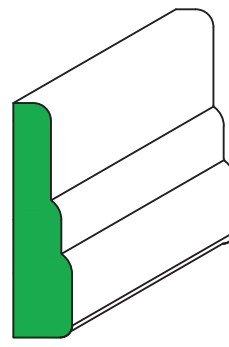

M2050
 $\frac{5}{8} \times 2\text{-}1/2$

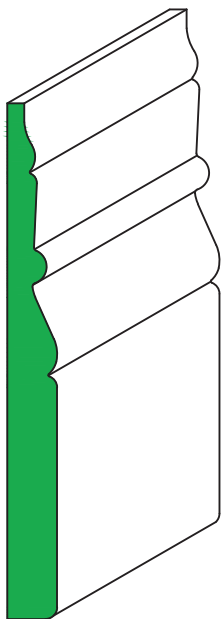

M2084
 $\frac{17}{32} \times 5\text{-}1/2$

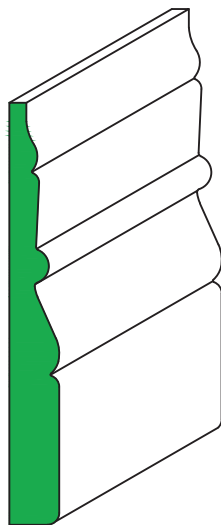

M2104
 $\frac{17}{32} \times 4\text{-}1/2$

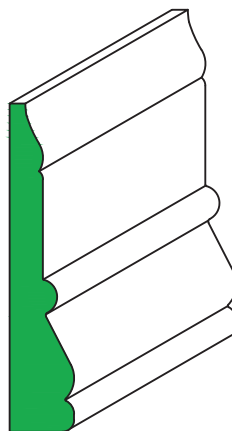

M2102
 $\frac{11}{16} \times 3\text{-}1/2$

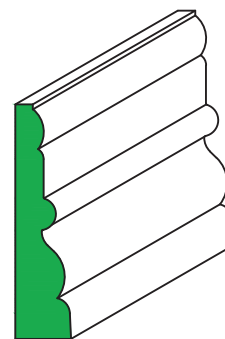

M2100
 $\frac{19}{32} \times 2\text{-}1/2$

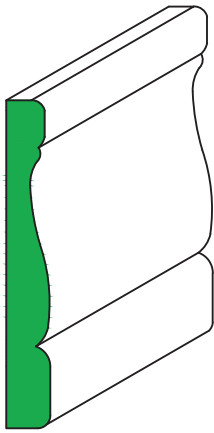

M2112
 $\frac{7}{16} \times 3\frac{1}{2}$

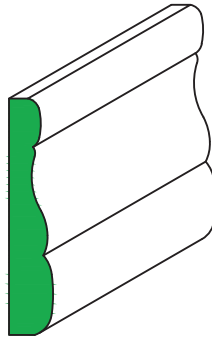

M2110
 $\frac{7}{16} \times 2\frac{1}{2}$

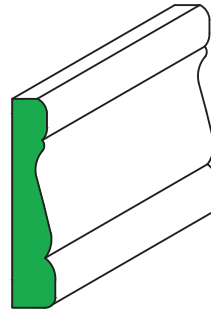

M2109
 $\frac{7}{16} \times 2\frac{1}{4}$

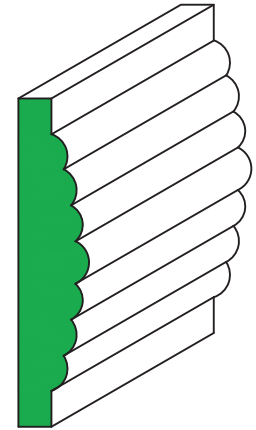

M2142
 $\frac{3}{4} \times 3\frac{1}{2}$

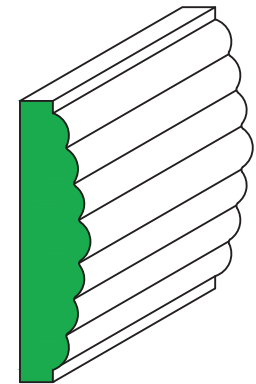

M2140
 $\frac{3}{4} \times 3$

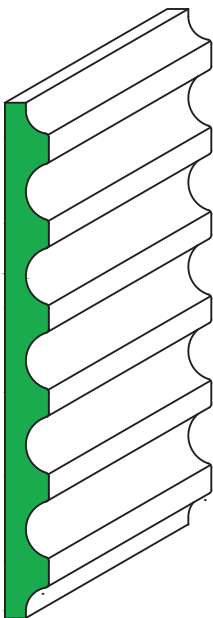

M2130
 $\frac{15}{32} \times 5\frac{1}{2}$

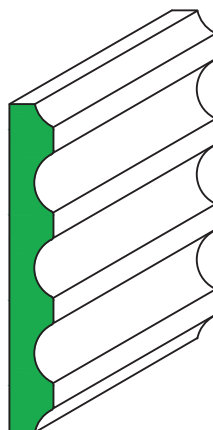

M2128
 $\frac{15}{32} \times 3\frac{1}{2}$

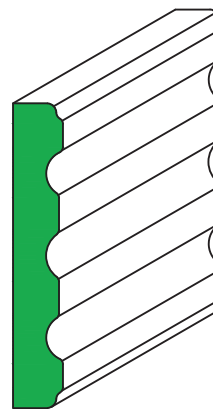

M2124
 $\frac{1}{2} \times 3\frac{1}{4}$

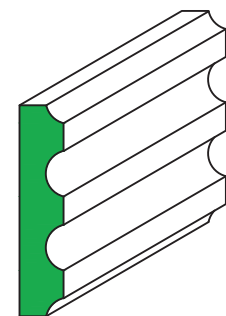

M2126
 $\frac{15}{32} \times 2\frac{1}{4}$

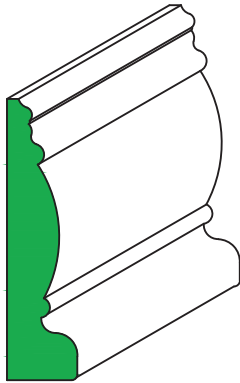

M2179
 $\frac{3}{4} \times 3$

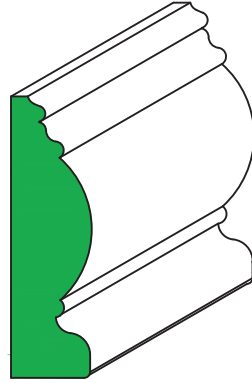

M2150
 $\frac{27}{32} \times 3$

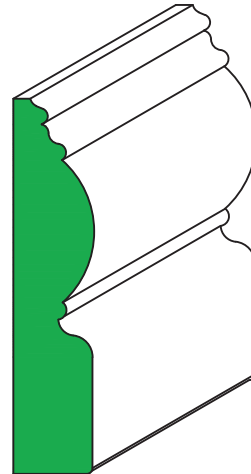

M2152
 $\frac{27}{32} \times 4$

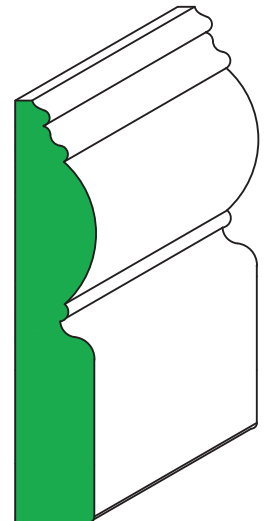

M2160
 $\frac{27}{32} \times 4\frac{1}{2}$

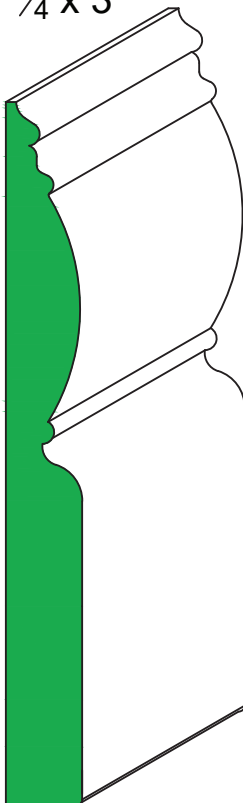

M2168
 $\frac{13}{16} \times 7\frac{1}{2}$

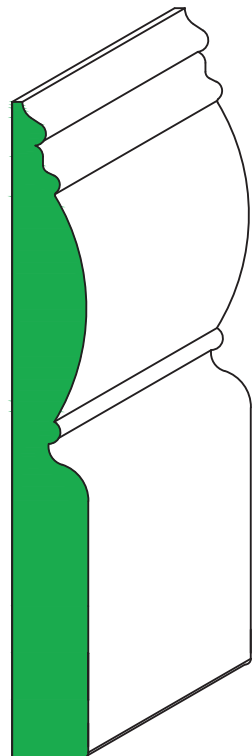

M2166
 $\frac{13}{16} \times 7$

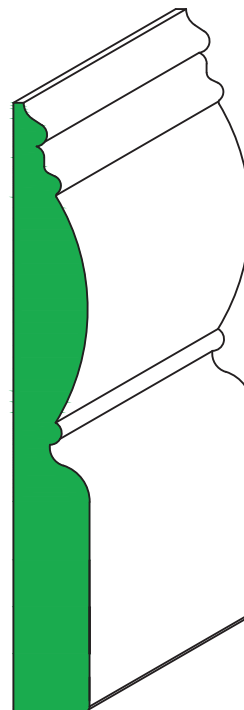

M2164
 $\frac{13}{16} \times 6\frac{1}{2}$

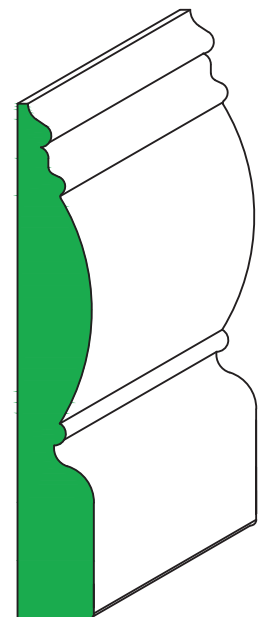

M2162
 $\frac{13}{16} \times 5\frac{1}{2}$

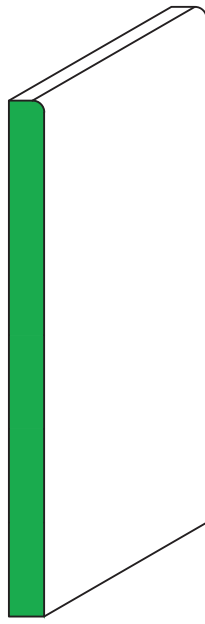

M2205
 $\frac{3}{8} \times 5\frac{1}{2}$

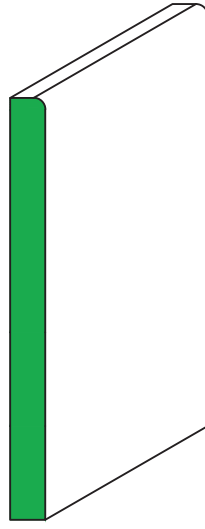

M22204
 $\frac{3}{8} \times 4\frac{1}{2}$

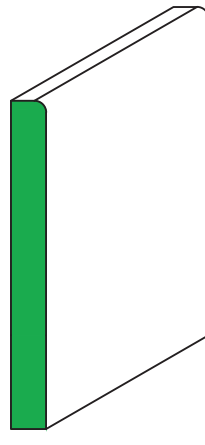

M2202
 $\frac{3}{8} \times 3\frac{1}{2}$

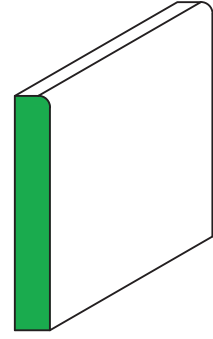

M2200
 $\frac{3}{8} \times 2\frac{1}{2}$

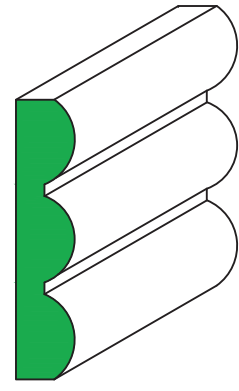

M2220
 $\frac{5}{8} \times 3$

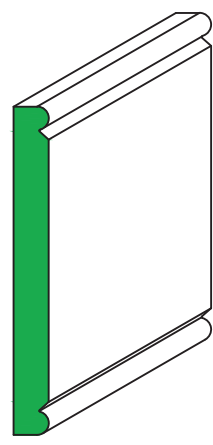

M2207
 $\frac{3}{8} \times 3\frac{1}{2}$

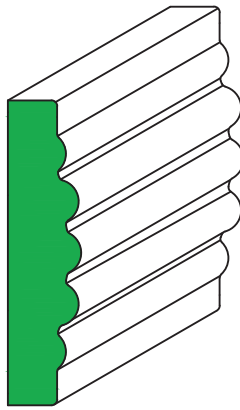

M2264
 $\frac{25}{32} \times 3 \frac{1}{4}$

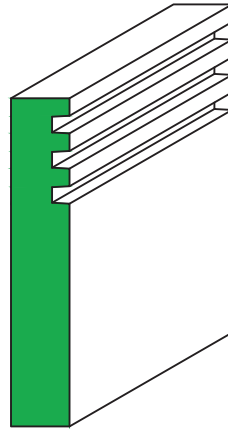

M2254
 $\frac{5}{8} \times 3 \frac{1}{2}$

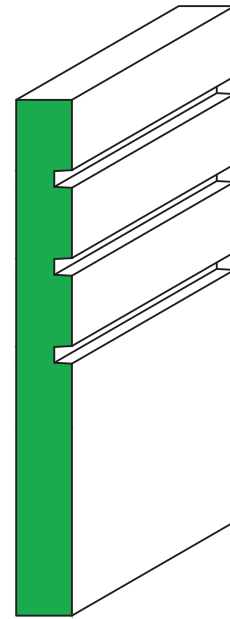

M2258
 $\frac{19}{32} \times 5 \frac{1}{2}$

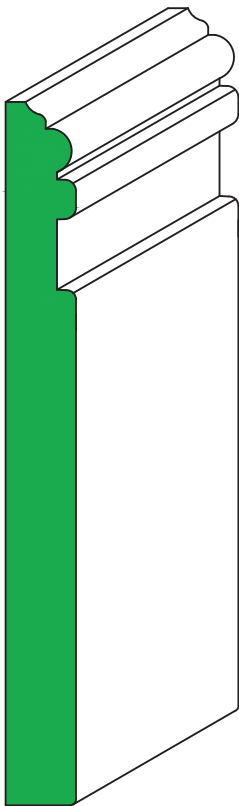

M2238
 $\frac{3}{4} \times 7 \frac{1}{2}$

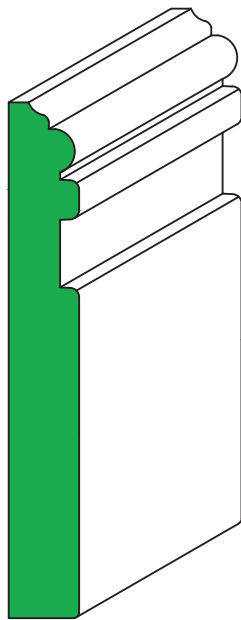

M2236
 $\frac{3}{4} \times 5 \frac{1}{2}$

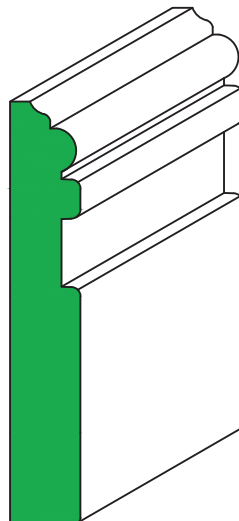

M2234
 $\frac{3}{4} \times 4 \frac{1}{2}$

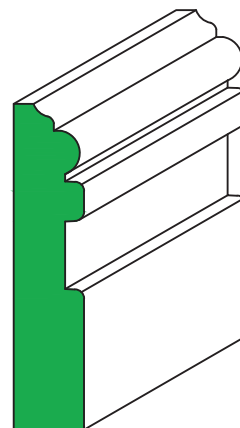

M2232
 $\frac{3}{4} \times 3 \frac{1}{2}$

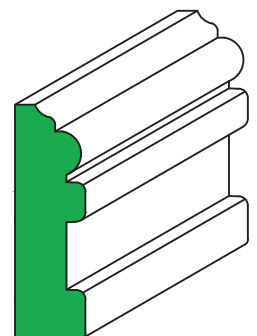

M2230
 $\frac{3}{4} \times 2 \frac{1}{2}$

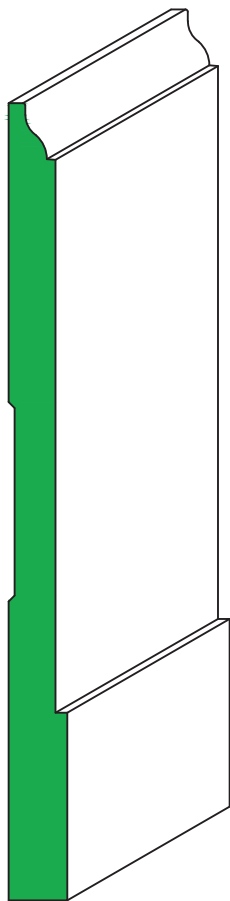

M2420
 $\frac{5}{8} \times 8 \frac{1}{2}$

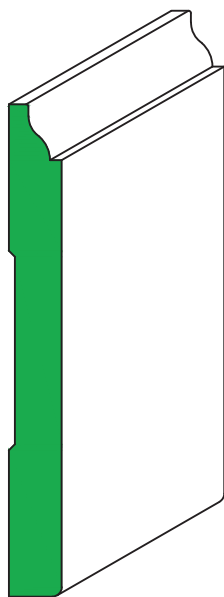

M2424
 $\frac{9}{16} \times 5 \frac{1}{4}$

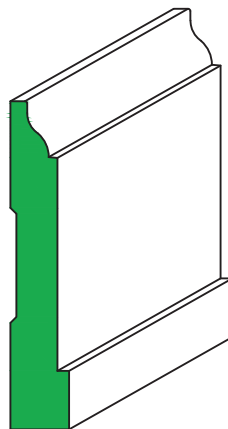

M2418
 $\frac{5}{8} \times 3 \frac{1}{2}$

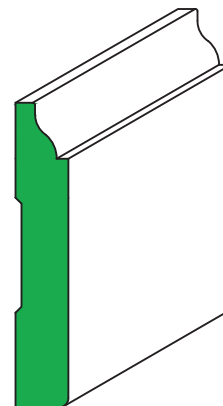

M2422
 $\frac{9}{16} \times 3 \frac{1}{4}$

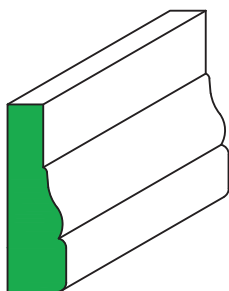

M2438
 $\frac{5}{8} \times 2$

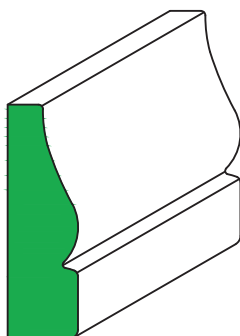

M2436
 $\frac{3}{4} \times 2 \frac{1}{2}$

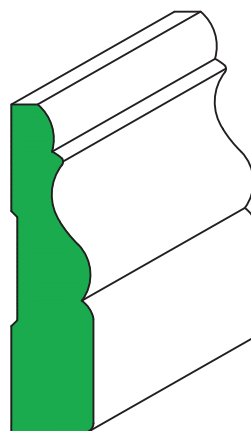

M2428
 $\frac{7}{8} \times 3 \frac{1}{2}$

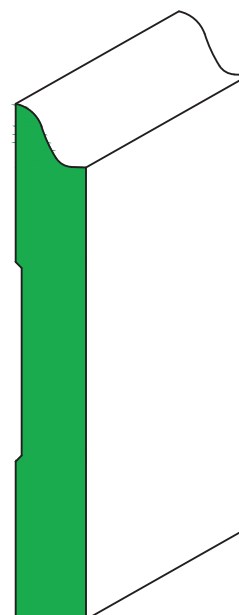

M2426
 $\frac{3}{4} \times 5 \frac{1}{2}$

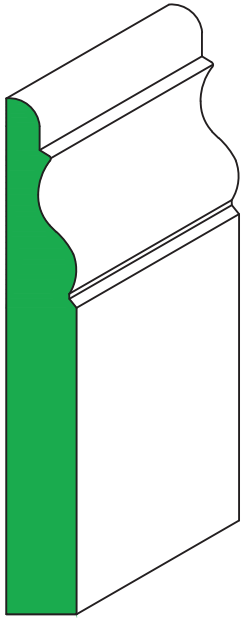

M2440
 $\frac{3}{4} \times 5 \frac{1}{2}$

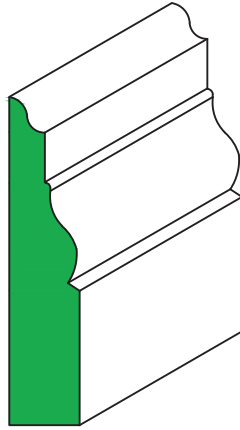

M2442
 $\frac{3}{4} \times 3 \frac{1}{2}$

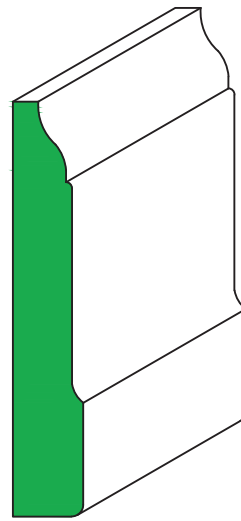

M2444
 $\frac{3}{4} \times 4 \frac{1}{2}$

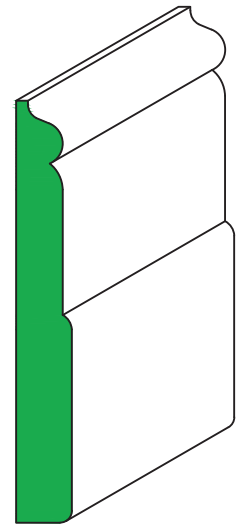

M2446
 $1\frac{9}{32} \times 4 \frac{1}{2}$

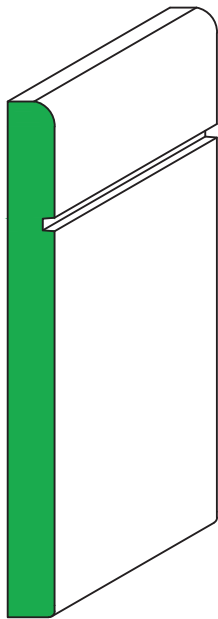

M2448
 $\frac{1}{2} \times 5 \frac{1}{2}$

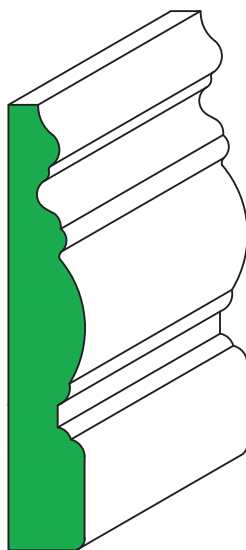

M2450
 $1\frac{13}{16} \times 4 \frac{3}{4}$

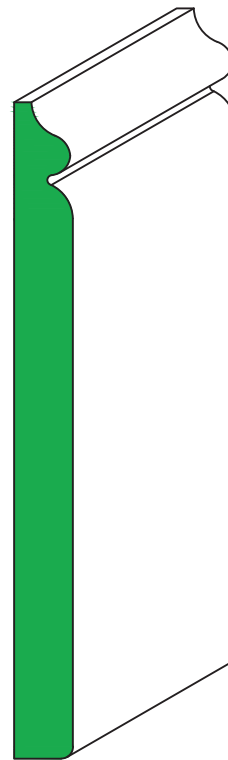

M2452
 $\frac{5}{8} \times 7$

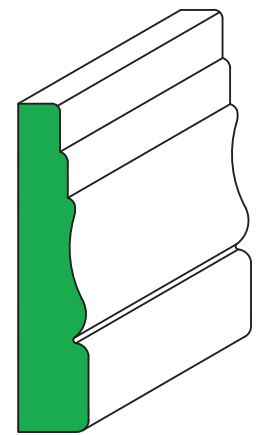

M2454
 $\frac{3}{4} \times 3 \frac{1}{2}$

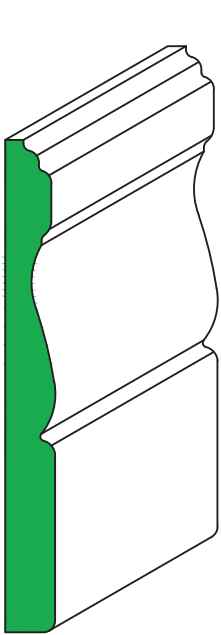

M2456
 $\frac{1}{2} \times 5 \frac{1}{4}$

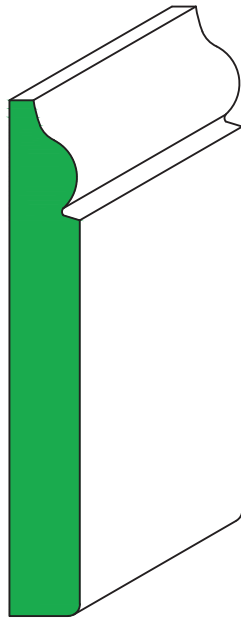

M2458
 $\frac{3}{4} \times 5 \frac{1}{2}$

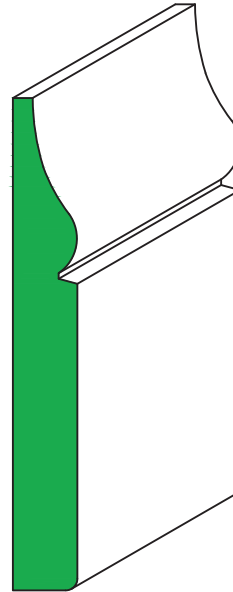

M2460
 $1 \frac{1}{16} \times 5 \frac{1}{4}$

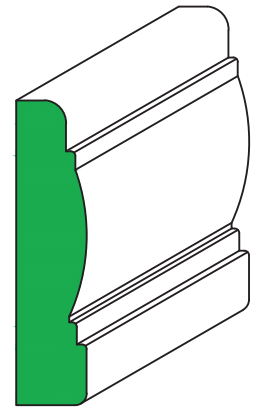

M2462
 $\frac{3}{4} \times 3 \frac{1}{4}$

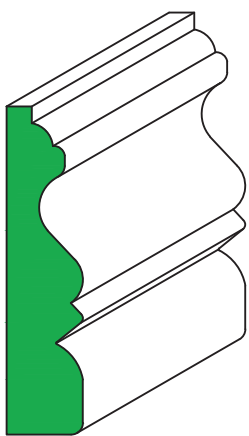

M2464
 $1 \frac{3}{16} \times 3 \frac{1}{2}$

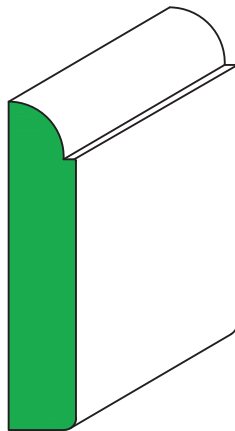

M2466
 $2 \frac{3}{32} \times 3 \frac{1}{2}$

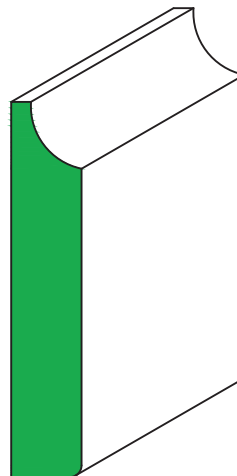

M2470
 $\frac{3}{4} \times 4$

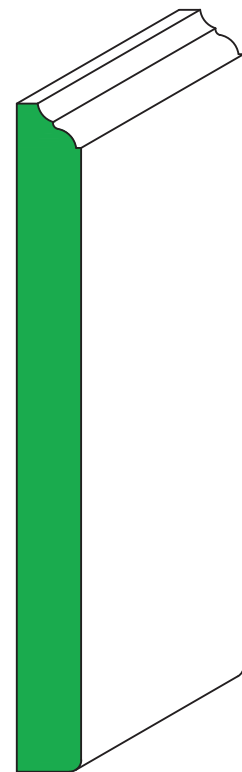

M2468
 $1 \frac{1}{16} \times 7 \frac{1}{8}$

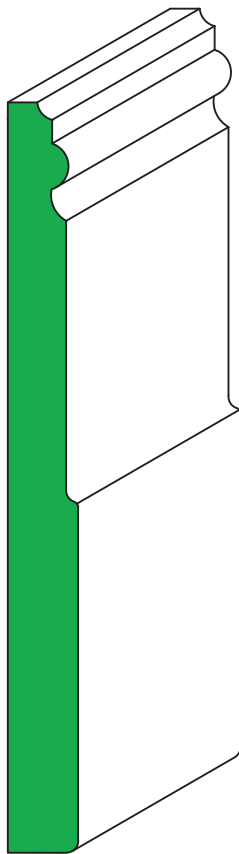

M2472
 $\frac{3}{4} \times 8$

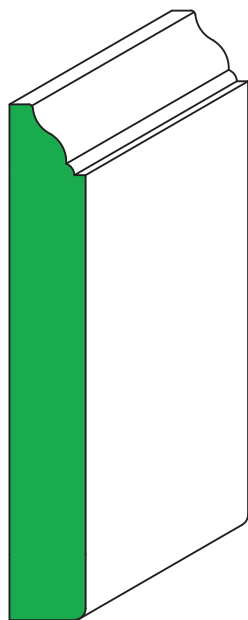

M2478
 $1\frac{3}{16} \times 5\frac{1}{2}$

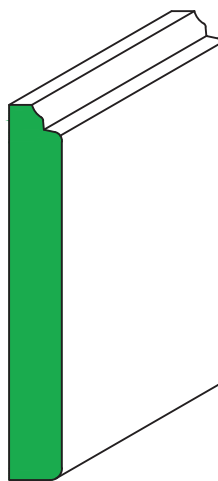

M2480
 $\frac{9}{16} \times 4$

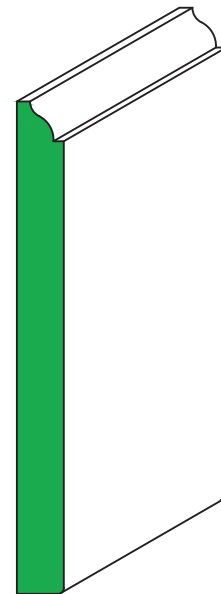

M2482
 $\frac{1}{2} \times 5\frac{1}{4}$

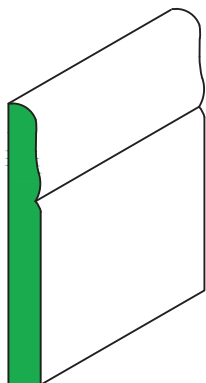

M2484
 $1\frac{1}{32} \times 3$

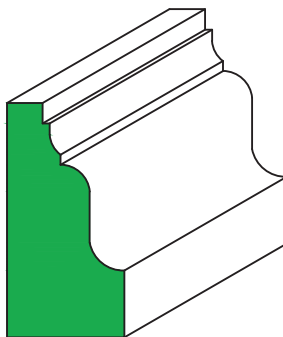

M2474
 $1\frac{1}{4} \times 2\frac{1}{2}$

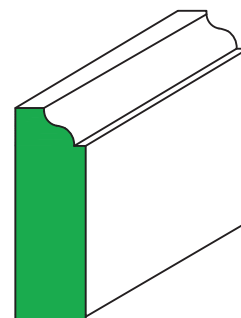

M2476
 $\frac{3}{4} \times 2\frac{1}{4}$

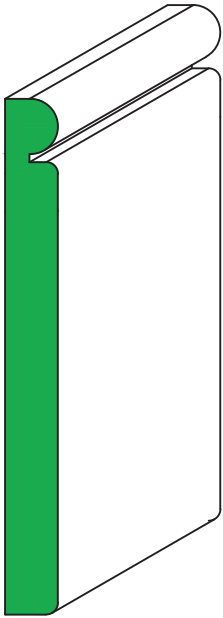

M2486
 $\frac{9}{16} \times 5 \frac{1}{2}$

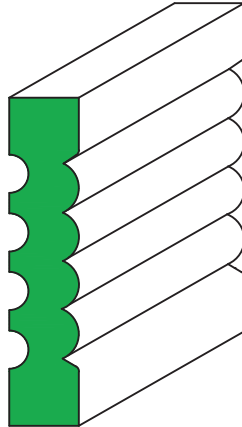

M2488
 $\frac{3}{4} \times 3 \frac{1}{2}$

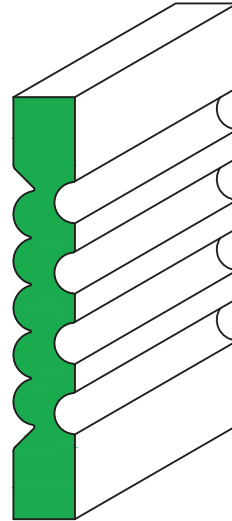

M2490
 $\frac{5}{8} \times 4 \frac{1}{2}$

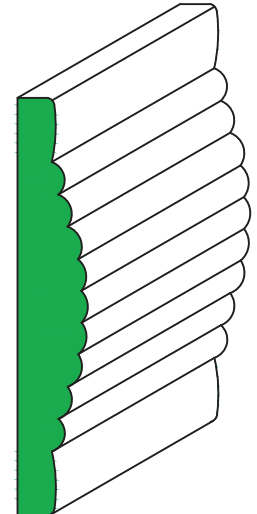

M2492
 $\frac{3}{4} \times 4 \frac{1}{2}$

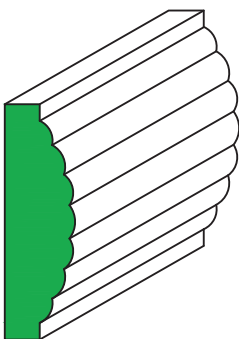

M2498
 $\frac{3}{4} \times 2 \frac{1}{2}$

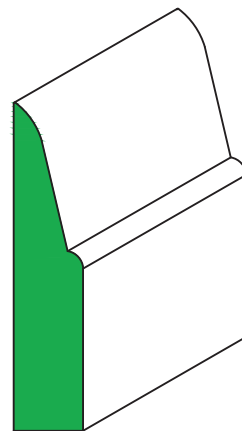

M2500
 $\frac{3}{4} \times 3 \frac{1}{2}$

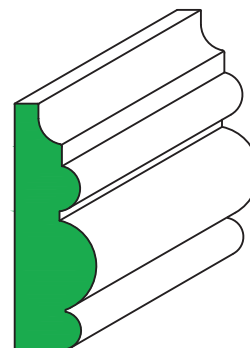

M2502
 $\frac{7}{8} \times 2 \frac{5}{8}$

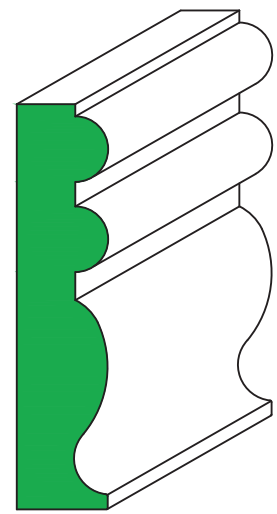

M2504
 $\frac{15}{16} \times 4 \frac{5}{16}$

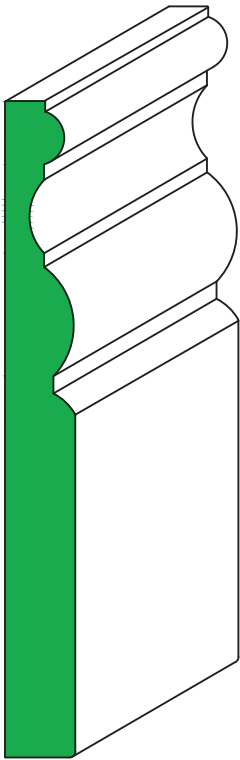

M2506
 $\frac{3}{4} \times 7$

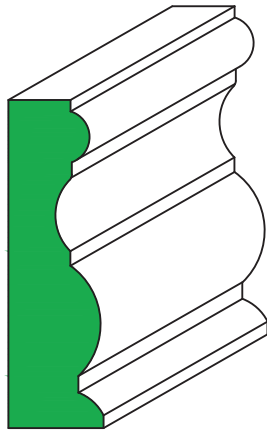

M2508
 $1 \times 3 \frac{1}{2}$

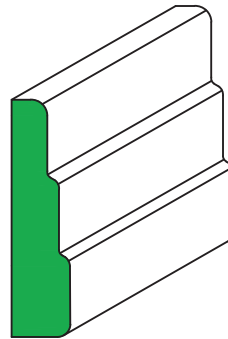

M2510
 $\frac{5}{8} \times 2 \frac{1}{2}$

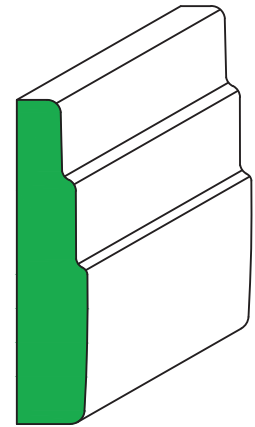

M2512
 $\frac{3}{4} \times 3 \frac{7}{16}$

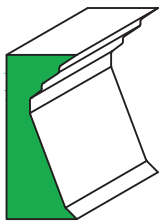

M2514
 $\frac{3}{4} \times 1 \frac{3}{4}$

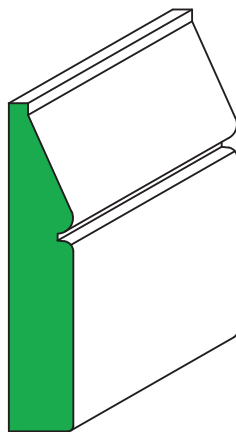

M2516
 $1 \frac{1}{16} \times 3 \frac{1}{2}$

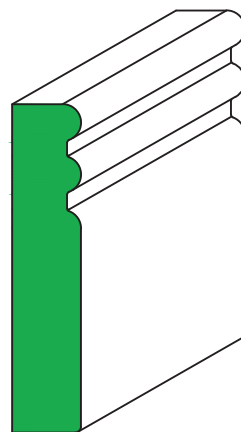

M2518
 $\frac{3}{4} \times 3 \frac{1}{2}$

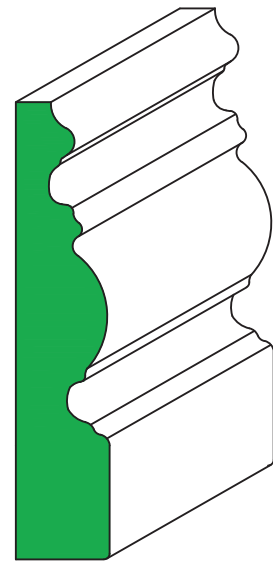

M2520
 $1 \times 4 \frac{7}{8}$

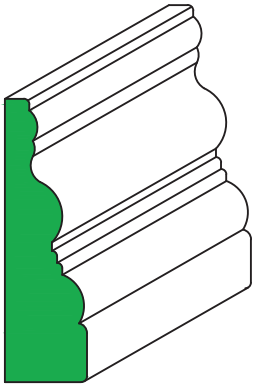

M2522
 $\frac{7}{8} \times 3$

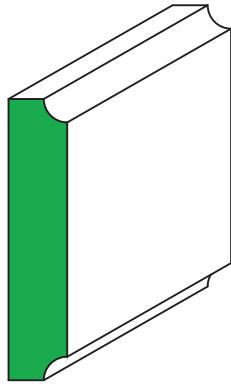

M2528
 $\frac{5}{8} \times 3$

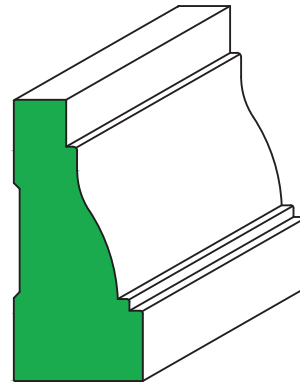

M2530
 $1 \frac{3}{8} \times 3$

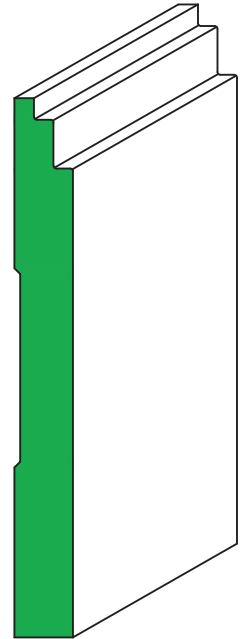

M2536
 $\frac{5}{8} \times 5 \frac{3}{4}$

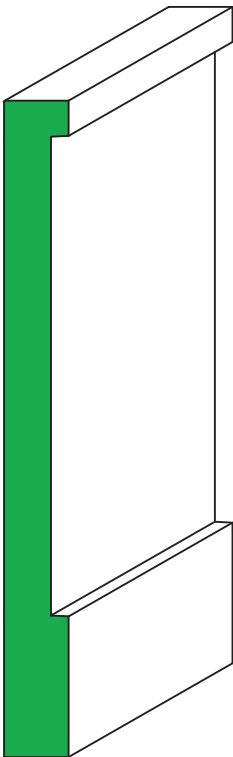

M2524
 $1 \frac{1}{16} \times 7$

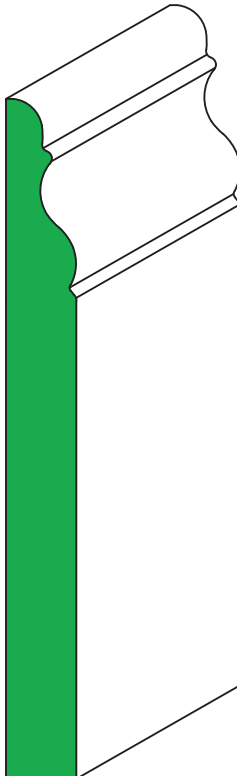

M2526
 $\frac{3}{4} \times 7 \frac{1}{4}$

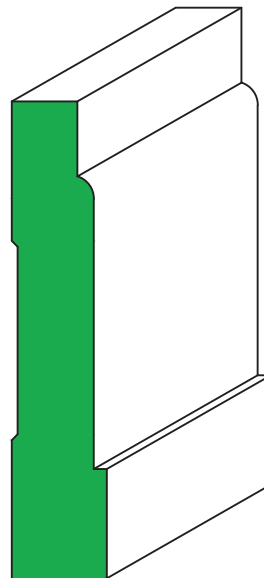

M2532
 $1 \times 5 \frac{1}{8}$

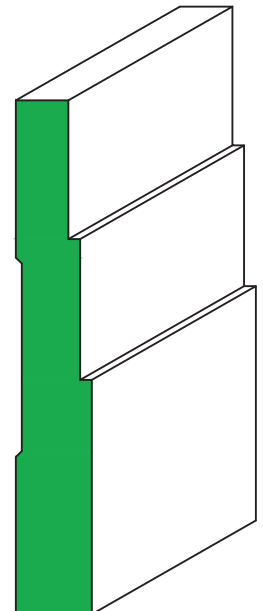

M2534
 $1 \frac{3}{16} \times 5 \frac{1}{2}$

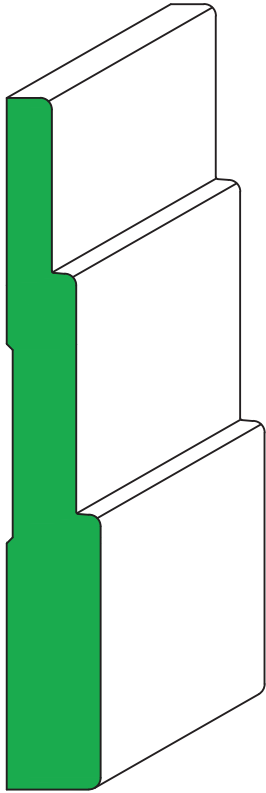

M2538
1 x 7 3/8

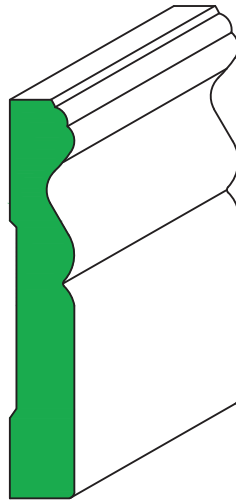

M2540
1 1/16 x 4 1/4

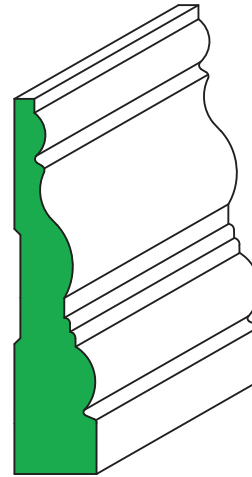

M2542
7/8 x 4

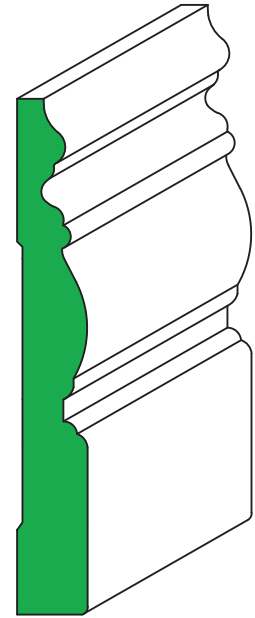

M2544
3/4 x 5 1/2

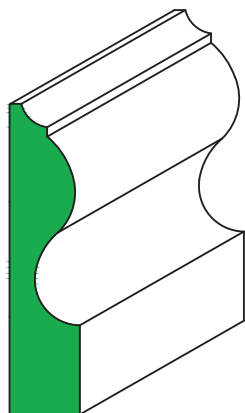

M2546
3/4 x 3 5/16

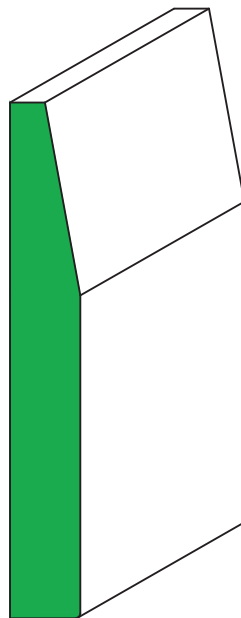

M2560
3/4 x 5 1/2

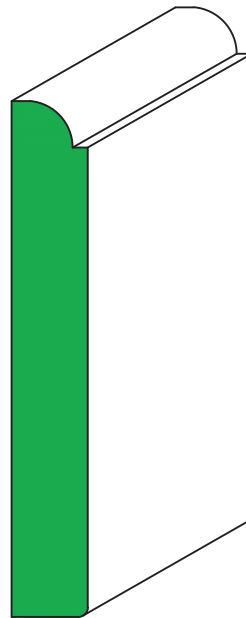

M2562
13/16 x 5 1/2

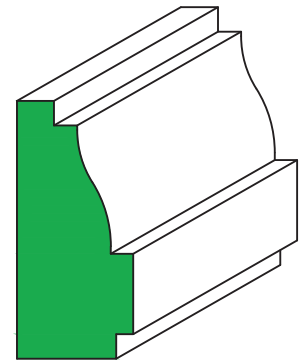

M2564
1 1/4 x 2 3/4

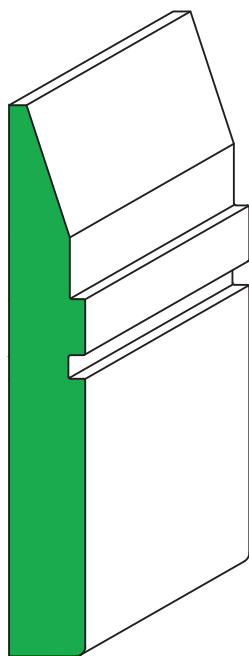

M2566
 $1\frac{3}{16} \times 5\frac{7}{8}$

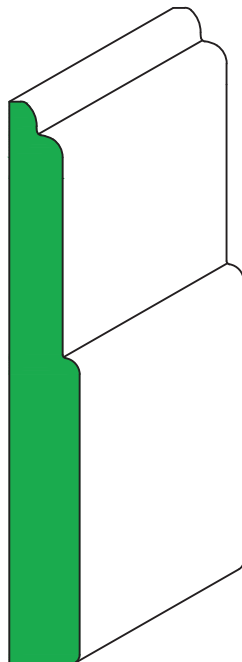

M2568
 $\frac{3}{4} \times 6$

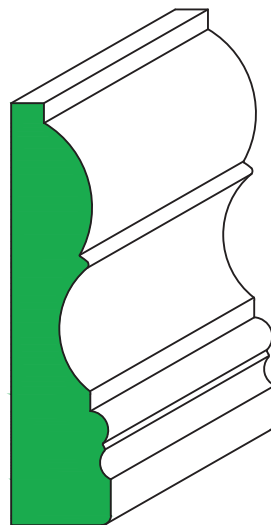

M2570
 $1\frac{1}{16} \times 4\frac{1}{2}$

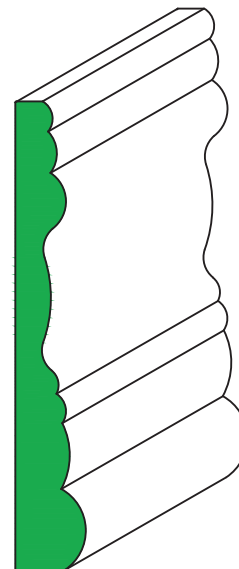

M2572
 $\frac{3}{4} \times 5$

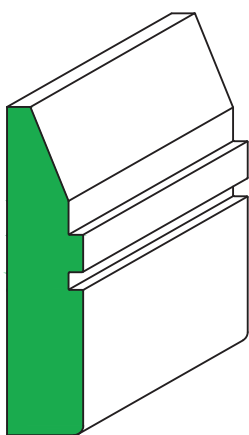

M2567
 $1\frac{3}{16} \times 3\frac{1}{2}$

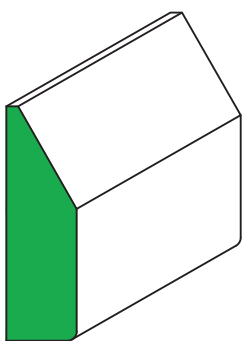

M2574
 $\frac{3}{4} \times 2\frac{1}{2}$

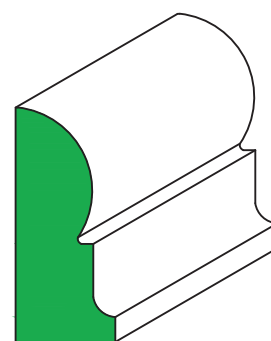

M2576
 $1\frac{1}{16} \times 2\frac{1}{2}$

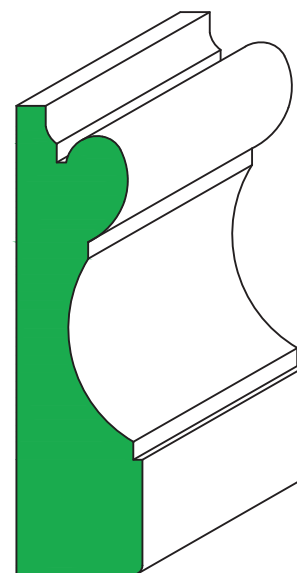

M2578
 $1\frac{5}{16} \times 5$

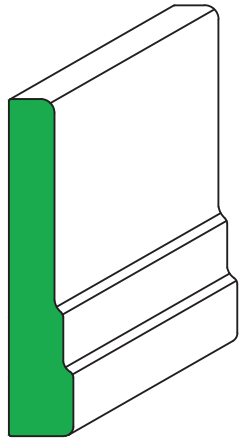

M2580
 $1\frac{1}{16} \times 3\frac{9}{16}$

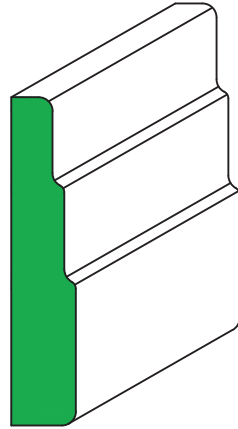

M2582
 $1\frac{1}{16} \times 3\frac{1}{2}$

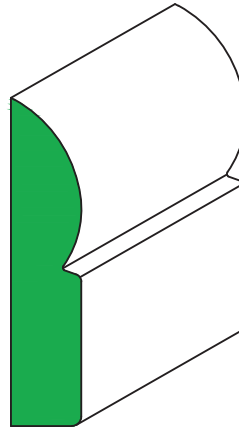

M2592
 $\frac{3}{4} \times 3\frac{1}{2}$

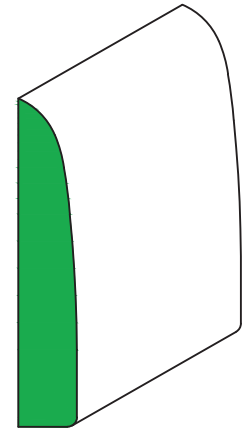

M2586
 $\frac{5}{8} \times 3\frac{1}{2}$

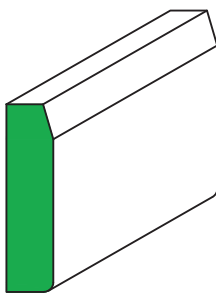

M2588
 $\frac{1}{2} \times 2$

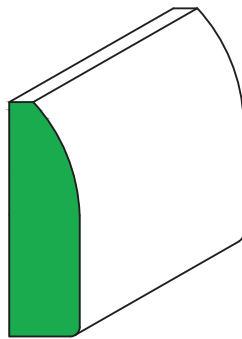

M2590
 $\frac{3}{4} \times 2\frac{1}{2}$

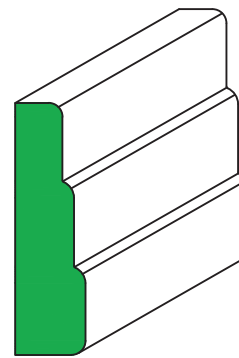

M2584
 $\frac{3}{4} \times 2\frac{1}{16}$

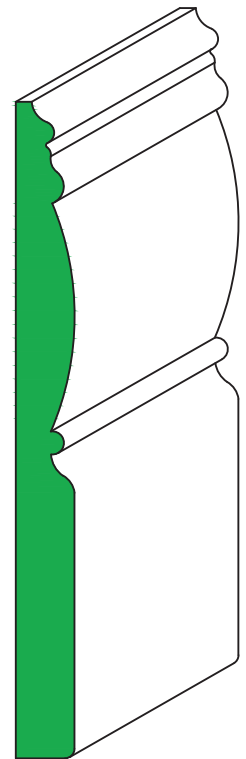

M2594
 $\frac{5}{8} \times 7$

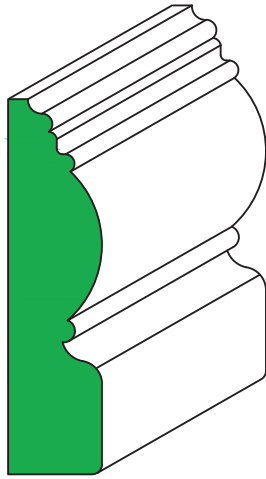

M2596
1 x 4

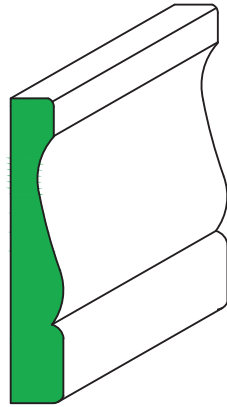

M2602
 $\frac{9}{16} \times 3 \frac{1}{4}$

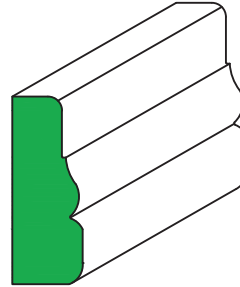

M2600
 $\frac{3}{4} \times 2"$

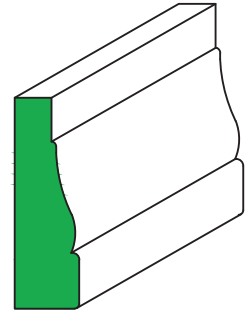

M2598
 $1 \frac{1}{16} \times 2 \frac{1}{4}$

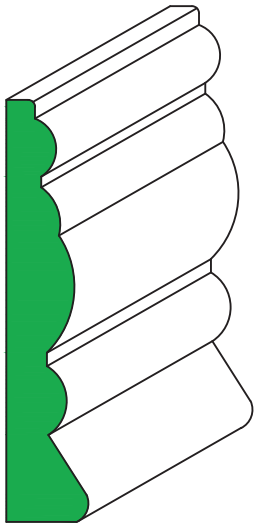

M2604
 $\frac{7}{8} \times 4 \frac{1}{2}$

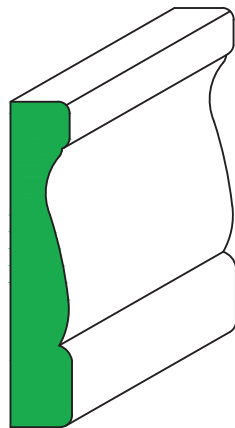

M2606
 $2 \frac{1}{32} \times 3 \frac{1}{2}$

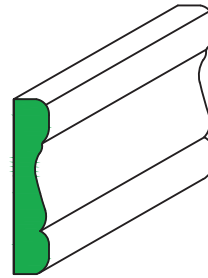

M2608
 $\frac{3}{8} \times 1 \frac{7}{8}$

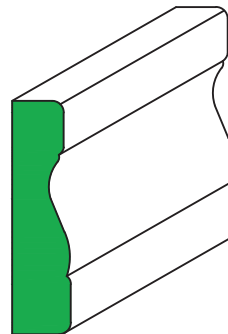

M2610
 $\frac{5}{8} \times 2 \frac{1}{2}$

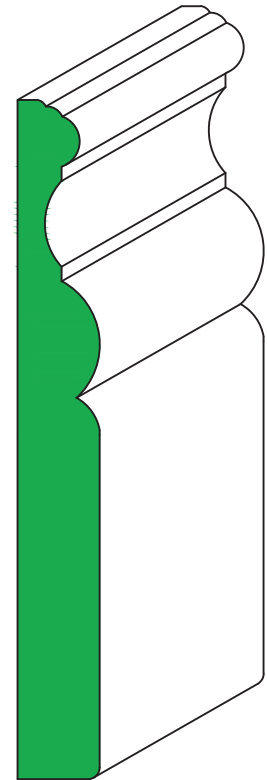

M2612
 $\frac{7}{8} \times 7 \frac{1}{4}$

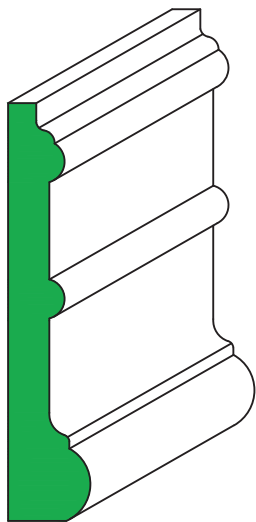

M2614
 $\frac{7}{8} \times 4 \frac{1}{2}$

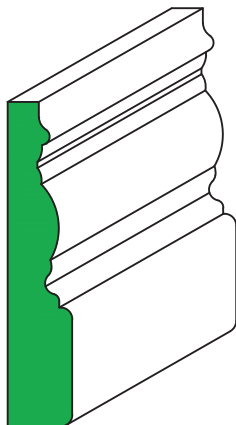

M2616
 $1 \frac{1}{16} \times 3 \frac{1}{2}$

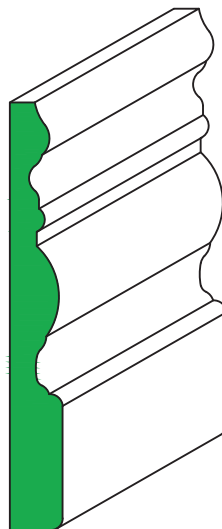

M2618
 $\frac{9}{16} \times 4 \frac{1}{2}$

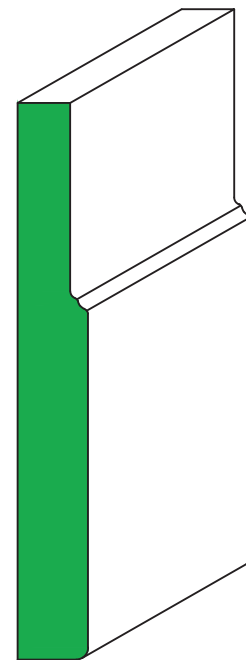

M2620
 $\frac{3}{4} \times 6$

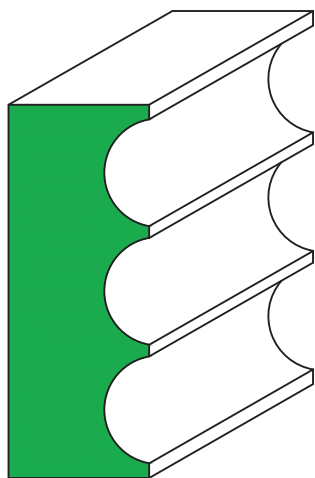

M2622
 $1 \frac{1}{2} \times 4$

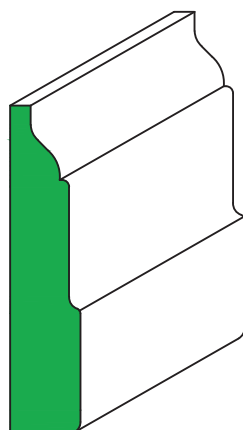

M2624
 $\frac{3}{4} \times 3 \frac{1}{2}$

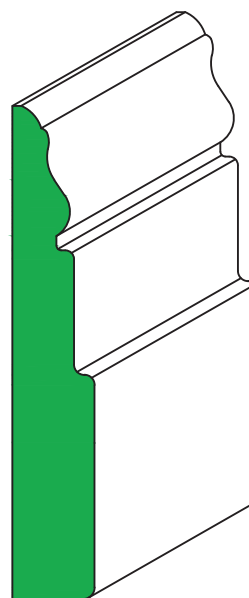

M2626
 $\frac{7}{8} \times 5 \frac{1}{4}$

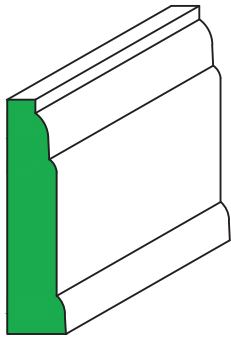

M2628
 $\frac{5}{8} \times 2 \frac{1}{2}$

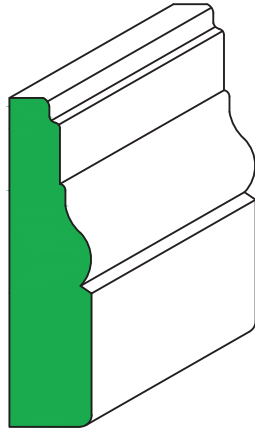

M2630
 $\frac{7}{8} \times 3 \frac{1}{2}$

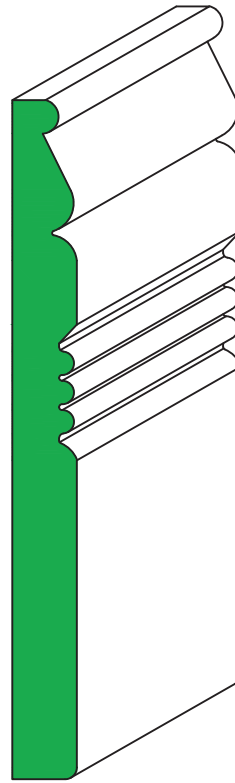

M2636
 $1 \frac{1}{16} \times 7 \frac{1}{4}$

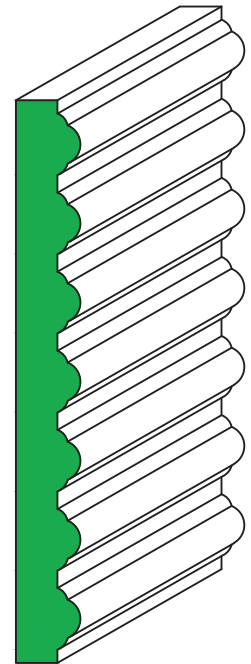

M2638
 $1 \frac{1}{16} \times 6''$

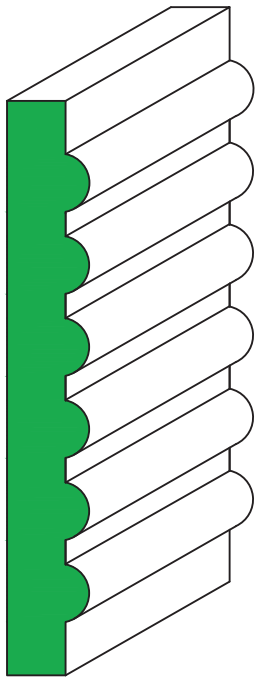

M2632
 $\frac{7}{8} \times 6 \frac{1}{8}$

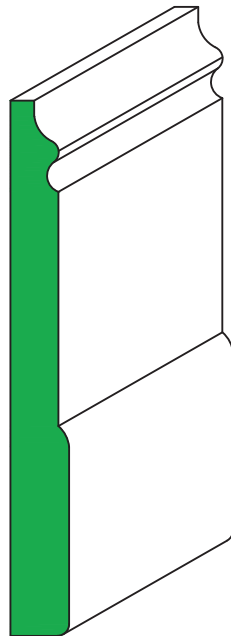

M2634
 $\frac{5}{8} \times 5 \frac{3}{4}$

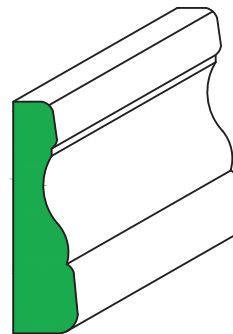

M2640
 $1 \frac{1}{16} \times 2 \frac{1}{2}$

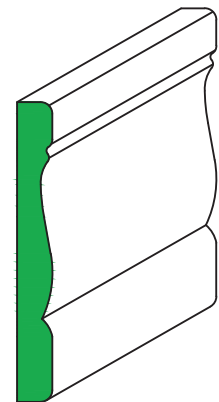

M2642
 $\frac{3}{8} \times 3 \frac{1}{4}$

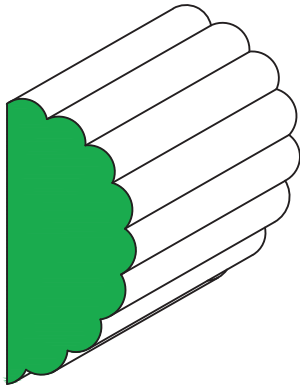

M2644
1 3/8 x 3"

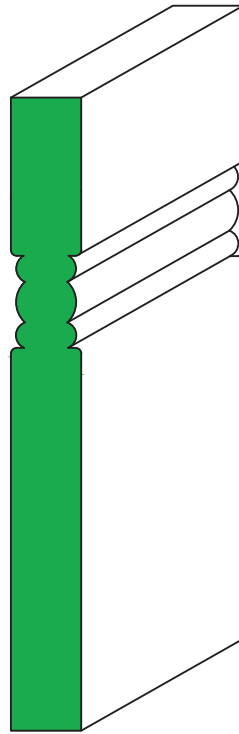

M2648
3/4 x 6 3/4

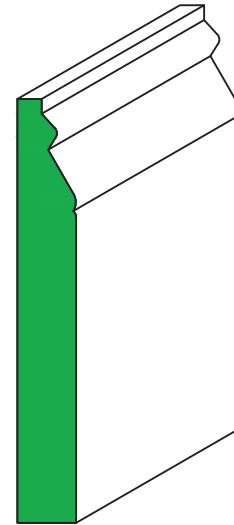

M2652
5/8 x 4 1/2

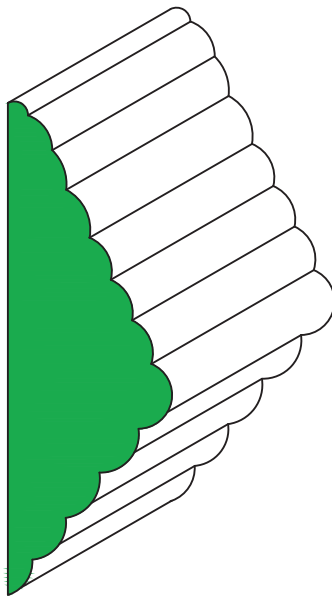

M2646
1 3/4 x 5 1/4

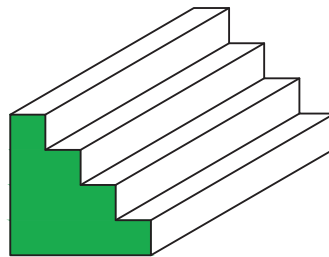

M2650
1 1/2 x 1 1/2

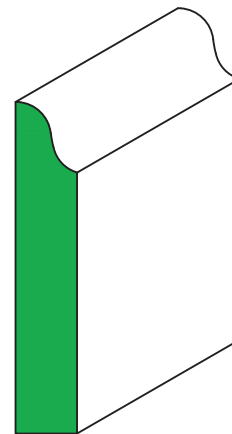

M2654
5/8 x 3 1/2

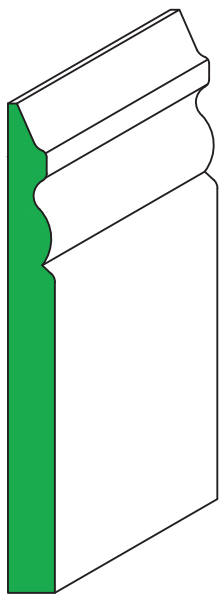

M2656
 $\frac{1}{2} \times 5\frac{1}{4}$

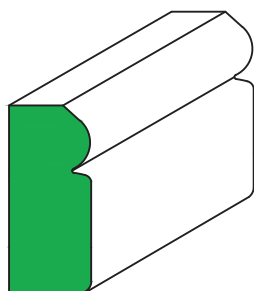

M2658
 $\frac{7}{8} \times 2"$

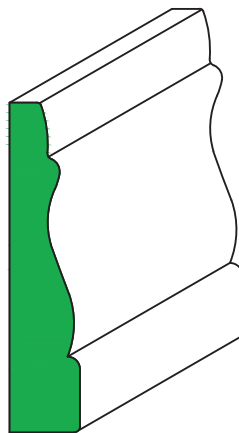

M2668
 $\frac{3}{4} \times 3\frac{1}{2}$

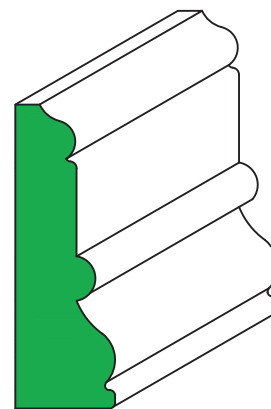

M2670
 $\frac{1}{16} \times 3\frac{1}{4}$

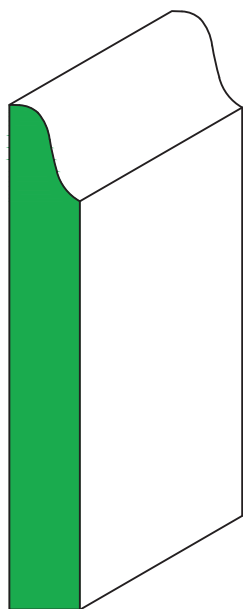

M2660
 $\frac{5}{8} \times 5\frac{3}{8}$

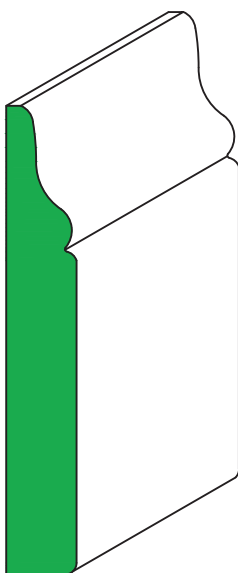

M2662
 $\frac{3}{4} \times 5"$

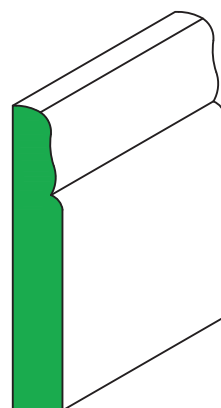

M2664
 $\frac{17}{32} \times 3\frac{1}{4}$

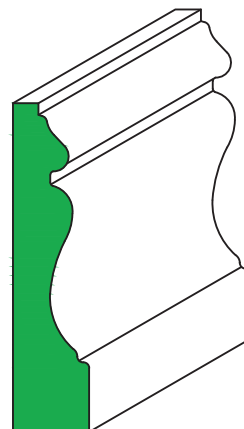

M2666
 $\frac{13}{16} \times 3\frac{1}{4}$

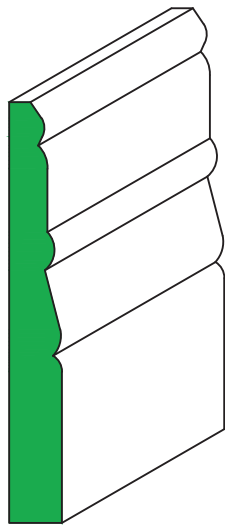

M2672
 $\frac{9}{16} \times 4\frac{1}{2}$

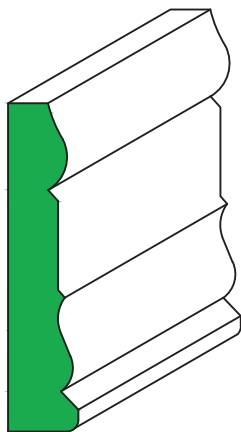

M2674
 $\frac{3}{4} \times 3\frac{1}{2}$

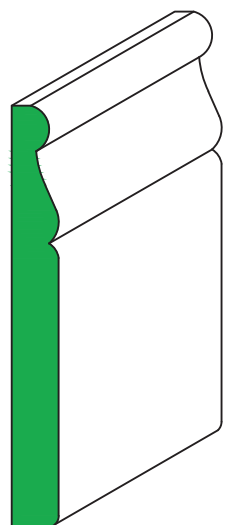

M2682
 $\frac{1}{2} \times 4\frac{1}{2}$

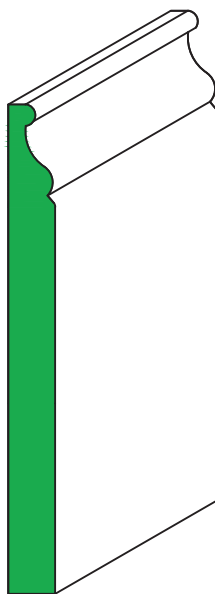

M2680
 $\frac{1}{2} \times 5\frac{1}{4}$

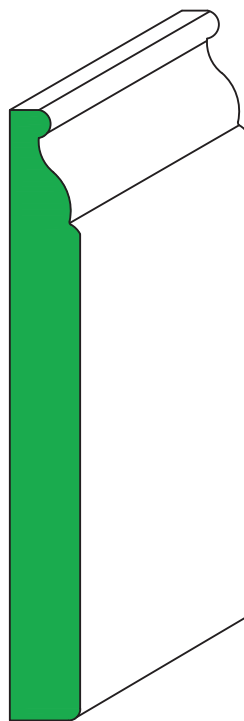

M2678
 $\frac{3}{4} \times 6\frac{1}{2}$

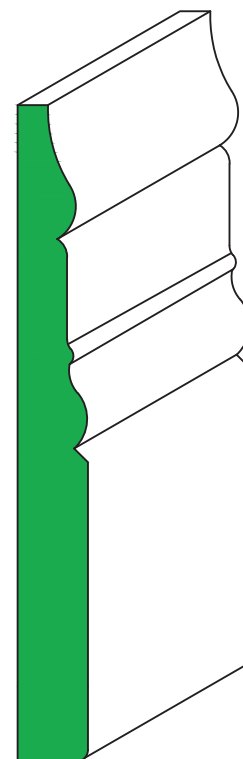

M2676
 $\frac{3}{4} \times 7"$

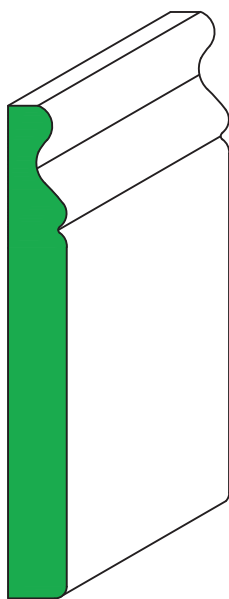

M2684
 $\frac{5}{8} \times 5\frac{1}{4}$

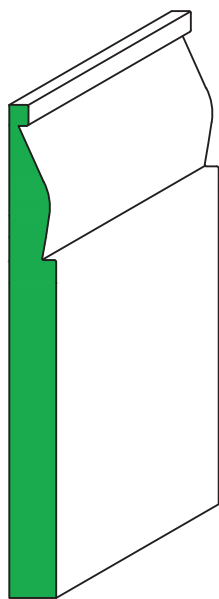

M2688
 $\frac{1}{2} \times 5\frac{1}{4}$

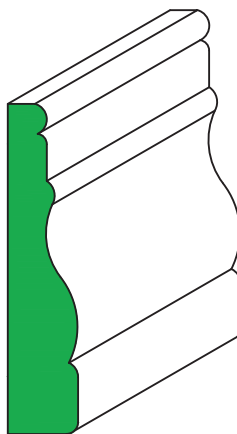

M2692
 $\frac{3}{4} \times 3\frac{1}{2}$

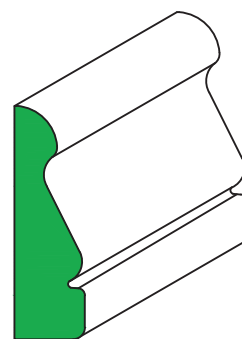

M2694
 $\frac{3}{4} \times 2\frac{1}{2}$

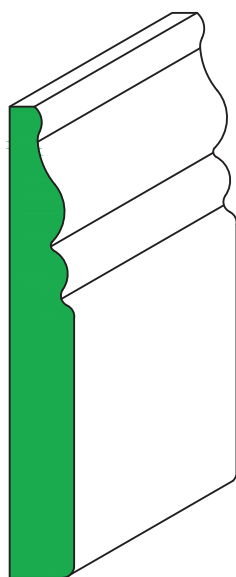

M2686
 $1\frac{1}{16} \times 5"$

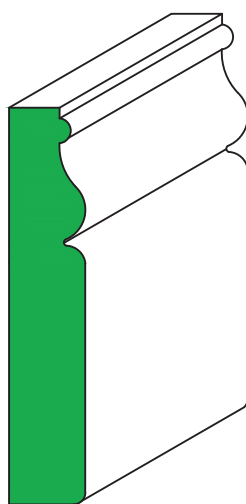

M2690
 $1\frac{3}{16} \times 4\frac{1}{4}$

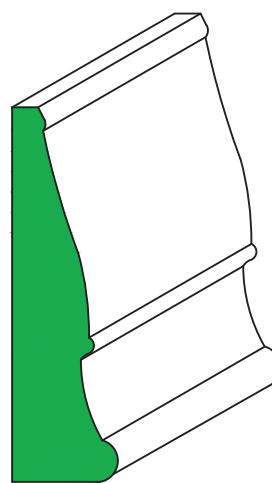

M2698
 $1\frac{1}{8} \times 4"$

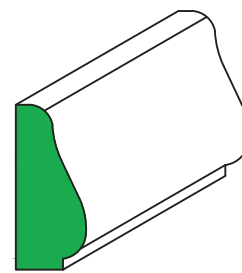

M2696
 $\frac{3}{4} \times 1\frac{3}{4}$

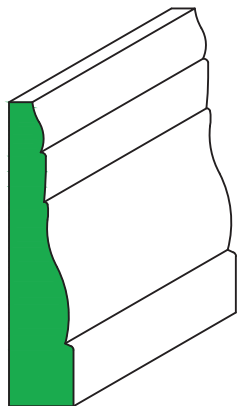

M2700
 $1\frac{1}{16} \times 3\frac{1}{4}$

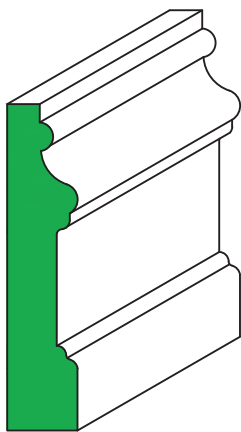

M2702
 $\frac{3}{4} \times 3\frac{1}{2}$

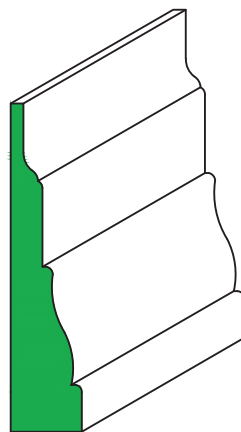

M2706
 $\frac{3}{4} \times 3\frac{1}{2}$

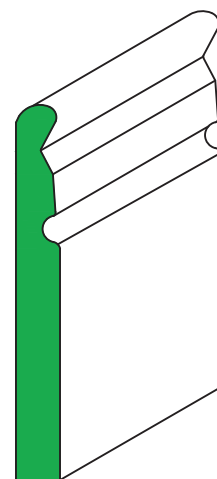

M2708
 $1\frac{5}{32} \times 4"$

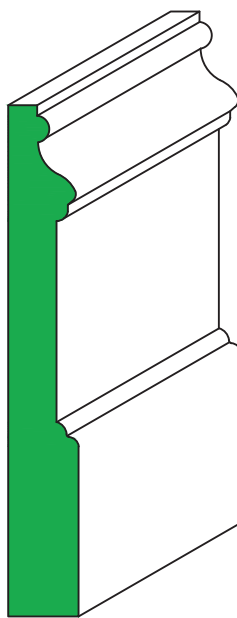

M2704
 $\frac{3}{4} \times 5\frac{1}{2}$

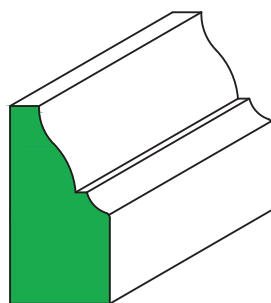

M2712
 $1\frac{1}{16} \times 2\frac{1}{8}$

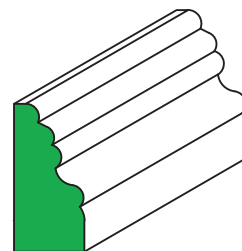

M2716
 $\frac{3}{4} \times 1\frac{9}{16}$

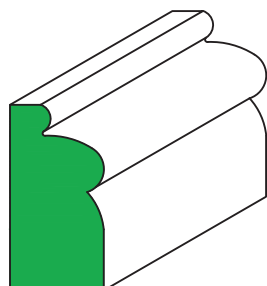

M2710
 $1" \times 2"$

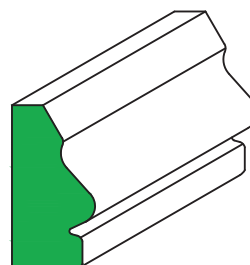

M2714
 $\frac{7}{8} \times 1\frac{3}{4}$

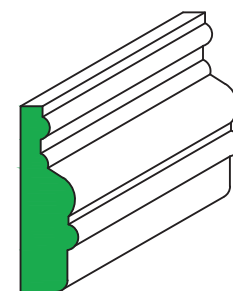

M2718
 $\frac{5}{8} \times 2"$

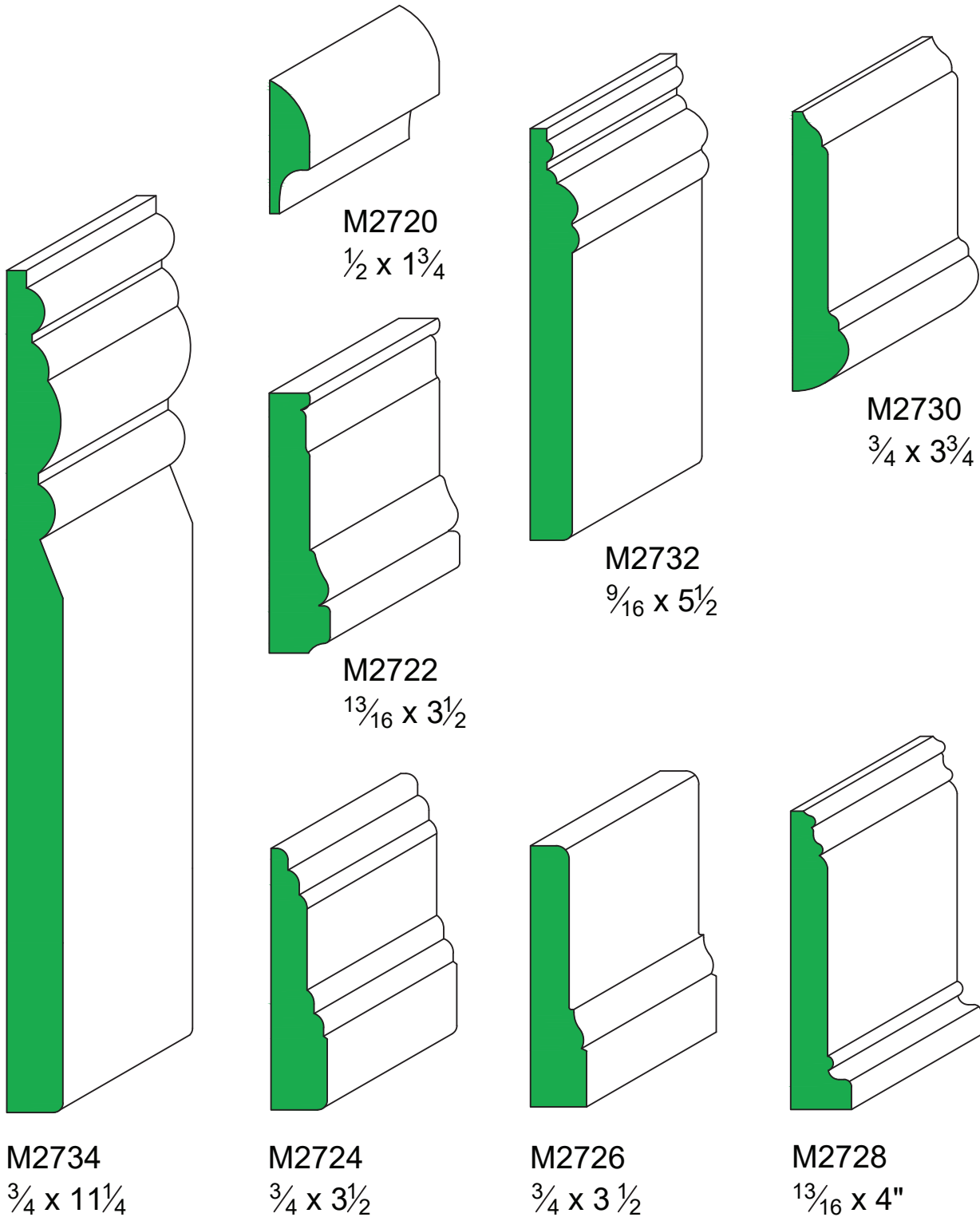

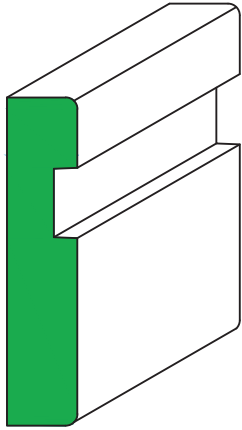

M2736
 $\frac{3}{4} \times 3\frac{1}{2}$

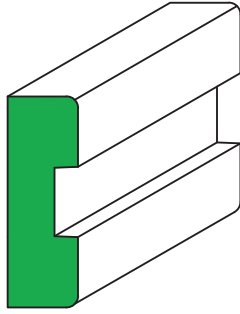

M2738
 $\frac{3}{4} \times 2\frac{1}{4}$

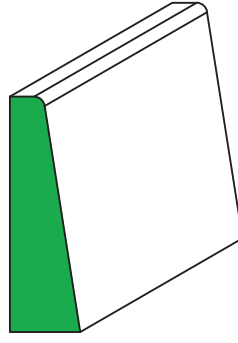

M2742
 $\frac{3}{4} \times 2\frac{1}{2}$

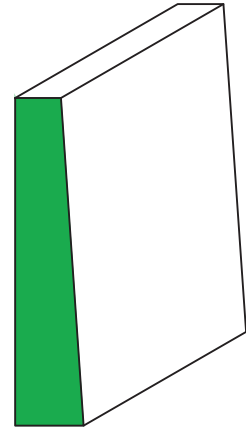

M2746
 $\frac{3}{4} \times 3\frac{1}{2}$

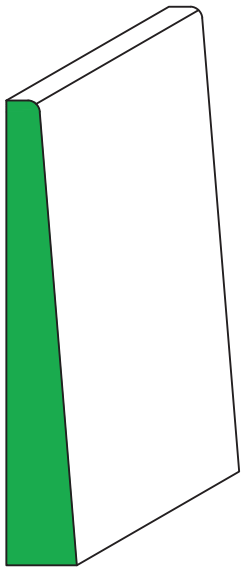

M2740
 $\frac{3}{4} \times 5"$

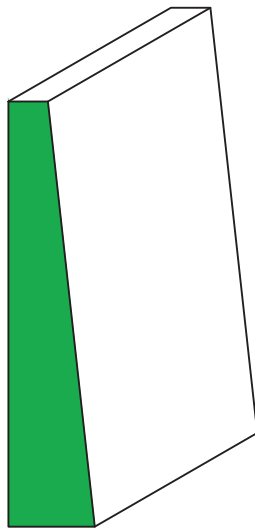

M2744
 $\frac{15}{16} \times 4\frac{9}{16}$

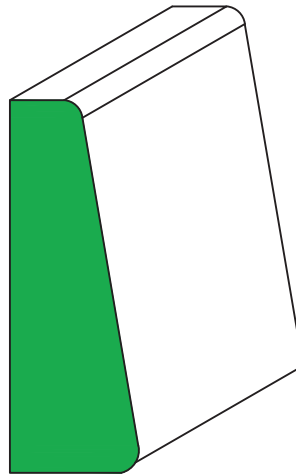

M2748
 $1\frac{3}{8} \times 4"$

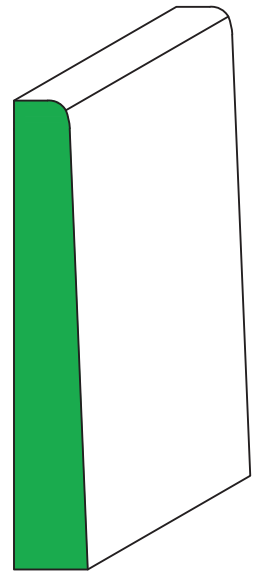

M2750
 $1\frac{3}{16} \times 5"$

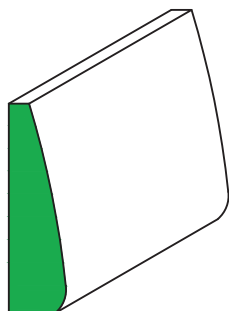

M2754
 $\frac{5}{8} \times 2\frac{1}{4}$

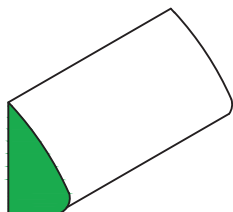

M2756
 $\frac{5}{8} \times 1\frac{3}{16}$

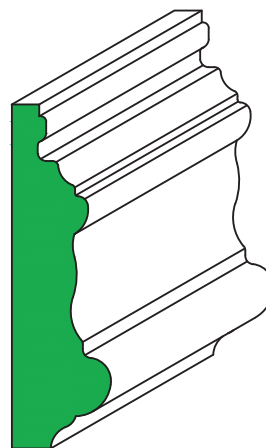

M2760
 $1\frac{1}{16} \times 3\frac{1}{16}$

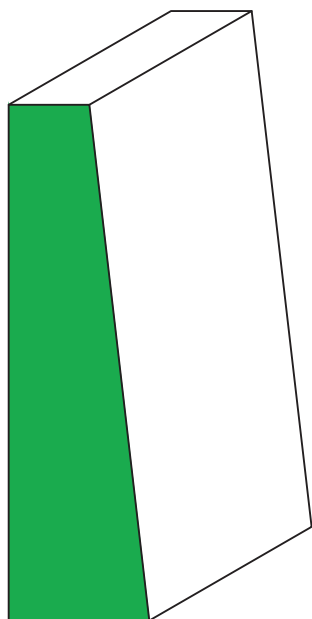

M2752
 $1\frac{1}{2} \times 5\frac{1}{2}$

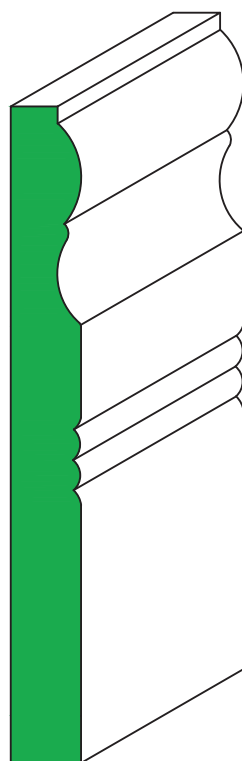

M2758
 $\frac{3}{4} \times 7"$

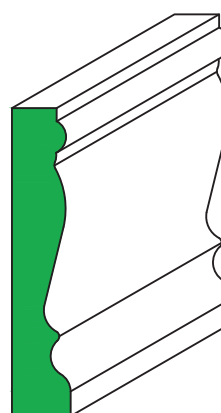

M2762
 $\frac{5}{8} \times 3\frac{5}{16}$

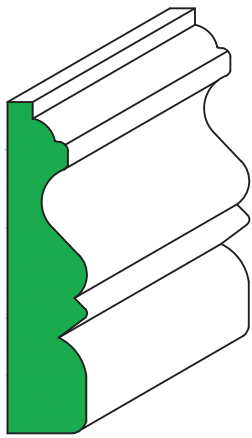

M2764
 $1\frac{3}{16} \times 3\frac{9}{16}$

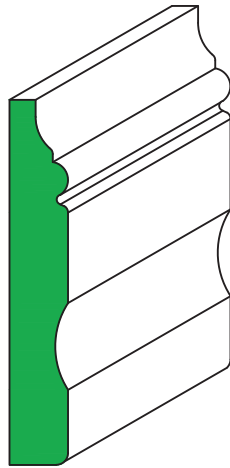

M2766
 $\frac{5}{8} \times 3\frac{7}{8}$

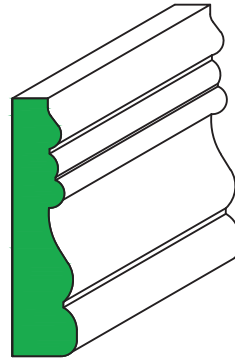

M2768
 $1\frac{1}{16} \times 2\frac{3}{4}$

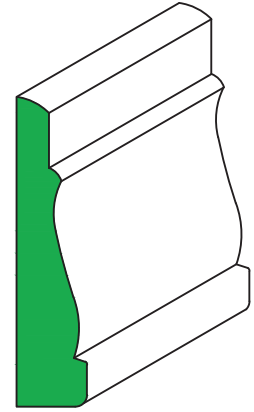

M2770
 $\frac{3}{4} \times 3\frac{5}{16}$

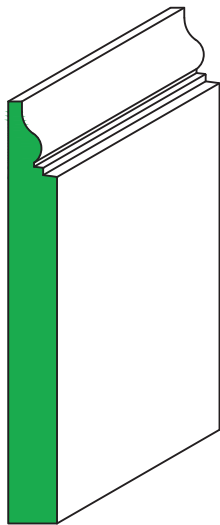

M2772
 $\frac{1}{2} \times 4\frac{1}{2}$

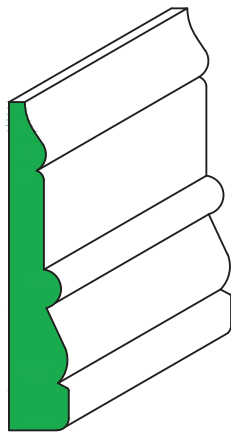

M2774
 $\frac{5}{8} \times 3\frac{1}{2}$

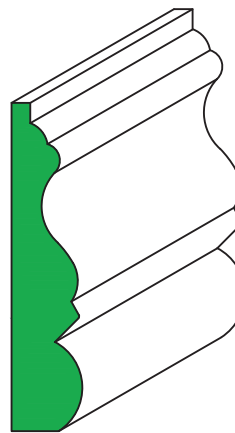

M2776
 $\frac{3}{4} \times 3\frac{1}{2}$

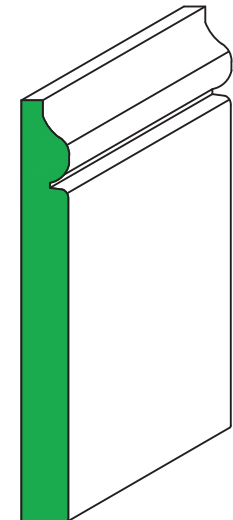

M2778
 $\frac{1}{2} \times 4\frac{1}{2}$

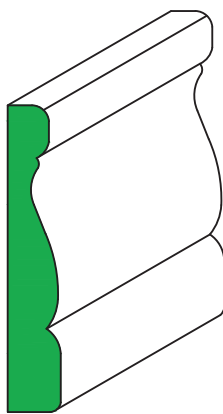

M2782
 $\frac{9}{16} \times 3\frac{1}{4}$

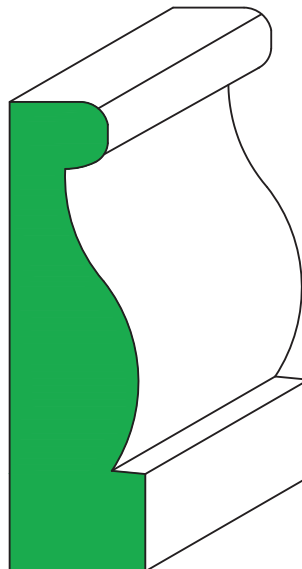

M2790
 $5" \times 1\frac{7}{16}$

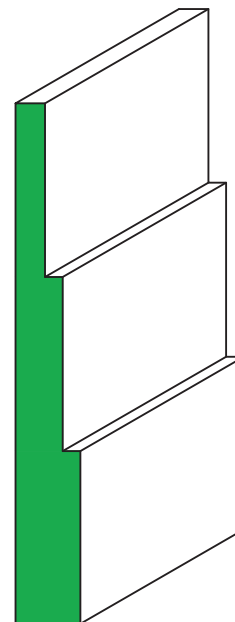

M2792
 $1\frac{1}{16} \times 5\frac{1}{2}$

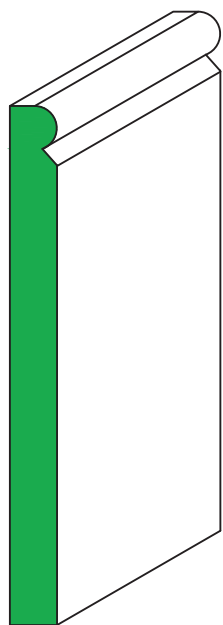

M2780
 $\frac{1}{2} \times 5\frac{1}{2}$

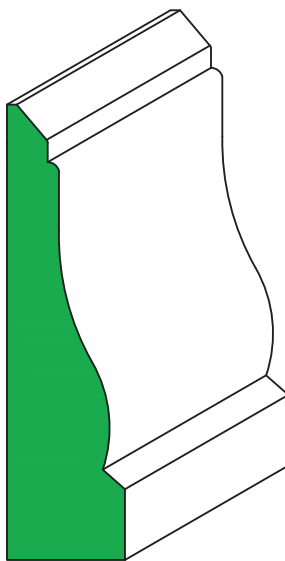

M2784
 $1\frac{1}{4} \times 4\frac{13}{16}$

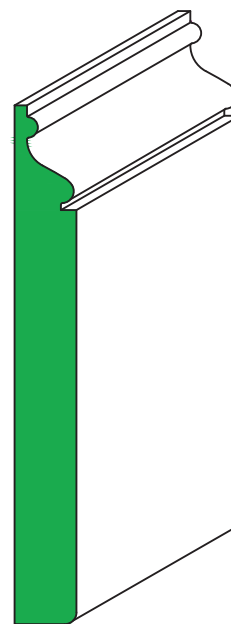

M2788
 $\frac{5}{8} \times 5\frac{1}{2}$

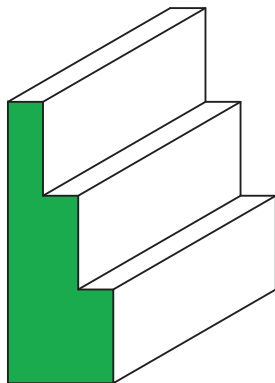

M2794
1 1/8 x 3"

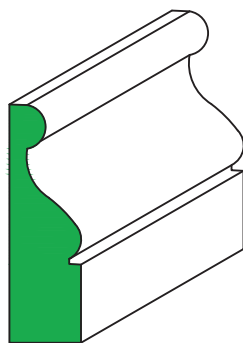

M2796
3/4 x 2 9/16"

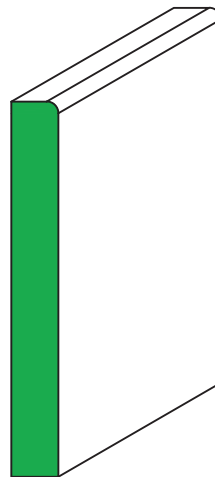

M2798
1/2 x 4"

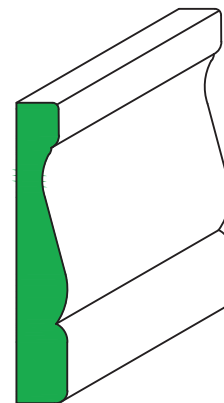

M2800
9/16 x 3 1/4"

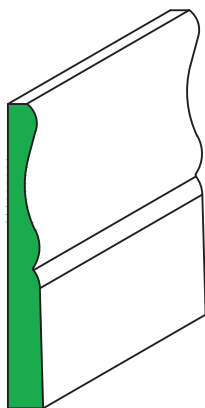

M2802
3/8 x 3 1/4"

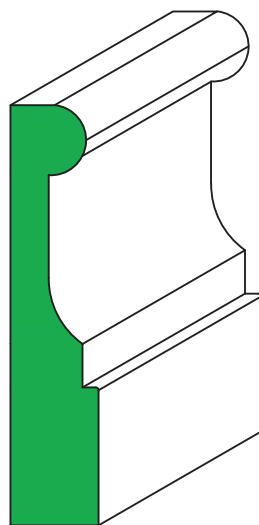

M2804
15/16 x 4 1/2"

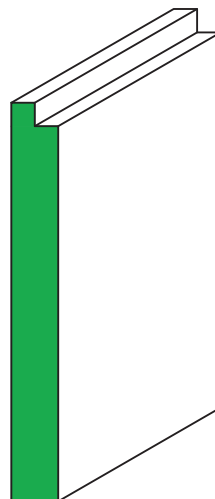

M2806
1/2 x 4 1/4"

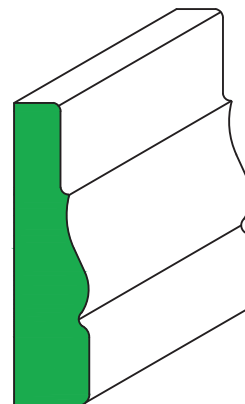

M2808
13/16 x 3 1/4"

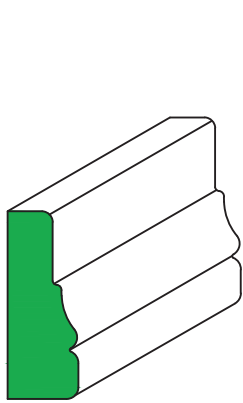

M2810
 $\frac{3}{4} \times 2"$

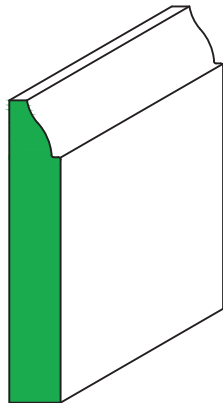

M2812
 $\frac{9}{16} \times 3\frac{1}{4}$

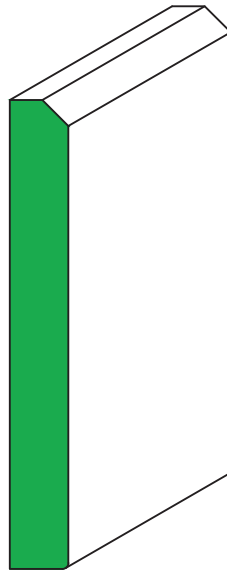

M2823
 $\frac{5}{8} \times 5"$

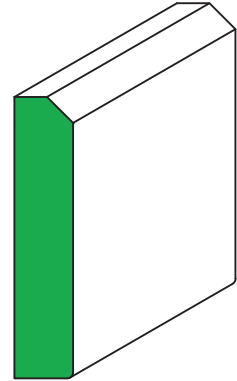

M2824
 $\frac{5}{8} \times 3"$

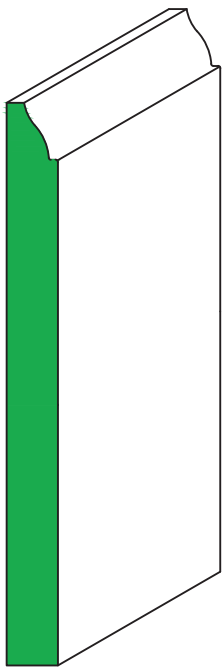

M2814
 $\frac{9}{16} \times 6"$

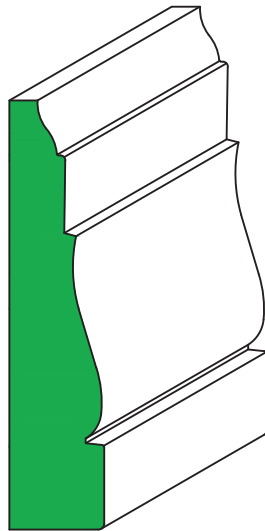

M2818
 $1" \times 4\frac{1}{2}$

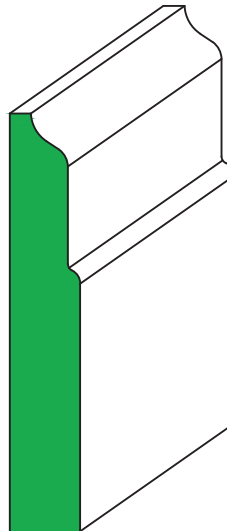

M2820
 $\frac{3}{4} \times 4\frac{1}{2}$

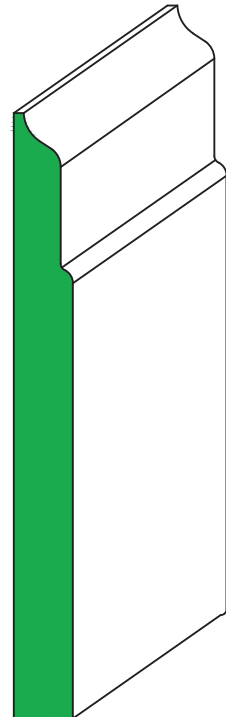

M2822
 $\frac{5}{8} \times 6\frac{1}{2}$

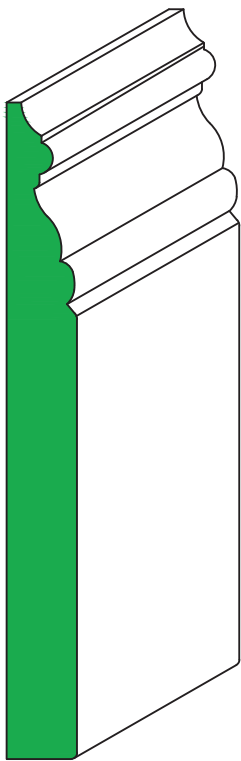

M2825
 $\frac{3}{4}$ x 7"

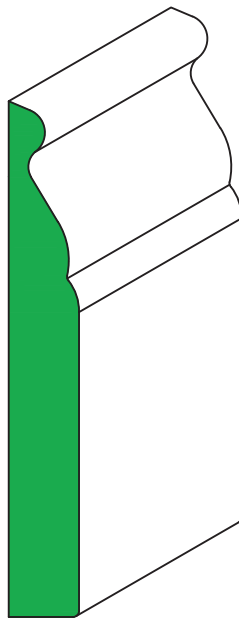

M2026
 $\frac{3}{4}$ x $5\frac{1}{2}$ "

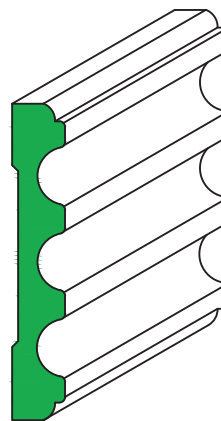

M2010
 $\frac{9}{16}$ x $3\frac{3}{8}$ "

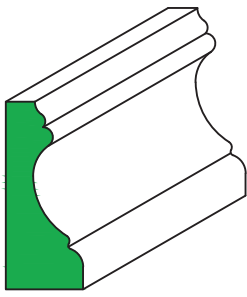

M3000
 $1\frac{3}{16} \times 2"$

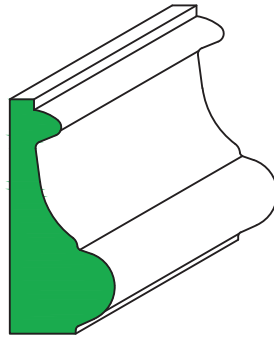

M3005
 $1\frac{1}{8} \times 2\frac{1}{2}"$

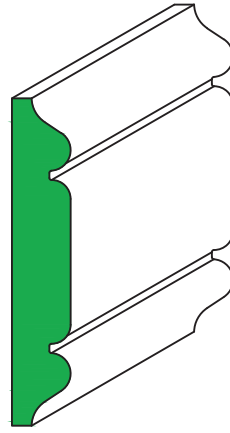

M3010
 $\frac{5}{8} \times 3\frac{1}{2}"$

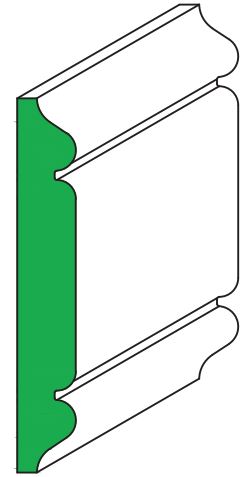

M3012
 $\frac{5}{8} \times 4"$

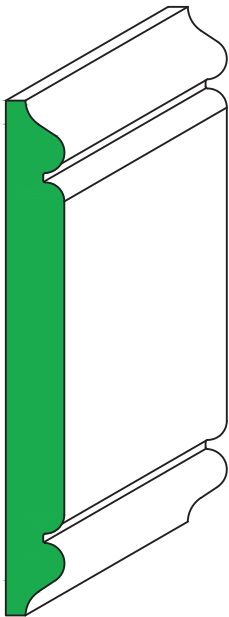

M3015
 $\frac{5}{8} \times 5\frac{1}{2}"$

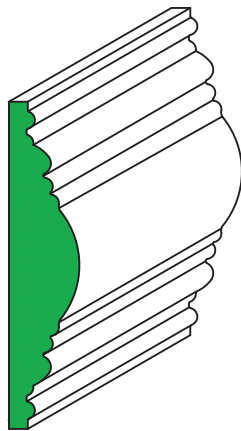

M3020
 $\frac{3}{4} \times 3\frac{1}{2}"$

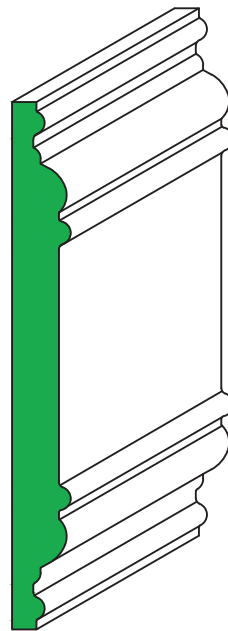

M3025
 $\frac{5}{8} \times 5\frac{5}{8}"$

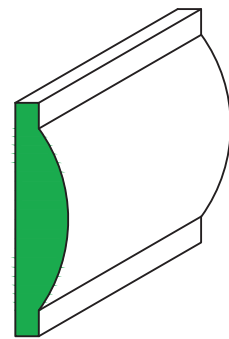

M3030
 $\frac{9}{16} \times 2\frac{1}{2}"$

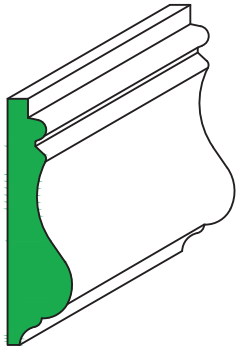

M3035
 $1\frac{1}{16} \times 2\frac{5}{8}$

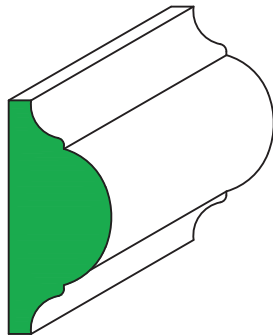

M3040
 $1\frac{1}{16} \times 2\frac{1}{2}$

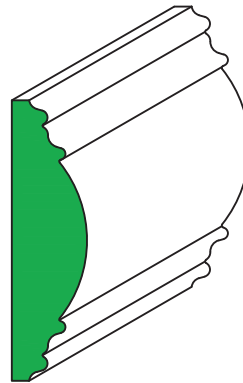

M3045
 $1\frac{3}{16} \times 3"$

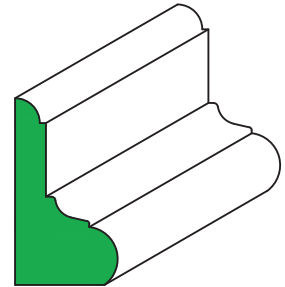

M3050
 $1\frac{1}{16} \times 2"$

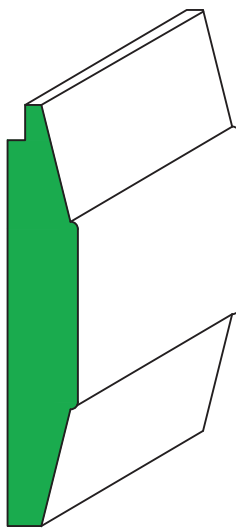

M3102
 $\frac{3}{4} \times 4\frac{1}{2}$

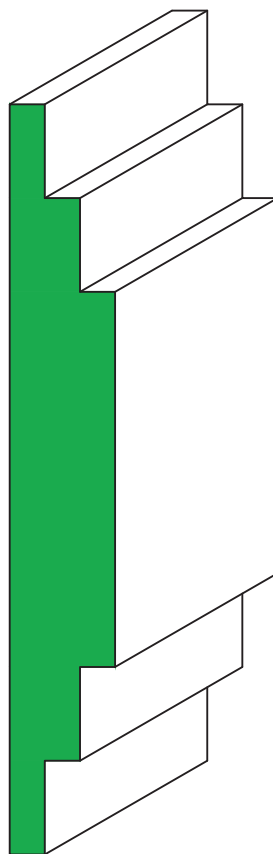

M3104
 $1\frac{1}{8} \times 8"$

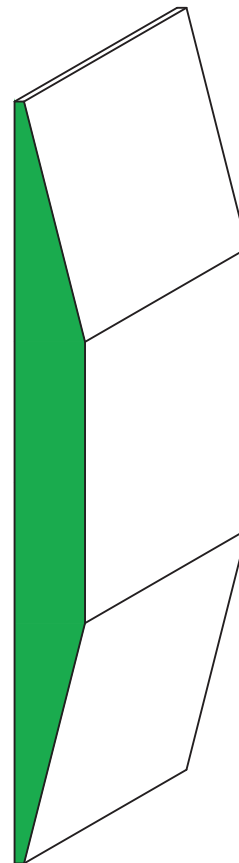

M3106
 $\frac{3}{4} \times 8\frac{1}{8}$

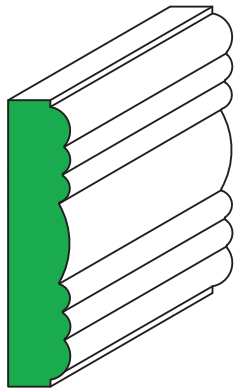

M3108
 $\frac{5}{8} \times 3\frac{1}{16}$

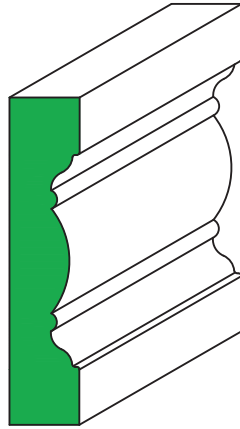

M3110
 $\frac{3}{4} \times 3\frac{1}{2}$

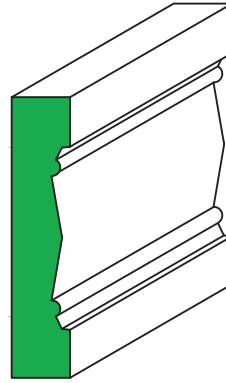

M3114
 $\frac{5}{8} \times 3"$

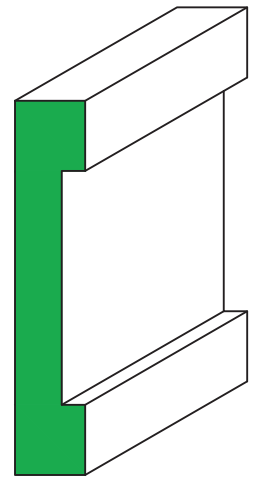

M3120
 $\frac{3}{4} \times 4"$

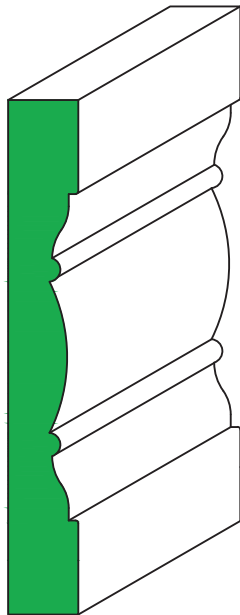

M3112
 $\frac{3}{4} \times 5\frac{1}{2}$

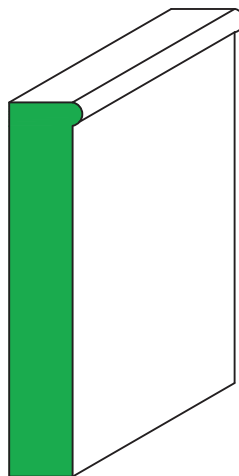

M3116
 $\frac{3}{4} \times 4"$

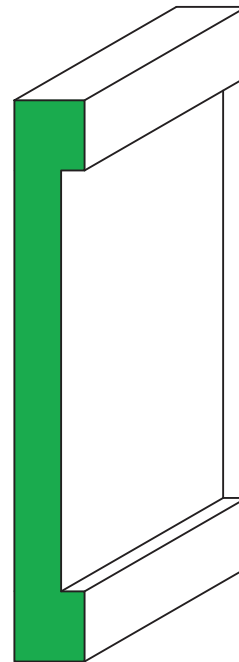

M3118
 $\frac{3}{4} \times 6"$

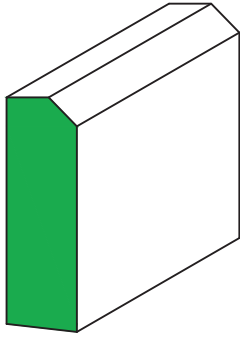

M3122
 $\frac{3}{4} \times 2\frac{1}{2}$

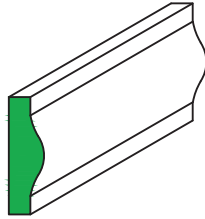

M3124
 $\frac{3}{8} \times 1\frac{1}{4}$

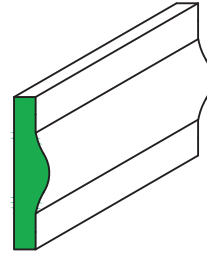

M3126
 $\frac{3}{8} \times 1\frac{5}{8}$

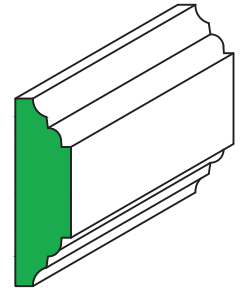

M3134
 $\frac{9}{16} \times 2"$

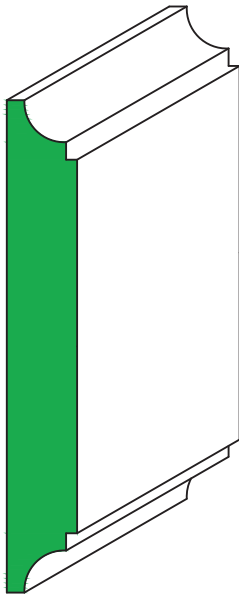

M3128
 $\frac{3}{4} \times 5\frac{1}{4}$

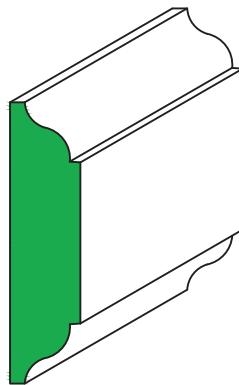

M3130
 $\frac{3}{4} \times 3"$

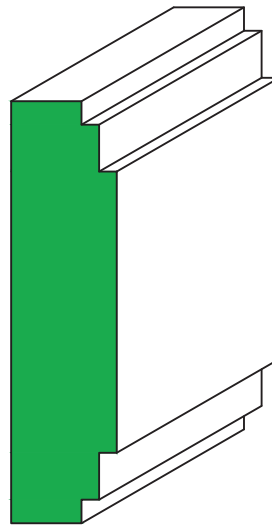

M3132
 $1\frac{1}{8} \times 4\frac{1}{2}$

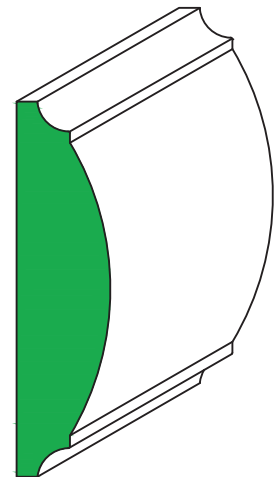

M3136
 $1" \times 4"$

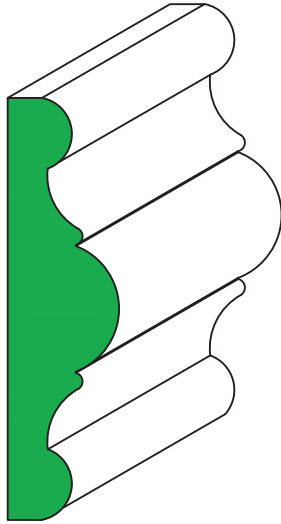

M3138
 $1\frac{3}{16} \times 4\frac{1}{2}$

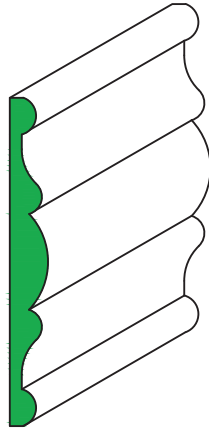

M3140
 $\frac{3}{8} \times 3\frac{1}{2}$

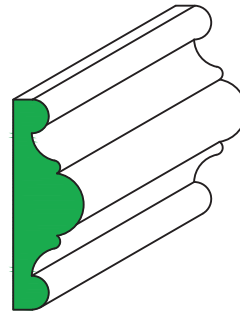

M3142
 $\frac{3}{4} \times 2\frac{1}{4}$

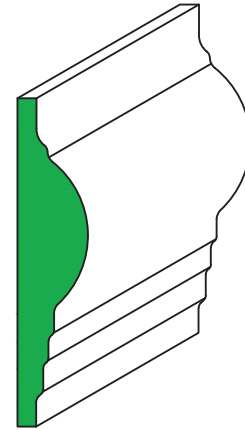

M3144
 $\frac{3}{4} \times 3\frac{1}{2}$

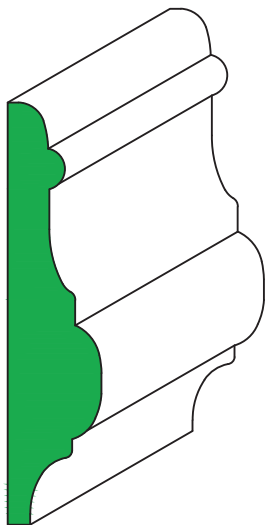

M3146
 $1" \times 4\frac{1}{2}$

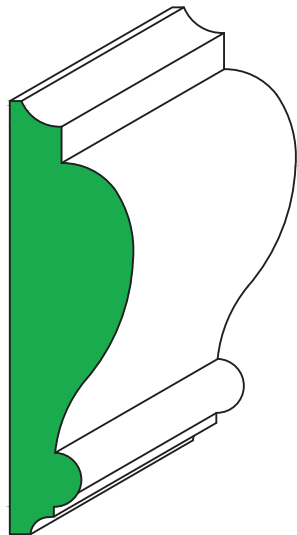

M3148
 $1\frac{5}{16} \times 4\frac{5}{8}$

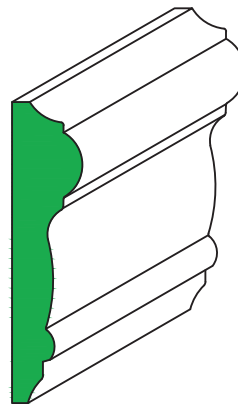

M3150
 $\frac{3}{4} \times 3\frac{3}{16}$

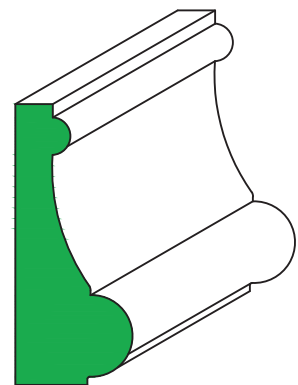

M3152
 $1\frac{1}{4} \times 3"$

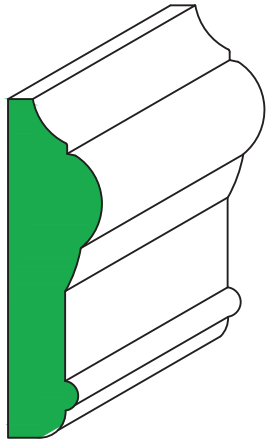

M3152
1" x 3⁵/₈"

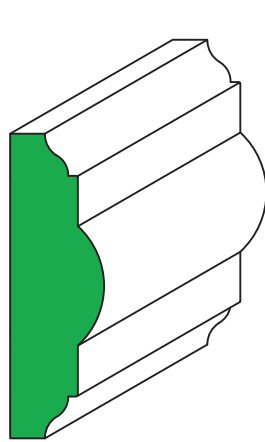

M3156
1" x 3¹/₄"

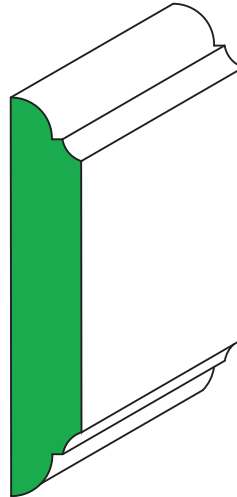

M3158
3³/₄" x 4¹/₄"

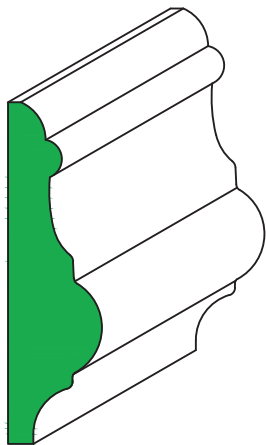

M3162
1" x 3⁵/₈"

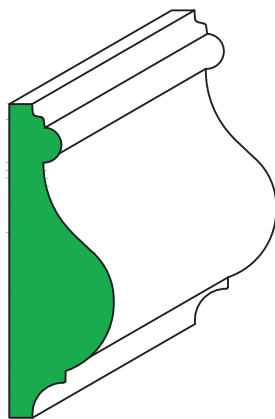

M3164
1¹/₈" x 3³/₈"

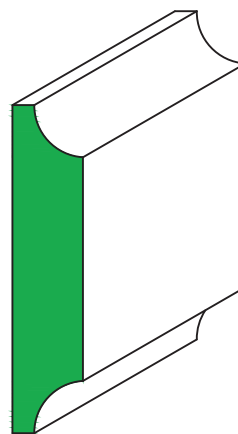

M3166
3³/₄" x 3¹/₂"

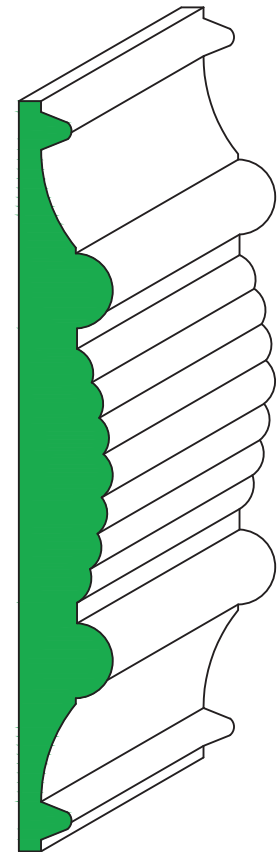

M3160
1" x 8"

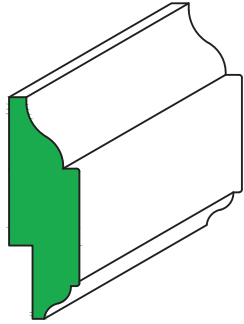

M3168
 $\frac{3}{4} \times 2\frac{3}{8}$

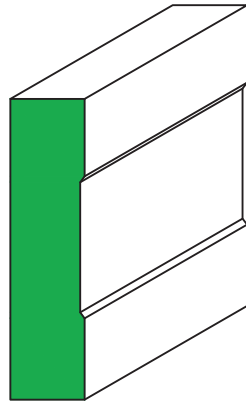

M3170
 $1\frac{3}{16} \times 3\frac{3}{16}$

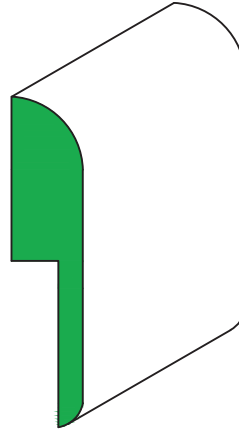

M3172
 $\frac{3}{4} \times 3\frac{1}{2}$

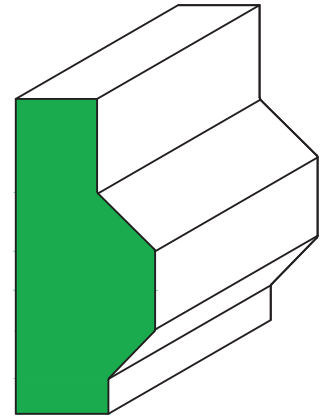

M3174
 $1\frac{1}{2} \times 3\frac{3}{8}$

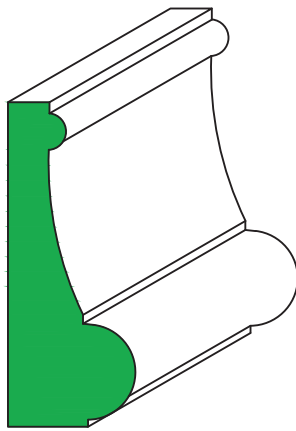

M3176
 $1\frac{3}{8} \times 3\frac{1}{2}$

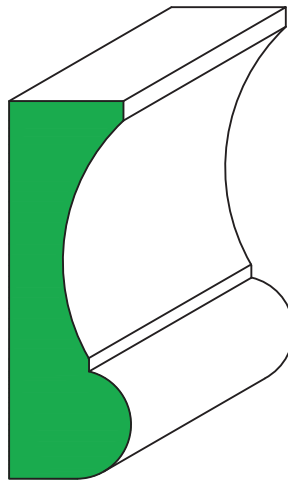

M3178
 $1\frac{5}{16} \times 4"$

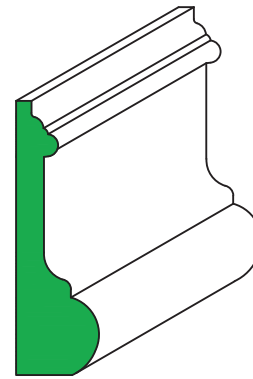

M3180
 $\frac{7}{8} \times 3"$

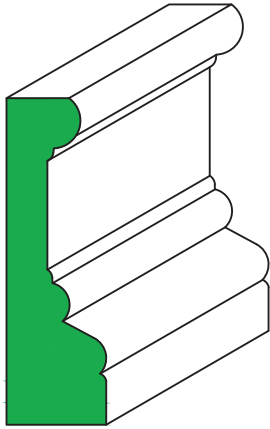

M3182
 $1\frac{1}{16} \times 3\frac{1}{2}$

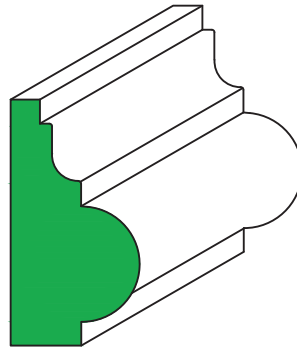

M3184
 $1\frac{3}{8} \times 2\frac{5}{8}$

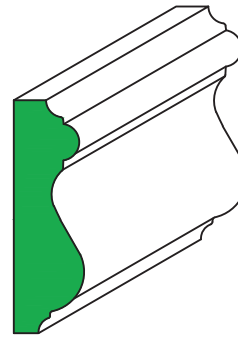

M3186
 $\frac{3}{4} \times 2\frac{1}{2}$

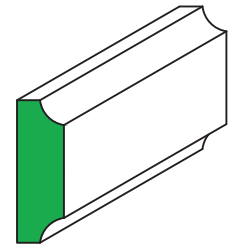

M3196
 $\frac{1}{2} \times 1\frac{1}{2}$

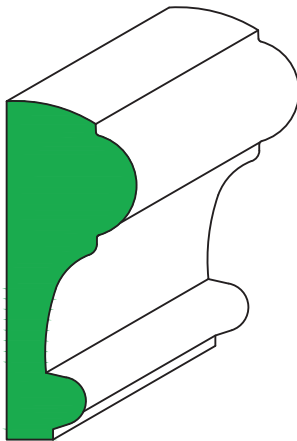

M3188
 $1\frac{3}{8} \times 3\frac{5}{8}$

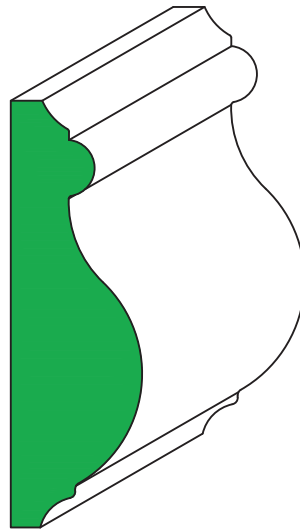

M3190
 $1\frac{3}{8} \times 4\frac{9}{16}$

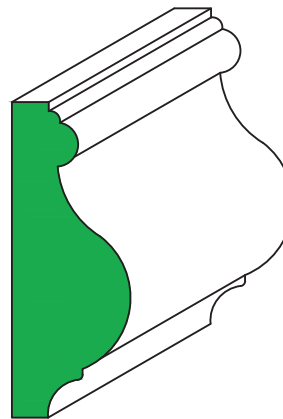

M3192
 $1\frac{1}{4} \times 3\frac{3}{8}$

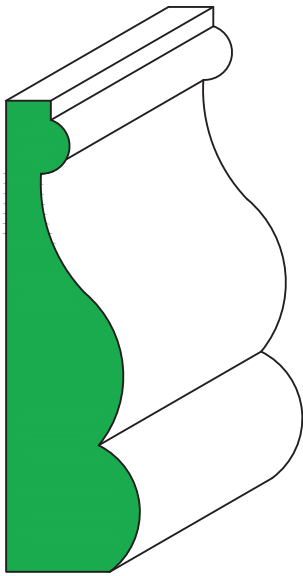

M3194
 $1\frac{7}{16} \times 5"$

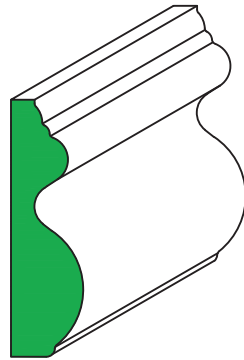

M3200
 $\frac{3}{4} \times 2\frac{3}{4}$

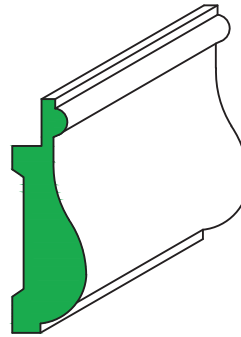

M3400
 $1\frac{3}{16} \times 2\frac{1}{2}$

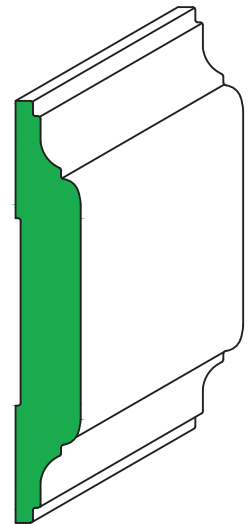

M3415
 $1\frac{1}{16} \times 4\frac{1}{2}$

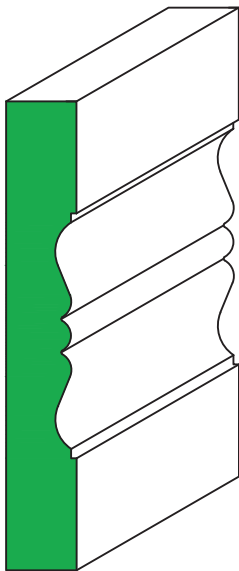

M3198
 $\frac{3}{4} \times 5"$

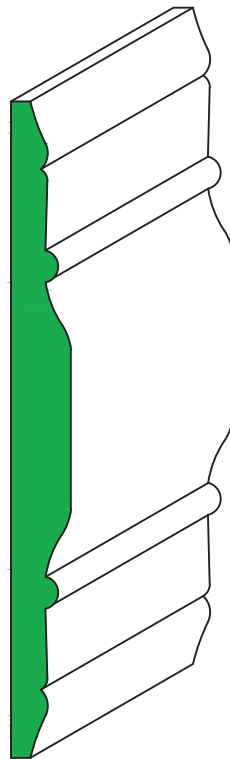

M3330
 $\frac{5}{8} \times 7"$

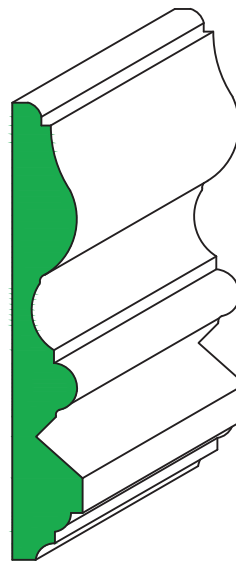

M3405
 $\frac{3}{4} \times 4\frac{7}{8}$

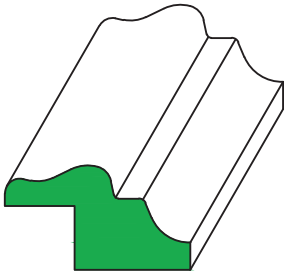

M5000
 $1\frac{1}{8} \times 2"$

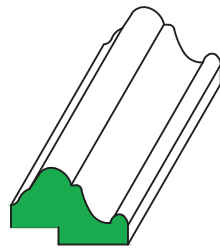

M5005
 $1\frac{3}{16} \times 1\frac{1}{4}$

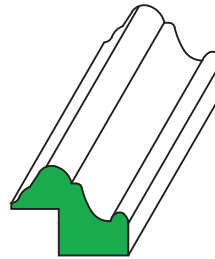

M5010
 $1" \times 1\frac{1}{4}$

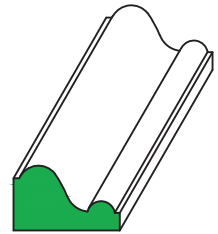

M5012
 $1\frac{1}{16} \times 1\frac{3}{16}$

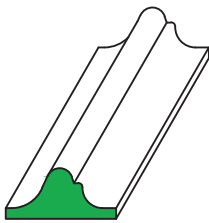

M5045
 $\frac{9}{16} \times 1\frac{3}{16}$

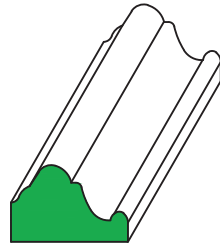

M5050
 $1\frac{3}{16} \times 1\frac{1}{4}$

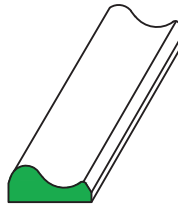

M5055
 $\frac{3}{8} \times \frac{7}{8}$

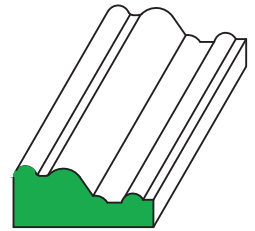

M5065
 $1\frac{1}{16} \times 1\frac{1}{2}$

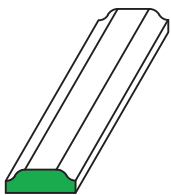

M5070
 $\frac{1}{4} \times \frac{3}{4}$

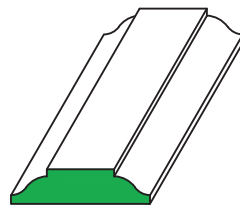

M5075
 $\frac{3}{8} \times 1\frac{1}{2}$

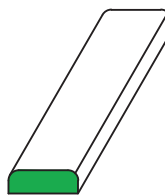

M5080
 $\frac{1}{4} \times \frac{3}{4}$

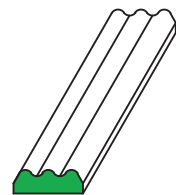

M5085
 $\frac{1}{4} \times \frac{3}{4}$

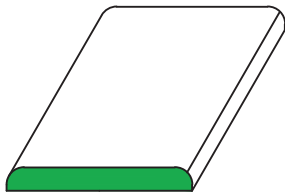

M5086
 $\frac{1}{4} \times 2"$

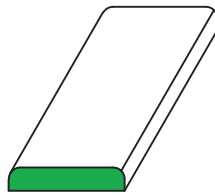

M5087
 $\frac{1}{4} \times 1\frac{1}{4}$

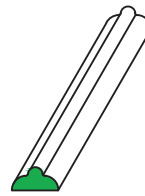

M5090
 $\frac{1}{4} \times \frac{1}{2}$

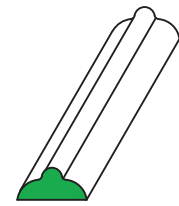

M5095
 $1\frac{1}{32} \times \frac{3}{4}$

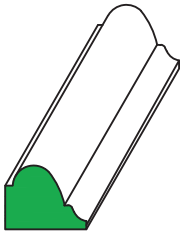

M5150
 $1\frac{1}{16} \times \frac{7}{8}$

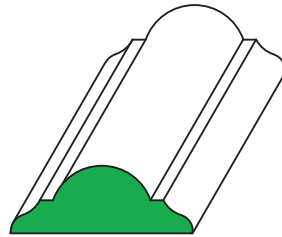

M5152
 $\frac{3}{4} \times 1\frac{15}{16}$

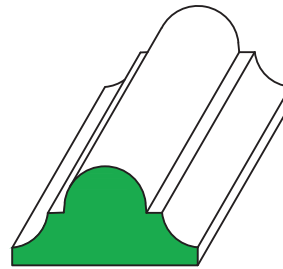

M5154
 $1\frac{1}{16} \times 2"$

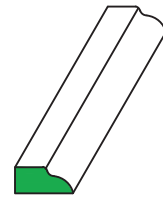

M5156
 $\frac{1}{4} \times \frac{5}{8}$

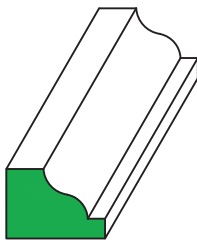

M5158
 $\frac{3}{4} \times 1\frac{1}{16}$

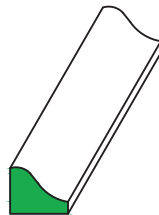

M5160
 $\frac{1}{2} \times \frac{5}{8}$

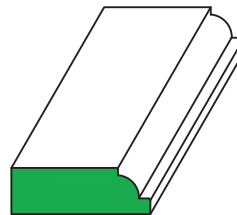

M5162
 $\frac{1}{2} \times 1\frac{1}{2}$

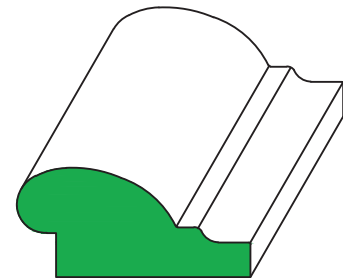

M5164
 $1\frac{3}{16} \times 2\frac{1}{2}$

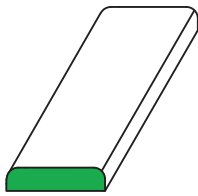

M5166
 $\frac{1}{4} \times 1\frac{1}{16}$

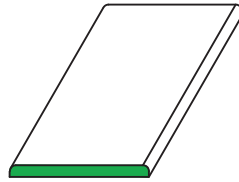

M5168
 $\frac{1}{8} \times 1\frac{1}{2}$

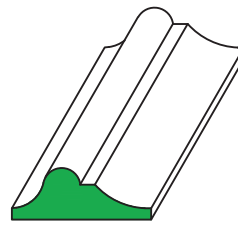

M5170
 $\frac{9}{16} \times 1\frac{1}{2}$

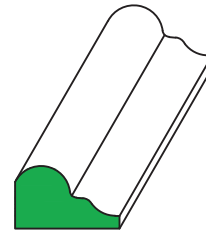

M5172
 $1\frac{1}{16} \times 1\frac{1}{8}$

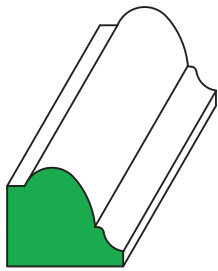

M5174
 $1\frac{1}{16} \times 1\frac{1}{4}$

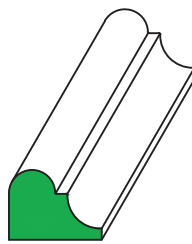

M5176
 $\frac{3}{4} \times 1"$

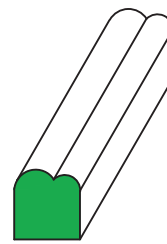

M5178
 $\frac{3}{4} \times 1\frac{1}{16}$

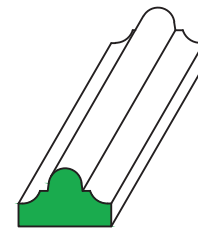

M5180
 $\frac{5}{8} \times 1"$

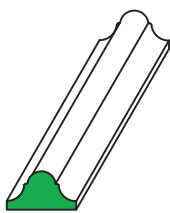

M5182
 $1\frac{3}{32} \times \frac{3}{4}$

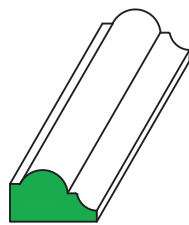

M5184
 $\frac{9}{16} \times 1\frac{5}{16}$

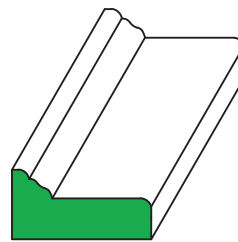

M5186
 $\frac{3}{4} \times 1\frac{1}{2}$

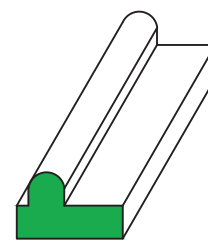

M5188
 $1\frac{1}{16} \times 1\frac{1}{8}$

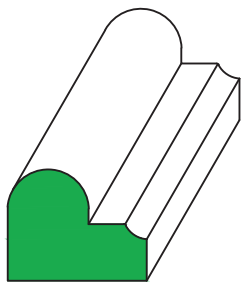

M5190
 $1\frac{3}{16} \times 1\frac{1}{2}$

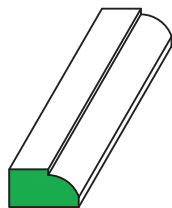

M5192
 $\frac{3}{8} \times \frac{3}{4}$

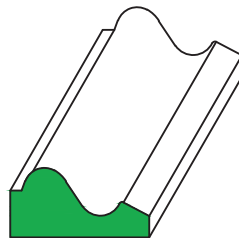

M5194
 $\frac{3}{4} \times 1\frac{1}{2}$

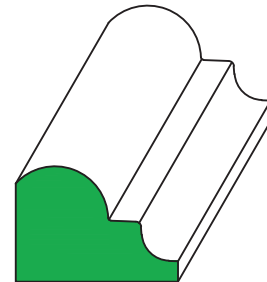

M5196
 $1\frac{1}{4} \times 1\frac{3}{4}$

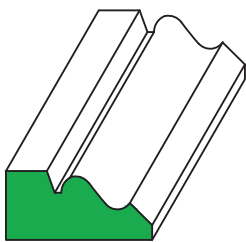

M5198
 $\frac{3}{4} \times 1\frac{9}{16}$

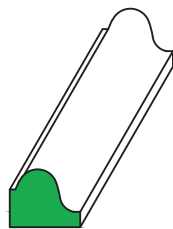

M5200
 $\frac{5}{8} \times \frac{3}{4}$

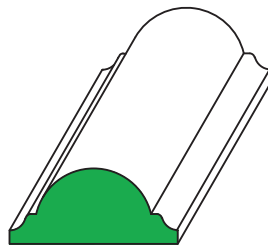

M5202
 $1\frac{3}{16} \times 1\frac{13}{16}$

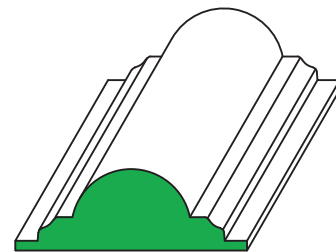

M5204
 $\frac{7}{8} \times 2\frac{1}{2}$

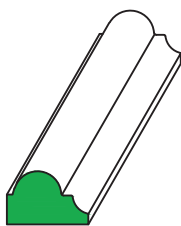

M5206
 $\frac{9}{16} \times \frac{7}{8}$

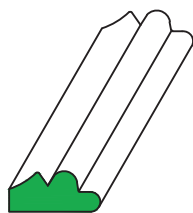

M5208
 $\frac{7}{16} \times 1"$

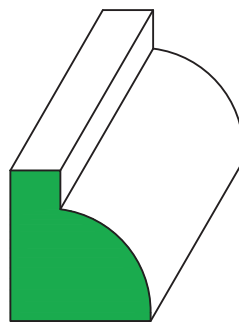

M5210
 $1\frac{5}{8} \times 1\frac{1}{2}$

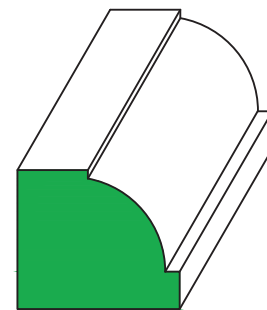

M5212
 $1\frac{1}{2} \times 1\frac{3}{4}$

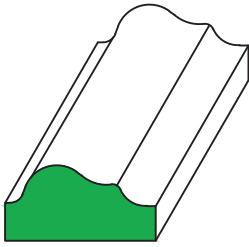

M5214
 $1\frac{3}{16} \times 1\frac{5}{8}$

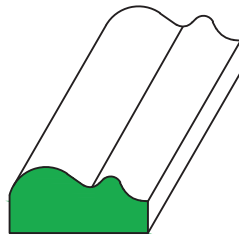

M5216
 $1\frac{1}{16} \times 1\frac{1}{2}$

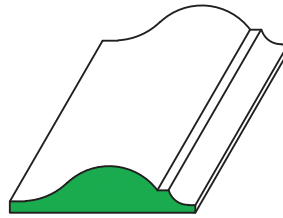

M5218
 $\frac{1}{2} \times 2"$

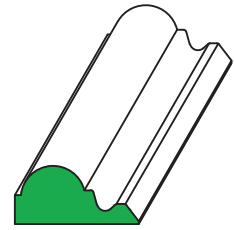

M5220
 $\frac{5}{8} \times 1\frac{5}{16}$

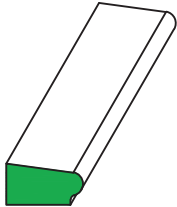

M5222
 $\frac{7}{16} \times 1\frac{3}{16}$

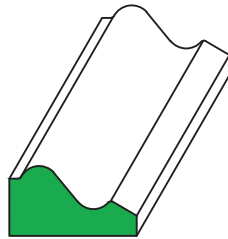

M5224
 $\frac{3}{4} \times 1\frac{3}{8}$

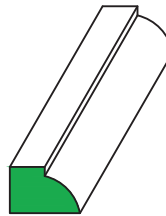

M5226
 $\frac{1}{2} \times \frac{3}{4}$

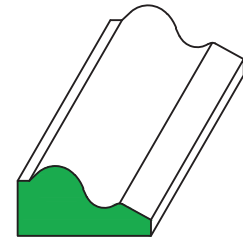

M5228
 $\frac{3}{4} \times 1\frac{7}{16}$

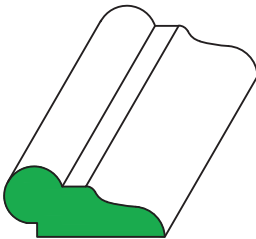

M5230
 $\frac{3}{4} \times 1\frac{3}{4}$

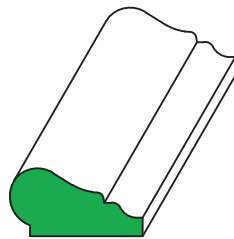

M5232
 $\frac{3}{4} \times 1\frac{7}{16}$

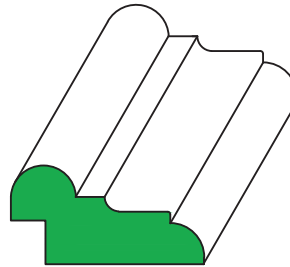

M5234
 $1\frac{1}{16} \times 2\frac{1}{16}$

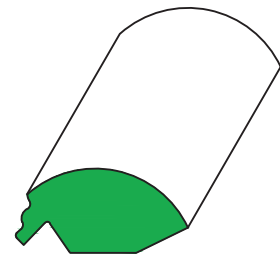

M5236
 $1\frac{15}{16} \times 1\frac{7}{8}$

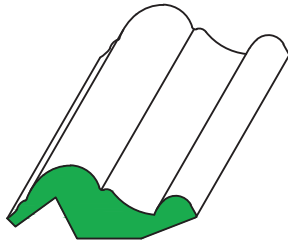

M5238
 $1\frac{3}{16} \times 2\frac{1}{16}$

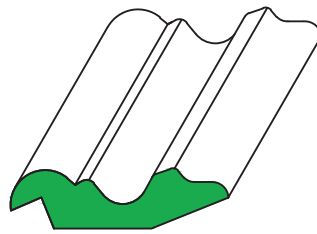

M5240
 $\frac{5}{8} \times 2\frac{5}{16}$

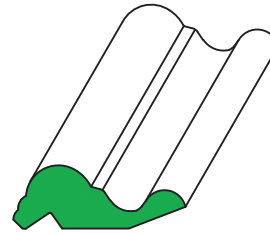

M5242
 $1\frac{1}{16} \times 1\frac{7}{8}$

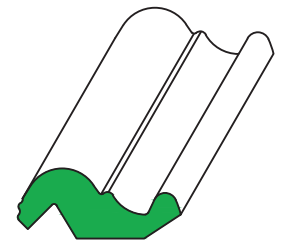

M5244
 $\frac{3}{4} \times 1\frac{3}{4}$

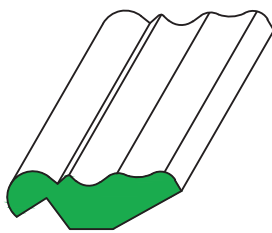

M5246
 $\frac{5}{8} \times 1\frac{7}{8}$

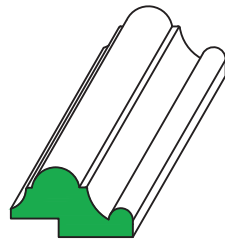

M5248
 $\frac{3}{4} \times 1\frac{5}{16}$

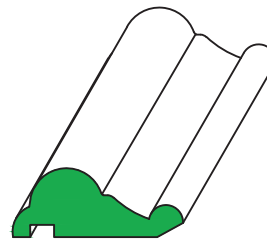

M5250
 $\frac{3}{4} \times 1\frac{13}{16}$

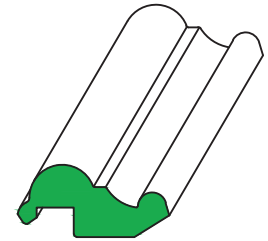

M5252
 $\frac{3}{4} \times 1\frac{5}{8}$

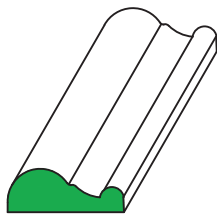

M5254
 $\frac{7}{16} \times 1\frac{1}{4}$

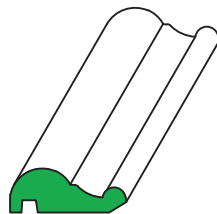

M5256
 $\frac{1}{2} \times 1\frac{1}{4}$

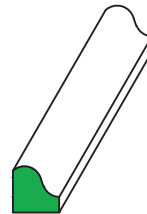

M5258
 $\frac{1}{2} \times \frac{1}{2}$

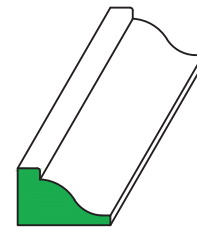

M5260
 $\frac{5}{8} \times 1"$

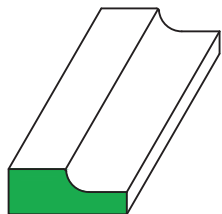

M5262
 $\frac{1}{2} \times \frac{1}{4}$

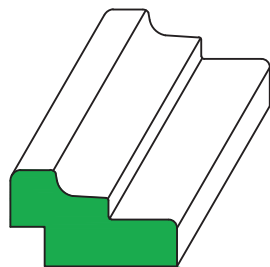

M5264
 $\frac{1}{16} \times 1\frac{13}{16}$

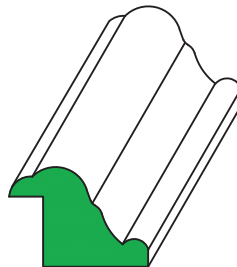

M5266
 $\frac{1}{16} \times 1\frac{1}{2}$

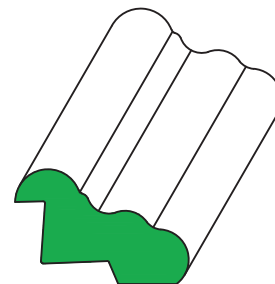

M5268
 $\frac{1}{4} \times 1\frac{7}{8}$

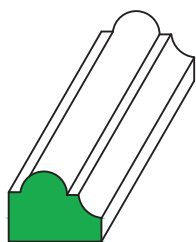

M5305
 $\frac{3}{4} \times 1"$

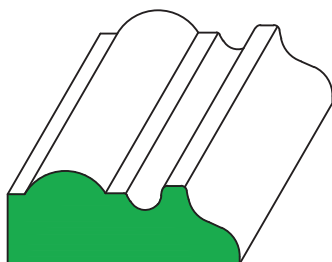

M5310
 $1" \times 2\frac{1}{2}$

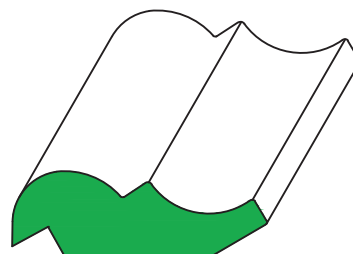

M5315
 $\frac{15}{16} \times 2\frac{3}{4}$

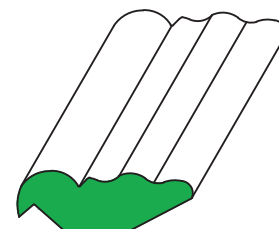

M5350
 $\frac{1}{16} \times 1\frac{7}{8}$

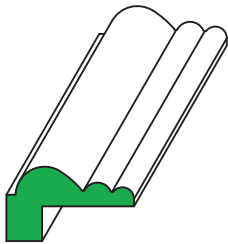

M6000
 $1\frac{3}{16} \times 1\frac{3}{8}$

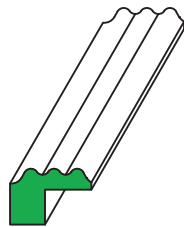

M6005
 $\frac{5}{8} \times \frac{7}{8}$

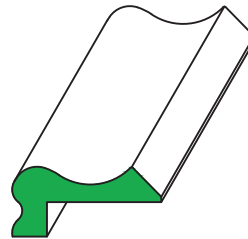

M6010
 $\frac{3}{4} \times 1\frac{5}{8}$

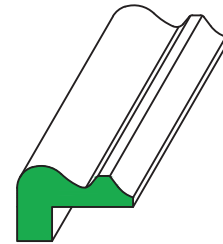

M6015
 $1\frac{3}{16} \times 1\frac{1}{4}$

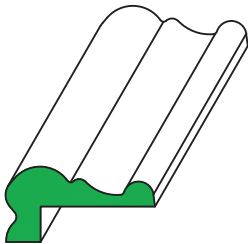

M6020
 $1\frac{3}{16} \times 1\frac{5}{8}$

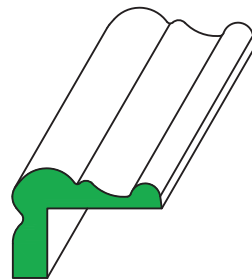

M6025
 $1\frac{3}{16} \times 1\frac{5}{8}$

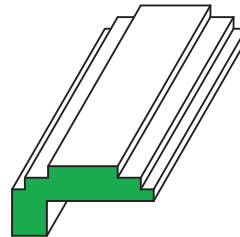

M6030
 $\frac{3}{4} \times 1\frac{1}{2}$

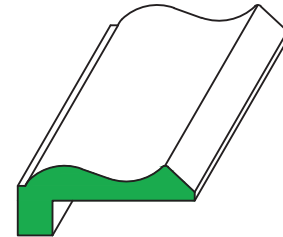

M6035
 $\frac{3}{4} \times 1\frac{7}{8}$

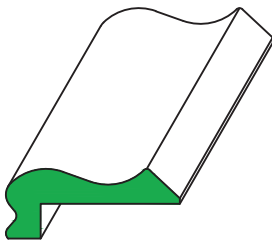

M6040
 $\frac{3}{4} \times 1\frac{7}{8}$

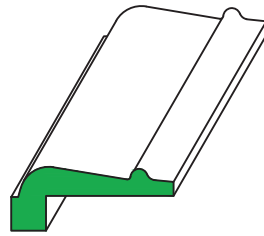

M6045
 $1\frac{1}{16} \times 1\frac{3}{4}$

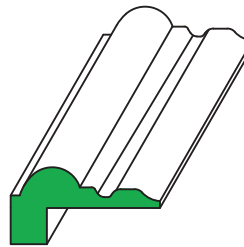

M6050
 $1\frac{3}{16} \times 1\frac{5}{8}$

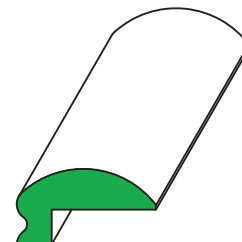

M6055
 $1\frac{3}{16} \times 1\frac{1}{2}$

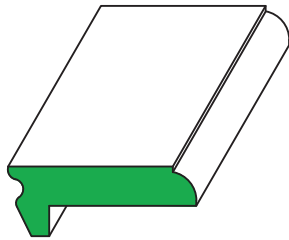

M6060
 $\frac{3}{4} \times 2''$

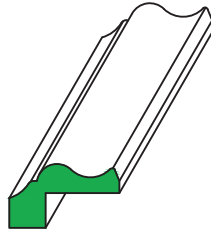

M6065
 $1\frac{1}{16} \times 1\frac{3}{16}$

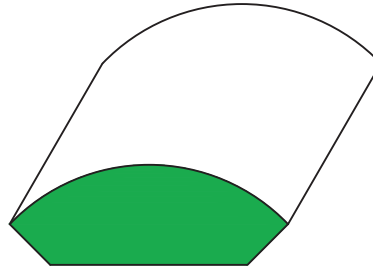

M6150
 $1\frac{1}{16} \times 3''$

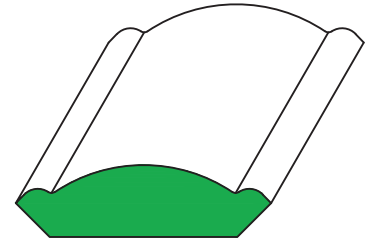

M6154
 $\frac{3}{4} \times 2\frac{3}{4}$

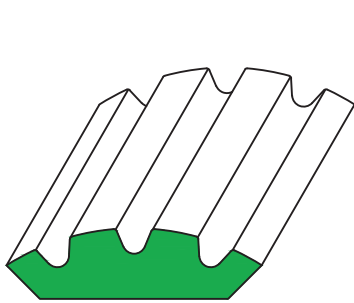

M6156
 $\frac{3}{4} \times 2\frac{3}{4}$

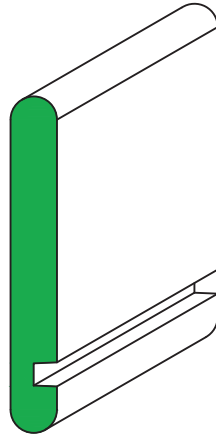

M6200
 $\frac{1}{2} \times 3\frac{5}{8}$

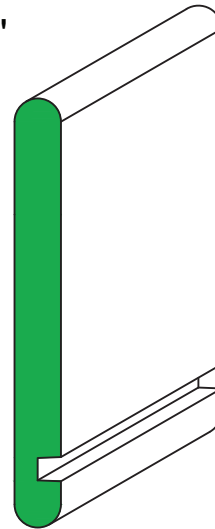

M6205
 $\frac{1}{2} \times 4\frac{5}{8}$

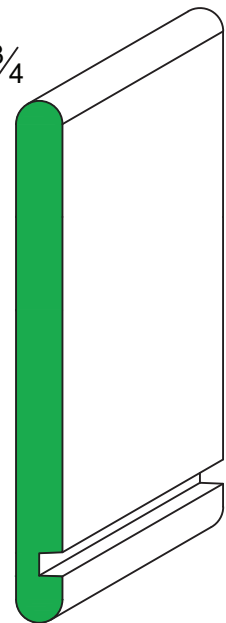

M6210
 $\frac{1}{2} \times 5\frac{5}{8}$

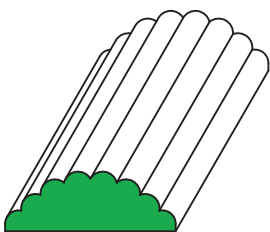

M6220
 $\frac{5}{8} \times 1\frac{13}{16}$

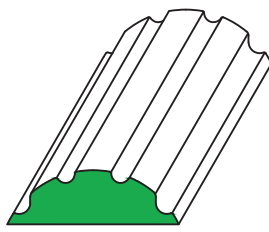

M6225
 $\frac{9}{16} \times 1\frac{7}{8}$

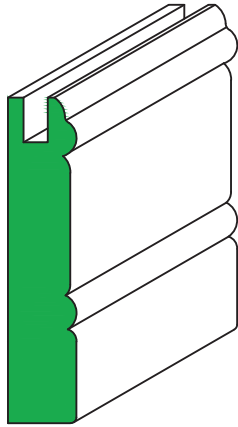

M6270
 $\frac{3}{4} \times 3\frac{1}{2}$

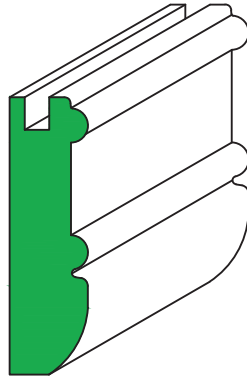

M6272
 $1\frac{3}{16} \times 3"$

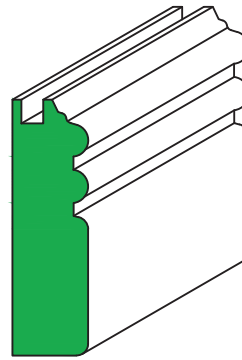

M6274
 $1\frac{3}{16} \times 2\frac{3}{4}$

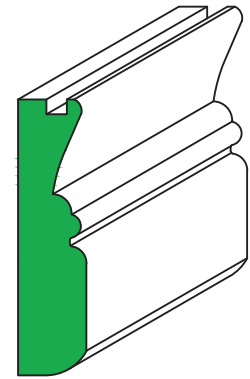

M6276
 $\frac{3}{4} \times 3"$

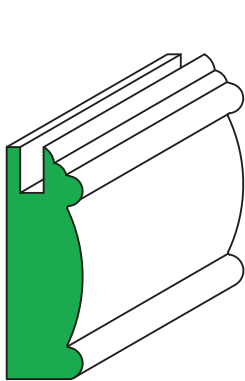

M6278
 $1\frac{3}{16} \times 2\frac{1}{2}$

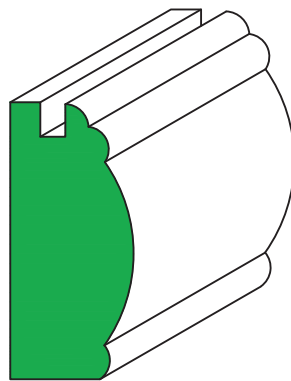

M6280
 $1\frac{5}{16} \times 3"$

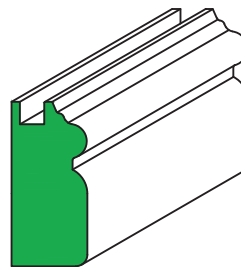

M6282
 $1\frac{3}{16} \times 1\frac{3}{4}$

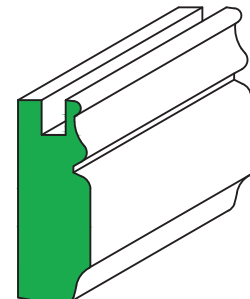

M6284
 $2\frac{5}{32} \times 2\frac{7}{32}$

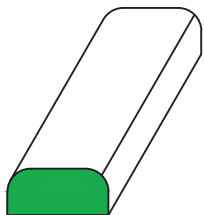

M6300
 $\frac{1}{2} \times 1\frac{1}{8}$

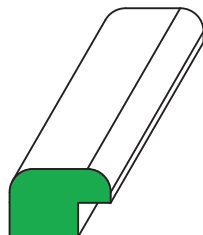

M6305
 $\frac{3}{4} \times 1\frac{1}{8}$

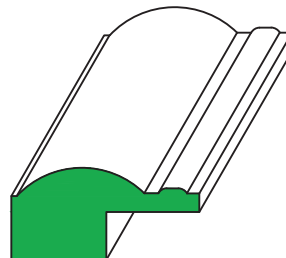

M6324
 $1" \times 2"$

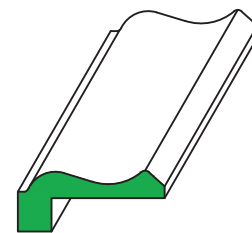

M6326
 $\frac{5}{8} \times 1\frac{9}{16}$

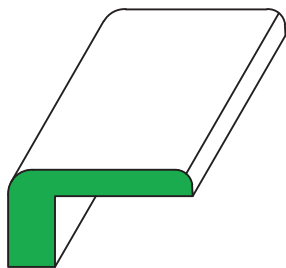

M6312
1¹/₁₆ x 2"

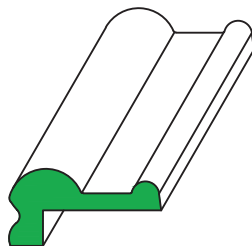

M6314
1³/₁₆ x 1⁵/₈

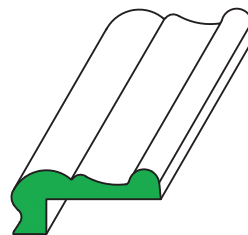

M6316
1¹/₁₆ x 1⁵/₈

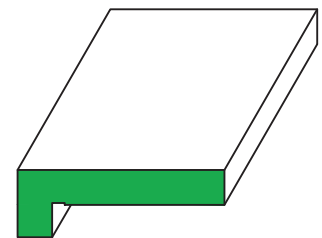

M6318
3/4 x 2¹/₄

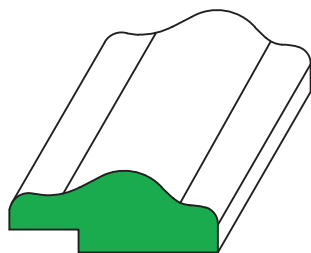

M6320
7/8 x 2¹/₄

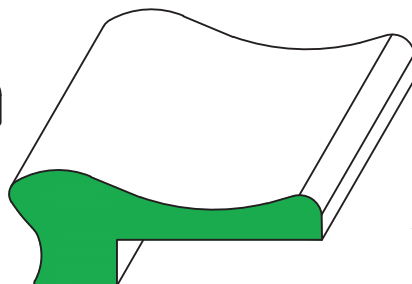

M6322
1¹/₄ x 3³/₈

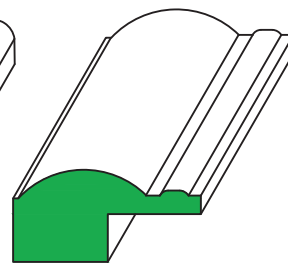

M6324
1" x 2"

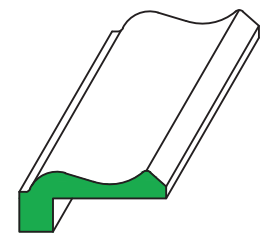

M6326
5/8 x 1⁹/₁₆

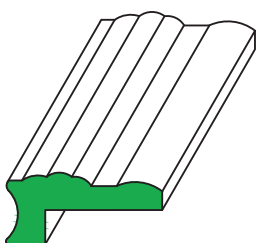

M6328
3/4 x 1¹¹/₁₆

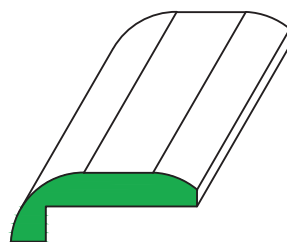

M6330
3/4 x 2"

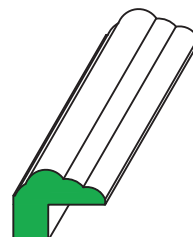

M6332
3/4 x 1"

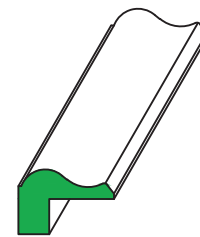

M6334
1¹/₁₆ x 1¹/₁₆

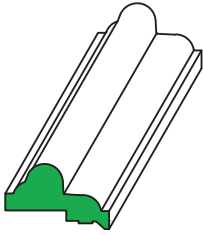

M6336
 $1\frac{1}{16} \times 1\frac{1}{8}$

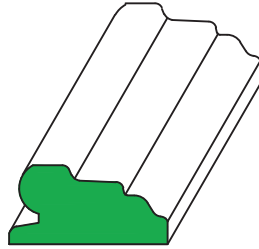

M6338
 $\frac{7}{8} \times 1\frac{11}{16}$

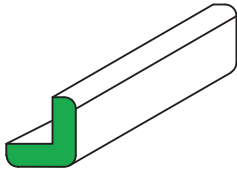

M7000
 $\frac{3}{4} \times \frac{3}{4}$

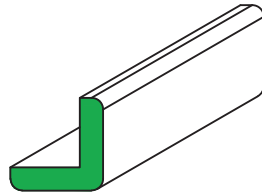

M7005
1" x 1"

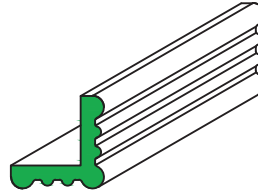

M7010
1" x 1"

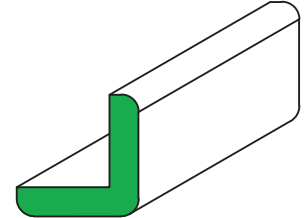

M7015
 $1\frac{5}{16} \times 1\frac{5}{16}$

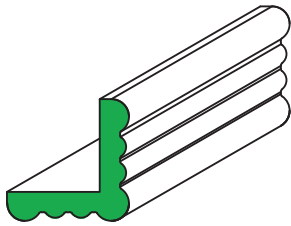

M7020
 $1\frac{5}{16} \times 1\frac{5}{16}$

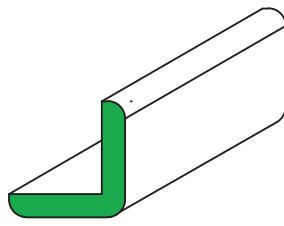

M7023
 $1\frac{1}{4} \times 1\frac{1}{4}$

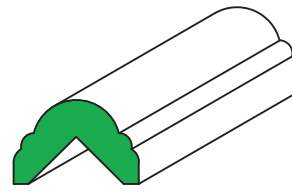

M7025
 $\frac{7}{8} \times 1\frac{3}{8}$

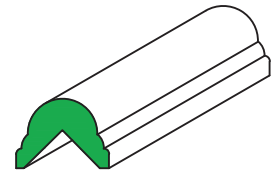

M7030
 $\frac{3}{4} \times 1"$

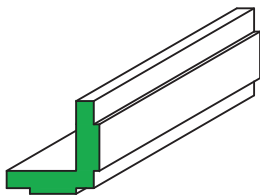

M7035
1" x 1"

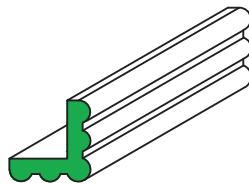

M7037
 $\frac{7}{8} \times \frac{7}{8}$

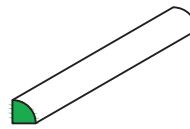

M7040
 $\frac{1}{4} \times \frac{1}{4}$

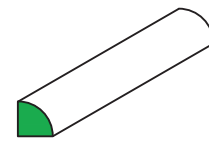

M7045
 $\frac{3}{8} \times \frac{3}{8}$

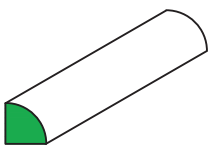

M7047
 $\frac{7}{16} \times \frac{7}{16}$

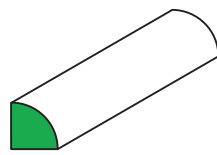

M7050
 $\frac{1}{2} \times \frac{1}{2}$

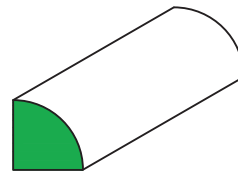

M7055
 $\frac{3}{4} \times \frac{3}{4}$

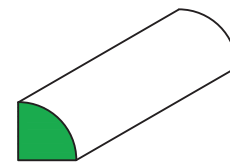

M7057
 $\frac{5}{8} \times \frac{5}{8}$

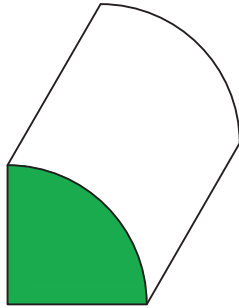

M7060
1½ x 1½

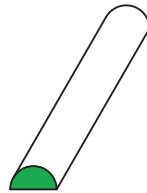

M7065
¼ x ½

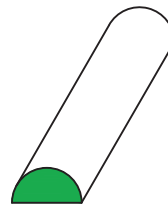

M7070
⅜ x ¾

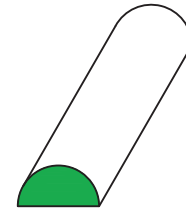

M7072
⅞ x ⅞

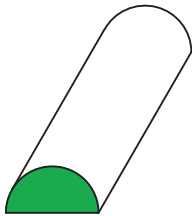

M7075
½ x 1"

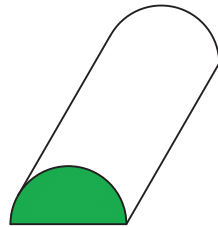

M7078
⅝ x 1¼

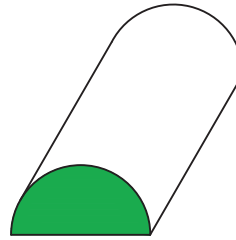

M7080
¾ x 1½

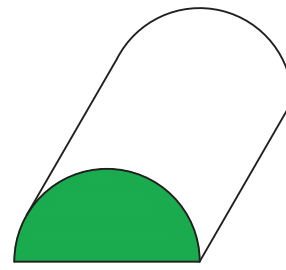

M7082
1" x 2"

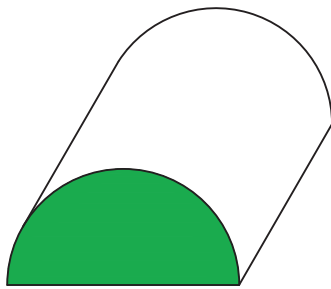

M7083
1¼ x 2½

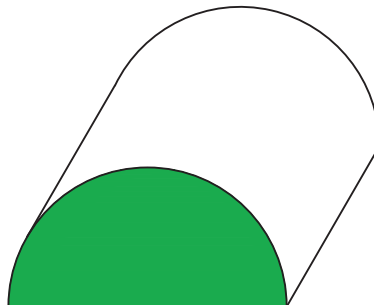

M7085
1½ x 3"

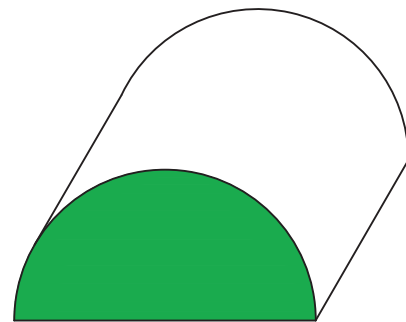

M7086
1⅝ x 3¼

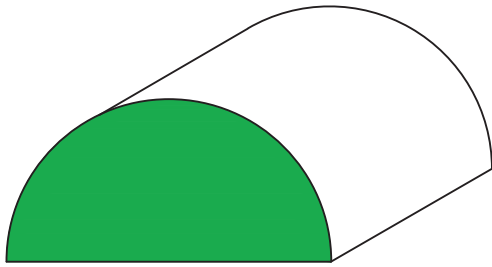

M7087
1 3/4 x 3 1/2

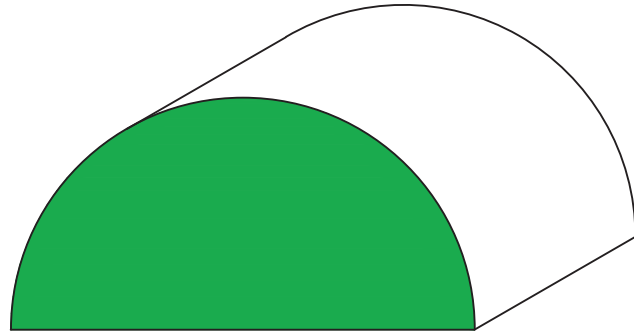

M7088
2 1/2 x 5"

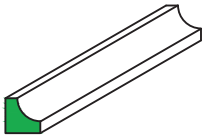

M7090
3/8 x 3/8

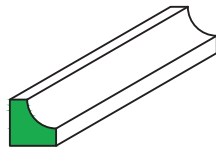

M7095
1/2 x 1/2

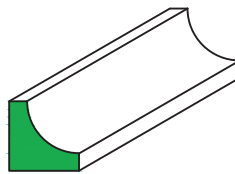

M7100
3/4 x 3/4

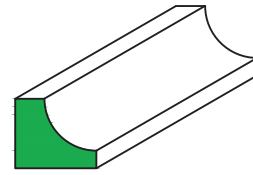

M7105
3/4 x 7/8

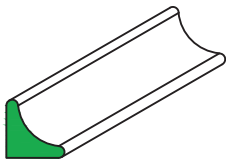

M7107
5/8 x 5/8

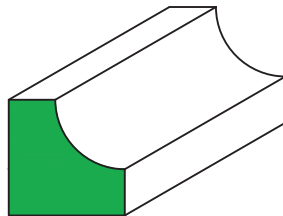

M7108
1 1/4 x 1 1/4

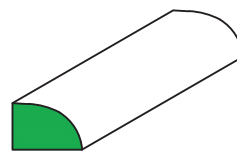

M7110
1/2 x 3/4

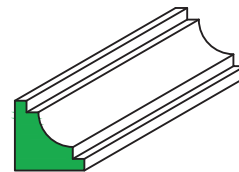

M7120
3/4 x 3/4

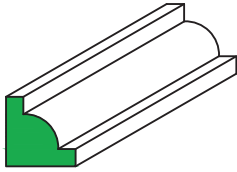

M7125
 $\frac{3}{4} \times \frac{3}{4}$

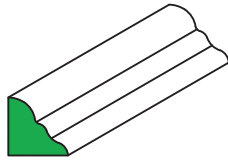

M7130
 $\frac{5}{8} \times \frac{5}{8}$

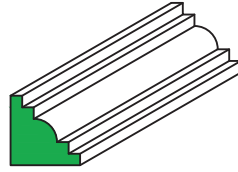

M7300
 $\frac{3}{4} \times \frac{3}{4}$

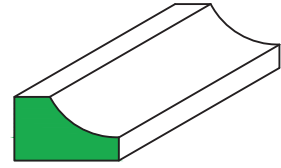

M7310
 $\frac{11}{16} \times \frac{11}{8}$

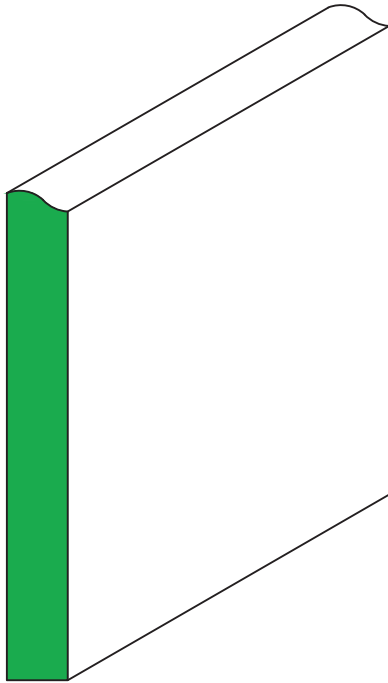

M8000
 $\frac{5}{8} \times 5\frac{1}{4}$

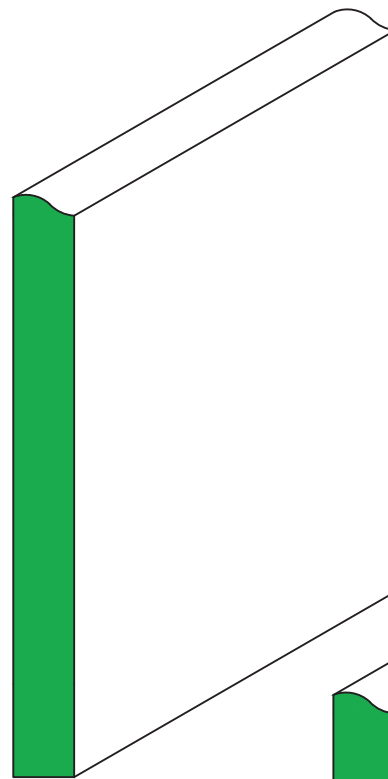

M8005
 $\frac{5}{8} \times 6\frac{1}{4}$

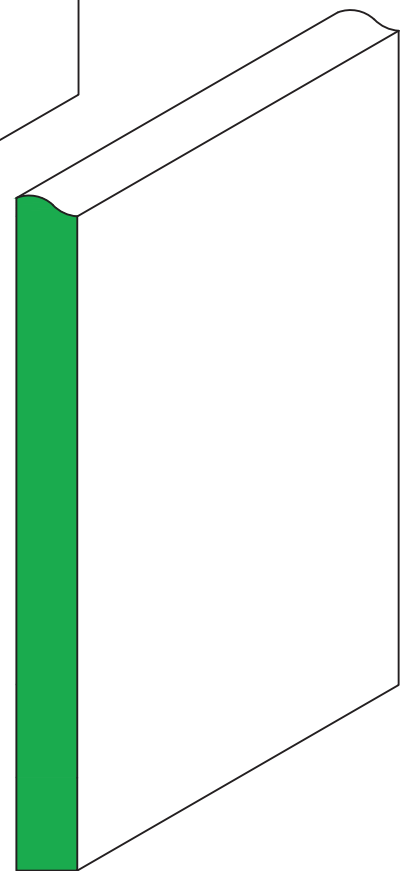

M8010
 $\frac{5}{8} \times 7\frac{1}{4}$

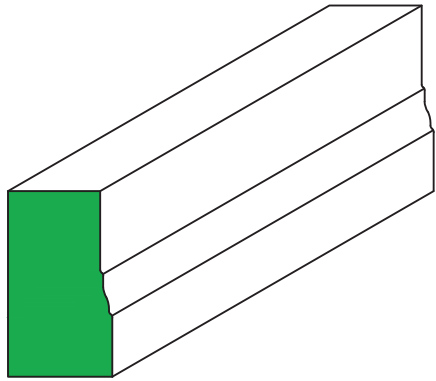

M8015
 $1\frac{1}{8}$ x 2"

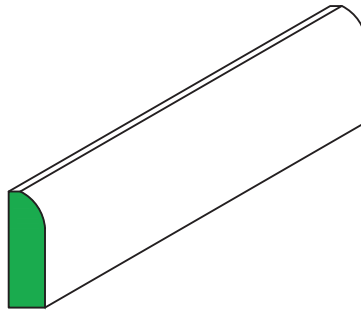

M8020
 $\frac{3}{8}$ x $1\frac{1}{4}$ "

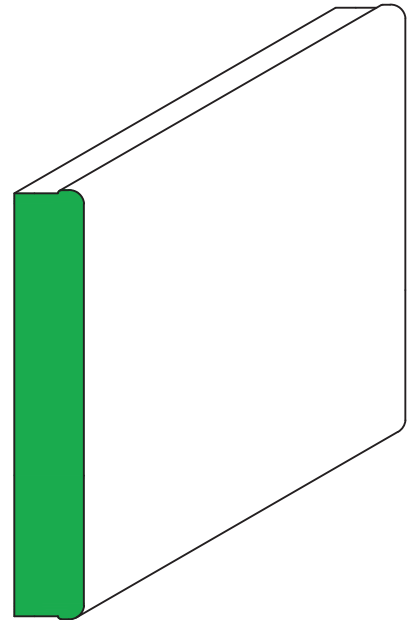

M8025
 $\frac{3}{4}$ x up to 12" wide

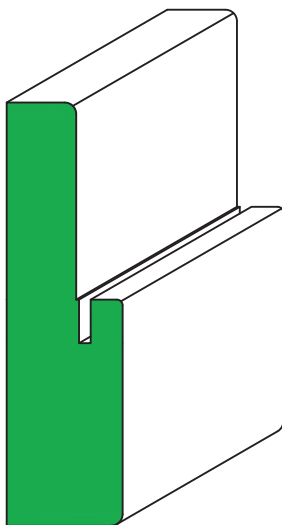

M8045
 $1\frac{1}{4}$ x $4\frac{9}{16}$ "

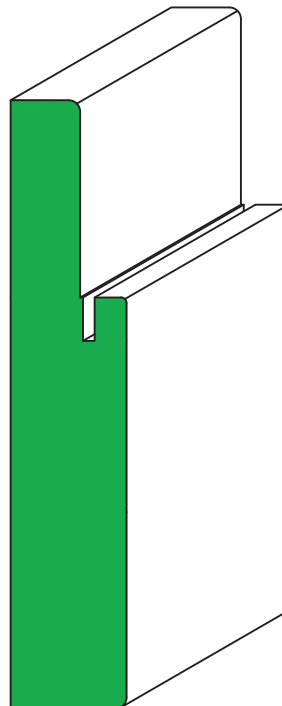

M8050
 $1\frac{1}{4}$ x $6\frac{9}{16}$ "

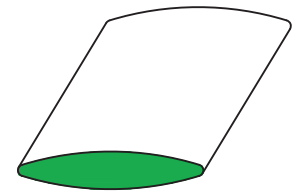

M8070
 $1\frac{3}{32}$ x 2"

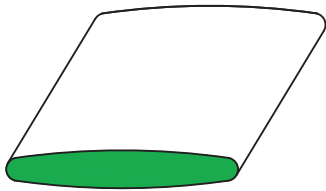

M8075
 $1\frac{3}{32} \times 2\frac{1}{2}$

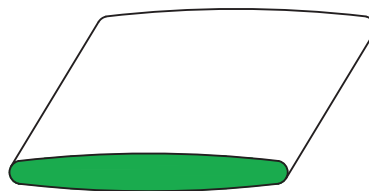

M8080
 $1\frac{3}{32} \times 3$

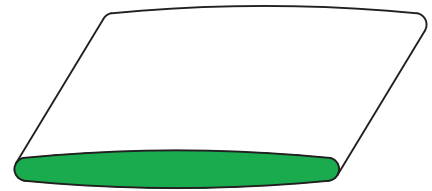

M8085
 $1\frac{3}{32} \times 3\frac{1}{2}$

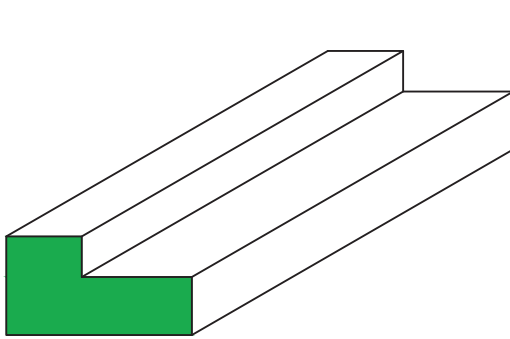

M8090
 $1\frac{1}{16} \times 2$

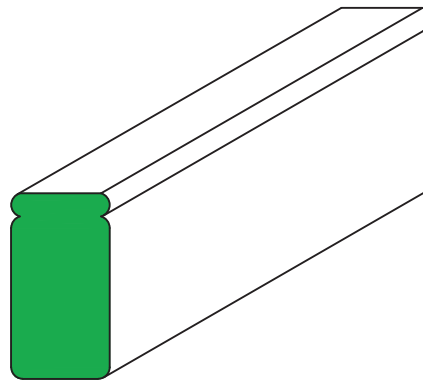

M8095
 $1\frac{1}{16} \times 2$

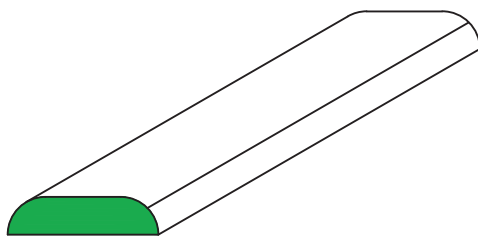

M8100
 $1\frac{3}{32} \times 1\frac{5}{8}$

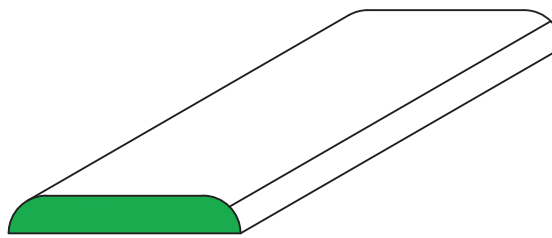

M8105
 $1\frac{3}{32} \times 2\frac{1}{2}$

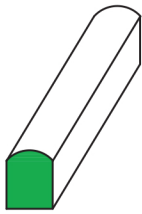

M8110
 $\frac{1}{2} \times \frac{5}{8}$

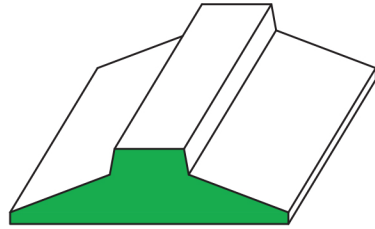

M8130
 $\frac{13}{16} \times 3"$

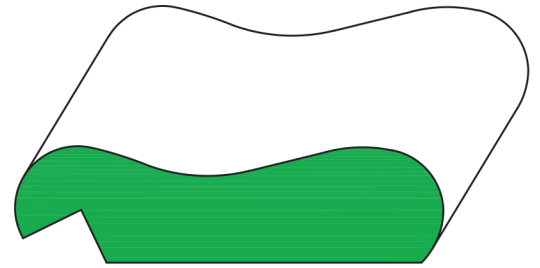

M8152
 $\frac{1}{4} \times 4\frac{5}{8}$

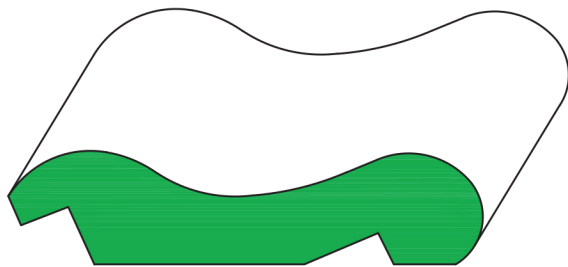

M8155
 $\frac{1}{4} \times 5\frac{1}{8}$

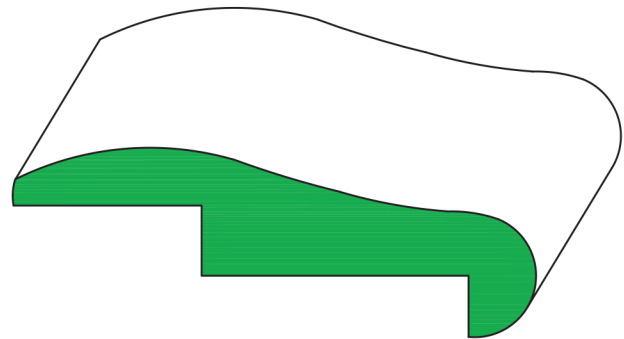

M8160
 $\frac{2}{16} \times 5\frac{1}{16}$

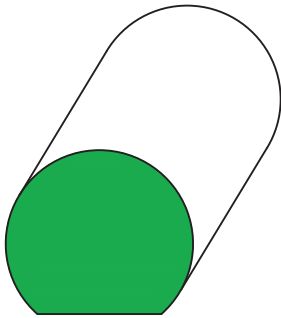

M8214
2" x 1³/₄"

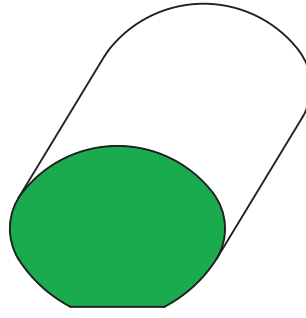

M8216
1³/₄" x 2⁵/₁₆"

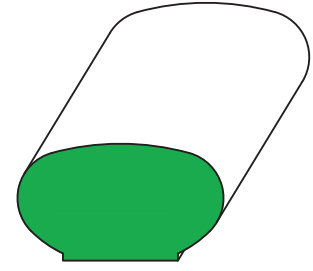

M8218
1¹/₄" x 2¹/₄"

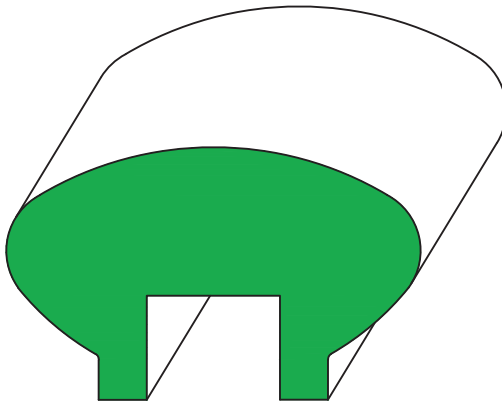

M8220
2³/₄" x 4⁷/₁₆"

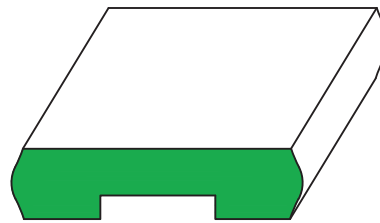

M8222
3³/₄" x 3¹/₈"

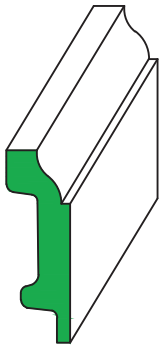

M8374
 $1\frac{1}{16} \times 2\frac{1}{16}$

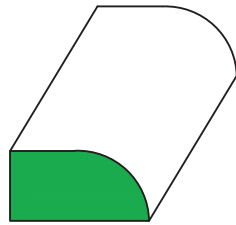

M8400
 $\frac{3}{4} \times 1\frac{1}{2}$

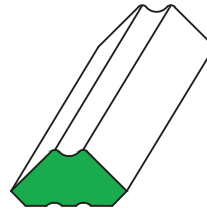

M8402
 $\frac{5}{8} \times 1\frac{1}{4}$

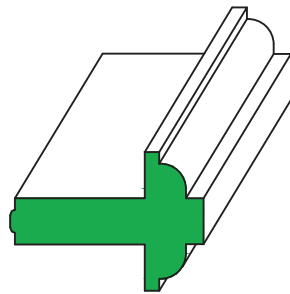

M8500
 $2\frac{1}{16} \times 1\frac{1}{2}$

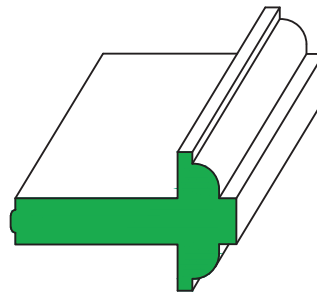

M8502
 $2\frac{7}{16} \times 1\frac{1}{2}$

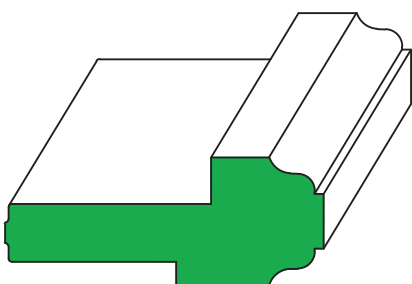

M8504
 $1\frac{3}{8} \times 3\frac{7}{16}$

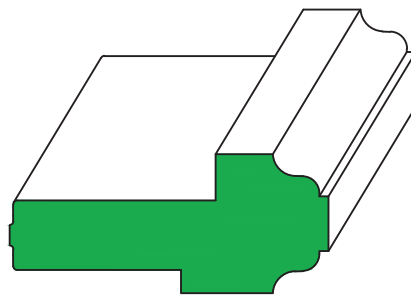

M8506
 $1\frac{1}{2} \times 3\frac{7}{16}$

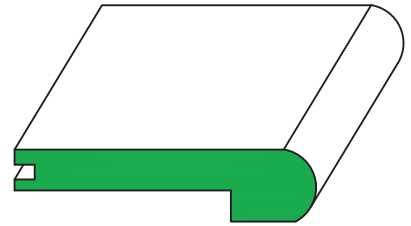

M8600
 $2\frac{5}{32} \times 3\frac{1}{4}$

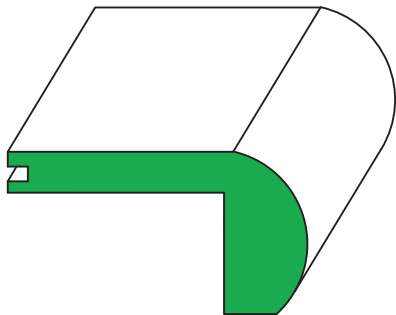

M8602
 $1\frac{3}{4} \times 3\frac{1}{4}$

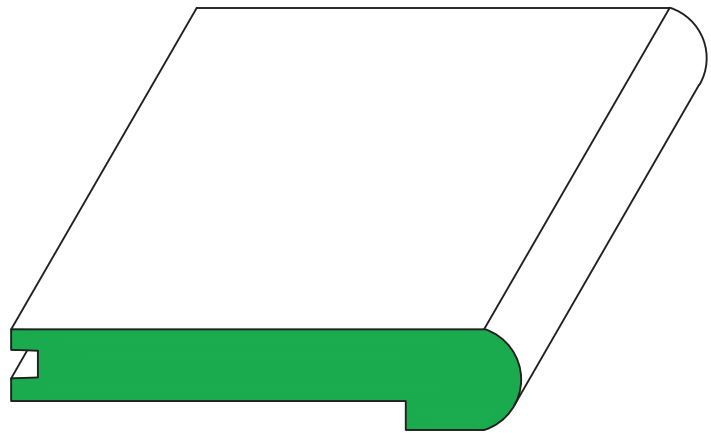

M8604
 $1\frac{1}{16} \times 5\frac{1}{2}$

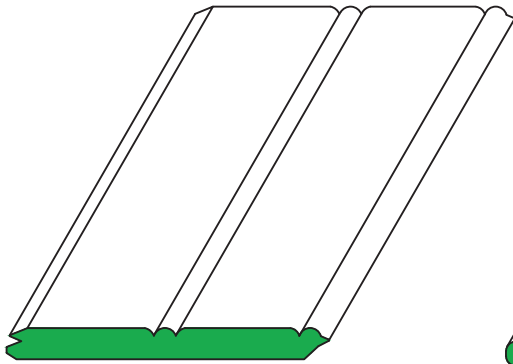

M9000
 $\frac{5}{16} \times 3 \frac{1}{2}$

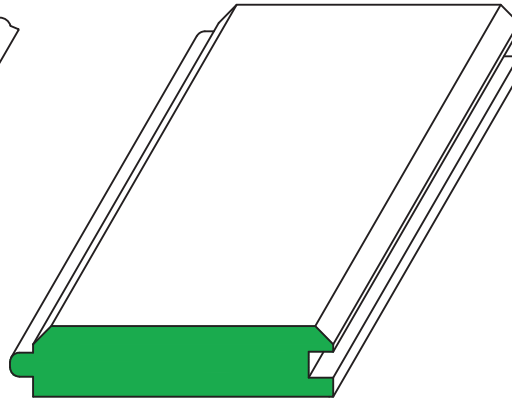

M9002
 $\frac{3}{4} \times W$

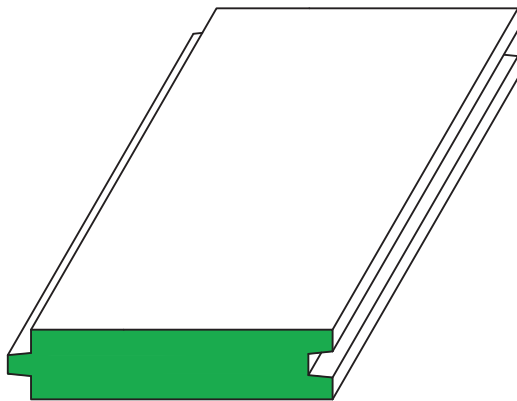

M9005
 $\frac{3}{4} \times$ up to 12" wide

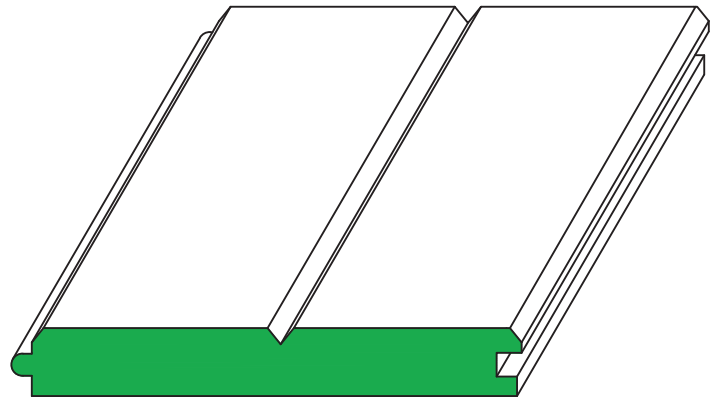

M9012
 $\frac{3}{4} \times 5 \frac{1}{2}$

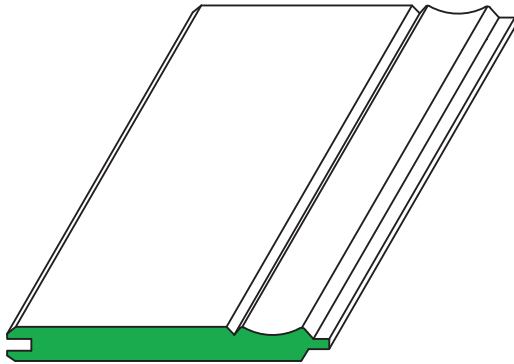

M9014
 $\frac{3}{8} \times 3 \frac{1}{2}$

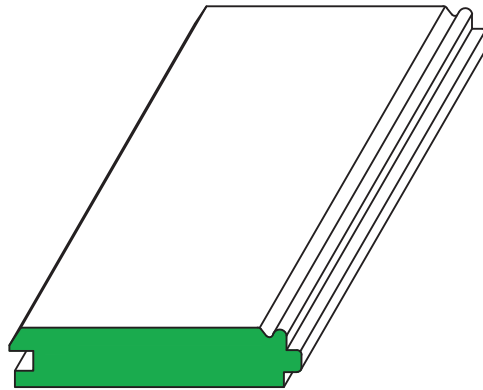

M9016
 $\frac{5}{8} \times 3 \frac{1}{8}$

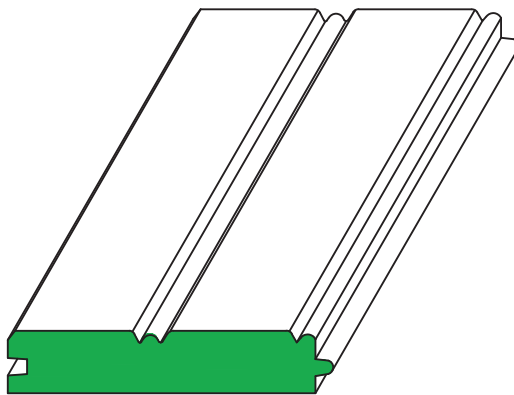

M9018
 $\frac{5}{8} \times 3 \frac{1}{8}$

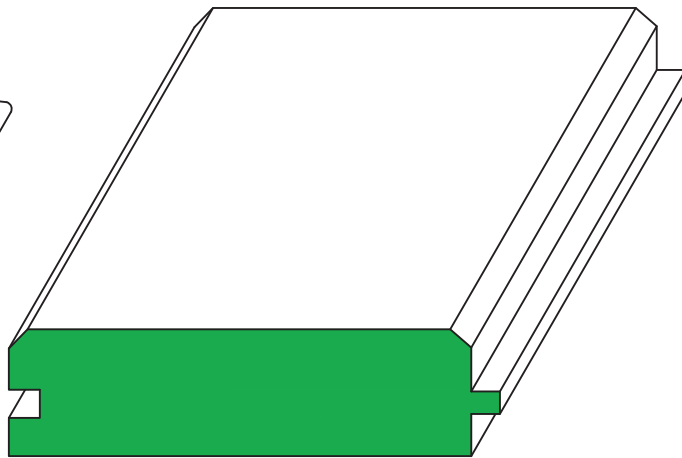

M9022
 $1 \frac{3}{8} \times$ up to 12" wide

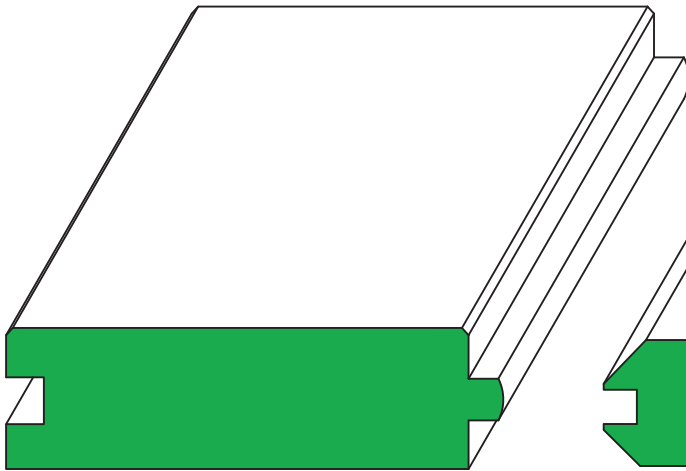

M9024
1½ x up to 12" wide

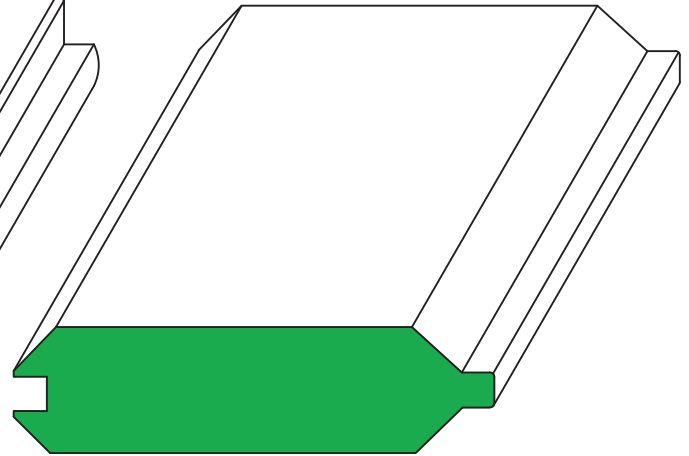

M9026
1⅜ x up to 12" wide

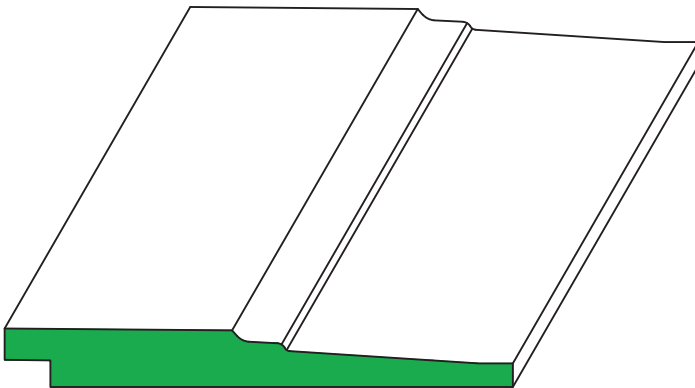

M9028
5⁄8 x 5 ½

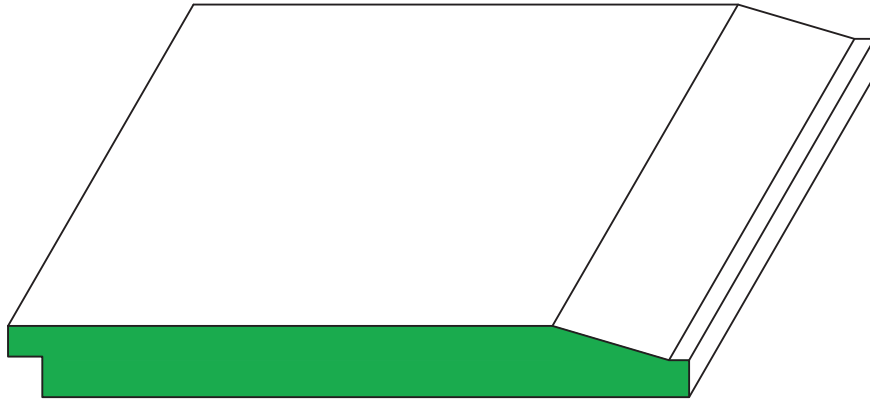

M9030
 $\frac{3}{4} \times 7\frac{3}{8}$

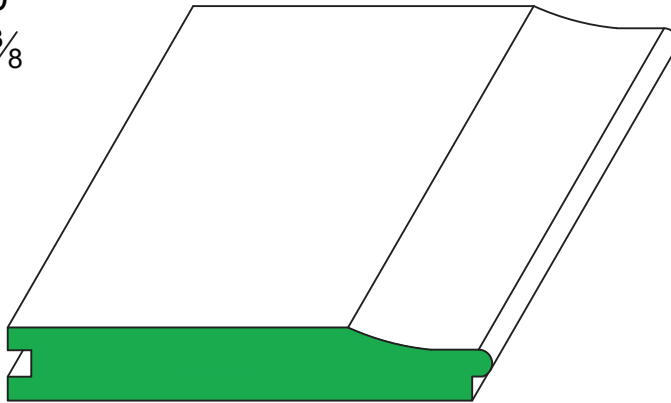

M9032
 $\frac{3}{4} \times 5\frac{1}{4}$

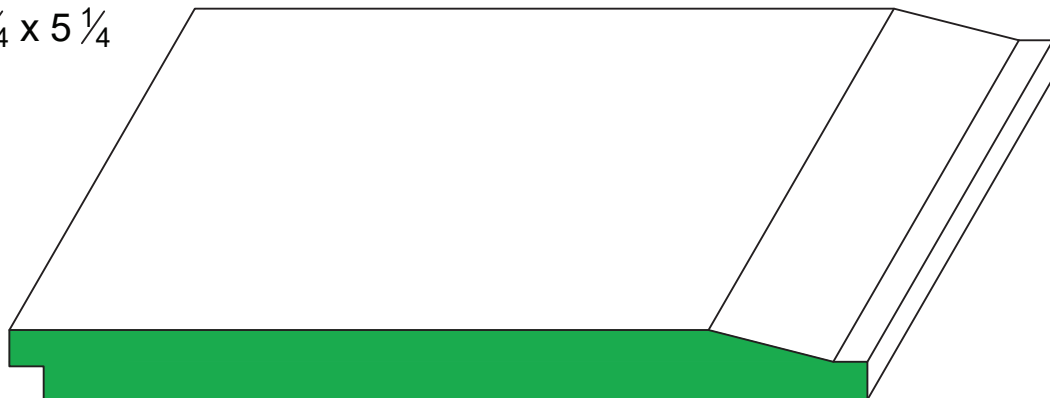

M9034
 $\frac{3}{4} \times 9\frac{1}{4}$

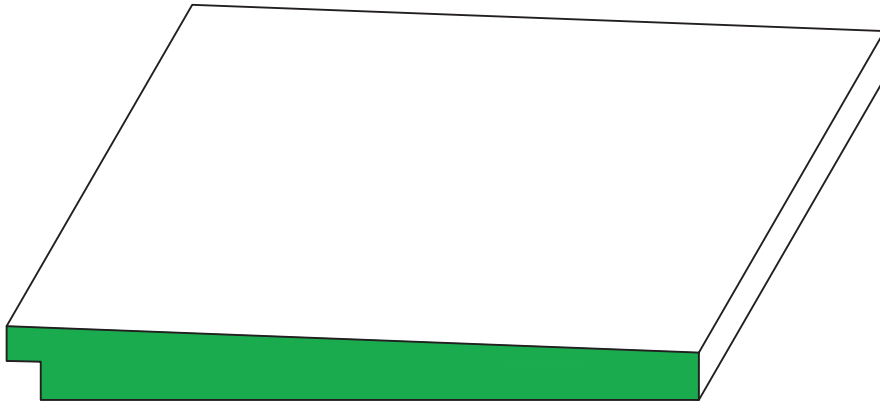

M9036
 $\frac{3}{4} \times 7\frac{1}{2}$

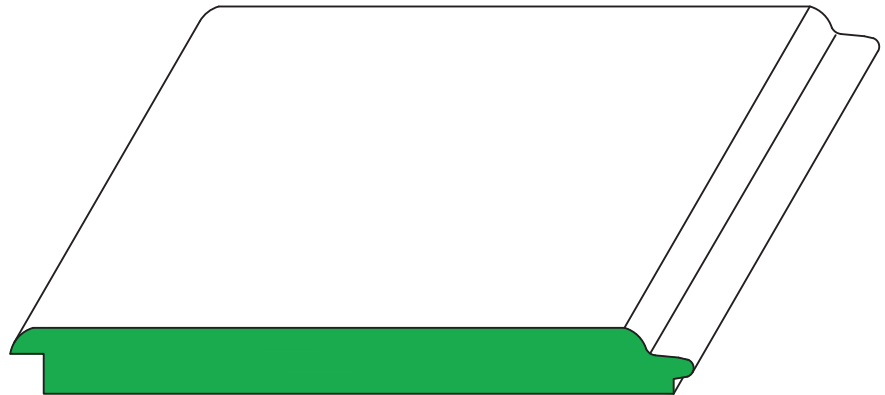

M9038
 $1\frac{1}{16} \times 7\frac{3}{8}$

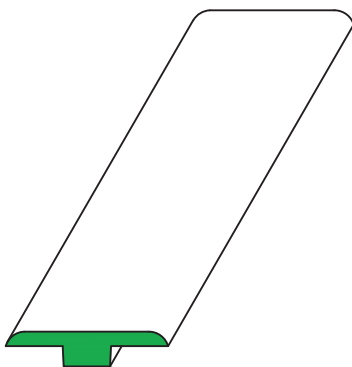

M9100
 $\frac{3}{8} \times 1\frac{3}{4}$

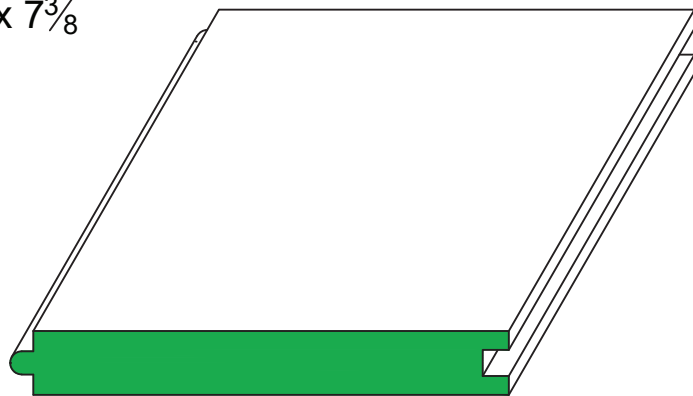

M9200
 $1\frac{1}{16} \times$ up to 12" wide

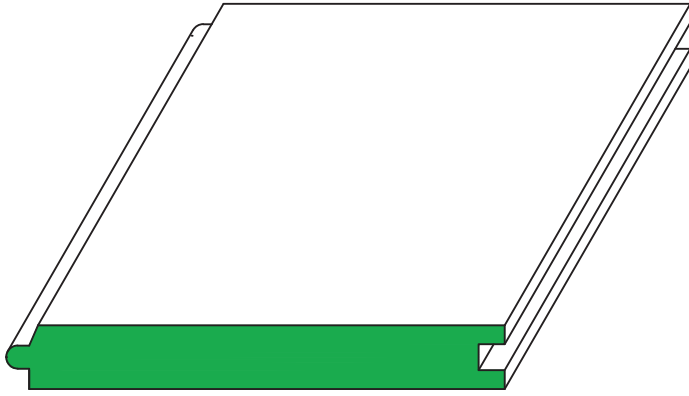

M9202
 $1\frac{1}{16}$ x up to 12" wide

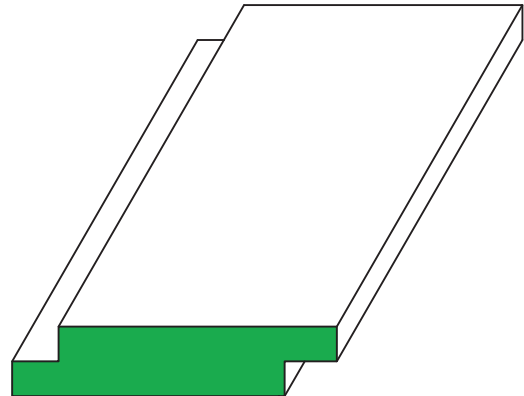

M9314
 $\frac{3}{4}$ x up to 12" wide

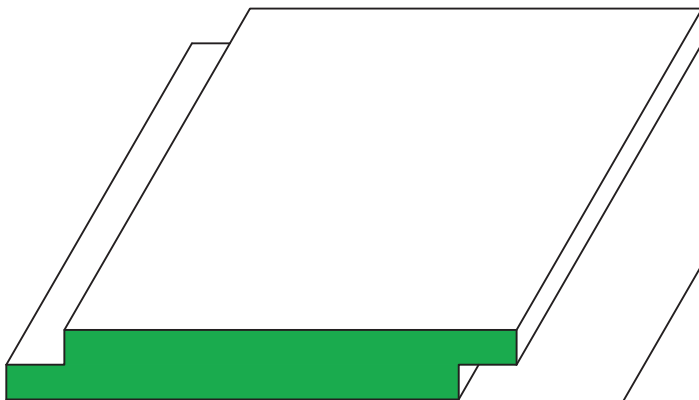

M9316
 $\frac{3}{4}$ x up to 12" wide

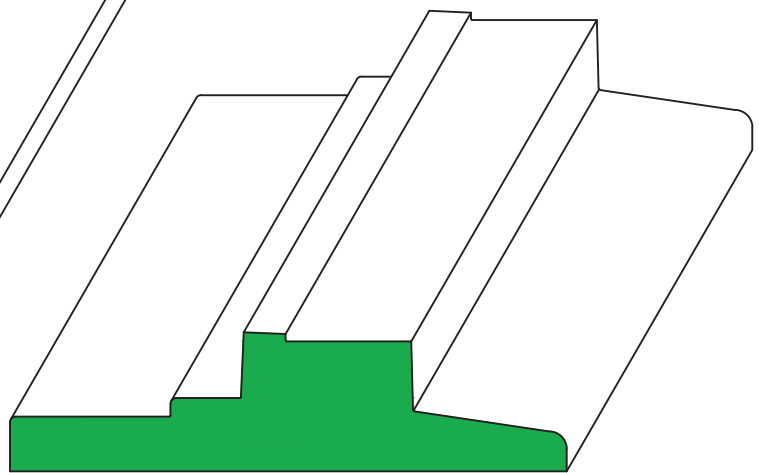

M9330
 $1\frac{1}{2}$ x 6"

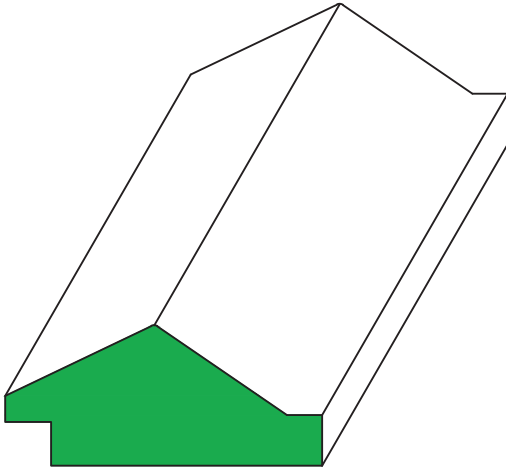

M9332
1½ x 3¾

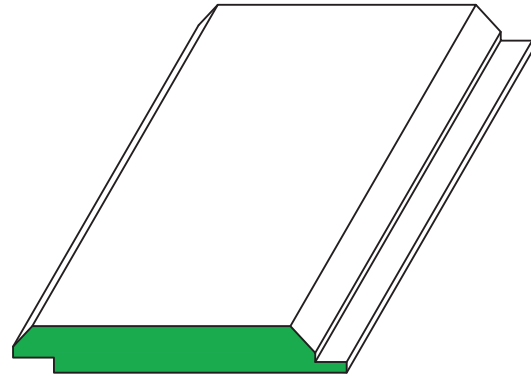

M9334
1½ x 3⅝



Texas Wood Supply is guided by the values of honesty and fairness. If we tell you we will be there, we will. It means we are here to help however we can. We treat you like a neighbor and talk to you as one as well. It's the character of the company. It's in our DNA.

We are quality people and we are experts at what we do. We have worked job sites and know techniques and time-tested solutions. When you want another point of view, we want to be there with architect-level project consulting and insights answering what can be done better. We are always striving to deliver the best solution for our customers.

Texas Wood Supply was originally started by two brothers in 1979 as Valley Carpenters Inc. in Mission, Texas. It soon changed to South Texas Moulding Inc. and moved to the current headquarters location in Donna, Texas in 1984.

The genesis of the company was the need for hardwood moulding in South Texas for the growing residential home market. South Texas Moulding was the only company running moulding at that time south of San Antonio.

The company expanded in the 90's and early 2000's from 1 to 7 locations in Brownsville, Mission, Corpus Christi, Laredo, Houston, and now in San Antonio.

Over 500 million lineal feet of moulding has been run since the start of the company with employees that have been with the company since the 80's and 90's. Texas Wood Supply is a small, regional, privately owned business that's expanded from a couple brothers, one moulder & a simple rip saw to a regional, privately owned business with over 70 employees, 7 stores, high-speed moulders, state-of-the-art laser optimizing rip saws, CNC routers and shapers and hundreds of years of combined experience.



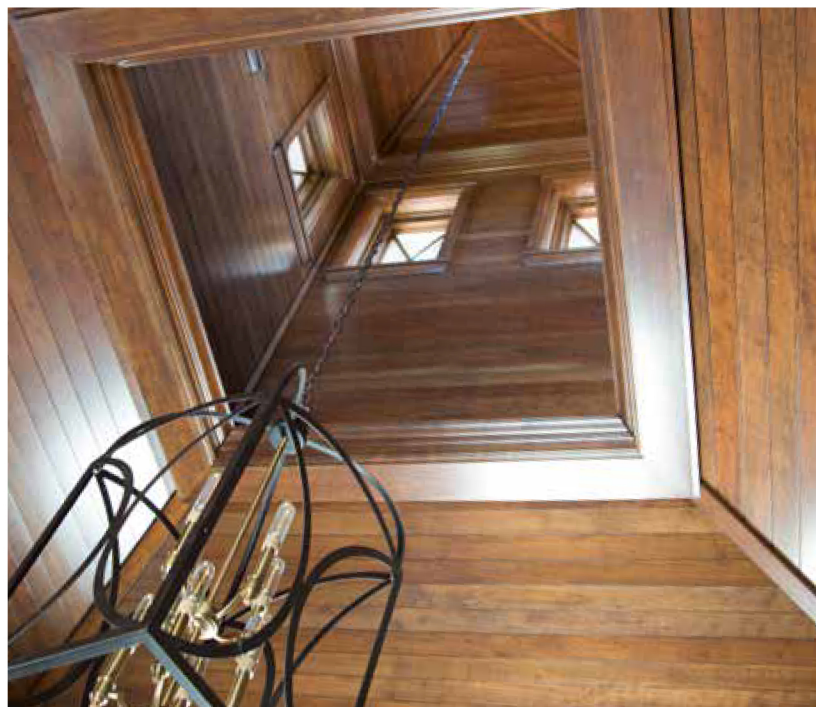

SEVEN CONVENIENT LOCATIONS

DONNA

940 W EXPY 83
DONNA, TX 78537
(956) 464-3371

MISSION

2400 W INTERSTATE HWY 2
MISSION, TX 78572
(956) 519-1700

BROWNSVILLE

4668 RUBEN M. TORRES BLVD
BROWNSVILLE, TX 78526
(956) 831-0340

LAREDO

6412 POLARIS DRIVE
LAREDO, TX 78041
(956) 723-0026

CORPUS CHRISTI

6525 AYERS ST
CORPUS CHRISTI, TX 78415
(361) 857-7770

HOUSTON

3485 W 12th ST
HOUSTON, TX 77008
(713) 842-7102

SAN ANTONIO

2233 NW LOOP 410
SAN ANTONIO, TX 78230
(210) 905-0005

