

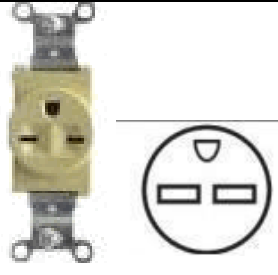
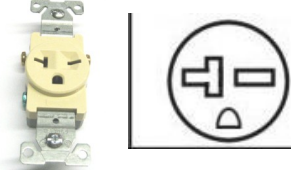

201000 CONTACTOS Y APAGADORES

CONTACTOS

		
No. DE ARTICULO	DESCRIPCION	CTD
052-704	#805V DE 20A-125V/250V	10

		
050-914	#816V SENCILLO 150A-250V	10

		
050-039	#1876V SENCILLO 20A-250V	10

		
052-456	#VGF15V GFCI DOBLE, COLOR IVORY 15A-125V	10

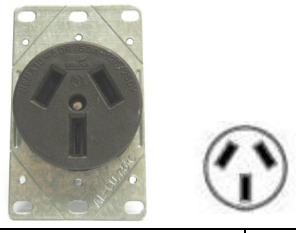
		
053-793	#32B PARA ESTUFA 50A-125/250V	1

		
051-888	#38B PARA SECADORA 30A-125/250V	1

		
052-548	#270B DOBLE 15A-250V	10
052-555	#270V DOBLE 15A-250V	10
057-547	#270W DOBLE 15A-250V	10

USA—MEXICO—CHINA

201000 CONTACTOS Y APAGADORES

CONTACTOS

		
053-744	#1254 50A-250V COLOR CAFE	1

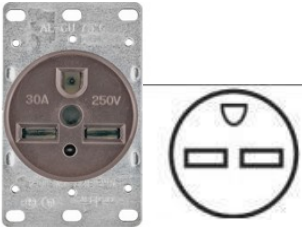
		
050-930	#1234 TIPO COMERCIAL 30A-250V	1

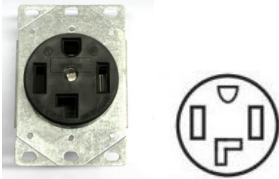
		
053-555	#1257-SP 30A-125/250V	1

		
052-639	#112 PARA ESTUFA 50A-125/250V	1

		
052-647	#125-B 30A-125/250V PARA SECADORA	1

		
053-801	#224 PARA USO CON #202 15A-125V	10

		
050-146	#2887 15A-125V	10

		
051-144	#1186B TRIPLE	25

USA—MEXICO—CHINA

201000 CONTACTOS Y APAGADORES

CLAVIJAS

		
051-896	S80-SP UNIVERSAL DE ALTA RESISTENCIA DE HULE 30A-125/250V O 50A-125/250V	1

		
051-706	S41-SP UNIVERSAL DE VINYL 50A-125V O 30A-125V	1

		
057-612	S42-SP UNIVERSAL DE VINYL 30A-250V O 50A-250V	1

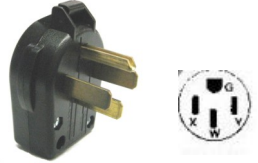
		
053-560	#S21-SP PARA ESTUFA 30A-125/250V O 50A-125/250V	1

		
050-468	#179B DE HULE DE 15A-125V	25

		
050-609	#183BK PLANA 15A-125V	25

		
050-138	#2867 15A-125V PARA USO CON #2887	10

		
050-032	#1709 DE 15A-125V	10

USA—MEXICO—CHINA

201000 CONTACTOS Y APAGADORES

CLAVIJAS

		
050-617	#4866 15A-250V O 20A-250V	10

		
052-258	#202 DE HULE PARA USO CON #224 15A-125V	10

ADAPTADORES DE VINYL

		
050-625	#4400W 15A-125V	10

		
050-633	#419GY 15A-125V	25

ENCHUFES

		
050-476	#124 ENCHUFE INTERPERIE BASE MEDIANA 660W-250V	25

		
050-831	#738B ENCHUFE / ADAPTADOR 15A-125V	25

APAGADORES

		
052-597	#1301B SENCILLO 15A-120V	10
052-605	#1301V SENCILLO 15A-120V	10
052-596	#1301W SENCILLO 15A-120V	10

USA—MEXICO—CHINA

201000 CONTACTOS Y APAGADORES

APAGADORES

		
052-621	#1303V DE ESCALERA 15A-120V	10

		
053-618	#271-V DE ESCALERA 15A-120V/AC	10

		
053-165	#TR274V APAGADOR 15A-120V Y CONTACTO 15A -125V CON TIERRA	10

		
054-148	#452 6A-125V O 3A-250V	10

		
050-666	#458NP 3A-125V O 1A- 125V O 1A-250V	10

		
050-898	#798V APAGADOR 10A-125V O 5A-250V Y CONTACTO 15A-12V	10

		
050-997	#907V 10A-125V AC/DC	10

REDUCTOR GIRATORIO		
		
049-106	R1061-VW-2K BLANCO O COLOR HUESO	25

USA—MEXICO—CHINA

201000 CONTACTOS Y APAGADORES

DETECTOR DE CORRIENTE		
		
053-710	#BP914	10

		
050-864	#758B CON BASE	25

ROSETAS

		
055-020	#659-SP CON CADENA	28

		
055-293	#669-SP CON CADENA Y CONTACTO	28

		
055-012	#604-SP SIN CADENA	28

BENJAMIN

		
053-728	#718B CON CADENA DE 250W-125V Y CONTACTO DE 660W-125V COLOR CAFE	10

		
052-571	#715B SIN CADENA COLOR CAFE 660W-125V	10

USA—MEXICO—CHINA

201000 CONTACTOS Y APAGADORES

BENJAMIN

		
052-589	#960ABD CON CADENA DE ALUMINIO 250W-250V	10

		
051-102	#962 REPUESTO PARA BENJAMIN #960ABD 250W- 250V	10

PLACAS

		
051-599	#2129B PLACA CIEGA	25
051-607	#2129V PLACA CIEGA	25

		
051-540	#2150B PARA DOS CONTACTOS DOBLES	10
053-983	#2150V PARA DOS CONTACTOS DOBLES	10

		
050-567	#2139B PARA DOS APAGADORES SENCILLOS	10
050-575	#2139V PARA DOS APAGADORES SENCILLOS	10

PARA CONTACTO DOBLE		
		
050-500	#2132B	25
050-518	#2132V	10
050-499	#2132W	10

USA—MEXICO—CHINA

201000 CONTACTOS Y APAGADORES

		
050-484	#2131B SENCILLA	25
050-492	#2131V SENCILLA	25

		
050-559	#2138V PARA CONTACTO DOBLE Y APAGADOR SENCILLO	10

		
050-526	#2134B PARA APAGADOR SENCILLO	25
050-534	#2134V PARA APAGADOR SENCILLO	25
050-525	2134W PARA APAGADOR SENCILLO	10

		
051-615	#2141B PARA TRES APAGADORES SENCILLOS	15

		
050-849	#2128V PARA TELEFONO COLOR IVORY	25

		
201-026	WHITE WALL- PLATE FOR GFCI	12

		
053-892	#39CH DE METAL DE 2-25/32"	1

USA—MEXICO—CHINA