

Feniex Industries, Inc.  
1.800.615.8350

Product Guide

# FENIEX PRODUCT GUIDE



## FENIEX INDUSTRIES

Feniex Industries is a USA manufacturer of visual and audio emergency vehicle warning products. Located in the heart of Texas, Feniex is the fastest growing emergency vehicle manufacturer.

Feniex changes lives by manufacturing innovative, American-made products for the world's toughest jobs.



MADE IN THE USA.  
PREMIER VEHICLE LIGHTING







### Product Showcase

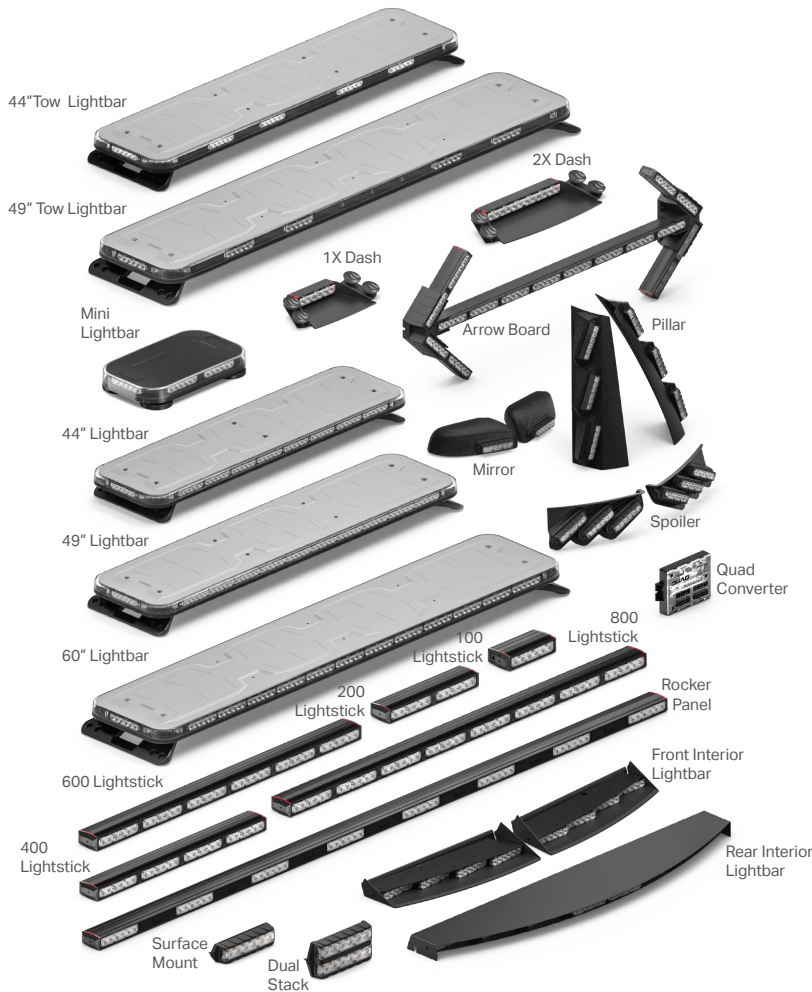

Feniex Industries, Inc.  
1.800.615.8350



Feniex Product Guide  
sales@feniex.com



## Product Showcase

Fusion-S  
Quad  
Feniex One

Feniex Industries, Inc.  
1.800.615.8350

# FUSION-S

The Feniex Fusion-S is the next evolution of the Fusion series. It is the world's brightest and most competitively priced emergency warning line. User configurable in red, blue, amber, white, and green, the Fusion-S offers the user a new and improved 40-degree optic that is 60% brighter than the previous Fusion family. No lighting line can compare to the brightness and light performance of the Fusion-S series.



### ■ SINGLE COLOR:

Incredible customization for 5 colors, including red, blue, amber, white and green.

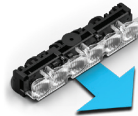

### ■ 40° OPTICS:

A narrow light spread for long, penetrating light guaranteed to be visible in any conditions.



### ■ QUAD CONVERTER:

A digital to analog converter. It converts the 2-pin digital wires from select products to 28 programmable functions.

## QUAD®

ONE 4 ALL

The Feniex Quad is the world's first 4-color emergency warning lighting line and the brightest in the industry. User programmable in red, blue, amber and white, the Quad offers endless customization while remaining competitively-priced. At Feniex Industries, we've seen the future. The future is one option for every first responder and construction site and one sku for every fleet manager. The future of safety comes in four colors and covers every application. The future is Quad.



### ■ 4 COLOR TECH:

Our four lighting color series. Capable of single, dual, tri and quad colors between red, blue, amber and white.



### ■ 60° OPTICS:

Specifically designed to optimize all LEDs in the board to maximize visibility.



### ■ QUAD CONVERTER:

A digital to analog converter. It converts the 2-pin digital wires from select products to 28 programmable functions.

## ONE

CONTROLLER | SIREN | FLEET MANAGER

The Feniex One is the world's first autonomous controller. Feniex Industries now brings the officer, the fleet manager and the installer a brand new product of incredible performance. The Feniex One champions functionality, ease of use, and streamlined installation. The next evolution in smart controllers goes beyond traditional standards with innovations that bridge the gap of automation. Transformative technology. The Feniex One.



### ■ LIVE FLEET HEALTH:

Monitor your fleet live with our fleet management software and controller updates for vehicle maintenance.



### ■ FENIEX WEB:

Track your fleets health, message vehicles and .



### ■ FLEET MESSAGING:

Contact specific vehicles that need service or fleet maintenance.



### ■ RELAY:

Multiple Quad and data ports for quick connectivity. A built-in siren and 32 outputs.

Feniex Product Guide  
sales@feniex.com





# FUSION S

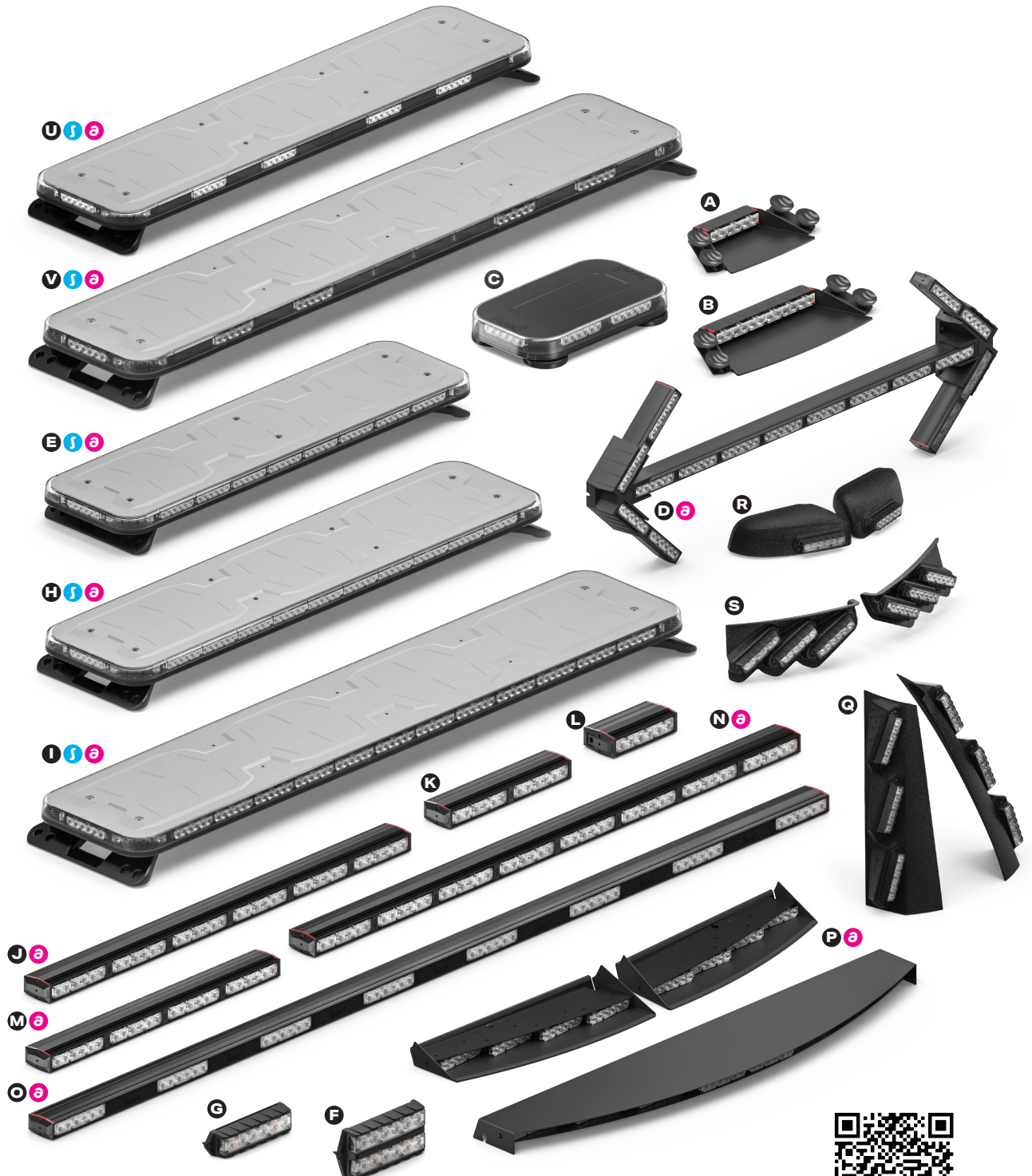





PRODUCT		DIMENSIONS	VOLTAGE	CURRENT DRAW	SYNC	WIRE
A. 1X Dash Light	Ⓛ	1.7" x 4.97" x 9.71"	10-18 V DC	1 Amp	Ⓡ	Cig Plug
B. 2X Dash Light	Ⓛ	1.7" x 4.97" x 13.8"	10-18 V DC	1.5 Amps	Ⓡ	Cig Plug
C. Mini Lightbar	Ⓛ	2.3" x 8.1" x 13.94"	10-18 V DC	5 Amps	Ⓡ	Cig Plug
D. Arrow Board	ⓐ	1.3" x 2.25" x 42.5"	10-18 V DC	8 Amps		4 Pin
M. 400 Lightstick	ⓐ	1.3" x 2.25" x 18.8"	10-18 V DC	4 Amps		4 Pin
J. 600 Light Stick	ⓐ	1.3" x 2.25" x 28.1"	10-18 V DC	5 Amps		4 Pin
N. 800 Light Stick	ⓐ	1.3" x 2.25" x 37.5"	10-18 V DC	6 Amps		4 Pin
O. Rocker Panels	ⓐ	1.3" x 2.25" x 64.4"	10-18 V DC	12 Amps		4 Pin
T. Interior Lightbars	ⓐ	N/A	10-18 V DC	6 Amps		4 Pin
E. 44" Lightbar	Ⓝ ⓐ	1.6" x 11.8" x 44.5"	10-18 V DC	15 Amps		4 Pin
H. 49" Lightbar	Ⓝ ⓐ	1.6" x 11.8" x 49.2"	10-18 V DC	16 Amps		4 Pin
I. 60" Lightbar	Ⓝ ⓐ	1.6" x 11.8" x 59.8"	10-18 V DC	18 Amps		4 Pin
U. Tow 49" Lightbar	Ⓝ ⓐ	1.6" x 11.8" x 49.2"	10-18 V DC	16 Amps		4 Pin
V. Tow 60" Lightbar	Ⓝ ⓐ	1.6" x 11.8" x 59.8"	10-18 V DC	18 Amps		4 Pin
F. Surface Mount	Ⓢ	0.88" x 1.7" x 5.22"	10-18 V DC	1 Amp	Ⓡ	6 Pin
G. Dual Stack	Ⓢ	1.8" x 1.7" x 5.22"	10-18 V DC	2 Amps	Ⓡ	6 Pin
K. 200 Light Stick	Ⓢ	1.3" x 2.25" x 9.5"	10-18 V DC	1.5 Amps	Ⓡ	6 Pin
L. 100 Light Stick	Ⓢ	1.3" x 2.25" x 4.8"	10-18 V DC	1 Amp	Ⓡ	6 Pin
Q. Pillar Mount	Ⓢ	N/A	10-18 V DC	5 Amps	Ⓡ	6 Pin
R. Mirror Mount	Ⓢ	N/A	10-18 V DC	1.5 Amps	Ⓡ	6 Pin
S. Spoiler Mount	Ⓢ	N/A	10-18 V DC	5 Amps	Ⓡ	6 Pin

**Product Locations**

Use the diagram below to see which products have specific mounting locations.

**Legend**

Use the icons to determine the wiring harness for the products.

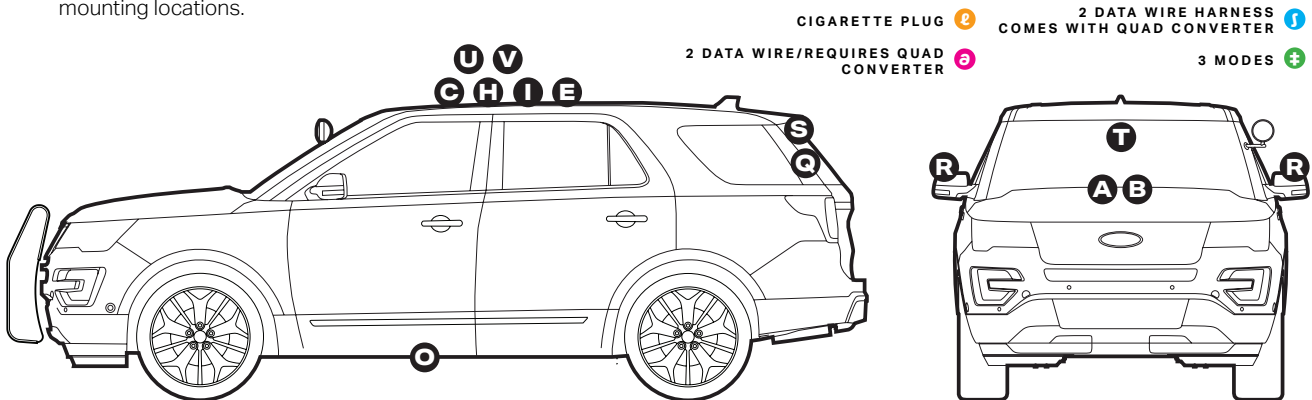



# FUSION-S GPL 44" LIGHTBAR

A. Fusion-S GPL 44" Lightbar  
B. Quad Converter

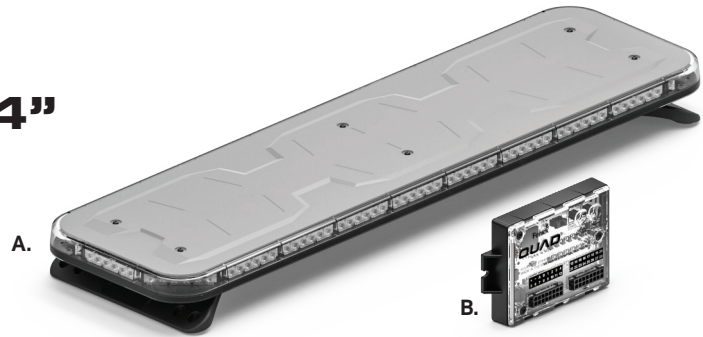

PART NUMBER	DIMENSIONS	VOLTAGE	CURRENT DRAW	LED COLORS
A. FS-4420	1.6" x 11.8" x 44.5"	10-18 V DC	14 Amps	R B A W G
B. Q-0020	1" x 2.6" x 4.1"	10-18 V DC	1 Amp	

**MOUNTING:**

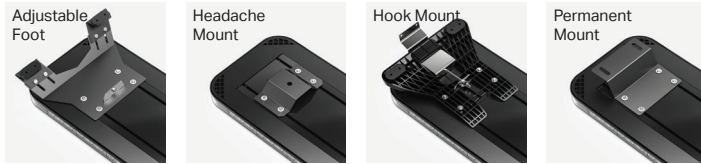

**CERTIFICATIONS:**



**DESCRIPTION:**

The Feniex Fusion-S is the next evolution of the Fusion series. It is the world's brightest and most competitively priced emergency warning line. User configurable in red, blue, amber, white, and green, the Fusion-S offers the user a new and improved 40-degree optic that is 60% brighter than the previous Fusion family. No lighting line can compare to the brightness and light performance of the Fusion-S series.

- Available in Single Colors: R, B, A, W, G
- 4 programmable priority flashing modes
- Syncs with T3, Cannon, Under Mirror Puck and QSM
- Multiple programmable modes:
  - Flood modes
  - Stop, tail & turn signal patterns
  - Cruise mode patterns
  - Traffic advisor modes
  - Cut-off modes
  - California Red option
  - Dim modes
- 132x single color led count
- 15 programmable flash patterns
- Field servicable
- 40° optical light spread for long-range visibility
- 15' cable length
- Packaged with Quad Converter providing 28 programmable modes
- Standard hook-mount supports 30+ vehicle makes & models



Fusion-S Converter Wires



Military-grade Aluminum



Anti-yellowing & anti-cracking clear-coated polycarbonate Lens





# FUSION-S GPL 49" LIGHTBAR

- A. Fusion-S GPL 49" Lightbar
- B. Quad Converter

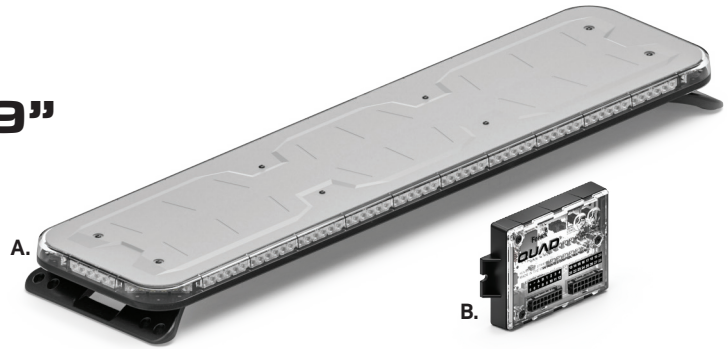

PART NUMBER	DIMENSIONS	VOLTAGE	CURRENT DRAW	LED COLORS
A. FS-4918	1.6" x 11.8" x 49.2"	10-18 V DC	15 Amps	R B A W G
B. Q-0020	1" x 2.6" x 4.1"	10-18 V DC	1 Amp	

**MOUNTING:**

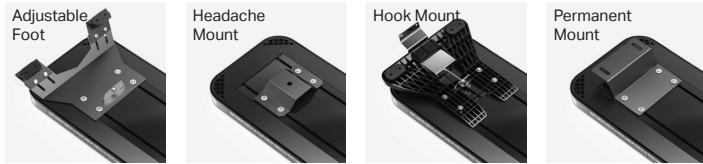

**CERTIFICATIONS:**



**DESCRIPTION:**

The Feniex Fusion-S is the next evolution of the Fusion series. It is the world's brightest and most competitively priced emergency warning line. User configurable in red, blue, amber, white, and green, the Fusion-S offers the user a new and improved 40-degree optic that is 60% brighter than the previous Fusion family. No lighting line can compare to the brightness and light performance of the Fusion-S series.

- Available in Single Colors: R, B, A, W, G
- 4 programmable priority flashing modes
- Syncs with T3, Cannon, Under Mirror Puck and QSM
- Multiple programmable modes:
  - Flood modes
  - Stop, tail & turn signal patterns
  - Cruise mode patterns
  - Traffic advisor modes
  - Cut-off modes
  - California Red option
  - Dim modes
- 156x single color led count
- 15 programmable flash patterns
- Field servicable
- 40° optical light spread for long-range visibility
- 15' cable length
- Packaged with Quad Converter providing 28 programmable modes
- Standard hook-mount supports 30+ vehicle makes & models



Fusion-S Converter Wires



Military-grade Aluminum



Anti-yellowing & anti-cracking clear-coated polycarbonate Lens



# FUSION GPL 60" LIGHTBAR

A. Fusion GPL 60" Lightbar  
B. Quad Converter

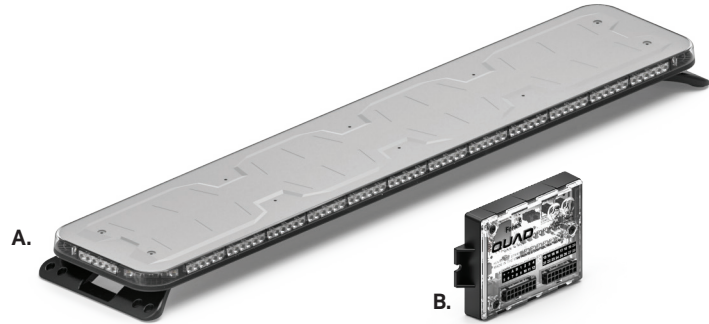

PART NUMBER	DIMENSIONS	VOLTAGE	CURRENT DRAW	LED COLORS
A. FS-6019	1.6" x 11.8" x 59.8"	10-18 V DC	16 Amps	R B A W G
B. Q-0020	1" x 2.6" x 4.1"	10-18 V DC	1 Amp	

### MOUNTING:

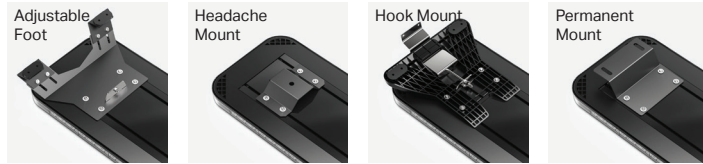

### CERTIFICATIONS:



### DESCRIPTION:

The Feniex Fusion-S is the next evolution of the Fusion series. It is the world's brightest and most competitively priced emergency warning line. User configurable in red, blue, amber, white, and green, the Fusion-S offers the user a new and improved 40-degree optic that is 60% brighter than the previous Fusion family. No lighting line can compare to the brightness and light performance of the Fusion-S series.

- Available in Single Colors: R, B, A, W, G
- 4 programmable priority flashing modes
- Syncs with T3, Cannon, Under Mirror Puck and QSM
- Multiple programmable modes:
  - Flood modes
  - Stop, tail & turn signal patterns
  - Cruise mode patterns
  - Traffic advisor modes
  - Cut-off modes
  - California Red option
  - Dim modes
- 180x single color led count
- 15 programmable flash patterns
- Field servicable
- 40° optical light spread for long-range visibility
- 15' cable length
- Packaged with Quad Converter providing 28 programmable modes
- Standard hook-mount supports 30+ vehicle makes & models



Fusion-S Converter Wires



Military-grade Aluminum



Anti-yellowing & anti-cracking clear-coated polycarbonate Lens





# FUSION-S MINI LIGHTBAR



- A. Fusion-S Mini Lightbar
- B. Quad Converter

PART NUMBER	DIMENSIONS	VOLTAGE	CURRENT DRAW	LED COLORS
A. FS-8118	2.3" x 8.1" x 13.94"	10-18 V DC	5 Amps	R  B  A  W  G

**MOUNTING:**



**CERTIFICATIONS:**



**DESCRIPTION:**

The Fenix Fusion-S is the next evolution of the Fusion series. It is the world's brightest and most competitively priced emergency warning line. User configurable in red, blue, amber, white, and green, the Fusion-S offers the user a new and improved 40-degree optic that is 60% brighter than the previous Fusion family. No lighting line can compare to the brightness and light performance of the Fusion-S series.

- Available in Single Colors: R, B, A, W, G
- 40° optical light spread for long-range visibility
- 2 programmable modes
- Syncs with T3, Cannon, Under Mirror Puck and QSM
- 15' cable length
- 36x single color led count
- Multiple modes capabilities:
  - Flood mode patterns
  - Cruise mode patterns

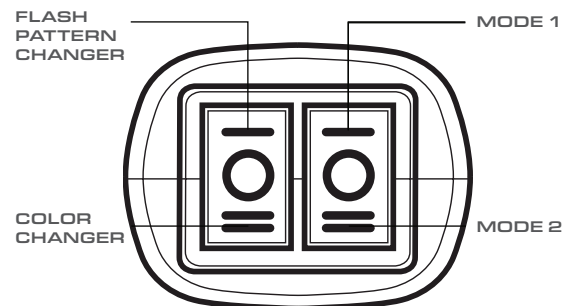
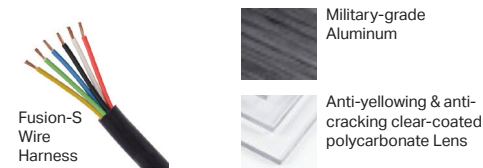



# FUSION TOW 49" LIGHTBAR

A. Fusion Tow 49" Lightbar  
B. Quad Converter

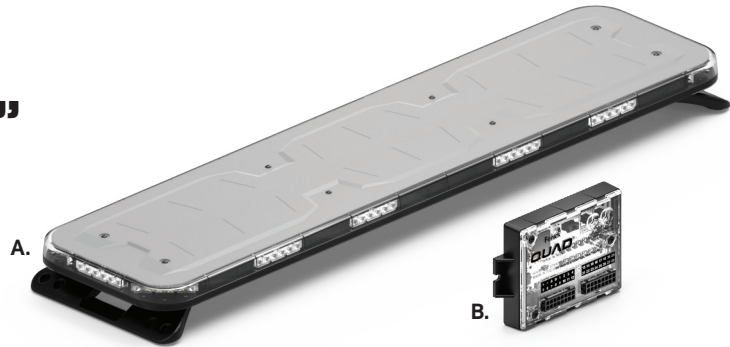

PART NUMBER	DIMENSIONS	VOLTAGE	CURRENT DRAW	LED COLORS
A. FS-0320	1.6" x 11.8" x 49.2"	10-18 V DC	9 Amps	R W A
B. Q-0020	1" x 2.6" x 4.1"	10-18 V DC	1 Amp	

### MOUNTING:

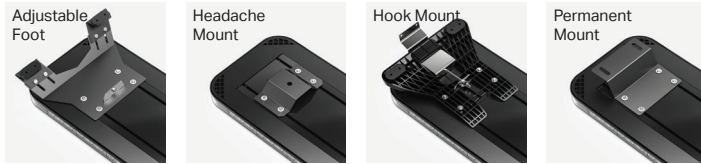

### CONFIGURATION:

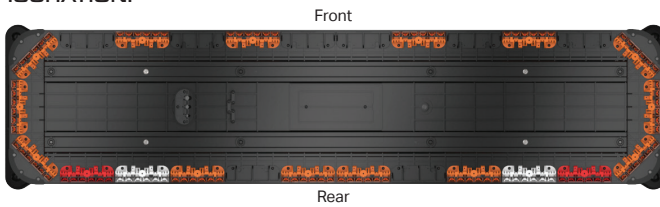

### CERTIFICATIONS:



### DESCRIPTION:

The Feniex Fusion-S is the next evolution of the Fusion series. It is the world's brightest and most competitively priced emergency warning line. User configurable in red, blue, amber, white, and green, the Fusion-S offers the user a new and improved 40-degree optic that is 60% brighter than the previous Fusion family. No lighting line can compare to the brightness and light performance of the Fusion-S series.

- Available in Single Colors: R, B, A, W, G
- 4 programmable priority flashing modes
- Syncs with T3, Cannon, Under Mirror Puck and QSM
- Multiple programmable modes:
  - Flood modes
  - Stop, tail & turn signal patterns
  - Cruise mode patterns
  - Traffic advisor modes
  - Cut-off modes
  - California Red option
  - Dim modes
- 108x single color led count
- 15 programmable flash patterns
- Field servicable
- 40° optical light spread for long-range visibility
- 15' cable length
- Packaged with Quad Converter providing 28 programmable modes
- Standard hook-mount supports 30+ vehicle makes & models



Military-grade Aluminum



Anti-yellowing & anti-cracking clear-coated polycarbonate Lens





# FUSION TOW 60" LIGHTBAR

A. Fusion Tow 60" Lightbar  
B. Quad Converter

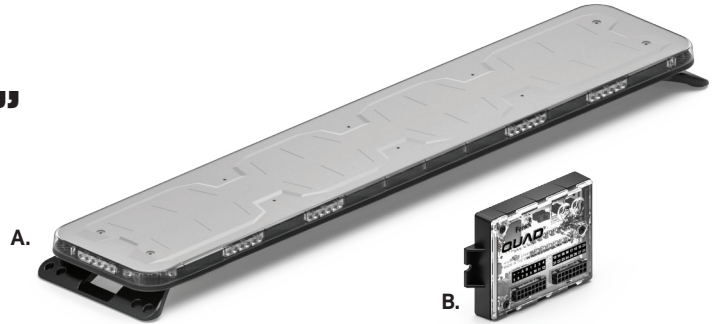

PART NUMBER	DIMENSIONS	VOLTAGE	CURRENT DRAW	LED COLORS
A. FS-0320	1.6" x 11.8" x 59.8"	10-18 V DC	10 Amps	R W A
B. Q-0020	1" x 2.6" x 4.1"	10-18 V DC	1 Amp	

**MOUNTING:**

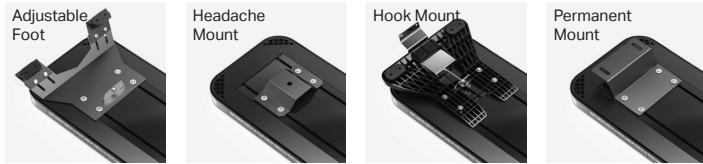

**CONFIGURATION:**

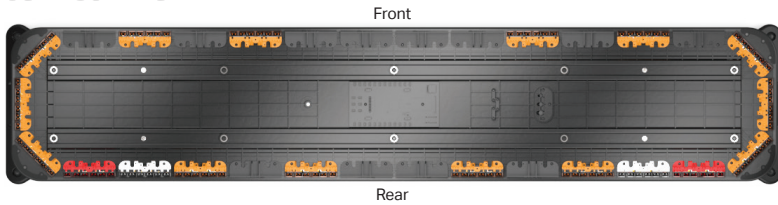

**CERTIFICATIONS:**



**DESCRIPTION:**

The Feniex Fusion-S is the next evolution of the Fusion series. It is the world's brightest and most competitively priced emergency warning line. User configurable in red, blue, amber, white, and green, the Fusion-S offers the user a new and improved 40-degree optic that is 60% brighter than the previous Fusion family. No lighting line can compare to the brightness and light performance of the Fusion-S series.

- Available in Single Colors: R, B, A, W, G
- 4 programmable priority flashing modes
- Syncs with T3, Cannon, Under Mirror Puck and QSM
- Multiple programmable modes:
  - Flood modes
  - Stop, tail & turn signal patterns
  - Cruise mode patterns
  - Traffic advisor modes
  - Cut-off modes
  - California Red option
  - Dim modes
- 108x single color led count
- 15 programmable flash patterns
- Field servicable
- 40° optical light spread for long-range visibility
- 15' cable length
- Packaged with Quad Converter providing 28 programmable modes
- Standard hook-mount supports 30+ vehicle makes & models



Military-grade Aluminum



Anti-yellowing & anti-cracking clear-coated polycarbonate Lens



# FUSION-S SURFACE MOUNT

A. Fusion Surface Mount



PART NUMBER	DIMENSIONS	VOLTAGE	CURRENT DRAW	LED COLORS
A. FSM-*	5.22" x 0.88" x 1.17"	10-18 V DC	1 Amp	R  B  A  W  G

**MOUNTING:**



**VEHICLE SPECIFIC:**



**CERTIFICATIONS:**



**DESCRIPTION:**

The Feniex Fusion-S is the next evolution of the Fusion series. It is the world's brightest and most competitively priced emergency warning line. User configurable in red, blue, amber, white, and green, the Fusion-S offers the user a new and improved 40-degree optic that is 60% brighter than the previous Fusion family. No lighting line can compare to the brightness and light performance of the Fusion-S series.

- Available in Single Colors: R, B, A, W, G
- 40° optical light spread for long-range visibility
- 3 programmable modes
- Syncs with T3, Cannon, Under Mirror Puck and QSM
- 10' cable length
- 6x single color led count
- Multiple modes capabilities:
  - Flood mode patterns
  - Stop, tail & turn signal patterns
  - Cruise mode patterns



Military-grade Aluminum



Anti-yellowing & anti-cracking clear-coated polycarbonate Lens





Surface Mount

# FUSION-S DUAL STACK

A. Fusion-S Dual Stack



PART NUMBER	DIMENSIONS	VOLTAGE	CURRENT DRAW	LED COLORS
A. FDSM-*	5.22" x 0.88" x 1.17"	10-18 V DC	1.5 Amps	R  B  A  W  G

**CERTIFICATIONS:**



**DESCRIPTION:**

The Feniex Fusion-S is the next evolution of the Fusion series. It is the world’s brightest and most competitively priced emergency warning line. User configurable in red, blue, amber, white, and green, the Fusion-S offers the user a new and improved 40-degree optic that is 60% brighter than the previous Fusion family. No lighting line can compare to the brightness and light performance of the Fusion-S series.

- Available in Single Colors: R, B, A, W, G
- 40° optical light spread for long-range visibility
- 3 programmable modes
- Syncs with T3, Cannon, Under Mirror Puck and QSM
- 10' cable length
- 12x single color led count
- Multiple modes capabilities:
  - Flood mode patterns
  - Stop, tail & turn signal patterns
  - Cruise mode patterns



Fusion-S  
Wire  
Harness



Military-grade  
Aluminum



Anti-yellowing & anti-  
cracking clear-coated  
polycarbonate Lens



# FUSION-S 100 LIGHTSTICK



A. Fusion-S 100 Lightstick

A.

PART NUMBER	DIMENSIONS	VOLTAGE	CURRENT DRAW	LED COLORS
A. FS-0116	1.22" x 4.8" x 2.25"	10-18 V DC	1 Amp	R B A W G

**MOUNTING:**

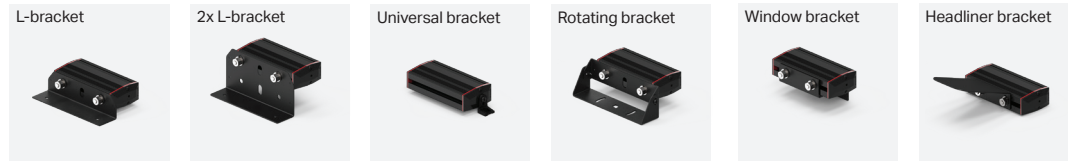

**CERTIFICATIONS:**



**DESCRIPTION:**

The Feniex Fusion-S is the next evolution of the Fusion series. It is the world's brightest and most competitively priced emergency warning line. User configurable in red, blue, amber, white, and green, the Fusion-S offers the user a new and improved 40-degree optic that is 60% brighter than the previous Fusion family. No lighting line can compare to the brightness and light performance of the Fusion-S series.

- Available in Single Colors: R, B, A, W, G
- 40° optical light spread for long-range visibility
- 3 programmable modes
- Syncs with T3, Cannon, Under Mirror Puck and QSM
- 8' cable length
- 6x single color led count
- Multiple modes capabilities:
  - Flood mode patterns
  - Stop, tail & turn signal patterns
  - Cruise mode patterns



Fusion-S Wire Harness



Military-grade Aluminum



Anti-yellowing & anti-cracking clear-coated polycarbonate Lens



# FUSION-S 200 LIGHTSTICK



A. Fusion-S 200 Lightstick

PART NUMBER	DIMENSIONS	VOLTAGE	CURRENT DRAW	LED COLORS
A. FS-0216	1.22" x 4.8" x 2.25"	10-18 V DC	1.5 Amps	R B A W G

**MOUNTING:**

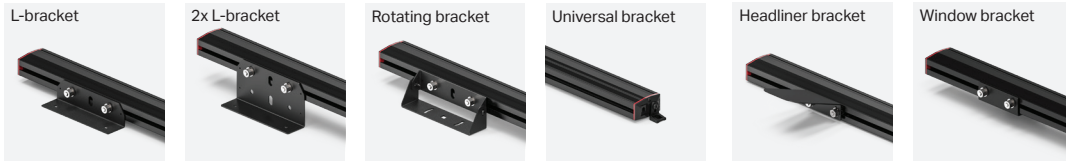

**CERTIFICATIONS:**



**DESCRIPTION:**

The Feniex Fusion-S is the next evolution of the Fusion series. It is the world's brightest and most competitively priced emergency warning line. User configurable in red, blue, amber, white, and green, the Fusion-S offers the user a new and improved 40-degree optic that is 60% brighter than the previous Fusion family. No lighting line can compare to the brightness and light performance of the Fusion-S series.

- Available in Single Colors: R, B, A, W, G
- 40° optical light spread for long-range visibility
- 3 programmable modes
- Syncs with T3, Cannon, Under Mirror Puck and QSM
- 8' cable length
- 6x single color led count
- Multiple modes capabilities:
  - Flood mode patterns
  - Stop, tail & turn signal patterns
  - Cruise mode patterns



Military-grade Aluminum



Anti-yellowing & anti-cracking clear-coated polycarbonate Lens





# FUSION-S 400 LIGHTSTICK

A. Fusion-S 400 Lightstick  
B. Quad Converter

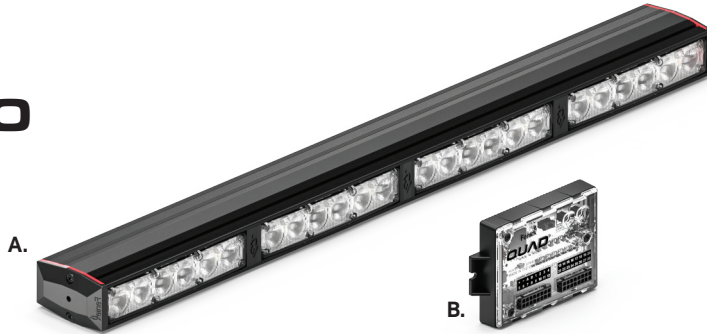

PART NUMBER	DIMENSIONS	VOLTAGE	CURRENT DRAW	LED COLORS
A. FS-0416	1.22" x 18.82" x 2.25"	10-18 V DC	4 Amps	R B A W G
B. Q-0020	1" x 2.6" x 4.1"	10-18 V DC	1 Amp	

**MOUNTING:**

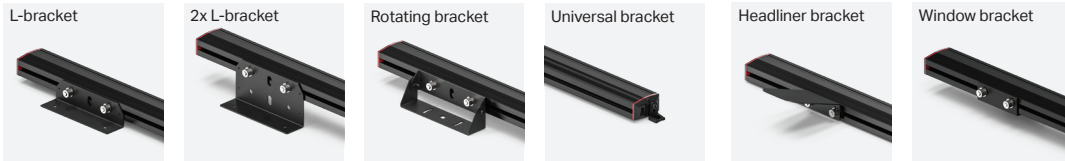

**CERTIFICATIONS:**



**DESCRIPTION:**

The Feniex Fusion-S is the next evolution of the Fusion series. It is the world's brightest and most competitively priced emergency warning line. User configurable in red, blue, amber, white, and green, the Fusion-S offers the user a new and improved 40-degree optic that is 60% brighter than the previous Fusion family. No lighting line can compare to the brightness and light performance of the Fusion-S series.

- Available in Single Colors: R, B, A, W, G
- 4 programmable priority flashing modes
- Syncs with T3, Cannon, Under Mirror Puck and QSM
- Multiple programmable modes:
  - Flood modes
  - Stop, tail & turn signal patterns
  - Cruise mode patterns
  - Traffic advisor modes
  - Cut-off modes
  - California Red option
  - Dim modes
- 24x single color led count
- 15 programmable flash patterns
- Field servicable
- 40° optical light spread for long-range visibility
- 10' cable length



Fusion-S Converter Wires



Military-grade Aluminum



Anti-yellowing & anti-cracking clear-coated polycarbonate Lens



# FUSION-S 600 LIGHTSTICK

A. Fusion-S 600 Lightstick  
B. Quad Converter

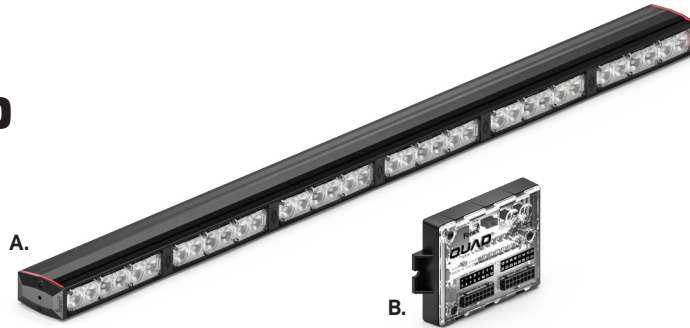

PART NUMBER	DIMENSIONS	VOLTAGE	CURRENT DRAW	LED COLORS
A. FS-0616	1.22" x 28.14" x 2.25"	10-18 V DC	5 Amps	R  B  A  W  G
B. Q-0020	1" x 2.6" x 4.1"	10-18 V DC	1 Amp	

**MOUNTING:**

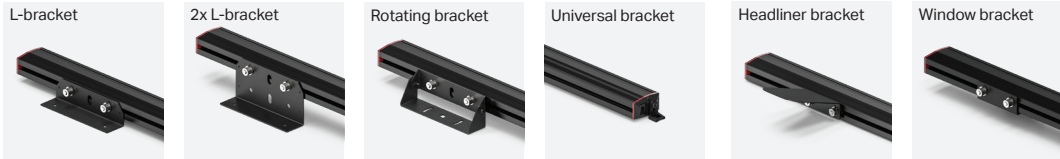

**CERTIFICATIONS:**



**DESCRIPTION:**

The Feniex Fusion-S is the next evolution of the Fusion series. It is the world's brightest and most competitively priced emergency warning line. User configurable in red, blue, amber, white, and green, the Fusion-S offers the user a new and improved 40-degree optic that is 60% brighter than the previous Fusion family. No lighting line can compare to the brightness and light performance of the Fusion-S series.

- Available in Single Colors: R, B, A, W, G
- 4 programmable priority flashing modes
- Syncs with T3, Cannon, Under Mirror Puck and QSM
- Multiple programmable modes:
  - Flood modes
  - Stop, tail & turn signal patterns
  - Cruise mode patterns
  - Traffic advisor modes
  - Cut-off modes
  - California Red option
  - Dim modes
- 36x single color led count
- 15 programmable flash patterns
- Field servicable
- 40° optical light spread for long-range visibility
- 10' cable length



Fusion-S Converter Wires



Military-grade Aluminum



Anti-yellowing & anti-cracking clear-coated polycarbonate Lens



# FUSION-S 800 LIGHTSTICK

- A. Fusion-S 800 Lightstick
- B. Quad Converter

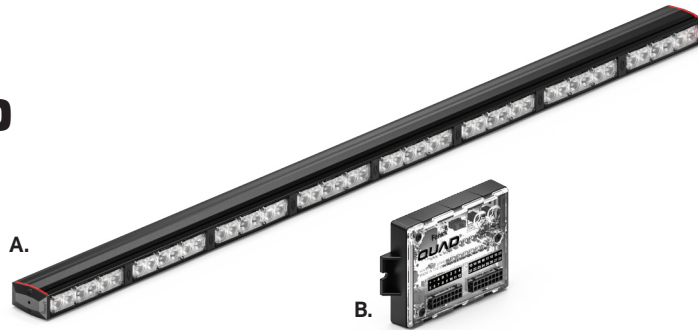

PART NUMBER	DIMENSIONS	VOLTAGE	CURRENT DRAW	LED COLORS
A. FN-0616	1.22" x 37.46" x 2.25"	10-18 V DC	6 Amps	R  B  A  W  G
B. Q-0020	1" x 2.6" x 4.1"	10-18 V DC	1 Amp	

**MOUNTING:**

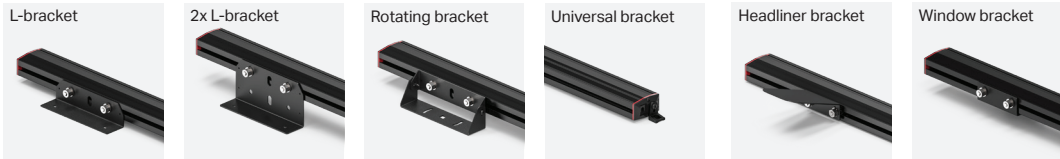

**CERTIFICATIONS:**



**DESCRIPTION:**

The Feniex Fusion-S is the next evolution of the Fusion series. It is the world's brightest and most competitively priced emergency warning line. User configurable in red, blue, amber, white, and green, the Fusion-S offers the user a new and improved 40-degree optic that is 60% brighter than the previous Fusion family. No lighting line can compare to the brightness and light performance of the Fusion-S series.

- Available in Single Colors: R, B, A, W, G
- 4 programmable priority flashing modes
- Syncs with T3, Cannon, Under Mirror Puck and QSM
- Multiple programmable modes:
  - Flood modes
  - Stop, tail & turn signal patterns
  - Cruise mode patterns
  - Traffic advisor modes
  - Cut-off modes
  - California Red option
  - Dim modes
- 48x single color led count
- 15 programmable flash patterns
- Field servicable
- 40° optical light spread for long-range visibility
- 10' cable length



Fusion-S Converter Wires



Military-grade Aluminum



Anti-yellowing & anti-cracking clear-coated polycarbonate Lens



# FUSION-S ROCKER PANELS

- A. Fusion-S Rocker Panels
- B. Quad Converter

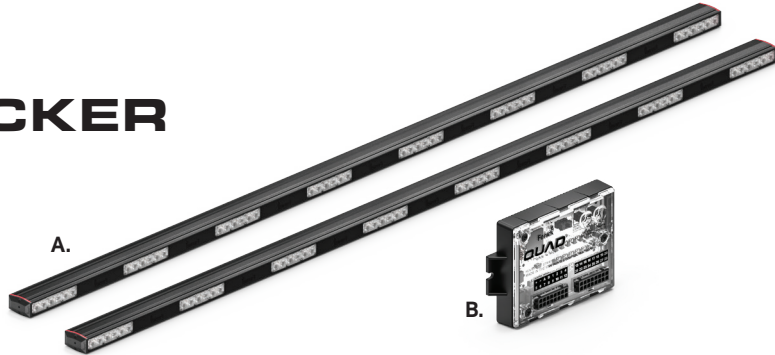

PART NUMBER	DIMENSIONS	VOLTAGE	CURRENT DRAW	LED COLORS
A. FS-8816	1.22" x 64" x 2.25"	10-18 V DC	12 Amps	R B A W G
B. Q-0020	1" x 2.6" x 4.1"	10-18 V DC	1 Amp	

### MOUNTING:

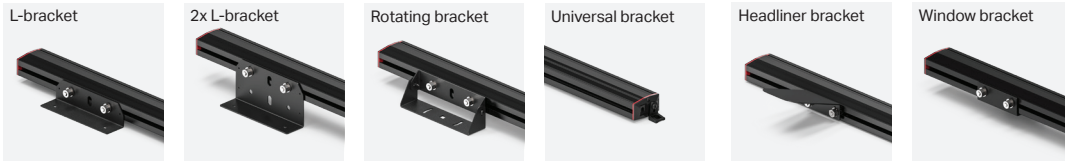

### CERTIFICATIONS:



### DESCRIPTION:

The Feniex Fusion-S is the next evolution of the Fusion series. It is the world's brightest and most competitively priced emergency warning line. User configurable in red, blue, amber, white, and green, the Fusion-S offers the user a new and improved 40-degree optic that is 60% brighter than the previous Fusion family. No lighting line can compare to the brightness and light performance of the Fusion-S series.

- Available in Single Colors: R, B, A, W, G
- 4 programmable priority flashing modes
- Syncs with T3, Cannon, Under Mirror Puck and QSM
- Multiple programmable modes:
  - Flood modes
  - Stop, tail & turn signal patterns
  - Cruise mode patterns
  - Traffic advisor modes
  - Cut-off modes
  - California Red option
  - Dim modes
- 96x single color led count
- 15 programmable flash patterns
- Field servicable
- 40° optical light spread for long-range visibility
- 10' cable length
- Sold in sets of 2



Fusion-S Converter Wires



Military-grade Aluminum



Anti-yellowing & anti-cracking clear-coated polycarbonate Lens





# FUSION-S ARROW LIGHTSTICK

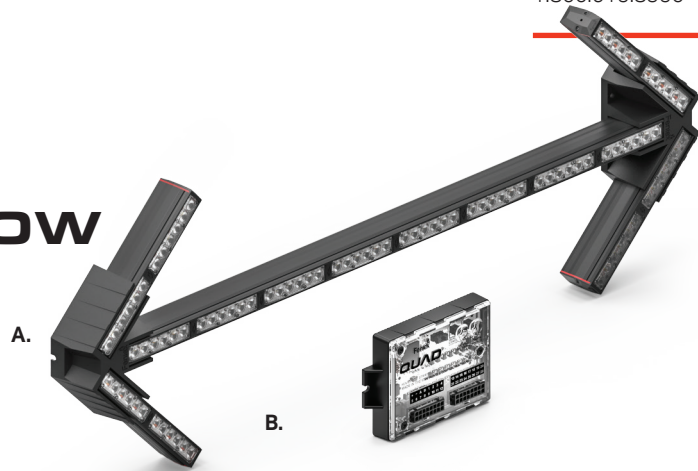

A. Fusion Arrow Board  
B. Quad Converter

PART NUMBER	DIMENSIONS	VOLTAGE	CURRENT DRAW	LED COLORS
A. FS-1016	1.3" x 2.25" x 42.5"	10-18 V DC	8 Amps	R  B  A  W  G
B. Q-0020	1" x 2.6" x 4.1"	10-18 V DC	1 Amp	

### MOUNTING:

Built-in bracket



### CERTIFICATIONS:



### DESCRIPTION:

The Feniex Fusion-S is the next evolution of the Fusion series. It is the world's brightest and most competitively priced emergency warning line. User configurable in red, blue, amber, white, and green, the Fusion-S offers the user a new and improved 40-degree optic that is 60% brighter than the previous Fusion family. No lighting line can compare to the brightness and light performance of the Fusion-S series.

- Available in Single Colors: R, B, A, W, G
- 4 programmable priority flashing modes
- Syncs with T3, Cannon, Under Mirror Puck and QSM
- Multiple programmable modes:
  - Flood modes
  - Stop, tail & turn signal patterns
  - Cruise mode patterns
  - Traffic advisor modes
  - Cut-off modes
  - California Red option
  - Dim modes
- 96x single color led count
- 15 programmable flash patterns
- Field servicable
- 40° optical light spread for long-range visibility
- 10' cable length



Fusion-S Converter Wires



Military-grade Aluminum



Anti-yellowing & anti-cracking clear-coated polycarbonate Lens



# FUSION-S FRONT INTERIOR LIGHTBAR

A. Fusion Front Lightbar  
B. Quad Converter

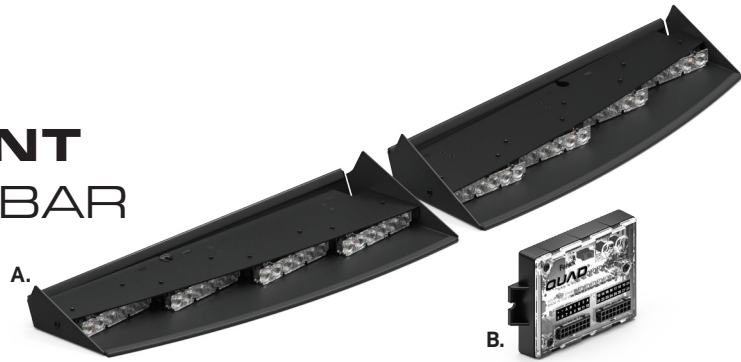

PART NUMBER	DIMENSIONS	VOLTAGE	CURRENT DRAW	LED COLORS
A. FS-****	1.3" x 2.25" x 42.5"	10-18 V DC	6 Amps	R B A W G
B. Q-0020	1" x 2.6" x 4.1"	10-18 V DC	1 Amp	

CERTIFICATIONS:



DESCRIPTION:

The Feniex Fusion-S is the next evolution of the Fusion series. It is the world's brightest and most competitively priced emergency warning line. User configurable in red, blue, white, and green, the Fusion-S offers the user a new and improved 40-degree optic that is 60% brighter than the previous Fusion family. No lighting line can compare to the brightness and light performance of the Fusion-S series.

- Available in Single Colors: R, B, A, W, G
- 3 programmable priority flashing modes
- Multiple programmable modes:
  - Flood modes
  - Stop, tail & turn signal patterns
  - Cruise mode patterns
  - Traffic advisor modes
  - Cut-off modes
  - California Red option
  - Dim modes
- 48x single color led count
- 15 programmable flash patterns
- Field servicable
- 40° optical light spread for long-range visibility
- 10' cable length



Fusion-S Converter Wires



Military-grade Aluminum



Anti-yellowing & anti-cracking clear-coated polycarbonate Lens



# FUSION-S REAR INTERIOR LIGHTBAR

- A. Fusion Rear Lightbar
- B. Quad Converter

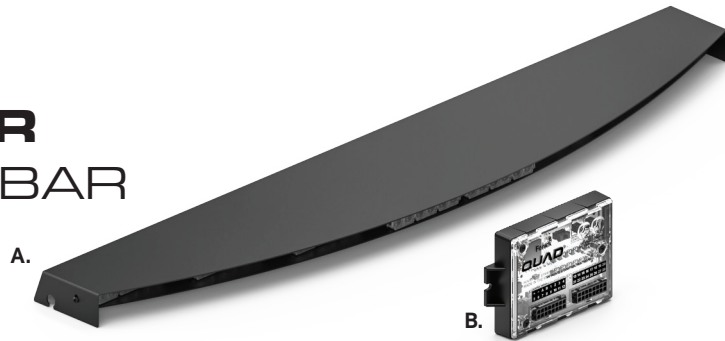

PART NUMBER	DIMENSIONS	VOLTAGE	CURRENT DRAW	LED COLORS
A. FS-2811	1" x 2.25" x 37.5"	10-18 V DC	5 Amps	R B A W G

CERTIFICATIONS:



DESCRIPTION:

The Feniex Fusion-S is the next evolution of the Fusion series. It is the world's brightest and most competitively priced emergency warning line. User configurable in red, blue, amber, white, and green, the Fusion-S offers the user a new and improved 40-degree optic that is 60% brighter than the previous Fusion family. No lighting line can compare to the brightness and light performance of the Fusion-S series.

- Available in Single Colors: R, B, A, W, G
- 3 programmable priority flashing modes
- Multiple programmable modes:
  - Flood modes
  - Stop, tail & turn signal patterns
  - Cruise mode patterns
  - Traffic advisor modes
  - Cut-off modes
  - California Red option
  - Dim modes
- 48x single color led count
- 15 programmable flash patterns
- Field servicable
- 40° optical light spread for long-range visibility
- 10' cable length



Fusion-S Converter Wires



Military-grade Aluminum



Anti-yellowing & anti-cracking clear-coated polycarbonate Lens



# FUSION-S 1X DASH LIGHT

A. Fusion 1X Dash Light



PART NUMBER	DIMENSIONS	VOLTAGE	CURRENT DRAW	LED COLORS
A. FS-1116	1.72" x 9.71" x 4.97"	10-18 V DC	1 Amp	R  B  A  W  G

**MOUNTING:**

Permanent 3M Tape



**CERTIFICATIONS:**



**DESCRIPTION:**

The Feniex Fusion-S is the next evolution of the Fusion series. It is the world's brightest and most competitively priced emergency warning line. User configurable in red, blue, amber, white, and green, the Fusion-S offers the user a new and improved 40-degree optic that is 60% brighter than the previous Fusion family. No lighting line can compare to the brightness and light performance of the Fusion-S series.

- Available in Single Colors: R, B, A, W, G
- 40° optical light spread for long-range visibility
- 2 programmable modes
- Syncs with T3, Cannon, Under Mirror Puck and QSM
- Built-in shield prevents flashback
- 8' cable length
- 6x single color led count
- Multiple modes capabilities:
  - Flood mode patterns
  - Stop, tail & turn signal patterns
  - Cruise mode patterns
- Shipped with 2 mounting options: suction-cup and 3m permanent tape



Fusion-S Wire Harness



Military-grade Aluminum



Anti-yellowing & anti-cracking clear-coated polycarbonate Lens

FLASH PATTERN CHANGER

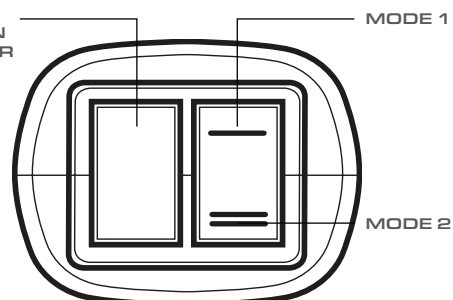





# FUSION-S 2X DASH LIGHT

A. Fusion 2X Dash Light



PART NUMBER	DIMENSIONS	VOLTAGE	CURRENT DRAW	LED COLORS
A. FS-2116	1.73" x 13.8" x 5.21"	10-18 V DC	1.5 Amps	R  B  A  W  G

**MOUNTING:**

Permanent 3M Tape



**CERTIFICATIONS:**



**DESCRIPTION:**

The Feniex Fusion-S is the next evolution of the Fusion series. It is the world's brightest and most competitively priced emergency warning line. User configurable in red, blue, amber, white, and green, the Fusion-S offers the user a new and improved 40-degree optic that is 60% brighter than the previous Fusion family. No lighting line can compare to the brightness and light performance of the Fusion-S series.

- Available in Single Colors: R, B, A, W, G
- 40° optical light spread for long-range visibility
- 2 programmable modes
- Syncs with T3, Cannon, Under Mirror Puck and QSM
- Built-in shield prevents flashback
- 8' cable length
- 12x single color led count
- Multiple modes capabilities:
  - Flood mode patterns
  - Stop, tail & turn signal patterns
  - Cruise mode patterns
- Shipped with 2 mounting options: suction-cup and 3m permanent tape



Fusion-S Wire Harness



Military-grade Aluminum



Anti-yellowing & anti-cracking clear-coated polycarbonate Lens

FLASH PATTERN CHANGER

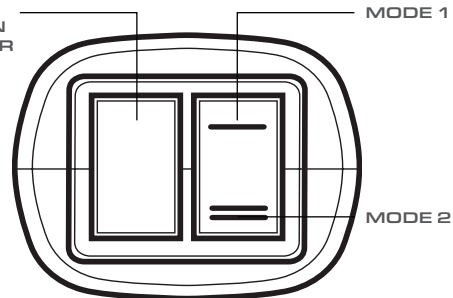



# FUSION-S MIRROR

A. Fusion-S Mirror



PART NUMBER	DIMENSIONS	VOLTAGE	CURRENT DRAW	LED COLORS
A. FS-*****	N/A	10-18 V DC	1.5 Amps	R  B  A  W  G

CERTIFICATIONS:



DESCRIPTION:

The Feniex Fusion-S is the next evolution of the Fusion series. It is the world’s brightest and most competitively priced emergency warning line. User configurable in red, blue, amber, white, and green, the Fusion-S offers the user a new and improved 40-degree optic that is 60% brighter than the previous Fusion family. No lighting line can compare to the brightness and light performance of the Fusion-S series.

- Available in Single Colors: R, B, A, W, G
- 40° optical light spread for long-range visibility
- 3 programmable modes
- Syncs with T3, Cannon, Under Mirror Puck and QSM
- Multiple modes capabilities:
  - Flood mode patterns
  - Stop, tail & turn signal patterns
  - Cruise mode patterns
- 12x single color led count
- Series supports 5+ vehicle makes & models
- Vehicle-specific vacuum-formed housing
- 2 lights total: 1 on each side



Fusion Wire Harness



Military-grade Aluminum



Anti-yellowing & anti-cracking clear-coated polycarbonate Lens



# Fusion® S Pillar

Perimeter Mount

Feniex Industries, Inc.  
1.800.615.8350

## FUSION-S PILLAR

A. Fusion-S Pillar

A.



PART NUMBER	DIMENSIONS	VOLTAGE	CURRENT DRAW	LED COLORS
A. FS-*****	N/A	10-18 V DC	5 Amps	R  B  A  W  G

### CERTIFICATIONS:



### DESCRIPTION:

The Feniex Fusion-S is the next evolution of the Fusion series. It is the world's brightest and most competitively priced emergency warning line. User configurable in red, blue, amber, white, and green, the Fusion-S offers the user a new and improved 40-degree optic that is 60% brighter than the previous Fusion family. No lighting line can compare to the brightness and light performance of the Fusion-S series.

- Available in Single Colors: R, B, A, W, G
- 40° optical light spread for long-range visibility
- 3 programmable modes
- Syncs with T3, Cannon, Under Mirror Puck and QSM
- Multiple modes capabilities:
  - Flood mode patterns
  - Stop, tail & turn signal patterns
  - Cruise mode patterns
- 36x single color led count
- Series supports 2+ vehicle makes & models
- Vehicle-specific vacuum-formed housing
- 6 lights total: 3 on each side



Fusion Wire Harness



Military-grade Aluminum



Anti-yellowing & anti-cracking clear-coated polycarbonate Lens



# FUSION-S SPOILER

A. Fusion-S Pillar



PART NUMBER	DIMENSIONS	VOLTAGE	CURRENT DRAW	LED COLORS
A. FS-*****	N/A	10-18 V DC	5 Amps	R  B  A  W  G

CERTIFICATIONS:



DESCRIPTION:

The Feniex Fusion-S is the next evolution of the Fusion series. It is the world's brightest and most competitively priced emergency warning line. User configurable in red, blue, amber, white, and green, the Fusion-S offers the user a new and improved 40-degree optic that is 60% brighter than the previous Fusion family. No lighting line can compare to the brightness and light performance of the Fusion-S series.

- Available in Single Colors: R, B, A, W, G
- 40° optical light spread for long-range visibility
- 3 programmable modes
- Syncs with T3, Cannon, Under Mirror Puck and QSM
- Multiple modes capabilities:
  - Flood mode patterns
  - Stop, tail & turn signal patterns
  - Cruise mode patterns
- 36x single color led count
- Series supports 5+ vehicle makes & models
- Vehicle-specific vacuum-formed housing
- 6 lights total: 3 on each side



Fusion Wire Harness



Military-grade Aluminum



Anti-yellowing & anti-cracking clear-coated polycarbonate Lens





Quad®

Portfolio

Feniex Industries, Inc.  
1.800.615.8350

# QUAD®

ONE 4 ALL

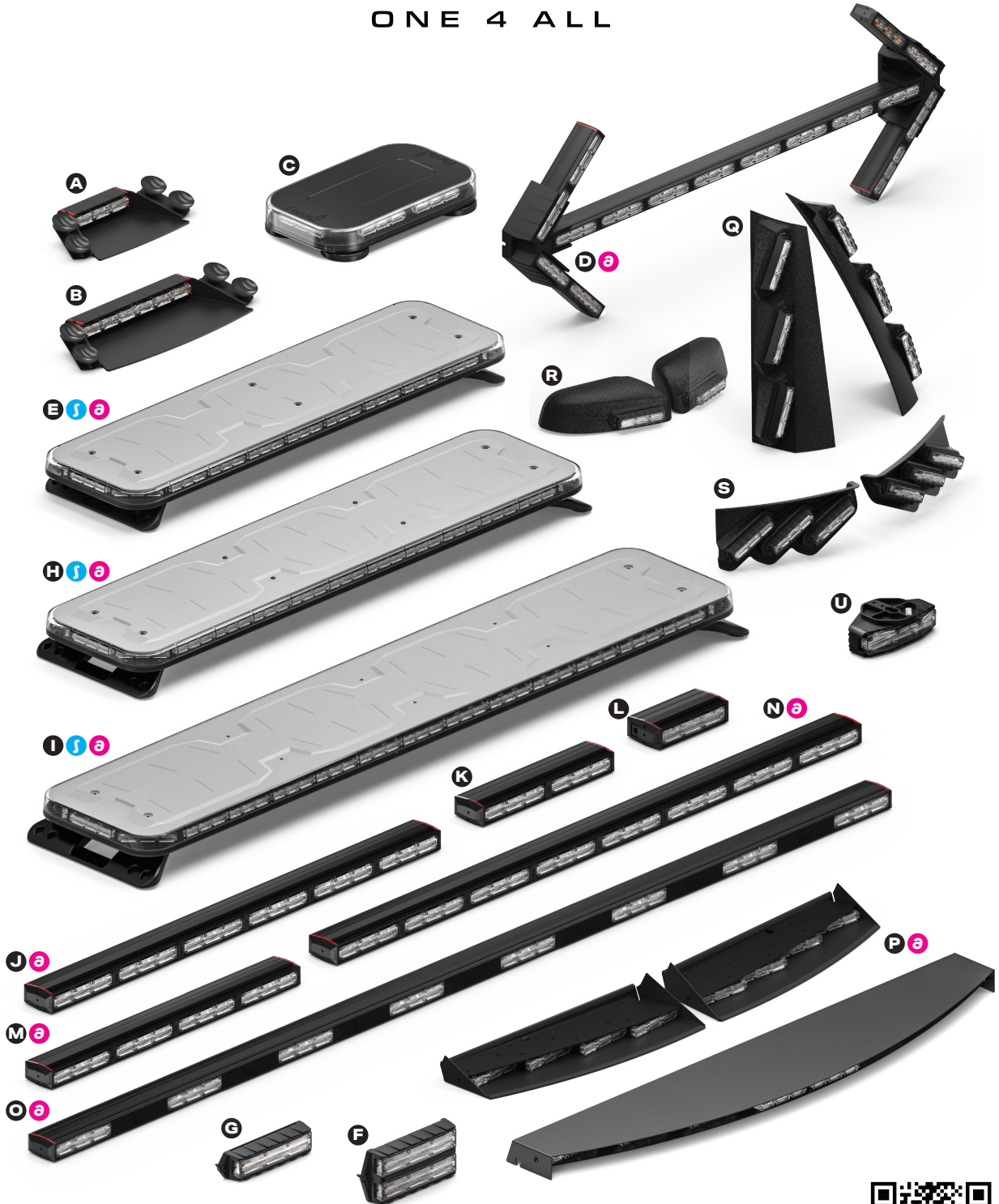

Feniex Product Guide  
[sales@feniex.com](mailto:sales@feniex.com)



PRODUCT		DIMENSIONS	VOLTAGE	CURRENT DRAW	SYNC	WIRE
A. 1X Dash Light	Ⓛ	1.7" x 4.97" x 9.71"	10-18 V DC	1 Amp	Ⓡ	Cig Plug
B. 2X Dash Light	Ⓛ	1.7" x 4.97" x 13.8"	10-18 V DC	1.5 Amps	Ⓡ	Cig Plug
C. Mini Lightbar	Ⓛ	2.3" x 8.1" x 13.94"	10-18 V DC	5 Amps	Ⓡ	Cig Plug
D. Arrow Board	ⓐ	1.3" x 2.25" x 42.5"	10-18 V DC	8 Amps		4 Pin
M. 400 Lightstick	ⓐ	1.3" x 2.25" x 18.8"	10-18 V DC	4 Amps		4 Pin
J. 600 Light Stick	ⓐ	1.3" x 2.25" x 28.1"	10-18 V DC	5 Amps		4 Pin
N. 800 Light Stick	ⓐ	1.3" x 2.25" x 37.5"	10-18 V DC	6 Amps		4 Pin
O. Rocker Panels	ⓐ	1.3" x 2.25" x 64.4"	10-18 V DC	12 Amps		4 Pin
T. Interior Lightbars	ⓐ	N/A	10-18 V DC	6 Amps		4 Pin
E. 44" Lightbar	Ⓡ ⓐ	1.6" x 11.8" x 44.5"	10-18 V DC	15 Amps		4 Pin
H. 49" Lightbar	Ⓡ ⓐ	1.6" x 11.8" x 49.2"	10-18 V DC	16 Amps		4 Pin
I. 60" Lightbar	Ⓡ ⓐ	1.6" x 11.8" x 59.8"	10-18 V DC	18 Amps		4 Pin
F. Surface Mount	Ⓢ	0.88" x 1.7" x 5.22"	10-18 V DC	1 Amp	Ⓡ	6 Pin
G. Dual Stack	Ⓢ	1.8" x 1.7" x 5.22"	10-18 V DC	2 Amps	Ⓡ	6 Pin
K. 200 Light Stick	Ⓢ	1.3" x 2.25" x 9.5"	10-18 V DC	1.5 Amps	Ⓡ	6 Pin
L. 100 Light Stick	Ⓢ	1.3" x 2.25" x 4.8"	10-18 V DC	1 Amp	Ⓡ	6 Pin
Q. Pillar Mount	Ⓢ	N/A	10-18 V DC	5 Amps	Ⓡ	6 Pin
R. Mirror Mount	Ⓢ	N/A	10-18 V DC	1.5 Amps	Ⓡ	6 Pin
S. Spoiler Mount	Ⓢ	N/A	10-18 V DC	5 Amps	Ⓡ	6 Pin
U. Under Mirror Puck	Ⓢ	4.5" x 1.375" x 2.5"	10-18 V DC	1.5 Amps	Ⓡ	6 Pin

**Product Locations**

Use the diagram below to see which products have specific mounting locations.

**Legend**

Use the icons to determine the wiring harness for the products.

- Ⓡ CIGARETTE PLUG
- Ⓢ 2 DATA WIRE/REQUIRES QUAD CONVERTER
- Ⓡ 2 DATA WIRE HARNESS COMES WITH QUAD CONVERTER
- ⓐ 3 MODES

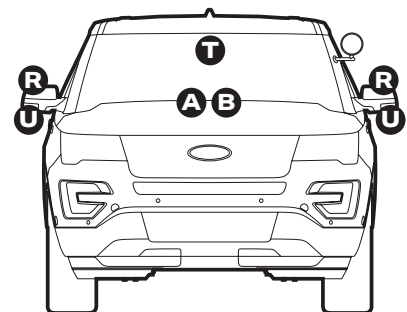
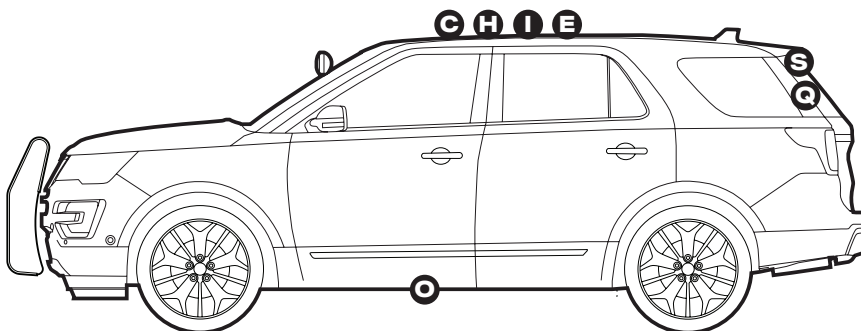



# QUAD 44" LIGHTBAR

A. Quad 44 Lightbar  
B. Quad Converter

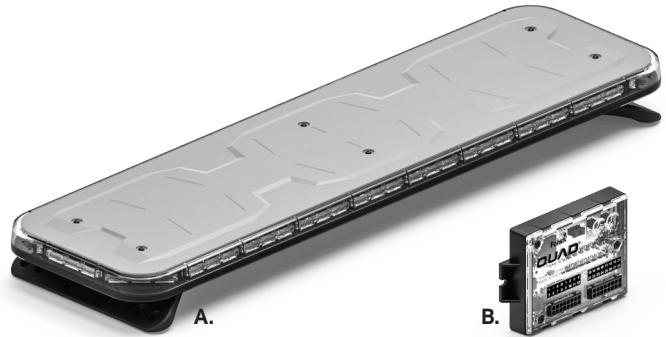

PART NUMBER	DIMENSIONS	VOLTAGE	CURRENT DRAW	LED COLORS
A. Q-4420	1.6" x 11.8" x 44.5"	10-18 V DC	15 Amps	R B A W
B. Q-0020	1" x 2.6" x 4.1"	10-18 V DC	1 Amp	

**MOUNTING:**

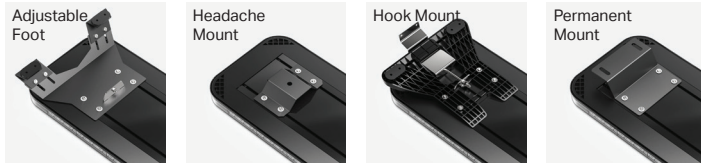

**CERTIFICATIONS:**



**DESCRIPTION:**

The Feniex Quad is the world's first 4-color emergency warning lighting line and the brightest in the industry. User programmable in red, blue, amber and white, the Quad offers endless customization while remaining competitively-priced. At Feniex Industries, we've seen the future. The future is one option for every first responder and construction site and one sku for every fleet manager. The future of safety comes in four colors and covers every application. The future is Quad.

- 15 programmable color settings: *single, dual, tri & quad*
- 15 color programmable rear traffic advisors
- 4 programmable cut-off modes: *front, rear, driver and passenger*
- 15 programmable flash patterns for front and rear flashing
- 4 programmable cruise modes: *driver & passenger*
- 3 programmable DOT functions: *stop, tail & turn*
- 3 programmable brightness levels: *10%, 50% & 100%*
- 4 programmable priority flashing modes: *front & rear*
- Programmable California-red mode: 20 positions
- 528x led count
- Waterproof 3M triple-bubble seal
- Purchase includes Quad Converter
- Field servicable
- Anti-cracking and Anti-yellowing clear-coated polycarbonate lens
- Hook mounts supports 30+ vehicles
- 60° optical light spread



Military-grade Aluminum



Anti-yellowing & anti-cracking clear-coated polycarbonate Lens



# QUAD 49" LIGHTBAR

- A. Quad 49 Lightbar
- B. Quad Converter

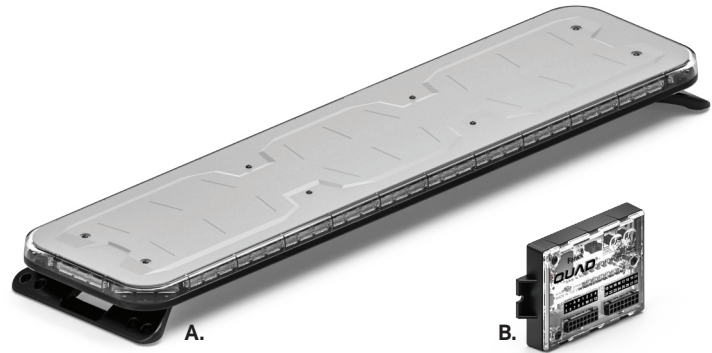

PART NUMBER	DIMENSIONS	VOLTAGE	CURRENT DRAW	LED COLORS
A. Q-4920	1.6" x 11.8" x 49.2"	10-18 V DC	16 Amps	R B A W
B. Q-0020	1" x 2.6" x 4.1"	10-18 V DC	1 Amp	

**MOUNTING:**

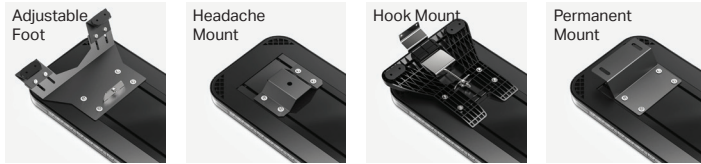

**CERTIFICATIONS:**



**DESCRIPTION:**

The Feniex Quad is the world's first 4-color emergency warning lighting line and the brightest in the industry. User programmable in red, blue, amber and white, the Quad offers endless customization while remaining competitively-priced. At Feniex Industries, we've seen the future. The future is one option for every first responder and construction site and one sku for every fleet manager. The future of safety comes in four colors and covers every application. The future is Quad.

- 15 programmable color settings: *single, dual, tri & quad*
- 15 color programmable rear traffic advisors
- 4 programmable cut-off modes: *front, rear, driver and passenger*
- 15 programmable flash patterns for front and rear flashing
- 4 programmable cruise modes: *driver & passenger*
- 3 programmable DOT functions: *stop, tail & turn*
- 3 programmable brightness levels: *10%, 50% & 100%*
- 4 programmable priority flashing modes: *front & rear*
- Programmable California-red mode: 20 positions
- 624x led count
- Waterproof 3M triple-bubble seal
- Purchase includes Quad Converter
- Field servicable
- Anti-cracking and Anti-yellowing clear-coated polycarbonate lens
- Hook mounts supports 30+ vehicles
- 60° optical light spread



Military-grade Aluminum



Anti-yellowing & anti-cracking clear-coated polycarbonate Lens





# QUAD 60" LIGHTBAR

- A. Quad 60 Lightbar
- B. Quad Converter

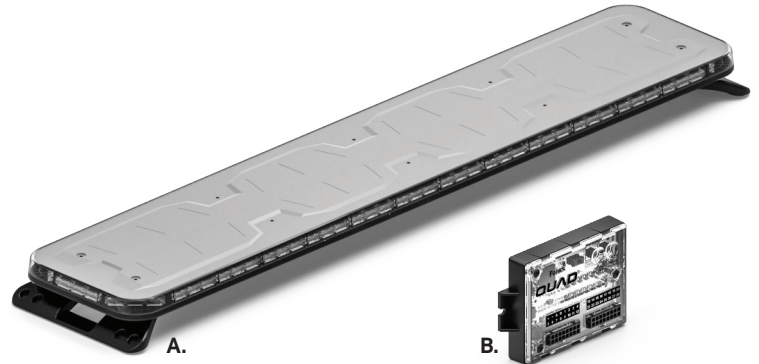

PART NUMBER	DIMENSIONS	VOLTAGE	CURRENT DRAW	LED COLORS
A. Q-6020	1.6" x 11.8" x 59.8"	10-18 V DC	18 Amps	R B A W
B. Q-0020	1" x 2.6" x 4.1"	10-18 V DC	1 Amp	

**MOUNTING:**

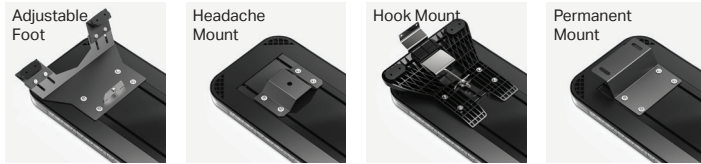

**CERTIFICATIONS:**



**DESCRIPTION:**

The Feniex Quad is the world's first 4-color emergency warning lighting line and the brightest in the industry. User programmable in red, blue, amber and white, the Quad offers endless customization while remaining competitively-priced. At Feniex Industries, we've seen the future. The future is one option for every first responder and construction site and one sku for every fleet manager. The future of safety comes in four colors and covers every application. The future is Quad.

- 15 programmable color settings: *single, dual, tri & quad*
- 15 color programmable rear traffic advisors
- 4 programmable cut-off modes: *front, rear, driver and passenger*
- 15 programmable flash patterns for front and rear flashing
- 4 programmable cruise modes: *driver & passenger*
- 3 programmable DOT functions: *stop, tail & turn*
- 3 programmable brightness levels: *10%, 50% & 100%*
- 4 programmable priority flashing modes: *front & rear*
- Programmable California-red mode: 20 positions
- 720x led count
- Waterproof 3M triple-bubble seal
- Purchase includes Quad Converter
- Field servicable
- Anti-cracking and Anti-yellowing clear-coated polycarbonate lens
- Hook mounts supports 30+ vehicles
- 60° optical light spread



Quad Converter Wires



Military-grade Aluminum



Anti-yellowing & anti-cracking clear-coated polycarbonate Lens



# QUAD MINI LIGHTBAR

A. Quad Mini Lightbar



A.

PART NUMBER	DIMENSIONS	VOLTAGE	CURRENT DRAW	LED COLORS
A. Q-6020	2.3" x 8.1" x 13.94"	10-18 V DC	5 Amps	R B A W

**MOUNTING:**



**CERTIFICATIONS:**



**DESCRIPTION:**

The Feniex Quad is the world's first 4-color emergency warning lighting line and the brightest in the industry. User programmable in red, blue, amber and white, the Quad offers endless customization while remaining competitively-priced. At Feniex Industries, we've seen the future. The future is one option for every first responder and construction site and one sku for every fleet manager. The future of safety comes in four colors and covers every application. The future is Quad.

- 15 programmable color settings: *single, dual, tri & quad*
- Syncs with T3, Cannon, Under Mirror Puck & FSMs
- 2 programmable modes
- Flood and cruise mode pattern capable
- Purchase includes magnetic mount. Permanent mount sold separately
- 60° optical light spread
- Field servicable & plug-in-play connectivity
- Cig-plug with color, pattern and switch modes
- 144x led count
- Waterproof 3M triple-bubble seal



Mini Wire Harness

Weatherproof Polycarbonate Plastic Base

Anti-yellowing & anti-cracking clear-coated polycarbonate Lens

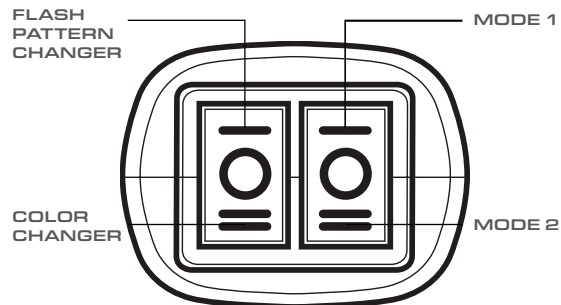



# QUAD 100 LIGHTSTICK

A. Quad 100 Lightstick

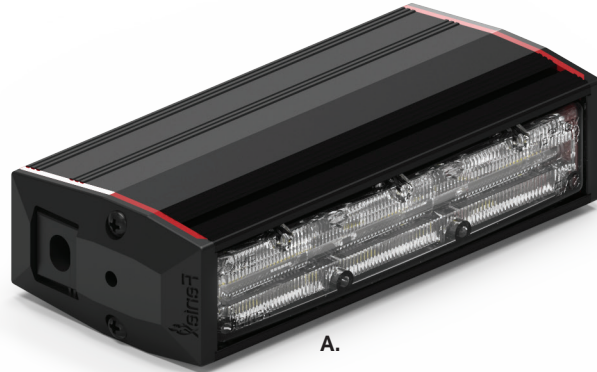

PART NUMBER	DIMENSIONS	VOLTAGE	CURRENT DRAW	LED COLORS
A. Q-0120	1.3" x 2.25" x 4.8"	10-18 V DC	1 Amp	R B A W

**MOUNTING:**

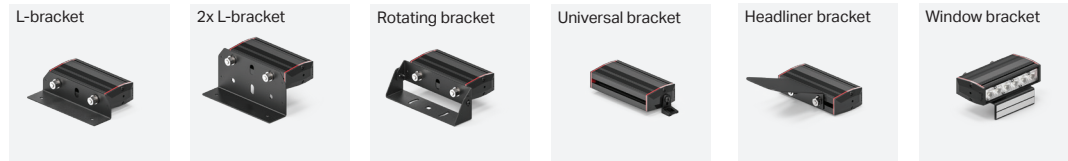

**CERTIFICATIONS:**



**DESCRIPTION:**

The Feniex Quad is the world's first 4-color emergency warning lighting line and the brightest in the industry. User programmable in red, blue, amber and white, the Quad offers endless customization while remaining competitively-priced. At Feniex Industries, we've seen the future. The future is one option for every first responder and construction site and one sku for every fleet manager. The future of safety comes in four colors and covers every application. The future is Quad.

- 15 programmable color settings: *single, dual, tri & quad*
- Syncs with T3, Cannon, Under Mirror Puck & FSMs
- 3 programmable modes
- Flood and cruise mode pattern capable
- Stop, turn and tail pattern capable
- Field servicable & plug-in-play connectivity
- Cig-plug with color, pattern and switch modes
- 24x led count
- Purchase includes Quad 100, 2 bolts, 2 nuts and 2 washers
- 60° optical light spread
- 8' cable length



Military-grade Aluminum



Anti-yellowing & anti-cracking clear-coated polycarbonate Lens



# QUAD 200 LIGHTSTICK

A. Quad 200 Lightstick

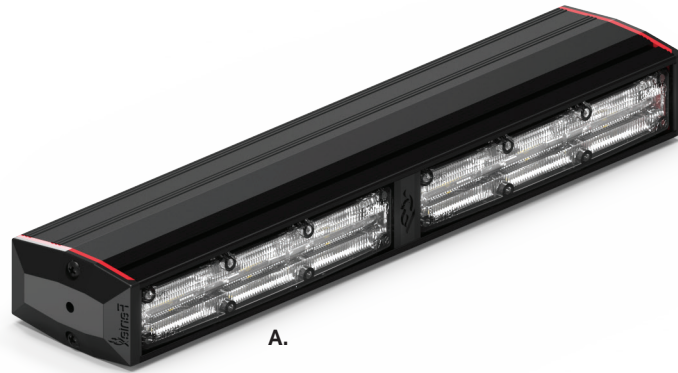

A.

PART NUMBER	DIMENSIONS	VOLTAGE	CURRENT DRAW	LED COLORS
A. Q-0220	1.3" x 2.25" x 9.5"	10-18 V DC	1.5 Amps	R B A W

**MOUNTING:**

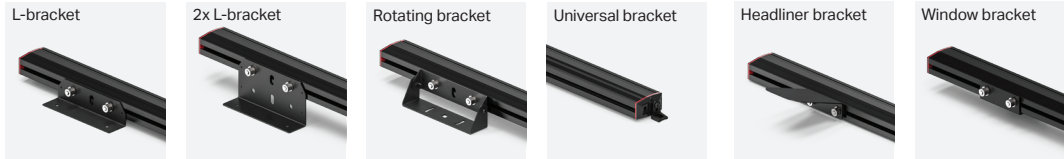

**CERTIFICATIONS:**



**DESCRIPTION:**

The Feniex Quad is the world's first 4-color emergency warning lighting line and the brightest in the industry. User programmable in red, blue, amber and white, the Quad offers endless customization while remaining competitively-priced. At Feniex Industries, we've seen the future. The future is one option for every first responder and construction site and one sku for every fleet manager. The future of safety comes in four colors and covers every application. The future is Quad.

- 15 programmable color settings: *single, dual, tri & quad*
- Syncs with T3, Cannon, Under Mirror Puck & FSMs
- 3 programmable modes
- Flood and cruise mode pattern capable
- Stop, turn and tail pattern capable
- Field servicable & plug-in-play connectivity
- Cig-plug with color, pattern and switch modes
- 48x led count
- Purchase includes Quad 200, 2 bolts, 2 nuts and 2 washers
- 60° optical light spread
- 8' cable length



Military-grade Aluminum



Anti-yellowing & anti-cracking clear-coated polycarbonate Lens



# QUAD 400 LIGHTSTICK

- A. Quad 400 Lightstick
- B. Quad Converter

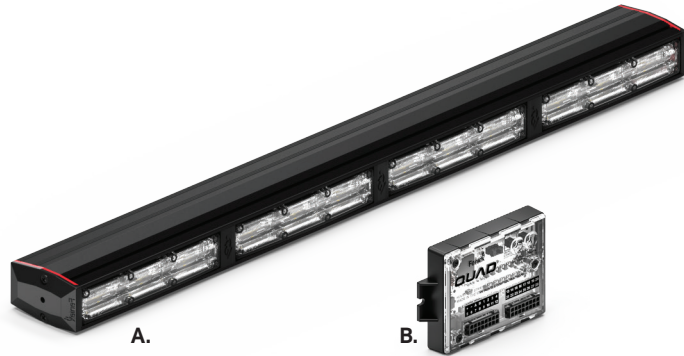

PART NUMBER	DIMENSIONS	VOLTAGE	CURRENT DRAW	LED COLORS
A. Q-0420	1.3" x 2.25" x 18.8"	10-18 V DC	4 Amps	R B A W
B. Q-0020	1" x 2.6" x 4.1"	10-18 V DC	1 Amp	

### MOUNTING:

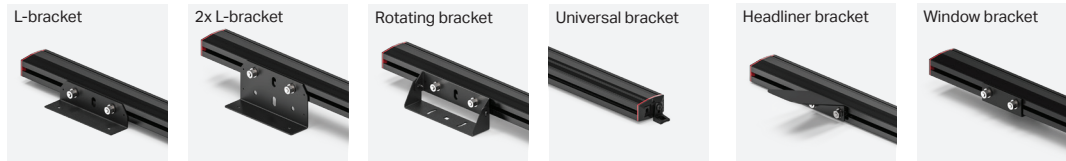

### CERTIFICATIONS:



### DESCRIPTION:

The Feniex Quad is the world's first 4-color emergency warning lighting line and the brightest in the industry. User programmable in red, blue, amber and white, the Quad offers endless customization while remaining competitively-priced. At Feniex Industries, we've seen the future. The future is one option for every first responder and construction site and one sku for every fleet manager. The future of safety comes in four colors and covers every application. The future is Quad.

- 15 programmable color settings: *single, dual, tri & quad*
- Programmable traffic advisor: *left, right and center-out*
- 4 programmable cut-off modes: *front, rear, driver and passenger*
- 15 programmable flash patterns
- 4 programmable cruise mode
- 3 programmable DOT functions: *stop, tail & turn*
- 3 programmable brightness levels: *10%, 50% & 100%*
- 4 programmable priority flashing modes
- Programmable California-red mode: 20 positions
- Built-in user programmable cut-off and flood modes
- 96x led count
- Purchase includes Quad 400, 2 bolts, 2 nuts and 2 washers
- 60° optical light spread
- 10' cable length
- Requires a Quad Converter. Not included with purchase



Military-grade Aluminum



Anti-yellowing & anti-cracking clear-coated polycarbonate Lens





# QUAD 600 LIGHTSTICK

A. Quad 600 Lightstick  
B. Quad Converter

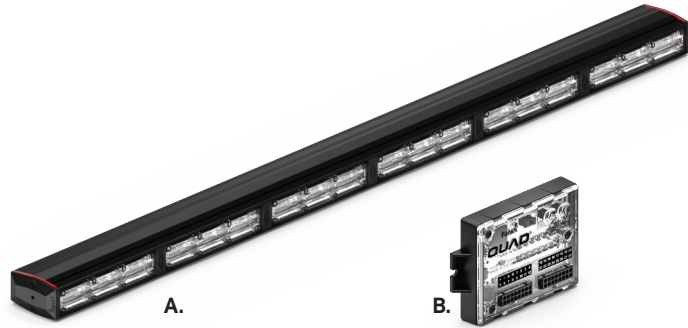

PART NUMBER	DIMENSIONS	VOLTAGE	CURRENT DRAW	LED COLORS
A. Q-0620	1.3" x 2.25" x 28.1"	10-18 V DC	5 Amps	R B A W
B. Q-0020	1" x 2.6" x 4.1"	10-18 V DC	1 Amp	

**MOUNTING:**

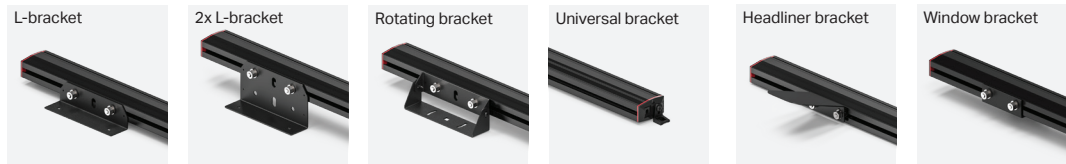

**CERTIFICATIONS:**



**DESCRIPTION:**

The Feniex Quad is the world's first 4-color emergency warning lighting line and the brightest in the industry. User programmable in red, blue, amber and white, the Quad offers endless customization while remaining competitively-priced. At Feniex Industries, we've seen the future. The future is one option for every first responder and construction site and one sku for every fleet manager. The future of safety comes in four colors and covers every application. The future is Quad.

- 15 programmable color settings: *single, dual, tri & quad*
- Programmable traffic advisor: *left, right and center-out*
- 4 programmable cut-off modes: *front, rear, driver and passenger*
- 15 programmable flash patterns
- 4 programmable cruise mode
- 3 programmable DOT functions: *stop, tail & turn*
- 3 programmable brightness levels: *10%, 50% & 100%*
- 4 programmable priority flashing modes
- Programmable California-red mode: 20 positions
- Built-in user programmable cut-off and flood modes
- 144x led count
- Purchase includes Quad 600, 2 bolts, 2 nuts and 2 washers
- 60° optical light spread
- 10' cable length
- Requires a Quad Converter. Not included with purchase

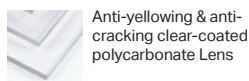



# QUAD 800 LIGHTSTICK

A. Quad 800 Lightstick  
B. Quad Converter

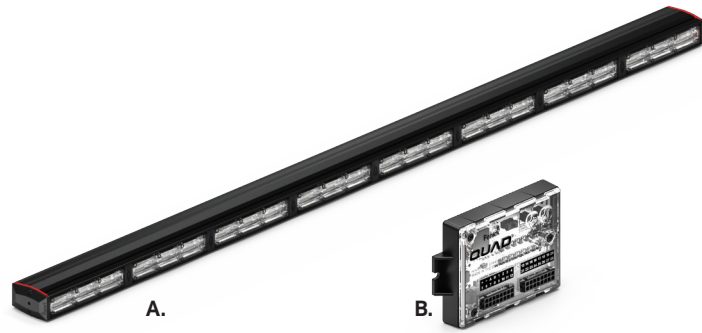

PART NUMBER	DIMENSIONS	VOLTAGE	CURRENT DRAW	LED COLORS
A. Q-0820	1.3" x 2.25" x 37.5"	10-18 V DC	6 Amps	R B A W
B. Q-0020	1" x 2.6" x 4.1"	10-18 V DC	1 Amp	

### MOUNTING:

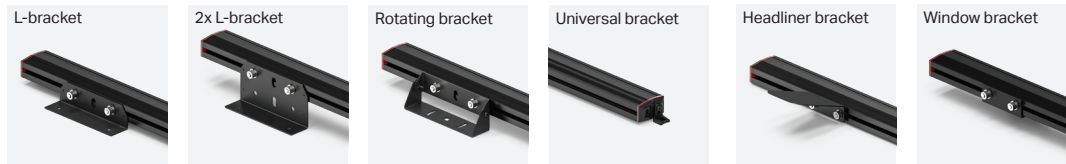

### CERTIFICATIONS:



### DESCRIPTION:

The Feniex Quad is the world's first 4-color emergency warning lighting line and the brightest in the industry. User programmable in red, blue, amber and white, the Quad offers endless customization while remaining competitively-priced. At Feniex Industries, we've seen the future. The future is one option for every first responder and construction site and one sku for every fleet manager. The future of safety comes in four colors and covers every application. The future is Quad.

- 15 programmable color settings: *single, dual, tri & quad*
- Programmable traffic advisor: *left, right and center-out*
- 4 programmable cut-off modes: *front, rear, driver and passenger*
- 15 programmable flash patterns
- 4 programmable cruise mode
- 3 programmable DOT functions: *stop, tail & turn*
- 3 programmable brightness levels: *10%, 50% & 100%*
- 4 programmable priority flashing modes
- Programmable California-red mode: 20 positions
- Built-in user programmable cut-off and flood modes
- 192x led count
- Purchase includes Quad 800, 2 bolts, 2 nuts and 2 washers
- 60° optical light spread
- 10' cable length
- Requires a Quad Converter. Not included with purchase



Military-grade Aluminum

Anti-yellowing & anti-cracking clear-coated polycarbonate Lens



# QUAD ROCKERS LIGHTSTICK

A. Quad Rocker Panels  
B. Quad Converter

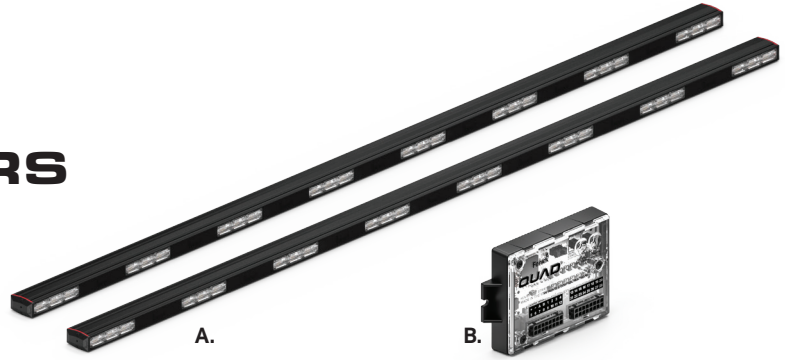

PART NUMBER	DIMENSIONS	VOLTAGE	CURRENT DRAW	LED COLORS
A. Q-8820	1.3" x 2.25" x 64.4"	10-18 V DC	12 Amps	R  B  A  W
B. Q-0020	1" x 2.6" x 4.1"	10-18 V DC	1 Amp	

### MOUNTING:

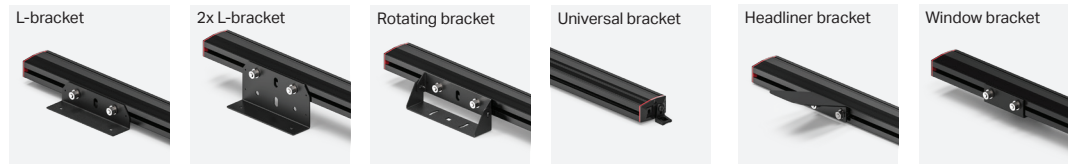

### CERTIFICATIONS:



### DESCRIPTION:

The Feniex Quad is the world's first 4-color emergency warning lighting line and the brightest in the industry. User programmable in red, blue, amber and white, the Quad offers endless customization while remaining competitively-priced. At Feniex Industries, we've seen the future. The future is one option for every first responder and construction site and one sku for every fleet manager. The future of safety comes in four colors and covers every application. The future is Quad.

- 15 programmable color settings: *single, dual, tri & quad*
- Programmable traffic advisor: *left, right and center-out*
- 4 programmable cut-off modes: *front, rear, driver and passenger*
- 15 programmable flash patterns
- 4 programmable cruise mode
- 3 programmable DOT functions: *stop, tail & turn*
- 3 programmable brightness levels: *10%, 50% & 100%*
- 4 programmable priority flashing modes
- Programmable California-red mode: 20 positions
- Built-in user programmable cut-off and flood modes
- 432x led count
- Purchase includes 2 Quad Rocker Panels, 2 bolts, 2 nuts and 2 washers
- 60° optical light spread
- 10' cable length
- Requires a Quad Converter. Not included with purchase



Military-grade Aluminum

Anti-yellowing & anti-cracking clear-coated polycarbonate Lens

Quad Converter Wires



# QUAD ARROW LIGHTSTICK

- A. Quad Arrow Board
- B. Quad Converter



PART NUMBER	DIMENSIONS	VOLTAGE	CURRENT DRAW	LED COLORS
A. Q-1020	1.3" x 2.25" x 42.5"	10-18 V DC	8 Amps	R B A W
B. Q-0020	1" x 2.6" x 4.1"	10-18 V DC	1 Amp	

**MOUNTING:**

Built-in mounting



**CERTIFICATIONS:**



**DESCRIPTION:**

The Feniex Quad is the world's first 4-color emergency warning lighting line and the brightest in the industry. User programmable in red, blue, amber and white, the Quad offers endless customization while remaining competitively-priced. At Feniex Industries, we've seen the future. The future is one option for every first responder and construction site and one sku for every fleet manager. The future of safety comes in four colors and covers every application. The future is Quad.

- 15 programmable color settings: *single, dual, tri & quad*
- Programmable traffic advisor: *left, right and center-out*
- 4 programmable cut-off modes: *front, rear, driver and passenger*
- 15 programmable flash patterns
- 4 programmable cruise mode
- 3 programmable DOT functions: *stop, tail & turn*
- 3 programmable brightness levels: *10%, 50% & 100%*
- 4 programmable priority flashing modes
- Programmable California-red mode: 20 positions
- Built-in user programmable cut-off and flood modes
- 384x led count
- 60° optical light spread
- 10' cable length
- Requires a Quad Converter. Not included with purchase
- Field servicable & plug-in-play connectivity



Quad Converter Wires



Military-grade Aluminum



Anti-yellowing & anti-cracking clear-coated polycarbonate Lens



# QUAD FRONT LIGHTBAR

A. Quad Front Interior  
B. Quad Converter

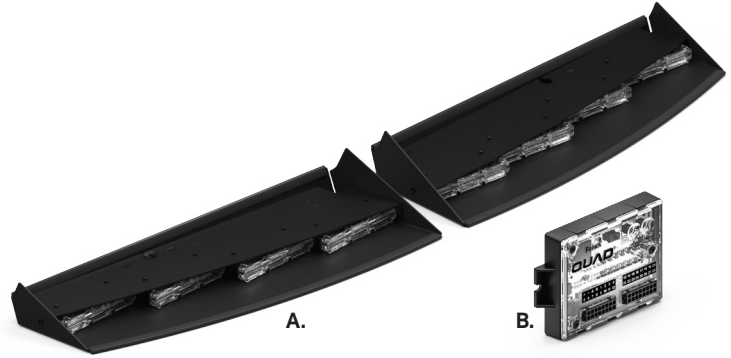

PART NUMBER	DIMENSIONS	VOLTAGE	CURRENT DRAW	LED COLORS
A. Q-****	1" x 2.25" x 37.5"	10-18 V DC	6 Amps	R B A W
B. Q-0020	1" x 2.6" x 4.1"	10-18 V DC	1 Amp	

CERTIFICATIONS:



DESCRIPTION:

The Feniex Quad is the world's first 4-color emergency warning lighting line and the brightest in the industry. User programmable in red, blue, amber and white, the Quad offers endless customization while remaining competitively-priced. At Feniex Industries, we've seen the future. The future is one option for every first responder and construction site and one sku for every fleet manager. The future of safety comes in four colors and covers every application. The future is Quad.

- 15 programmable color settings: *single, dual, tri & quad*
- 4 programmable cut-off modes: *front, rear, driver and passenger*
- 15 programmable flash patterns
- 4 programmable cruise mode
- 3 programmable DOT functions: *stop, tail & turn*
- 3 programmable brightness levels: *10%, 50% & 100%*
- 4 programmable priority flashing modes
- Programmable California-red mode: 20 positions
- Built-in user programmable cut-off and flood modes
- Front lightbar supports 50+ vehicle makes & models
- 192x led count
- 60° optical light spread
- 10' cable length
- Requires a Quad Converter. Not included with purchase
- Field servicable & plug-in-play connectivity



Quad Converter Wires



Military-grade Aluminum



Anti-yellowing & anti-cracking clear-coated polycarbonate Lens





# QUAD REAR LIGHTBAR

A. Quad Front Interior  
B. Quad Converter

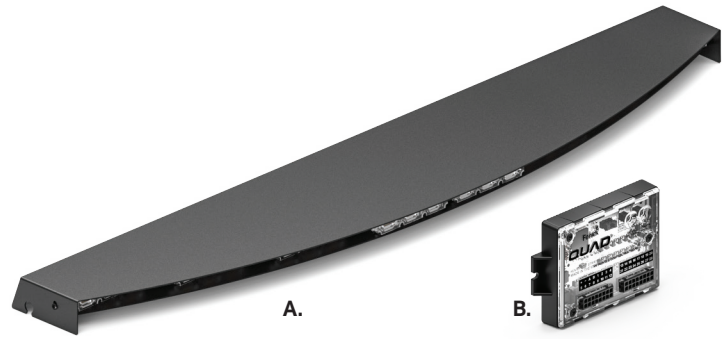

PART NUMBER	DIMENSIONS	VOLTAGE	CURRENT DRAW	LED COLORS
A. Q-****	1" x 2.25" x 37.5"	10-18 V DC	6 Amps	R B A W
B. Q-0020	1" x 2.6" x 4.1"	10-18 V DC	1 Amp	

**MOUNTING:**

**CERTIFICATIONS:**



**DESCRIPTION:**

The Feniex Quad is the world's first 4-color emergency warning lighting line and the brightest in the industry. User programmable in red, blue, amber and white, the Quad offers endless customization while remaining competitively-priced. At Feniex Industries, we've seen the future. The future is one option for every first responder and construction site and one sku for every fleet manager. The future of safety comes in four colors and covers every application. The future is Quad.

- 15 programmable color settings: *single, dual, tri & quad*
- 4 programmable cut-off modes: *front, rear, driver and passenger*
- Programmable traffic advisor: *left, right & center-out*
- 15 programmable flash patterns
- 4 programmable cruise mode
- 3 programmable DOT functions: *stop, tail & turn*
- 3 programmable brightness levels: *10%, 50% & 100%*
- 4 programmable priority flashing modes
- Programmable California-red mode: 20 positions
- Built-in user programmable cut-off and flood modes
- Rear lightbar supports 5+ vehicle makes & models
- 192x led count
- 60° optical light spread
- 10' cable length
- Requires a Quad Converter. Not included with purchase
- Field servicable & plug-in-play connectivity



Quad Converter Wires



Military-grade Aluminum



Anti-yellowing & anti-cracking clear-coated polycarbonate Lens



Quad® 1X

Interior  
Lightars

Feniex Industries, Inc.  
1.800.615.8350

# QUAD 1X DASH LIGHT

A. Quad 1X Dash Light

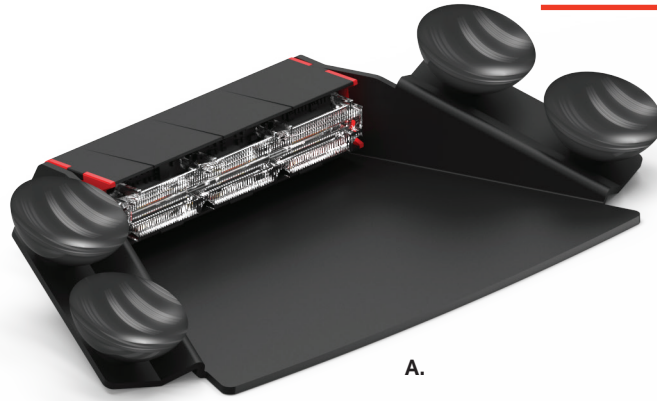

A.

PART NUMBER	DIMENSIONS	VOLTAGE	CURRENT DRAW	LED COLORS
A. Q-1120	1.7" x 4.97" x 9.71"	10-18 V DC	1 Amp	R B A W

### MOUNTING:

Permanent 3M Tape



### CERTIFICATIONS:



### DESCRIPTION:

The Feniex Quad is the world's first 4-color emergency warning lighting line and the brightest in the industry. User programmable in red, blue, amber and white, the Quad offers endless customization while remaining competitively-priced. At Feniex Industries, we've seen the future. The future is one option for every first responder and construction site and one sku for every fleet manager. The future of safety comes in four colors and covers every application. The future is Quad.

- 15 programmable color settings: *single, dual, tri & quad*
- 2-user programmable modes
- Flood mode pattern capable
- Cruise mode pattern capable
- Stop, turn & tail pattern capable
- Built-in shield to protect against flash back
- Syncs with T3, Cannon, Under Mirror Puck & FSMs
- Cig plug with color, pattern & mode switches
- 24x led count
- 60° optical light spread
- 8' cable length
- Field servicable & plug-in-play connectivity



1X  
Wire  
Harness



Military-grade  
Aluminum



Anti-yellowing & anti-cracking  
clear-coated  
polycarbonate Lens

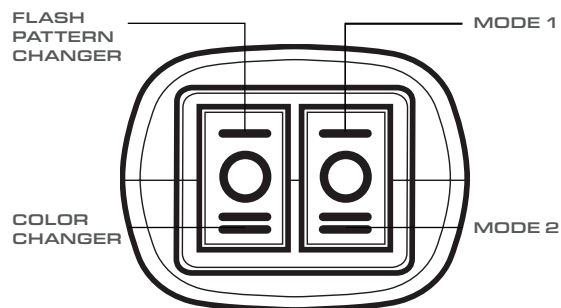



Quad® 2X

Interior  
Lightars

Feniex Industries, Inc.  
1.800.615.8350

# QUAD 2X DASH LIGHT

A. Quad 2X Dash Light

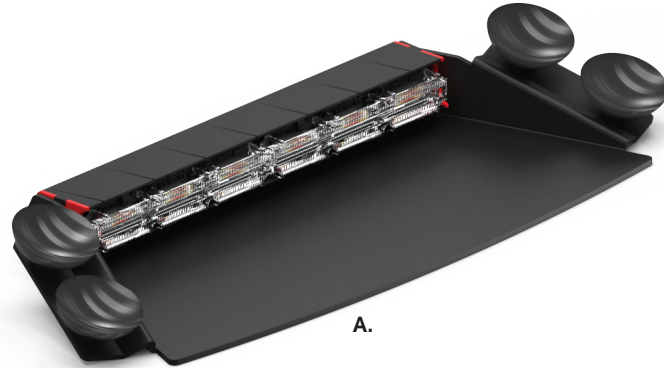

PART NUMBER	DIMENSIONS	VOLTAGE	CURRENT DRAW	LED COLORS
A. Q-2120	1.7" x 4.97" x 13.8"	10-18 V DC	1.5 Amps	R B A W

**MOUNTING:**

Permanent 3M Tape



**CERTIFICATIONS:**



**DESCRIPTION:**

The Feniex Quad is the world's first 4-color emergency warning lighting line and the brightest in the industry. User programmable in red, blue, amber and white, the Quad offers endless customization while remaining competitively-priced. At Feniex Industries, we've seen the future. The future is one option for every first responder and construction site and one sku for every fleet manager. The future of safety comes in four colors and covers every application. The future is Quad.

- 15 programmable color settings: *single, dual, tri & quad*
- 2-user programmable modes
- Flood mode pattern capable
- Cruise mode pattern capable
- Stop, turn & tail pattern capable
- Built-in shield to protect against flash back
- Syncs with T3, Cannon, Under Mirror Puck & FSMs
- Cig plug with color, pattern & mode switches
- 48x led count
- 60° optical light spread
- 8' cable length
- Field servicable & plug-in-play connectivity



200  
Wire  
Harness



Military-grade  
Aluminum



Anti-yellowing & anti-cracking clear-coated polycarbonate Lens

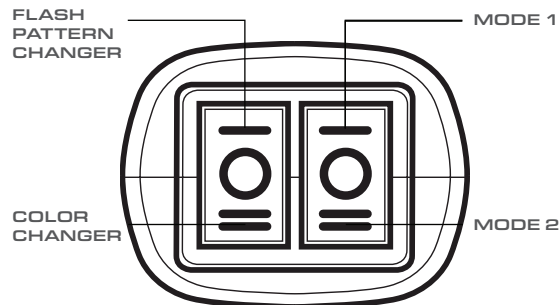



# QUAD SURFACE MOUNT



A.

A. Quad Surface Mount



PART NUMBER	DIMENSIONS	VOLTAGE	CURRENT DRAW	LED COLORS
A. QSM-8101	0.88" x 1.7" x 5.22"	10-18 V DC	1 Amp	R B A W

**MOUNTING:**



**VEHICLE SPECIFIC:**



**CERTIFICATIONS:**



**DESCRIPTION:**

The Feniex Quad is the world's first 4-color emergency warning lighting line and the brightest in the industry. User programmable in red, blue, amber and white, the Quad offers endless customization while remaining competitively-priced. At Feniex Industries, we've seen the future. The future is one option for every first responder and construction site and one sku for every fleet manager. The future of safety comes in four colors and covers every application. The future is Quad.

- 15 programmable color settings: *single, dual, tri & quad*
- Syncs with T3, Cannon, Under Mirror Puck & FSMs
- 3 programmable modes
- Flood and cruise mode pattern capable
- Stop, turn and tail pattern capable
- Field servicable & plug-in-play connectivity
- 24x led count
- 1' cable length
- 60° optical light spread





# QUAD DUAL STACK

A. Quad Dual Stack

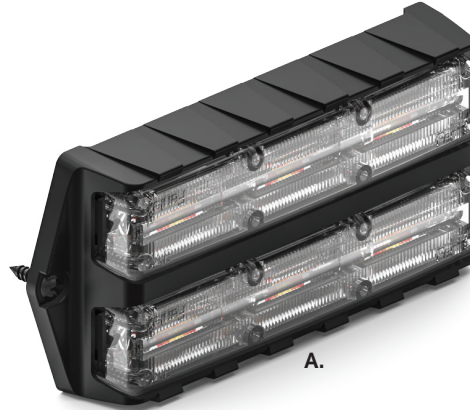

PART NUMBER	DIMENSIONS	VOLTAGE	CURRENT DRAW	LED COLORS
A. QDSM-8101	1.8" x 1.7" x 5.22"	10-18 V DC	1.5 Amps	R  B  A  W

CERTIFICATIONS:



DESCRIPTION:

The Feniex Quad is the world's first 4-color emergency warning lighting line and the brightest in the industry. User programmable in red, blue, amber and white, the Quad offers endless customization while remaining competitively-priced. At Feniex Industries, we've seen the future. The future is one option for every first responder and construction site and one sku for every fleet manager. The future of safety comes in four colors and covers every application. The future is Quad.

- 15 programmable color settings: *single, dual, tri & quad*
- Syncs with T3, Cannon, Under Mirror Puck & FSMs
- 3 programmable modes
- Flood and cruise mode pattern capable
- Stop, turn and tail pattern capable
- Field servicable & plug-in-play connectivity
- 48x led count
- 1' cable length
- 60° optical light spread

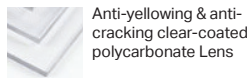





# QUAD MIRROR MOUNT



A.

A. Quad Mirror Mount



PART NUMBER	DIMENSIONS	VOLTAGE	CURRENT DRAW	LED COLORS
A. Q-1400	N/A	10-18 V DC	1.5 Amps	R B A W

CERTIFICATIONS:



DESCRIPTION:

The Feniex Quad is the world's first 4-color emergency warning lighting line and the brightest in the industry. User programmable in red, blue, amber and white, the Quad offers endless customization while remaining competitively-priced. At Feniex Industries, we've seen the future. The future is one option for every first responder and construction site and one sku for every fleet manager. The future of safety comes in four colors and covers every application. The future is Quad.

- 15 programmable color settings: *single, dual, tri & quad*
- Syncs with T3, Cannon, Under Mirror Puck & FSMs
- 3 programmable modes
- Flood and cruise mode pattern capable
- Turn pattern capable
- Series supports 5+ vehicle makes & models
- 48x led count
- 60° optical light spread



Mirror Mount Wire Harness



Vehicle-specific vacuum-formed housing



Anti-yellowing & anti-cracking clear-coated polycarbonate Lens



# QUAD SPOILER MOUNT



A. Quad Spoiler Mount



PART NUMBER	DIMENSIONS	VOLTAGE	CURRENT DRAW	LED COLORS
A. Q-1000	N/A	10-18 V DC	5 Amps	R B A W

CERTIFICATIONS:



DESCRIPTION:

The Feniex Quad is the world's first 4-color emergency warning lighting line and the brightest in the industry. User programmable in red, blue, amber and white, the Quad offers endless customization while remaining competitively-priced. At Feniex Industries, we've seen the future. The future is one option for every first responder and construction site and one sku for every fleet manager. The future of safety comes in four colors and covers every application. The future is Quad.

- 15 programmable color settings: *single, dual, tri & quad*
- Syncs with T3, Cannon, Under Mirror Puck & FSMs
- 3 programmable modes
- Flood and cruise mode pattern capable
- Stop, tail and turn pattern capable
- Series supports 5+ vehicle makes & models
- 144x led count
- 60° optical light spread



Vehicle-specific vacuum-formed housing



Anti-yellowing & anti-cracking clear-coated polycarbonate Lens



# QUAD PILLAR MOUNT

A. Quad Pillar Mount



PART NUMBER	DIMENSIONS	VOLTAGE	CURRENT DRAW	LED COLORS
A. Q-1700	N/A	10-18 V DC	3 Amps	R B A W

CERTIFICATIONS:



DESCRIPTION:

The Feniex Quad is the world's first 4-color emergency warning lighting line and the brightest in the industry. User programmable in red, blue, amber and white, the Quad offers endless customization while remaining competitively-priced. At Feniex Industries, we've seen the future. The future is one option for every first responder and construction site and one sku for every fleet manager. The future of safety comes in four colors and covers every application. The future is Quad.

- 15 programmable color settings: *single, dual, tri & quad*
- Syncs with T3, Cannon, Under Mirror Puck & FSMs
- 3 programmable modes
- Flood and cruise mode pattern capable
- Stop, tail and turn pattern capable
- Series supports 5+ vehicle makes & models
- 144x led count
- 60° optical light spread



Mirror Mount Wire Harness



Vehicle-specific vacuum-formed housing



Anti-yellowing & anti-cracking clear-coated polycarbonate Lens



**Quad**

Converter

**Feniex Industries, Inc.**  
1.800.615.8350

# QUAD CONVERTER

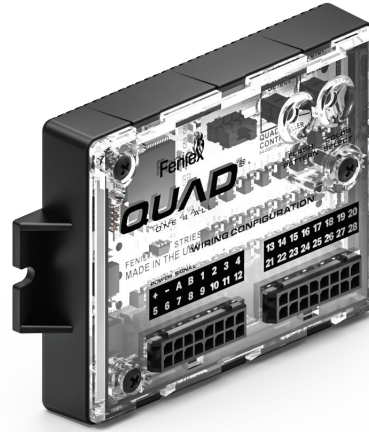

A.

A. Quad Converter

PART NUMBER	DIMENSIONS	VOLTAGE	MAX CURRENT DRAW	AMPS PER OUTPUT
A. Q-0020	4" x 2.75" x 0.75"	10-18 V DC	750 mA	3.5 Amps on 6 outputs

**COMPATIBILITY:** FUSION-S & QUAD



**CERTIFICATIONS:**



**DESCRIPTION:**

The Feniex Quad is the world's first 4-color emergency warning lighting line and the brightest in the industry. User programmable in red, blue, amber and white, the Quad offers endless customization while remaining competitively-priced. At Feniex Industries, we've seen the future. The future is one option for every first responder and construction site and one sku for every fleet manager. The future of safety comes in four colors and covers every application. The future is Quad.

- 15 programmable color settings: *single, dual, tri & quad*
- 15 color programmable rear traffic advisor: *left, right & center out*
- 4 programmable cut-off modes: *front, rear, driver & passenger*
- 4 programmable flood modes: *front, rear, driver & passenger*
- 15 programmable flash patterns for front & rear flashing
- 4 color programmable cruise modes: *driver & passenger*
- 4 programmable priority flashing modes: *front & rear*
- Programmable California-red mode: *20 positions*
- 3 programmable DOT functions: *stop, turn & tail light*
- 3 programmable brightness levels: *10%, 50% & 100%*
- Cable length: 1'
- Built-in pattern & color selection switch
- Plug & play connectivity

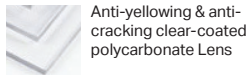



# AM800® Beacon

Perimeter  
Lights

Feniex Industries, Inc.  
1.800.615.8350

## BEACON PERIMETER LIGHT

A. Beacon Perimeter Light



PART NUMBER	DIMENSIONS	VOLTAGE	CURRENT DRAW	LENS COLORS
A. BN-0118	6.4" D x 4.4" H	10-18 V DC	2.3 Amps	R B A W G

### MOUNTING:



Pole Mount



Magnetic Mount

### CERTIFICATIONS:



### DESCRIPTION:

Send the signal with the Feniex AM600 Beacon, an easy-to-use, reliable safety light for any public works or commercial vehicle. Combining quality and affordability, the AM600 is a single-color SAE J845-Class 1 Certified LED beacon with multiple mounting options and 20 flash patterns.

- Purchase includes: 1 beacon, cigarette plug controller and 3 mounting screws.
- 20 flash patterns
- Optional magnetic mount or pole mount add-ons
- 10' cable harness
- All flash patterns in slow/fast speeds
- Sync up to 6 beacons
- 40x LEDs



Beacon  
Wire  
Harness

Weatherproof  
Polycarbonate  
Plastic Base

Anti-yellowing  
Polycarbonate Lens

ON/OFF  
SWITCH

FLASH PATTERN  
CHANGER

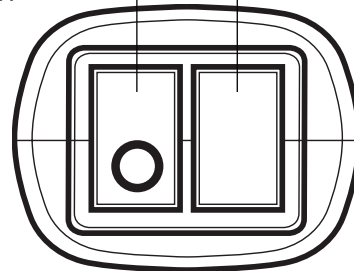





## Typhoon Full Function

Siren & Controller

Feniex Industries, Inc.  
1.800.615.8350

# TYPHOON FULL FUNCTION

- A. Typhoon Controller
- B. Typhoon Siren

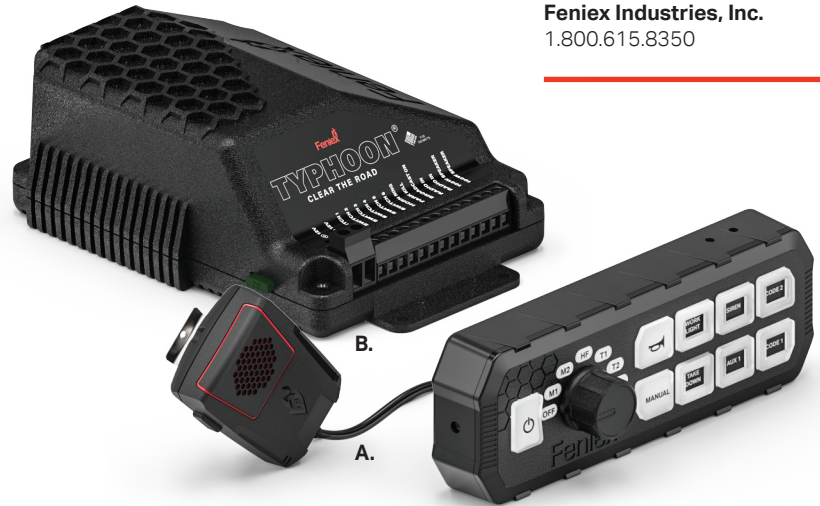

PART NUMBER	DIMENSIONS	VOLTAGE	MAX CURRENT DRAW	AMPS PER OUTPUT
A. C-4017	6.8" x 2.4" x 1.2"	10-18 V DC	N/A	N/A
B. C-4017	4.8" x 7.4" x 2.5"	10-18 V DC	20 Amps	3.5 Amps on 6 outputs

### MOUNTING:

Dash mount bracket



### CERTIFICATIONS:



### DESCRIPTION:

The Typhoon Full Function system includes a 100w siren and integrated controller. Engineered with both pursuit and response vehicles in mind, the Typhoon Full Function features 6-programmable backlit buttons, a PA/microphone, and 23 police and fire tones with rotary dial selection.

- 21 programmable siren tones
- 6 auxiliary outputs [3.5A per output]
- Auxiliary buttons programmable as on/off or momentary
- Integrated 2 output wigwag capability [for lights]
- Integrated microphone
- Air horn, park-kill, radio rebroadcast capabilities
- Rotary switch
- 2' mic cable length
- Volume control
- Backlit LED buttons
- Purchase includes Typhoon siren, controller, dash mount bracket & legend sheet
- Compatible with most emergency lights



Military-grade Aluminum

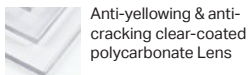

Anti-yellowing & anti-cracking clear-coated polycarbonate Lens



# TYPHOON HANDHELD

- A. Typhoon Controller
- B. Typhoon Siren

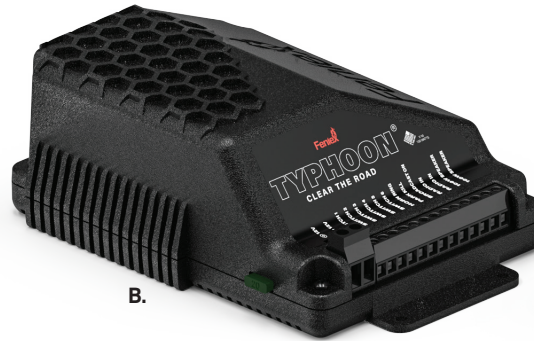

B.



A.

PART NUMBER	DIMENSIONS	VOLTAGE	MAX CURRENT DRAW	AMPS PER OUTPUT
A. C-5017	6.8" x 2.4" x 1.2"	10-18 V DC	N/A	N/A
B. C-5017	4.8" x 7.4" x 2.5"	10-18 V DC	20 Amps	3.5 Amps on 6 outputs

**MOUNTING:**

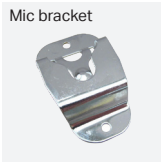

**CERTIFICATIONS:**



**DESCRIPTION:**

Ride the wave of the Typhoon Handheld, an integrated, compact 100w siren/controller with ultra-clear sound and reliable convenience. Engineered for undercover and volunteer applications, the Typhoon Handheld features 6-programmable backlit buttons, integrated PA/microphone with flexible mounting options, and 23 police and fire tones with push-button selection. Additional lead times for Spanish Tones.

- 21 programmable siren tones
- 6 auxiliary outputs [3.5A per output]
- Auxiliary buttons programmable as on/off or momentary
- Integrated 2 output wigwag capability [for lights]
- Integrated microphone
- 7 dedicated buttons for siren tones and programmed as momentary or on/off
- Air horn, park-kill, radio rebroadcast capabilities
- Rotary switch
- 2' mic cable length
- Volume control
- Backlit LED buttons
- Purchase includes Typhoon siren, controller, dash mount bracket & legend sheet
- Compatible with most emergency lights





## 4200 DL

Controller & Relay

Feniex Industries, Inc.  
1.800.615.8350

# 4200 DL CONTROLLER

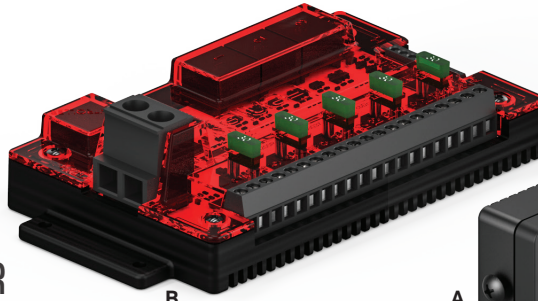

B.



A.

- A. 4200 Controller
- B. 4200 DL Relay

PART NUMBER	DIMENSIONS	VOLTAGE	MAX CURRENT DRAW	AMPS PER OUTPUT
A. C-4200-DL	6.8" x 3.5" x 1.3"	10-18 V DC	N/A	N/A
B. C-4200-DL	6.3" x 3.3" x 1.5"	10-18 V DC	60 Amps	10 Amps on 18 outputs

### MOUNTING:



### CERTIFICATIONS:



### DESCRIPTION:

The most powerful controller in the warning industry, the 4200 Datalink Controller is ideal for any emergency vehicle. Universally compatible and fully programmable, the 4200 DL can control your vehicle's entire lighting and siren system. Connects easily to the Feniex StormPro Siren or Fusion Series lightbar by using one of three Datalink ports.

- 18 programmable buttons: *on/off, momentary and timer*
- Free 4200 programmable software
- Auxiliary buttons programmable as on/off or momentary
- Integrated 2 output wigwag capability [for lights]
- Integrated microphone
- 7 dedicated buttons for siren tones and programmed as momentary or on/off
- Air horn, park-kill, radio rebroadcast capabilities
- Fuse 125% of circuit draw
- Console face plates available with Havis, Jotto and Troy
- Backlit LED buttons
- Purchase includes 4200 controller & relay, 4x button legend sheets, 2x RJ45 cables, 1x usb cable and u-bracket
- Compatible with most emergency lights
- Capabilities
  - 3 position slide switch
  - 2 channel integrated wigwag
  - 18 programmable 10 amp outputs
  - Programmable ignition activation
  - Programmable night mode activation
  - Programmable day mode activation
  - 2 programmable 12V- inputs





**4200 DL**

Controller & Relay

Feniex Industries, Inc.  
1.800.615.8350

# 4200 MINI CONTROLLER

A. 4200 Mini



PART NUMBER	DIMENSIONS	VOLTAGE	MAX CURRENT DRAW	AMPS PER OUTPUT
A. C-4010	4" x 2.75" x 0.75"	10-18 V DC	750 mA	3.5 Amps on 6 outputs

**MOUNTING:**



**CERTIFICATIONS:**



**DESCRIPTION:**

The 4200 Mini Controller is the new standard for any vehicle. With 6 programmable buttons and an aluminum, waterproof case, this ultra-compact controller can be mounted practically anywhere and will withstand demanding environments.

- 6 programmable buttons: *on/off or momentary*
- Integrated 2 output wigwag capability
- Fuse 125% of circuit draw

- Backlit LED buttons
- Purchase includes 4200 mini controller, button legend sheets and side brackets
- Compatible with most emergency lights

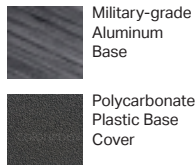



## Feniex One

Controller & Relay

Feniex Industries, Inc.  
1.800.615.8350

# FENIEX ONE CONTROLLER

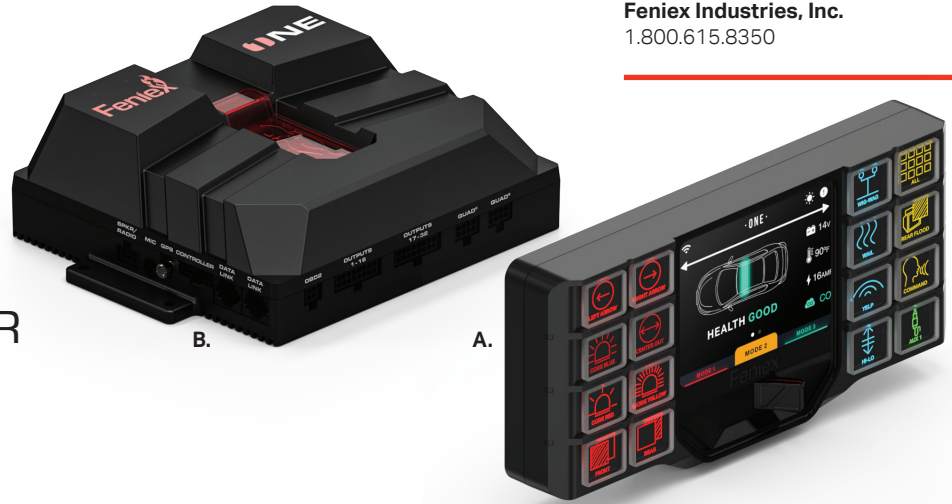

A. Feniex one Controller  
B. Feniex One Relay

PART NUMBER	DIMENSIONS	VOLTAGE	MAX CURRENT DRAW	AMPS PER OUTPUT
A. C-4200-DL	7.3" x 1.13" x 3.13"	10-18 V DC	N/A	N/A
B. C-4200-DL	8" x 6.25" x 2.44"	10-18 V DC	60 Amps	5 Amps on 32 outputs

### MOUNTING:



### CERTIFICATIONS:



### DESCRIPTION:

The Feniex One is the world's first autonomous controller. Feniex Industries now brings the officer, the fleet manager and the installer a brand new product of incredible performance. The Feniex One champions functionality, ease of use, and streamlined installation. The next evolution in smart controllers goes beyond traditional standards with innovations that bridge the gap of automation. Transformative technology. The Feniex One.

*\*Purchasing without an obd2 plug-in will limit the functionality of the controller and require additional installation. Consult your Feniex Representative or Customer Support for more questions.*

- Built-in 200W dual-tone siren with audio commands
- Integrated 3-position programmable slide switch
- 16 programmable push buttons with 5 color options
- 3 additional programmable LCD push buttons
- Feniex software easy to configure and program
- Feniex Web offers live fleet health monitoring
- 32 programmable outputs rated at 5 amps each
- Integrated GPS timing chip for vehicle to vehicle sync
- 8 programmable inputs with 12v+ or 12v- options
- 8 programmable Quad serial outputs
- Console face plates available with Havis, Jotto and Troy
- 15' controller cable length
- Purchase includes Feniex One controller & relay, button legend sheets, u-bracket, antenna, usb cable, ethernet cable, wire harnesses for data link, outputs, inputs and siren
- Compatible with most emergency lights
- Powered by ARM A9 Quad Core Processor







# FENIEX WEB LIVE FLEET

A. Live Fleet Software

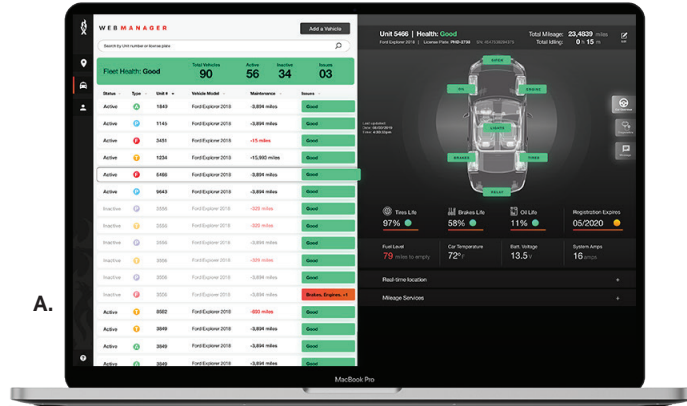

PART NUMBER	UPDATE RATE	SUBSCRIPTION
A. LF-0121	5 year data	2-year commitment

**ADD-ONS:**

C.A.N. OBD2 Plug



**SCREENSHOTS**

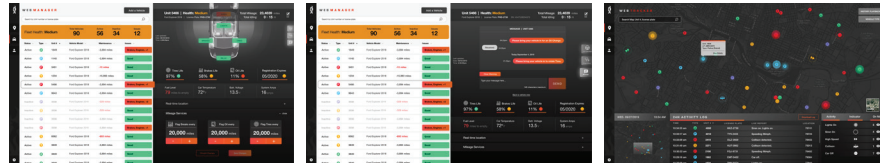

**CERTIFICATIONS:**



**DESCRIPTION:**

The Feniex Web Live Fleet is an online solution designed to enhance fleet accountability. Fleet managers can now easily access and record activity data of their vehicles to ensure the safety of their fleet. Live Fleet is the only industry-specific fleet management system designed for first responders out on the road and the fleet managers that maintain their equipment. Through the online dashboard, fleet managers can monitor their entire fleet with live diagnostics and forecast maintenance spending. For the first time, fleet managers can message drivers directly on their installed Feniex One controllers to streamline critical issues.

- Online dashboard provides live fleet activity
- Vehicle's percentage of tires, brake & oil life
- Vehicle's current fuel level, mileage & idling time
- Vehicle's real-time location of entire fleet
- Records fleet activity and history playback
- Messaging feature from online portal to a vehicle's Feniex One
- Live view of vehicle speed
- Available for any fleet size
- Live diagnostics of lights & siren
- Live view of all active issues in fleet
- Downloadable 24-hour activity log
- Ability to filter between vehicle type
- Indicator of collision alert
- Status of lights active or inactive
- Status of siren active or inactive
- Status of engine on or off



Software Connects to Feniex One Controller



Connect to Feniex Web without a controller with our C.A.N. OBD2 plug-in



# STORM PRO 100W SIREN



A. Storm Pro 100W Siren

A.

PART NUMBER	DIMENSIONS	VOLTAGE	MAX CURRENT DRAW	POWER OUTPUT
A. C-4014	4.1" x 6" x 2.5"	10-18 V DC	10A	100W
B. C-4014	2.7" x 3.74" x 1.81"	N/A	N/A	N/A

**MOUNTING:**



**CERTIFICATIONS:**



**DESCRIPTION:**

The Storm Pro 100 Watt Siren packs a punch and produces 124 decibels of clear, thundering sound in 23 programmable tones. The leading siren for pursuit and response vehicles, the Storm has remote activation that allows universal compatibility with non-Feniex controllers. For maximum impact, pair your Storm Pro police siren with the Feniex Triton speaker and the Feniex 4200 DataLink controller. Meets or exceeds SAE J1849 standards.

- 100W power output
- 21 programmable tones
- Microphone included for PA functionality
- Capabilities:
  - Radio rebroadcast
  - Park-kill
  - Horn ring
  - 4 programmable modes
- Integrated push button for tone selection
- Purchase includes Storm Pro 100W, RJ45 cable, microphone and microphone mounting set
- Functions with most existing controllers and switch panels
- 15' microphone cable length



Siren  
Military-grade  
Aluminum



# STORM PRO 200W SIREN



A. Storm Pro 200W Siren  
B. Microphone

PART NUMBER	DIMENSIONS	VOLTAGE	MAX CURRENT DRAW	POWER OUTPUT
A. C-4015	6.6" x 6" x 2.5"	10-18 V DC	20A	200W
B. C-4014	2.7" x 3.74" x 1.81"	N/A	N/A	N/A

**MOUNTING:**

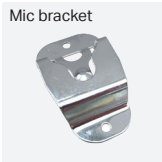

**CERTIFICATIONS:**



**DESCRIPTION:**

The Storm Pro 200 Watt Siren packs a punch, producing 130 decibels of clear, thundering sound in 23 programmable tones. The leading siren for pursuit and response vehicles, the Storm Pro 200w is dual-tone capable with remote activation that allows for universal compatibility with non-Feniex controllers. For maximum impact, pair your Storm Pro police siren with the Feniex Triton speaker and the Feniex 4200 DataLink controller. Meets or exceeds SAE J1849 standards. Additional lead times for Spanish Tones.

- 200W power output
- 21 programmable tones
- Dual tone capability
- Microphone included for PA functionality
- Capabilities:
  - Radio rebroadcast
  - Park-kill
  - Horn ring
  - 6 programmable modes
- Integrated push button for tone selection
- Purchase includes Storm Pro 200W, RJ45 cable, microphone and microphone mounting set
- Functions with most existing controllers and switch panels





**Torch Light**

Scene Lighting

**Feniex Industries, Inc.**  
1.800.615.8350

# TORCH POLE LIGHT



A. Torch Light

PART NUMBER	DIMENSIONS	VOLTAGE	CURRENT DRAW	LED COLORS
A. PL-1519	6.125" x 3.25" x 12"	11-27 V DC	14 peak Amps	W ■

**MOUNTING:**

Pole bracket



**CERTIFICATIONS:**



**DESCRIPTION:**

The Feniex Torch Pole Light is incredibly bright and fully adjustable, making it the best work light for any construction, towing, fire apparatus or utility vehicle. Featuring 84 incredibly bright flood LEDs and 110° light spread, the Torch Light is guaranteed to light up any scene.

- 20,000 lumens
- Working temperature: -40° F to 65° F
- Power supply: spiral harness
- 150W power
- Mounting brackets included
- 84x led count
- Purchase includes adjustable pole mount with 2.75" standoff brackets
- 48" wire harness
- 110° optical light spread

Torch Wire Harness



Weatherproof powder-coated anodized aluminum housing



Anti-yellowing & anti-cracking clear-coated polycarbonate Lens



# AM900 Work Light

Scene Lighting

Feniex Industries, Inc.  
1.800.615.8350



A.

## AM900 WORK LIGHT

A. AM900 Work Light

PART NUMBER	DIMENSIONS	VOLTAGE	CURRENT DRAW	LED COLORS
A. WL-0118	4.4" x 3.3" x 2.2"	10-24 V DC	1.75 A	W

### MOUNTING:

Swivel bracket



### CERTIFICATIONS:



### DESCRIPTION:

Make work brighter with the Feniex AM900 Work Light, an effective and high-quality work light for any construction, towing, plow or utility vehicle. Featuring 8 incredibly bright flood LEDs, the AM900 offers excellent heat dispersion and a rugged, durable aluminum exterior.

- 8 high power LEDs
- Power output: 20W
- Mounts vertically or horizontally
- 8x high power led count
- Purchase includes swivel mount
- 16" wire harness

AM900 Wire Harness



Weatherproof powder-coated anodized aluminum housing



Anti-yellowing & anti-cracking clear-coated polycarbonate Lens





# T3 SURFACE MOUNT

A. T3 Surface Mount

A.



PART NUMBER	DIMENSIONS	VOLTAGE	CURRENT DRAW	LED COLORS
A. D-50015	1" x 3.4" x 1.05"	10-18 V DC	0.75 A	R  B  A  W  G

**MOUNTING:**

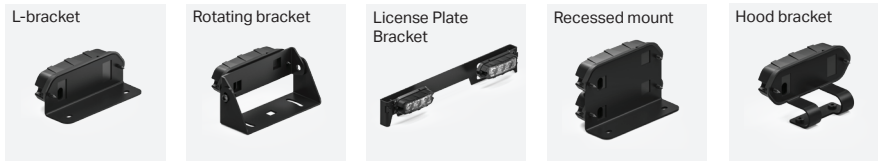

**CERTIFICATIONS:**



**DESCRIPTION:**

A surface mount that works as hard as you do: the T3 is fiercely bright, affordable and can be mounted almost anywhere on your vehicle. Compact and weatherproof, count on the Feniex T3 to get the job done.

- Available brake, tail and steady-on patterns
- Cost effective
- Mounts vertically or horizontally
- 3x high power led count
- Purchase includes protective rubber pad
- 10" cable harness
- 40° optical light spread





# CANNON HIDE A WAY

A. Cannon Hide a way



PART NUMBER	DIMENSIONS	VOLTAGE	CURRENT DRAW	LED COLORS
A. H-2219	1" x 1" x 1.59"	10-18 V DC	1 A	R  B  A  W

**MOUNTING:**



**ADD-ONS:**



**CERTIFICATIONS:**



**DESCRIPTION:**

The Cannon is the brightest, most versatile hide-a-way in the emergency market...and a Feniex best-seller. 12 individual LEDs are housed within this compact, weatherproof design. The Cannon features 3 modes and is offered in single and dual color options. Syncs with additional Cannons, Under Mirror Puck Light, Fusion Surface Mounts (v3), Fusion Dual Stack, Fusion Mirror Mount, Fusion Spoiler Mount, Fusion Pillar Mount, Fusion 1X and 2X, Fusion 100, Fusion 200, Fusion 400.

- 120° optic with option to convert to 360° optic
- 3 programmable modes
- Dual color availability
- 15 single color flash patterns
- 39 dual color flash patterns
- Available colors: R, A, B, W, RW, BW, AW, RB, RA, BA
- All-in-one design. No inline driver
- Functions as reverse light, turn light, tail light, fog light and/or warning light
- 12x led count
- Purchase includes Cannon, 2x screws and 1 gasket
- 10" cable harness



Cannon  
Wire  
Harness



Military-grade  
Aluminum



Anti-yellowing & anti-  
cracking clear-coated  
polycarbonate Lens



**Shield**  
Backup Alarm

Speaker

**Feniex Industries, Inc.**  
1.800.615.8350

# SHIELD BACKUP ALARM

A. Shield Backup Alarm

A.



PART NUMBER	DIMENSIONS	VOLTAGE	CURRENT DRAW	SOUND OUTPUT
A. BA-0119	2.9" x 5" x 2.8"	12-14 V DC	1 A	97dB (+/- 10dB)

**CERTIFICATIONS:**



**DESCRIPTION:**

Sound the alarm with the Feniex Shield 14W, a dependable, affordable solution to protect any work site or construction zone. This 97dB (+/-10dB) back-up alarm/beeper is dust, moisture and vibration-proof.

- Max watt 14.4
- Temperature range: -40° - 185°
- Dust, moisture and vibration-proof
- Built-in universal flush or hanging mount
- Purchase includes 1 backup alarm



Shield Wire Harness



Durable glass-filled nylon housing



**Triton**

Speaker

**Feniex Industries, Inc.**  
1.800.615.8350

# TRITON SPEAKER

A. Triton Speaker

A.



PART NUMBER	DIMENSIONS	POWER	SOUND DISP.	SOUND OUTPUT
A. S-2009	7" x 7" x 3"	100W	85°	124dB

**CERTIFICATIONS:**



**DESCRIPTION:**

Stand out with the Triton 100W: with a compact low-profile design and durable polycarbonate housing, its the ideal speaker for any police, fire or EMS vehicle. Uniquely engineered to achieve 85 degree sound dispersion, the Triton is a reliable choice for any first responder. Meets or exceeds SAE J1849 standards.

- Impedance of 11 ohms
- Neodymium magnet
- Universal compatibility

- Built-in I-shaped mounting bracket
- Purchase includes 1 Triton Speaker
- Compact, slim design to fit behind grille

Triton Wire Harness



Lightweight durable polycarbonate frame



Military-grade Aluminum



Vanguard

Speaker

Feniex Industries, Inc.  
1.800.615.8350

# VANGUARD SPEAKER

A. Vanguard Speaker

A.



PART NUMBER	DIMENSIONS	POWER	SOUND DISP.	SOUND OUTPUT
A. S-1019	2.75" x 6.75" x 6.5"	100W	85°	127dB

**MOUNTING:**

U bracket



**CERTIFICATIONS:**



**DESCRIPTION:**

The Vanguard Speaker is a compact low-profile design and durable metal housing, making it the ideal speaker for any police, fire or EMS vehicle. Uniquely engineered to fit anywhere on the vehicle, the Vanguard is capable of working with any existing siren package. Meets or exceeds SAE J1849 standards.

- 12 V DC input voltage
- 100% metal speaker
- Universal compatibility
- Includes I-shaped mounting bracket
- Purchase includes 1 Vanguard speaker
- Compact, slim design to fit behind grille



Triton  
Wire  
Harness



Military-grade  
Aluminum





# Titan 30W

Speaker

Feniex Industries, Inc.  
1.800.615.8350

## TITAN 30W SPEAKER

A. Titan 30W Speaker



PART NUMBER	DIMENSIONS	POWER	SIREN TONES	CURRENT DRAW	SOUND OUTPUT
A. S-5018	4.8" x 4.8" x 4.5"	30W	30	3 Amps	110dB

### MOUNTING:

Built-in L-bracket



### CERTIFICATIONS:



### DESCRIPTION:

The Titan is the smallest and most compact siren/speaker available today. Ideal for any motorcycle, ATV, UTV or small vehicle, the Titan can function as a siren or speaker and is compatible with any switch panel or pre-installed switch configuration.

- Integrated all-in-one siren and speaker
- Easily mounts to any rail, bumper or headache rack
- Includes universal mounting bracket
- Input voltage: 12V DC
- Purchase includes 1 Titan speaker
- Lightweight and ultra-compact design
- On/Off activation
- Hands-free activation
- 30 siren tones



Titan Wire Harness

Weatherproof Polycarbonate Plastic Base

Military-grade Aluminum



## Hammer

Low Frequency  
Speaker

Feniex Industries, Inc.  
1.800.615.8350

# HAMMER 100W SPEAKER



A. Titan 30W Low Frequency Speaker

PART NUMBER	DIMENSIONS	POWER	SIREN TONES	CURRENT DRAW	SOUND OUTPUT
A. S-3017	7.25" x 7.25" x 9.25"	100W	7	17 peak Amps	110dB

### MOUNTING:

Universal L-bracket



Charger bracket



Interceptor sedan



Tahoe bracket



Interceptor utility



### CERTIFICATIONS:



### DESCRIPTION:

An instant game-changer: the Hammer is the only all-in-one, universal low-frequency siren. Our unique system combines a siren, amplifier and speaker within a single unit. Pair it with a Typhoon, Storm Pro or any other siren. Compact and easy to install, mount it to any emergency vehicle for 100 watts of ultra-clear, powerfully consistent sound waves. The Hammer is capable of penetrating solid objects and helping to clear intersections quickly and safely.

- Integrated all-in-one siren, amplifier and speaker
- Easily mounts to any rail, bumper or headache rack
- Includes universal mounting bracket
- Input voltage: 12V DC
- Current draw 17 peak amps
- 2 programmable modes
- Park kill capability
- Vehicle specific brackets
- 7+ integrated siren tones
- Frequency input: 732Hz - 4KHz
- Frequency output: 183Hz - 1KHz



Titan  
Wire  
Harness



Military-grade  
Aluminum



# GUARDIAN FLASHLIGHT

A. Guardian Flashlight

A.



PART NUMBER	DIMENSIONS	VOLTAGE	POWER	LED COLORS
A. FL-001	7.9" x 1.75" x 1.75"	12 V DC	<5W	W ■

INSTALLATION:

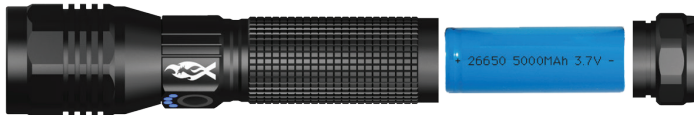

CERTIFICATIONS:



DESCRIPTION:

The Fenix Guardian Tactical Flashlight is a must have for any in need of a personal LED flashlight that is both long lasting and rechargeable. The Fenix Industries Guardian Flashlight lasts for nearly 6 hours on a full charge and has 5 modes that include 100%, 50%, 25%, Strobe and SOS. The handheld flashlight boasts a 1,200 Lumen rating and features adjustable optics to ensure pinpoint accuracy or a wide scene light application for spotting small objects in a wide area. The Guardian features a quick charging 2A USB Micro that ensures you always have ample power to lighten up any spot at any time of night.

- Telescopic lens for light adjustment
- 1x26650 lithium rechargeable battery
- 1200 lumens
- Up to 6 hour battery life
- Battery life led indicator
- Wrist strap provided
- 2A usb-micro charging cable
- 5 modes: 100%, 50%, 25%, strobe & SOS

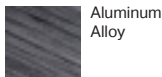

Aluminum Alloy

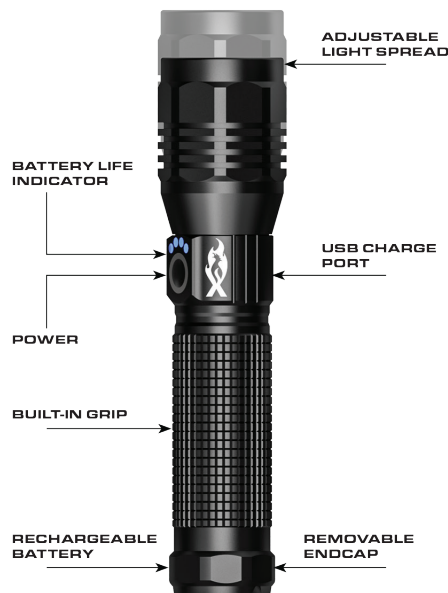



# 8.5" DOME INTERIOR LIGHT

A. 8.5" Dome Light



PART NUMBER	DIMENSIONS	VOLTAGE	CURRENT DRAW	LED COLORS
A. IL-0121	8.5" x 8.5" x 1.5"	10-18 V DC	1 Amp	W <input type="checkbox"/> R <input type="checkbox"/>

**MOUNTING:**



**CERTIFICATIONS:**



**DESCRIPTION:**

The Feniex Dome 8.5" Dome Light, the perfect choice for any interior emergency vehicle lighting. The Dome offers 4 modes: Night Time Red, 100% White, 75% White, and 50%. Safely light the interior of your vehicle even while in a tactical situation where limited light is required.

- 360° unobstructed lighting
- 3 light color modes
  - 50% white dim
  - 100% white
  - red light
- Front or rear mounting options available
- 10" cable harness
- Mounting hardware provided
- Unobtrusive design



Military-grade Aluminum



Anti-yellowing & anti-cracking clear-coated polycarbonate Lens



## Wide Lux 9x7

Surface Mount

Feniex Industries, Inc.  
1.800.615.8350

# WIDE LUX 9X7 LIGHT

A. Wide Lux 9x7

A.



PART NUMBER	DIMENSIONS	VOLTAGE	CURRENT DRAW	LED COLORS
A. A-7900	7.75" x 10" x 1"	10-18 V DC	1.5 Amps	R  B  A  W

### MOUNTING:



### CERTIFICATIONS:



### DESCRIPTION:

Choose the Wide-Lux™ 9x7 Series for the industry's boldest, most intense perimeter lighting in an ultra-compact, slim design. Ideal for fire and EMS vehicles. Our Wide-Lux™ technology features hourglass optics, emitting powerful visibility from 180° viewing angles. Extremely functional and customizable, the Wide-Lux™ can be used as a brake-tail-turn, reverse, warning light or scene light and steady on capabilities at 50% brightness. Available in red, blue, amber or white with a clear lens.

- Available modes:
  - Brake light mode
  - Tail light mode
  - Dim Mode
  - Turn light mode
- Front or rear mounting options available
- 36x led count
- 180° light spread
- 10" cable harness
- Mounting hardware provided
- 20+ flash patterns



Wide Lux Wire Harness



Military-grade Aluminum



Anti-yellowing & anti-cracking clear-coated polycarbonate Lens





# Wide Lux 6x4

Surface Mount

Feniex Industries, Inc.  
1.800.615.8350

## WIDE LUX 6X4 LIGHT

A. Wide Lux 6x4

A.



PART NUMBER	DIMENSIONS	VOLTAGE	CURRENT DRAW	LED COLORS
A. A-4600	4.75" x 7.05" x 1"	10-18 V DC	1.25 Amps	R B A W

### MOUNTING:

Built-in bracket



Bezel Mount



### CERTIFICATIONS:



### DESCRIPTION:

Choose the Wide-Lux™ 6x4 Series for the industry's boldest, most intense perimeter lighting in an ultra-compact, slim design. Ideal for fire and EMS vehicles. Our Wide-Lux™ technology features hourglass optics, emitting powerful visibility from 180° viewing angles. Extremely functional and customizable, the Wide-Lux™ can be used as a brake-tail-turn, reverse, warning light or scene light and steady on capabilities at 50% brightness. Available in red, blue, amber or white with a clear lens.

- Available modes:
  - Brake light mode
  - Tail light mode
  - Dim Mode
  - Turn light mode
- Front or rear mounting options available
- 18x led count
- 180° light spread
- 10" cable harness
- Mounting hardware provided
- 20+ flash patterns



Wide Lux Wire Harness



Military-grade Aluminum



Anti-yellowing & anti-cracking clear-coated polycarbonate Lens



# WIDE LUX 7X3 LIGHT

A. Wide Lux 7x3

A.



PART NUMBER	DIMENSIONS	VOLTAGE	CURRENT DRAW	LED COLORS
A. A-3700	3.75" x 8" x 1"	10-18 V DC	1 Amp	R  B  A  W

### MOUNTING:

Built-in bracket



Bezel Mount



### CERTIFICATIONS:



### DESCRIPTION:

Choose the Wide-Lux™ 7x3 Series for the industry's boldest, most intense perimeter lighting in an ultra-compact, slim design. Ideal for fire and EMS vehicles. Our Wide-Lux™ technology features hourglass optics, emitting powerful visibility from 180 degree viewing angles. Extremely functional and customizable, the Wide-Lux™ can be used as a brake-tail-turn, reverse, warning light or scene light and steady on capablities at 50% brightness.

- Available modes:
  - Brake light mode
  - Tail light mode
  - Dim Mode
  - Turn light mode
- Front or rear mounting options available
- 18x led count
- 180° light spread
- 10" cable harness
- Mounting hardware provided
- 20+ flash patterns



Wide Lux Wire Harness



Military-grade Aluminum



Anti-yellowing & anti-cracking clear-coated polycarbonate Lens



## Down Lux 9x7

Scene Lighting





Feniex Industries, Inc.  
1.800.615.8350

# DOWN LUX 9X7 LIGHT

A. Down Lux 9x7

A.



PART NUMBER	DIMENSIONS	VOLTAGE	CURRENT DRAW	LED COLORS
A. D-7900	7.75" x 10" x 1"	10-18 V DC	1 Amp	R  B  A  W 

### MOUNTING:

Built-in bracket



Bezel Mount



### CERTIFICATIONS:



### DESCRIPTION:

Choose the Down Lux™ Series for the industry's boldest, most intense scene lighting in an ultra-compact, slim design. The Down Lux features unique 50° optics with a downward projection, providing powerful visibility for any emergency scene. Available in white with a clear lens the Down Lux is the perfect led scene light for any firetruck, ambulance, or command vehicle in your fleet. The Down Lux meets or exceeds NFPA and KKK ambulance specifications.

- Available modes:
  - Flood mode
- Front or rear mounting options available
- Purchase includes 9x7 Down Lux, 4 # 6-32 x 3/16" screws, 2x back bracket mounts, 2x #10-24 x 1" bolts, 2x #6 x .5" screws, 2x hex nuts, 2x #10 flat washers
- 36x led count
- 180° light spread
- 9" cable harness
- Mounting hardware provided

Wide Lux Wire Harness



Military-grade Aluminum



Anti-yellowing & anti-cracking clear-coated polycarbonate Lens





# DOWN LUX 6X4 LIGHT

A. Down Lux 6x4

A.



PART NUMBER	DIMENSIONS	VOLTAGE	CURRENT DRAW	LED COLORS
A. D-4600	4.75" x 7.05" x 1"	10-18 V DC	1 Amp	R B A W

**MOUNTING:**

Built-in bracket



Bezel Mount



**CERTIFICATIONS:**



**DESCRIPTION:**

Choose the Down Lux™ Series for the industry's boldest, most intense scene lighting in an ultra-compact, slim design. The Down Lux features unique 50° optics with a downward projection, providing powerful visibility for any emergency scene. Available in white with a clear lens the Down Lux is the perfect led scene light for any firetruck, ambulance, or command vehicle in your fleet. The Down Lux meets or exceeds NFPA and KKK ambulance specifications.

- Available modes:
  - Flood mode
- Front or rear mounting options available
- Purchase includes 6x4 Down Lux, 4 # 6-32 x 3/16" screws, 2x back bracket mounts, 2x #10-24 x 1" bolts, 2x #6 x .5" screws, 2x hex nuts, 2x #10 flat washers
- 18x led count
- 180° light spread
- 9" cable harness
- Mounting hardware provided

Wide Lux Wire Harness



Military-grade Aluminum



Anti-yellowing & anti-cracking clear-coated polycarbonate Lens





# DOWN LUX 7X3 LIGHT

A. Down Lux 7x3

A.

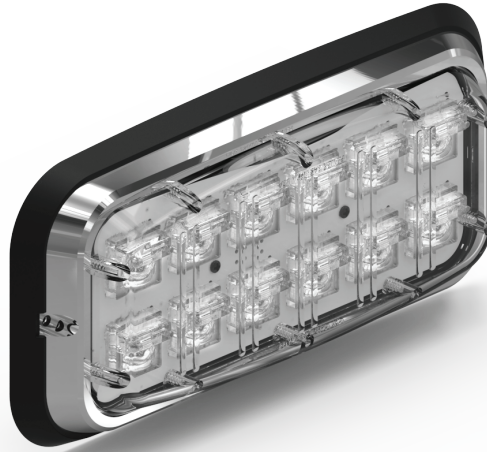

PART NUMBER	DIMENSIONS	VOLTAGE	CURRENT DRAW	LED COLORS
A. D-3700	3.75" x 8" x 1"	10-18 V DC	1 Amp	R B A W

**MOUNTING:**



**CERTIFICATIONS:**



**DESCRIPTION:**

Choose the Down Lux™ Series for the industry’s boldest, most intense scene lighting in an ultra-compact, slim design. The Down Lux features unique 50° optics with a downward projection, providing powerful visibility for any emergency scene. Available in white with a clear lens the Down Lux is the perfect led scene light for any firetruck, ambulance, or command vehicle in your fleet. The Down Lux meets or exceeds NFPA and KKK ambulance specifications.

- Available modes:
  - Flood mode
- Front or rear mounting options available
- Purchase includes 6x4 Down Lux, 4 # 6-32 x 3/16" screws, 2x back bracket mounts, 2x #10-24 x 1" bolts, 2x #6 x .5" screws, 2x hex nuts, 2x #10 flat washers
- 12x led count
- 180° light spread
- 9" cable harness
- Mounting hardware provided

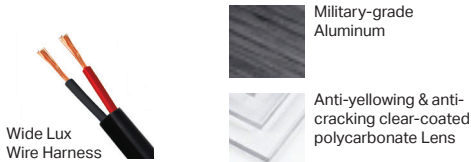



# AI SERIES 8" LIGHTBAR

A. AI Series 8" Lightbar



PART NUMBER	DIMENSIONS	VOLTAGE	CURRENT DRAW	LED COLORS
A. AI-0817	5.37" x 3.53" x 7.8"	11.5-15 V DC	6 Amps	W

**MOUNTING:**



**CONTROLLER:**



**CERTIFICATIONS:**



**DESCRIPTION:**

Popular for scene lighting, the Feniex AI Series offers up to 50,000 lumens of bright, powerful light. All AI Series lightbars are fully dimmable and controllable: go from full flood to spot with a turn of the controller or manually increase/decrease the brightness of your bar. Unlike any other lightbar on the market, the Feniex AI Series also offers a unique autonomous/ artificial intelligence feature capable of learning your driving habits and adjusting automatically and in real-time.

- 3 high power LEDs
- 4 modes & preset:
  - Custom mode
  - Focus mode
  - Dim mode
  - AI mode
  - Memory presets
- Integrated military-grade GPS (50Hz per second)
- Vehicle-specific brackets available
- Adjustable light spread between 10° and 60°
- 6,500 Lumens
- 125mA Standby current
- Purchase includes AI Series Lightbar, controller, swivel mount & hardware, RJ45 hub and cable, usb cable and antenna
- 13' wire harness
- Free Mac & Windows downloadable software

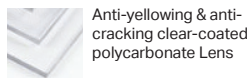
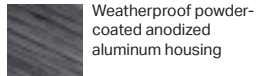





# AI SERIES 14" LIGHTBAR

A. AI Series 14" Lightbar

A.



PART NUMBER	DIMENSIONS	VOLTAGE	CURRENT DRAW	LED COLORS
A. AI-1417	5.37" x 3.53" x 14.06"	11.5-15 V DC	11 Amps	W

**MOUNTING:**



**CONTROLLER:**



**CERTIFICATIONS:**



**DESCRIPTION:**

Popular for scene lighting, the Feniex AI Series offers up to 50,000 lumens of bright, powerful light. All AI Series lightbars are fully dimmable and controllable: go from full flood to spot with a turn of the controller or manually increase/decrease the brightness of your bar. Unlike any other lightbar on the market, the Feniex AI Series also offers a unique autonomous/ artificial intelligence feature capable of learning your driving habits and adjusting automatically and in real-time.

- 6 high power LEDs
- 4 modes & preset:
  - Custom mode
  - Focus mode
  - Dim mode
  - AI mode
  - Memory presets
- Integrated military-grade GPS (50Hz per second)
- Vehicle-specific brackets available
- Adjustable light spread between 10° and 60°
- 12,500 Lumens
- 145mA Standby current
- Purchase includes AI Series Lightbar, controller, swivel mount & hardware, RJ45 hub and cable, usb cable and antenna
- 13' wire harness
- Free Mac & Windows downloadable software

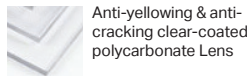
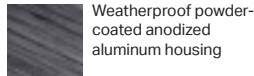



# AI SERIES 20" LIGHTBAR

A. AI Series 20" Lightbar

A.



PART NUMBER	DIMENSIONS	VOLTAGE	CURRENT DRAW	LED COLORS
A. AI-2017	5.37" x 3.53" x 20.32"	11.5-15 V DC	16 Amps	W

**MOUNTING:**



**CONTROLLER:**



**CERTIFICATIONS:**



**DESCRIPTION:**

Popular for scene lighting, the Feniex AI Series offers up to 50,000 lumens of bright, powerful light. All AI Series lightbars are fully dimmable and controllable: go from full flood to spot with a turn of the controller or manually increase/decrease the brightness of your bar. Unlike any other lightbar on the market, the Feniex AI Series also offers a unique autonomous/ artificial intelligence feature capable of learning your driving habits and adjusting automatically and in real-time.

- 9 high power LEDs
- 4 modes & preset:
  - Custom mode
  - Focus mode
  - Dim mode
  - AI mode
  - Memory presets
- Integrated military-grade GPS (50Hz per second)
- Vehicle-specific brackets available
- Adjustable light spread between 10° and 60°
- 19,000 Lumens
- 160mA Standby current
- Purchase includes AI Series Lightbar, controller, swivel mount & hardware, RJ45 hub and cable, usb cable and antenna
- 13' wire harness
- Free Mac & Windows downloadable software

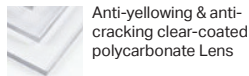
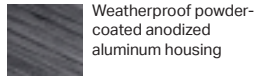



# AI SERIES 27" LIGHTBAR

A. AI Series 27" Lightbar

A.



PART NUMBER	DIMENSIONS	VOLTAGE	CURRENT DRAW	LED COLORS
A. AI-2717	5.37" x 3.53" x 26.58"	11.5-15 V DC	21 Amps	W

**MOUNTING:**



**CONTROLLER:**



**CERTIFICATIONS:**



**DESCRIPTION:**

Popular for scene lighting, the Feniex AI Series offers up to 50,000 lumens of bright, powerful light. All AI Series lightbars are fully dimmable and controllable: go from full flood to spot with a turn of the controller or manually increase/decrease the brightness of your bar. Unlike any other lightbar on the market, the Feniex AI Series also offers a unique autonomous/ artificial intelligence feature capable of learning your driving habits and adjusting automatically and in real-time.

- 9 high power LEDs
- 4 modes & preset:
  - Custom mode
  - Focus mode
  - Dim mode
  - AI mode
  - Memory presets
- Integrated military-grade GPS (50Hz per second)
- Vehicle-specific brackets available
- Adjustable light spread between 10° and 60°
- 25,000 Lumens
- 180mA Standby current
- Purchase includes AI Series Lightbar, controller, swivel mount & hardware, RJ45 hub and cable, usb cable and antenna
- 13' wire harness
- Free Mac & Windows downloadable software

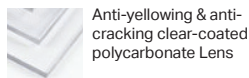
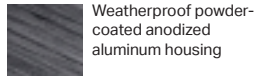



# AI SERIES 33" LIGHTBAR



A. AI Series 33" Lightbar

A.

PART NUMBER	DIMENSIONS	VOLTAGE	CURRENT DRAW	LED COLORS
A. AI-3317	5.37" x 3.53" x 32.84"	11.5-15 V DC	26 Amps	W

**MOUNTING:**



**CONTROLLER:**



**CERTIFICATIONS:**



**DESCRIPTION:**

Popular for scene lighting, the Feniex AI Series offers up to 50,000 lumens of bright, powerful light. All AI Series lightbars are fully dimmable and controllable: go from full flood to spot with a turn of the controller or manually increase/decrease the brightness of your bar. Unlike any other lightbar on the market, the Feniex AI Series also offers a unique autonomous/ artificial intelligence feature capable of learning your driving habits and adjusting automatically and in real-time.

- 12 high power LEDs
- 4 modes & preset:
  - Custom mode
  - Focus mode
  - Dim mode
  - AI mode
  - Memory presets
- Integrated military-grade GPS (50Hz per second)
- Vehicle-specific brackets available
- Adjustable light spread between 10° and 60°
- 31,000 Lumens
- 195mA Standby current
- Purchase includes AI Series Lightbar, controller, swivel mount & hardware, RJ45 hub and cable, usb cable and antenna
- 13' wire harness
- Free Mac & Windows downloadable software

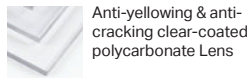
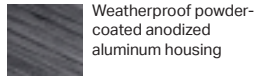



# AI SERIES 40" LIGHTBAR



A. AI Series 40" Lightbar

A.

PART NUMBER	DIMENSIONS	VOLTAGE	CURRENT DRAW	LED COLORS
A. AI-4017	5.37" x 3.53" x 39.1"	11.5-15 V DC	31 Amps	W

**MOUNTING:**



**CONTROLLER:**



**CERTIFICATIONS:**



**DESCRIPTION:**

Popular for scene lighting, the Feniex AI Series offers up to 50,000 lumens of bright, powerful light. All AI Series lightbars are fully dimmable and controllable: go from full flood to spot with a turn of the controller or manually increase/decrease the brightness of your bar. Unlike any other lightbar on the market, the Feniex AI Series also offers a unique autonomous/ artificial intelligence feature capable of learning your driving habits and adjusting automatically and in real-time.

- 18 high power LEDs
- 4 modes & preset:
  - Custom mode
  - Focus mode
  - Dim mode
  - AI mode
  - Memory presets
- Integrated military-grade GPS (50Hz per second)
- Vehicle-specific brackets available
- Adjustable light spread between 10° and 60°
- 37,500 Lumens
- 215mA Standby current
- Purchase includes AI Series Lightbar, controller, swivel mount & hardware, RJ45 hub and cable, usb cable and antenna
- 13' wire harness
- Free Mac & Windows downloadable software

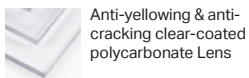
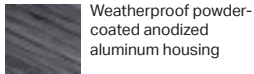



# AI SERIES 46" LIGHTBAR

A. AI Series 46" Lightbar

A.



PART NUMBER	DIMENSIONS	VOLTAGE	CURRENT DRAW	LED COLORS
A. AI-4617	5.37" x 3.53" x 45.36"	11.5-15 V DC	36 Amps	W

**MOUNTING:**



**CONTROLLER:**



**CERTIFICATIONS:**



**DESCRIPTION:**

Popular for scene lighting, the Feniex AI Series offers up to 50,000 lumens of bright, powerful light. All AI Series lightbars are fully dimmable and controllable: go from full flood to spot with a turn of the controller or manually increase/decrease the brightness of your bar. Unlike any other lightbar on the market, the Feniex AI Series also offers a unique autonomous/ artificial intelligence feature capable of learning your driving habits and adjusting automatically and in real-time.

- 21 high power LEDs
- 4 modes & preset:
  - Custom mode
  - Focus mode
  - Dim mode
  - AI mode
  - Memory presets
- Integrated military-grade GPS (50Hz per second)
- Vehicle-specific brackets available
- Adjustable light spread between 10° and 60°
- 44,000 Lumens
- 230mA Standby current
- Purchase includes AI Series Lightbar, controller, swivel mount & hardware, RJ45 hub and cable, usb cable and antenna
- 13' wire harness
- Free Mac & Windows downloadable software

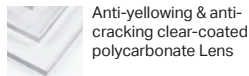
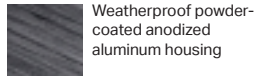





# AI SERIES 52" LIGHTBAR

A. AI Series 52" Lightbar

A.



PART NUMBER	DIMENSIONS	VOLTAGE	CURRENT DRAW	LED COLORS
A. AI-5217	5.37" x 3.53" x 51.62"	11.5-15 V DC	41 Amps	W

**MOUNTING:**



**CONTROLLER:**



**CERTIFICATIONS:**



**DESCRIPTION:**

Popular for scene lighting, the Feniex AI Series offers up to 50,000 lumens of bright, powerful light. All AI Series lightbars are fully dimmable and controllable: go from full flood to spot with a turn of the controller or manually increase/decrease the brightness of your bar. Unlike any other lightbar on the market, the Feniex AI Series also offers a unique autonomous/ artificial intelligence feature capable of learning your driving habits and adjusting automatically and in real-time.

- 24 high power LEDs
- 4 modes & preset:
  - Custom mode
  - Focus mode
  - Dim mode
  - AI mode
  - Memory presets
- Integrated military-grade GPS (50Hz per second)
- Vehicle-specific brackets available
- Adjustable light spread between 10° and 60°
- 50,000 Lumens
- 250mA Standby current
- Purchase includes AI Series Lightbar, controller, swivel mount & hardware, RJ45 hub and cable, usb cable and antenna
- 13' wire harness
- Free Mac & Windows downloadable software

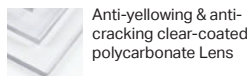
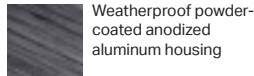



# AI CUBE SCENE LIGHT

A. AI Cube Scene Light



PART NUMBER	DIMENSIONS	VOLTAGE	CURRENT DRAW	LED COLORS
A. AI-1018	3" x 3" x 3"	9-17 V DC	3 Amps	W ■

**MOUNTING:**

Built-in bracket



**CERTIFICATIONS:**



**DESCRIPTION:**

The AI Series is a revolution in off-road technology: this is the world's most innovative cube light. No need to choose between beam patterns or from an entire series of pod lights: the AI Cube is completely dimmable and focus-adjustable up to an astounding 2,100 lumens. This single pod light adjusts between scene, driving, flood, spot and hyperspot to maintain visibility in any race or any environment.

- 1 high power LEDs
- Adjust between:
  - Scene lighting
  - Drive lighting
  - Hyperspot lighting
  - Flood lighting
  - Spot lighting
- Adjustable light spread between 10° and 60°
- 2,100 Lumens
- 10" wire harness



AI Wire Harness

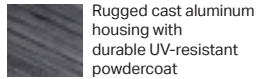

Rugged cast aluminum housing with durable UV-resistant powdercoat



Shatter-proof polycarbonate Lens



4X

Flasher

Feniex Industries, Inc.  
1.800.615.8350

# 4X FLASHER

A. 4X Flasher

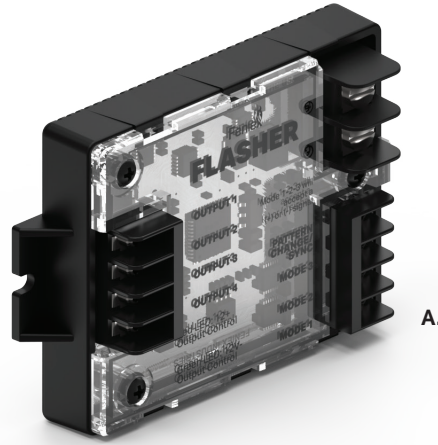

PART NUMBER	DIMENSIONS	VOLTAGE	FLASH PATTERNS	MAX CURRENT OUTPUT
A. H-2220	4" x 2.6" x 1"	10-18 V DC	20 positive & 20 negative	20 Amps

**COMPATIBILITY:**

Fusion-S Surface Mount



Quad Surface Mount



T3 Surface Mount



Cannon Hide-a-way



**CERTIFICATIONS:**



**DESCRIPTION:**

The Feniex 4x Flasher is a versatile 4-channel LED flasher that offers 40 patterns in a compact footprint. Its solid-state design allows for compatibility with both positive and ground switched LED modules. Compatible with all emergency response vehicles, the Flasher's three modes make it flexible enough to function as both a warning and/or indication controller.

- Short circuit protection and over temperature protection
- Compatible with halogen and led lighting products
- Integrated steady-on brake-pop feature
- LED flash pattern indicator
- 3 programmable modes
- 4 outputs rated at 5 Amps each
- Syncs with other compatible flashers & lights



Anti-yellowing & anti-cracking clear-coated polycarbonate Lens



Military-grade Aluminum Base

Feniex Industries, Inc.  
1.800.615.8350

---

**Product Guide**  
Feniex Catalog

FENIEX INDUSTRIES IS A USA MANUFACTURER OF VISUAL  
AND AUDIO EMERGENCY VEHICLE WARNING PRODUCTS.  
LOCATED IN THE HEART OF TEXAS, FENIEX IS THE FASTEST  
GROWING EMERGENCY VEHICLE MANUFACTURER.



FENIEX CHANGES LIVES BY MANUFACTURING INNOVATIVE,  
AMERICAN-MADE PRODUCTS FOR THE WORLD'S TOUGHEST  
JOBS.



**FENIEX**

MADE IN THE USA.  
PREMIER VEHICLE LIGHTING