

# SIEMENS

List of corrections, 10-06-2022

SIVACON S8 – technical informations for planning, release 12/21

## **Chapter 3.2 - Cubicles with two ACBs (3WA)**

The actual print-document of these planning manual shows wrong information for the cubicle-width with two ACBs as combination of two independent incoming- or outgoing circuit-breakers.

The cubicle width is :

- 600 mm (3WA11)
- 800 mm (3WA12)

## **Chapter 3.4 - Cubicles with one MCCB (3VA)**

The shown current in tab 3/17 for cubicles with circuit-breakers 3VA1563 contain wrong information in non-ventilated construction:

- 590 A (Busbar connection at the top, cable connection from the bottom)
- 580 A (Busbar connection at the rear, cable connection from the bottom)
- 570 A (Busbar connection at the rear, cable connection from the top)

The corresponding online-document of these planning manual was updated in 06/2022.



TOTALLY INTEGRATED POWER

# SIVACON S8

Technical Planning  
Information

**SIEMENS**

# SIVACON S8

Technical Planning Information

System-Based Power Distribution	1
SIVACON S8 System Overview	2
Circuit-Breaker Design	3
Universal Mounting Design	4
In-Line Design, Plug-in	5
Fixed-Mounted Design	6
Reactive Power Compensation	7
Communication Connection	8
Further Planning Notes	9
Conformance to Standards and Design Verification	10
Technical Annex	11
Glossary and Rated Values	12

# Contents

<b>1</b>	<b>System-Based Power Distribution</b>	<b>1</b>	<b>8</b>	<b>Communication Connection</b>	<b>79</b>
<b>2</b>	<b>SIVACON S8 System Overview</b>	<b>5</b>	8.1	Serial Fieldbus Systems	81
2.1	System Configuration and Cubicle Design	8	8.2	Industrial Ethernet-Based Fieldbus Systems	83
2.2	Corner Cubicle	13	8.3	Gateways	85
2.3	Horizontal Main Busbar	14	8.4	SIVACON S8-Specific Network Installation for Ethernet-Based Protocols	87
2.4	Earthing and Short-Circuiting Points	15	8.5	Data Visualization and Processing	90
2.5	Overview of Mounting Designs	16	<b>9</b>	<b>Further Planning Notes</b>	<b>95</b>
<b>3</b>	<b>Circuit-Breaker Design</b>	<b>19</b>	9.1	Installation	96
3.1	Cubicles with One ACB (3WA)	22	9.2	Weights and Power Losses	102
3.2	Cubicles with Two ACBs (3WA)	29	9.3	Environmental Conditions	103
3.3	Cubicles with up to Three ACBs	32	<b>10</b>	<b>Conformance to Standards and Design Verification</b>	<b>105</b>
3.4	Cubicles with One MCCB (3VA)	33	10.1	Product Standard IEC 61439-2	106
3.5	Cubicles for Direct Incoming Feeder / Direct Outgoing Feeder	34	10.2	Arc Resistance	107
<b>4</b>	<b>Universal Mounting Design</b>	<b>35</b>	10.3	Seismic Withstand Capability and Seismic Requirements	111
4.1	Fixed-Mounted Design with Compartment Door	39	10.4	Declarations of Conformity and Certificates	113
4.2	In-Line Switch-Disconnectors with Fuses (3NJ63, SASILplus)	40	<b>11</b>	<b>Technical Annex</b>	<b>119</b>
4.3	Withdrawable Design	40	11.1	Network Systems According to the Type of Earth Connection	120
<b>5</b>	<b>In-Line Design, Plug-in</b>	<b>51</b>	11.2	Loads and Dimensioning	123
5.1	In-Line Switch-Disconnectors with Fuses 3NJ63	53	11.3	Degrees of Protection According to IEC 60529	125
5.2	In-Line Switch-Disconnectors with Fuses SASILplus	56	11.4	Forms of Internal Separation According to IEC 61439-2	126
<b>6</b>	<b>Fixed-Mounted Design</b>	<b>59</b>	11.5	Operating Currents of Three-Phase Asynchronous Motors	127
6.1	In-Line Design, Fixed-Mounted	60	11.6	Three-Phase Distribution Transformers	128
6.2	Fixed-Mounted Design with Front Cover	63	<b>12</b>	<b>Glossary and Rated Values</b>	<b>129</b>
6.3	Freely Configured Fixed-Mounted Design	67	12.1	Term Explanations	130
6.4	Frequency Converter Design	69	12.2	Rated Values	132
<b>7</b>	<b>Reactive Power Compensation</b>	<b>73</b>	12.3	List of Tables	134
7.1	Configuration and Calculation	76	12.4	List of Figures	136
7.2	Separately Installed Compensation Cubicles	78			

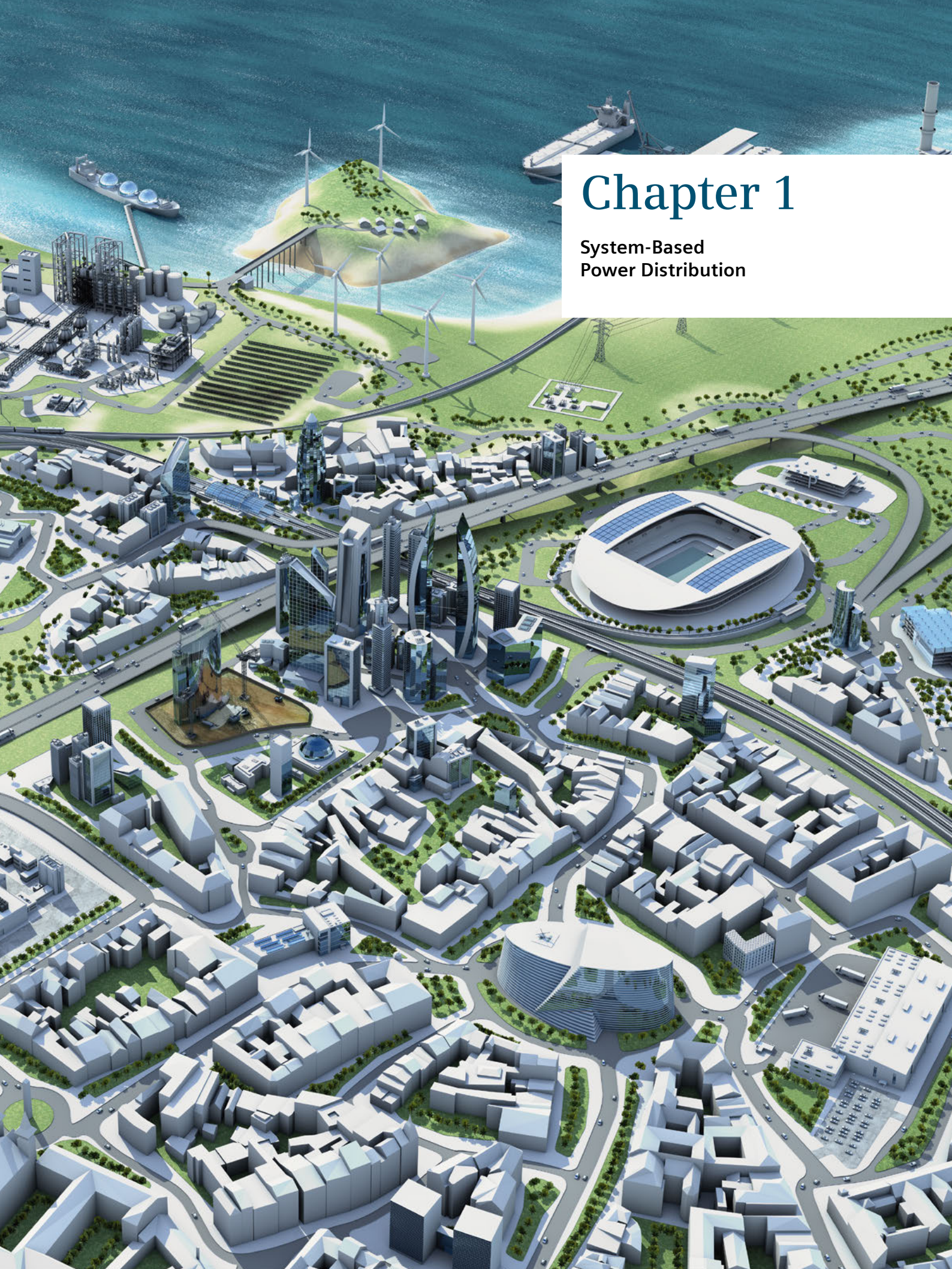

# Chapter 1

System-Based  
Power Distribution

# 1 System-Based Power Distribution

When a power distribution concept is to be developed which includes dimensioning of systems and devices, its requirements and feasibility have to be matched by the end user and the manufacturer. We have prepared this planning manual for the SIVACON S8 low-voltage switchboard to support you with this task. Three principles must be observed for optimal power distribution:

- Safety – integrated
- Cost-efficiency – right from the start
- Flexibility – through modularity.

Comparable to a main artery, electric power supply constitutes the basis for reliable and efficient functioning of all electrically operated facilities. Electric power distribution requires integrated solutions. Totally Integrated Power (TIP) is a synonym for integrated electric power distribution (Fig. 1/1) in industrial applications, infrastructure projects, and buildings.

Further information on TIP:  
[www.siemens.com/tip](http://www.siemens.com/tip)

## SIMARIS planning tools

The SIMARIS planning tools by Siemens provide efficient support for dimensioning electric power distribution systems and determine the devices and distribution boards required for them:

- SIMARIS design for network calculation and dimensioning
- SIMARIS project for determining the space requirements of the power distribution system, and for generating specifications
- SIMARIS curves for visualizing characteristic tripping curves as well as let-through current and let-through energy curves.

SIMARIS Suite is the platform for your uniform access to all SIMARIS planning tools. In addition you will obtain the latest information on the subject and be able to access support documents and videos.

Further information on SIMARIS:  
[www.siemens.com/simaris](http://www.siemens.com/simaris)

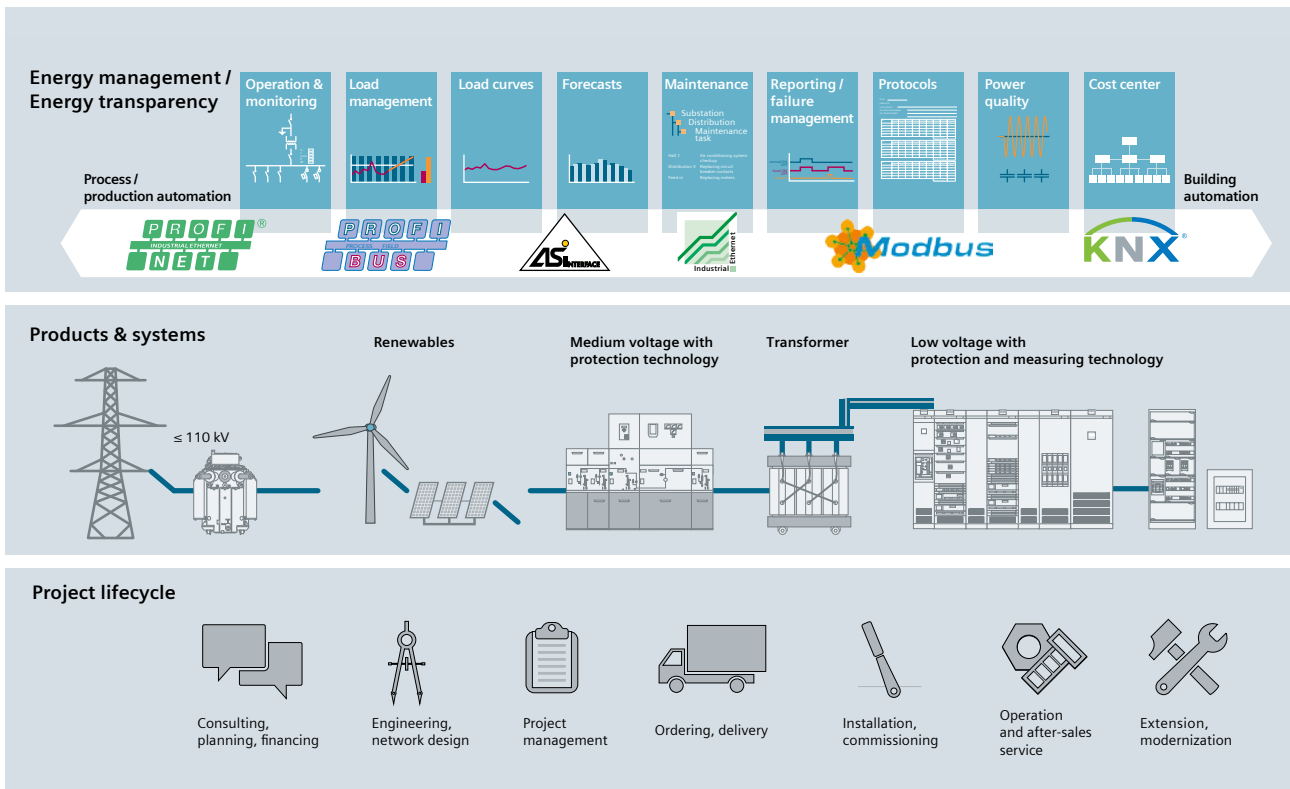

Fig. 1/1: Totally Integrated Power (TIP) as a holistic approach to electric power distribution

## SIMARIS engineering tools

Configuring and dimensioning a low-voltage switchboard is very complex. SIVACON S8 switchboards are configured by experts, effectively supported by the SIMARIS engineering tools. The following tools offer support during the stages of switchboard manufacture, operation and maintenance:

- SIMARIS configuration for offer preparation, order processing, and manufacture of the SIVACON S8 switchboard
- SIMARIS control for visualization and diagnostics station for operation and monitoring as well as for support during preventive and general maintenance of the SIVACON S8 switchboard.

## Cost-efficient complete system

The SIVACON S8 low-voltage switchboard sets new standards worldwide as a power distribution board (PDB) in infrastructure or motor control centers (MCC) for industrial applications (Fig. 1/2). The switchboard system up to 7,000 A for easy and integrated power distribution ensures maximum safety for personnel and equipment, and provides many possibilities for use thanks to its optimal design. Its modular design allows the switchboard to be optimally matched to any requirement when the whole system is set up. Maximum safety and modern design now complement each other in an efficient switchboard.

## Tested safety

SIVACON S8 is a synonym for safety at the highest level. The low-voltage switchboard is a design verified in accordance with IEC 61439-2. Design verification is performed by testing. Its physical properties were verified in the testing station both for operating and fault situations. Maximum personell safety is also ensured by a test verification under conditions of arcing in accordance with IEC/TR 61641.

## Flexible solutions

The SIVACON S8 switchboard is the intelligent solution which adapts itself to your requirements. The combination of different mounting designs within one cubicle is easily possible. The flexible modular design allows functional units to be easily replaced or added. All SIVACON S8 components are subject to a continuous innovation process, and the complete system always reflects the highest level of technical progress.

Further information on SIVACON S8:  
[www.siemens.com/sivacon-s8](http://www.siemens.com/sivacon-s8)

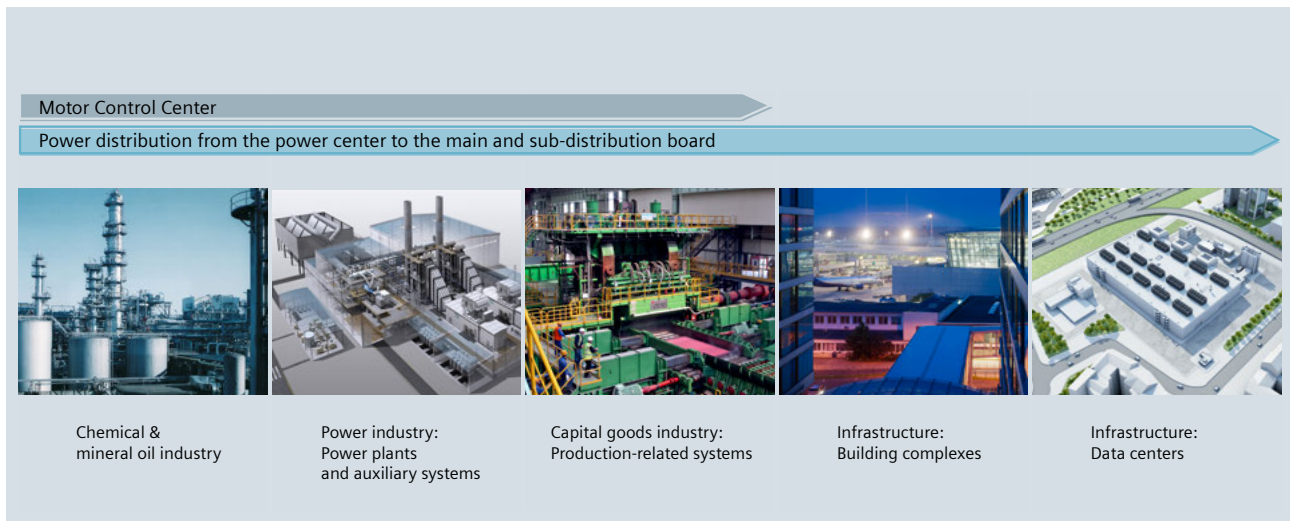

Fig. 1/2: SIVACON S8 for all areas of application

## Use

SIVACON S8 can be used for all application levels in the low-voltage network (Fig. 1/3):

- Power center or transformer substation
- Main switchboard or main distribution board
- Sub-distribution board, motor control center, distribution board for installation devices or industrial use.

## Advantages of modular design

Every SIVACON S8 switchboard is manufactured from demand-oriented, standardized and series-produced components. All components are tested and of a high quality. Virtually every requirement can be satisfied due to the manifold component combination options. Adaptations to new performance requirements can easily and rapidly be implemented by replacing or adding components.

The advantages offered by this modular concept are clear:

- Verification of safety and quality for every switchboard
- Fulfilment of each and every requirement profile combined with the high quality of series production
- Easy placement of repeat orders and a short delivery time.

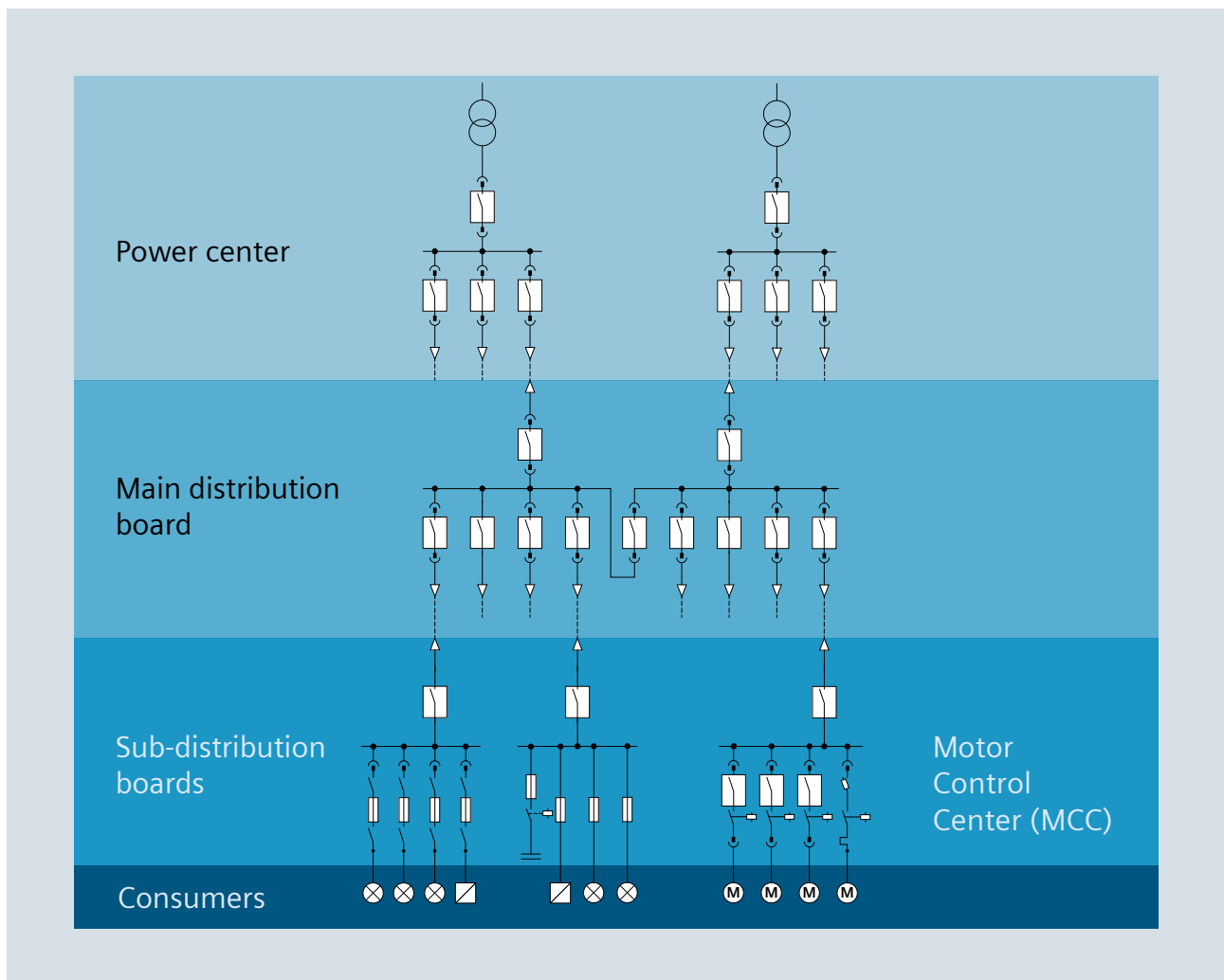

Fig. 1/3: Use of SIVACON S8 in power distribution



# Chapter 2

## SIVACON S8 System Overview

2.1	System Configuration and Cubicle Design	8
2.2	Corner Cubicle	13
2.3	Horizontal Main Busbar	14
2.4	Earthing and Short-Circuiting Points	15
2.5	Overview of Mounting Designs	16



## 2 SIVACON S8 System Overview

The interaction of the components described below results in an optimal low-voltage switchboard with advantages as regards:

- Safety – integrated
- Cost-efficiency – right from the start
- Flexibility – through modularity.

Standards and approvals		
Standards and specifications	Power switchgear and controlgear assembly (design verification)	IEC 61439-2 DIN EN 61439-2 VDE 0660-600-2
	Testing under conditions of arcing due to internal fault	IEC/TR 61641 DIN EN 61439-2 Supplement 1 VDE 0660-600-2 Supplement 1
	Induced vibrations	IEC 60068-3-3 IEC 60068-2-6 IEC 60068-2-57 IEC 60980 KTA 2201.4 Uniform Building Code (UBC), Edition 1997 Vol. 2, Ch. 19, Div. IV
	Protection against electric shock	EN 50274 (VDE 0660-514)
Approvals and certifications	European Union	CE marking and EC Declaration of Conformity
	Great Britain	UK Conformity Assessed
	Eurasian Economic Union	EAC (Eurasian Conformity)
	China	CCC (China Compulsory Certification)
	Det Norske Veritas	DNV GL Type Approval Certificate
Technical data		
Installation conditions	Indoor installation, ambient temperature in the 24-h mean	+ 35 °C (-5 °C to + 40 °C)
Main circuit	Rated operational voltage $U_e$	Up to 690 V (nominal frequency $f_n$ : 50 Hz)
Dimensioning of clearances and creepage distances	Rated impulse withstand voltage $U_{imp}$	12 kV (depending on the type of design)
	Rated insulation voltage $U_i$	1,000 V
	Pollution degree	3
Main busbars, horizontal	Rated current	Up to 7,010 A
	Rated peak withstand current $I_{pk}$	Up to 330 kA
	Rated short-time withstand current $I_{cw}$	Up to 150 kA, 1 s
Rated device currents	Circuit-breaker	Up to 6,300 A
	Cable feeders	Up to 630 A
	Motor feeders	Up to 630 A
Internal separation	IEC 61439-2	Form 1 to form 4
	BS EN 61439-2	Up to form 4b type 7
IP degree of protection	In accordance with IEC 60529	Ventilated up to IP43 Non-ventilated IP54
Mechanical strength	IEC 62262	Up to IK10
Dimensions	Height (without base):	2,000; 2,200 mm
	Height of base (optional):	100; 200 mm
	Cubicle width:	200; 350; 400; 600; 800; 850; 1,000; 1,200; 1,400 mm
	Depth (single front):	500; 600; 800 mm
	Depth (double front):	1,000; 1,200 mm

Tab. 2/1: Technical data, standards and approvals for the SIVACON S8 switchboard

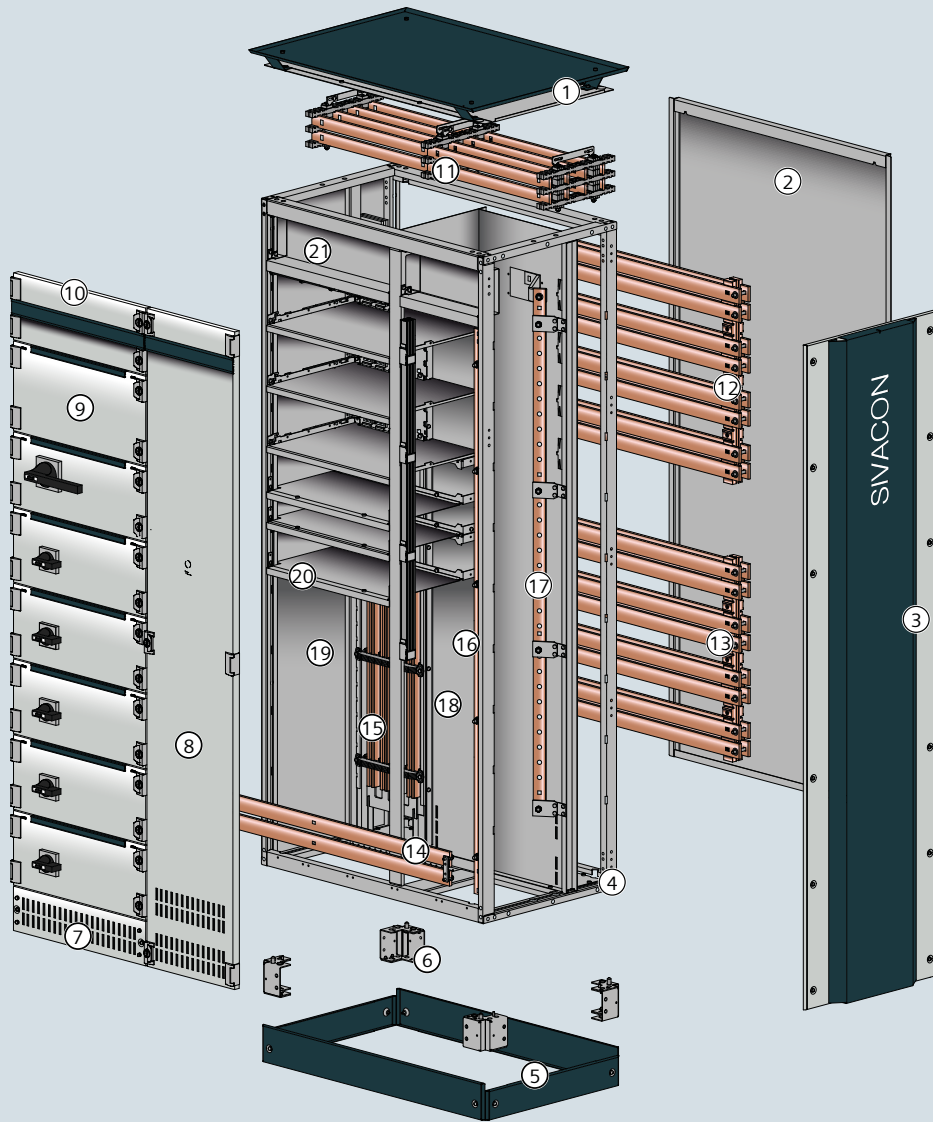

#### Enclosure

- ① Roof plate
- ② Rear wall
- ③ Design side wall
- ④ Frame
- ⑤ Base cover
- ⑥ Base
- ⑦ Base compartment cover, ventilated
- ⑧ Cubicle door, ventilated
- ⑨ Compartment door
- ⑩ Head compartment door

#### Busbars

- ⑪ Main busbar (L1... L3, N) – top
- ⑫ Main busbar (L1... L3, N) – rear-top
- ⑬ Main busbar (L1... L3, N) – rear-bottom
- ⑭ Main busbar (PE) – bottom
- ⑮ Distribution busbar (L1... L3, N) - device compartment
- ⑯ Distribution busbar (PE) - cable compartment
- ⑰ Distribution busbar (N) - cable compartment

#### Internal separation

- ⑱ Device compartment / busbar compartment
- ⑲ Cubicle to cubicle
- ⑳ Compartment to compartment
- ㉑ Cross-wiring compartment

Fig. 2/1: Cubicle design of SIVACON S8

## 2.1 System Configuration and Cubicle Design

When the system configuration is planned, the following characteristics must be specified:

- Busbar position (top, rear-top, rear-bottom, or both rear-top and rear-bottom)
- Single-front or double-front design
- Position of cable / busbar entry (from bottom or from top)
- Connection in cubicle (front or rear).

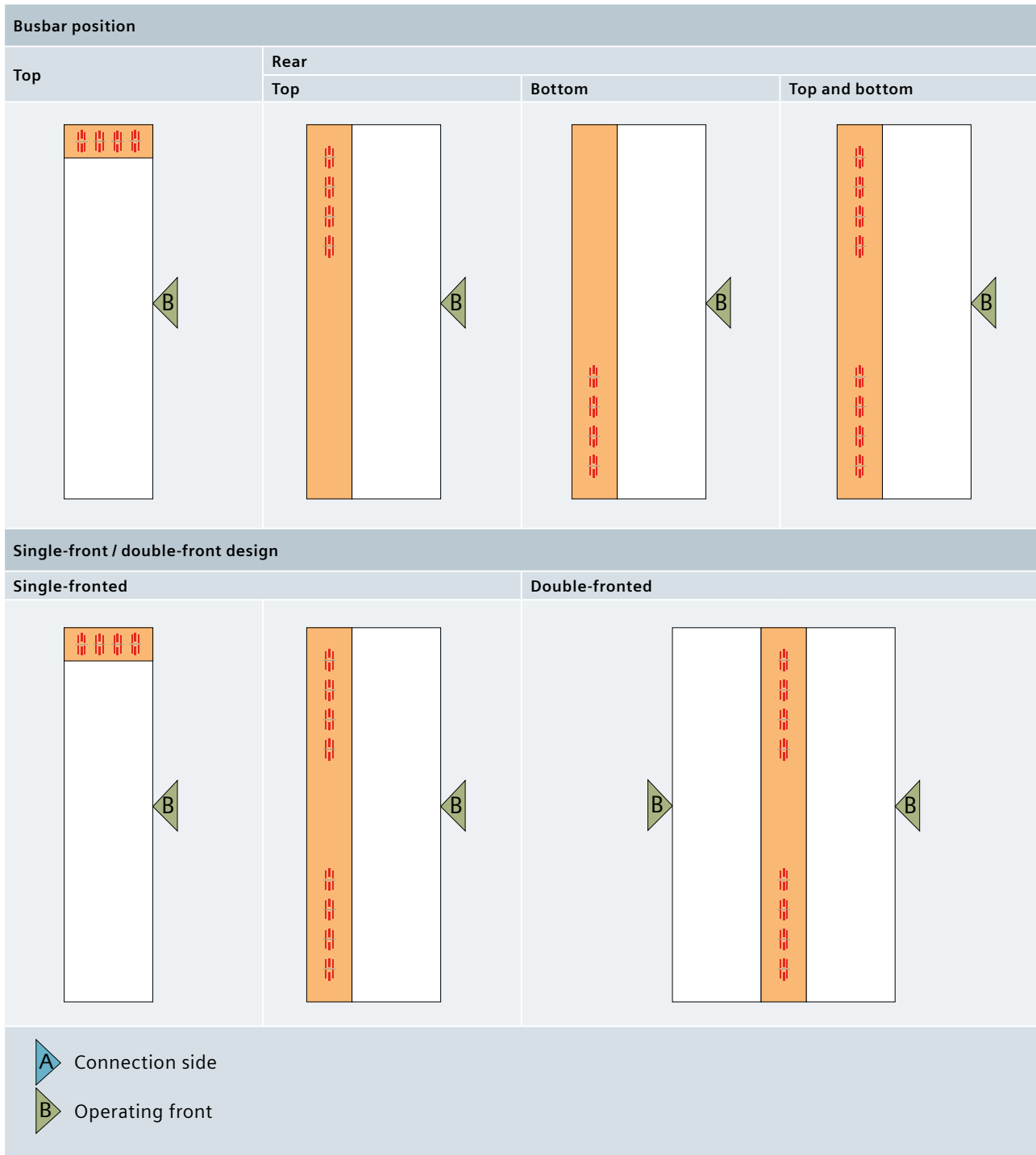

Tab. 2/2: Schematic overview of the switchboard configuration for SIVACON S8

Among other things, these characteristics depend on the type of installation:

- Stand-alone
- At the wall (only for single-front design)
- Back-to-back (only for single-front design).

These determinations allow to specify the cubicle design in more detail (Fig. 2/1, Tab. 2/2 and Tab. 2/3). Further information on installation can be found in Chapter 8 (Further planning notes).

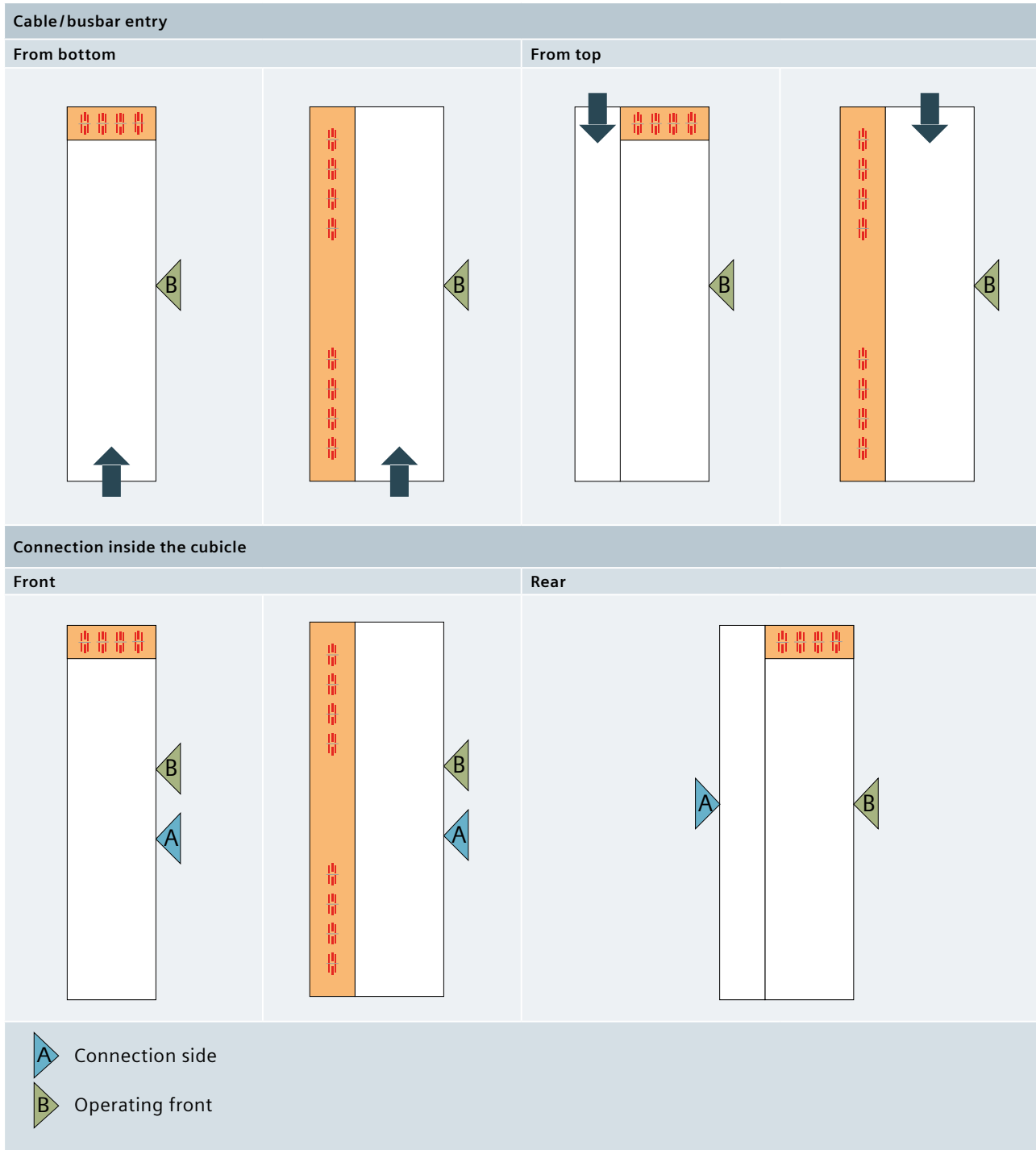

Busbar position at the top		
Busbar system		Cubicle design
Busbar position Rated current Cable / busbar entry Connection inside the cubicle	Top Up to 3,270 A Bottom Front	
Busbar position Rated current Cable / busbar entry Connection inside the cubicle	Top Up to 3,270 A Top Front or rear	
Busbar position Rated current Cable / busbar entry Connection inside the cubicle	Top Up to 6,300 A Bottom Front	
Busbar position Rated current Cable / busbar entry Connection inside the cubicle	Top Up to 6,300 A Top Front or rear	

Device / functional compartment
  Busbar compartment
  Cable / busbar compartment
  Cross-wiring compartment
 
▶
 Operating fronts

Tab. 2/3: Cubicle types and busbar arrangement in the cubicles

Busbar position at the rear		
Busbar system		Cubicle design
Busbar position Rated current Cable / busbar entry Connection inside the cubicle	Rear top or bottom, top and bottom Up to 4,000 A Bottom or top Front	
Busbar position Rated current Cable / busbar entry Connection inside the cubicle	Rear top or bottom Up to 7,010 A Bottom or top Front	
Busbar position Rated current Cable / busbar entry Connection inside the cubicle	Rear top or bottom, top and bottom Up to 6,300 A Bottom or top Front	
Busbar position Rated current Cable / busbar entry Connection inside the cubicle	Rear top or bottom Up to 7,010 A Bottom, top Front	
<div style="display: flex; justify-content: space-between; align-items: center;"> <div style="display: flex; gap: 10px;"> <div style="width: 20px; height: 20px; background-color: #004a99; border: 1px solid black;"></div> Device / functional compartment           </div> <div style="display: flex; gap: 10px;"> <div style="width: 20px; height: 20px; background-color: #ff9933; border: 1px solid black;"></div> Busbar compartment           </div> <div style="display: flex; gap: 10px;"> <div style="width: 20px; height: 20px; background-color: #cccccc; border: 1px solid black;"></div> Cable / busbar compartment           </div> <div style="display: flex; gap: 10px;"> <div style="width: 20px; height: 20px; background-color: #ffffff; border: 1px solid black;"></div> Cross-wiring compartment           </div> <div style="display: flex; gap: 10px;"> <div style="font-size: 20px;">▷</div> Operating fronts           </div> </div>		

1
2
3
4
5
6
7
8
9
10
11
12

Cubicle height					
Frame	2,000; 2,200 mm				
Base	Without; 100; 200 mm				
Cubicle width					
Depending on:	- Cubicle type - Rated current of the devices - Connection position and/or cable / busbar entry				
Cubicle depth					
Design	Main busbar		Cubicle depth		
	Position	Rated current	Front connection		Rear connection
			Entry from bottom	Entry from top	
Single-fronted	Top	3,270 A	500; 800 mm	800 mm	800 mm
		6,300 A	800; 1,000 mm	1,200 mm	1,200 mm
	Rear	4,000 A	600 mm	600 mm	-
		7,010 A	800 mm	800 mm	-
Double-fronted	Rear	4,000 A	1,000 mm	1,000 mm	-
		7,010 A <sup>1)</sup>	1,200 mm	1,200 mm	-

<sup>1)</sup> Frame height 2,200 mm

Tab. 2/4: Cubicle dimensions

The cubicle dimensions listed in Tab. 2/4 do not factor in the enclosure parts and any outer built-on parts.

For the dimensions of the cubicles' enclosure parts, please refer to Fig. 2/2. For degrees of protection IPX1 and IPX3, additional ventilation roof plates are mounted on the cubicle.

The dimensions of the enclosure parts are within the required minimum distances for installing the switch-board. Doors can be fitted so that they close in escape direction. The door hinge can easily be changed later. The door hinges allow for a door opening angle of up to 180° in case of single installation of a cubicle and at least 125° when cubicles are grouped. For more information, see Chapter 9 (Further Planning Notes). The condition of surfaces of structural and enclosure parts is described in Tab. 2/5.

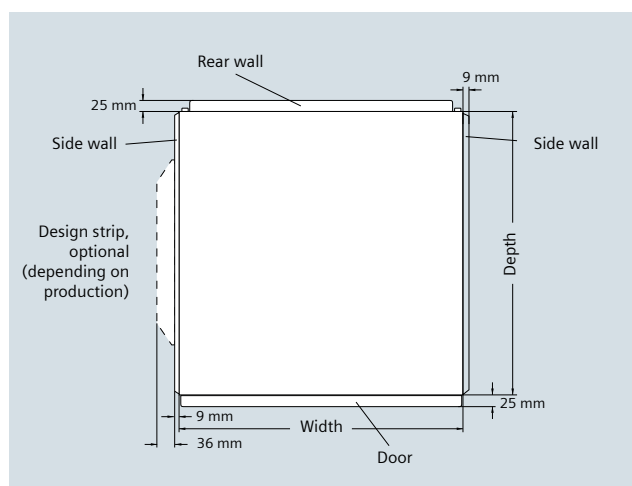

Fig. 2/2: Dimensions of the enclosure parts

Surface treatment	
Frame components	Sendzimir-galvanized
Enclosure	Sendzimir-galvanized / powder-coated
Doors	Powder-coated
Copper bars	Bare copper, optionally silver-plated, optionally tinned, insulated
Color	
Powder-coated components (layer thickness 100 ± 25 µm)	RAL7035, light gray (in accordance with DIN 43656) or upon request
Design parts	Blue Green Basic

Tab. 2/5: Surface treatment



## 2.2 Corner Cubicle

The corner cubicle connects two segments, positioned at right angles to each other, of a switchboard in single-front design (Fig. 2/3). The corner cubicle contains as functional compartments only the busbar compartment and the cross-wiring compartment. These compartments are not accessible through doors. In Tab. 2/6, the frame widths and/or frame depths of a corner cubicle are listed depending on the cubicle depth.

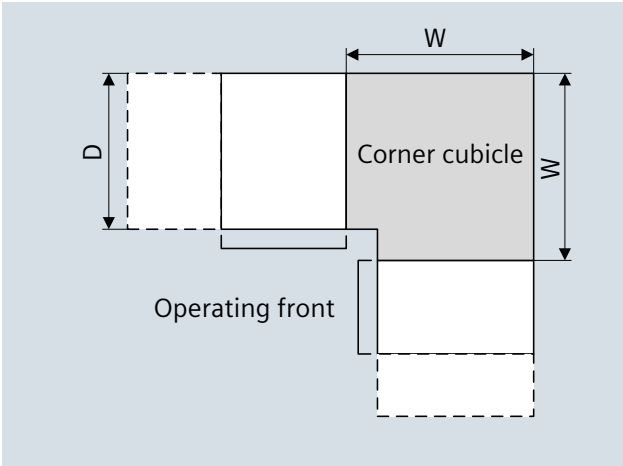

Fig. 2/3: Integration of a corner cubicle

Cubicle depth D	Frame width / frame depth W for a corner cubicle
500 mm	600 mm
600 mm	700 mm
800 mm	900 mm
1,200 mm	900 mm

Tab. 2/6: Dimensions of the corner cubicle

1

2

3

4

5

6

7

8

9

10

11

12

## 2.3 Horizontal Main Busbar

For the two possibilities of how to position the main busbar – top or rear – (Fig. 2/4), the rated operational currents and the rated short-time withstand current are listed in Tab. 2/7. Chapter 10 describes how ambient temperatures must be observed for the current-carrying capacity.



Fig. 2/4: Variable busbar position for SIVACON S8

Busbar position at the top		
Rated operational current $I_e$ at an ambient temperature of 35 °C		Rated short-time withstand current $I_{cw}$ (1 s)
Ventilated	Non-ventilated	
1,190 A	965 A	35 kA
1,630 A	1,310 A	50 kA
1,920 A	1,480 A	65 kA
2,470 A	1,870 A	85 kA
3,010 A	2,250 A	100 kA
3,270 A	2,450 A	100 kA
3,700 A <sup>1)</sup>	3,000 <sup>1)</sup>	100 kA
4,660 A <sup>1)</sup>	3,680 A <sup>1)</sup>	100 kA
5,620 A <sup>1)</sup>	4,360 A <sup>1)</sup>	150 kA
6,300 A <sup>1)</sup>	4,980 A <sup>1)</sup>	150 kA
<sup>1)</sup> Correction factors to be applied when circuit-breakers with a very high power loss are used: 3WA1350: 0.95 3WA1363: 0.88		
Busbar position at the rear <sup>1)</sup>		
Rated operational current $I_e$ at an ambient temperature of 35 °C		Rated short-time withstand current $I_{cw}$ (1 s)
Ventilated	Non-ventilated	
1,280 A	1,160 A	50 kA
1,630 A	1,400 A	65 kA
2,200 A	1,800 A	65 kA
2,520 A	2,010 A	85 kA
2,830 A	2,210 A	100 kA
3,170 A	2,490 A	100 kA
4,000 A	3,160 A	100 kA
4,910 A <sup>2)</sup>	3,730 A <sup>2)</sup>	100 kA
5,340 A <sup>2)</sup>	4,080 A <sup>2)</sup>	100 kA
5,780 A <sup>2)</sup>	4,440 A <sup>2)</sup>	100 kA
7,010 A <sup>2)</sup>	5,440 A <sup>2)</sup>	150 kA
<sup>1)</sup> Derating factors to be considered for simultaneous operation of two systems per cubicle (busbar position rear-top and rear-bottom): For ventilated switchboards: 0.94 For non-ventilated switchboards: 0.98 <sup>2)</sup> Busbar position rear-top or rear-bottom		

Tab. 2/7: Operational ratings of the main busbar

## 2.4 Earthing and Short-Circuiting Points

### Short-circuiting and earthing device (SED)

For short-circuiting and earthing, short-circuiting and earthing devices (SED) are available. For mounting the SED, appropriate fastening points are fitted at the points to be earthed. For the SED on the main busbar side, a cubicle for freely configured fixed-mounted designs is used (see Chapter 6.3: Freely Configured Fixed-Mounted Design). The cubicle widths are given in Tab. 2/8.

### Central earthing point (CEP) and main earthing busbar (MEB)

When voltage sources, which are located far apart, are earthed, for example transformer substation and emergency generating set, the individual earthing of their neutral points results in compensating currents through foreign conductive building structures. Undesired electromagnetic interference is created, caused by the building currents on the one hand and the lack of summation current in the respective cables on the other.

If the requirement is parallel operation of several voltage sources and if building currents shall be reduced as far as possible, the preferable technical solution is the use of the central earthing point (CEP). In this case, the neutral points of all voltage sources are connected to the system protective conductor / system earth at a single point only. The effect is that, despite potential differences of the neutral points, building currents cannot develop any more.

Earthing and short-circuiting points	Cubicle widths
Short-circuiting and earthing device (SED)	400 mm (200 mm as cubicle extension)
Central earthing point (CEP)	600 mm; 1,000 mm (200 mm as cubicle extension)
Main earthing busbar (MEB)	600; 1,000 mm

Tab. 2/8: Cubicle widths for earthing and short-circuiting points

The central earthing point can only be used in the network system L1, L2, L3, PEN (isolated) + PE. To implement the central earthing point (CEP) – with or without a main earthing busbar (MEB) – a cubicle for freely configured fixed-mounted design is used (see Chapter 6.3).

### CEP design

The CEP is designed as a bridge between the isolated PEN (laid separately) and the PE conductor of the switchboard. Measuring current transformers can be mounted on the bridge for differential current measurements. In order to be able to remove the current transformer in case of a defect, a second, parallel bridge is provided. This prevents canceling the protective measure due to a missing connection between the isolated PEN and the PE conductor.

A mounting plate in the cubicle is provided for placing the differential current monitoring devices. The cubicle widths are given in Tab. 2/8.

### MEB design

As an option to the central earthing point, the MEB can be mounted as a horizontal busbar. This connection busbar is installed in an isolated way in the cubicle and rigidly connected to the PE conductor. Depending on how the cable is entered, the MEB is installed at the top or bottom of the cubicle. The cubicle widths can be found in Tab. 2/8 and information on the cable connections can be found in Tab. 2/9.

Cubicle width	Max. number of connectable cables with cable lugs (screws) acc. to DIN 46235
600 mm	10 x 185 mm <sup>2</sup> (M10) + 12 x 240 mm <sup>2</sup> (M12) <sup>1)</sup>
1,000 mm	20 x 185 mm <sup>2</sup> (M10) + 22 x 240 mm <sup>2</sup> (M12) <sup>1)</sup>

<sup>1)</sup> 300 mm<sup>2</sup> cable lugs with bolt M12 can be used. However, this cable lug does not comply with DIN 46235, although it is available at some manufacturers.

Tab. 2/9: Cable connection for the main earthing busbar

## 2.5 Overview of Mounting Designs



	Circuit-breaker design	Arc fault protection design	Universal mounting design	Frequency converter design
<b>Mounting design</b>	Withdrawable design, fixed mounted design	Fixed-mounted design	Withdrawable design, fixed mounted design with compartment doors, plug-in design	Fixed-mounted design
<b>Functions</b>	Incoming feeder Outgoing feeder Coupler	Extended arc fault protection	Cable feeders, motor feeders (MCC)	Automatic control of fans, pumps, compressor
<b>Rated current</b>	Up to 6,300 A	Short-circuit withstand strength up to 100 kA at 690 V	Up to 630 A, up to 250 kW	Up to 132 kW
<b>Type of connection</b>	Front or rear	-	Front or rear	Front
<b>Cubicle width</b>	400; 600; 800; 1,000; 1,400 mm	400 mm	600; 1,000; 1,200 mm	600; 800; 1,000 mm
<b>Internal separation</b>	Form 1, 2b, 3a, 4b, 4b type 7 (BS)	Form 4b	Form 2b, 3b, 4a, 4b, 4b type 6, 4b type 7 (BS)	Form 1, 2b
<b>Busbar position</b>	Top, rear	Top, rear	Top, rear	Without, top, rear

Tab. 2/10: Basic data of the different mounting designs

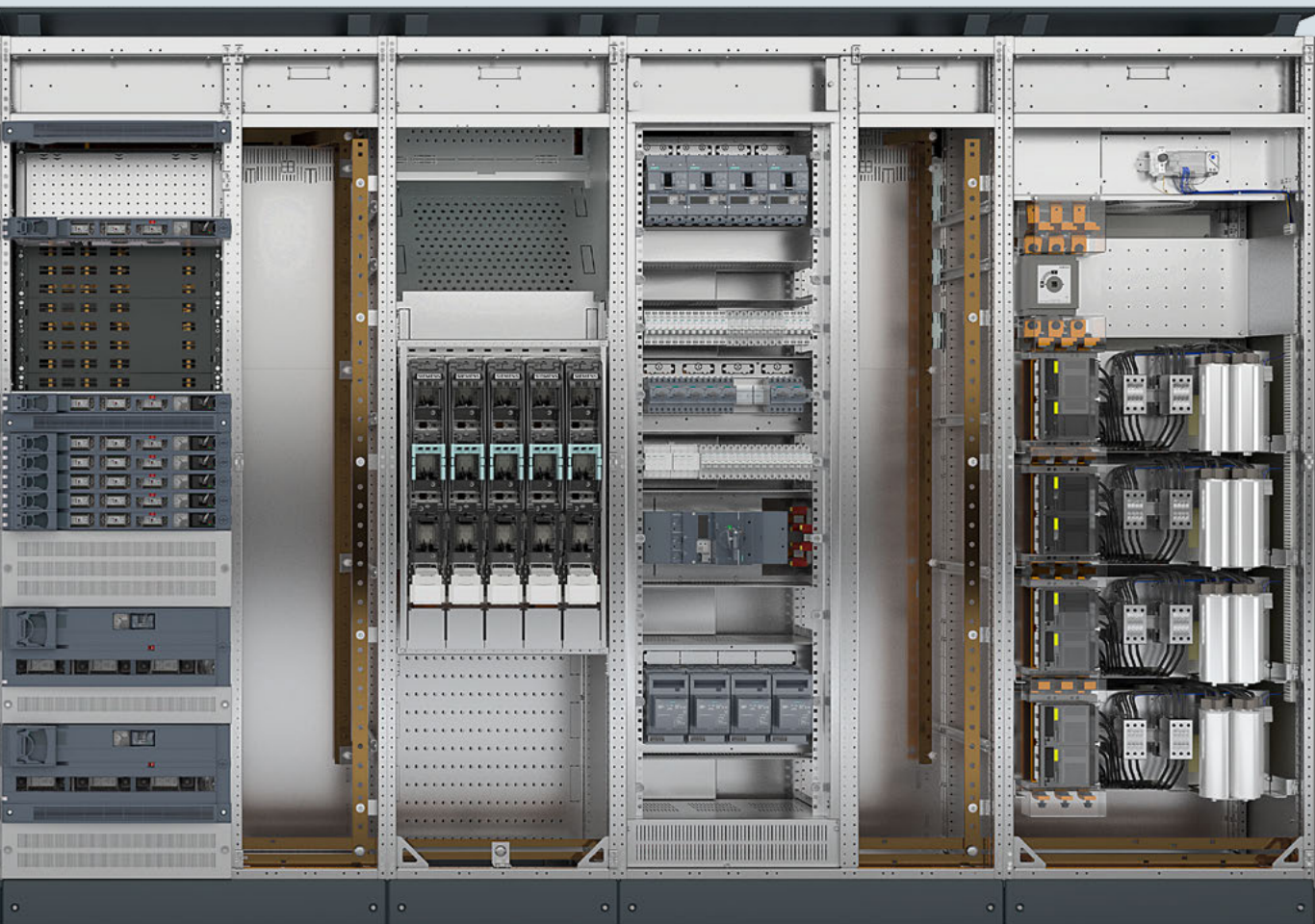

1

2

3

4

5

6

7

8

9

10

11

12

In-line design, plug-in	In-line design, fixed-mounted	Fixed-mounted design	Reactive power compensation
Plug-in design	Fixed-mounted design	Fixed-mounted design with front covers	Fixed-mounted design
Cable feeders	Cable feeders	Cable feeders	Central compensation of reactive power
Up to 630 A	Up to 630 A	Up to 630 A	Up to 500 kvar unchoked / choked
Front	Front	Front	Front
1,000; 1,200 mm	600; 800; 1,000 mm	1,000; 1,200 mm	800 mm
Form 3b, 4b	Form 1, 2b	Form 1, 2b, 3b, 4a, 4b	Form 1, 2b
Top, rear	Rear	Top, rear	Without, top, rear



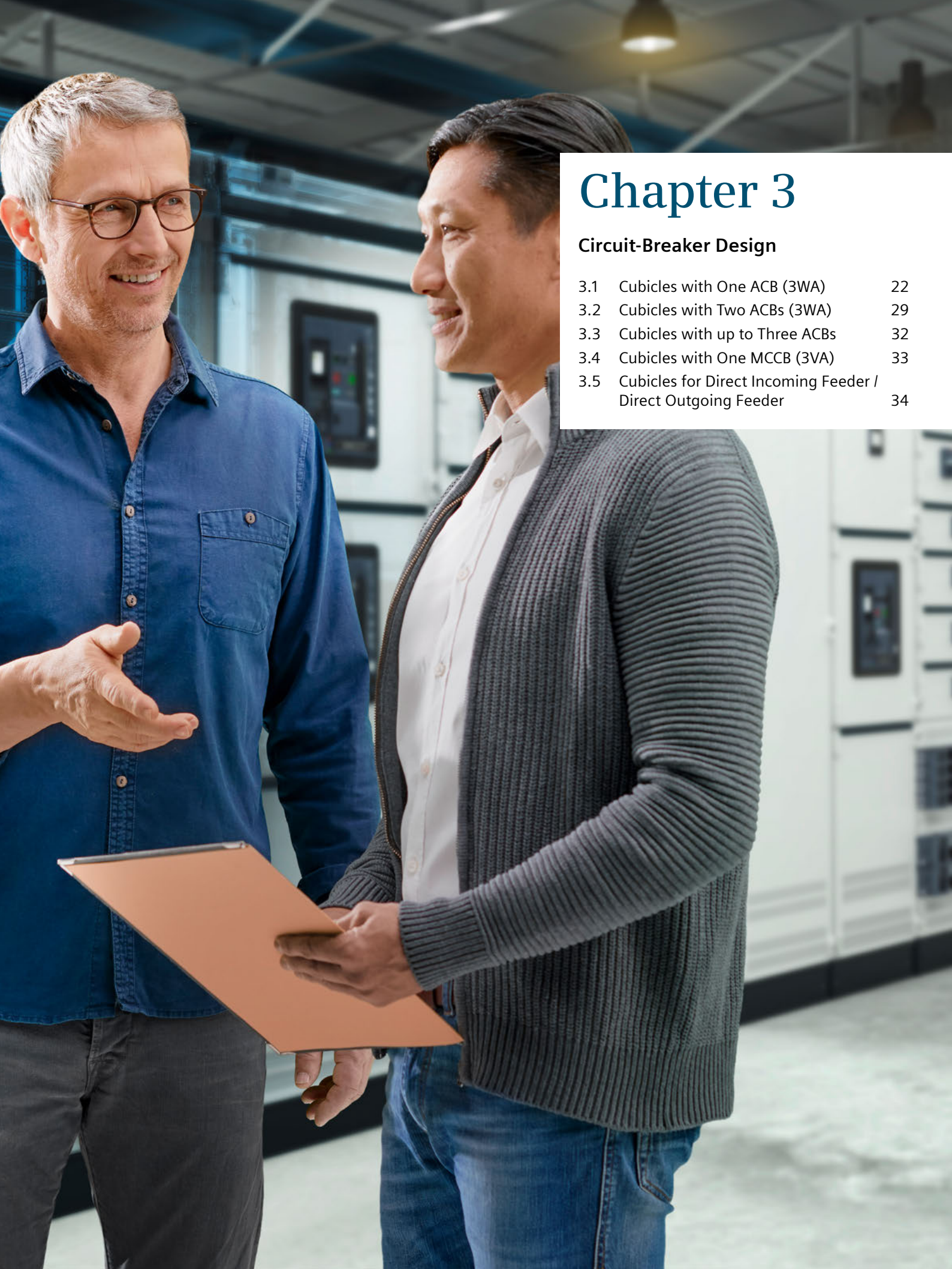

# Chapter 3

## Circuit-Breaker Design

3.1	Cubicles with One ACB (3WA)	22
3.2	Cubicles with Two ACBs (3WA)	29
3.3	Cubicles with up to Three ACBs	32
3.4	Cubicles with One MCCB (3VA)	33
3.5	Cubicles for Direct Incoming Feeder / Direct Outgoing Feeder	34

# 3 Circuit-Breaker Design

The cubicles for 3WA and 3VA circuit-breakers cater for personnel safety and long-term operational reliability (Fig. 3/1). The incoming feeder cubicles, outgoing feeder cubicles, and coupling cubicles of the circuit-breaker design are equipped with 3WA air circuit-breakers (ACB) in withdrawable or fixed-mounted design, or alternatively with 3VA molded-case circuit-breakers (MCCB) (Tab. 3/1).

The cubicle dimensions are tailored to the circuit-breaker sizes and can be selected according to the individual requirements. The circuit-breaker design provides optimum connection conditions for every nominal current range. In addition to cable connections, the system also provides design verified connections to SIVACON 8PS busbar trunking systems.



Fig. 3/1: Cubicles in circuit-breaker design



<b>Application</b>	<ul style="list-style-type: none"> <li>- Incoming circuit-breakers</li> <li>- Coupling circuit-breakers (longitudinal and transverse couplers)</li> <li>- Outgoing circuit-breakers</li> <li>- Direct incoming/outgoing feeder (without circuit-breakers)</li> </ul>	
<b>Degrees of protection</b>	<ul style="list-style-type: none"> <li>- Up to IP43</li> <li>- IP54</li> </ul>	<ul style="list-style-type: none"> <li>Ventilated</li> <li>Non-ventilated</li> </ul>
<b>Form of internal separation</b>	<ul style="list-style-type: none"> <li>- Form 1, 2b</li> <li>- Form 3a, 4b <sup>1)</sup></li> </ul>	Door divided into 3 parts
<b>Design options</b>	<ul style="list-style-type: none"> <li>- Air circuit-breaker (ACB) in fixed-mounted or withdrawable version <sup>2)</sup></li> <li>- Molded-case circuit-breaker (MCCB) in fixed-mounted design <sup>3)</sup></li> </ul>	

<sup>1)</sup> Also form 4b type 7 acc. to BS EN 61439-2 possible  
<sup>2)</sup> Information on 3WT circuit-breakers can be obtained from your contact partner at Siemens  
<sup>3)</sup> Information on molded-case circuit-breakers in plug-in/withdrawable design can be obtained from your contact partner at Siemens

Tab. 3/1: General cubicle characteristics of the circuit-breaker design

The circuit-breaker cubicles allow the installation of a current transformer (L1, L2 and L3) on the customer connection side. Information on the installation of additional transformers can be obtained from your contact partner at Siemens.

### Cubicle with forced ventilation

The circuit-breaker cubicles with forced ventilation are equipped with fans (Fig. 3/2). Controlled fans are installed in the cubicle front below the circuit-breaker. The forced ventilation increases the rated current of the circuit-breaker cubicle. The other cubicle characteristics are identical to the cubicle without forced ventilation.

The fan control comes completely configured from the factory. No further settings are required during switchboard commissioning. The fans are dimensioned such that the required ventilation is still ensured if a fan fails. Failure of the fan or non-permissible temperature rises are signaled. Forced ventilation is available for selected ACBs (3WA) in withdrawable version.

The use of fans brings about additional noise emission. Under normal operating conditions, the noise emission may be 85 dB as a maximum. Higher noise emissions only occur in case of fault. Observing local regulations on noise protection and industrial health and safety is mandatory.



Fig. 3/2: Forced ventilation in a circuit-breaker cubicle

### 3.1 Cubicles with one ACB (3WA)

The widths for the different cubicle types are listed by ACB type in Tab. 3/2 to Tab. 3/4.

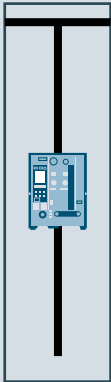
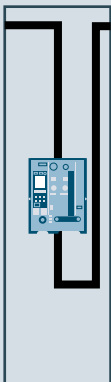
Cubicle type	ACB type	Rated device current	Cubicle width in mm			
			Cable connection		Busbar connection	
			3-pole	4-pole	3-pole	4-pole
<b>Incoming feeder / outgoing feeder</b>						
 <p>Busbar position at the top, cable / busbar entry from the top or bottom</p>	3WA1106	630 A	400/600	600	-	-
	3WA1108	800 A	400/600	600	-	-
	3WA1110	1,000 A	400/600	600	-	-
	3WA1112	1,250 A	400/600	600	-	-
	3WA1116	1,600 A	400/600	600	400/600	600
	3WA1120	2,000 A	400/600	600	400/600	600
	3WA1220	2,000 A	600/800	800	600/800	800
	3WA1225	2,500 A	600/800	800	600/800	800
	3WA1232	3,200 A	600/800	800	600/800	800
	3WA1340	4,000 A <sup>2)</sup>	800	1,000	800	1,000
	3WA1350 <sup>1)</sup>	5,000 A <sup>2)</sup>	-	-	1,000	1,000
	3WA1363 <sup>1)</sup>	6,300 A <sup>2)</sup>	-	-	1,000	1,000
The position of the connection busbars is identical for cable entry from the top or bottom						
<b>Longitudinal coupler</b>			<b>3-pole</b>	<b>4-pole</b>		
 <p>Busbar position at the top</p>	3WA1106	630 A	600	800	-	-
	3WA1108	800 A	600	800	-	-
	3WA1110	1,000 A	600	800	-	-
	3WA1112	1,250 A	600	800	-	-
	3WA1116	1,600 A	600	800	-	-
	3WA1120	2,000 A	600	800	-	-
	3WA1220	2,000 A	800	1,000	-	-
	3WA1225	2,500 A	800	1,000	-	-
	3WA1232	3,200 A	800	1,000	-	-
	3WA1340	4,000 A <sup>2)</sup>	1,000	1,200	-	-
	3WA1350 <sup>1)</sup>	5,000 A <sup>2)</sup>	1,200	1,200	-	-
	3WA1363 <sup>1)</sup>	6,300 A <sup>2)</sup>	1,200	1,200	-	-
<sup>1)</sup> Withdrawable unit version, frame height 2,200 mm						
<sup>2)</sup> Main busbar up to 6,300 A						

Tab. 3/2: Cubicle dimensions for busbar position at the top

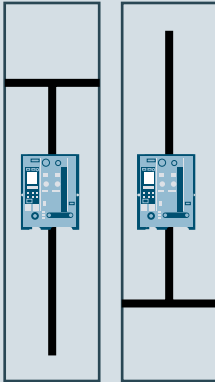
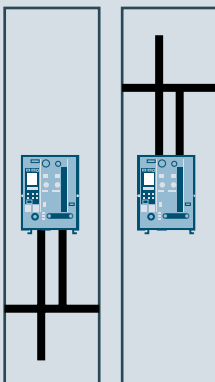
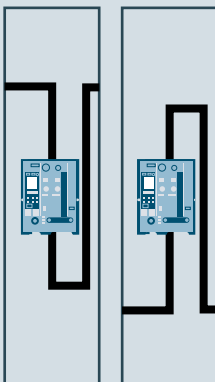
Cubicle type	ACB type	Rated device current	Cubicle width in mm			
			Cable connection		Busbar connection	
			3-pole	4-pole	3-pole	4-pole
 <p>1 busbar system in the cubicle: busbar position rear-top and cable/busbar entry from the bottom or busbar position rear-bottom and cable/busbar entry from the top</p>	3WA1106	630 A	400/600	600	-	-
	3WA1108	800 A	400/600	600	-	-
	3WA1110	1,000 A	400/600	600	-	-
	3WA1112	1,250 A	400/600	600	-	-
	3WA1116	1,600 A	400/600	600	400/600	600
	3WA1120	2,000 A	400/600	600	400/600	600
	3WA1220	2,000 A	600/800	800	600/800	800
	3WA1225	2,500 A	600/800	800	600/800	800
	3WA1232	3,200 A	600/800	800	600/800	800
	3WA1340	4,000 A	1,000	1,000	800 <sup>1)</sup> /1,000	1,000
	3WA1350 <sup>1)</sup>	5,000 A <sup>2)</sup>	-	-	1,000	1,000
	3WA1363 <sup>1)</sup>	6,300 A <sup>2)</sup>	-	-	1,000	1,000
 <p>1 busbar system in the cubicle: busbar position rear-bottom and cable/busbar entry from the bottom or busbar position rear-top and cable/busbar entry from the top</p>	3WA1106	630 A	400/600	600	-	-
	3WA1108	800 A	400/600	600	-	-
	3WA1110	1,000 A	400/600	600	-	-
	3WA1112	1,250 A	400/600	600	-	-
	3WA1116	1,600 A	400/600	600	400/600	600
	3WA1120	2,000 A	400/600	600	400/600	600
	3WA1220	2,000 A	600/800	800	600/800	800
	3WA1225	2,500 A	600/800	800	600/800	800
	3WA1232	3,200 A	600/800	800	600/800	800
	3WA1340	4,000 A	-	-	800 <sup>3)</sup> /1,000	1,000
Longitudinal coupler			<b>3-pole</b>	<b>4-pole</b>		
	 <p>1 busbar system in the cubicle: busbar position rear-top or busbar position rear-bottom</p>	3WA1106	630 A	600	600	-
3WA1108		800 A	600	600	-	-
3WA1110		1,000 A	600	600	-	-
3WA1112		1,250 A	600	600	-	-
3WA1116		1,600 A	600	600	-	-
3WA1120		2,000 A	600	600	-	-
3WA1220		2,000 A	800	800	-	-
3WA1225		2,500 A	800	1,000	-	-
3WA1232		3,200 A	800	1,400	-	-
3WA1340		4,000 A	1,000	1,000	-	-
3WA1350 <sup>1)</sup>		5,000 A <sup>2)</sup>	1,400	1,400	-	-
3WA1363 <sup>1)</sup>		6,300 A <sup>2)</sup>	1,400	1,400	-	-

<sup>1)</sup> Withdrawable unit version, frame height 2,200 mm  
<sup>2)</sup> Main busbar up to 7,010 A  
<sup>3)</sup> Frame height 2,200 mm

Tab. 3/3: Cubicle dimensions for busbar position at the rear

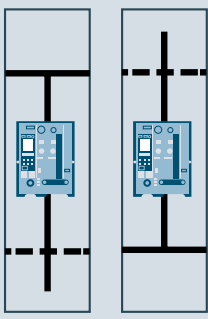
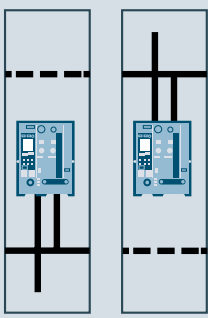
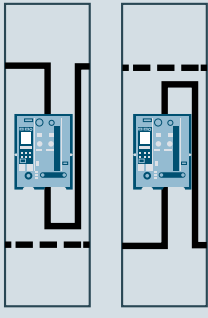
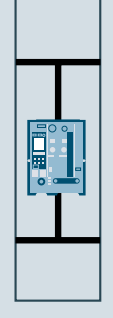

Cubicle type	ACB type	Rated device current	Cubicle width in mm				
			Cable connection		Busbar connection		
			3-pole	4-pole	3-pole	4-pole	
<b>Incoming feeder / outgoing feeder</b>							
 <p>2 busbar systems in the cubicle: busbar position rear-top and cable / busbar entry from the bottom</p> <p>or</p> <p>busbar position rear-bottom and cable / busbar entry from the top</p>	3WA1106	630 A	400/600	600	-	-	
	3WA1108	800 A	400/600	600	-	-	
	3WA1110	1,000 A	400/600	600	-	-	
	3WA1112	1,250 A	400/600	600	-	-	
	3WA1116	1,600 A	400/600	600	400/600	600	
	3WA1120	2,000 A	400/600	600	400/600	600	
	3WA1220	2,000 A	600/800	800	600/800	800	
	3WA1225	2,500 A	600/800	800	600/800	800	
	3WA1232	3,200 A	600/800	800	600/800	800	
	3WA1340	4,000 A	1,000	1,000	800 <sup>1)</sup> /1,000	1,000	
 <p>2 busbar systems in the cubicle: busbar position rear-bottom and cable / busbar entry from the bottom</p> <p>or</p> <p>busbar position rear-top and cable / busbar entry from the top</p>	3WA1106	630 A	400/600	600	-	-	
	3WA1108	800 A	400/600	600	-	-	
	3WA1110	1,000 A	400/600	600	-	-	
	3WA1112	1,250 A	400/600	600	-	-	
	3WA1116	1,600 A	400/600	600	400/600	600	
	3WA1120	2,000 A	400/600	600	400/600	600	
	3WA1220	2,000 A	600/800	800	600/800	800	
	3WA1225	2,500 A	600/800	800	600/800	800	
	3WA1232	3,200 A	600/800	800	600/800	800	
	3WA1340	4,000 A	-	-	800 <sup>1)</sup> /1,000	1,000	
<b>Longitudinal coupler</b>			<b>3-pole</b>	<b>4-pole</b>			
 <p>2 busbar systems in the cubicle: busbar position rear-top</p> <p>or</p> <p>busbar position rear-bottom</p>	3WA1106	630 A	600	600	-	-	
	3WA1108	800 A	600	600	-	-	
	3WA1110	1,000 A	600	600	-	-	
	3WA1112	1,250 A	600	600	-	-	
	3WA1116	1,600 A	600	600	-	-	
	3WA1120	2,000 A	600	600	-	-	
	3WA1220	2,000 A	800	800	-	-	
	3WA1225	2,500 A	800	800	-	-	
	3WA1232	3,200 A	800	800	-	-	
3WA1340	4,000 A	1,000	1,000	-	-		
<b>Transversal coupler</b>			<b>3-pole</b>	<b>4-pole</b>			
 <p>2 busbar systems in the cubicle: busbar position rear-top and busbar position rear-bottom</p>	3WA1106	630 A	400/600	600	-	-	
	3WA1108	800 A	400/600	600	-	-	
	3WA1110	1,000 A	400/600	600	-	-	
	3WA1112	1,250 A	400/600	600	-	-	
	3WA1116	1,600 A	400/600	600	-	-	
	3WA1120	2,000 A	400/600	600	-	-	
	3WA1220	2,000 A	600/800	800	-	-	
	3WA1225	2,500 A	600/800	800	-	-	
	3WA1232	3,200 A	600/800	800	-	-	
3WA1340	4,000 A	1,000	1,000	-	-		

<sup>1)</sup> Frame height 2,200 mm

Tab. 3/4: Cubicle dimensions for busbar position at the rear with two busbar systems in the cubicle

## Cable and busbar connection

The number of connectable cables, as stated in Tab. 3/5, may be restricted by the available openings in the roof/floor plate and/or by door-mounted components. The position of the connection busbars is identical for front or rear connection in the cubicle.

Connection to the SIVACON 8PS busbar trunking system is effected by means of a built-in busbar trunking connection piece. The SIVACON S8 connection system is located completely inside the cubicle. The busbars can be connected both from the top and from the bottom, thus allowing flexible connection. The factory-assembled copper connections ensure a high short-circuit withstand strength, which is verified by a design verification test, as is the temperature rise test.

## Short-circuiting and earthing device (SED)

For short-circuiting and earthing, short-circuiting and earthing devices (SED) are available for the circuit-breaker cubicle. For mounting the SED, appropriate fastening points are fitted at the points to be earthed.

Cable lug acc. to DIN 46235 (240 mm <sup>2</sup> , M12) <sup>1)</sup>	Max. number of cables connectable per phase depending on the circuit-breaker size				
	3WA11 up to 1,000 A	3WA11 1,250 to 2,000 A	3WA12 up to 1,600 A	3WA12 2,000 to 3,200 A	3WA13 <sup>2)</sup> up to 4,000 A
	4	6	6	12	14

<sup>1)</sup> 300 mm<sup>2</sup> cable lugs with bolt M12 can be used. However, this cable lug does not comply with DIN 46235, although it is available at some manufacturers  
<sup>2)</sup> Circuit-breakers 5,000 A and 6,300 A with busbar connection

Tab. 3/5: Cable connection for cubicles with 3WA

## Rated operational currents

Depending on the ACB type, the rated operational currents of the different cubicle and busbar connection types are specified in Tab. 3/6 , Tab. 3/7 and Tab. 3/8.

Tab. 3/9 shows the rated operational currents of withdrawable units with 3WA circuit-breakers with forced ventilation.

ACB type	Rated device current	Rated operational current at an ambient temperature of 35 °C					
		Busbar position at the top		Busbar position at the rear			
		Cable connection from the bottom		Cable connection from the bottom		Cable connection from the top	
		Non-ventilated	Ventilated	Non-ventilated	Ventilated	Non-ventilated	Ventilated
3WA1106	630 A	630 A	630 A	630 A	630 A	630 A	630 A
3WA1108	800 A	800 A	800 A	800 A	800 A	800 A	800 A
3WA1110	1,000 A	930 A	1,000 A	1,000 A	1,000 A	1,000 A	1,000 A
3WA1112	1,250 A	1,160 A	1,250 A	1,170 A	1,250 A	1,020 A	1,190 A
3WA1116	1,600 A	1,200 A	1,500 A	1,410 A	1,600 A	1,200 A	1,360 A
3WA1120	2,000 A	1,550 A	1,780 A	1,500 A	1,840 A	1,480 A	1,710 A
3WA1220	2,000 A	1,630 A	2,000 A	1,630 A	1,920 A	1,880 A	2,000 A
3WA1225	2,500 A	1,960 A	2,360 A	1,950 A	2,320 A	1,830 A	2,380 A
3WA1232	3,200 A	2,240 A	2,680 A	2,470 A	2,920 A	1,990 A	2,480 A
3WA1340	4,000 A	2,600 A	3,660 A	2,700 A	3,700 A	2,430 A	3,040 A

ACB type	Rated device current	Busbar position at the top		Busbar position at the rear			
		Longitudinal coupler		Longitudinal coupler		Transversal coupler	
		Non-ventilated	Ventilated	Non-ventilated	Ventilated	Non-ventilated	Ventilated
3WA1106	630 A	630 A	630 A	630 A	630 A	630 A	630 A
3WA1108	800 A	800 A	800 A	800 A	800 A	800 A	800 A
3WA1110	1,000 A	1,000 A	1,000 A	1,000 A	1,000 A	1,000 A	1,000 A
3WA1112	1,250 A	1,160 A	1,250 A	1,140 A	1,250 A	1,170 A	1,250 A
3WA1116	1,600 A	1,390 A	1,600 A	1,360 A	1,600 A	1,410 A	1,600 A
3WA1120	2,000 A	1,500 A	1,850 A	1,630 A	1,910 A	1,500 A	1,840 A
3WA1220	2,000 A	1,630 A	1,930 A	1,710 A	2,000 A	1,630 A	1,920 A
3WA1125	2,500 A	1,960 A	2,360 A	1,930 A	2,440 A	1,950 A	2,320 A
3WA1132	3,200 A	2,200 A	2,700 A	2,410 A	2,700 A	2,470 A	2,920 A
3WA1140	4,000 A	2,840 A	3,670 A	2,650 A	3,510 A	2,700 A	3,700 A
3WA1350	5,000 A	3,660 A	4,720 A	3,310 A	4,460 A	-	-
3WA1363	6,300 A	3,920 A	5,180 A	3,300 A	5,060 A	-	-

Tab. 3/6: Rated operational currents for cable connection cubicles and couplers with a 3WA

ACB type	Rated device current	Busbar position at the top			
		Busbar connection from the bottom with SIVACON 8PS system LD		Busbar connection from the top with SIVACON 8PS system LD	
		Non-ventilated	Ventilated	Non-ventilated	Ventilated
3WA1116	1,600 A	1,200 A	1,500 A	1,420 A	1,580 A
3WA1120	2,000 A	1,550 A	1,780 A	1,600 A	1,790 A
3WA1220	2,000 A	1,630 A	2,000 A	1,630 A	2,000 A
3WA1225	2,500 A	1,960 A	2,360 A	2,030 A	2,330 A
3WA1232	3,200 A	2,240 A	2,680 A	2,420 A	2,720 A
3WA1340	4,000 A	2,600 A	3,660 A	2,980 A	3,570 A
3WA1350	5,000 A	3,830 A	4,450 A	3,860 A	4,460 A

ACB type	Rated device current	Busbar position at the rear			
		Busbar connection from the bottom with SIVACON 8PS system LD		Busbar connection from the top with SIVACON 8PS system LD	
		Non-ventilated	Ventilated	Non-ventilated	Ventilated
3WA1116	1,600 A	1,410 A	1,600 A	1,440 A	1,550 A
3WA1120	2,000 A	1,500 A	1,840 A	1,590 A	1,740 A
3WA1220	2,000 A	1,630 A	1,920 A	1,630 A	1,920 A
3WA1225	2,500 A	1,950 A	2,320 A	2,130 A	2,330 A
3WA1232	3,200 A	2,470 A	2,920 A	2,440 A	2,660 A
3WA1340	4,000 A	2,700 A	3,700 A	2,750 A	3,120 A
3WA1350	5,000 A	3,590 A	4,440 A	3,590 A	4,440 A

Tab. 3/7: Rated operational currents of the connections for the SIVACON 8PS system LD with a 3WA

ACB type	Rated device current	Busbar trunking system LI	Rated operational current at an ambient temperature of 35 °C					
			Busbar position at the top		Busbar position at the rear			
			Busbar connection from the top		Busbar connection from the bottom		Busbar connection from the top	
			Non-ventilated	Ventilated	Non-ventilated	Ventilated	Non-ventilated	Ventilated
3WA1116	1,600 A	LI-A1600	-	-	1,240 A	1,480 A	1,260 A	1,470 A
3WA1120	2,000 A	LI-A1600	1,450 A	1,600 A	1,450 A	1,600 A	1,450 A	1,600 A
3WA1220	2,000 A	LI-A2000	-	-	-	-	1,630 A	1,980 A
3WA1225	2,500 A	LI-A2000	1,930 A	2,000 A	1,890 A	2,000 A	1,930 A	2,000 A
3WA1225	2,500 A	LI-A2500	1,950 A	2,460 A	1,930 A	2,350 A	2,000 A	2,350 A
3WA1232	3,200 A	LI-A2500	2,220 A	2,500 A	2,070 A	2,500 A	2,220 A	2,500 A
3WA1232	3,200 A	LI-A3200	-	-	2,100 A	2,570 A	2,030 A	2,510 A
3WA1340	4,000 A	LI-A2500	2,500 A	2,500 A	2,480 A	2,500 A	2,500 A	2,500 A
3WA1340	4,000 A	LI-A3200	2,510 A	3,040 A	-	-	2,510 A	3,040 A
3WA1340	4,000 A	LI-A4000 <sup>1)</sup>	-	-	2,640 A	3,330 A	2,360 A	2,870 A
3WA1350	5,000 A	LI-A4000	3,570 A	4,000 A	3,470 A	4,000 A	3,300 A	4,000 A
3WA1350	5,000 A	LI-A5000	-	-	3,420 A	4,790 A	3,390 A	4,920 A
3WA1163	6,300 A	LI-A5000	3,890 A	4,940 A	3,560 A	5,000 A	3,390 A	4,920 A
3WA1116	1,600 A	LI-C1600	-	-	1,220 A	1,440 A	1,230 A	1,510 A
3WA1120	2,000 A	LI-C1600	1,530 A	1,600 A	1,480 A	1,600 A	1,530 A	1,600 A
3WA1220	2,000 A	LI-C2000	-	-	-	-	1,560 A	1,930 A
3WA1225	2,500 A	LI-C2000	1,910 A	2,000 A	1,890 A	2,000 A	1,910 A	2,000 A
3WA1225	2,500 A	LI-C2500	2,150 A	2,310 A	1,950 A	2,340 A	2,150 A	2,310 A
3WA1232	3,200 A	LI-C2500	2,260 A	2,480 A	2,130 A	2,500 A	2,260 A	2,480 A
3WA1232	3,200 A	LI-C3200	2,260 A	2,820 A	2,160 A	2,640 A	2,330 A	2,680 A
3WA1340	4,000 A	LI-C2500	2,460 A	2,500 A	2,470 A	2,500 A	2,460 A	2,500 A
3WA1340	4,000 A	LI-C3200	2,830 A	3,200 A	2,650 A	3,200 A	2,830 A	3,200 A <sup>2)</sup>
3WA1340	4,000 A	LI-C4000	-	-	2,640 A	3,390 A	2,410 A	3,030 A
3WA1350	5,000 A	LI-C4000	3,520 A	4,000 A	3,490 A	4,000 A	3,380 A	4,000 A <sup>1)</sup>
3WA1350	5,000 A	LI-C5000	-	-	3,490 A	4,840 A	3,420 A	4,860 A
3WA1363	6,300 A	LI-C5000	4,000 A	5,000 A	3,670 A	5,000 A	3,510 A	5,000 A
3WA1163	6,300 A	LI-C6300	-	-	3,670 A	5,100 A	3,640 A	5,330 A

<sup>1)</sup> Only degree of protection IP3X

<sup>2)</sup> Cubicle width 1,000 mm

Tab. 3/8: Rated operational currents of the connections for the SIVACON 8PS system LI with a 3WA

Busbar position rear-top Incoming feeder or outgoing feeder function; cable or busbar connection LD from the bottom			
3WA withdrawable design		Rated operational currents at an ambient temperature of 35 °C	
Type	Rated current	Non-ventilated	Ventilated
3WA1232	3,200 A	3,200 A	3,200 A
3WA1340	4,000 A	3,760 A	4,000 A

Busbar position rear-bottom Incoming feeder or outgoing feeder function; cable or busbar connection LD from the top				
3WA withdrawable design		Connection	Rated operational currents at an ambient temperature of 35 °C	
Type	Rated current		Non-ventilated	Ventilated
3WA1232	3,200 A	Cable	2,990 A	3,030 A
3WA1340	4,000 A	Cable	3,890 A	4,000 A
3WA1232	3,200 A	LDA6	2,650 A	2,640 A
3WA1232	3,200 A	LDC6	3,170 A	3,160 A

Busbar position rear-top Incoming feeder or outgoing feeder function; busbar connection LI from the bottom				
3WA withdrawable design		Connection	Rated operational currents at an ambient temperature of 35 °C	
Type	Rated current		Non-ventilated	Ventilated
3WA1340	4,000 A	LIA4000	4,000 A	4,000 A
3WA1340	4,000 A	LIC4000	4,000 A	4,000 A

Busbar position rear-bottom Incoming feeder or outgoing feeder function; busbar connection LI from the top				
3WA withdrawable design		Connection	Rated operational currents at an ambient temperature of 35 °C	
Type	Rated current		Non-ventilated	Ventilated
3WA1232	3,200 A	LIA3200	2,920 A	3,030 A
3WA1340	4,000 A	LIA4000	3,650 A	3,670 A
3WA1350	5,000 A	LIA5000	5,000 A	5,000 A
3WA1232	3,200 A	LIC3200	3,170 A	3,190 A
3WA1340	4,000 A	LIC4000	3,900 A	3,950 A
3WA1350	5,000 A	LIC5000	5,000 A	5,000 A
3WA1363	6,300 A	LIC6300	6,070 A	6,200 A

Tab. 3/9: Rated operational currents for withdrawable units with 3WA circuit-breakers with forced ventilation



### 3.2 Cubicles with Two ACBs (3WA)

When two ACBs are installed in the cubicles, three types are distinguished:

- The combination of incoming feeder or outgoing feeder and longitudinal coupler as a standard cubicle
- The installation of two ACBs as incoming or outgoing circuit-breakers independent of each other
- The installation of two ACBs connected in parallel with circuit-breakers with a common connection.

Common features of the three types:

- Main busbar position at the rear
- All cubicle depths for main busbar position at the rear are possible
- Cubicle height: 2,200 mm
- Degree of protection, non-ventilated: IP54
- Degree of protection, ventilated:  $\leq$  IP43
- Connection with cables
- Connection with busbars is possible, but may be different depending on the type
- ACB switching capacity classes N, S or H are possible.

#### i) Combination of incoming feeder or outgoing feeder and longitudinal coupler

In the 800 mm or 1,000 mm wide cubicle, two 3WA12 (size 2, withdrawable design with  $I_n \leq 2,500$  A) make up a combination of incoming feeder or outgoing feeder and longitudinal coupler. As for the design, they look like cubicles with one ACB, but a circuit-breaker is arranged at the position of the auxiliary device holder (Fig. 3/3).

Circuit-breakers with different rated currents and switching capacity classes can be mixed as well as 3- and 4-pole circuit-breakers. The common busbar set is determined by the circuit-breaker with the highest rated current. The rated operational currents for different load cases are listed in Tab. 3/10. Connection with LI busbar is possible.

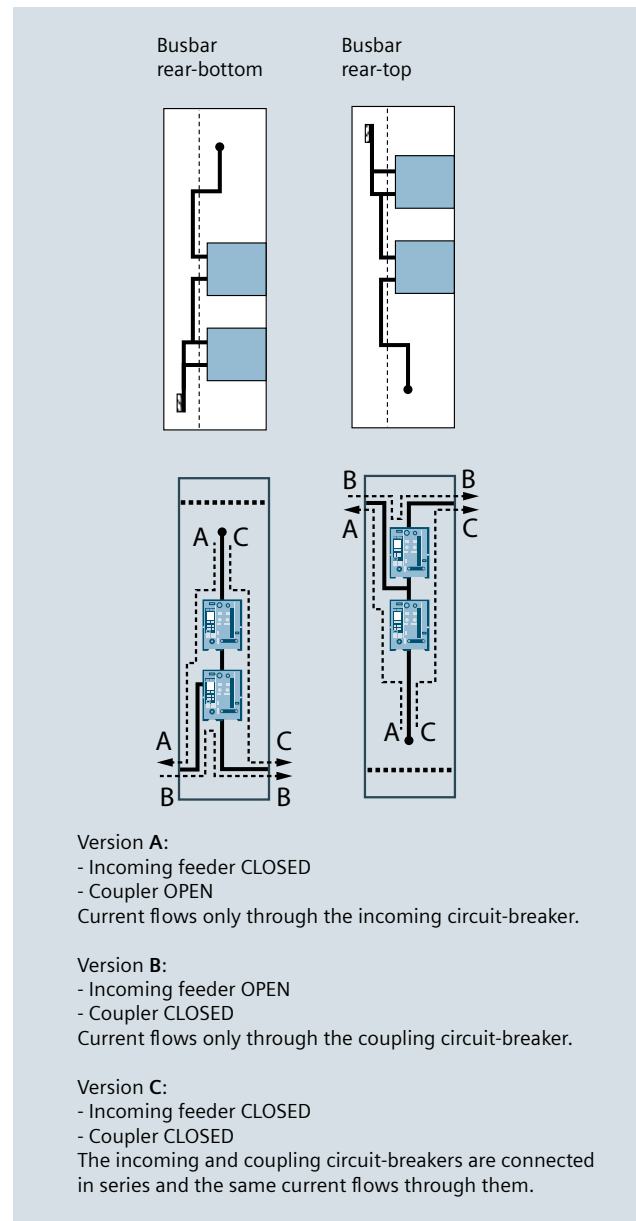

Fig. 3/3: Cubicle types and load cases with two 3WA12 as longitudinal coupler and incoming feeder / outgoing feeder (top: side view; bottom: front view)

Rated device current	ACB type	Main busbar	Rated operational current at an ambient temperature of 35 °C					
			Version A		Version B		Version C	
			Non-ventilated	Ventilated	Non-ventilated	Ventilated	Non-ventilated	Ventilated
Up to 2,000 A	3WA1220	Top	1,660 A	2,260 A	1,760 A	1,990 A	1,510 A	1,820 A
		Bottom	1,540 A	1,810 A	1,550 A	1,930 A	1,400 A	1,770 A
Up to 2,500 A	3WA1225	Top	2,030 A	2,380 A	2,270 A	2,490 A	1,880 A	2,230 A
		Bottom	1,940 A	2,260 A	1,920 A	2,340 A	1,720 A	2,170 A

Tab. 3/10: Rated operational currents for load cases (Fig. 3/3) of a circuit-breaker cubicle with two 3WA12 circuit-breakers in the cubicle

ii) **Combination of two independent incoming or outgoing circuit-breakers**

Two feeders with 3-pole 3WA11 up to 1,000 A (600 mm wide) or with 3-pole 3WA12 up to 1,600 A (800 mm wide) are possible per cubicle. On the right there is a 200 mm wide, cubicle-high cable compartment. The circuit-breaker sizes cannot be mixed within the cubicle. Besides the cable connection there is a universal busbar connection available. An incoming feeder with the network configuration TN-C-S cannot be configured. Short-circuiting and earthing devices are not possible for reasons of space. The connection options are schematically represented in Fig. 3/4. Tab. 3/11 specifies the rated currents for connection of the 3WA12 with  $I_n = 1,600$  A from the top. Other values are available on request.

Busbar position at the rear, incoming feeder or outgoing feeder	Rated operational current at an ambient temperature of 35 °C	
	Non-ventilated	Ventilated
Cable connection from the top	1,150 A	1,370 A
Universal busbar connection from the top <sup>1)</sup>	1,220 A	1,490 A
Cable connection from the bottom	1,010 A	1,340 A
Universal busbar connection from the bottom <sup>1)</sup>	1,010 A	1,340 A

<sup>1)</sup> Connection at the lower circuit-breaker is done in the right-hand connection compartment with cables

Tab. 3/11: Rated operational currents for two 3WA12 (Rated current  $I_n = 1,600$  A) in the cubicle

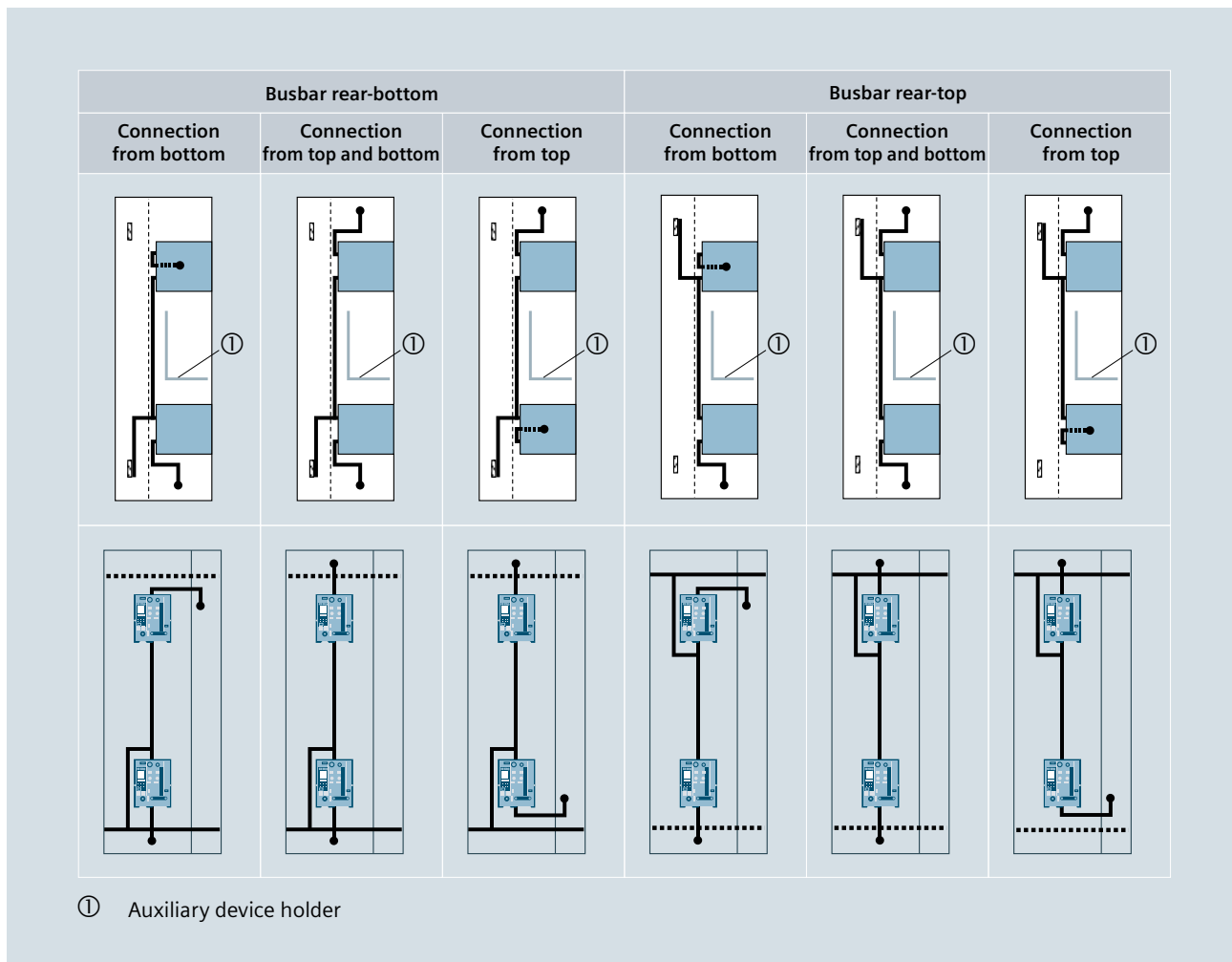

Fig. 3/4: Cubicle types with two independent 3WA as incoming feeder / outgoing feeder (top: side view; bottom: front view)

iii) **Combination of two incoming or outgoing circuit-breakers connected in parallel**

Two 3- or 4-pole 3WA12 with  $I_n \leq 3,200$  A are connected in parallel as incoming outgoing feeder. Both circuit-breakers have a common customer connection. Connection is possible with cables or with the LI busbar. However, only LI busbar trunking systems with rated currents  $I_n$  from 2,000 A to 3,200 A can be connected.

The circuit-breakers have the same rated currents, switching capacity classes and number of poles. Infeed takes place only in one direction, i.e., either from the busbar rear-bottom to the customer connection at the top, or from the busbar rear-top to the customer connection at the bottom. The bypass circuit-breaker is upstream from the busbar (Fig. 3/5). The rated operational currents for different load cases are listed in Tab. 3/12.

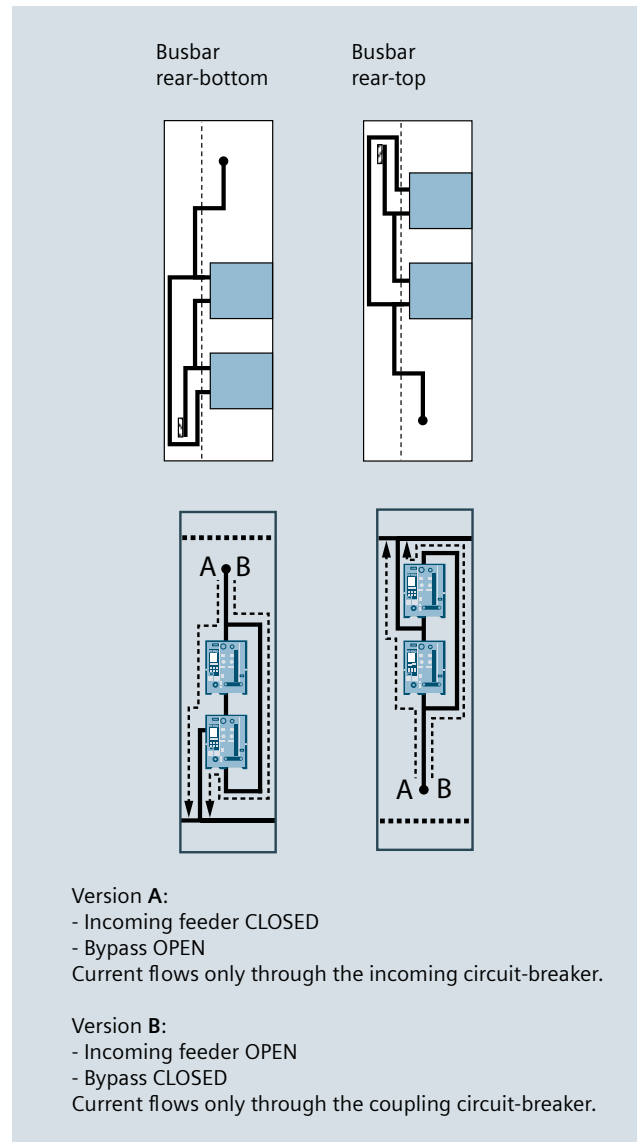

Fig. 3/5: Cubicle types and load cases with two 3WA12 connected in parallel as incoming feeder / outgoing feeder (top: side view; bottom: front view)

Rated device current (3WA1232)	Cable or busbar connection with LI	Rated operational current at an ambient temperature of 35 °C			
		Version A		Version B	
		Non-ventilated	Ventilated	Non-ventilated	Ventilated
Up to 3,200 A	Top	2,260 A	2,620 A	2,140 A	2,530 A
	Bottom	2,140 A	2,670 A	1,830 A	2,410 A

Tab. 3/12: Rated operational currents for load cases (Fig. 3/5) of a circuit-breaker cubicle with two 3WA12 circuit-breakers connected in parallel in the cubicle

### 3.3 Cubicles with Three ACBs

To allow space-saving installation, cubicles with up to three circuit-breakers as incoming and/or outgoing circuit-breakers can be implemented for specific ACB types (3WA).

#### Cubicle dimensions and cable connection

In a cubicle with three circuit-breakers, the cables are connected from the rear. A version with cable connection in the cubicle from the front does not offer any space advantages because of the required connection compartment. For this application, cubicles with one circuit-breaker are used. The three mounting spaces can be designed independently of each other either with a circuit-breaker, as a device compartment, or as direct incoming feeder. Cubicle dimensions and specifications on the cable connection can be found in Tab. 3/13, Tab. 3/14 and Fig. 3/6. The number of connectable cables may be restricted by the available openings in the roof/floor plate and/or by door-mounted components. For cubicles with up to 3 ACBs, the frame height is 2,200 mm.

#### Rated operational currents

The up to three circuit-breakers in the cubicle influence each other. Depending on the utilization of the individual circuit-breakers and the current distribution within the cubicle, different rated operational currents result for the individual circuit-breakers. Tab. 3/15 indicates the maximum rated operational currents for three specific cases of current distribution in the cubicle:

- Version A: identical rated operational current for all three mounting spaces
- Version B: highest current for top mounting space, lowest current for bottom mounting space
- Version C: highest current for bottom mounting space, lowest current for top mounting space

Information for individual distribution of the rated operational currents in the cubicle is available from your contact partner at Siemens.

ACB type	Rated device current	Cubicle width in mm		Cubicle depth in mm
		3-pole	4-pole	
3WA1106	630 A	600	600	800
3WA1108	800 A	600	600	800
3WA1110	1,000 A	600	600	800
3WA1112	1,250 A	600	600	1,200 <sup>1)</sup>
3WA1116	1,600 A	600	600	1,200 <sup>1)</sup>

<sup>1)</sup> Main busbar up to 6,300 A

Tab. 3/13: Cubicle dimensions for cubicles with 3 ACBs type 3WA

Cable lug acc. to DIN 46235 (240 mm <sup>2</sup> , M12) <sup>1)</sup>	Max. number of cables connectable per phase depending on the cubicle depth	
	800 mm	1,200 mm
	4	6

<sup>1)</sup> 300 mm<sup>2</sup> cable lugs with bolt M12 can be used. However, this cable lug does not comply with DIN 46235, although it is available at some manufacturers.

Tab. 3/14: Cable connection in cubicles with up to 3 ACBs

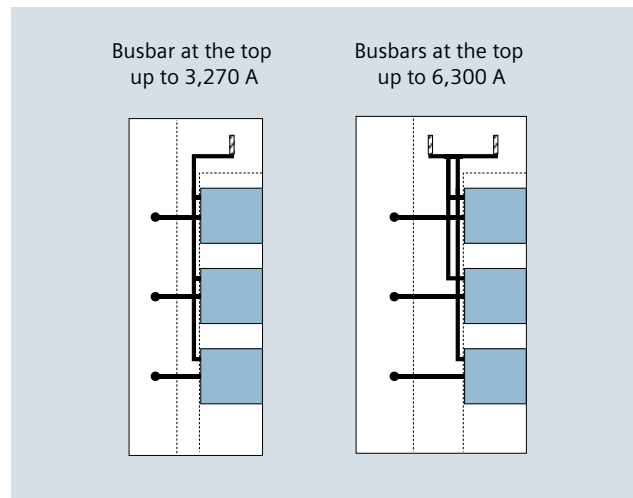

Fig. 3/6: Cubicle types with three circuit-breakers (side view)

Rated device current	Cubicle depth	Mounting space	Rated operational current at an ambient temperature of 35 °C					
			Version A		Version B		Version C	
			Non-ventilated	Ventilated	Non-ventilated	Ventilated	Non-ventilated	Ventilated
Up to 1,000 A	800 mm	Top	710 A	960 A	900 A	1,000 A	0	900 A
		Center	710 A	955 A	905 A	1,000 A	980 A	1,000 A
		Bottom	710 A	955 A	0	905 A	925 A	1,000 A
Up to 1,600 A	1,200 mm	Top	1,030 A	1,350 A	1,220 A	1,600 A	305 A	910 A
		Center	1,030 A	1,350 A	1,230 A	1,600 A	1,200 A	1,440 A
		Bottom	1,040 A	1,350 A	231 A	300 A	1,310 A	1,600 A

Tab. 3/15: Rated operational currents for special load cases of a circuit-breaker cubicle with three 3WA11 circuit-breakers in the cubicle

### 3.4 Cubicles with One MCCB (3VA)

The cubicle width of the different cubicle types (Tab. 3/16) with an MCCB (3VA) is generally 400 mm for 3- and 4-pole circuit-breakers. Up to 4 cables per phase can be connected to 3VA circuit-breakers up to 1,000 A with cable lugs (240 mm<sup>2</sup>, M12) according to DIN 46235.

*Note: 300 mm<sup>2</sup> cable lugs with bolt M12 can be used. However, this cable lug does not comply with DIN 46235, although it is available at some manufacturers.*

Information on rated operational currents for the different configurations of MCCBs, busbar position, cable entry, and ventilation conditions can be found in Tab. 3/17.

Busbar position					
Top	Rear-top		Rear-bottom		Rear-top and rear-bottom
Cable entry					Transversal coupler
Cable entry from the top or bottom <sup>1)</sup>	Cable entry from the top <sup>2)</sup>	Cable entry from the bottom <sup>2)</sup>	Cable entry from the top <sup>2)</sup>	Cable entry from the bottom <sup>2)</sup>	-

<sup>1)</sup> The position of the connection busbars is identical for cable entry from the top or bottom  
<sup>2)</sup> Two main busbar systems in the cubicle are also possible  
<sup>3)</sup> Auxiliary device holder

Tab. 3/16: Cubicle types for outgoing feeder/incoming feeder cubicles with MCCB (front view at the top; side view at the bottom)

MCCB type	Rated device current	Rated operational current at an ambient temperature of 35 °C					
		Busbar position at the top		Busbar position at the rear			
		Cable connection from the bottom		Cable connection from the bottom		Cable connection from the top	
		Non-ventilated	Ventilated	Non-ventilated	Ventilated	Non-ventilated	Ventilated
3VA1563 / 3VA2563	630 A	590 A / 605 A	630 A / 630 A	580 A / 630 A	630 A / 630 A	570 A / 630 A	630 A / 630 A
3VA1580 / 3VA2580	800 A	660 A / 660 A	735 A / 730 A	690 A / 685 A	775 A / 775 A	730 A / 695 A	775 A / 765 A
3VA1510 / 3VA2510	1,000 A	815 A / 770 A	900 A / 905 A	800 A / 840 A	905 A / 955 A	780 A / 770 A	830 A / 895 A

Tab. 3/17: Rated operational currents for cubicles with 3VA

### 3.5 Cubicles for Direct Incoming Feeder / Direct Outgoing Feeder

The different cubicle types:

1. Busbar position at the top, cable entry from the bottom or top (the position of the connection busbars is identical for cable from the top or bottom)
2. Busbar position rear-top, cable entry from the top
3. Busbar position rear-top, cable entry from the bottom
4. Busbar position rear-bottom, cable entry from the top
5. Busbar position rear-bottom, cable entry from the bottom

are represented schematically in Fig. 3/7.

The cubicle width and maximum number of connectable cables depend on the rated current (Tab. 3/18 and Tab. 3/19). For 5,000 A and 6,300 A, connections with direct incoming adapter or busbar connections are possible only. The rated operational currents, in turn, depend on the busbar position and the cable entry (Tab. 3/20).

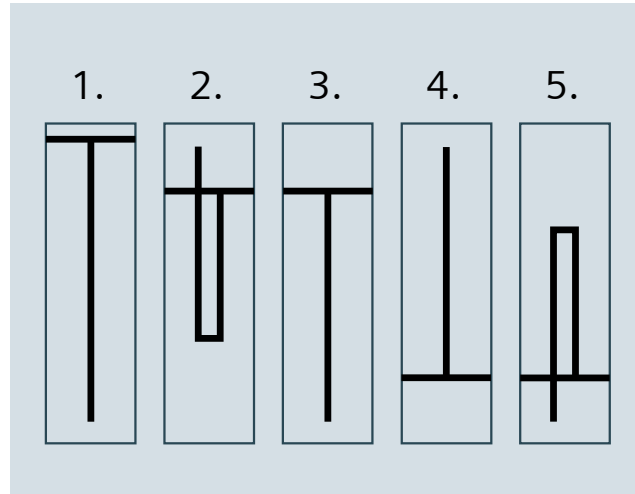

Fig. 3/7: Cubicle types for direct incoming feeder / direct outgoing feeder (refer to the text for explanations)

Rated current	1,000 A	1,600 A	2,500 A	3,200 A	4,000 A	5,000 A	6,300 A
Cubicle width	400 mm	400 mm	600 mm	600 mm	800 mm	1,000 mm	1,000 mm

Tab. 3/18: Cubicle width for direct incoming feeder / direct outgoing feeder

Cable lug acc. to DIN 46235 (240 mm <sup>2</sup> , M12) <sup>1)</sup>	Max. number of cables connectable per phase depending on the rated current				
	1,000 A	1,600 A	2,500 A	3,200 A	4,000 A
	4	6	12	12	14

<sup>1)</sup> 300 mm<sup>2</sup> cable lugs with bolt M12 can be used. However, this cable lug does not comply with DIN 46235, although it is available at some manufacturers

- The number of connectable cables may be restricted by the available openings in the roof/floor plate and/or by door-mounted components.
- The position of the connection busbars is identical for front or rear connection in the cubicle.

Tab. 3/19: Cable connection for direct incoming feeder / direct outgoing feeder

Rated current	Rated operational current at an ambient temperature of 35 °C					
	Busbar position at the top		Busbar position at the rear			
	Cable connection		Cable entry from the bottom		Cable entry from the top	
	Non-ventilated	Ventilated	Non-ventilated	Ventilated	Non-ventilated	Ventilated
1,000 A	905 A	1,050 A	1,100 A	1,190 A	1,120 A	1,280 A
1,600 A	1,300 A	1,500 A	1,530 A	1,640 A	1,480 A	1,740 A
2,500 A	1,980 A	2,410 A	2,230 A	2,930 A	2,210 A	2,930 A
3,200 A	2,340 A	2,280 A	2,910 A	3,390 A	2,770 A	3,390 A
4,000 A	3,430 A	4,480 A	3,300 A	4,210 A	3,140 A	4,210 A
5,000 A <sup>1)</sup>	-	-	3,180 A	4,840 A	-	-
<b>With busbar connection</b>						
LI-C5000 <sup>1)</sup>	-	-	3,490 A	4,840 A	3,420 A	4,860 A
LI-C6300 <sup>1)</sup>	-	-	3,670 A	5,100 A	3,640 A	5,330 A

<sup>1)</sup> Design with direct incoming adapter

Tab. 3/20: Rated operational currents for direct incoming feeder



# Chapter 4

## Universal Mounting Design

4.1	Fixed-Mounted Design with Compartment Door	39
4.2	In-Line Switch-Disconnectors with Fuses (3NJ63, SASILplus)	40
4.3	Withdrawable Design	40

# 4 Universal Mounting Design

The universal mounting design of SIVACON S8 switchboards (Fig. 4/1) allows outgoing feeders in withdrawable design, fixed-mounted design, and plug-in in-line design.

The combination of these mounting designs makes for a space-optimized installation of the switchboard. Tab. 4/1 gives an overview of the general cubicle characteristics.



Fig. 4/1: Cubicle for universal mounting design with cable connection from the front

<b>Application</b>	<ul style="list-style-type: none"> <li>- Incoming feeder up to 630 A</li> <li>- Cable feeders up to 630 A</li> <li>- Motor feeders up to 630 A</li> </ul>	
<b>Degrees of protection</b>	<ul style="list-style-type: none"> <li>- Up to IP43</li> <li>- IP54</li> </ul>	<ul style="list-style-type: none"> <li>Ventilated</li> <li>Non-ventilated</li> </ul>
<b>Cubicle dimensions</b>	<ul style="list-style-type: none"> <li>- Cubicle height</li> <li>- Cubicle width (rear connection in the cubicle)</li> <li>- Cubicle width (front connection in the cubicle)</li> </ul>	<ul style="list-style-type: none"> <li>2,000; 2,200 mm</li> <li>600 mm</li> <li>1,000; 1,200 mm</li> </ul>
<b>Device compartment</b>	<ul style="list-style-type: none"> <li>- Height</li> <li>- Width</li> </ul>	<ul style="list-style-type: none"> <li>1,600; 1,800 mm</li> <li>600 mm</li> </ul>
<b>Form of internal separation</b>	<ul style="list-style-type: none"> <li>- Up to form 4b <sup>1)</sup> and up to form 4b type 6/7 (BS)</li> </ul>	<ul style="list-style-type: none"> <li>Compartment door,</li> <li>functional compartment door</li> </ul>
<b>Mounting designs</b>	<ul style="list-style-type: none"> <li>- Withdrawable design</li> <li>- Fixed-mounted design with compartment door</li> <li>- In-line switch-disconnectors with fuses 3NJ63 <sup>2)</sup></li> <li>- In-line switch-disconnectors with fuses SASILplus (Jean Müller) <sup>2)</sup></li> </ul>	

<sup>1)</sup> Depending on the mounting design

<sup>2)</sup> Front connection in the cubicle

Tab. 4/1: General cubicle characteristics for the universal mounting design



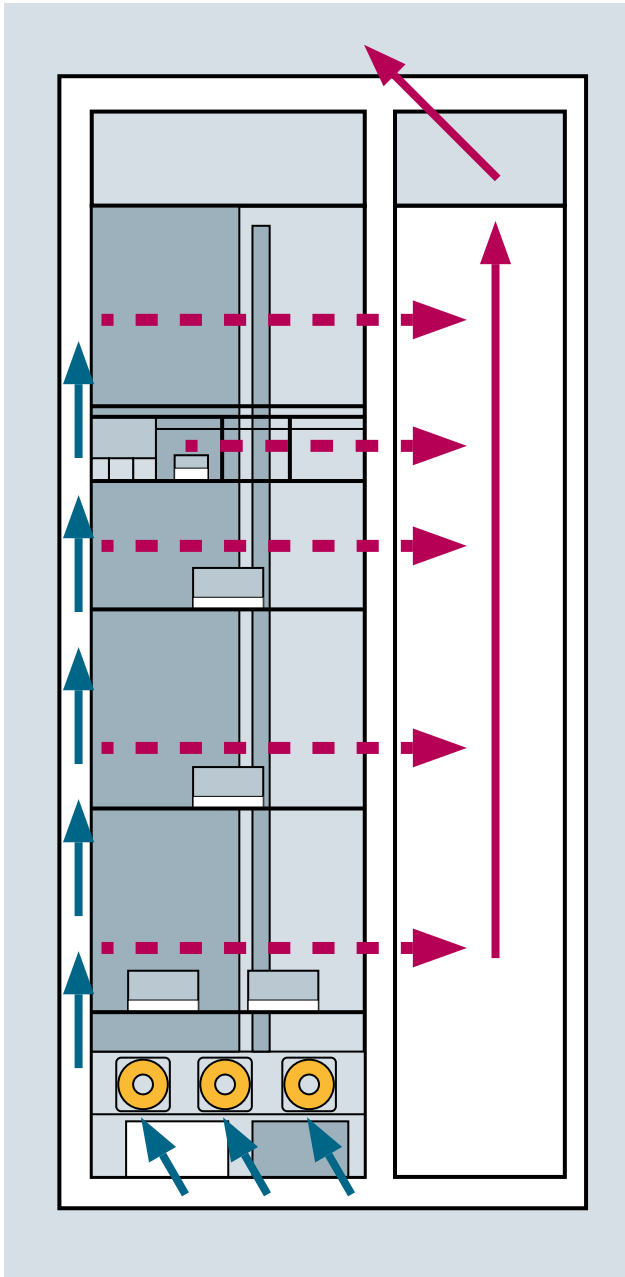

Fig. 4/2: Cubicle with forced ventilation for universal mounting design

### Cubicle with forced ventilation

Cubicles with forced ventilation (Fig. 4/2) are used for accommodation of functional units with a very high power loss and for avoidance of derating, in particular in case of a high degree of protection.

The fan control comes completely configured from the factory. No further settings are required during switch-board commissioning. The fans are dimensioned such that, if a fan fails, the remaining fans can still ensure the necessary heat dissipation of the withdrawable unit. A failure message will be issued.

The cubicles with forced ventilation comply with degree of protection up to IP54. Connection in the cubicle is effected from the front.

The other cubicle characteristics are identical to the cubicle without forced ventilation. All mounting designs and functional units without forced ventilation can be used.

## Combination of mounting designs

The different mounting designs can be combined in a cubicle as shown in Fig. 4/3.

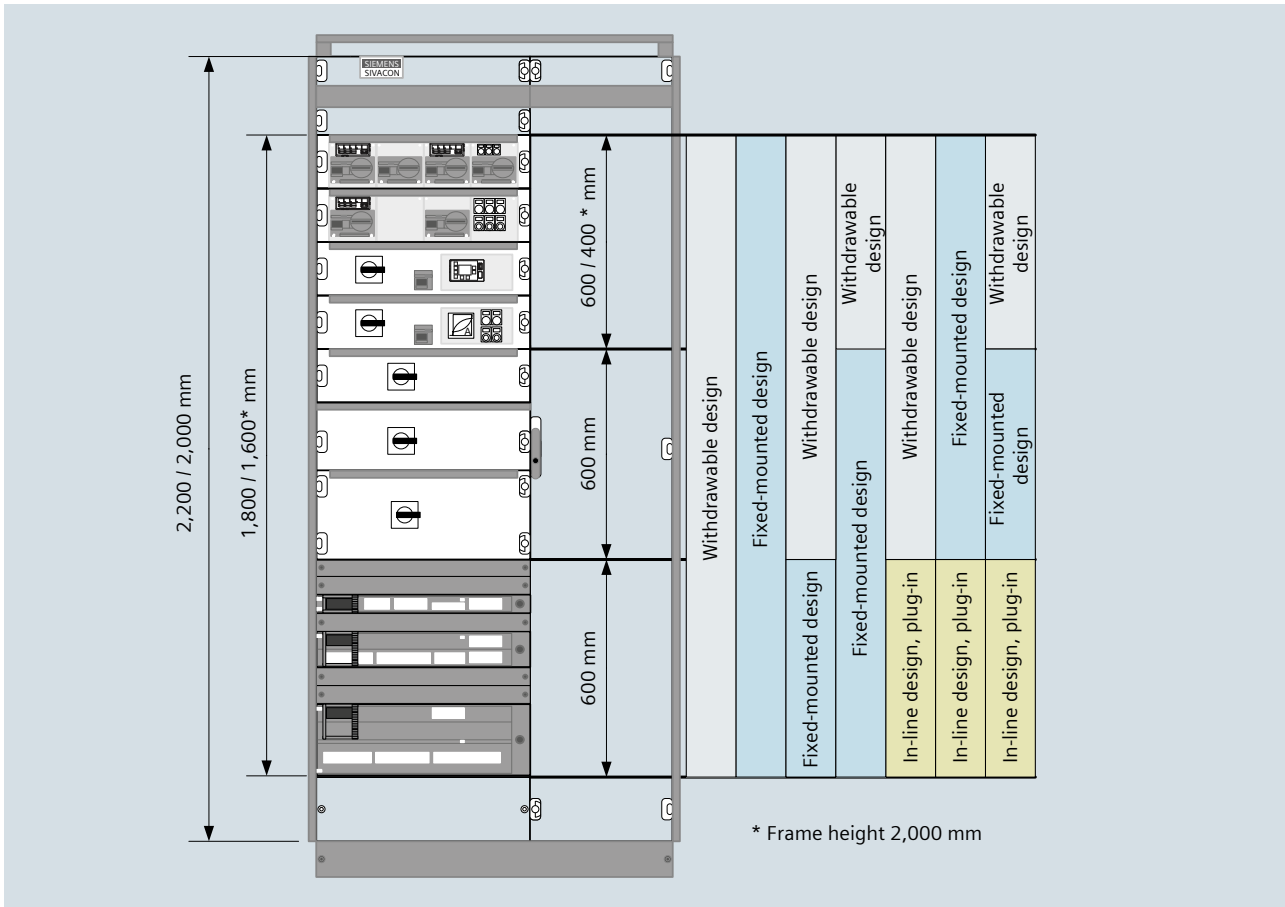

Fig. 4/3: Combination options for universal mounting design

## Vertical distribution busbar

The vertical distribution busbars with the line conductors L1, L2, L3 are arranged on the left inside the cubicle. The PE, N or PEN busbars are arranged in the cable compartment.

In the case of 4-pole feeders, the N conductor is allocated to the line conductors L1, L2, L3 at the rear inside the cubicle. Operational ratings are stated in Tab. 4/2.

Distribution busbar		Profile bar			Flat copper <sup>1)</sup>	
Cross-section		400 mm <sup>2</sup>	650 mm <sup>2</sup>	1,400 mm <sup>2</sup> <sup>1)</sup>	1 x (40 mm x 10 mm)	2 x (40 mm x 10 mm)
Rated operational current at an ambient temperature of 35 °C	Ventilated	905 A	1,100 A	1,720 A	865 A	1,120 A
	Non-ventilated	830 A	1,000 A	1,400 A	820 A	1,000 A
Rated short-time withstand current $I_{cw}$ (1 s) <sup>2)</sup>		65 kA	65 kA	100 kA	65 kA	65 kA

<sup>1)</sup> Main busbar position: only at the top

<sup>2)</sup> Rated conditional short-circuit current  $I_{cc} = 150$  kA

Tab. 4/2: Operational ratings of the vertical distribution busbar

## 4.1 Fixed-Mounted Design with Compartment Door

In fixed-mounted design, the switching devices are installed on mounting plates. They can be equipped with circuit-breakers or switch-disconnectors with fuses (Fig. 4/4; left). Tab. 4/3 gives an overview of the cubicle characteristics in fixed-mounted design. The incoming sides of the switching devices are connected to the vertical distribution busbars.

For forms 2b and 4a without current measurement, cables are connected directly at the switching device. The maximum cross-sections that can be connected are stated in the device catalogs. For forms 3b and 4b as well as for feeders with current measurement (instrument transformers), the cables are connected in the cable compartment (Fig. 4/4; right). The maximum connection cross-sections are stated in Tab. 4/4.

The operational ratings for cable feeders are stated in Tab. 4/5. The thermal interaction of the outgoing feeders in the cubicle has to be considered by specifying the rated diversity factor (RDF).

Permissible continuous operational current  $I_{ng}$ :  
 $I_{ng}(\text{cable feeder}) = \text{rated operational current } I_e \cdot \text{RDF}$

For the outgoing feeders in the cubicle, the rated diversity factor  $\text{RDF} = 0.8$  can be applied:

- Regardless of the number of outgoing feeders in the cubicle
- Regardless of the mounting position in the cubicle.

For cubicles with a very high packing and/or power density, a project-specific assessment is recommended. Further information can be obtained from your contact partner at Siemens.



Fig. 4/4: Arrangement of components in fixed-mounted design (left) and connection terminals in the cable compartment (right)

<b>Application</b>	- Incoming feeder up to 630 A - Cable feeders up to 630 A
<b>Form of internal separation</b>	- Form 2b Functional compartment door - Form 3b, 4a, 4b <sup>1)</sup> Compartment door
<b>Mounting designs</b>	- Fixed-mounted module in compartment - Empty compart., device compartment

<sup>1)</sup> Also form 4b type 7 acc. to BS EN 61439-2 possible

Tab. 4/3: Cubicle characteristics for fixed-mounted design

Rated feeder current	Bolted joint	Max. conductor cross-section
≤ 250 A	M10	1 x 185 mm <sup>2</sup> or 2 x 120 mm <sup>2</sup>
> 250 A up to 630 A	M12	1 x 240 mm <sup>2</sup> or 2 x 120 mm <sup>2</sup>

Tab. 4/4: Conductor cross-sections in fixed-mounted cubicles with front door

Type	Rated device current	Module height		Rated operational current $I_e$ at an ambient temperature of 35 °C	
		3-pole	4-pole	Non-ventilated	Ventilated
<b>Fuse-switch-disconnector <sup>1)</sup></b>					
3NP1123	160 A	150 mm	-	106 A	120 A
3NP1133	160 A	150 mm	-	123 A	133 A
3NP1143	250 A	250 mm	-	222 A	241 A
3NP1153	400 A	300 mm	-	350 A	375 A
3NP1163	630 A	350 mm	-	480 A	530 A
3NP4010	160 A	150 mm	-	84 A	96 A
3NP4070	160 A	150 mm	-	130 A	142 A
3NP4270	250 A	250 mm	-	248 A	250 A
3NP4370	400 A	300 mm	-	355 A	370 A
3NP4470	630 A	350 mm	-	480 A	515 A
3NP5060	160 A	150 mm	-	130 A	142 A
3NP5260	250 A	250 mm	-	248 A	250 A
3NP5360	400 A	300 mm	-	355 A	370 A
3NP5460	630 A	350 mm	-	480 A	515 A
<b>Switch-disconnector with fuses <sup>1)</sup></b>					
3KF1	63 A	200 mm	200 mm	63 A	63 A
3KF2	160 A	250 mm	250 mm	144 A	152 A
3KF3	250 A	300 mm	350 mm	206 A	237 A
3KF4	400 A	300 mm	350 mm	315 A	365 A
3KF5	630 A	450 mm	500 mm	495 A	580 A
<b>Circuit-breaker</b>					
3RV2.1	16 A	150 mm <sup>2)</sup>	-	12.7 A	14.1 A
3RV2.2	40 A	150 mm <sup>2)</sup>	-	27 A	31.5 A
3RV2.3	80 A	150 mm <sup>2)</sup>	-	71 A	78 A
3RV2.4	100 A	150 mm <sup>2)</sup>	-	79 A	90 A
3VA10	100 A	150 mm <sup>2)</sup>	200 mm	72 A	85 A
3VA11	160 A	150 mm <sup>2)</sup>	200 mm	112 A	125 A
3VA12	250 A	150 mm <sup>2)</sup>	200 mm	232 A	246 A
3VA13	400 A	200 mm <sup>3)</sup>	250 mm	355 A	400 A
3VA14	630 A	200 mm <sup>3)</sup>	250 mm	410 A	460 A
3VA20	100 A	150 mm <sup>2)</sup>	200 mm	100 A	100 A
3VA21	160 A	150 mm <sup>2)</sup>	200 mm	160 A	160 A
3VA22	250 A	150 mm <sup>2)</sup>	200 mm	201 A	226 A
3VA23	400 A	200 mm <sup>3)</sup>	250 mm	350 A	400 A
3VA24	630 A	200 mm <sup>3)</sup>	250 mm	410 A	495 A
<b>Device compartments (usable mounting depth 310 mm)</b>					
Module height: 150, 200, 300, 400, 500, 600 mm					
<sup>1)</sup> Rated operational current with fuse-link = rated device current					
<sup>2)</sup> Module height 200 mm for 3-pole + N					
<sup>3)</sup> Module height 250 mm for 3-pole + N					

Tab. 4/5: Operational ratings for cable feeders

## 4.2 In-Line Switch-Disconnectors with Fuses (3NJ63 / SASILplus)

For the cubicle in universal mounting design, an adapter is available that allows the installation of in-line switch-disconnectors with fuses. This adapter is mounted in the cubicle at the bottom. It occupies 600 mm in the cubicle's device compartment.

A mounting height of 500 mm is available for the installation of in-line switch-disconnectors. The basic cubicle characteristics are stated in Tab. 4/6. More information on the in-line switch-disconnectors 3NJ63 can be found in Chapter 5.

<b>Application</b>	- Incoming feeder up to 630 A - Cable feeders up to 630 A	
<b>Form of internal separation</b>	- Form 3b, 4b	
<b>Degree of protection</b>	- Up to IP41	Ventilated
<b>Cubicle dimensions</b>	- Width (front connection in the cubicle)	1,000 mm; 1,200 mm

Tab. 4/6: Cubicle characteristics for in-line switch-disconnectors

## 4.3 Withdrawable Design

If fast replacement of functional units is required in order to prevent downtimes, the withdrawable design offers a safe and flexible solution. Regardless of whether small or normal withdrawable units are used, the size is

optimally adapted to the required power. The patented withdrawable unit contact system has been conceived to be user-friendly and wear-resistant. Typical cubicle characteristics of the withdrawable design are listed in Tab. 4/7.

<b>Application</b>	- Incoming feeder up to 630 A - Cable feeders up to 630 A - Motor feeders up to 630 A	
<b>Form of internal separation</b>	- Form 3b, 4b <sup>1)</sup>	Compartment door, modular cover
<b>Design options</b>	- Withdrawable unit in the compartment - Reserve compartment - Empty compartment, device compartment	
<b>Design versions for feeders <sup>2)</sup> (see Fig. 4/5)</b>	- Standard Feature Design (SFD) - High Feature Design (HFD)	
<sup>1)</sup> Also form 4b type 6/7 in acc. with BS EN 61439-2 possible		
<sup>2)</sup> Withdrawable unit versions in SFD and HFD can be mixed within one cubicle		

Tab. 4/7: General cubicle characteristics for withdrawable design



Fig. 4/5: Withdrawable design versions in Standard Feature Design (SFD; left) and High Feature Design (HFD; right)

### 4.3.1 Withdrawable Unit Version – High Feature Design (HFD)

The withdrawable units are equipped with a movable, low-wear disconnecting contact system. The disconnected, test and connected positions can be effected by moving the disconnecting contacts without shifting the withdrawable unit behind the closed compartment door (Fig. 4/7). Moving the disconnecting contacts under load is prevented by an operating error protection. The degree of protection is kept in every position. In the disconnected position, all parts of the withdrawable unit such as the contacts are located within the device contour and are protected against damage.

Withdrawable units are available as small withdrawable units (size 1/2 and 1/4, see Fig. 4/6 and Tab. 4/8) and as normal withdrawable units (Tab. 4/8). The withdrawable units of all sizes provide a uniform user interface for operation and indication.

In addition to the main switch, the individual positions can be locked. Control and signaling devices are installed in an instrument board. All withdrawable units are equipped with up to forty auxiliary contacts.

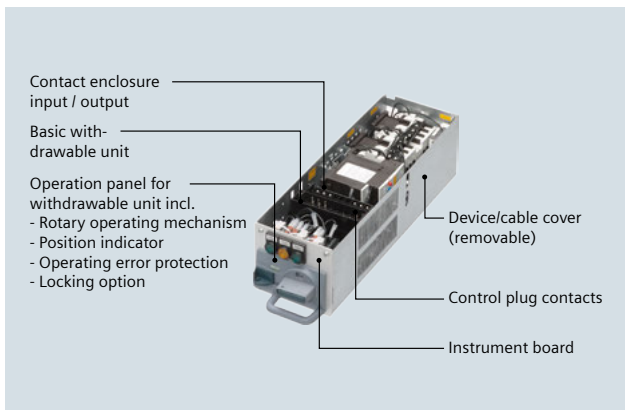

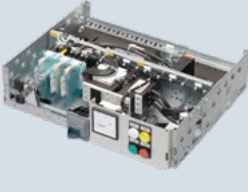

Fig. 4/6: Structure of a small withdrawable unit in HFD

Design	Withdrawable unit height	View
Small withdrawable unit width 1/4	150 mm, 200 mm, 300 mm	
Small withdrawable unit width 1/2	150 mm, 200 mm	
Normal withdrawable unit	≥ 100 mm (grid 50 mm)	

Tab. 4/8: Withdrawable units in HFD

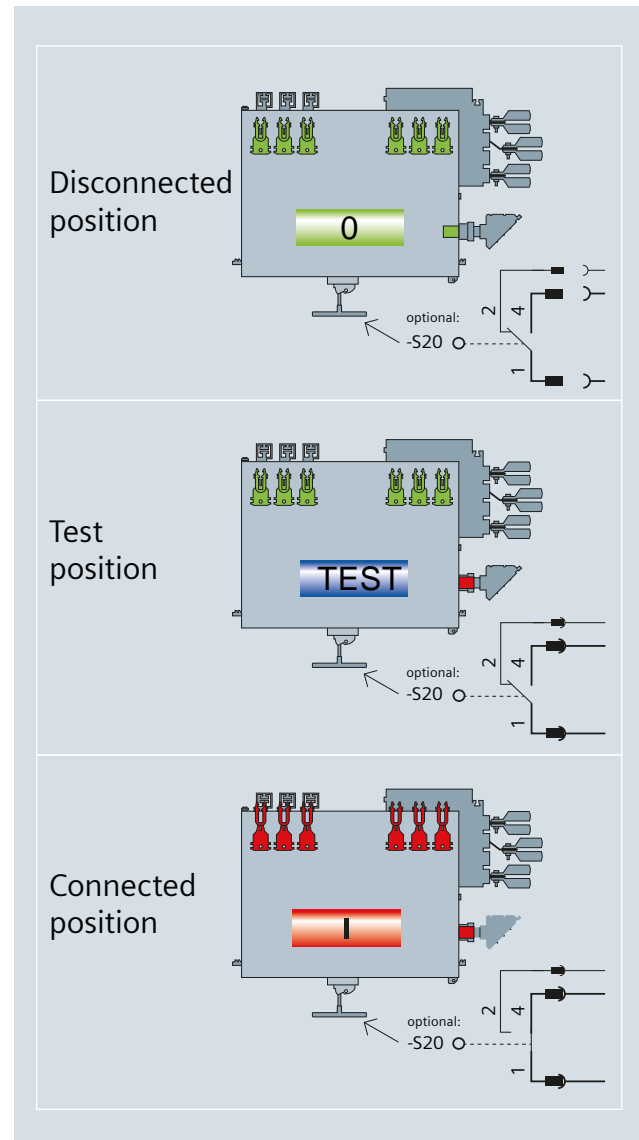
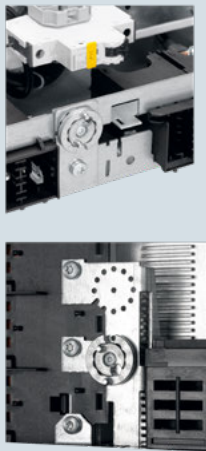



Fig. 4/7: Positions with disconnecting contact system in HFD

1  
2  
3  
4  
5  
6  
7  
8  
9  
10  
11  
12

## Characteristics of withdrawable units in HFD

Tab. 4/9 distinguishes between small and normal withdrawable units. The mounting height has to be observed additionally. The mechanical coding of the compartments and withdrawable units prevents mixing up withdrawable units of identical size. The control and indication devices for the feeder are installed in the instrument board. Fig. 4/8, Fig. 4/9 and Fig. 4/10 show the corresponding usable front areas.

	Small withdrawable unit	Normal withdrawable unit
<b>Mechanical withdrawable unit coding (optional)</b>		
	96 coding options (height of withdrawable unit 150, 200, 300 mm)	96 coding options (height of withdrawable unit 100 mm)
		9,216 coding options (height of withdrawable unit > 100 mm)
<b>Locking capability</b>		
	<p>The withdrawable units can be locked by means of a padlock with a shackle diameter of 6 mm. The withdrawable unit can then neither be moved to the disconnected, test or connected position nor be removed from the compartment.</p> <p>Locking capability of the main switch in the "0" position is integrated into the control unit: max. 3 padlocks with 4.5 mm Ø (shackle)</p>	<p>Locking capability for door coupling rotary operating mechanism 8UD in "0" position: max. 5 padlocks with 4.5 mm Ø (shackle) or max. 3 padlocks with 8.5 mm Ø (shackle)</p>
<b>Instrument board</b>		
<b>Maximum mounting depth for devices</b>	60 mm	70 mm
<b>Usable front area</b>	For a mounting height of 150 mm, see Fig. 4/11 For a mounting height of 200 mm, see Fig. 4/12	See Fig. 4/13
<b>Withdrawable unit position signal (optional)</b>		
<b>With signaling switch (-S20)</b>	Feeder available signal (AZV)	Feeder available signal (AZV)
	Test position signal (Test)	Test position signal (Test)
<b>Communication interfaces</b>		
<b>PROFIBUS <sup>1)</sup> (up to 12 Mbit/s)</b>	Via auxiliary contacts of the control plug	Via auxiliary contacts of the control plug
<b>PROFINET <sup>2)</sup></b>	Size ¼: One separate RJ45 plug	One or two separate RJ45 plug(s)
	Size ½: One or two separate RJ45 plug(s)	
<p><sup>1)</sup> Apart from that, other protocols based on the EIA-485 (RS485) interface standard, such as Modbus RTU, can be used</p> <p><sup>2)</sup> Apart from that, other protocols based on the Industrial Ethernet standard, such as Modbus/TCP, can be used</p>		

Tab. 4/9: Characteristics of withdrawable units in HFD

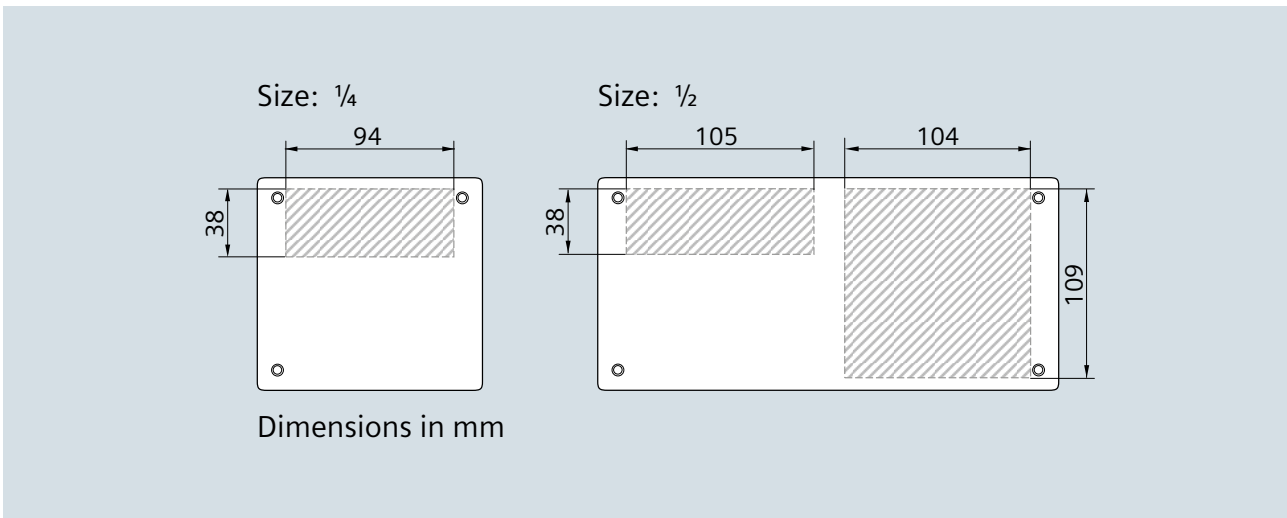

Fig. 4/8: Front areas usable for an instrument board for small withdrawable units with a mounting height of 150 mm

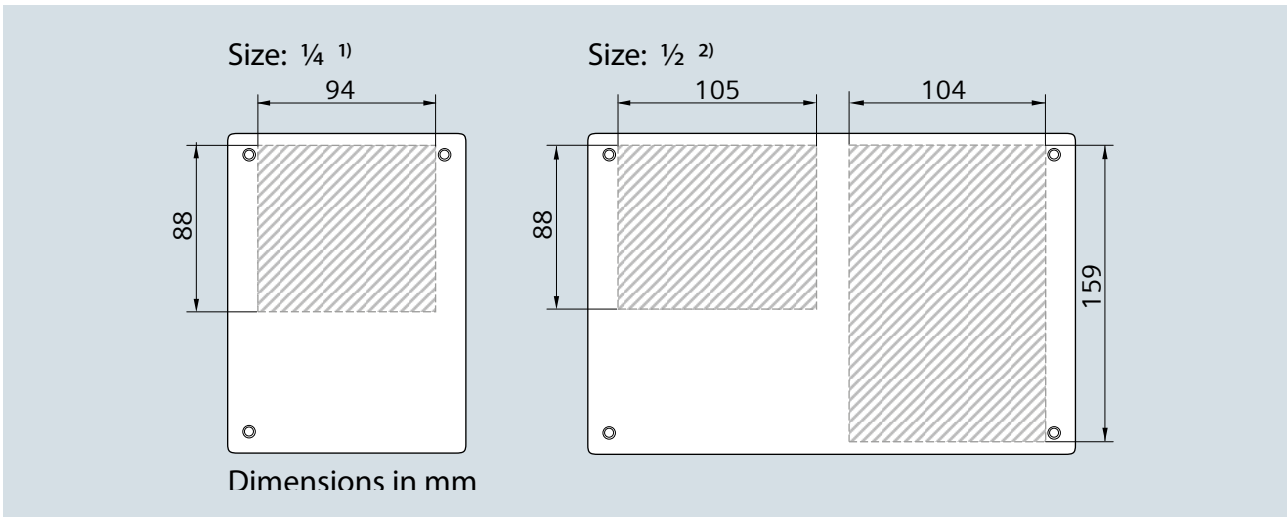

Fig. 4/9: Front areas usable for an instrument board for small withdrawable units with a mounting height of 200 mm for <sup>1) 2)</sup> and 300 mm for <sup>1)</sup>

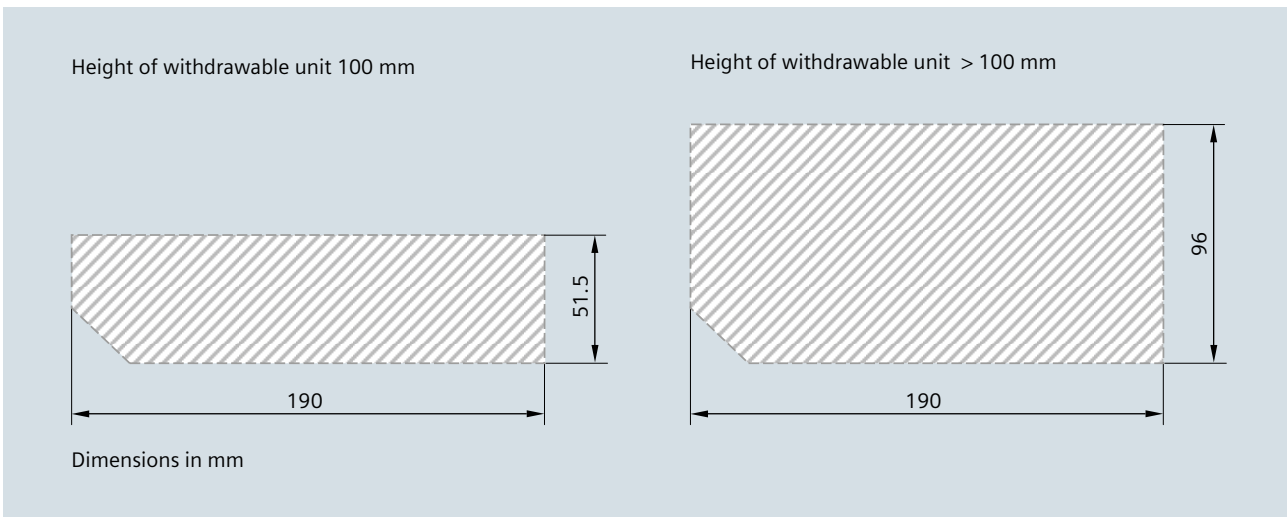

Fig. 4/10: Front areas usable for an instrument board for normal withdrawable units

1

2

3

4

5

6

7

8

9

10

11

12

### 4.3.2 Withdrawable Unit Compartment in HFD

The vertical distribution busbar is covered test finger proofed (IP2X). Phase separation is possible. No connection work is required in the compartment (Fig. 4/11). The internal separation options up to form 4b lead to a high level of personnel safety.

For small withdrawable units, an adapter plate is mounted at the top in the compartment (Fig. 4/12). The tap-off openings for the input contacts of the withdrawable units in the compartment can be equipped with shutters.

The shutters are opened automatically when the withdrawable unit is inserted into the compartment.

Connection is effected in a separate cable compartment. The connection data for main circuits are stated in Tab. 4/10, those for auxiliary circuits in Tab. 4/11, and the number of free auxiliary contacts in Tab. 4/12.

The rated current for auxiliary contacts is:

- 6 A (250 V) for small withdrawable units
- 10 A (250 V) for normal withdrawable units.

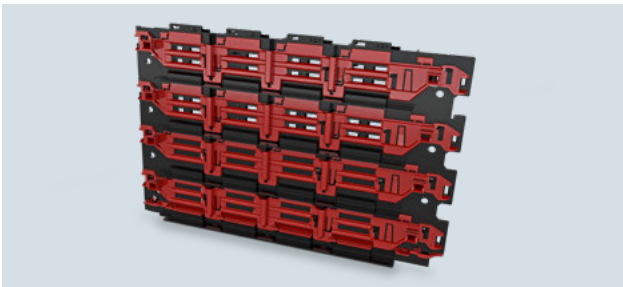

Fig. 4/11: Shutter for normal withdrawable unit in HFD



Fig. 4/12: Adapter plate for small withdrawable units

	Withdrawable unit height	Rated feeder current	Terminal size	Maximum conductor cross-section
Small withdrawable unit	150, 200, 300 mm	≤ 35 A	16 mm <sup>2</sup>	-
		≤ 63 A	35 mm <sup>2</sup>	-
Normal withdrawable unit	100 mm	≤ 35 A	16 mm <sup>2</sup>	-
		≤ 63 A	35 mm <sup>2</sup>	-
	≥ 150 mm	≤ 250 A	-	1 x 185 mm <sup>2</sup> 2 x 120 mm <sup>2</sup>
		> 250 A	-	2 x 240 mm <sup>2</sup> 4 x 120 mm <sup>2</sup>

Tab. 4/10: Connection data for main circuit

Design	Terminal size
Push-in clamp connection	2.5 mm <sup>2</sup>
Screw connection	2.5 mm <sup>2</sup>

Tab. 4/11: Connection data for auxiliary circuit

	Withdrawable unit height	Type of control plug	Number of available auxiliary contacts		
			Without communication	With PROFIBUS	With PROFINET
Small withdrawable unit	150, 200 mm	26-pole	26	20	19
		40-pole	40	37	32
Normal withdrawable unit	≥ 100 mm	12-pole	12	9	12
		24-pole	24	21	24
	≥ 150 mm	32-pole	32	29	32
		40-pole	40	37	40

Tab. 4/12: Number of free auxiliary contacts for withdrawable units in HFD



### 4.3.3 Withdrawable Unit Version – Standard Feature Design (SFD)

The withdrawable units provide a fixed disconnecting contact system. Disconnected, test and connected position can be effected by moving the withdrawable unit (Fig. 4/13). In disconnected and test position, degree of protection IP30 is achieved. Moving the withdrawable unit under load is prevented by an operating error protection.

Withdrawable units in SFD are equipped with a detachable cover. Control and signaling devices are installed in an instrument board and integrated into the withdrawable unit cover (Fig. 4/14). The disconnecting contact system can be used up to a rated current of 250 A. All withdrawable units are equipped with up to forty auxiliary contacts. In SFD, normal withdrawable units with a withdrawable unit height of 100 mm or higher (grid size 50 mm) can be used. The characteristics of withdrawable units in SFD are summarized in Tab. 4/13.

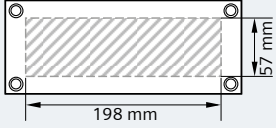
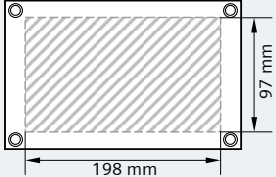
Mechanical withdrawable unit coding	
Withdrawable unit height 100 mm	15 coding options
Withdrawable unit height > 100 mm	21 coding options
Locking capability	
In "0" position for 8UD door coupling rotary operating mechanism	Maximum 5 padlocks with a shackle diameter of 4.5 mm Maximum 3 padlocks with a shackle diameter of 8.5 mm
Instrument board	
Maximum mounting depth for devices	60 mm
Usable front area for withdrawable unit height 100 mm	
Usable front area for withdrawable unit height > 100 mm	
Withdrawable unit position signal	
With optional signaling switch (-S20)	Feeder available signal (AZV)
	Test position signal (Test)
Communication interfaces	
PROFIBUS <sup>1)</sup> (up to 12 Mbit/s)	Via auxiliary contacts of the control plug
PROFINET <sup>2)</sup>	Separate RJ45 plug
<sup>1)</sup> Apart from that, other protocols based on the EIA-485 (RS485) interface standard, such as Modbus RTU, can be used	
<sup>2)</sup> Apart from that, other protocols based on the Industrial Ethernet standard, such as Modbus/TCP, can be used	

Tab. 4/13: Characteristics of withdrawable units in SFD

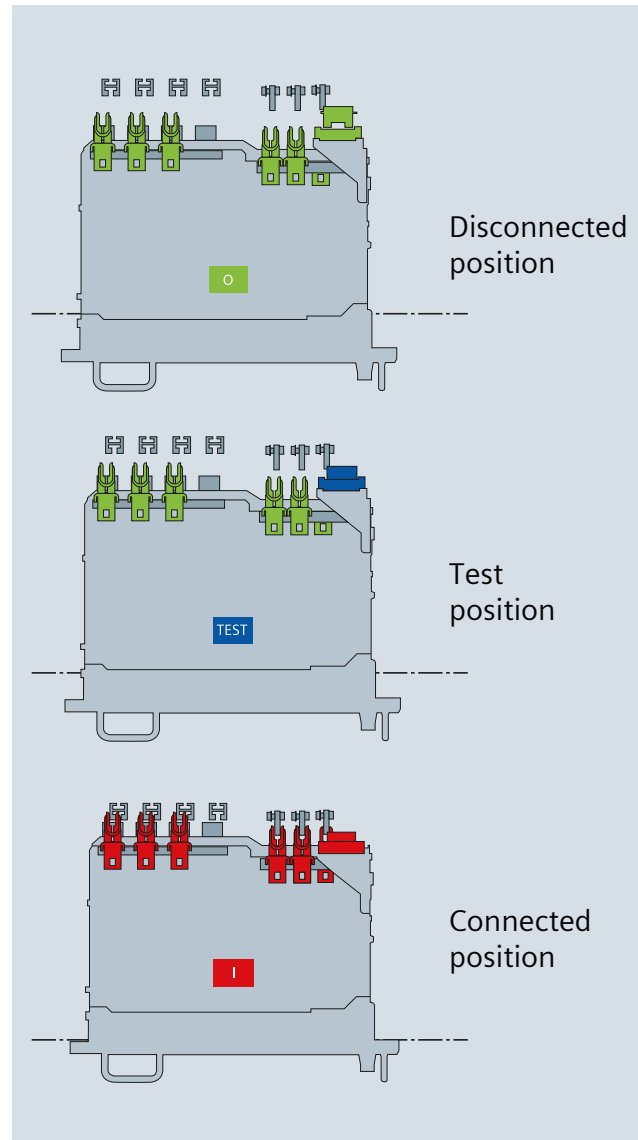

Fig. 4/13: Positions with disconnecting contact system in SFD

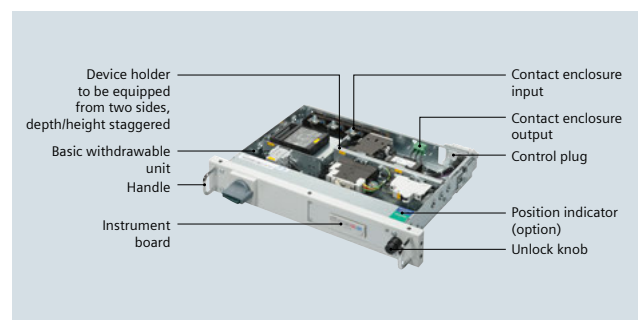

Fig. 4/14: Normal withdrawable unit in SFD with a withdrawable unit height of 100 mm

### 4.3.4 Withdrawable Unit Compartment in SFD

The vertical distribution busbar is covered test finger proofed (IP2X). Phase separation is possible. No connection work is required in the compartment (Fig. 4/15). The internal separation options up to form 4b lead to a high level of personnel safety. Connection is effected in a separate cable compartment. The connection data for main circuits are stated in Tab. 4/14, those for auxiliary circuits in Tab. 4/15, and the number of free auxiliary contacts in Tab. 4/16.

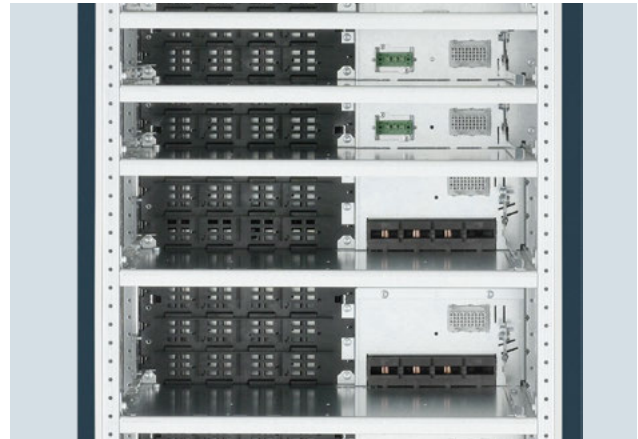

Fig. 4/15: Open withdrawable unit compartments in SFD

	Withdrawable unit height	Rated feeder current	Terminal size	Maximum conductor cross-section
Front connection in the cubicle	≥ 100 mm	≤ 35 A	16 mm <sup>2</sup>	-
		≤ 63 A	35 mm <sup>2</sup>	-
		≤ 120 A	70 mm <sup>2</sup>	-
		≤ 160 A	95 mm <sup>2</sup>	-
		≤ 250 A	150 mm <sup>2</sup>	-
Rear connection in the cubicle	100 mm	≤ 35 A	16 mm <sup>2</sup>	-
	≥ 150 mm	≤ 250 A	-	1 x 185 mm <sup>2</sup> 2 x 120 mm <sup>2</sup>

Tab. 4/14: Connection data for main circuit

Design	Terminal size
Push-in clamp connection	4 mm <sup>2</sup>
Screw connection	6 mm <sup>2</sup>

Tab. 4/15: Connection data for auxiliary circuit

Withdrawable unit height	Type of control plug	Quantity of free auxiliary contacts (rated current 10 A / 250 V)		
		without communication	with PROFIBUS	with PROFINET
≥ 100 mm	12-pole	12	9	12
	24-pole	24	21	24
≥ 150 mm	32-pole	32	29	-
	40-pole	40	37	-

Tab. 4/16: Number of free auxiliary contacts for withdrawable units in SFD

### 4.3.5 Operational Data for Cable Feeders

Withdrawable units in SFD are used up to a rated current of 250 A. The two withdrawable unit versions in SFD and HFD can be mixed within one cubicle.

The thermal interaction of the outgoing feeders in the cubicle has to be considered. This is done by specifying the rated diversity factor RDF.

Permissible continuous operational current  $I_{ng}$ :  
 $I_{ng}$  (cable feeder) = rated operational current  $I_e$  · RDF

For the outgoing feeders in the cubicle, the rated diversity factor RDF = 0.8 can be applied:

- Regardless of the number of outgoing feeders in the cubicle
- Regardless of the mounting position in the cubicle.

Rated operational currents and minimum withdrawable unit heights for cable feeders are stated in Tab. 4/17.

For cubicles with a very high packing and/or power density, a project-specific assessment is recommended. Further information can be obtained from your contact partner at Siemens.

Small withdrawable unit <sup>1)</sup>					
Type	Rated device current	Minimum withdrawable unit size (height)		Rated operational current $I_e$ at an ambient temperature of 35 °C	
		3-pole	4-pole	Non-ventilated	Ventilated
<b>Main switch and fuses <sup>3)</sup></b>					
3LD22	32 A	150 mm - ¼, ½	150 mm - ¼, ½	32 A	32 A
3LD25	63 A	150 mm - ¼, ½	200 mm - ¼, ½	52.5 A	55.5 A
<b>Circuit-breaker</b>					
3RV2.1	16 A	150 mm - ¼, ½ <sup>4)</sup>	-	14.6 A	15.2 A
3RV2.2	40 A	150 mm - ¼, ½ <sup>4)</sup>	-	32 A	33.5 A
3RV2.3	52 A	150 mm - ½ <sup>4)</sup>	-	40 A	41 A
3RV2.4	63 A	150 mm - ½ <sup>4)</sup>	-	45 A	50 A
3VA10	63 A	150 mm - ½ <sup>4)</sup>	200 mm - ½	on request	on request
3VA11	63 A	150 mm - ½ <sup>4)</sup>	200 mm - ½	48 A	52 A
<b>Normal withdrawable unit</b>					
Type	Rated device current	Minimum withdrawable unit size (height)		Rated operational current $I_e$ at an ambient temperature of 35 °C	
		3-pole	4-pole	Non-ventilated	Ventilated
<b>Main switch and fuses <sup>3)</sup></b>					
3LD22	32 A	100 mm	-	32 A	32 A
<b>Switch-disconnector with fuses <sup>3)</sup></b>					
3KF1	63 A	150 mm	150 mm	63 A	63 A
3KF2	125 A	150 mm	200 mm	115 A	124 A
3KF2	160 A	200 mm	200 mm	144 A	152 A
3KF3	250 A	300 mm	300 mm	204 A	233 A
3KF4	400 A	300 mm	300 mm	305 A	345 A
3KF5	630 A	400 mm	500 mm	380 A	470 A
<b>Circuit-breaker</b>					
3RV2.1	16 A	100 mm <sup>4)</sup>	-	14.6 A	15.2 A
3RV2.2	40 A	100 mm <sup>4)</sup>	-	32 A	33.5 A
3RV2.3	52 A	150 mm <sup>4)</sup>	-	40 A	41 A
3RV2.4	100 A	150 mm <sup>4)</sup>	-	79 A	90 A
3VA10	100 A	150 mm	200 mm <sup>4)</sup>	92 A	97 A
3VA11	160 A	150 mm	200 mm <sup>4)</sup>	128 A	133 A
3VA12	250 A	200 mm	250 mm <sup>4)</sup>	218 A	226 A
3VA13	400 A	300 mm	300 mm <sup>4)</sup>	355 A	400 A
3VA14	630 A	300 mm	400 mm <sup>4)</sup>	410 A	460 A
3VA15	630 A	400 mm	500 mm <sup>4)</sup>	435 A	500 A
3VA20	100 A	200 mm	200 mm <sup>4)</sup>	100 A	100 A
3VA21	160 A	200 mm	200 mm <sup>4)</sup>	155 A	160 A
3VA22	250 A	200 mm	250 mm <sup>4)</sup>	189 A	203 A
3VA23	400 A	300 mm	300 mm <sup>4)</sup>	320 A	350 A
3VA24	630 A	300 mm	400 mm <sup>4)</sup>	365 A	405 A
3VA25	630 A	400 mm	500 mm <sup>4)</sup>	455 A	510 A

<sup>1)</sup> Type: ¼ = small withdrawable unit size ¼  
½ = small withdrawable unit size ½  
<sup>4)</sup> Also 3-pole + N (only rear connection)

<sup>2)</sup> Circuit-breaker in vertical mounting position  
<sup>3)</sup> Rated operational current with fuse-link = rated device current

Tab. 4/17: Rated operational currents and minimum withdrawable unit heights for cable feeders in SFD / HFD

### 4.3.6 Operational Data for Motor Feeders in SFD / HFD

Withdrawable units in SFD are used up to a rated current of 250 A. The two withdrawable unit versions in SFD and HFD can be mixed within one cubicle.

The following tables list the available sizes of withdrawable units (Tab. 4/18, Tab. 4/19 and Tab. 4/20) for motor feeders. Depending on the number of project-specific secondary devices and control wiring, larger withdrawable units may be required.

Further information on motor feeders can be obtained from your local contact partner at the Siemens AG office:

- Motor feeders for a rated voltage of 500 V and 690 V
- Motor feeders for trip class up to CLASS 30
- Motor feeders with a short-circuit breaking capacity up to 100 kA
- Motor feeders with soft starter.

Height of withdrawable units for motor feeders in normal withdrawable unit design, 400 V, CLASS 10, with overload relay, type 2 at 50 kA and an ambient temperature of 35 °C												
Motor rating <i>P</i> in kW (AC-2/AC-3)	Minimum height of withdrawable unit in mm											
	With overload relay						With SIMOCODE					
	Direct contactor		Reversing circuit		Star-delta		Direct contactor		Reversing circuit		Star-delta	
	Non-fused	Fused	Non-fused	Fused	Non-fused	Fused	Non-fused	Fused	Non-fused	Fused	Non-fused	Fused
0.25 kW	100	100	100	100	-	-	100	-	100	-	-	-
0.37 kW	100	100	100	100	-	-	100	-	100	-	-	-
0.55 kW	100	100	100	100	-	-	100	-	100	-	-	-
0.75 kW	100	100	100	100	-	-	100	-	100	-	-	-
1.1 kW	100	100	100	100	-	-	100	100	100	100	-	-
1.5 kW	100	100	100	100	-	-	100	-	100	-	-	-
2.2 kW	100	100	100	100	-	-	100	100	100	100	-	-
3 kW	100	100	100	100	-	-	100	100	100	100	-	-
4 kW	100	100	100	100	-	-	100	100	100	100	-	-
5.5 kW	100	100	100	100	150	-	100	-	100	-	150	-
7.5 kW	100	100	100	100	150	-	100	100	100	150	150	-
11 kW	100	100	100	100	150	-	150	150	150	150	150	-
15 kW	100	150	100	150	150	-	150	150	150	200	-	-
18.5 kW	150	150	150	200	-	-	200	200	250	200	-	-
22 kW	150	150	150	200	300	-	200	200	250	200	300	-
30 kW	150	200	200	200	300	-	200	200	250	200	300	-
37 kW	150	200	200	200	300	-	200	200	250	200	300	-
45 kW	150	200	200	200	300	-	200	300	250	400	300	-
55 kW	300	400	300	500	300	-	300	400	300	500	300	-
75 kW	300	400	300	500	300	-	300	400	300	500	300	-
90 kW	300	400	300	500	300	-	300	400	300	500	500	-
110 kW	500	500	500	600	500	-	500	500	500	600	500	-
132 kW	500	500	500	600	500	-	500	500	500	600	500	-
160 kW	500	500	500	600	500	-	500	600	500	700	500	-
200 kW	500	600	500	700	500	-	500	600	500	700	500	-
250 kW	500	600	500	700	-	-	500	600	500	700	-	-

Tab. 4/18: Sizes for normal withdrawable units

The thermal interaction of the outgoing feeders in the cubicle has to be considered. This is done by specifying the rated diversity factor RDF.

Permissible continuous operational current  $I_{ng}$ :  
 $I_{ng}$  (motor feeder) = rated operational current  $I_e$  · RDF

For the outgoing feeders in the cubicle, the rated diversity factor RDF = 0.8 can be applied:

- Regardless of the number of outgoing feeders in the cubicle
- Regardless of the mounting position in the cubicle.

For cubicles with a very high packing and/or power density, a project-specific assessment is recommended. Your contact partner at Siemens will be pleased to provide further information.

The standard values for the operational currents of three-phase asynchronous motors can be found in Chapter 10.

Height of withdrawable units for motor feeders in fused small withdrawable unit design, 400 V, CLASS 10, with overload relay, type 2 at 50 kA and an ambient temperature of 35 °C												
Motor rating $P$ in kW (AC-2/AC-3)	Minimum height of withdrawable unit in mm											
	With overload relay						With SIMOCODE					
	Direct contactor		Reversing circuit		Star-delta		Direct contactor		Reversing circuit		Star-delta	
	Withdrawable unit size		Withdrawable unit size		Withdrawable unit size		Withdrawable unit size		Withdrawable unit size		Withdrawable unit size	
	¼	½	¼	½	¼	½	¼	½	¼	½	¼	½
0.25 kW	150	150	150	150	-	150	-	-	-	-	-	-
0.37 kW	150	150	150	150	-	150	-	-	-	-	-	-
0.55 kW	150	150	150	150	-	150	-	-	-	-	-	-
0.75 kW	150	150	150	150	-	150	-	-	-	-	-	150
1.1 kW	150	150	150	150	-	150	150	150	200	150	-	150
1.5 kW	150	150	150	150	-	150	-	-	-	-	-	150
2.2 kW	150	150	150	150	-	150	150	150	200	150	-	150
3 kW	150	150	150	150	-	150	150	150	200	150	-	150
4 kW	150	150	150	150	-	150	150	150	200	150	-	150
5.5 kW	150	150	150	150	-	150	-	-	-	-	-	150
7.5 kW	150	150	150	150	-	150	200	150	200	150	-	150
11 kW	150	150	150	150	-	150	300	150	300	200	-	150
15 kW	300	150	300	200	-	150	300	150	300	200	-	150
18.5 kW	300	150	300	200	-	150	300	150	300	200	-	150
22 kW	-	-	-	-	-	150	-	-	-	-	-	-

Tab. 4/19: Sizes of small withdrawable units for fused motor feeders

Height of withdrawable units for motor feeders in non-fused small withdrawable unit design, 400 V, CLASS 10, with overload relay, type 2 at 50 kA and an ambient temperature of 35 °C

Motor rating <i>P</i> in kW (AC-2/AC-3)	Minimum height of withdrawable unit in mm											
	With overload relay						With SIMOCODE					
	Direct contactor		Reversing circuit		Star-delta		Direct contactor		Reversing circuit		Star-delta	
	Withdrawable unit size		Withdrawable unit size		Withdrawable unit size		Withdrawable unit size		Withdrawable unit size		Withdrawable unit size	
	¼	½	¼	½	¼	½	¼	½	¼	½	¼	½
0.25 kW	150	150	150	150	-	-	150	150	200	150	-	-
0.37 kW	150	150	150	150	-	-	150	150	200	150	-	-
0.55 kW	150	150	150	150	-	-	150	150	200	150	-	-
0.75 kW	150	150	150	150	-	-	150	150	200	150	-	-
1.1 kW	150	150	150	150	-	-	150	150	200	150	-	-
1.5 kW	150	150	150	150	-	-	150	150	200	150	-	-
2.2 kW	150	150	150	150	-	-	150	150	200	150	-	-
3 kW	150	150	150	150	-	-	150	150	200	150	-	-
4 kW	150	150	150	150	-	-	150	150	200	150	-	-
5.5 kW	150	150	150	150	-	150	150	150	200	150	-	150
7.5 kW	150	150	150	150	-	150	150	150	200	150	-	150
11 kW	150	150	150	150	-	150	200	150	300	150	-	200
15 kW	150	150	150	150	-	150	300	200	-	200	-	-
18.5 kW	300	150	-	200	-	-	-	200	-	-	-	-
22 kW	300	150	-	200	-	-	-	200	-	-	-	-
30 kW	-	200	-	-	-	-	-	200	-	-	-	-
37 kW	-	200	-	-	-	-	-	200	-	-	-	-
45 kW	-	200	-	-	-	-	-	200	-	-	-	-

Tab. 4/20: Sizes of small withdrawable units for non-fused motor feeders

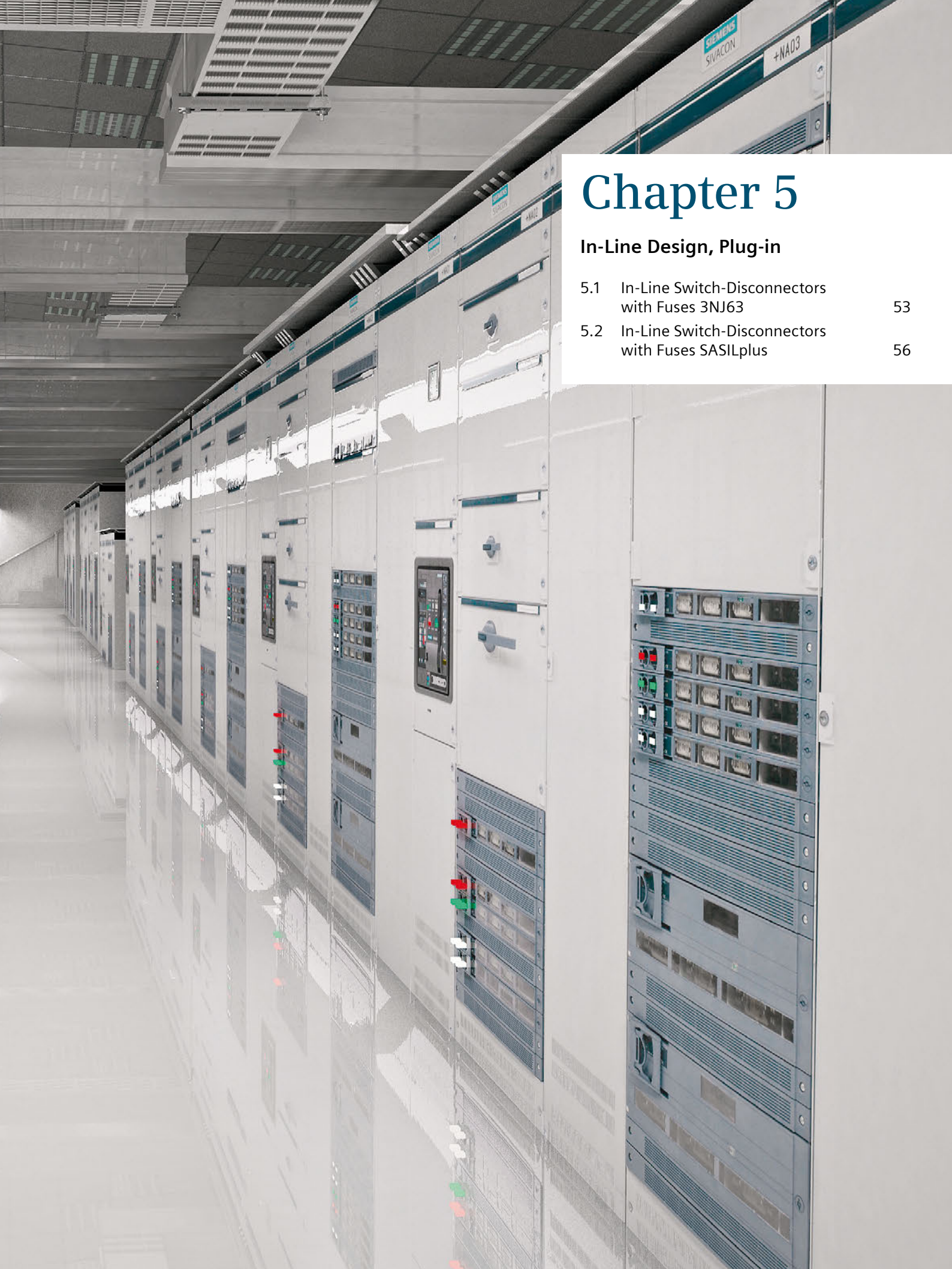

# Chapter 5

## In-Line Design, Plug-in

- 5.1 In-Line Switch-Disconnectors with Fuses 3NJ63 53
- 5.2 In-Line Switch-Disconnectors with Fuses SASILplus 56

# 5 In-Line Design, Plug-in

The plug-in design for SIVACON S8 switchboards (Fig. 5/1) with switching devices in in-line design with a plug-in contact on the supply side allows easy and fast modification or replacement under operating conditions. The plug-in in-line units are operated directly at the device. Tab. 5/1 gives an overview of the general cubicle characteristics.

Connection is effected directly at the switching device. The maximum cross-sections that can be connected are stated in the device catalogs. The in-line switch-disconnector allows the installation of a measuring device for 1-pole measurement. For 3-pole measurement, the measuring devices can be installed in the device compartment doors or in the door of the cable compartment. The associated current transformers are integrated into the in-line unit on the cable feeder side.



Fig. 5/1: Cubicles for plug-in in-line design: on the left for in-line switch-disconnectors with fuses 3NJ63; on the right for in-line switch-disconnectors with fuses SASILplus

<b>Application</b>	- Incoming feeder up to 630 A - Cable feeders up to 630 A	
<b>Degrees of protection</b>	- Up to IP41	Ventilated
<b>Cubicle dimensions</b>	- Cubicle height - Cubicle width (front connection in the cubicle)	2,000; 2,200 mm 1,000; 1,200 mm
<b>Device compartment</b>	- Height - Width	1,550; 1,750 mm 600 mm
<b>Form of internal separation</b>	- Form 3b, 4b	
<b>Design options</b>	- In-line switch-disconnectors with fuses 3NJ63 - In-line switch-disconnectors with fuses SASILplus (Jean Müller) - Empty space, device compartment	

Tab. 5/1: General cubicle characteristics for plug-in in-line design



## 5.1 In-Line Switch-Disconnectors with Fuses 3NJ63

In-line switch-disconnectors with fuses 3NJ63 (Fig. 5/2) have a double break feature as standard.

### Ratings of the vertical distribution busbar 3NJ63

The vertical distribution busbars with the line conductors L1, L2, L3 are arranged at the rear inside the cubicle. The PE, N or PEN busbars are arranged in the cable compartment. In the case of 4-pole feeders, the N conductor is allocated to the line conductors L1, L2, L3 at the rear inside the cubicle.

The vertical distribution busbar is covered test finger proofed (IP2X). The ratings are stated in Tab. 5/2.

### Ratings of 3NJ63 cable feeders

Apart from the space requirements for the additional built-in components (Tab. 5/3), the derating factor stated in Tab. 5/4 is to be used for determining the permissible operational current of a fuse-link. The space requirements for the cable feeders of the different in-line units depend on the rated device current (Tab. 5/5). The cable connection data can be found in Tab. 5/6.



Fig. 5/2: Plug-in in-line switch-disconnectors 3NJ63

Distribution busbar cross-section	60 x 10 mm <sup>2</sup>	80 x 10 mm <sup>2</sup>
Rated operational current at an ambient temperature of 35 °C	1,560 A	2,100 A
Rated short-time withstand current $I_{cw}$ (1 s) <sup>1)</sup>	50 kA	50 kA

<sup>1)</sup> Rated conditional short-circuit current  $I_{cc} = 120$  kA

Tab. 5/2: Ratings of the vertical distribution busbar 3NJ63

Built-in components	Height in mm	Design
Blanking cover for empty spaces	50 <sup>1)</sup>	Plastic
	100, 200, 300	Metal
Device compartment (mounting plate with compartment door)	200, 400, 600	Usable device mounting depth 180 mm

<sup>1)</sup> Accessory 3NJ6900-4CB00

Tab. 5/3: Additional built-in components for 3NJ63

Rated current of fuse-link	Derating factor $F$
$I_n < 630$ A	0.8
$I_n \geq 630$ A	0.715

Tab. 5/4: Derating factors for 3NJ63 fuse-links

Type	Rated device current	Space requirements of the in-line unit (height) <sup>1)</sup>		Size	Rated operational current <sup>1)</sup> at an ambient temperature of 35 °C
		3-pole	4-pole		
3NJ6303	160 A	50 mm	100 mm	00	125 A
3NJ6313	250 A	100 mm	150 mm	1	200 A
3NJ6323	400 A	200 mm	250 mm	2	320 A
3NJ6333	630 A	200 mm	250 mm	3	450 A

<sup>1)</sup> Rated operational current with fuse-link = rated device current  
The configuration rules stated in the following are to be observed

Tab. 5/5: Ratings of 3NJ63 cable feeders

		Conductor cross-sections for size			
		Size 00	Size 1	Size 2	Size 3
Cable lug connection	Al / Cu single- or multi-core (acc. to DIN 46235 for Cu, acc. to DIN 46239 for Al)	1 x 10 to 95 mm <sup>2</sup> or 2 x 16 to 70 mm <sup>2</sup>	1 x 25 to 240 mm <sup>2</sup> or 2 x 25 to 70 mm <sup>2</sup>	1 x 25 to 300 mm <sup>2</sup> or 2 x 25 to 240 mm <sup>2</sup>	1 x 25 to 300 mm <sup>2</sup> or 2 x 25 to 240 mm <sup>2</sup>
	Screw size	M8	M12	2 x M12	2 x M12
	Torque	15 Nm	30 Nm	30 Nm	30 Nm
Terminal connection	Al / Cu round, multi-core (rm)	1 x 10 to 50 mm <sup>2</sup>	1 x 16 to 185 mm <sup>2</sup>	1 x 16 to 185 mm <sup>2</sup>	1 x 16 to 185 mm <sup>2</sup>
	Al / Cu round, single-core (rs)	1 x 10 to 50 mm <sup>2</sup>	1 x 16 to 150 mm <sup>2</sup>	1 x 16 to 150 mm <sup>2</sup>	1 x 16 to 150 mm <sup>2</sup>
	Al / Cu sector-shaped, multi-core (sm)	1 x 16 to 95 mm <sup>2</sup>	1 x 35 to 240 mm <sup>2</sup>	1 x 35 to 240 mm <sup>2</sup>	1 x 35 to 240 mm <sup>2</sup>
	Al / Cu sector-shaped, single-core (ss)	1 x 16 to 95 mm <sup>2</sup>	1 x 35 to 300 mm <sup>2</sup>	1 x 35 to 300 mm <sup>2</sup>	1 x 35 to 300 mm <sup>2</sup>
	Torque	15 Nm	25 Nm	25 Nm	25 Nm

<sup>1)</sup> Below the lowermost in-line unit in the cubicle, only a blanking cover of 50 mm instead of 100 mm is required, or no blanking cover instead of a 50 mm blanking cover

Tab. 5/6: Maximum possible cable connections for in-line switch-disconnectors 3NJ63

## Configuration rules

For the completely equipped cubicle, the rated diversity factor (RDF) in accordance with IEC 61439-2 applies. Non-observance of these notes might result in premature aging of fuses and their uncontrolled tripping due to local overheating. The permissible operational current of all in-line units in the cubicle is limited by the rated operational current of the vertical distribution busbar.

All data refers to an ambient temperature of the switchgear of 35 °C in the 24-h mean. Conversion factors for different ambient temperatures are stated in Tab. 5/7.

Ratings and arrangement notes for the configuration of the in-line units and covers are given in Tab. 5/8. The in-line switch-disconnectors are arranged in the cubicle from size 3 to size 00 in decreasing order from bottom to top either in groups or individually. Blanking covers with ventilation slot are mounted in between for ventilation.

Ambient temperature of the switchboard	20 °C	25 °C	30 °C	35 °C	40 °C	45 °C	50 °C	55 °C
Conversion factor	1.10	1.07	1.04	1.00	0.95	0.90	0.85	0.80

Tab. 5/7: Conversion factors for other ambient temperatures

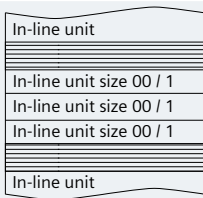
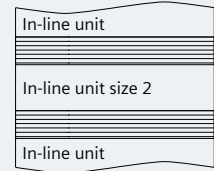
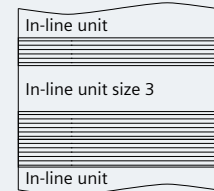
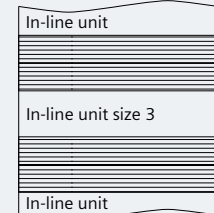
Size	Grouping	Blanking covers with ventilation slots	Example		
00 1	Total of the rated operational currents of the group ≤ 400 A	100 mm blanking cover below <sup>1)</sup> the group		Rated current of fuse: 80 A 125 A 250 A Total:	Rated operational current: 64 A 100 A 200 A 364 A
2	Not permissible	50 mm blanking cover below <sup>1)</sup> the in-line unit		Rated current of fuse: 400 A	Rated operational current: 320 A
3	Not permissible Rated operational current < 440 A	50 mm blanking cover above and 100 mm blanking cover below <sup>1)</sup> the in-line unit		Rated current of fuse: 500 A	Rated operational current: 400 A
	Not permissible Rated operational current from 440 A to 450 A	100 mm blanking cover each above and below <sup>1)</sup> the in-line unit		Rated current of fuse: 630 A	Rated operational current: 450 A

<sup>1)</sup> Below the lowermost in-line unit in the cubicle, only a blanking cover of 50 mm instead of 100 mm is required, or no blanking cover instead of a 50 mm blanking cover

Tab. 5/8: Configuration rules for 3NJ63: arrangement of in-line units in the cubicle

## 5.2 In-Line Switch-Disconnectors with Fuses SASILplus

Cubicles with plug-in in-line switch-disconnectors can also be equipped with in-line switch-disconnectors SASILplus (Fig. 5/3) (make Jean Müller). A difference is made between versions with a contact system plugged in on the incoming side as well as a contact system plugged in on the incoming and outgoing side.

### Ratings of the vertical distribution busbar SASILplus

The vertical distribution busbars with the line conductors L1, L2, L3 are arranged at the rear inside the cubicle. The PE, N or PEN busbars are arranged in the cable compartment. In the case of 4-pole feeders, the N conductor is allocated to the line conductors L1, L2, L3 at the rear inside the cubicle. The vertical distribution busbar is covered test finger proofed (IP2X). The ratings are stated in Tab. 5/9.

### Ratings of the SASILplus cable feeders

Apart from the space requirements for the additional built-in components (Tab. 5/10), the derating factor stated in Tab. 5/11 is to be used for determining the permissible operational current of a fuse-link. The space requirements for the cable feeders of the different in-line units depend on the rated operational current of the devices (Tab. 5/12).

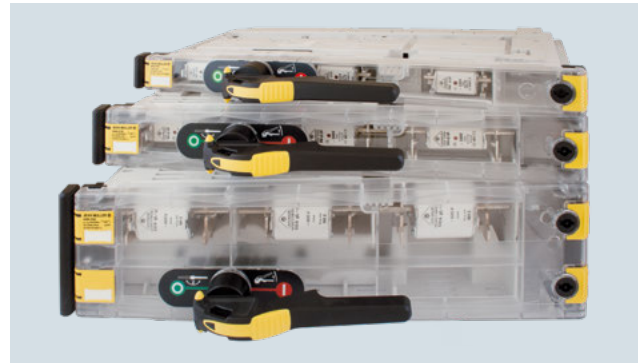

Fig. 5/3: Plug-in in-line switch-disconnectors SASILplus

Distribution busbar cross-section	60 x 10 mm <sup>2</sup>	80 x 10 mm <sup>2</sup>
Rated operational current at an ambient temperature of 35 °C	1,560 A	2,100 A
Rated short-time withstand current $I_{cw}$ (1 s) <sup>1)</sup>	50 kA	50 kA
<sup>1)</sup> Rated conditional short-circuit current $I_{cc} = 100$ kA		

Tab. 5/9: Ratings of the vertical distribution busbar SASILplus

Built-in components	Height in mm	Design
Blanking cover for empty spaces	50, 75, 150, 300	Metal
Device compartment (mounting plate with compartment door)	150, 200, 300, 450, 600	Without power pick-up, usable device mounting depth 180 mm
	200, 300, 450, 600	With power pick-up, usable device mounting depth 180 mm

Tab. 5/10: Additional built-in components for SASILplus

Rated current of fuse-link	Derating factor $F$
$I_n \leq 32$ A	1
$32$ A < $I_n \leq 160$ A	0.76
$160$ A < $I_n \leq 630$ A	0.81

Tab. 5/11: Derating factors for SASILplus fuse-links

Size	Rated device current	Space requirements of the in-line unit (height) <sup>1)</sup>		Rated operational current <sup>1)</sup> at an ambient temperature of 35 °C
		3-pole	4-pole	
00	160 A	50 mm	100 mm	122 A
1	250 A	75 mm	150 mm	203 A
2	400 A	150 mm	300 mm	324 A
3	630 A	150 mm	300 mm	510 A

<sup>1)</sup> Rated current with fuse-link = rated device current  
The configuration rules stated in the following are to be observed

Tab. 5/12: Ratings of the SASILplus cable feeders

## Configuration rules

For the completely equipped cubicle, the rated diversity factor (RDF) in accordance with IEC 61439-2 applies. Non-observance of these notes might result in premature aging of fuses and their uncontrolled tripping due to local overheating. The permissible operational current of all in-line units in the cubicle is limited by the rated current of the vertical distribution busbar.

Ratings and arrangement notes for the configuration of the in-line units and covers are given in Tab. 5/14. The in-line switch-disconnectors are arranged in the cubicle from size 3 to size 00 in decreasing order from bottom to top either in groups or individually. Blanking covers with ventilation slots are mounted in between for ventilation.

All data refers to an ambient temperature of the switchgear of 35 °C in the 24-h mean. Conversion factors for other ambient temperatures are stated in Tab. 5/13.

Ambient temperature of the switchboard	20 °C	25 °C	30 °C	35 °C	40 °C	45 °C	50 °C	55 °C
Conversion factor	1.10	1.07	1.04	1.00	0.96	0.93	0.89	0.85

Tab. 5/13: Conversion factors for other ambient temperatures

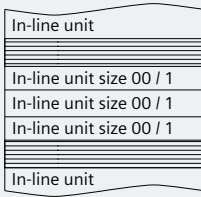
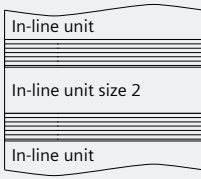
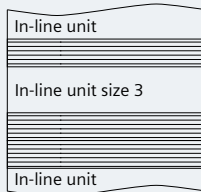
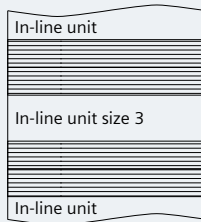
Size	Grouping	Blanking covers 75 mm with ventilation slots	Example		
00	Total of the rated operational currents of the group ≤ 319 A	One blanking cover each above and below <sup>1)</sup> the group		Rated current of fuse: 80 A 100 A 160 A Total:	Rated operational current: 60 A 76 A 122 A 256 A
1	Total of the rated operational currents of the group ≤ 365 A	One blanking cover each above and below <sup>1)</sup> the group		Rated current of fuse: 250 A 250 A Total:	Rated operational current: 182 A 182 A 364 A
2	Not permissible	One blanking cover each above and below <sup>1)</sup> the group		Rated current of fuse: 355 A	Rated operational current: 288 A
3	Not permissible	Two blanking covers each above and below <sup>1)</sup> the group		Rated current of fuse: 630 A	Rated operational current: 510 A

<sup>1)</sup> Below the lowermost in-line unit in the cubicle, only a blanking cover of 75 mm instead of 150 mm is required, or no blanking cover instead of a 75 mm blanking cover

Tab. 5/14: Configuration rules for SASILplus: arrangement of in-line units in the cubicle





# Chapter 6

## Fixed-Mounted Design

6.1	In-Line Design, Fixed-Mounted	60
6.2	Fixed-Mounted Design with Front Cover	63
6.3	Freely Configured Fixed-Mounted Design	67
6.4	Frequency Converter Design	69

# 6 Fixed-Mounted Design

If the replacement of components under operating conditions is not required, or if short downtimes are acceptable, then the fixed-mounted design offers a safe and cost-efficient solution.

## 6.1 In-Line Design, Fixed-Mounted

The cubicles for cable feeders in the fixed-mounted design up to 630 A are equipped with vertically installed 3NJ4 fuse-switch-disconnectors (Fig. 6/1). The cubicles are available with busbar position at the rear. Due to their compact and modular design, they allow optimal cost-efficient applications in the infrastructure. Design verified standard modules ensure maximum safety.

Depending on the cubicle width, several switch-disconnectors of size 00 to 3 can be installed. For the installation of additional auxiliary devices, DIN rails, wiring ducts, terminal blocks, etc., a device support plate can be provided in the cubicle. Alternatively, an ALPHA small distribution board can be installed. Measuring devices and control elements are installed in the door.



Fig. 6/1: Cubicles for fixed-mounted in-line design with 3NJ4 in-line switch-disconnectors



## General cubicle characteristics

Tab. 6/1 summarizes the general cubicle characteristics. The switch-disconnectors are fixed-mounted on the horizontal distribution busbar system. Cable connection is effected from the front, directly at the switching device. The maximum cross-sections that can be connected are stated in Tab. 6/2. The cables can be routed into the cubicle from the top or bottom.

The switch-disconnectors can be fitted with up to three current transformers to enable feeder-related measurements. In order to implement cubicle-related summation current measurements, the system provides the option to install current transformers in the distribution busbar system.

<b>Application</b>	- Incoming feeder up to 630 A - Cable feeders up to 630 A	
<b>Degrees of protection</b>	- Up to IP31 - Up to IP43 - IP54	Ventilated, door with cut-out Ventilated Non-ventilated
<b>Cubicle dimensions</b>	- Cubicle height - Cubicle width	2,000; 2,200 mm 600; 800; 1,000 mm
<b>Device compartment</b>	- For cubicle width 600 mm - For cubicle width 800 mm - For cubicle width 1,000 mm	Device compartment width 500 mm Device compartment width 700 mm Device compartment width 900 mm
<b>Form of internal separation</b>	- Form 1b, 2b	Door with cubicle height
<b>Design options</b>	- In-line fuse-switch-disconnectors 3NJ4 (3-pole) - With or without current measurement - Empty space cover	

Tab. 6/1: General cubicle characteristics for fixed-mounted in-line design

	Size 00	Size 1	Size 2	Size 3
<b>Connection screws</b>	M8	M10	M12	M12
<b>Cable lug, max. conductor cross-section (multi-core)</b>	95 mm <sup>2</sup>	240 mm <sup>2</sup>	240 mm <sup>2</sup>	240 mm <sup>2</sup>
<b>Torque</b>	12 to 15 Nm	30 to 35 Nm	35 to 40 Nm	35 to 40 Nm

Tab. 6/2: Maximum possible cable connections for 3NJ4 in-line switch-disconnectors

## Ratings for cable feeders

Tab. 6/3 states the space requirements and the respective rated current depending on the in-line unit type.

Type	Rated current	Space requirements of the in-line unit	Rated operational current <sup>1)</sup> at an ambient temperature of 35 °C	
			Non-ventilated	Ventilated
3NJ410	160 A	50 mm	117 A	136 A
3NJ412	250 A	100 mm	200 A	220 A
3NJ413	400 A	100 mm	290 A	340 A
3NJ414	630 A	100 mm	380 A	460 A

<sup>1)</sup> Rated operational current with fuse-link = rated device current

Tab. 6/3: Ratings of 3NJ4 cable feeders

## Additional built-in components

In cubicles with identical position for the busbar and the cable connection, one of three possible additional built-in components (see Tab. 6/4) can be used. The possible arrangements are listed in Tab. 6/5.

Device holder	Mounting depth	370 mm
	Mounting height	625 mm (cubicle height 2,000 mm) 725 mm (cubicle height 2,200 mm)
ALPHA 8GK rapid mounting kit for modular installation devices	Height	450 mm (3 rows)
2nd row, in-line unit size 00	Data stated in Tab. 6/6 or Tab. 6/7	

Tab. 6/4: Dimensions if additional built-in components are used

Busbar position	Cable connection	Additional built-in component installed in the cubicle
Bottom	Bottom	Top
Top	Top	Bottom
Bottom	Top	Not possible
Top	Bottom	Not possible

Tab. 6/5: Mounting location of additional built-in components

## Additional built-in components for in-line units of size 00 in second row

Mounting additional built-in components for 3NJ4 in-line units of size 00 is possible for cubicles up to degree of protection IP31 and operation of the main in-line switch-disconnectors through the door (door with cut-out).

The additional in-line switch-disconnectors are operated behind the door. This arrangement results in a smaller width of the device compartment (Tab. 6/6). The ratings of the cable feeders are stated in Tab. 6/7. The connection is established directly at the switching device from the top or from the bottom. Due to the restricted connection compartment, connection is possible with a cable cross-section up to 95 mm<sup>2</sup>.

Cubicle width	Width of device compartment
600 mm	300 mm
800 mm	500 mm
1,000 mm	700 mm

Tab. 6/6: Device compartment for in-line units in the second row

Type	Rated device current	Space requirement of in-line unit	Max. no. of in-line units per cubicle	Rated operational current <sup>1)</sup> for an ambient temperature up to 35 °C
<b>Installation at the top in the cubicle</b>				
3NJ410	160 A	50 mm	10	95 A
			14	74 A
<b>Installation at the bottom in the cubicle</b>				
3NJ410	160 A	50 mm	10	107 A
			14	92 A

<sup>1)</sup> Rated operational current with fuse-link = rated device current

Tab. 6/7: Ratings of the cable feeders for in-line units in the second row

## Equipment rules for 3NJ4 in-line fuse-switch-disconnectors

Arrangement options for the in-line units in the cubicle:

- Sizes of in-line units decreasing from left to right
- Sizes of in-line units decreasing from right to left

The specified rated operational currents are applicable when the 3NJ4 in-line units are equipped with the largest possible fuse-links. When using smaller fuses, a corresponding utilization (in percent) is permissible.

Example:

- 3NJ414 in-line unit in a non-ventilated cubicle (Tab. 6/3: 380 A)
- Equipped with 500 A fuse

Max. permissible continuous operational current =  
(380 A / 630 A) · 500 A = 300 A

## 6.2 Fixed Mounted Design with Front Covers

The front covers, which are easy to install, allow for the implementation of cubicles with uniform front level (Fig. 6/2). Optionally, a cubicle door or a glass door can be used. Implementing the distribution busbars as profile bars or flat copper allows for tap-offs in the smallest of grids. Connections to the distribution busbars by means of cables, wires or busbars are also possible without any need for drilling or punching. This ensures maximum flexibility also for later extensions.

### General cubicle characteristics

Tab. 6/8 summarizes the general cubicle characteristics. The switching devices are installed on modular device holders of graduated depth. These can be equipped with circuit-breakers, switch-disconnectors with fuses, or modular installation devices. Different switching device groupings into one module are also possible. They are attached to the device holder and directly connected to the distribution busbar.

To the front, the devices are equipped with front covers. Operation is effected through the cover.

Cable connection is made directly at the device or, in cases of higher requirements, at special connection terminals. Thanks to the cover, simple operation is possible directly at the device in the cable compartment. For individual equipping, the system offers device holders for free arrangement of components.



Fig. 6/2: Cubicles for fixed-mounted design with front door

<b>Application</b>	<ul style="list-style-type: none"> <li>- Incoming feeder up to 630 A</li> <li>- Cable feeders up to 630 A</li> <li>- Modular installation devices</li> </ul>	
<b>Degrees of protection</b>	<ul style="list-style-type: none"> <li>- Up to IP43</li> <li>- IP54</li> </ul>	<ul style="list-style-type: none"> <li>Ventilated</li> <li>Non-ventilated</li> </ul>
<b>Cubicle dimensions</b>	<ul style="list-style-type: none"> <li>- Cubicle height</li> <li>- Cubicle width (front connection in the cubicle)</li> </ul>	<ul style="list-style-type: none"> <li>2,000; 2,200 mm</li> <li>1,000; 1,200 mm</li> </ul>
<b>Device compartment</b>	<ul style="list-style-type: none"> <li>- Height</li> <li>- Width</li> </ul>	<ul style="list-style-type: none"> <li>1,600; 1,800 mm</li> <li>600 mm</li> </ul>
<b>Form of internal separation</b>	<ul style="list-style-type: none"> <li>- Form 1, 2b, 4a, 4b</li> </ul>	<ul style="list-style-type: none"> <li>Door, glass door with cubicle height <sup>1)</sup></li> </ul>
<b>Design options</b>	<ul style="list-style-type: none"> <li>- Fixed-mounted module with front cover</li> <li>- Assembly kit for modular installation devices</li> <li>- Empty compartment, device compartment</li> </ul>	

<sup>1)</sup> Cubicle with degree of protection less than or equal to IP31 is also possible without a door

Tab. 6/8: General cubicle characteristics for fixed-mounted cubicles with front door

## Vertical distribution busbar

The vertical distribution busbars with the line conductors L1, L2, L3 are arranged on the left inside the cubicle. The PE, N or PEN busbars are arranged in the cable compartment.

In the case of 4-pole feeders, the N conductor is allocated to the line conductors L1, L2, L3 at the rear inside the cubicle. Ratings are stated in Tab. 6/9.

Distribution busbar		Profile bar			Flat copper <sup>1)</sup>	
Cross-section		400 mm <sup>2</sup>	650 mm <sup>2</sup>	1,400 mm <sup>2</sup> <sup>1)</sup>	1 x (40 mm x 10 mm)	2 x (40 mm x 10 mm)
Rated operational current at an ambient temperature of 35 °C	Ventilated	905 A	1,100 A	1,720 A	865 A	1,120 A
	Non-ventilated	830 A	1,000 A	1,400 A	820 A	1,000 A
Rated short-time withstand current $I_{cw}$ (1 s) <sup>2)</sup>		65 kA	65 kA	100 kA	65 kA	65 kA

<sup>1)</sup> Main busbar position: only at the top  
<sup>2)</sup> Rated conditional short-circuit current  $I_{cc} = 150$  kA

Tab. 6/9: Ratings of the vertical distribution busbar

## Mounting

One or several switching device(s) is/are mounted on device holders of graduated depth and connected with the incoming side to the vertical distribution busbars

(Fig. 6/3). To the front, the devices are equipped with front covers. Operation is effected through the cover.

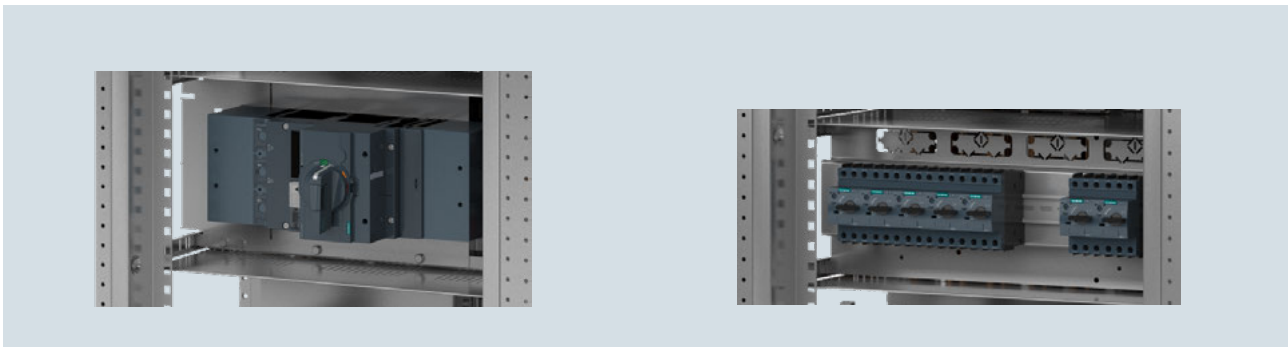

Fig. 6/3: Installation of switching devices in fixed-mounted cubicles with front cover (cover open)

## Cable connection

For form 1, 2b and 4a, the cable connection is effected directly at the switching device. The maximum cross-sections that can be connected are stated in the device catalogs.

For form 4b, the cable connection is effected in the cable compartment. Tab. 6/10 states the maximum conductor cross-sections and Fig. 6/4 shows a detail with connections.

Rated feeder current	Max. conductor cross-section
≤ 250 A	120 mm <sup>2</sup>
> 250 A	240 mm <sup>2</sup>

Tab. 6/10: Conductor cross-sections in fixed-mounted cubicles with front door

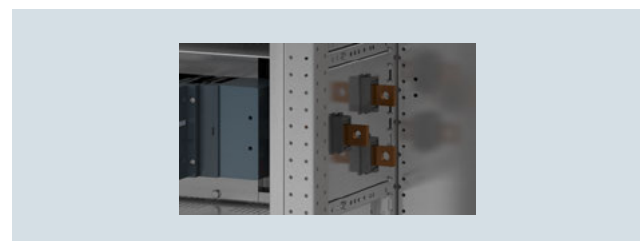

Fig. 6/4: Cable connections in fixed-mounted cubicles with front door

## Ratings of cable feeders

Tab. 6/11 and Tab. 6/12 state the installation data of the switching devices if used in fixed-mounted cubicles with a front door. The thermal interaction of the outgoing feeders in the cubicle has to be considered by specifying the rated diversity factor (RDF).

Permissible continuous operational current  $I_{ng}$ :

$$I_{ng} \text{ (cable feeder)} = \text{rated operational current } I_e \cdot \text{RDF}$$

For the outgoing feeders in the cubicle, the rated diversity factor  $\text{RDF} = 0.8$  can be applied:

- Regardless of the number of outgoing feeders in the cubicle
- Regardless of the mounting position in the cubicle.

For cubicles with a very high packing and/or power density, a project-specific assessment is recommended. Further information can be obtained from your contact partner at Siemens.

Type	Rated device current	Quantity per row	Module height		Rated operational current $I_e$ at an ambient temperature of 35 °C	
			3-pole / 4-pole	3-pole	4-pole	Non-ventilated
<b>Fuse-switch-disconnector <sup>1)</sup></b>						
3NP1123	160 A	1	150 mm	-	106 A	120 A
3NP1123	160 A	4	300 mm	-	106 A	120 A
3NP1133	160 A	1	200 mm	-	123 A	133 A
3NP1133	160 A	3	300 mm	-	123 A	133 A
3NP1143	250 A	1	250 mm	-	222 A	241 A
3NP1153	400 A	1	300 mm	-	350 A	375 A
3NP1163	630 A	1	300 mm	-	480 A	530 A
3NP4010	160 A	1	150 mm	-	84 A	96 A
3NP4010	160 A	4	300 mm	-	84 A	96 A
3NP4070	160 A	1	200 mm	-	130 A	142 A
3NP4070	160 A	3	300 mm	-	130 A	142 A
3NP4270	250 A	1	250 mm	-	248 A	250 A
3NP4370	400 A	1	300 mm	-	355 A	370 A
3NP4470	630 A	1	300 mm	-	480 A	515 A
3NP5060	160 A	1	200 mm	-	84 A	96 A
3NP5060	160 A	3	350 mm	-	84 A	96 A
3NP5260	250 A	1	250 mm	-	248 A	250 A
3NP5360	400 A	1	300 mm	-	355 A	370 A
3NP5460	630 A	1	300 mm	-	480 A	515 A
<b>Switch-disconnector with fuses <sup>1)</sup></b>						
3KF1	63 A	1	250 mm	250 mm	63 A	63 A
3KF2	160 A	1	250 mm	250 mm	144 A	152 A
3KF3	250 A	1	350 mm	350 mm	206 A	237 A
3KF4	400 A	1	350 mm	350 mm	315 A	365 A
3KF5	630 A	1	550 mm	550 mm	495 A	580 A
<b>Circuit-breaker</b>						
3RV2.1	16 A	1	100 mm	-	12.7 A	14.1 A
3RV2.1	16 A	9	200 mm	-	12.7 A	14.1 A
3RV2.2	40 A	1	100 mm	-	27 A	31.5 A
3RV2.2	40 A	9	200 mm	-	27 A	31.5 A
3RV2.3	50 A	1	150 mm	-	71 A	78 A
3RV2.3	50 A	7	250 mm	-	59 A	61 A
3RV2.4	100 A	1	150 mm	-	79 A	90 A
3RV2.4	100 A	6	300 mm	-	66 A	76 A

<sup>1)</sup> Rated operational current with fuse-link = rated device current

Tab. 6/11: Ratings of cable feeders for 3NP, 3KF and 3RV

Type	Rated device current	Quantity per row		Module height		Rated operational current $I_e$ at an ambient temperature of 35 °C	
		3-pole	4-pole	3-pole	4-pole	Non-ventilated	Ventilated
molded-case-circuit-breaker <sup>1)</sup>							
3VA10	100 A	1	1	150 mm	150 mm	72 A	85 A
3VA10	100 A	5	4	400 mm	400 mm	72 A	85 A
3VA11	160 A	1	1	150 mm	150 mm	112 A	125 A
3VA11	160 A	5	4	400 mm	400 mm	112 A	125 A
3VA11 <sup>1)</sup>	160 A	5	4	500 mm	500 mm	112 A	125 A
3VA12	250 A	1	1	200 mm	250 mm	232 A	246 A
3VA13	400 A	1	1	250 mm	300 mm	355 A	400 A
3VA14	630 A	1	1	250 mm	300 mm	410 A	460 A
3VA20	100 A	1	1	150 mm	200 mm	100 A	100 A
3VA20 <sup>2)</sup>	100 A	4	3	350 (450) mm	350 (450) mm	83 A	100 A
3VA20 <sup>3)</sup>	100 A	4	3	400 mm	400 mm	83 A	100 A
3VA20 <sup>4)</sup>	100 A	4	3	500 (600) mm	500 (600) mm	83 A	100 A
3VA21	160 A	1	1	150 mm	200 mm	160 A	160 A
3VA21 <sup>2)</sup>	160 A	4	3	350 (450) mm	350 (450) mm	90 A	125 A
3VA21 <sup>3)</sup>	160 A	4	3	400 mm	400 mm	90 A	125 A
3VA21 <sup>4)</sup>	160 A	4	3	500 (600) mm	500 (600) mm	90 A	125 A
3VA22	250 A	1	1	200 mm	250 mm	201 A	226 A
3VA23	400 A	1	1	250 mm	300 mm	350 A	400 A
3VA24	630 A	1	1	250 mm	300 mm	410 A	495 A

<sup>1)</sup> 3VA with RCD  
<sup>2)</sup> 3VA fixed-mounted  
<sup>3)</sup> 3VA with plug-in base  
<sup>4)</sup> 3VA fixed-mounted with RCD  
 ( ) Module height for nominal voltage higher than 525 V

Tab. 6/12: Ratings of cable feeders for 3VA

## Device compartments

The device compartment consists of a fixed device holder with a uniform usable overall depth of 310 mm. The device compartment is closed with a front cover. The five typical module heights are: 200, 300, 400, 500, and 600 mm.

## Assembly kits for modular installation devices

Thanks to the different assembly kits, one or more row(s) of modular installation devices can be installed in the switchboard. Tab. 6/12 states the configurations depending on the module height. The assembly kit (Fig. 6/5) comprises the 35 mm multi-profile bar(s) for mounting modular installation devices of size 1, 2 or 3 according to DIN 43880, and a front cover. The multi-profile bar allows the SIKclip 5ST25 wiring system to be snapped on at the rear.

Installation width	Number of rows	Row distance	Module height
24 MW <sup>1)</sup>	1	150 mm	150 mm
		200 mm	200 mm
	2	150 mm	300 mm
		200 mm	400 mm
	3	150 mm	450 mm
		200 mm	600 mm

<sup>1)</sup> MW = modular width = 18 mm

Tab. 6/13: Configuration data of the assembly kits for modular installation devices

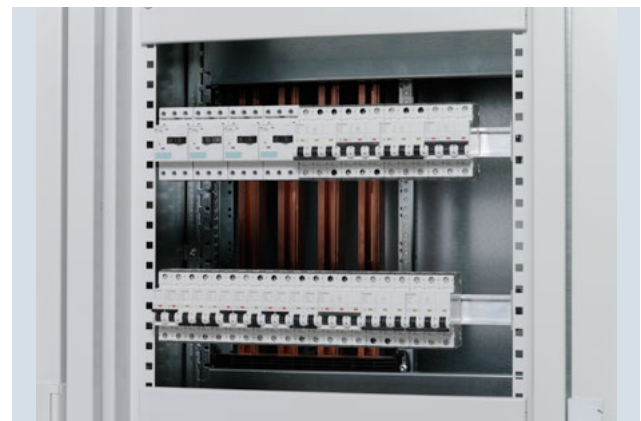

Fig. 6/5: Assembly kit for modular installation devices (without cover)

## 6.3 Freely Configured Fixed-Mounted Design

For individual configuration and flexible extension of cubicles, additional cubicles for freely configured fixed-mounted designs are available for SIVACON S8 switch-

boards (Fig. 6/6). Their general characteristics are stated in Tab. 6/14 and the configuration data are described in Tab. 6/15.



Fig. 6/6: Cubicles for freely configured fixed-mounted design

<b>Application</b>	- Fixed-mounted cubicle with mounting plate for free configuration - Use as a cubicle extension <sup>1)</sup>	
<b>Degrees of protection</b>	- Up to IP43 - IP54	Ventilated Non-ventilated
<b>Cubicle dimensions</b>	- Cubicle height - Cubicle width	2,000; 2,200 mm see Tab. 6/15 (cubicle design)
<b>Device compartment</b>	- Height - Width	1,600; 1,800 mm see Tab. 6/15 (cubicle design)
<b>Form of internal separation</b>	- Form 1, 2b	Door, glass door with cubicle height
<b>Design options</b>	- Mounting plate - ALPHA 8GK rapid mounting kits <sup>2)</sup> - With / without main busbar - With / without vertical distribution busbar	

<sup>1)</sup> Extension of cubicles to the left or to the right

<sup>2)</sup> Cubicle height 2,000 mm; main busbar position at the rear

Tab. 6/14: General cubicle characteristics for freely configured fixed-mounted design

## Cubicle design

Separate cable compartment on the right	Cubicle width	Width of device compartment	Vertical distribution busbar
Yes	1,000 mm <sup>1)</sup> (600 mm + 400 mm); 1,200 mm <sup>1)</sup> (600 mm + 600 mm)	600 mm	Yes / No
No	200 <sup>2)</sup> ; 350 <sup>3)</sup> ; 400; 600; 800; 850 <sup>3)</sup> ; 1,000 mm	According to the cubicle width	No
	600 mm <sup>4)</sup>	600 mm	Yes / No

<sup>1)</sup> Front connection in the cubicle  
<sup>2)</sup> Width 200 mm as cubicle extension  
<sup>3)</sup> Cubicle height 2,000 mm; single-front switchboards  
<sup>4)</sup> Rear connection in the cubicle

Tab. 6/15: Configuration data on cubicle design for freely configured fixed-mounted design

## Vertical distribution busbar

The vertical distribution busbars with the line conductors L1, L2, L3 are arranged on the left inside the cubicle. The PE, N or PEN busbars are arranged in the cable compartment.

In the case of four-pole feeders, the N conductor is allocated to the line conductors L1, L2, L3 at the rear inside the cubicle. Ratings are stated in Tab. 6/16.

Distribution busbar		Profile bar			Flat copper <sup>1)</sup>	
Cross-section		400 mm <sup>2</sup>	650 mm <sup>2</sup>	1,400 mm <sup>2</sup> <sup>1)</sup>	1 x (40 mm x 10 mm)	2 x (40 mm x 10 mm)
Rated operational current at an ambient temperature of 35 °C	Ventilated	905 A	1,100 A	1,720 A	865 A	1,120 A
	Non-ventilated	830 A	1,000 A	1,400 A	820 A	1,000 A
Rated short-time withstand current $I_{cw}$ (1 s) <sup>2)</sup>		65 kA	65 kA	100 kA	65 kA	65 kA

<sup>1)</sup> Main busbar position: only at the top  
<sup>2)</sup> Rated conditional short-circuit current  $I_{cc} = 150$  kA

Tab. 6/16: Ratings of the vertical distribution busbar

## Mounting options

The dimensions and arrangement options for mounting plates and ALPHA 8GK rapid mounting kits are stated in Tab. 6/17.

More detailed information on the ALPHA 8GK rapid mounting kits is available in the relevant product catalog.

Mounting plates			
Cubicle height	Main busbar	Overall height of mounting plate	Design
2,000 mm	No	1,600 mm	- Divided / non-divided - Perforated / non-perforated
	Yes	1,800 mm	
2,200 mm	No	2,000 mm	
	Yes	1,800 mm	
ALPHA 8GK rapid mounting kits			
Cubicle height	Main busbar	Installation compartment	
		Height	Width
2,000 mm	Without	1,800 mm	350 <sup>1)</sup> , 600, 800 mm
	Position at the rear	1,650 mm	

<sup>1)</sup> No glass door

Tab. 6/17: Configuration data on mounting options for freely configured fixed-mounted design



## 6.4 Frequency Converter Design

The frequency converter cubicle for the fixed mounting of modules with SIMAMICS frequency converters of the G120 series can either be integrated in the SIVACON S8, or be supplied via the common busbar, or be optionally delivered as an autonomous cubicle (Fig. 6/7). Important technical features are given in Tab. 6/15.

### Device compartment

The feeders are lined up in the cubicle, starting from the left (preferably with the largest modules). Remaining empty spaces are closed with the corresponding covers. Alternatively, it is also possible to install device plates for free arrangement of components. The modules are supplied directly from the main busbar through a cable or busbar connection, an external infeed is also optionally possible.

<b>Switchboard design</b>		- Single front - Double front
<b>Main busbar position</b>		- Top, - Rear-top - Rear-bottom
<b>Degree of protection</b>		- IP30, 31 - IP40, 41, 43 - IP54 <sup>1)</sup>
<b>Connection position in the cubicle</b>		- Front - Rear
<b>Cable entry</b>		- Bottom - Top <sup>2)</sup>
<b>Form of internal separation</b>		- Form 2b
<b>Rated power of the modules</b>		- From 0.55 kW to 132 kW
<b>Cubicle dimensions</b>	<b>Width</b>	- 400; 600; 800; 1,000 mm
	<b>Height</b>	- 2,000; 2,200 mm
<b>Device compartment</b>	<b>Equippable width</b>	- Cubicle width - 100 mm
	<b>Height</b>	- 1,600 mm
<b>Module height</b>		- 1,600 mm
<b>Module width</b>	<b>FSA</b>	- 100 mm <sup>3)</sup>
	<b>FSB</b>	- 125 mm <sup>3)</sup>
	<b>FSC</b>	- 150 mm <sup>3)</sup>
	<b>FSD</b>	- 225 mm
	<b>FSE</b>	- 300 mm
	<b>FSF</b>	- 325 mm

<sup>1)</sup> Degree of protection IP54 is only possible with forced ventilation  
<sup>2)</sup> With busbar position at the rear, connection from the top is only possible in the 1,000 mm wide cubicle; the equippable width is then 750 mm  
<sup>3)</sup> For the sizes FSA - FSC, there is still a version available with a width of 200 mm, with an extended auxiliary device holder

Tab. 6/18: Technical features of the cubicles with frequency converter design

### Cable connection

For the size FSA – FSC, the cables are connected to the module via the outgoing terminals provided for this purpose, and for the size FSD – FSF, directly at the power module. The maximum cross-sections that can be connected are stated in Tab. 6/16.

<b>Size</b>	FSA	FSB	FSC
<b>Cross-section</b>	4 mm <sup>2</sup>	10 mm <sup>2</sup>	16 mm <sup>2</sup>
<b>Size</b>	FSD	FSE	FSF
<b>Cross-section</b>	35 mm <sup>2</sup>	70 mm <sup>2</sup>	2 x 120 mm <sup>2</sup>

Tab. 6/19: Conductor cross-sections of the modules



Fig. 6/7: Cubicle with frequency converter design

## Feeders with frequency converters

The feeders are available in fused or non-fused design. Only frequency converters in standard design (SINAMICS G120 PM240-2) are used.

Possible device combinations in the frequency converter cubicle are listed in Tab. 6/17.

Operational voltage	Rated power		Size of power module	Circuit-breaker		Additional components					
	Low overload <sup>1)</sup>	High overload <sup>1)</sup>		Fused	Non-fused	Main contactor	Line reactor	Output reactor			
3AC 380 - 480 V	0.55 kW	0.37 kW	FSA	3NP1	3RV2	Optional	Optional	Optional <sup>2)</sup>			
	0.75 kW	0.55 kW									
	1.1 kW	0.75 kW									
	1.5 kW	1.1 kW									
	2.2 kW	1.5 kW									
	3 kW	2.2 kW									
	4 kW	3 kW	FSB								
	5.5 kW	4 kW									
	7.5 kW	5.5 kW									
	11 kW	7.5 kW	FSC								
	15 kW	11 kW									
	18.5 kW	15 kW	FSD								
	22 kW	18.5 kW									
	30 kW	22 kW									
	37 kW	30 kW									
	45 kW	37 kW	FSE				3VA11	Optional	Integrated	Not available <sup>3)</sup>	
55 kW	45 kW										
75 kW	55 kW										
90 kW	75 kW	FSF	3VA12								
110 kW	90 kW										
132 kW	110 kW										
				3VA23							
3AC 500 - 690 V	11 kW	7.5 kW	FSD	3NP1	3RV2	Optional	Integrated				Not available <sup>3)</sup>
	15 kW	11 kW									
	18.5 kW	15 kW									
	22 kW	18.5 kW									
	30 kW	22 kW									
	37 kW	30 kW									
	45 kW	37 kW	FSE				3VA10				
	55 kW	45 kW									
	75 kW	55 kW									
	90 kW	75 kW	FSF				3VA11				
	110 kW	90 kW									
	132 kW	110 kW									
			3VA12								

<sup>1)</sup> Low overload: Low dynamics (continuous duty); quadratic torque characteristic; low breakaway torque; low speed  
 Examples: centrifugal pumps, radial/axial fans, rotary blowers, radial compressors, vacuum pumps, chain conveyors, agitators  
 High overload: higher dynamics (cyclic operation); constant torque characteristic; high breakaway torque  
 Examples: gear pumps, eccentric screw pumps, mills, mixers, breakers, lifters/sinkers, centrifuges.

<sup>2)</sup> Further information can be found in the catalog D31.1 (E86060-K5531-A111-A1)

<sup>3)</sup> Please ask your contact partner at Siemens

Tab. 6/20: Categorization of assembly kits for modular installation devices

## Derating

Depending on the ambient temperature and the site altitude, a possible derating must be considered (Fig. 6/8). The ambient temperature refers to the frequency converter and corresponds to the inside

temperature of the cubicle. Accordingly, the resulting threshold value must be adjusted at the thermostat in case of forced ventilation (fan).

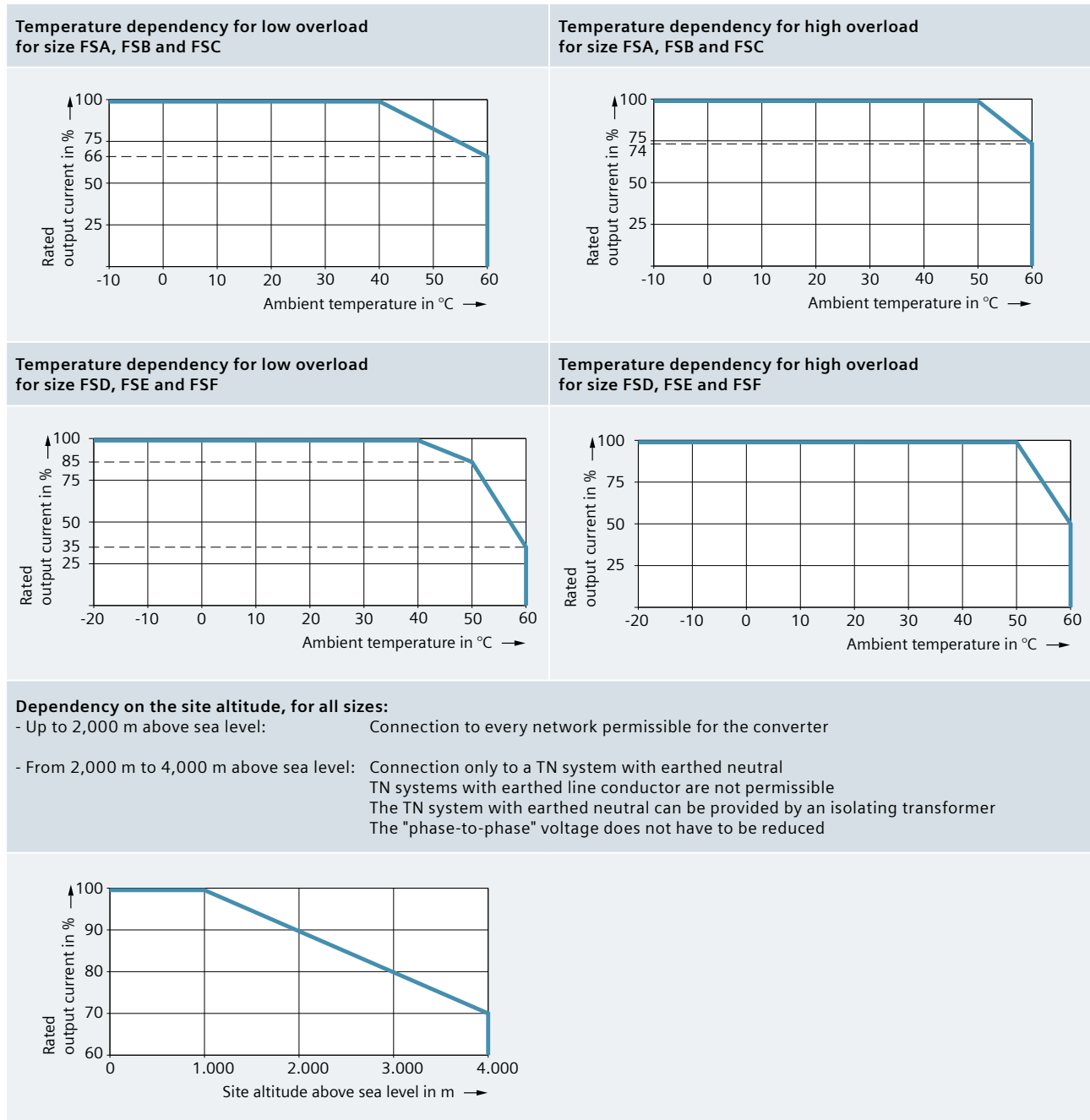

Fig. 6/8: Permissible output current for cubicles with frequency converter design





# Chapter 7

## Reactive Power Compensation

7.1	Configuration and Calculation	76
7.2	Separately Installed Compensation Cubicles	78

# 7 Reactive Power Compensation

The cubicles for reactive power compensation (Fig. 7/1) relieve transformers and cables, reduce transmission losses, and thus save energy. Depending on the consumer structure, the reactive power compensation is

equipped with choked or unchoked capacitor assemblies. The controller module for electronic reactive power compensation can be installed in the door. Tab. 7/1 summarizes the general cubicle characteristics.



Fig. 7/1: Cubicle for reactive power compensation

<b>Application</b>	- Controlled reactive power compensation	
<b>Degrees of protection</b>	- Up to IP43	Ventilated
<b>Cubicle dimensions</b>	- Cubicle height - Cubicle width	2,000; 2,200 mm 800 mm
<b>Device compartment</b>	- Height - Width	1,600; 1,800 mm 600 mm
<b>Form of internal separation</b>	- Form 1, 2b	Door with cubicle height
<b>Design options</b>	<ul style="list-style-type: none"> <li>- Unchoked</li> <li>- Choked: 5.67 %, 7 %, 14 %</li> <li>- With / without main busbar</li> <li>- With connection to main busbar or with external connection</li> <li>- With / without upstream switch-disconnector assembly as sectionalizing point between main busbars and vertical distribution busbar</li> </ul>	

Tab. 7/1: General cubicles characteristics for reactive power compensation

## Compensation assemblies

Depending on the consumer type, unchoked and choked capacitor assemblies are used for reactive power compensation. An assembly with fuse-switch-disconnectors can optionally be installed to disconnect the capacitor assemblies (Fig. 7/2) from the main busbar.

- **Unchoked capacitor assemblies**  
Unchoked assemblies are mainly used for central compensation of reactive power in networks with mainly linear consumers. They are divided into several, separately switchable capacitor stages. The reactive power controller installed in the door enables adhering to the specified set  $\cos \varphi$  even under varying load conditions by connecting or disconnecting the stages.
- **Choked capacitor assemblies**  
Choked assemblies have an additional inductance. They are used for compensating reactive power in networks with non-linear consumers (15 - 20 % of the total load) and a high harmonic component. In addition to capacitive reactive power, choked modules also provide filtering of low-frequency harmonics.

## Audio frequency ripple control systems and compensation

Ripple control signals can be used in the power supply network to control power consumers from remote. The signals for audio frequency ripple control systems (AF) are in the range of 110 and 2,000 Hz. The dependency of the choking level from the audio frequency suppressor is listed in Tab. 7/2.

Using an audio frequency suppressor is required to prevent suppressing ripple control signals from the network by the compensation system. The audio frequency suppressor depends on the frequency of the ripple control signal of the respective system operator and must be adjusted if required. Special versions are available on request.

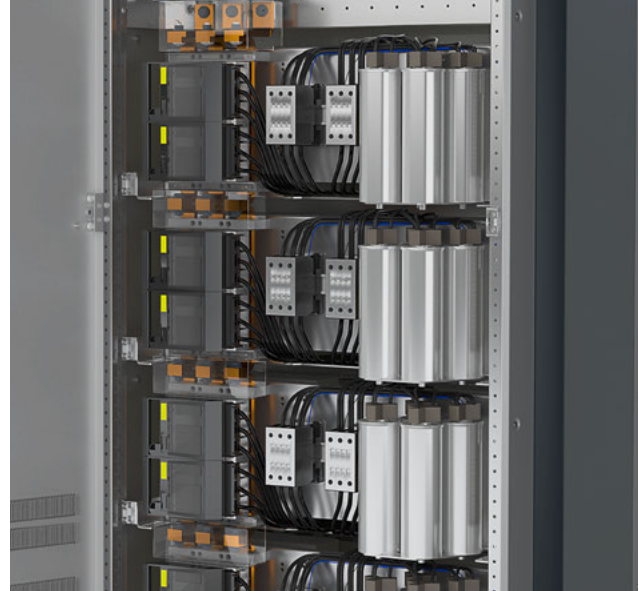

Fig. 7/2: Capacitor assemblies of the reactive power compensation

Degree of choking	Audio frequency suppressor
5.67 %	> 350 Hz
7 %	> 250 Hz
14 %	> 160 Hz

Tab. 7/2: Choked capacitor assemblies with built-in audio frequency suppressor

## 7.1 Configuration and Calculation

When cubicles with direct connection to the main busbar are configured, the selection of the capacitor assemblies depends on the total power in the cubicle and the number of stages, as it becomes apparent in Tab. 7/3.

The maximum power per cubicle is 500 kvar / 400 V, 525 V, 690 V at an ambient temperature of 35 °C. The compensation assemblies can only be used for 50 Hz. Assemblies for 60 Hz are available on request.

Cubicle height	Compensation power per cubicle	Number of stages	Design			
			Unchoked		Choked: 5.67 %, 7 %, 14 % <sup>1)</sup>	
			Without switch-disconnector	With switch-disconnector	Without switch-disconnector	With switch-disconnector
2,000 mm; 2,200 mm	50 kvar	4 x 12.5 kvar	+	+	-	-
	50 kvar	2 x 25 kvar	+	+	+	+
	100 kvar	4 x 25 kvar	+	+	+	+
	100 kvar	2 x 50 kvar	+	+	+	+
	150 kvar	12 x 12.5 kvar	+	+	-	-
	150 kvar	6 x 25 kvar	+	+	+	+
	200 kvar	8 x 25 kvar	+	+	+	+
	200 kvar	4 x 50 kvar	+	+	+	+
	250 kvar	20 x 12.5 kvar	+	+	-	-
	250 kvar	10 x 25 kvar	+	+	+	+
	300 kvar	12 x 25 kvar	+	+	+	-
	300 kvar	6 x 50 kvar	+	+	+	+
	350 kvar	28 x 12.5 kvar	+	+ <sup>2)</sup>	-	-
	350 kvar	14 x 25 kvar	+	+ <sup>2)</sup>	+	+ <sup>2)</sup>
	400 kvar	16 x 25 kvar	+	+ <sup>2)</sup>	+	-
	400 kvar	8 x 50 kvar	+	+ <sup>2)</sup>	+	+ <sup>2)</sup>
2,200 mm	450 kvar	36 x 12.5 kvar	+	-	-	-
	450 kvar	18 x 25 kvar	+	-	+	-
	500 kvar	20 x 25 kvar	+	-	-	-
	500 kvar	10 x 50 kvar	+	-	+	-

<sup>1)</sup> 14 % choked only possible for 400 V  
<sup>2)</sup> Only possible with a cubicle height of 2,200 mm  
Legend: + possible - not possible

Tab. 7/3: Configuration of the capacitor assemblies

When calculating the required compensation power, you can proceed as follows:

1. The electricity bill of the power supplier shows the consumption of active energy in kWh and reactive energy in kvarh. The distribution system operator (DSO) usually requires a  $\cos \varphi$  between 0.90 and 0.95.

To avoid costs, the value should be compensated to a  $\cos \varphi$  near 1.

With:  $\tan \varphi = \text{reactive energy} / \text{active energy}$

2. From Tab. 7/4 the conversion factor  $F$  must be determined by compensation in dependency of the original value for  $\tan \varphi_1$  (row) and the desired  $\cos \varphi_2$  (column).

3. The compensation power required is the product of the conversion factor  $F$  and the mean active power consumption  $P_m$

$$\text{Compensation power } P_{\text{comp}} = F \cdot P_m$$

### Example:

$$\begin{aligned} \text{Reactive energy } W_b &= 61,600 \text{ kvarh per month} \\ \text{Active energy } W_w &= 54,000 \text{ kWh per month} \\ \tan \varphi_1 &= W_b / W_w = 1.14 \quad (\cos \varphi_1 = 0.66) \end{aligned}$$

$$\begin{aligned} \text{Mean power consumption } P_m & \\ P_m &= \text{active energy} / \text{working time} \\ &= 54,000 \text{ kWh} / 720 \text{ h} = 75 \text{ kW} \end{aligned}$$

$$\text{Desired power factor } \cos \varphi_2 = 0.95$$

$$\begin{aligned} \text{Conversion factor } F \text{ (} \tan \varphi_1 = 1.14; \cos \varphi_2 = 0.95 \text{)} \\ F &= 0.81 \end{aligned}$$

$$\begin{aligned} \text{Compensation power } P_{\text{comp}} &= F \cdot P_m = 0.81 \cdot 75 \text{ kW} \\ P_{\text{comp}} &= 60 \text{ kvar} \end{aligned}$$



Actual value given		Conversion factor											
$\tan \varphi_1$	$\cos \varphi_1$	$\cos \varphi_2 = 0.70$	$\cos \varphi_2 = 0.75$	$\cos \varphi_2 = 0.80$	$\cos \varphi_2 = 0.82$	$\cos \varphi_2 = 0.85$	$\cos \varphi_2 = 0.87$	$\cos \varphi_2 = 0.90$	$\cos \varphi_2 = 0.92$	$\cos \varphi_2 = 0.95$	$\cos \varphi_2 = 0.97$	$\cos \varphi_2 = 1.00$	
4.9	0.20	3.88	4.02	4.15	4.20	4.28	4.33	4.41	4.47	4.57	4.65	4.90	
3.87	0.25	2.85	2.99	3.12	3.17	3.25	3.31	3.39	3.45	3.54	3.62	3.87	
3.18	0.30	2.16	2.30	2.43	2.48	2.56	2.61	2.70	2.75	2.85	2.93	3.18	
2.68	0.35	1.66	1.79	1.93	1.98	2.06	2.11	2.19	2.25	2.35	2.43	2.68	
2.29	0.40	1.27	1.41	1.54	1.59	1.67	1.72	1.81	1.87	1.96	2.04	2.29	
2.16	0.42	1.14	1.28	1.41	1.46	1.54	1.59	1.68	1.74	1.83	1.91	2.16	
2.04	0.44	1.02	1.16	1.29	1.34	1.42	1.47	1.56	1.62	1.71	1.79	2.04	
1.93	0.46	0.91	1.05	1.18	1.23	1.31	1.36	1.45	1.50	1.60	1.68	1.93	
1.83	0.48	0.81	0.95	1.08	1.13	1.21	1.26	1.34	1.40	1.50	1.58	1.83	
1.73	0.50	0.71	0.85	0.98	1.03	1.11	1.17	1.25	1.31	1.40	1.48	1.73	
1.64	0.52	0.62	0.76	0.89	0.94	1.02	1.08	1.16	1.22	1.31	1.39	1.64	
1.56	0.54	0.54	0.68	0.81	0.86	0.94	0.99	1.07	1.13	1.23	1.31	1.56	
1.48	0.56	0.46	0.60	0.73	0.78	0.86	0.91	1	1.05	1.15	1.23	1.48	
1.40	0.58	0.38	0.52	0.65	0.71	0.78	0.84	0.92	0.98	1.08	1.15	1.40	
1.33	0.60	0.31	0.45	0.58	0.64	0.71	0.77	0.85	0.91	1	1.08	1.33	
1.27	0.62	0.25	0.38	0.52	0.57	0.65	0.70	0.78	0.84	0.94	1.01	1.27	
1.20	0.64	0.18	0.32	0.45	0.50	0.58	0.63	0.72	0.77	0.87	0.95	1.20	
1.14	0.66	0.12	0.26	0.39	0.44	0.52	0.57	0.65	0.71	0.81	0.89	1.14	
1.08	0.68	0.06	0.20	0.33	0.38	0.46	0.51	0.59	0.65	0.75	0.83	1.08	
1.02	0.70	–	0.14	0.27	0.32	0.40	0.45	0.54	0.59	0.69	0.77	1.02	
0.96	0.72		0.08	0.21	0.27	0.34	0.40	0.48	0.54	0.63	0.71	0.96	
0.91	0.74		0.03	0.16	0.21	0.29	0.34	0.42	0.48	0.58	0.66	0.91	
0.86	0.76		–	0.11	0.16	0.24	0.29	0.37	0.43	0.53	0.60	0.86	
0.80	0.78			0.05	0.1	0.18	0.24	0.32	0.38	0.47	0.55	0.80	
0.75	0.8			–	0.05	0.13	0.18	0.27	0.32	0.42	0.50	0.75	
0.70	0.82				–	0.08	0.13	0.21	0.27	0.37	0.45	0.70	
0.65	0.84					0.03	0.08	0.16	0.22	0.32	0.40	0.65	
0.59	0.86						–	0.03	0.11	0.17	0.26	0.59	
0.54	0.88							–	0.06	0.11	0.21	0.54	
0.48	0.9								–	0.06	0.16	0.48	
0.43	0.92									–	0.10	0.43	
0.36	0.94										0.03	0.36	
0.29	0.96										–	0.29	
0.20	0.98											–	0.20

Tab. 7/4: Conversion factors  $F$  for phase angle adjustments

## 7.2 Separately Installed Compensation Cubicles

When compensation cubicles are configured, which are to be installed separately from the switchboard, the back-up fuse and connection cable must be taken into account. For their configuration data, please refer to Tab. 7/5.

Power per cubicle	Nominal voltage 400 V AC / 50 Hz			Nominal voltage 525 V AC / 50 Hz			Nominal voltage 690 V AC / 50 Hz		
	Rated oper. current	Fuse per phase L1, L2, L3	Cable cross-section per phase L1, L2, L3	Rated oper. current	Fuse per phase L1, L2, L3	Cable cross-section per phase L1, L2, L3	Rated oper. current	Fuse per phase L1, L2, L3	Cable cross-section per phase L1, L2, L3
Up to 21 kvar	30.3 A	35 A	10 mm <sup>2</sup>	-	-	-	-	-	-
25 kvar	36.1 A	63 A	16 mm <sup>2</sup>	27.5 A	50 A	10 mm <sup>2</sup>	20.9 A	50 A	10 mm <sup>2</sup>
30 kvar	43.3 A	63 A	16 mm <sup>2</sup>	-	-	-	-	-	-
35 kvar	50.5 A	80 A	25 mm <sup>2</sup>	-	-	-	-	-	-
40 kvar	57.7 A	100 A	35 mm <sup>2</sup>	-	-	-	-	-	-
45 kvar	64.9 A	100 A	35 mm <sup>2</sup>	-	-	-	-	-	-
50 kvar	72.2 A	100 A	35 mm <sup>2</sup>	54.9 A	100 A	35 mm <sup>2</sup>	41.8 A	63 A	16 mm <sup>2</sup>
60 kvar	86.6 A	160 A	70 mm <sup>2</sup>	-	-	-	-	-	-
70 kvar	101 A	160 A	70 mm <sup>2</sup>	-	-	-	-	-	-
75 kvar	108 A	160 A	70 mm <sup>2</sup>	82.5 A	125 A	35 mm <sup>2</sup>	62.7 A	100 A	25 mm <sup>2</sup>
80 kvar	115 A	200 A	95 mm <sup>2</sup>	-	-	-	-	-	-
100 kvar	144 A	250 A	120 mm <sup>2</sup>	110 A	200 A	95 mm <sup>2</sup>	83.6 A	125 A	35 mm <sup>2</sup>
125 kvar	180 A	300 A	150 mm <sup>2</sup>	137 A	200 A	95 mm <sup>2</sup>	105 A	160 A	70 mm <sup>2</sup>
150 kvar	217 A	355 A	2 x 70 mm <sup>2</sup>	165 A	250 A	120 mm <sup>2</sup>	126 A	200 A	95 mm <sup>2</sup>
160 kvar	231 A	355 A	2 x 70 mm <sup>2</sup>	-	-	-	-	-	-
175 kvar	253 A	400 A	2 x 95 mm <sup>2</sup>	192 A	300 A	150 mm <sup>2</sup>	146 A	250 A	120 mm <sup>2</sup>
200 kvar	289 A	500 A	2 x 120 mm <sup>2</sup>	220 A	355 A	185 mm <sup>2</sup>	167 A	250 A	150 mm <sup>2</sup>
250 kvar	361 A	630 A	2 x 150 mm <sup>2</sup>	275 A	400 A	2 x 95 mm <sup>2</sup>	209 A	315 A	185 mm <sup>2</sup>
300 kvar	433 A	2 x 355 A <sup>1)</sup>	2 x 185 mm <sup>2</sup>	330 A	500 A	2 x 120 mm <sup>2</sup>	251 A	400 A	2 x 95 mm <sup>2</sup>
350 kvar	505 A	2 x 400 A <sup>1)</sup>	4 x 95 mm <sup>2 2)</sup>	385 A	630 A	2 x 150 mm <sup>2</sup>	293 A	500 A	2 x 120 mm <sup>2</sup>
400 kvar	577 A	2 x 500 A <sup>1)</sup>	4 x 120 mm <sup>2 2)</sup>	440 A	2 x 355 A <sup>1)</sup>	2 x 185 mm <sup>2</sup>	335 A	500 A	2 x 120 mm <sup>2</sup>
450 kvar	650 A	2 x 500 A <sup>1)</sup>	4 x 120 mm <sup>2 2)</sup>	495 A	2 x 400 A <sup>1)</sup>	4 x 95 mm <sup>2</sup>	377 A	2 x 315 A <sup>1)</sup>	2 x 185 mm <sup>2</sup>
500 kvar	722 A	2 x 630 A <sup>1)</sup>	4 x 150 mm <sup>2 2)</sup>	550 A	2 x 500 A <sup>1)</sup>	4 x 120 mm <sup>2</sup>	418 A	2 x 315 A <sup>1)</sup>	2 x 185 mm <sup>2</sup>

<sup>1)</sup> For this type of protection, an information label "Caution, reverse voltage through parallel cable" is recommended.  
A circuit-breaker can be used to avoid the problem with parallel fuses.

<sup>2)</sup> Connection possibility for separately installed compensation cubicles: max. 2 x 240 mm<sup>2</sup>.  
Recommendation for 4 parallel cables per phase: Use a separate incoming feeder cubicle and reactive compensation cubicle with main busbar.

Tab. 7/5: Connection cables and back-up fuses for separately installed compensation cubicles

If there are particular requirements concerning the power quality, or in case of a greater variation of the disturbing frequencies, the installation of a compensation with passive assemblies may be expensive. For this, active filters with high-frequency power electronics are appropriate. Further information on the corresponding solutions can be obtained from your contact partner at Siemens.



# Chapter 8

## Communication Connection

8.1	Serial Fieldbus Systems	81
8.2	Industrial Ethernet-Based Fieldbus Systems	82
8.3	Gateways	85
8.4	SIVACON S8-Specific Network Installation for Ethernet-Based Protocols	87
8.5	Data Visualization and Processing	90

# 8 Communication Connection

As a rule, only standardized and open communication systems (see standard series IEC 61158 for industrial communication networks – fieldbus specifications, and IEC 61784 for industrial communication networks – profiles) are used in SIVACON S8 switchboards. Transmission within the switchboard is done via serial or Industrial Ethernet-based fieldbus system on electrical transmission paths. Optical transmission paths can be connected outside the switchboard on request via suitable network interfaces.

The advantages of serial fieldbus systems are their simple structure, low costs, and high availability in operation. Furthermore, there is large choice of certified devices available, which can communicate and interact through a serial connection.

Industrial Ethernet systems (conforming to IEEE 802.3 or ISO/IEC 8802-3) have the advantage of higher data transmission rates, a larger data width, a large address range, a large network reach, options for real-time transmission, better preconditions for information security, and easier connection to production, which is becoming increasingly important regarding digitalization in the industrial area (keyword: Industry 4.0). Furthermore, different transmission paths such as cables, optical fiber, or radio transmission can be used and combined.

The use of SIVACON S8-specific communication systems is not intended, except for device-internal communication systems such as the 3VA-line for SENTRON 3VA molded-case circuit-breakers.

The different communication systems are connected and combined through standard gateways or data concentrators. Coupling different systems is important, for example, if existing switchboards have to be connected unchanged to new automation systems.

When installing the communication system in the switchboard, a difference is made between serial fieldbus systems such as PROFIBUS DP or Modbus RTU and Ethernet-based communication networks such as PROFINET, Modbus TCP and bus systems conforming to IEC 61850, as well as device-specific communication

connections such as 3VA-line. For configuration of the SIVACON S8 switchboard, the following communication systems can be selected:

- PROFIBUS up to 500 kbit/s or up to 12 Mbit/s
- PROFINET <sup>1)</sup>
- EtherNet/IP <sup>2)</sup> (abbreviated EIP; can only be selected for motor feeders with SIMOCODE pro V)
- Modbus RTU
- Modbus TCP
- 3VA-line (only cable feeders with SENTRON 3VA2).

1) With PROFINET, various protocol versions such as Modbus TCP, IEC 60870-104 and IEC 61850 can be integrated via SIVACON S8 withdrawable units.

2) For EtherNet/IP, the same electromagnetic design of the feeder/compartments is selected as for PROFINET, but with SIMOCODE pro V EIP instead of SIMOCODE pro V PN.

Tab. 8/1 shows the combination options for some Siemens devices with the different communication systems. Further communication systems are alternatively possible on request.

Communication system	Device
PROFIBUS DP	SIMOCODE Pro S/C/V, SENTRON 3WL COM15, SENTRON 3VL COM20, SIPROTEC, SENTRON PAC, SINAMICS, SIRIUS 3RW5
PROFINET	SIMOCODE Pro V PN, SIPROTEC, SENTRON PAC, SENTRON 3VA COM060, SENTRON 3WA COM190, SINAMICS, SIRIUS 3RW5
Modbus RTU	SENTRON 3WL COM16, SIMOCODE pro V MR, SIRIUS 3RW5
Modbus TCP	SENTRON PAC, SIPROTEC, SENTRON 3VA COM060, SENTRON 3WA COM190, SIRIUS 3RW5
EtherNet/IP	SIMOCODE pro V EIP
IEC 61850	SIPROTEC, SICAM P85x, SICAM Q100

Tab. 8/1: Examples for connection of Siemens devices to the different communication systems

## 8.1 Serial Fieldbus Systems

Known examples for serial fieldbus systems are PROFIBUS DP and Modbus RTU. The communication for both of them is based on a master-slave principle and two-core cables. As a difference to Modbus, PROFIBUS permits several masters on the bus.

PROFIBUS requires a shielded line. In the case of Modbus, the shield can be used as a third wire, which is requested in the specification as a common return for all participants with earth potential. Some other differences are compiled in Tab. 8/2 in short form.

The devices installed in SIVACON S8 usually have an RS485 interface, which means that this transmission procedure is used. In the case of the RS485 connections, termination resistors must be provided at the open wire ends in both bus systems. While passive resistors (150 Ω; power loss 0.5 W; Fig. 8/1) can be used with Modbus RTU, PROFIBUS must be equipped with active bus termination modules with their own control voltage supply, or bus connectors with integrated termination resistors. The control voltage supply of the bus termination resistors in the bus connector takes place through the device that is connected to the bus via the connector. In the bus system, all participants communicate with the same transmission rate stipulated by the master.

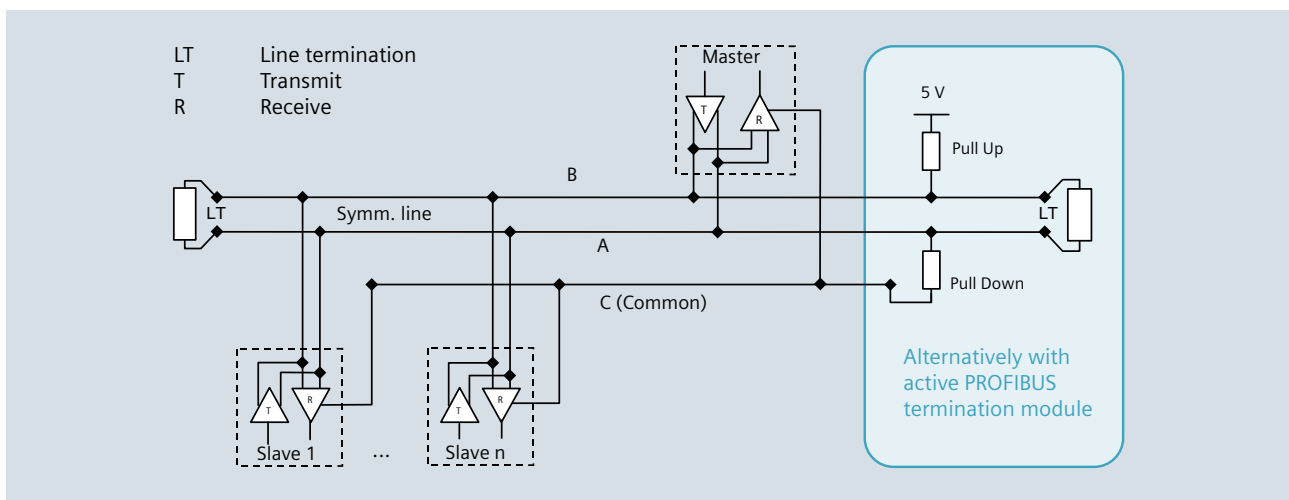

Fig. 8/1: RS485 connection for Modbus [source: modbus.org/docs/Modbus\_over\_serial\_line\_V1\_02.pdf (Modbus over Serial Line Specification and Implementation Guide V1.02; 2006)]

Properties	PROFIBUS DP	Modbus RTU
Operation modes	Multi-master mode possible	Only single-master mode
Ethernet-capable	No	Possible, through TCP/IP container
Transmission standard	RS485, optical fiber	No fixed standard (RS232, RS422, RS485, optical fiber, wireless possible): RS485 common
Transmission speed	From 1.2 kbps to 12 Mbps	Up to 115 kbps
Transmission distance	Up to 1,200 m at 9.6 kbps, up to 100 m at 12 Mbps	Up to 1,300 m (below 700 m with RS485)
Number of devices	Up to 126 devices (master and slaves)	Up to 247 slaves (32 with RS485; more with repeaters)
Typical applications	Thanks to the robustness of the protocol, complete systems can be automated. Advantageous in case of a larger number of devices, and in order to set up installations independently of the manufacturer.	Thanks to the simplicity of the protocol, particularly suitable in order to concatenate individual controllers in point-to-point operation. Advantageous for smaller automation projects.

Tab. 8/2: Features of PROFIBUS DP and Modbus RTU

## 8.1.1 PROFIBUS

For SIVACON S8 switchboards, two installation versions are distinguished for PROFIBUS DP:  
 PROFIBUS up to 500 kbit/s and up to 12 Mbit/s.

### i) PROFIBUS up to 500 kbit/s

The bus system is installed via PROFIBUS cable type A (Tab. 8/3). The withdrawable units and feeders are contacted through the control plug of the feeder. The line topology in the segment wiring is implemented from withdrawable unit to withdrawable unit. The bus line of the bus participants in the withdrawable units is designed as a radial line. At these transmission speeds, the use of radial lines is permissible and enables a disconnection of the withdrawable unit from the bus line without interrupting the latter. The ends of the radial line are implemented without bus termination resistor. The bus is connected at the SIMOCODE device through the bus connection terminals (A/B/SPE). Fig. 8/2 shows possible network topologies with PROFIBUS up to 500 kbit/s.

### ii) PROFIBUS up to 12 Mbit/s

A PROFIBUS connection with up to 12 Mbit/s is only possible with a bus installation without radial lines (Fig. 8/3). Every bus participant in a withdrawable unit is connected through a separate bus segment from the repeater to the bus participant in the withdrawable unit. The individual bus segments must be equipped at both ends with active termination resistors, whereby the bus participant in the withdrawable unit is connected through a bus connector with integrated bus termination resistors. Connection of the SIMOCODE device through the bus connection terminals (A/B/SPE) is not permissible.

<b>Surge impedance</b>	135...165 Ω
<b>Capacitance per unit length</b>	≤ 30 pF/m
<b>Loop resistance</b>	≤ 110 Ω/m
<b>Core diameter</b>	> 0.64 mm
<b>Core cross-section</b>	> 0.34 mm <sup>2</sup>

Tab. 8/3: Properties of a PROFIBUS cable type A

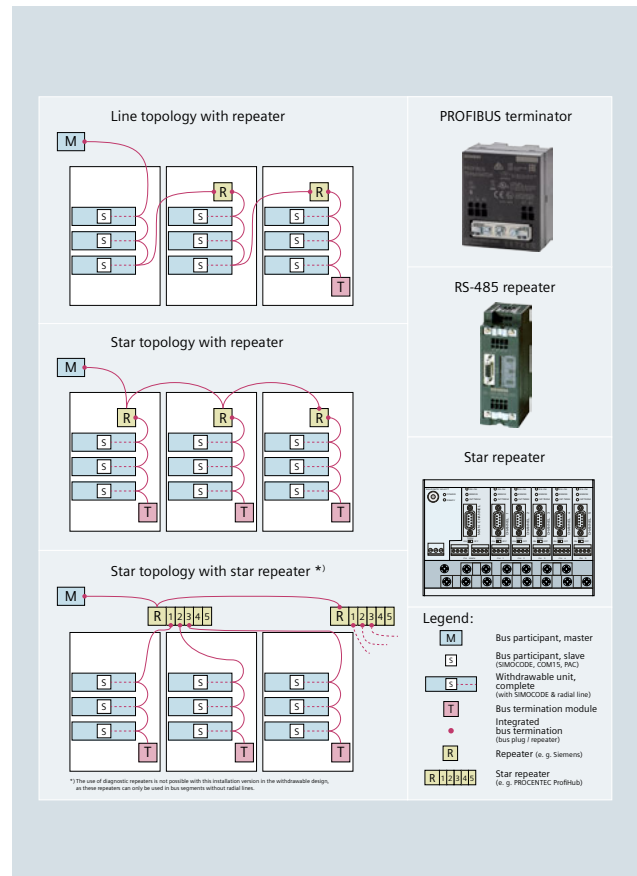

Fig. 8/2: PROFIBUS network topologies with repeater

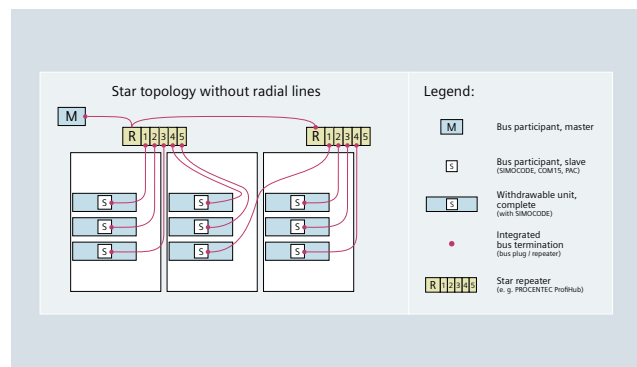

Fig. 8/3: PROFIBUS network topology without radial lines

## 8.1.2 Modbus RTU

As a special aspect regarding the RS485 connection in the case of Modbus, a third conductor (C = Common) must be considered as a common return for all participants with earth potential, apart from the two-wire connection (lines A and B). As termination resistors at the open line ends, 150-ohm resistors with a power loss of 0.5 W must be provided. Active bus terminations do not exist. For this reason, a pull-up or pull-down resistor must be provided for in Modbus segments (Fig. 8/1).

Due to the low data transmission rate of Modbus RTU, it is not advisable to set up bus lines with more than 31 slaves (a number of participants from 20 to 25 devices per bus line is technically appropriate). After a maximum of 31 participants, a suitable repeater must be installed. Suitable Modbus topologies are the line and star topology with repeater, comparable to the corresponding topologies in Fig. 8/2.

*Attention: The use of Siemens PROFIBUS repeaters is not possible. Suitable are, for example, devices from Phoenix Contact!*

Other than with PROFIBUS; devices connected via Modbus RTU cannot be connected with two master devices at the same time!

If it is necessary for another master (e.g. SIMARIS control and the process control system) to access these devices and there is no alternative way of access (e.g. a second communication interface) available, access must take place through a proxy gateway or a multi-client-capable gateway! (In this case, a SENTRON PAC 4200 is not suitable as a gateway, as this is a transparent gateway without multi-client functionality.)

## 8.2 Industrial Ethernet-Based Fieldbus Systems

As against the Ethernet used in the office area as a wired data transmission system, the Industrial Ethernet is adjusted to industrial ambient conditions. Additional requirements, such as real-time capability, better determinism (e.g. reliable assignment of events and safe transmission) and the robustness of the Industrial Ethernet require special data network components (lines, switches, converters, etc.). Furthermore, special protocols such as PROFINET or Modbus TCP are used (Ethernet protocol TCP/IP).

Generally, the Ethernet components used in SIVACON S8 switchboards can be applied to all office and industrial versions of the Ethernet protocol. It is also possible to use several protocols in parallel (e.g. PROFINET for SIMOCODE pro V PN feeders, Modbus TCP for SENTRON PAC measuring devices or for the 7KN POWERCENTER 3000), as different network services can run simultaneously on the same infrastructure. There is also the possibility for the same device to offer several services (e.g. PROFINET for process control, Webserver for diagnostics close to the switchboard, and OPC UA [open platform communications unified architecture] for connection to an energy management or maintenance system, such as SIMARIS control, or powermanager, for example). A typical representative of such devices is SIMOCODE pro V PN.

### 8.2.1 PROFINET

PROFINET is standardized in the IEC 61158 and IEC 61784 standard series. In SIVACON S8 switchboards, mainly PROFINET IO applications are used. PROFINET IO follows the proven PROFIBUS DP master-slave communication. Tab. 8/4 illustrates the transition from PROFIBUS to PROFINET for individual network participants.

Besides the mode of operation, PROFINET also defines the type of network installation. The cables and plug connectors to be used for PROFINET networks are defined.

Participant classification	Corresponds in PROFIBUS to	Examples
PROFINET IO Controller	Master class1 (cyclic)	Control and protection systems and controls
PROFINET IO Device	Slave	SIMOCODE, measuring devices for circuit-breakers
PROFINET IO Supervisor	Master class2 (acyclic)	Programming device, visualization

Tab. 8/4: Distribution of the PROFINET devices and their equivalents in PROFIBUS cubicles

## 8.2.2 Modbus TCP

The corresponding requirements are fixed in the individual conformance classes (CC) of IEC 61784-2.

- CC-A (switchboard automation): Lowest PROFINET conformance class, which requests a basic PROFINET functionality
- CC-B (machinery control): Enables additional diagnostics and topology information
- CC-C (motion control): Expands the functionality for using hardware-supported prioritization and synchronization in order to implement clock-synchronous applications.

In SIVACON S8 switchboards, passive installation components such as cables and plug connector are used, which are permissible for all conformance classes. In this context, the selection of the active network components (switches) depends on the requirements of the communication network and the scope of functions of the connected participants. For the communication functions of SIMOCODE, CC-A is sufficient if no redundancy concepts have to be implemented. If higher requirements (CC-B or CC-C) must be met, this has to be stipulated by the operator.

Modbus TCP corresponds to the Modbus RTU protocol for the Industrial Ethernet fieldbus. Modbus TCP is a part of the IEC 61158 standard and is based on a client/server architecture. By means of protocol converters or gateways such as SENTRON PAC4200 with RS485 module (Fig. 8/4), older devices with just a serial interface can be integrated in Ethernet-based systems.

If devices equipped with a MODBUS RTU interface (e.g. SIMOCODE pro V MR or data cards of the infrared temperature detection) are connected to a system with Modbus TCP master (client, for example SIMARIS control or 7KN POWERCENTER 3000), a conversion to Modbus TCP is required, for example with the help of a gateway. 3VA circuit-breakers can be connected to Ethernet-based bus systems via the unitary 3VA-line system by means of a data concentrator such as COM100 or COM800 (Fig. 8/5).

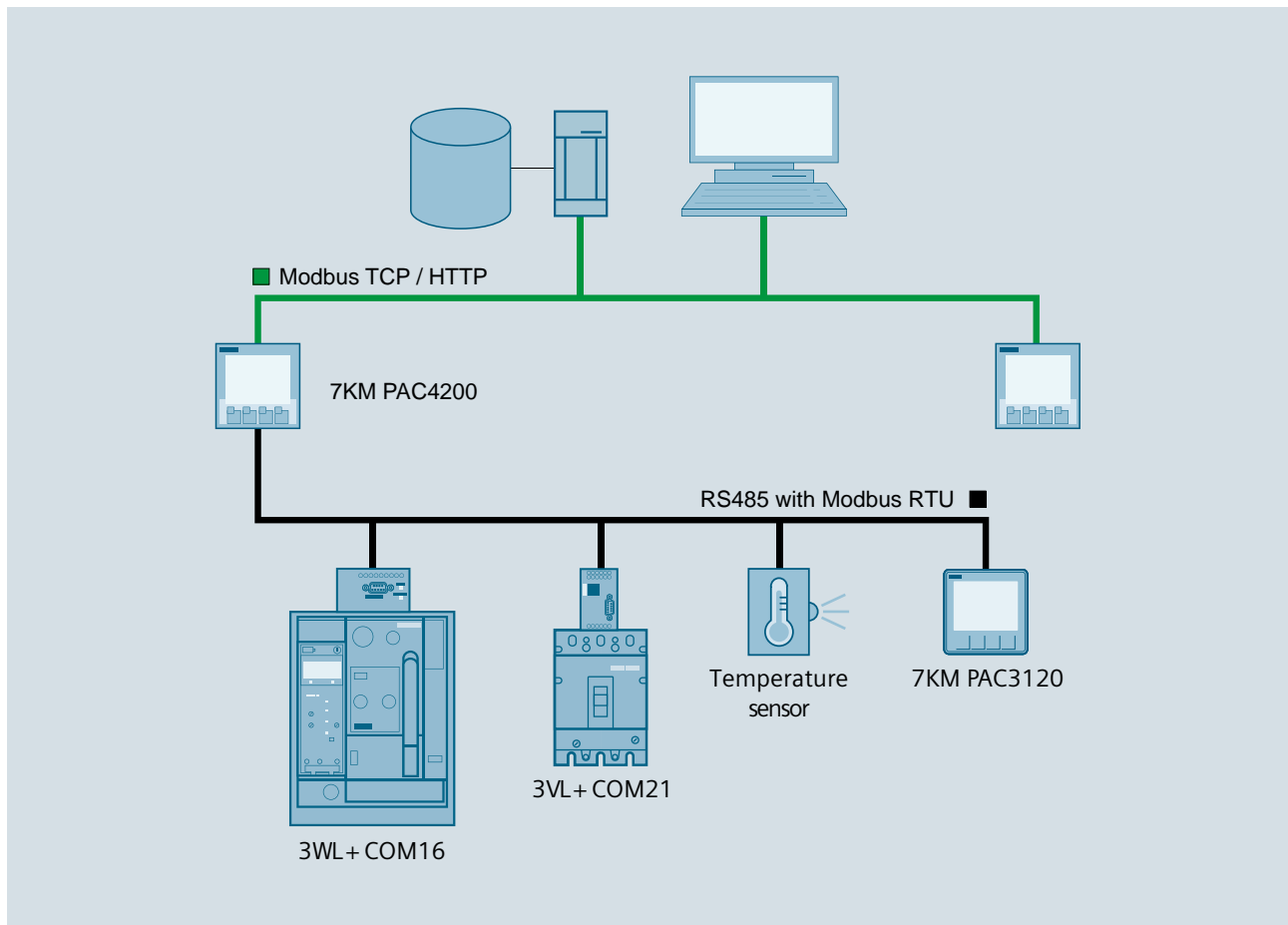

Fig. 8/4: Connection of Modbus RTU devices via a 7KM PAC4200 gateway to the Modbus TCP communication



## 8.3 Gateways

A gateway is an active network node that can interconnect two networks which are incompatible with each other (electrically or at protocol level). Gateways have the task to mediate between two networks that use different protocols or "bus physics" (e.g. different data line systems).

For this, the gateway has a separate interface for every network connected to it, and it can be addressed from both sides. To enable communication between the two networks, the gateway converts the protocol of one network side to the protocol of the other network side. The protocol conversion is done autonomously and transparently for the other network participants (transparent gateway).

This means that the gateway itself does not influence the use data transmitted between the participants. From the slave's point of view, the higher level control (e.g. a Modbus TCP client) is the master, but not the gateway. To the contrary, the client/master can access the complete data stock of all slaves.

As a gateway for the connection between Modbus RTU and Modbus TCP, a SENTRON 7KM PAC4200 measuring device with RS485 module (up to 31 Modbus RTU devices can be connected) may be used, for example (Fig. 8/4). If such a device is already available in the switchboard, and its gateway function is not required for other purposes, the additional device is not necessary. It has to be observed that, if a PAC4200 is used as a gateway, only a single Modbus TCP client (master) can access the Modbus RTU devices. All slaves are accessed sequentially. This means that the effective data transmission rate depends on the Modbus RTU side, even if the Modbus TCP level would be much faster theoretically.

Likewise, a data concentrator such as COM800 for the 3VA-line or, at a higher level, the SENTRON 7KN POWERCENTER 3000 for cloud connection and transition to the Intranet or Internet, works like a proxy gateway (Fig. 8/5). Here, the data concentrator acts as master towards the slaves itself, and reads the data directly.

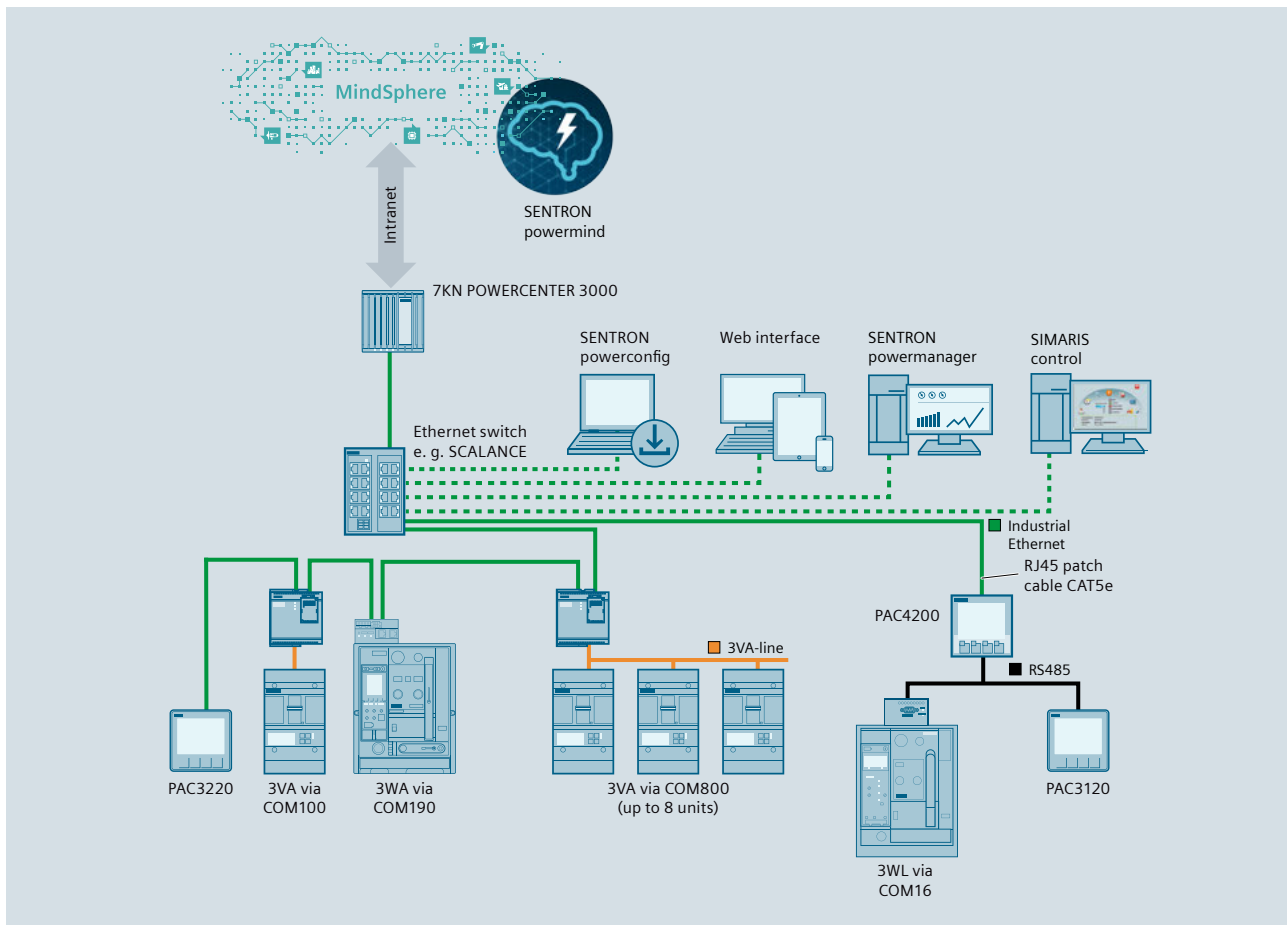

Fig. 8/5: Communication network with SENTRON 7KN POWERCENTER 3000 as a gateway for connection to the cloud

In addition, as the name suggests, the total amount of data from the slaves can be concentrated to several important data points. These are made available for a higher-level client for which the data concentrator acts as a server. This mechanism involves that only the data the gateway retrieves from the slaves is available for the Modbus TCP client. Therefore, the gateway becomes a representative (proxy) for all subordinate slaves. Many proxy gateways, such as for example the SENTRON 7KN POWERCENTER 3000, can be addressed simultaneously by several clients (→ multi-client functionality). In this way, for example, a control system, the SENTRON powermanager, and SIMARIS control would be able to access the same data stock.

Nevertheless, the data concentrator must be installed. Apart from the obligatory settings such as the IP address and the network parameters, it is also necessary to select the data to be retrieved from the slaves and make them available on the TCP side (mapping). The SENTRON 7KN POWERCENTER 3000 can be used here for pre-processing (e.g. modification of data formats, scaling). If slaves are added or removed, the gateway configuration must be adjusted accordingly. Due to its principle, such a data concentrator buffers all data, so that the clients can access them in a faster sequence than would be possible with a transparent gateway.

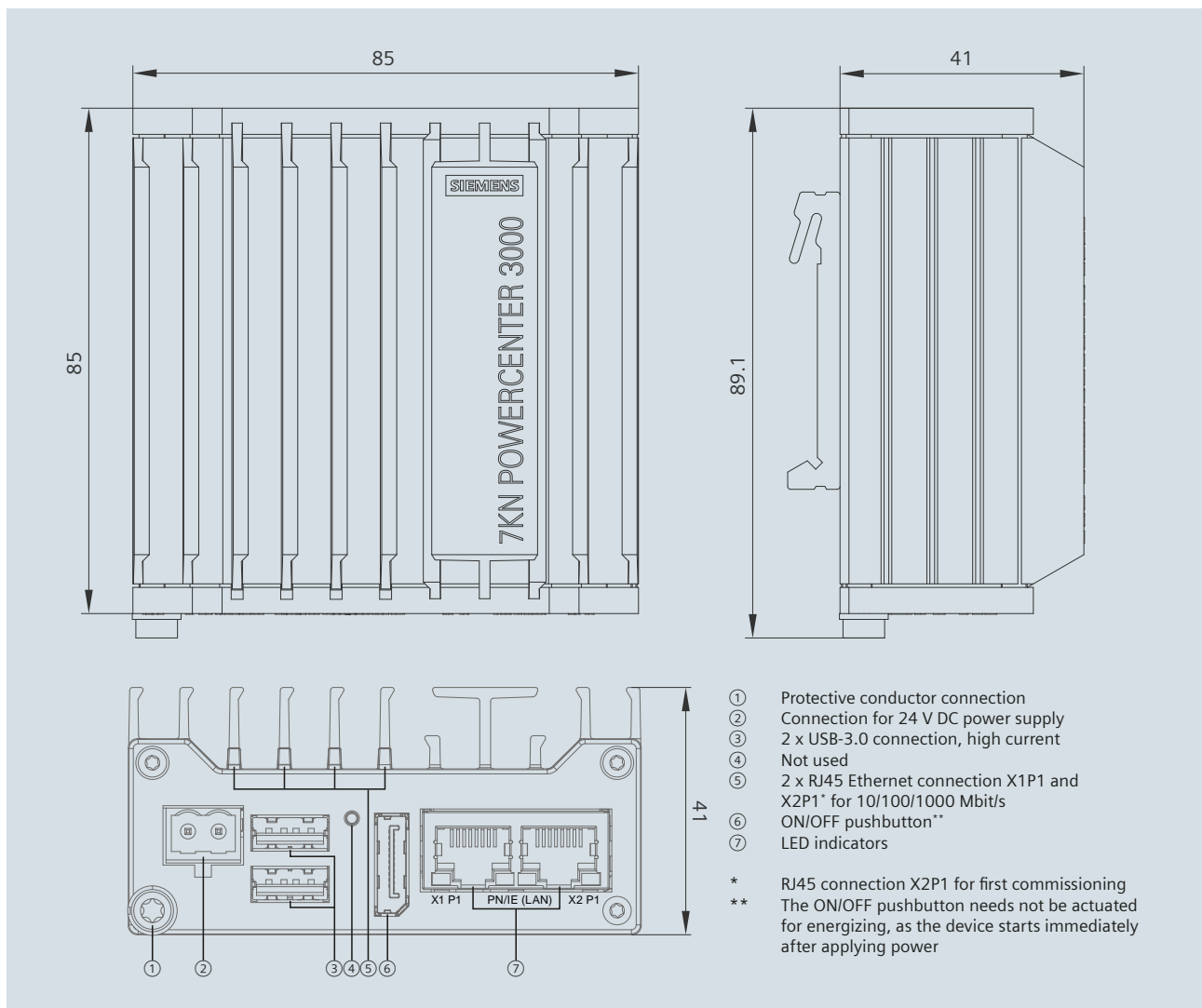

Fig. 8/6: Dimensions and connections of the SENTRON 7KN POWERCENTER 3000 (dimensions in millimeters)

## 8.4 SIVACON S8-Specific Network Installation for Ethernet-Based Protocols

The network installation takes place via active network components (switches, e.g. SCALANCE). Every participant is connected through a port of a switch. As connection cables, Industrial Ethernet cables with the corresponding RJ45 plugs are used. Connections of the Industrial Ethernet cable via terminals are not permissible in SIVACON S8 switchboards. Some devices (e.g. SIMOCODE) include integrated switches with two ports. Such participants can then be interconnected to a line (SIMOCODE to SIMOCODE) even without an additional switch.

Such line structures can only be used in the withdrawable design with restrictions, as a SIMOCODE device in a disconnected withdrawable unit would interrupt this line. Also, the failure of the device control voltage of a SIMOCODE device would lead to a network failure of the subsequent devices.

In SIVACON S8 switchboards with withdrawable design, the PROFINET devices in the withdrawable units are connected to the network via RJ45 plug connectors. In designs with small withdrawable units, this RJ45 plug is directly integrated in the control plug housing of the withdrawable unit. This leads to a reduction to 19 available control contacts.

Article number	Cable length
6XV1870-3QE30	0.3 m
6XV1870-3QE50	0.5 m
6XV1870-3QH10	1.0 m
6XV1870-3QH20	2.0 m
6XV1870-3QH30	3.0 m
6XV1870-3QH40	4.0 m
6XV1870-3QH60	6.0 m
6XV1870-3QN10	10.0 m
6XV1870-3QN15	15.0 m
6XV1870-3QN20	20.0 m
6XV1870-3QN25	25.0 m
6XV1870-3QN30	30.0 m
6XV1870-3QN35	35.0 m
6XV1870-3QN40	40.0 m
6XV1870-3QN45	45.0 m
6XV1870-3QN50	50.0 m

Tab. 8/5: Industrial Ethernet cable, prefabricated with two RJ45 plugs (CAT 6A, TP line 4 x 2)

In normal withdrawable units, the plug connector is additionally integrated at the control plug and does not lead to a reduction of the control contacts. On every withdrawable unit compartment there is a RJ45 socket available. The connection from the withdrawable unit compartment to the switch in the cubicle is implemented via Industrial Ethernet standard cables, which are prefabricated and available in different lengths (Tab. 8/5).

It is basically possible to execute the PROFINET connection of a withdrawable unit twice (for small withdrawable units only possible for ½ withdrawable units). In this way, redundant network connections or two separate communication networks can be connected to a withdrawable unit.

For installation of the active network components (switches) in the cubicle, there is no configuration feature available. Placing the switch mainly depends on the cubicle type, the cubicle equipment, and the switch used. Standardization is therefore hardly possible. Every switchboard must be configured individually.

Which type of switch will be used depends on the operator's network requirements. Basically, a difference is made between non-configurable (unmanaged) and configurable (managed) switches. Tab. 8/6 shows a selection of managed and unmanaged PROFINET switches from Siemens.

SCALANCE type	Article number	Number of ports, electrical	Managed / Unmanaged
XB005	6GK5005-0BA00-1AB2	5	Unmanaged
XB008	6GK5008-0BA00-1AB2	8	Unmanaged
XB112	6GK5112-0BA00-2AB2	12	Unmanaged
XB116	6GK5116-0BA00-2AB2	16	Unmanaged
XB124	6GK5124-0BA00-2AB2	24	Unmanaged
XC208	6GK5208-0BA00-2AC2	8	Managed
XC216	6GK5216-0BA00-2AC2	16	Managed
XC224	6GK5224-0BA00-2AC2	24	Managed

Tab. 8/6: PROFINET switches SCALANCE (10/100 Mbit/s) for cubicle installation



Unmanaged switches are simple, non-configurable network switches. They feature the basic functionalities of an Industrial Ethernet switch. They are suitable for setting up networks in line or star structure. If there are no special requirements, this type should be preferred. Installation can be easily done with plug-and-play. Unmanaged switches meet the requirements of conformance class CC-A.

The functions of conformance class CC-B require managed switches. These switches feature an extended range of functions for network diagnostics, safety settings, speed optimization, etc. They are suitable for setting up networks in line, star or ring structure. Configuration usually takes place via device-internal webservers or special parameterization programs, and is generally stored on exchangeable storage media (C-plug).

At least one port must be provided per switch for the connection to the higher-level network (tree topology).

In a ring structure, two ports must be provided for this connection. It is economically more useful to use a 16-port switch than two 8-port switches, as there are more ports effectively available, and there is less need for connection cables. To connect the switches with the terminal devices, prefabricated patch cables can normally be used. These are available in many graded lengths in the Siemens portfolio.

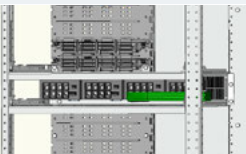
To install the switch devices, a separate compartment should be provided, which is available in two different heights (100 and 200 mm). The corresponding empty compartments have to be configured (Tab. 8/7). If this is not possible for reasons of space, Tab. 8/8 shows mounting options in the cable compartment as well as the head or foot compartment for the corresponding switch configurations in the universal outgoing feeder cubicle. Fig. 8/7 shows the installation of the assembly 8PQ6024-2AA74 for a small switch with 8 ports, as it is possible in all cubicle types.

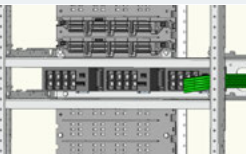
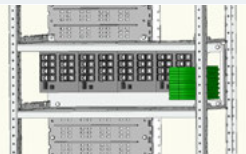
Assembly	8PQ6024-2AA88	8PQ6024-3AA00	8PQ6024-3AA01	8PQ6024-3AA02
Cubicle configuration	Busbar top-rear Cable connection from the right	Busbar top-rear Cable connection from the right	Busbar top-rear Cable connection from the rear	Busbar top-rear Cable connection from the rear
Height	100 mm	200 mm	100 mm	200 mm
Max. number of free ports: Tree / Ring	28 / 24	60 / 56	21 / 18	60 / 56
View (example)				

Tab. 8/7: Mounting options in empty compartments for cubicle installation of SCALANCE switches

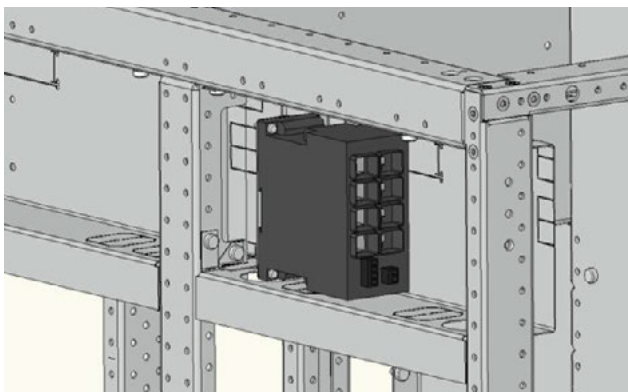























Fig. 8/7: Mounting option of a SCALANCE switch with 8 ports for all cubicle types

Cubicle configuration	Total number of ports of the switches used		
	8	16	24
Busbar at the top Cable connection from right Cable entry from bottom	8PQ6024-3AA05 1 x 8 ports Ports max.: Tree: 7 / Ring: 6	8PQ6024-3AA05 1 x 16 ports Ports max.: Tree: 15 / Ring: 14	2 x 8PQ6024-3AA05 1 x 8 ports + 1 x 16 ports Ports max.: Tree: 22 / Ring: 20
			
	8PQ6024-3AA06 1 x 8 ports Ports max.: Tree: 7 / Ring: 6	2 x 8PQ6024-3AA06 2 x 8 ports Ports max.: Tree: 14 / Ring: 12	3 x 8PQ6024-3AA06 3 x 8 ports Ports max.: Tree: 21 / Ring: 18
			
Busbar at the top Cable connection from rear Cable entry from bottom	8PQ6024-3AA03 or 8PQ6024-3AA04 1 x 8 ports Ports max.: Tree: 7 / Ring: 6	8PQ6024-3AA03 1 x 16 ports Ports max.: Tree: 15 / Ring: 14	3 x 8PQ6024-3AA03 1 x 24 ports Ports max.: Tree: 23 / Ring: 22
			
	8PQ6024-3AA03 or 8PQ6024-3AA04 1 x 8 ports Ports max.: Tree: 7 / Ring: 6	8PQ6024-3AA03 1 x 16 ports Ports max.: Tree: 15 / Ring: 14	3 x 8PQ6024-3AA03 1 x 24 ports Ports max.: Tree: 23 / Ring: 22
			
Busbar at the rear Cable connection from right Cable entry from bottom	8PQ6024-3AA07 1 x 8 ports Ports max.: Tree: 7 / Ring: 6	8PQ6024-3AA07 1 x 16 ports Ports max.: Tree: 14 / Ring: 12	8PQ6024-3AA07 1 x 24 ports (or 1 x 16 + 1 x 8 ports) Ports max.: Tree: 23 / Ring: 22 (or Tree: 22 / Ring: 20)
			
	8PQ6024-7AA01 1 x 8 ports Ports max.: Tree: 7 / Ring: 6	8PQ6024-7AA01 1 x 16 ports Ports max.: Tree: 14 / Ring: 12	8PQ6024-7AA01 1 x 24 ports (or 1 x 16 + 1 x 8 ports) Ports max.: Tree: 23 / Ring: 22 (or Tree: 22 / Ring: 20)
			
	8PQ6024-3AA08 1 x 8 ports Ports max.: Tree: 7 / Ring: 6	8PQ6024-3AA08 1 x 16 ports Ports max.: Tree: 14 / Ring: 12	8PQ6024-3AA08 1 x 24 ports Ports max.: Tree: 21 / Ring: 18
			
	8PQ6024-3AA10 1 x 8 ports Ports max.: Tree: 7 / Ring: 6		
			

Tab. 8/8: Mounting options of SCALANCE switches in the cable, head or foot compartment of universal outgoing feeder cubicles

1  
2  
3  
4  
5  
6  
7  
8  
9  
10  
11  
12

## 8.5 Data Visualization and Processing

The network installation described above transmits data, information and commands from and to the intelligent protection, switching and measuring devices as well the sensors installed in the SIVACON S8 switchboard. Suitable hardware and software, as already briefly presented in Chapters 8.2 and 8.3, are required for parameterization, observation and operation in the low-voltage power distribution board and in the industrial Motor Control Center. Fig. 8/8 can only provide a rough classification of the components described in the following. The application advantages are shown for the typical places of use. It is clear that SIMARIS control as a human-machine interface (HMI) can offer a wide scope of functions especially for SIVACON S8 and medium-voltage switchgear,

whereas the Siemens products designed for specialized tasks can be used for the different product series from Siemens.

The TIA Portal as an important auxiliary means for commissioning enables full access to the complete digitalized automation, from digital planning through integrated engineering up to transparent operation, and WinCC is a PC-based process visualization system that provides the basis for numerous Siemens tools. For a specific configuration and for more detailed information, also regarding the numerous other communication and data processing options offered by Siemens, the expert consultants of Siemens can provide assistance.

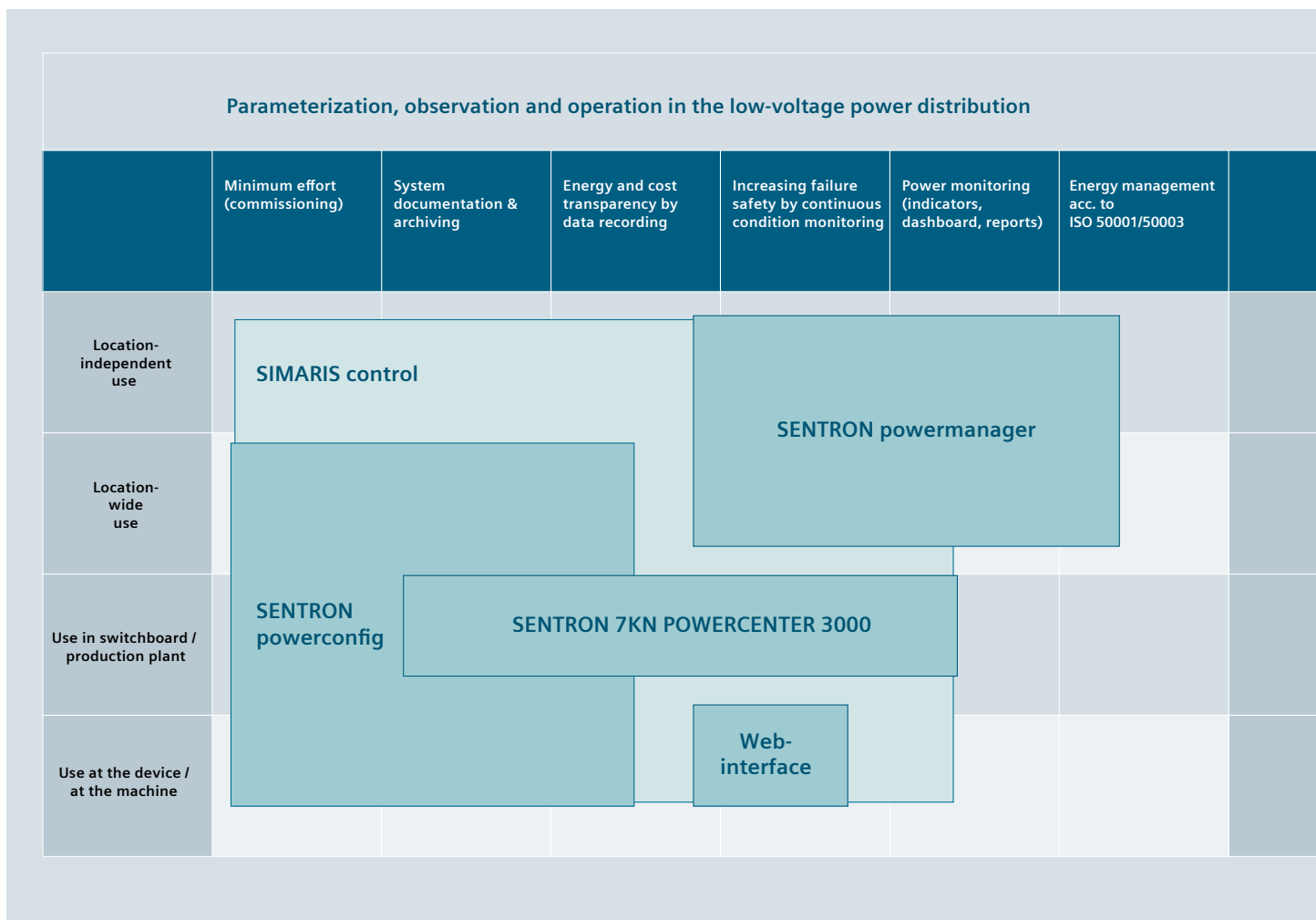

Fig. 8/8: Communication solutions from Siemens for SIVACON S8

## 8.5.1 SENTRON 7KN POWERCENTER 3000

As an open platform for the collection, processing and signaling of data directly in the switchboard or the Motor Control Center, the SENTRON 7KN POWERCENTER 3000 (Fig. 8/6) provides for a consistent connection of the production to the Internet of Things (IoT). The intelligent gateway for IoT solutions is appropriate for location-independent monitoring of switchboard states in low-voltage power distribution boards, and is designed for harsh ambient conditions:

- 24/7 continuous duty
- For an ambient temperature up to 50 °C
- Satisfies high vibration / shock requirements.

Thanks to the plug-and-operate connection to MindSphere and other cloud systems, the 7KN POWERCENTER 3000 additionally enables getting started into new business models for enterprises, for example in the form of cloud-based services.

Basic features are:

- Capture and storage of individual state, statistical and measured values as smart data packages with little effort
- Integration of subordinate, communication-capable SENTRON measuring devices, circuit-breakers via Modbus TCP/RTU gateways and other devices via Modbus TCP
- Data visualization and analysis in a web interface, in the local power monitoring system SENTRON power-manager or in the cloud-based open IoT operating system MindSphere, for example to SENTRON powermind
- Data security during transmission to the cloud via protected https-communication, IP-based access control and other integrated safety measures

Parameterization, observation and operation in the industrial Motor Control Center

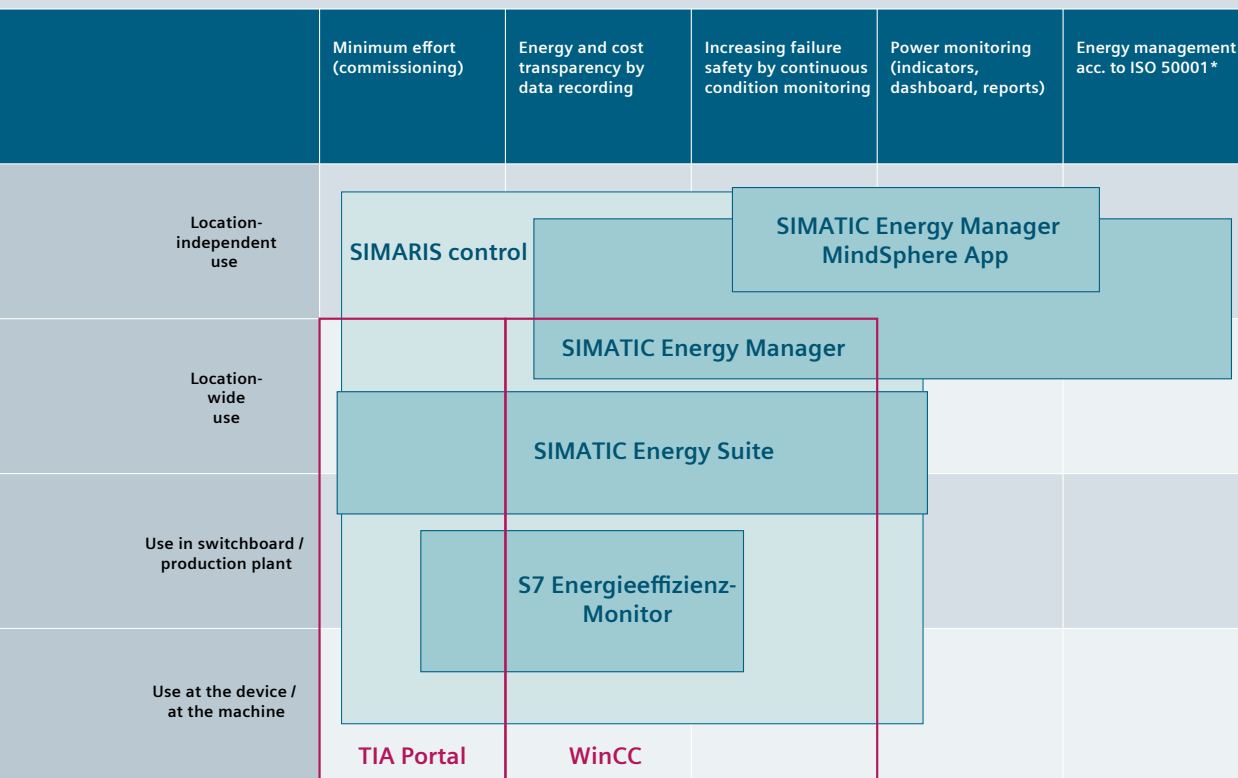

\* Baseline management, forecast, batch analysis

1  
2  
3  
4  
5  
6  
7  
8  
9  
10  
11  
12

- High switchboard availability thanks to warning messages in case of failure via e-mail and status information accessible at any time
- Web interface with 10 different languages as well as user login
- Explicit and periodical export of archived data as ".csv" files
- Support of other cloud systems (e.g. AWS, Azure or Alibaba Cloud)
- Time synchronization of connected devices
- Simple solution for an energy management for certification according to ISO 50001 / ISO 50003 and ISO 50006
- The hardware is qualified for international markets by CE, UL and EAC certification
- Configuration with SENTRON powerconfig.

### 8.5.2 SENTRON powerconfig

The SENTRON powerconfig software tool is appropriate for efficient commissioning and diagnostics of communication-capable SENTRON components. The Windows PC-based tool facilitates the setting of the devices, which leads to considerable time savings, in particular when several devices have to be set. SENTRON powerconfig offers the following functions:

- Parameterization, documentation, operation and observation in a single software
- Comfortable documentation of settings and measured values
- Clear overview of the available parameters including plausibility check of input values
- Display of available device states and measured values in standardized views
- Project-oriented filing of device data
- Uniform operation and usability
- Support of the different communication interfaces (Modbus RTU, Modbus TCP, PROFIBUS, PROFINET)
- Update of the device firmware and loading of language packages (depending on the device).

SENTRON powerconfig is available free of charge at: <http://support.automation.siemens.com/WW/view/de/63452759>

### 8.5.3 SENTRON powermanager

The power monitoring software SENTRON powermanager helps to easily evaluate, archive and monitor the captured measured values. Reports can be generated in graphical and tabular form. The Windows software clarifies the power distribution and enables an analysis of the captured data. The software platform is a standard SQL database.

The usual communication networks can be used to transmit the captured measuring data to the software for evaluation purposes. The TÜV certificate of conformity confirms that the power monitoring system is suitable for operation of an energy management system according to ISO 50001. The energy data of the most important measured values is captured via predefined views that can be visualized immediately after commissioning of the communications.

The representation and evaluation of the measured values is done in graphical form through load curves. Besides peak loads, energy-intensive processes as well as inefficient consumers become visible. For example, peak loads can be reduced by initiating the associated measures, such as intelligent control of thermal consumers. In addition, the purchasing conditions can be improved, thus reducing the energy costs.

Starting a power monitoring system can be made with a simple license that can be flexibly extended according to the respective customer requirements. With the flexible license concept, the powermanager power monitoring software is scalable regarding the size of the system and additional functions. Moreover, further measuring devices can be integrated into the power monitoring system.

Highlights with regard to the customer benefit are:

- TÜV-tested power monitoring system
- Suitable for use in the infrastructure, industrial applications, and buildings
- Integration of measuring devices for data capture of non-electric energy carriers
- Low investment costs and high security of investment
- Reduced engineering expenses during commissioning
- Scalable power monitoring system according to customer requirements
- Simple connection of other components
- Reduction of energy consumption by detection of inefficient consumers
- Optimization of energy use by means of specific measures
- Reduction of energy procurement costs by avoiding peak loads
- Raising awareness about energy in the enterprise by transparency.



## 8.5.4 SIMARIS control

SIMARIS control has been conceived as a modular power visualization system especially for the low-voltage switchboard SIVACON S8 manufactured by Siemens, as well as for medium-voltage switchgear by Siemens. A great advantage is its flexibility of use regarding infrastructure and industrial solutions (Fig. 8/8).

SIMARIS control is perfectly suitable for application in SIVACON S8 switchboards with integrated fieldbus system, in particular in Motor Control Centers with numerous motor feeders, but also for low-voltage power distribution boards.

To operate this software, an industrial PC system with the operating system Windows 10 (64-bit version) must be available, which is either installed in the switchboard or linked with it. The open system enables the connection to special power monitoring and evaluation software like SENTRON powermanager, or WINCC-based software. Through a cloud connection, linking to cloud apps such as SENTRON powermind is also possible, of course.

Configuration parameters	Ordering option	
Number of participants	XS	10 devices
	S	40 devices
	M	80 devices
	L	125 devices
	XL	180 devices
	XXL	500 devices
Industrial PC	Yes <sup>1)</sup> / No	
PROFIBUS	Number of PROFIBUS lines	Up to 4
PROFINET	Yes / No	
Modbus TCP	Yes / No	
Modbus RTU <sup>2)</sup>	Yes <sup>3)</sup> / No	
License medium	Hardware dongle	
WLAN access point	Yes / No	
Indication IACD + AQD	No / IACD / IACD + AQD	
Indication cooling by fan	Yes / No	
MindSphere connection (only Professional license)	Yes / No	
<sup>1)</sup> A panel PC with touch display is delivered as standard <sup>2)</sup> A gateway is required in the switchboard; preferred configuration: SENTRON PAC4200 <sup>3)</sup> With SENTRON PAC4200 as a gateway in one cubicle of the switchboard <sup>4)</sup> Internal arc-fault control device (IACD, e.g. Arcteq AQ110P/AQ101) Arc quenching device (AQD, e.g. Arcteq AQ1000)		

Tab. 8/9: Options for the SIMARIS control versions

For SIMARIS control there are four license versions available, with a variety of options (Tab. 8/9):

- Basic  
Offline version that makes the project documentation available via a clear interface; it is delivered together with the WinCC OA Dongle on a USB stick
- Standard  
Online version that includes the basic functions for observation and monitoring of the switchboard; for equipment options, see Tab. 8/9
- Advanced  
Measured values captured online can additionally be archived; extended scope of operations
- Professional  
In addition to all functions of the Standard and Advanced version, a server functionality via OPC UA is integrated (optionally, Modbus TCP server). In this way, data from the switchboard can be prepared and made available for other systems (e.g. connection to SENTRON powermanager or MindSphere); for this, higher engineering expenses must be taken into account.

Furthermore, there is a demo version available that is delivered without license.

## 8.5.5 SIMATIC Energy Suite and SIMATIC Energy Manager

The SIMATIC Energy Suite as an option of the TIA Portal links the energy management efficiently with the automation system, and thus also the energy transparency with the power distribution system for the production. This software package helps summarize, buffer and visualize different energy data in a uniform way. With the clearly simplified configuration of energy-measuring components from the SIMATIC, SENTRON, SINAMICS, SIRIUS and SIMOCODE product families, the configuration effort is considerably reduced. The automatic generation of the energy program reduces the configuration expenses for industrial plants significantly. Thanks to the consistent connection to SIMATIC Energy Manager, the captured energy data can be seamlessly extended to a location-overlapping energy management system certified according to ISO 50001 (Fig. 8/9). Highlights are:

- Easy and intuitive configuration instead of programming
- Automatic generation of the energy program of a programmable logic controller (PLC)
- Comfortable integration of measuring components from the Siemens portfolio and other manufacturers
- Integrated into the TIA Portal and the automation system
- Archiving on WinCC Professional or PLC
- Seamless connection to Energy Manager.

Configuration information from the SIMATIC Energy Suite can be directly loaded into the SIMATIC Energy Manager, without additional configuration effort. The SIMATIC Energy manager mainly offers functions for the commercial and corporate consideration of the energy consumption. To optimize the energy consumption, the relevant power flows throughout all energy media of the enterprise must be transparent:

- Creation of energy and material balances
- Calculation of indicators; the key performance indicators (KPI) enable the energetic evaluation and comparison of different processes and systems (benchmarking)
- Cost transparency by allocating the energy costs to the actual perpetrators
- Sensitization of employees regarding the energy consumption of machinery, processes and systems.

The SIMATIC Energy Manager is available in a Basic and a PRO version. The Basic version is for getting started and is just web-based. An upgrade from Basic to PRO is possible with a license key.

Apart from the connection to the SIMATIC Energy Suite, the SIMATIC Energy Manager also offers the latest interface standards, such as WinCC, PCS7, Desigo CC, OPC UA, OPC DA (DA, HA), OPC HDA, Modbus TCP, ODBC, ASCII or XML, machine driver to the S7 EE Monitor. The scope of functions reaches from power monitoring, power controlling, energy accounting, baseline management, and forecasting to an energy efficiency measure management. This includes, among others, a comprehensive and easily usable reporting system, as well as a dynamic widget-based web dashboard for analyzing or distributing the captured and prepared data.

The energy data are pre-processed in a real-time accounting core that can be freely modeled, including formula editor for the definition and configuration of new calculation functions (thermal calculation of boiler plants, quality of CHP plants, etc.).

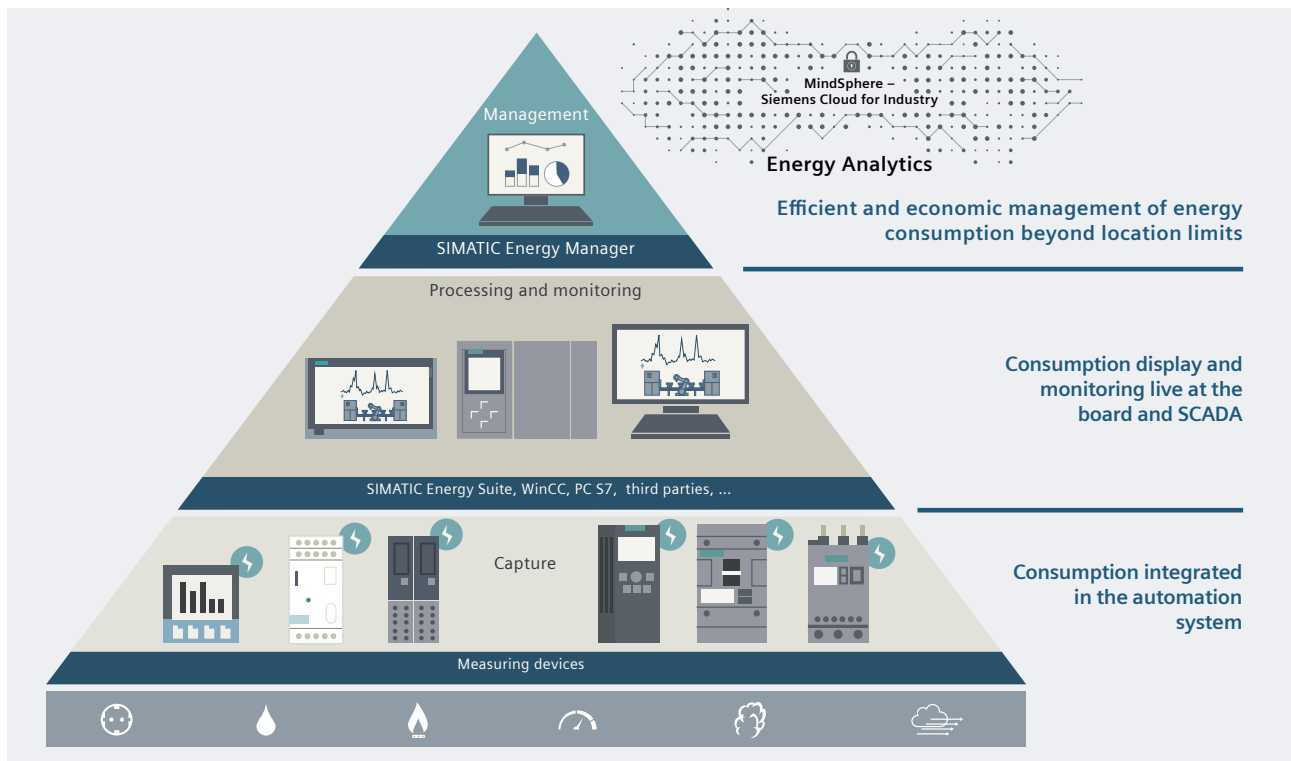

Fig. 8/9: Energy management pyramid with SIMATIC Energy Suite and SIMATIC Energy Manager

# Chapter 9

## Further Planning Notes

9.1	Installation	96
9.2	Weights and Power Losses	102
9.3	Environmental Conditions	103



# 9 Further Planning Notes

In the planning phase, installation conditions such as distances, width of maintenance gangways, weights, underground, as well as environmental conditions, for example climatic conditions, and power loss must already be considered. In particular, the following aspects should be kept in mind when planning a switchboard:

- Maximally permitted equipment of a cubicle (for example, number of in-line switch-disconnectors considering size and load of the in-line unit; manufacturer information must be observed!)
- Minimum cubicle width, considering equipping density, conductor cross-sections and number of cables (a wider connection compartment may have to be selected or an additional cubicle may have to be configured)
- Device derating factors must be observed according to the manufacturer information! The mounting location, ambient temperature, and rated current play an important part (particular attention in case of currents higher than 2,000 A!)
- The dimensioning of compensation systems is very much governed by the place of use (office, production) and the network conditions (harmonic content, DSO specifications, audio frequency, etc.). Up to about 30 %

of the transformer output can be expected as a rough estimate (in industrial environments) in the absence of specific criteria for planning. If switched-mode power supply units are increasingly used, for example in ICT equipment in office rooms, the power factor may even turn capacitive. In this context, it must be observed that these power supply units frequently cause network feedbacks in the form of harmonics, which can be reduced by passive or active filters

- The decision in favor of central or distributed implementation of compensation is governed by the network configuration (center of reactive current sources). In case of distributed arrangement of the compensation systems, appropriate outgoing feeders (in-line switch-disconnectors, circuit-breakers, etc.) shall be provided in the switchboard.
- Generator-source networks must not be compensated if problems may arise in generator control as a result of compensation control (disconnecting the compensation system during switchover to generator mode or static compensation adjusted to the generator are possible)
- Choking of a compensation system depends on the network requirements as well as on those of the customer and the DSO.

## 9.1 Installation

### Installation – distances and gangway widths

When low-voltage switchboards are installed, the minimum distances between switchboards and obstacles as specified by the manufacturer must be observed (Fig. 9/1).

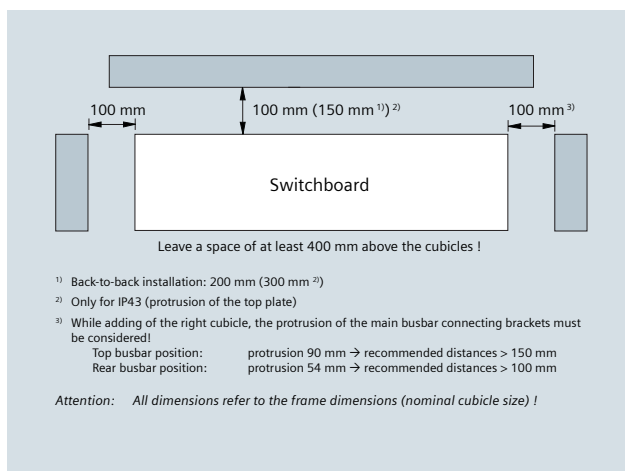

Fig. 9/1: Distances to obstacles

The minimum dimensions for control and maintenance gangways according to IEC 60364-7-729 must be taken into account when planning the space required (Fig. 9/2).

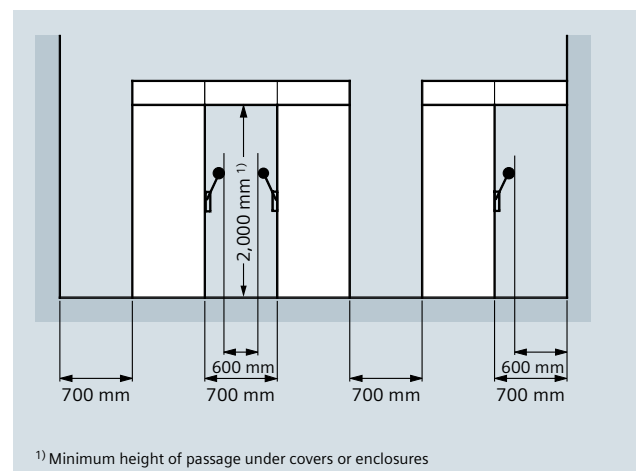

Fig. 9/2: Gangway widths and passage heights

When using an lifting truck for the insertion of circuit-breakers, the minimum gangway widths must be matched to the dimensions of the lifting truck. A reduced gangway width within the range of open doors must be paid attention to (Fig. 9/3). With face-to-face switchboard fronts, constriction by open doors is only accounted for on one side. SIVACON S8 doors can be fitted so that they close in escape direction. The door hinge can easily be changed later. Moreover, the standard requires a minimum door opening angle of 90°.

### Altitude

The site altitude must not be above 2,000 m above sea level.

Switchboards and equipment which are to be used in higher altitudes require that the reduction of dielectric strength, the equipment switching capacity, and the cooling effect of the ambient air be considered. Further information can be obtained from your contact partner at Siemens.

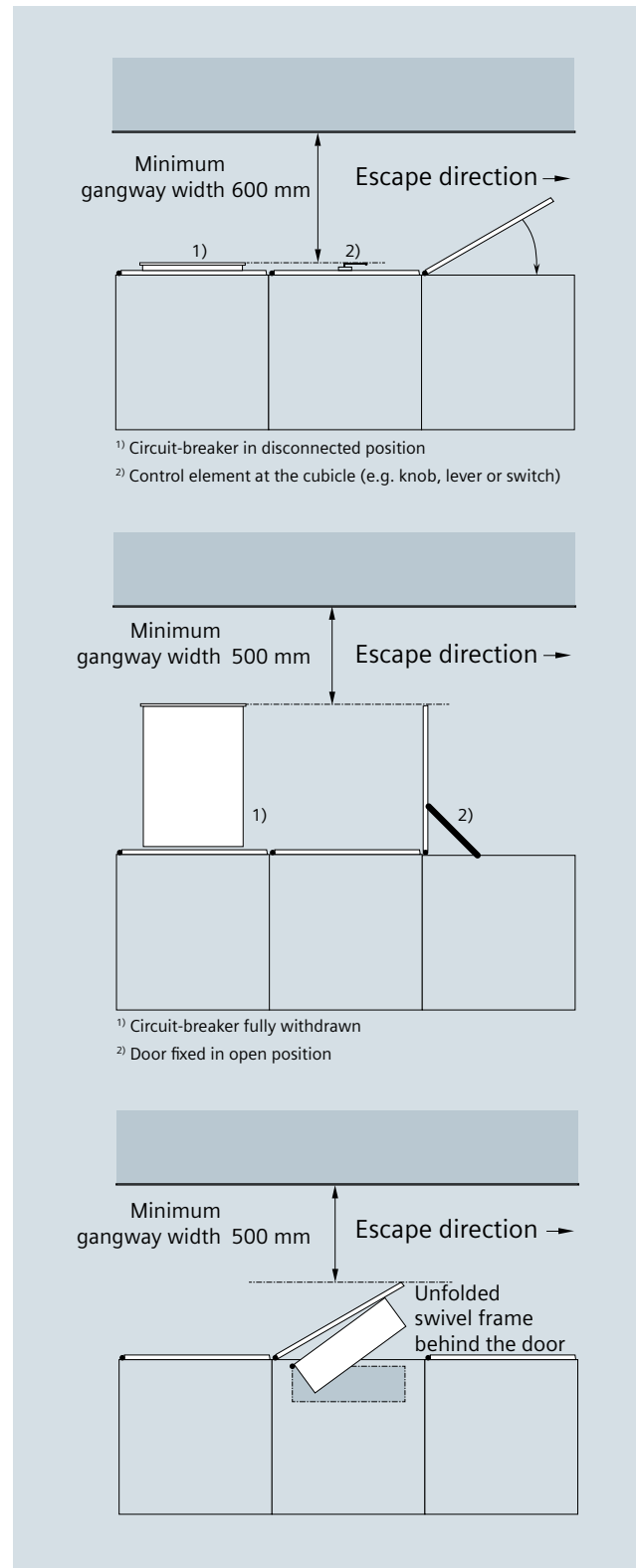

Fig. 9/3: Minimum widths of gangways in case of evacuation acc. to IEC 60364-7-729

1  
2  
3  
4  
5  
6  
7  
8  
9  
10  
11  
12

## Single-front and double-front switchboards

In the single-front switchboard, the cubicles stand next to each other in a row (Fig. 9/4 top). One or more cubicles can be combined to a transport unit. Cubicles within a transport unit have a continuous horizontal busbar. The cubicles cannot be separated.

In the double-front switchboard, the cubicles stand in a row next to and behind one another (Fig. 9/4). Double-front switchboards are only feasible with busbar position at the rear. The main characteristic of a double-front switchboard is its cost-efficient construction: The feeders on both operating fronts are supplied by one main busbar system only.

A double-front unit consists of a minimum of two and a maximum of four cubicles. The width of the double-front unit is determined by the widest cubicle (1) within the double-front unit. This cubicle can be placed at the front or rear side of the double-front unit. Up to three more cubicles (2), (3), (4) can be placed on the opposite side. The sum of the cubicle widths (2) to (4) must be equal to the width of the widest cubicle (1).

One or more double-front units can be combined to a transport unit. Cubicles within a transport unit have a continuous horizontal busbar. The cubicles cannot be separated.

Exceptions:

The following cubicles determine the width of the double-front unit and may only be combined with a cubicle for free configuration (CCS) without distribution busbar, without SED, without CEP, and without built-in ALPHA components.

- Longitudinal coupler
- Incoming / outgoing feeder with longitudinal coupler
- Incoming / outgoing feeder with bypass
- Incoming / outgoing feeder 4,000 A, cubicle width 800 mm
- Incoming / outgoing feeder 5,000 A, except cable connection
- Incoming / outgoing feeder 6,300 A.

Furthermore, the following has to be observed:

- The incoming feeder / outgoing feeder 5,000 A with cable connection opposed to the main busbar rear-bottom is only implemented as a double front and absolutely requires a special cubicle at the rear
- CCS cubicles with a cubicle width of 350 mm or 850 mm as well as corner cubicles cannot be used within double-front switchboards
- Longitudinal couplers must always be placed at the front side; otherwise, the electrical busbar interconnection is not possible. At the rear side of longitudinal couplers there must be an individual CCS cubicle of the same cubicle width as the coupler; in the case of longitudinal couplers with 5,000 A and 6,300 A, these are two CCS cubicles (cubicle width 1,400 mm).

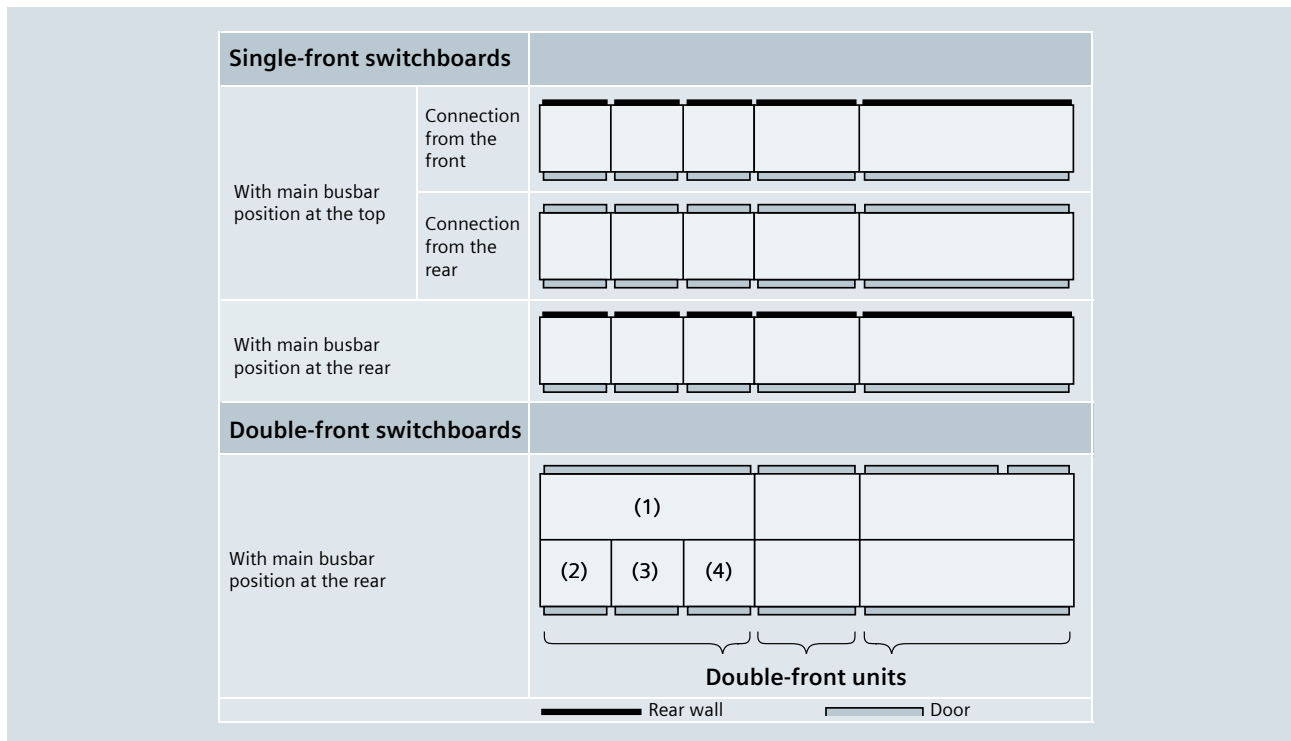

Fig. 9/4: Cubicle arrangement for single-front (top) and double-front switchboards (bottom)

## Foundation frame and floor mounting

The foundation generally consists of concrete, with a cut-out for cable or busbar entry. The cubicles are positioned on a foundation frame made of steel girders. In addition to the permissible deviations of the installation area (Fig. 9/5), it must be ensured that:

- The foundation is precisely aligned
- The joints of several foundation frames are smooth
- The surface of the frame is in the same plane as the surface of the finished floor.

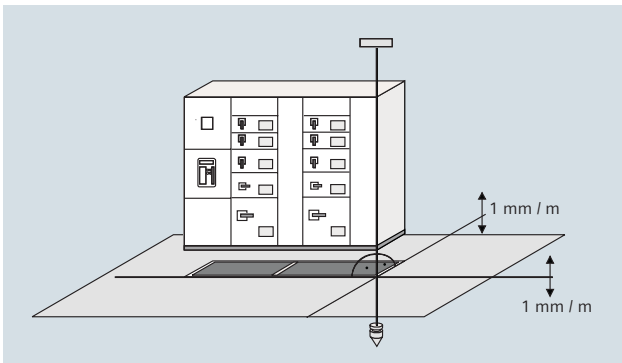

Fig. 9/5: Permissible deviations in the installation area

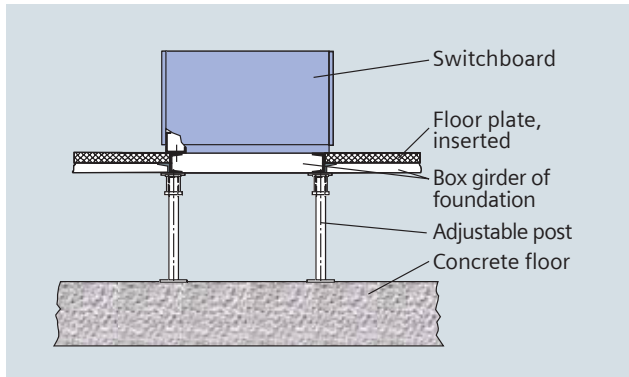

Fig. 9/6: Installation on false floors

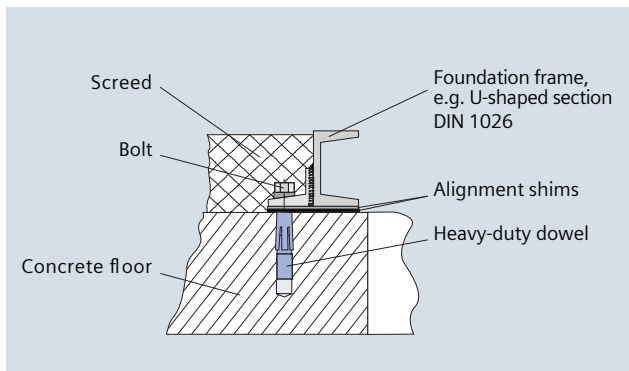

Fig. 9/7: Foundation frame fixing on concrete

Two typical examples for switchboard installation are:

- Installation on a false floor (Fig. 9/6)
- Foundation frame mounted on concrete (Fig. 9/7).

The fixing points on the foundation frame can be found in Fig. 9/8 for single-front and double-front switchboards.

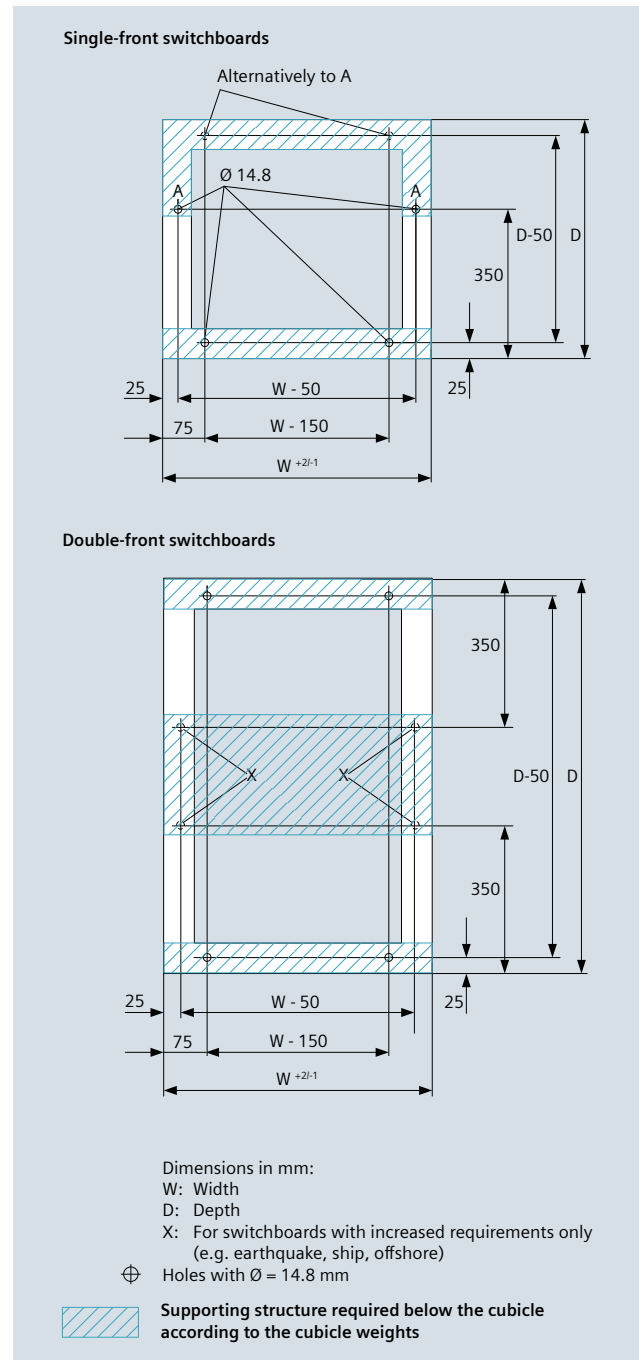

Fig. 9/8: Fixing points of single- and double-front switchboards

1  
2  
3  
4  
5  
6  
7  
8  
9  
10  
11  
12

Fig. 9/9 shows the dimensions for a corner cubicle. Dimensions in mm are referred to the cubicle width  $W$  and cubicle depth  $D$ .

### Cable entry

Depending on the busbar position and on the positioning of the cable connection, different cable entry areas are provided for the individual cubicles of the SIVACON S8. The views in Fig. 9/10 show the cable entries for busbar position at the top in single-front switchboards for cable connection from the front or from the rear, and in Fig. 9/11 those for busbar position at the rear. Fig. 9/12 shows the cable entry areas for double-front switchboards and busbar position in the center.

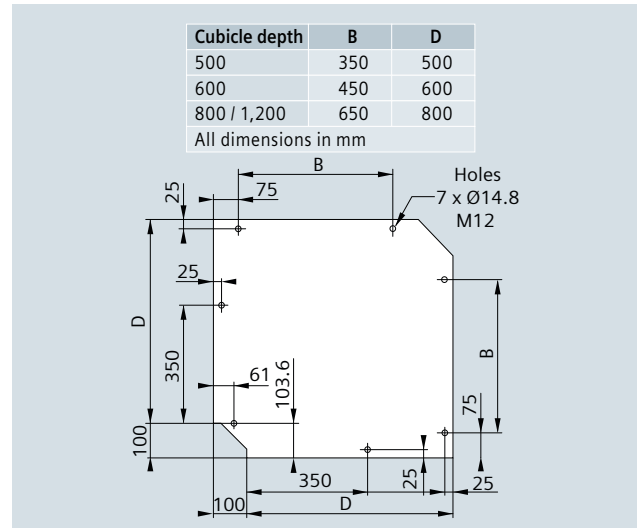

Fig. 9/9: Fixing points for the corner cubicle

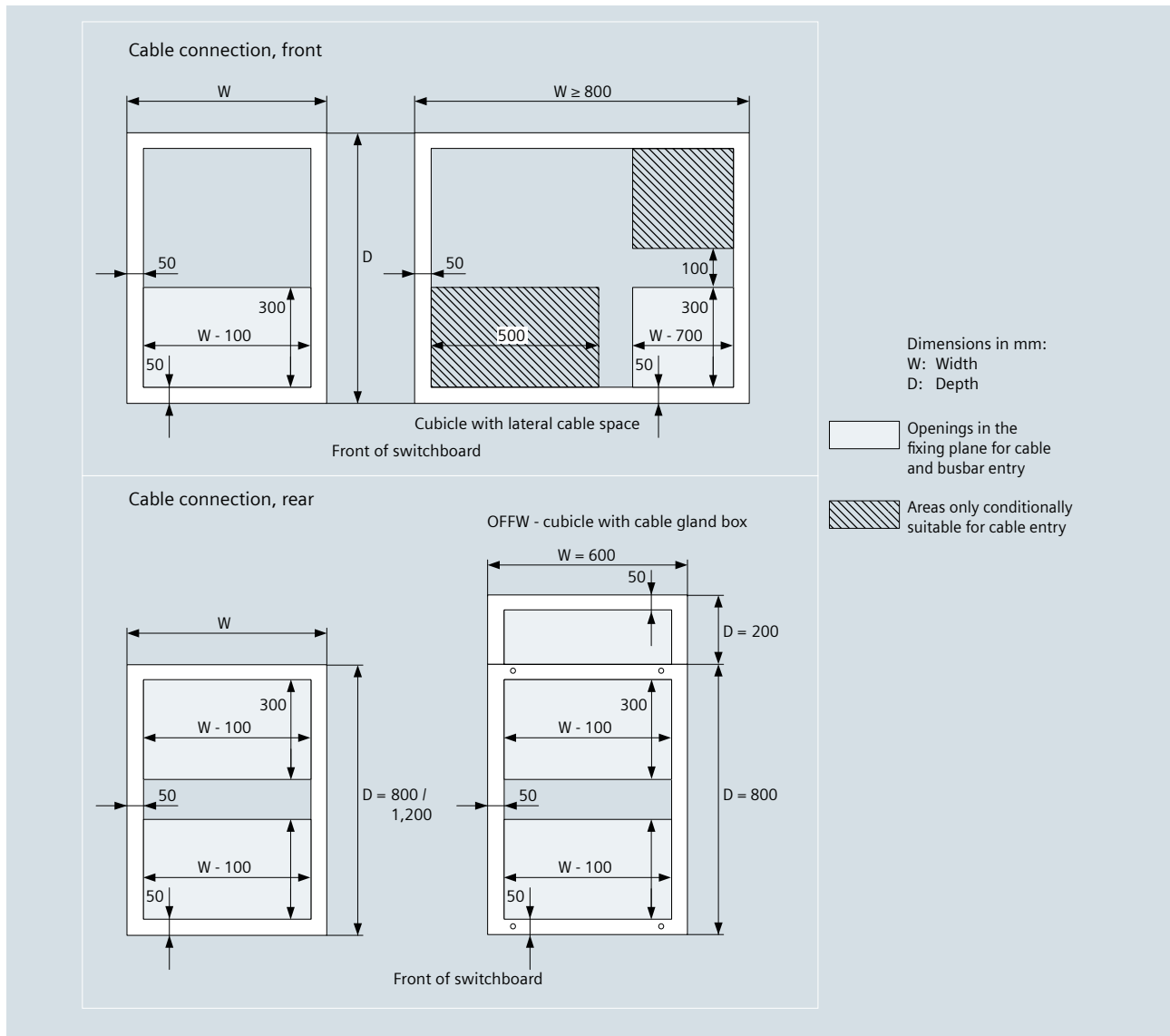

Fig. 9/10: Cable entry for cubicles with busbar position at the top



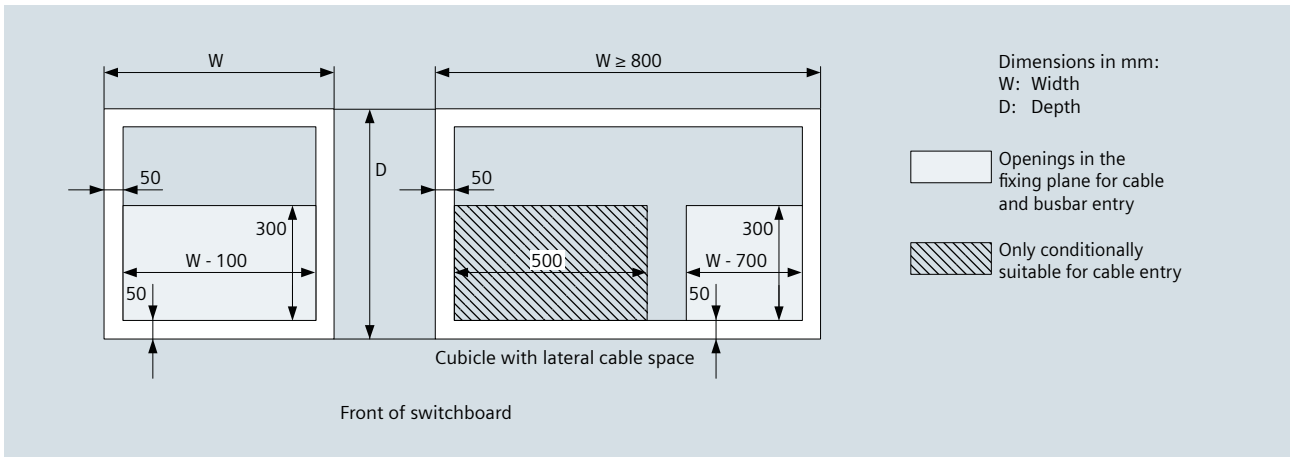

Fig. 9/11: Cable entry for cubicles with busbar position at the rear

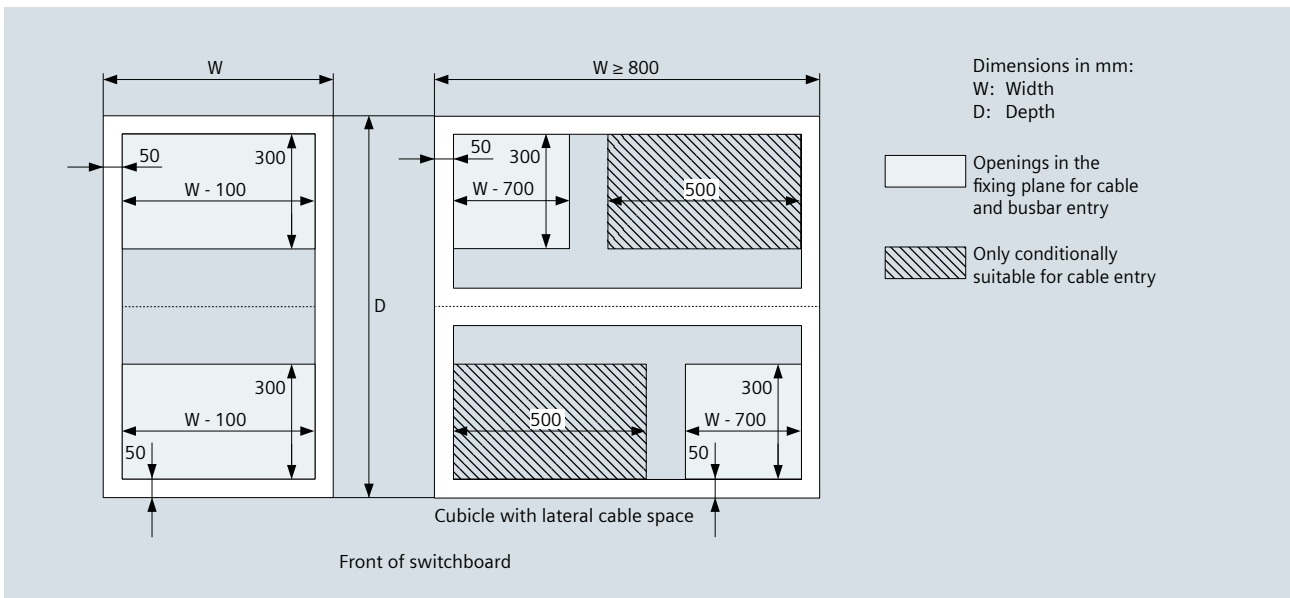

Fig. 9/12: Cable entry for double-front cubicles with busbar position in the center

## 9.2 Weights and Power Losses

Weight data in Tab. 9/1 is for orientation only. The same applies to the power losses specified in Tab. 9/2. This data represents approximate values for a cubicle with the main circuit of functional units for determination of the power loss to be dissipated from the switchboard

room. Power losses of additional auxiliary devices may also have to be taken into consideration. Further information can be obtained from your contact partner at Siemens.

Cubicle dimensions			Rated current	Average weights of the cubicles including busbar (without cables)
Height	Width	Depth		
<b>Circuit-breaker cubicles</b>				
2,200 mm	400 mm	500 mm	630 - 1,600 A	340 kg
	600 mm			390 kg
	600 mm	600 mm	2,000 - 3,200 A	510 kg
	800 mm			545 kg
	800 mm	600 mm	4,000 A	770 kg
		800 mm		
1,000 mm	800 mm	4,000 - 6,300 A	915 kg	
<b>Universal / fixed-mounted design</b>				
2,200 mm	1,000 mm	500 mm		400 kg
		600 mm		470 kg
		800 mm		590 kg
<b>In-line design, fixed-mounted</b>				
2,200 mm	600 mm	600 mm		360 kg
	800 mm	800 mm		470 kg
<b>In-line design, plug-in</b>				
2,200 mm	1,000 mm	500 mm		415 kg
		600 mm		440 kg
		800 mm		480 kg
<b>Reactive power compensation</b>				
2,200 mm	800 mm	500 mm		860 kg
		600 mm		930 kg
		800 mm		1,050 kg

Tab. 9/1: Weights (orientation values) for selected cubicles

3WA circuit-breaker design (withdrawable unit)	Power loss (approx. value) P <sub>V</sub>		3VA circuit-breaker design (withdrawable unit)	Power loss (approx. value) P <sub>V</sub>	
	100% rated oper. current	80% rated oper. current		100% rated oper. current	80% rated oper. current
3WA1106 (630 A, size I)	215 W	140 W	3VA1563 (630 A)	180 W	144 W
3WA1108 (800 A, size I)	345 W	215 W	3VA1580 (800 A)	240 W	192 W
3WA1110 (1,000 A, size I)	540 W	345 W	3VA1510 (1,000 A)	330 W	264 W
3WA1112 (1,250 A, size I)	730 W	460 W	3VA2563 (600 A)	144 W	115 W
3WA1116 (1,600 A, size I)	1,000 W	640 W	3VA2580 (800 A)	231 W	185 W
3WA1220 (2,000 A, size II)	1,140 W	740 W	3VA2510 (1,000 A)	330 W	264 W
3WA1225 (2,500 A, size II)	1,890 W	1,210 W	<b>Fixed-mounted design</b>	P <sub>V</sub> = approx. 600 W	
3WA1232 (3,200 A, size II)	3,680 W	2,500 W	<b>In-line design, fixed-mounted</b>	P <sub>V</sub> = approx. 600 W	
3WA1340 (4,000 A, size III)	4,260 W	2,720 W	<b>In-line design, plug-in</b>	P <sub>V</sub> = approx. 1,500 W	
3WA1350 (5,000 A, size III)	5,670 W	3,630 W	<b>Withdrawable design</b>	P <sub>V</sub> = approx. 600 W	
3WA1363 (6,300 A, size III)	8,150 W	5,220 W	<b>Reactive power compensation</b>	<b>Power loss (approx. value) P<sub>V</sub></b>	
			<b>Unchoked</b>	1.4 W / kvar	
			<b>Choked</b>	6.0 W / kvar	

Tab. 9/2: Power losses for SIVACON S8 cubicles (orientation values)

### 9.3 Environmental Conditions

The climate and other external conditions (natural foreign substances, chemically active pollutants, small animals) may affect the switchboard to a varying extent. The influence depends on the air conditioning equipment of the switchboard room.

According to IEC 61439-1, environmental conditions for low-voltage switchboards are classified as:

- Normal service conditions (IEC 61439-1, Clause 7.1)
- Special service conditions (IEC 61439-1, Clause 7.2).

SIVACON S8 switchboards are intended for use in the normal environmental conditions described in Tab. 9/3 and 9/4.

If special service conditions prevail (Tab. 9/5), special agreements between the switchboard manufacturer and the user must be reached. The user must inform the switchboard manufacturer about such extraordinary service conditions.

Special service conditions refer to, for example:

- Data about ambient temperature, relative air humidity and/or altitude, if this data deviates from the normal service conditions

- The occurrence of fast temperature and/or air pressure changes, so that extraordinary condensation must be expected inside the switchboard
- An atmosphere which may contain a substantial proportion of dust, smoke, corrosive or radioactive components, vapors or salt (e.g. H<sub>2</sub>S, NO<sub>x</sub>, SO<sub>2</sub>, chlorine).

The occurrence of severe vibrations and impacts is considered in Section 10.3.

In case of higher concentrations of pollutants (class > 3C2), reducing measures are required, for example:

- Air intake for the service room from a less contaminated point
- Exposing the service room to slight overpressure (e.g. injecting clean air into the switchboard)
- Air conditioning of switchboard rooms (temperature reduction, relative air humidity < 60 %, if necessary, use pollutant filters)
- Reduction of temperature rise (oversizing of switching devices or components such as busbars and distribution busbars).

Further information can be obtained from your contact partner at Siemens.

Environmental conditions	Environmental parameters	Lower limit	Upper limit	Measures
Climatic	Environmental temperature	- 5 °C	+ 40°C + 35 °C (24-h mean)	
	Relative air humidity	5 % ) <sup>1</sup>	95 % ) <sup>1</sup>	
	Speed of temperature change	0,5 °C/min		
	Installation location height above sea level	n/a	2000 m	
	Condensation	a moderate condensation caused by occasionally temperature changes is allowed		Installation of cubicle heater
	Wind-borne precipitation	No		
	Water (except rain)	See special service conditions		
	Formation of ice	No		

<sup>1)</sup> according IEC 61439-1:2020

Tab. 9/3: Normal service conditions for SIVACON S8 for indoor installation

further environmental parameters based on IEC 60721-3-3: 1994, class 3K4	Lower limit	Upper limit	Measures
Absolute air humidity	1 g/m <sup>3</sup>	29 g/m <sup>3</sup>	
Atmospheric pressure	70 kPa	106 kPa	
Sunlight	700 W/m <sup>2</sup>		
Heat radiation	none		

Tab. 9/4: Further service conditions for SIVACON S8 for indoor installation

## Conditions for transport, storage and installation

If the ambient conditions for transport, storage or installation of the switchboard deviate from the normal service conditions listed in Tab. 9/5 (for example, an excessively low or high value for temperature or air humidity), the measures required for proper treatment of the switchboard must be agreed upon between manufacturer and user.

Environmental conditions	Class ) <sup>1</sup>	Environmental parameters including their limit values Definition acc. to IEC 60721-3-3 ) <sup>1</sup>		Measures	
Chemically active substances	3C2	Sea salt	Presence of salt mist		On request
			Mean value	Limit value	
		Sulphur dioxide SO <sub>2</sub>	0.3 mg/m <sup>3</sup>	1.0 mg/m <sup>3</sup>	
		Hydrogen sulphide H <sub>2</sub> S	0.1 mg/m <sup>3</sup>	0.5 mg/m <sup>3</sup>	
		Chlorine Cl <sub>2</sub>	0.1 mg/m <sup>3</sup>	0.3 mg/m <sup>3</sup>	
		Hydrogen chloride HCl	0.1 mg/m <sup>3</sup>	0.5 mg/m <sup>3</sup>	
		Hydrogen fluoride	0.01 mg/m <sup>3</sup>	0.03 mg/m <sup>3</sup>	
		Ammonia NH <sub>3</sub>	1.0 mg/m <sup>3</sup>	3.0 mg/m <sup>3</sup>	
		Ozone O <sub>3</sub>	0.05 mg/m <sup>3</sup>	0.1 mg/m <sup>3</sup>	
		Nitrogen oxides NO <sub>x</sub>	0.5 mg/m <sup>3</sup>	1.0 mg/m <sup>3</sup>	
Further climatic conditions	> 3K4	High air temperature	> 40°C		Air-condition for cubical
	3Z1	Heat radiation is negligible			
	3Z7	Dripping water in accordance with IEC 60068-2-18			IPX1
	3Z9	Splashing water in accordance with IEC 60068-2-18			IPX4
	3B2	Flora	Presence of mold, fungus, etc.		≥ IP4X including protection towards the cable basement
		Fauna	Presence of rodents and other animals harmful to products, excluding termites		
Mechanically active substances	3S1	Sand in air	-		< IP5X
		Dust (suspension)	0.01 mg/m <sup>3</sup>		
		Dust (sedimentation)	0.4 mg/(m <sup>3</sup> ·h)		
	3S2	Sand in air	300 mg/m <sup>3</sup>		≥ IP5X
		Dust (suspension)	0.4 mg/m <sup>3</sup>		
		Dust (sedimentation)	15 mg/(m <sup>3</sup> ·h)		

)<sup>1</sup> definition for classes, environmental parameters and limit values according to IEC 0721-3-3:1994

Tab. 9/5: special service conditions for SIVACON S8

A large, industrial-grade electrical cabinet, the Siemens SIVACON, is shown. The cabinet is dark grey with a prominent vertical band on the left side. The word "SIVACON" is printed vertically in large, white, sans-serif capital letters on this band. The right side of the cabinet is open, revealing a complex internal structure with multiple horizontal busbars and several circuit breakers. Each breaker has a grey handle and a small digital display. At the bottom right, a control panel is visible, featuring a digital display and various buttons and indicators. The background is a light blue gradient with faint, semi-transparent text and graphics, including the words "KONTAKTE", "BREMSE", "SPEKTR", "CONTACTS", "READY", "AUS", "OPEN", "PUSH", and the "SIEMENS" logo.

SIVACON

# Chapter 10

## Conformance to Standards and Design Verification

10.1	Product Standard IEC 61439-2	107
10.2	Arc Resistance	108
10.3	Seismic Withstand Capability and Seismic Requirements	112
10.4	Declarations of Conformity and Certificates	114

# 10 Conformance to Standards and Design Verification

## 10.1 Product Standard IEC 61439-2

Low-voltage switchboards, or power switchgear and controlgear assemblies according to the standard, are developed and manufactured according to the stipulations of IEC 61439-2, and their compliance with the standard is verified. In order to provide evidence that the switchboard is fit for purpose, this standard requests two main forms of verification – design verifications and routine verifications.

Design verifications are tests carried out during the development process and are the responsibility of the original manufacturer (developer). Routine verifications must be performed by the manufacturer of the power switchgear and controlgear assembly (original equipment manufacturer) on every manufactured switchboard prior to delivery.

### Design verification test

The SIVACON S8 low-voltage switchboard offers safety for personnel and equipment by means of design verification (Tab. 10/1) with tests according to IEC 61439-2. Its physical properties are rated in the test area both for operating and failure situations and ensure maximum

personnel and switchboard safety. Design verifications as well as routine verifications are a decisive part of quality assurance, and the prerequisite for CE marking according to the EU directives and laws.

### Verification of temperature rise

One of the most important verifications is the "verification of temperature rise". Thereby it is verified that the switchboard is fit for purpose when the temperature rises due to power loss. In view of the ever increasing rated currents, together with higher requirements relating to the degree of protection and internal separation, this is one of the greatest challenges for the switchboards. According to the standard, this verification can be performed by calculation up to a rated current of 1,600 A. For SIVACON S8, this verification is always performed by testing. Rules governing the selection of the test specimens (worst-case test), as well as the testing of complete switchgear and controlgear assemblies, ensure that the entire product range is systematically covered and that this verification always includes the devices. This means that testing randomly selected test specimens suffices just as little as replacing a device without repeating the test.

The table shows all verifications required by the standard. They can be delivered by three alternative possibilities.	Verification by means of test	Verification by means of calculation	Verification by means of design rules
1. Strength of materials and parts	✓	-	-
2. Degree of protection of enclosures	✓	-	✓
3. Clearances and creepage distances	✓	✓	✓
4. Protection against electric shock and consistency of protective conductor circuits	✓	✓ <sup>1)</sup>	✓ <sup>1)</sup>
5. Installation of operational equipment	-	-	✓
6. Internal electrical circuits and connections	-	-	✓
7. Connections for conductors inserted from outside	-	-	✓
8. Insulation properties	✓	-	✓ <sup>2)</sup>
9. Temperature-rise limits	✓	Up to 1,600 A	Up to 630 A <sup>3)</sup>
10. Short-circuit withstand strength	✓	Conditionally <sup>3)</sup>	Conditionally <sup>3)</sup>
11. Electromagnetic compatibility (EMC)	✓	-	✓
12. Mechanical function	✓	-	-

<sup>1)</sup> Effectiveness of the switchgear and controlgear assembly in case of external faults  
<sup>2)</sup> Only impulse strength  
<sup>3)</sup> Comparison with an already tested design

Tab. 10/1: Tests for design verification according to IEC 61439-1 and IEC 61439-2

## 10.2 Arc resistance

Even though arc faults rarely occur in design verified low-voltage switchboards, their effects are still grave, as they can cause serious personal injury and equipment damage, and produce high downtime costs. Caused, for example, by foreign objects, pollution, animals, or incorrect work operations, an arc fault releases a high amount of energy with extreme heat development and a pressure wave within a short period of time.

To minimize these risks, SIVACON S8 provides a comprehensive, modular arc fault protection concept (Fig. 10/1). The following two principles apply to all measures defined for the protection of personnel and switchboard:

1. Preventing arc faults
2. Keeping the effects of residual risks from an arc fault as low as possible

- Common measures to avoid arc faults are, for example:
- Constructional measures (Fig. 10/2) whose function is proved by a design verification according to IEC 61439-2
  - Application-conforming dimensioning of the switchgear and controlgear assembly already during the planning phases (dimensioning and engineering tools such as the SIMARIS Suite simplify this task)
  - Form of internal separation (see IEC 61439-2) as protection against access to hazardous parts or ingress of solid foreign objects
  - Insulation of conductors, partitions and shutters, as well as their testing for protection against hazardous electrical effects (Fig. 10/3)
  - Uniform operation concept, adequate protective equipment and tools, as well as appropriate training of the operators.



Fig. 10/1: Tasks and objectives of the arc fault protection

Measures to mitigate the effects of arc faults are, for example:

- Pressure relief measures and suitable dimensioning of the enclosure
- Arc barriers (Fig. 10/2)
- Systems for arc detection and arc quenching
- Constructional limitation of the arc fault effects to defined areas with verification by test in accordance with IEC/TR 61641
- Distance extension by remote operation instead of operation directly in front of the equipment
- Material strength of the enclosure parts, quality of the locking system
- Use of suitable fuses in combination with switching devices to limit the short-circuit current and the fault duration (already supported in the planning phases by a dimensioning tool such as SIMARIS design)
- Racking of the contact system of a withdrawable unit to or from service position only with closed front door
- Personal protective equipment and training of operators.

If the switchgear and controlgear assembly is supplied by a transformer, an arc duration of 300 ms should be considered in order to enable disconnection by a high-voltage protection device.

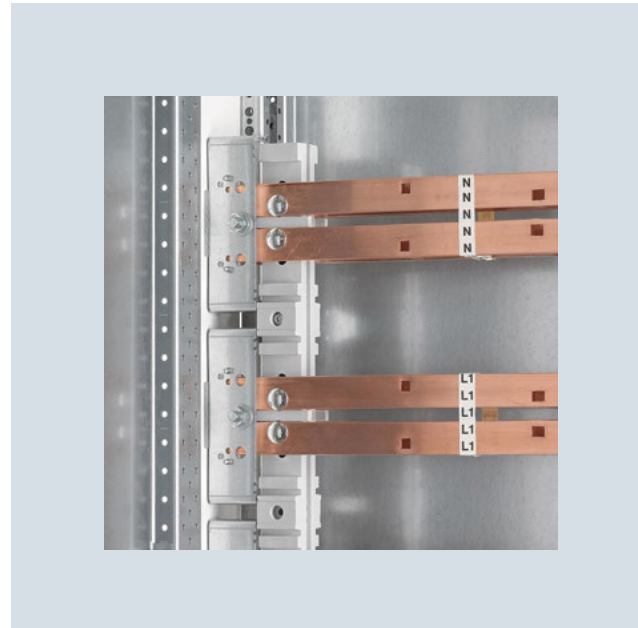

Fig. 10/2: Arc barrier in SIVACON S8



## Verification of functionality in the event of an arc fault

The test under conditions of arcing due to an internal fault is done according to IEC/TR 61641. For the evaluation of test results, criteria are applied which are summarized in arcing classes (Tab. 10/2).

### Passive arc fault protection

The principle of a passive arc fault protection is based on preventing the occurrence of an arc fault. The use of insulating materials (e.g. Teroson), which are wrapped around live bare conductors (Fig. 10/3), of covers, shutters, etc. prevents the development of parallel arcs. Depending on the requested availability, this principle can be applied in several steps, from limiting the effects of an arc fault in a cubicle, through their limitation to a functional compartment, and up to their limitation to the place of origin.

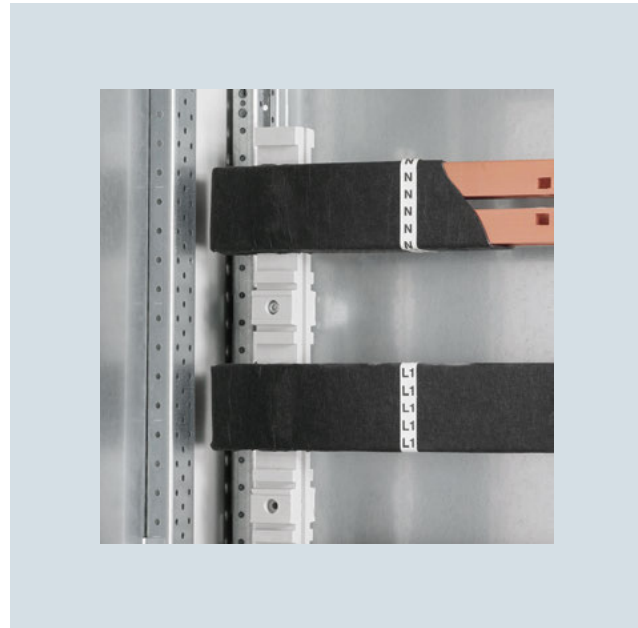

Fig. 10/3: Insulated main busbar in the SIVACON S8 (N insulation optional)

Criteria		Arcing class		
1	Doors and covers do not open	<b>Arcing class A</b> <b>Personnel protection</b>  The arc fault is confined to the area within the switchgear and controlgear assembly  <b>A</b>	<b>Arcing class B</b> <b>Personnel and switchboard protection</b>  The arc fault is confined to a defined area within the switchgear and controlgear assembly  <b>B</b>	<b>Arcing class C</b> <b>Personnel and switchboard protection</b>  The arc fault is confined to a defined area within the switchgear and controlgear assembly. Limited operation is possible after the fault.  <b>C</b>
2	No parts of the switchgear and controlgear assembly are ejected			
3	No holes as a result of an arc fault burning through the external parts of the enclosure declared to be freely accessible			
4	The indicators do not ignite; limited access for authorized personnel in work clothes (cretonne 150 g/m <sup>2</sup> )			
	The indicators do not ignite; unlimited access for untrained or unskilled persons in light summer clothes (batiste 40 g/m <sup>2</sup> )			
5	The protective conductor circuit for accessible parts of the enclosure is still effective			
6	The arc fault is limited to the defined area of the switchgear and controlgear assembly			
7	Emergency operation of the remaining switchgear and controlgear assembly is possible after the fault has been cleared and/or affected functional units have been disconnected or removed			

Tab. 10/2: Characteristics under conditions of internal arcing and classification according to IEC/TR 61641

## Active arc fault protection

An arc fault causes a flash of light which is detected by an optical sensor (Fig. 10/4). At the same time, the current transformers register a quick current increase. Both events are reported to an internal arc fault control device (IACD) and, if they occur simultaneously, they are recognized as an arc fault. The energy converted in an internal arc fault is reduced by tripping the arc quenching device (AQD) (Fig. 10/5) and the incoming circuit-breaker. By tripping the AQD, a low-impedance current path is established. The residual current / short-circuit current flows along this path and withdraws energy from the arc. This current path is maintained until the incoming circuit-breaker interrupts the short-circuit current (Fig. 10/6).

The active arc fault protection system reduces the energy converted during an arc fault, and thus additionally mitigates the effects on the low-voltage switchgear and controlgear assemblies. The integration and testing of the active arc fault protection system of SIVACON S8 is done according to IEC/TS 63107 with the following objectives:

- Correct functioning of all components of the active arc fault protection system within the low-voltage switchgear and controlgear assembly
- Prevention of false tripping, for example by switching arcs from open circuit-breakers
- Test of the lower and maximum tripping threshold (smallest and maximum residual current)
- Behavior of the system immediately after switching on.

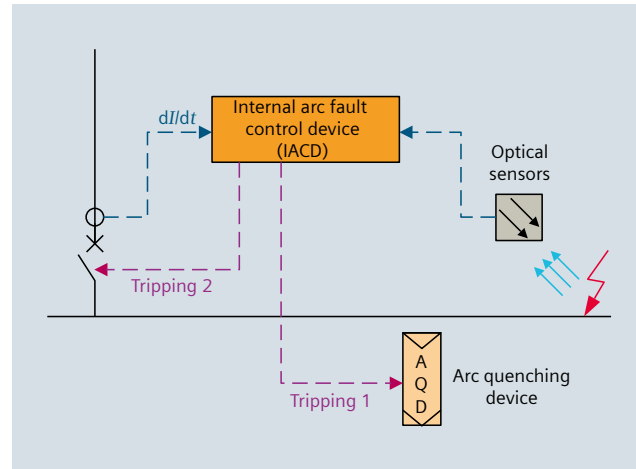

Fig. 10/4: Function of the active arc fault protection for SIVACON S8



Fig. 10/5: AQD systems (AQ 100 and DEHNshort) for SIVACON S8

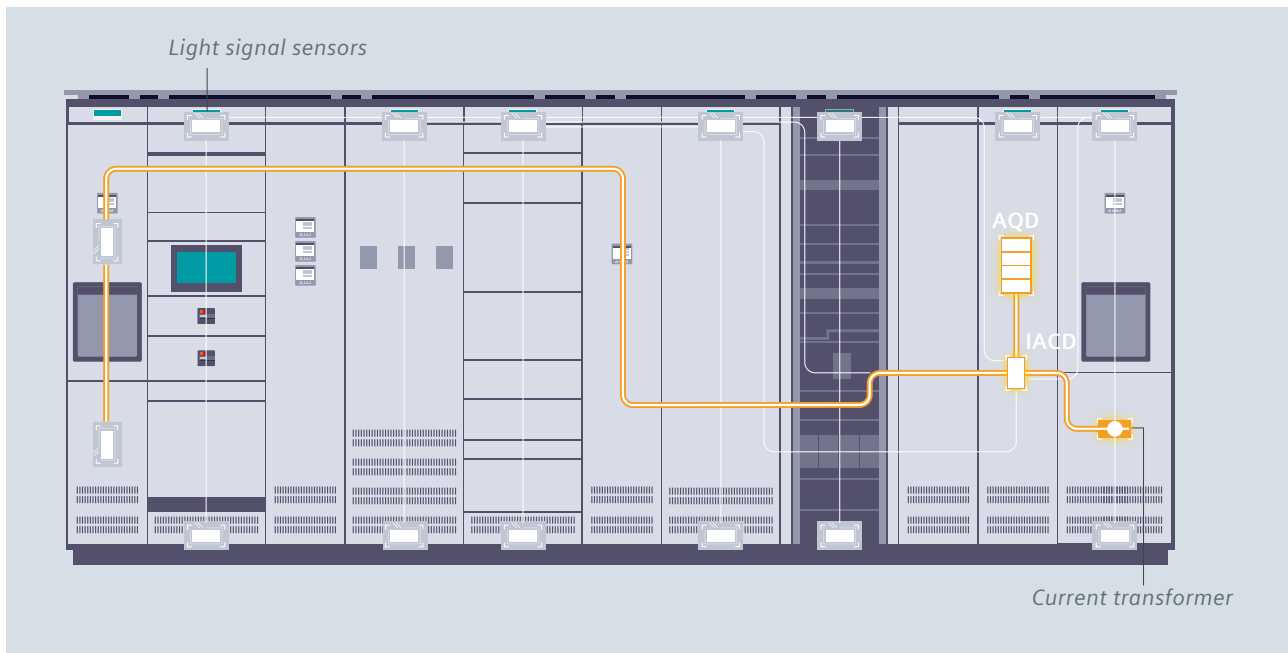

Fig. 10/6: Design of the arc fault protection system in SIVACON S8

## 10.3 Seismic Withstand Capability and Seismic Requirements

The SIVACON S8 low-voltage switchboard is available in earthquake-proof design for seismic requirements. The tests examine its operability and stability during and after an earthquake. The results of the seismic tests are divided into three categories according to Tab. 10/3.

### Test specifications

- IEC 60068-3-3, English version from 1993: Environmental testing; seismic test methods for equipments; guidance
- IEC 60068-2-6, English version from 2008: Environmental testing: Tests - Test Fc: Vibration (sinusoidal)
- IEC 60068-2-57, English version from 2015: Environmental testing: Tests - Test Ff: Vibration - Time-history and sine-beat method
- KTA 2201.4, 2000: Design of Nuclear Power Plants against Seismic Events
- IEC 60980, 1989: Recommended practices for seismic qualification of electrical equipment of the safety system for nuclear generating stations
- UBC, Uniform Building Code, 1997: Chapter 16, Division IV.

Testing is performed in three axes with independently generated time histories in three axes in accordance with IEC 60068-2-57.

<b>Category 1: Operability during the earthquake</b>	$\alpha_f = 0.6 \text{ g (ZPA)}$
<b>Category 2: Operability after the earthquake</b>	$\alpha_r = 0.75 \text{ g (ZPA)}$
<b>Category 3: Stability</b>	$\alpha_f = 1.06 \text{ g (ZPA)}$
$\alpha_f$ = floor acceleration (acceleration in the mounting plane of the switchboard) ZPA = zero period acceleration g = ground acceleration = 9.81 m/s <sup>2</sup>	

Tab. 10/3: SIVACON S8 system characteristics under earthquake conditions

### Acceleration values

There is a simple interrelation between floor acceleration  $a_f$  and local ground acceleration  $a_g$ :

$$a_f = K \cdot a_g$$

with amplification factor K according to Tab. 10/4. Ground acceleration depends on the local seismic conditions.

If the switchboard is installed at ground level and directly on the ground-level foundation, this acceleration factor – provided that there are no further specifications – can be regarded as the acceleration which acts on the mounting plane of the switchboard ( $K = 1$ ,  $a_f = a_g$ ).

Depending on how the switchgear and controlgear assembly is fastened, an amplification of the ground acceleration becomes effective. This dependency is taken into account with the amplification factor K (Tab. 10/4).

If there is no information about the floor acceleration or the installation of the switchboard,  $K = 2$  is applied, meaning double the value of the specified ground acceleration is regarded as the stress the switchboard will be exposed to.

If there are no specifications regarding the directional assignment of the acceleration parameters, the values are referred to the horizontal directions (x, y). Conforming to international standards, the vertical accelerations are lower and are usually factored in with 0.5 to 0.6 times the horizontal acceleration.

K factor	Fixing of the switchboard
1.0	On rigid foundations or supporting structure of high stiffness
1.5	Rigidly connected with the building
2.0	On stiff supporting structure which is rigidly connected with the building
3.0	On supporting structure of low stiffness, connected with the building

Tab. 10/4: Acceleration factor K for SIVACON S8

## Comparison of seismic requirements

There are numerous international and national standards referring to the classification of seismic requirements. Classification varies greatly in these documents. For this reason, the specification of an earthquake zone always requires reference to the relevant standard or classification. With regard to the requirements placed on SIVACON S8 switchboards, it is therefore advantageous to specify the floor acceleration. Or, if this information is not available, the ground acceleration in the vicinity of the building accommodating the installation should be given. Fig. 10/7 shows the relation of the seismic categories 1, 2 and 3 from Tab. 10/3 to the known earthquake classifications and seismic scale divisions.

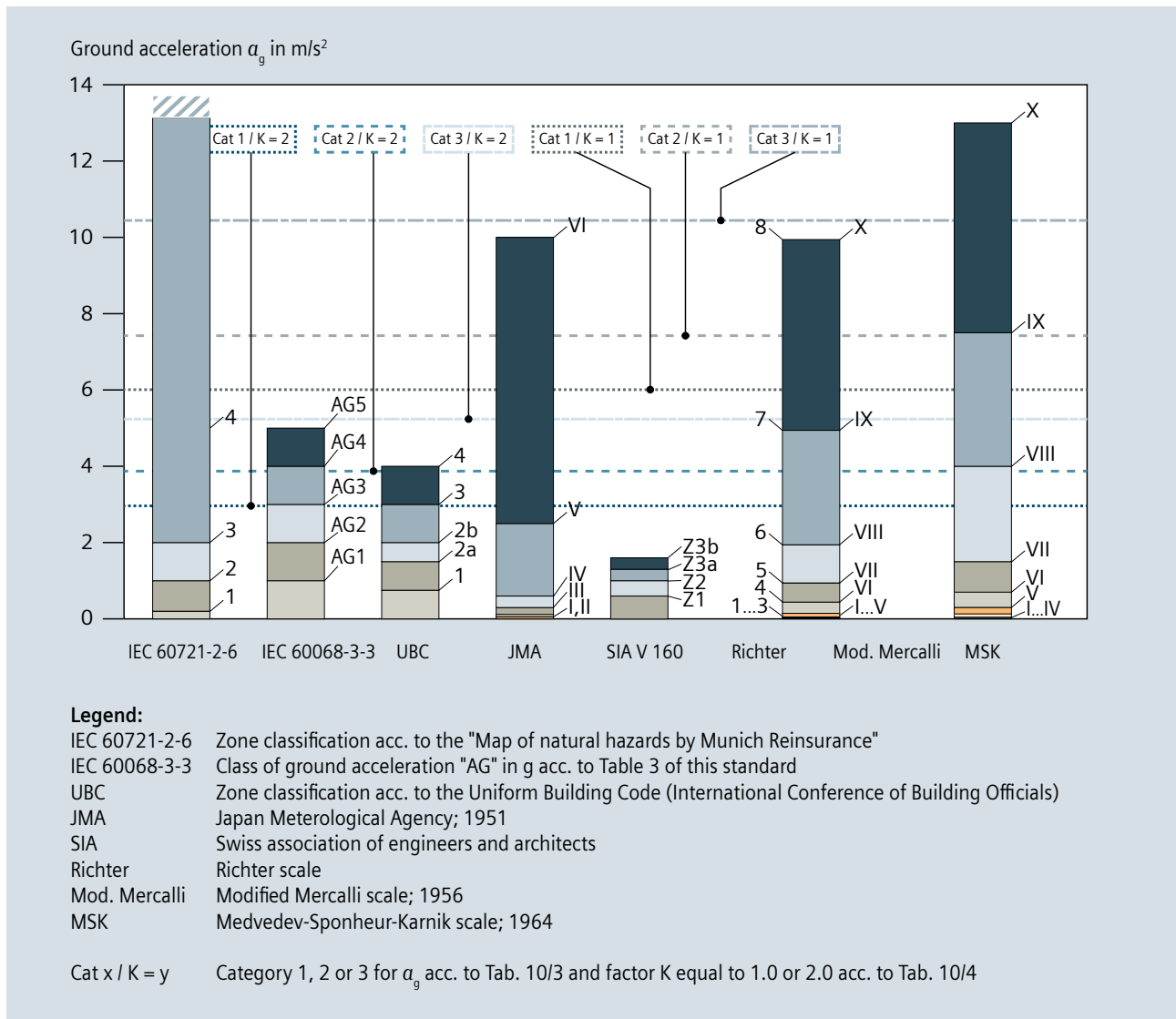

Fig. 10/7: Comparison of seismic scales for the classification of seismic response categories of SIVACON S8

## 10.4 Declarations of Conformity and Certificates

With a Declaration of Conformity, the manufacturer of the low-voltage switchboard confirms that the requirements of the directive or standard referred to in this declaration have been fulfilled.

Further information about such declarations of conformity and certificates (Fig. 10/8 to Fig. 10/11 are examples of such documents) can be obtained from your contact partner at Siemens.

### CE marking and EU declaration of conformity

The CE marking is a label affixed under the sole responsibility of the manufacturer. The declaration of conformity confirms compliance of products with the relevant basic requirements of all Directives of the European Union (EU) applicable to this product.

Low-voltage switchboards – named power switchgear and controlgear assemblies in the product standard IEC 61439-2 – must comply with the requirements of the Low Voltage Directive 2014/35/EU and the EMC Directive 2014/30/EU. The CE marking is a mandatory condition for placing products on the markets of the entire European Union. The associated declarations of conformity for the SIVACON S8 low-voltage switchboard can be found on the following pages.

### UKCA marking

Since January 2021, the UKCA Conformity Assessed is requested in Great Britain instead of the CE marking. The UKCA marking substitutes the CE marking requirements for products put into circulation in Great Britain. The marking proves that the SIVACON S8 meets the conformity requirements of the British market. The conformity assessment procedures for Great Britain and the underlying technical rules (EN Standards) that must be used for verification of the conformity correspond to those of the CE certification to a large extent.

1

2

3

4

5

6

7

8

9

10

11

12

## EU-Konformitätserklärung / EU Declaration of Conformity

Nr./No. EC 0002.05de

Produktbezeichnung: Niederspannungs-Schaltgerätekombination SIVACON S8 .....  
*Product identification* Low-voltage switchgear and controlgear assembly SIVACON S8 .....  
 Hersteller: Siemens AG / SI DS .....  
*Manufacturer* .....  
 Anschrift: Mozartstrasse 31 C .....  
*Address* D-91052 Erlangen .....

Die alleinige Verantwortung für die Ausstellung dieser Konformitätserklärung trägt der Hersteller.

*This declaration of conformity is issued under the sole responsibility of the manufacturer.*

Der oben beschriebene Gegenstand der Erklärung erfüllt die einschlägigen Harmonisierungsrechtsvorschriften der Union:

*The object of the declaration described above is in conformity with the relevant Union harmonisation legislation:*

**Niederspannungsrichtlinie:**

**Low Voltage Directive:**

2014/35/EU Richtlinie des Europäischen Parlaments und des Rates vom 26. Februar 2014 zur Harmonisierung der Rechtsvorschriften der Mitgliedstaaten über die Bereitstellung elektrischer Betriebsmittel zur Verwendung innerhalb bestimmter Spannungsgrenzen auf dem Markt; Amtsblatt der EU L96, 29/03/2014, S. 357–374

2014/35/EU Directive of the European Parliament and of the Council of 26 February 2014 on the harmonisation of the laws of the Member States relating to the making available on the market of electrical equipment designed for use within certain voltage limits; Official Journal of the EU L96, 29/03/2014, p. 357–374

**EMV-Richtlinie:**

**EMC Directive:**

2014/30/EU Richtlinie des Europäischen Parlaments und des Rates vom 26. Februar 2014 zur Harmonisierung der Rechtsvorschriften der Mitgliedstaaten über die elektromagnetische Verträglichkeit; Amtsblatt der EU L96, 29/03/2014, S. 79–106

2014/30/EU Directive of the European Parliament and of the Council of 26 February 2014 on the harmonisation of the laws of the Member States relating to electromagnetic compatibility; Official Journal of the EU L96, 29/03/2014, p. 79–106

Die Übereinstimmung des bezeichneten Produkts mit den Vorschriften der angewandten Richtlinie(n) wird nachgewiesen durch die Einhaltung folgender Normen / Vorschriften:

*The conformity of the product described above with the provisions of the applied Directive(s) is demonstrated by compliance with the following standards / regulations:*

Harmonisierte Normen, sonstige technische Normen, Spezifikationen / Harmonised standards, other technical standards, specifications:

Referenznummer <i>Reference number</i>	Ausgabedatum <i>Date of issue</i>	Referenznummer <i>Reference number</i>	Ausgabedatum <i>Date of issue</i>
EN 61439-2 .....	2011 .....	IEC 61439-2 Ed. 2.0 .....	2011-08 .....
.....	.....	VDE 0660-600-2 .....	Juni 2012 .....
.....	.....	.....	.....

Untersignet für und im Namen von / Signed for and on behalf of:

Siemens Aktiengesellschaft

Leipzig 14.08.2019  
 Ort / place Datum der Ausstellung / Date of issue

Dr. Franke, Head of Development SI\_DS R&D LVS  
 Name, Funktion / name, function Unterschrift / signature

Piot, Head of Product Management SI\_DS S PLM-LVSB  
 Name, Funktion / name, function Unterschrift / signature

Diese Erklärung bescheinigt die Übereinstimmung mit den genannten Richtlinien, ist jedoch keine Beschaffenheits- oder Haltbarkeitsgarantie. Die Sicherheitshinweise der mitgelieferten Produktdokumentation sind zu beachten.

*This declaration is an attestation of conformity with the indicated Directive(s) but does not imply any guarantee of quality or durability. The safety instructions of the accompanying product documentation shall be observed.*

Siemens Aktiengesellschaft: Vorsitzender des Aufsichtsrats: Jim Hagemann Snaab; Vorstand: Joe Kaeser, Vorsitzender, Roland Busch, Lisa Davis, Klaus Helmrich, Janina Kugel, Cedrik Neike, Michael Sen, Ralf P. Thomas; Sitz der Gesellschaft: Berlin und München, Deutschland; Registergericht: Berlin Charlottenburg, HRB 12300, München, HRB 6684; WEEE-Reg.-Nr. DE 23691322

Fig. 10/8: EU Declaration of Conformity for SIVACON S8 in respect of the Low Voltage and EMC Directives

## Konformitätserklärung

*Declaration of Conformity*

Nr. **EK 0030.01de**  
No.

**Siemens AG / EM MS**

Wir \_\_\_\_\_  
We (Name des Herstellers / manufacturer's name)

**Mozartstrasse 31 C**  
**D-91052 Erlangen**

(Anschrift / address)

erklären in alleiniger Verantwortung, daß das (die) Produkt(e)  
declare under our sole responsibility that the product(s)

**SIVACON S8**  
**Niederspannungs-Schaltgerätekombination**  
**SIVACON S8**  
**Low-voltage switchgear and controlgear assembly**

(Bezeichnung, Typ oder Modell /  
name, type or model)

mit folgenden normativen Dokumenten übereinstimmt (übereinstimmen);  
is (are) in conformity with the following normative documents:

**IEC 61439-2 Edition 2.0 2011-08**  
**EN 61439-2:2011**  
**VDE 0660-600-2 Juni 2012**

(Titel und/oder Nr. sowie Ausgabedatum odes normativen Dokumentes /  
Title and/or number and date of issue of thenormative document)

**Bauartnachweise nach Kapitel 10 der oben**  
**genannten Normen (siehe Anlage)**  
**Design verifications according to chapter 10 of the above**  
**mentioned standards (see annex)**

Diese Konformitätserklärung entspricht der Europäischen Norm EN ISO/IEC 17050-1 "Konformitätsbewertung - Konformitätserklärung von Anbietern - Teil 1: Allgemeine Anforderungen". Diese Erklärung bescheinigt die Übereinstimmung des Produktes in der von uns in Verkehr gebrachten Ausführung mit den genannten Richtlinien, ist jedoch keine Beschaffenheits- oder Haltbarkeitsgarantie nach §443 BGB. Die Sicherheitshinweise dier mitgelieferten Produktdokumentation sind zu beachten.

*This Declaration of Conformity is in compliance with the European Standard EN ISO/IEC 17050-1 "Conformity assessment - Supplier's declaration of conformity - Part 1: General requirements". This declaration certifies the conformity of the product as delivered to the specified directives but does not imply any warranty for properties. The safety instructions of the accompanying product documentation shall be observed.*

Siemens Aktiengesellschaft

Leipzig 20.11.2014  
Ort / place of issue Datum / Date of issue

Franke \_\_\_\_\_  
Name / name Unterschrift / signature

Ulbrich \_\_\_\_\_  
Name / name Unterschrift / signature

Head EM MS R&D LVS  
Funktion / function

Head EM MS S PLM SB  
Funktion / function

Siemens Aktiengesellschaft; Vorsitzender des Aufsichtsrats: Gerhard Cromme; Vorstand: Joe Kaeser, Vorsitzender; Roland Busch, Lisa Davis, Klaus Helmrich, Hermann Requardt, Siegfried Russwurm, Ralf P. Thomas  
Sitz der Gesellschaft: Berlin und München, Deutschland; Registergericht: Berlin Charlottenburg, HRB 12300, München, HRB 6684  
WEEE-Reg.-Nr. DE 23691322

K00S10021A41 500 000 11 09 171323

Fig. 10/9: Declaration of Conformity for SIVACON S8 regarding design verification

## Anlage zur Konformitätserklärung

Annex to Declaration of Conformity

Nr. **EK 0030.01de**  
No.

Seite **1/2**  
Page

**Durchgeführte Bauartnachweise nach IEC 61439-2 / EN 61439-2 / VDE 0660-600-2:**  
**Design verifications performed according to IEC 61439-2 / EN 61439-2 / VDE 0660-600-2:**

10.2.2	Korrosionsbeständigkeit Resistance to corrosion
10.2.3.2	Nachweis der Widerstandsfähigkeit von Isolierstoffen gegen außergewöhnliche Wärme und Feuer aufgrund von inneren elektrischen Wirkungen Verification of the resistance of insulating materials to abnormal heat and fire due to internal electric effects
10.2.5	Anheben Lifting
10.2.6	Schlagprüfung Mechanical impact
10.2.7	Aufschriften Marking
10.3	Schutzart von Gehäusen Degree of protection of ASSEMBLIES
10.4	Luft- und Kriechstrecken Clearances and creepage distances
10.5.2	Durchgängigkeit der Verbindung zwischen Körpern der Schaltgerätekombination und Schutzleiterkreis Effective earth continuity between the exposed conductive parts of the ASSEMBLY and the protective circuit
10.5.3	Kurzschlussfestigkeit des Schutzleiterkreises Short-circuit withstand strength of the protective circuit
10.6	Einbau von Betriebsmitteln Incorporation of switching devices and components
10.7	Innere elektrische Stromkreise und Verbindungen Internal electrical circuits and connections
10.8	Anschlüsse für von außen eingeführte Leiter Terminals for external conductors
10.9.2	Betriebsfrequente Spannungsfestigkeit Power-frequency withstand voltage
10.9.3	Stoßspannungsfestigkeit Impulse withstand voltage
10.10	Nachweis der Erwärmung Verification of temperature rise
10.11	Kurzschlussfestigkeit Short-circuit withstand strength
10.12	Elektromagnetische Verträglichkeit (EMV) Electromagnetic compatibility (EMC)
10.13	Mechanische Funktion Mechanical operation

H30-5102-N41 600 000 11 09 171323

Fig. 10/10: Declaration of Conformity for SIVACON S8 regarding design verification – Annex Page 1/2



## Anlage zur Konformitätserklärung

Annex to Declaration of Conformity

Nr. **EK 0030.01de**  
No.

Seite **2/2**  
Page

### Anmerkungen: Remarks:

Die einzelnen Nachweise sind jeweils in einem Typprüfbericht dokumentiert. Diese Typprüfberichte liegen beim Hersteller vor.

Each of the individual verifications is documented in a type test report. These type test reports are available at the manufacturer.

Nachweise der Wärmebeständigkeit von Gehäusen nach Kapitel 10.2.3.1 sind nur für Gehäuse aus Isolierstoffen erforderlich. Die Gehäuse von SIVACON S8 bestehen aus beschichtetem Stahlblech.

Verification of the thermal stability of enclosures according to clause 10.2.3.1 is only required for enclosures manufactured from insulating material. The enclosures of SIVACON S8 are manufactured from coated sheet steel.

Nachweise der Beständigkeit gegen ultra-violette (UV-)Strahlung nach Kapitel 10.2.4 sind nur für Gehäuse für Freiluftaufstellung erforderlich. SIVACON S8 ist ausschließlich für Innenraumaufstellung vorgesehen.

Verification of the resistance to ultra-violet (UV) radiation according to clause 10.2.4 is only required for enclosures intended to be installed outdoors. SIVACON S8 is only intended for indoor installations.

EMV-Prüfungen sind nicht erforderlich, wenn die Anforderungen der oben genannten Normen, Abschnitt J.9.4.2 a) und b), eingehalten werden.

No EMC tests are required if the conditions of clause J.9.4.2 a) and b) of the above mentioned standards are fulfilled.

Siemens Aktiengesellschaft

Leipzig 20.11.2014  
Ort / place of issue Datum / Date of issue

Franke  
Name / name Unterschrift / signature

Head EM MS R&D LVS  
Funktion / function

Ulbrich  
Name / name Unterschrift / signature

Head EM MS S PLM SB  
Funktion / function

Siemens Aktiengesellschaft: Vorsitzender des Aufsichtsrats: Gerhard Cromme; Vorstand: Joe Kaeser, Vorsitzender; Roland Busch, Lisa Davis, Klaus Helmrich, Hermann Requardt, Siegfried Russwurm, Ralf P. Thomas  
Sitz der Gesellschaft: Berlin und München, Deutschland; Registergericht: Berlin Charlottenburg, HRB 12300, München, HRB 6684  
WEEE-Reg.-Nr. DE 23691322

H3051002AN41 500 000 11 08 171323

Fig. 10/11: Declaration of Conformity for SIVACON S8 regarding design verification – Annex Page 2/2





# Chapter 11

## Technical Annex

11.1	Network Systems According to the Type of Earth Connection	121
11.2	Loads and Dimensioning	124
11.3	Degrees of Protection According to IEC 60529	126
11.4	Forms of Internal Separation According to IEC 61439-2	127
11.5	Operating Currents of Three-Phase Asynchronous Motors	128
11.6	Three-Phase Distribution Transformers	129

# 11 Technical Annex

## 11.1 Network Systems According to the Type of Earth Connection

The network systems according to the type of connection to earth considered for power distribution are described in the IEC 60364-1 standard. The type of connection to earth must be selected carefully for the low-voltage network, as it has a major impact on the expense required for protective measures (Fig. 11/1). On the low-voltage side, it also influences the electromagnetic compatibility

(EMC). From experience, the TN-S system has the best cost-benefit ratio of electrical networks at the low-voltage level. To determine the type of connection to earth, the entire installation from the power source (transformer) to the electrical consumer must be considered. The low-voltage switchboard is merely one part of this installation.

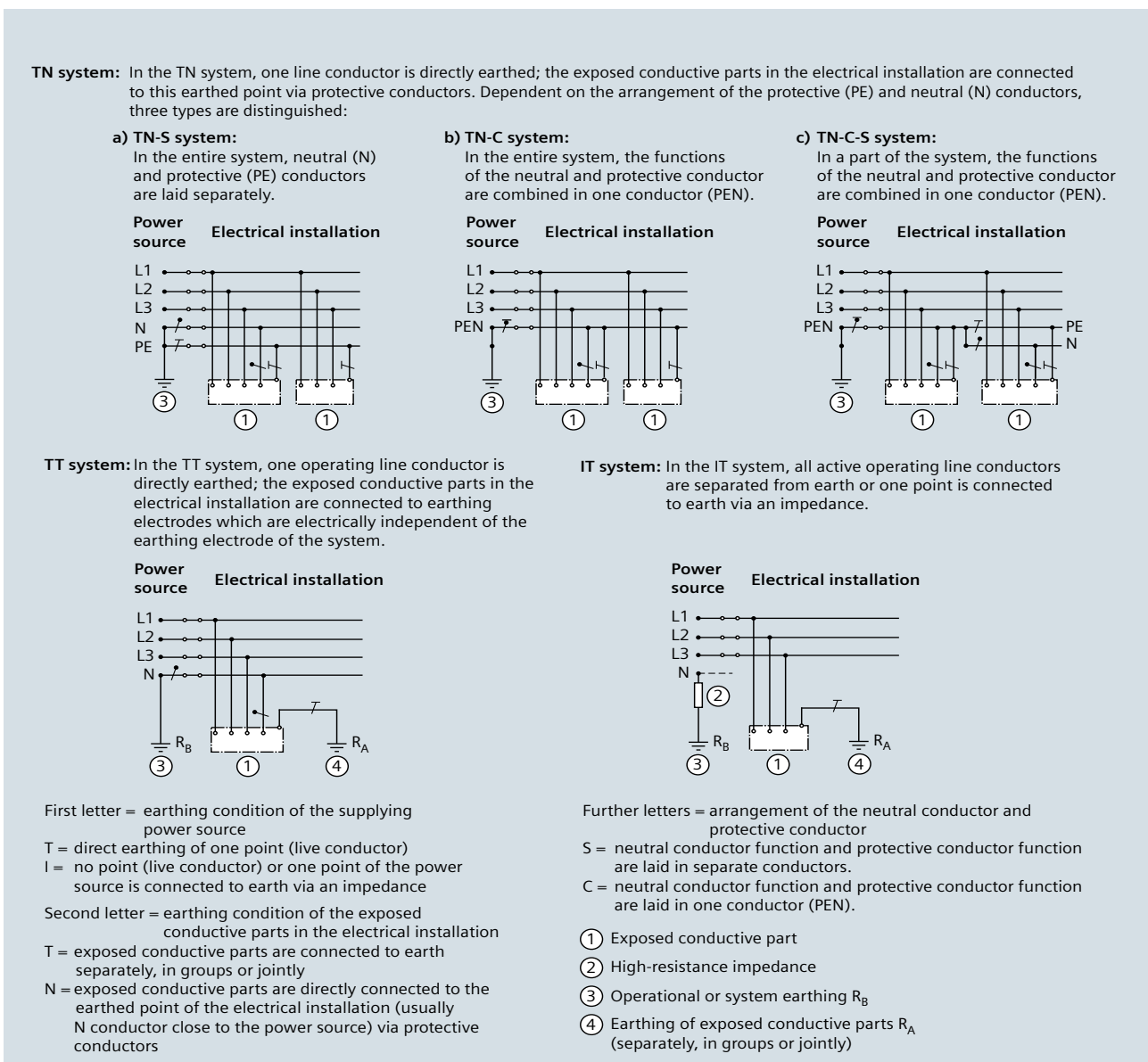

Fig. 11/1: Systems by type of connection to earth in accordance with IEC 60364-1

In the event of a short-circuit to an exposed-conductive-part in a TN system, a considerable proportion of the 1-phase short-circuit current is not fed back to the power source through earth but through the protective conductor. The comparatively high 1-phase short-circuit current allows for the use of simple protection devices such as fuses or miniature circuit-breakers, which clear the fault within the permissible fault disconnection time.

In building technologies, networks with TN-S systems are preferably used today. When a TN-S system is used in the entire building, residual currents in the building, and thus an electromagnetic interference by galvanic coupling, can be prevented during normal operation because the operational currents flow back exclusively through the separately laid, isolated N conductor. In case of a central arrangement of the power sources, the TN-S system is always recommended. In that, the system earthing is implemented at one central earthing point (CEP) for all sources, for example in the low-voltage main distribution.

Please note that neither the PEN nor the PE must be switched. If a PEN conductor is used, it is to be isolated over its entire course – this includes the distribution system (please refer to the example in Fig. 11/2). The magnitude of the 1-phase short-circuit current directly depends on the position of the CEP.

*Caution: In extensive supply networks with more than one splitting bridge, stray short-circuit currents may occur.*

4-pole switching devices must be used if two TN-S subsystems are connected to each other. In TN-S systems, only one earthing bridge may be active at a time. Therefore, it is not permitted that two earthing bridges be interconnected via two conductors.

Today, networks with TT systems are still used in rural supply areas only and in few countries. In this context, the stipulated independence of the earthing systems

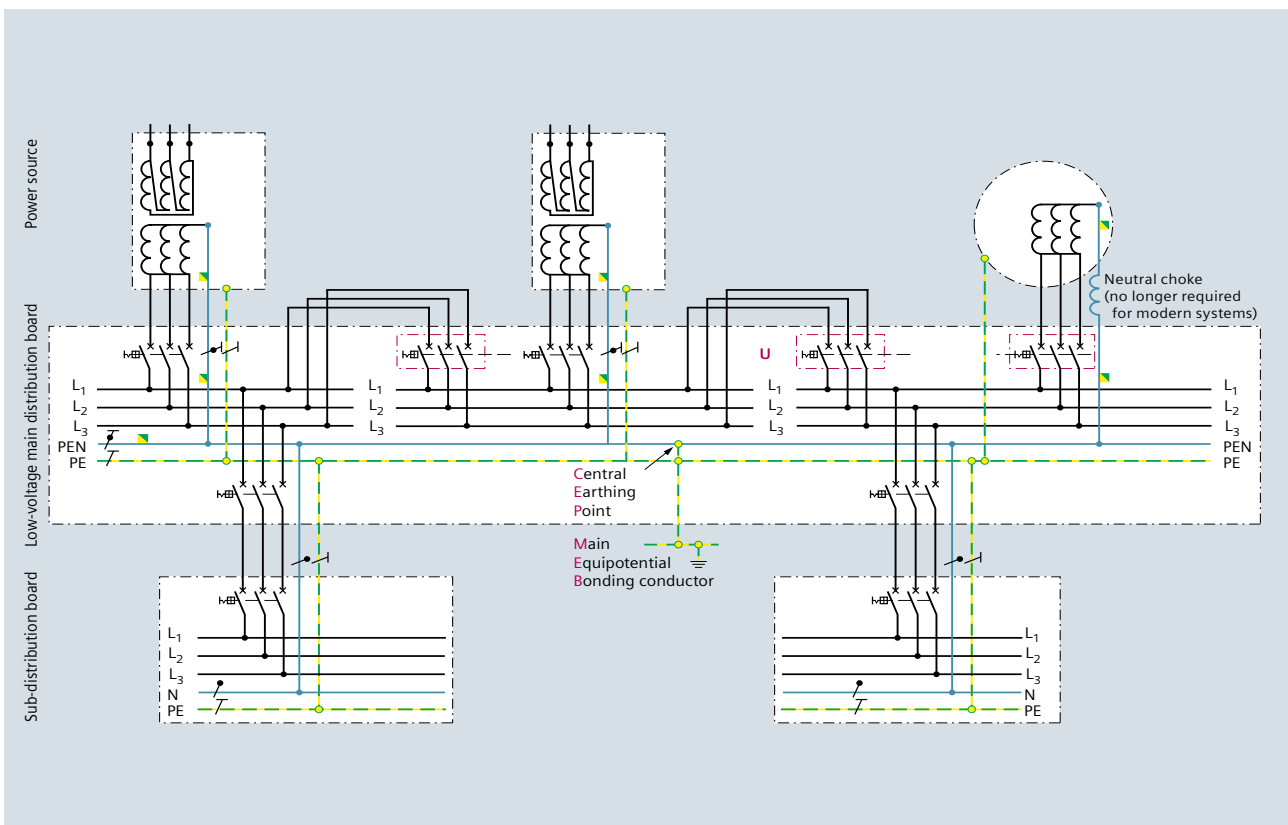

Fig. 11/2: Line diagram for an earthing concept based on a central earthing point (CEP)

must be observed. In accordance with IEC 60364-5-54, a minimum distance  $\geq 15$  m is required.

Networks with an IT system are preferably used for rooms with medical applications in accordance with IEC 60364-7-710 in hospitals and in the production, where no supply interruption is to take place upon the first fault, for example in the cable and optical fiber production. The TT system as well as the IT system require the use of residual current devices (RCDs) – previously named FI (fault interrupters) – for almost every circuit.

### Fault in the IT network

In the IT network, it is the double earth fault which has to be managed by the circuit-breaker as the worst case fault on the load and supply side (Fig. 11/3). During such

a fault, the full phase-to-phase voltage of 690 V, for example, is applied at the main contact, and simultaneously the high short-circuit current.

The product standard IEC 60947-2 for circuit-breakers calls for additional tests in accordance with Annex H of this standard to qualify them for use in non-earthed or impedance-earthed networks (IT systems). Accordingly, the circuit-breaker specifications relating to the IT system must be observed.

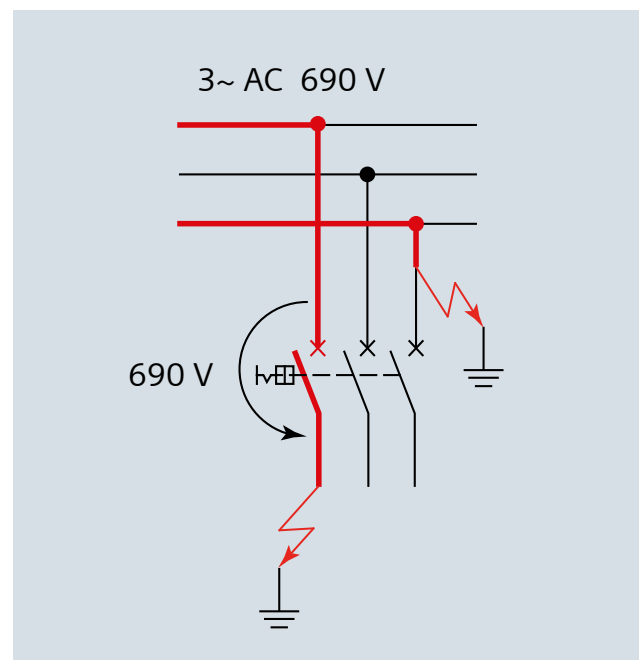

Fig. 11/3: Double earth fault in the IT system

## 11.2 Loads and Dimensioning

### Current-carrying capacity considering the ambient temperature

The current-carrying capacity can be calculated from the following relation taking the ambient temperature into account.

$$I_1^2 / I_2^2 = \Delta T_1 / \Delta T_2$$

Where the power ratio (of the currents squared) equals the ratio of temperature differences  $\Delta T$  between object and environment.

Example of a main busbar:

With

a rated current of  $I_1 = 4,000 \text{ A}$   
and a permissible busbar temperature of  $T_{\text{BB}} = 130 \text{ }^\circ\text{C}$ ,

an ambient temperature  $T_{\text{env}} = 40 \text{ }^\circ\text{C}$   
results in a rated operational current  $I_2$  of

$$I_2 = I_1 \cdot \sqrt{\frac{\Delta T_1}{\Delta T_2}} = I_1 \cdot \sqrt{\frac{(T_{\text{BB}} - T_{\text{env}})}{(T_{\text{BB}} - 35 \text{ }^\circ\text{C})}}$$
$$I_2 = 4,000 \text{ A} \cdot \sqrt{\frac{90 \text{ }^\circ\text{C}}{95 \text{ }^\circ\text{C}}} = \underline{\underline{3,893 \text{ A}}}$$

### Rated frequency 60 Hz

According to IEC 61439-1, Clause 10.10.2.3.1, the rated current at 60 Hz must be reduced to 95 % of its value at 50 Hz in case of currents greater than 800 A.

### Short-circuit current-carrying capacity of distribution busbars and functional units

IEC 61439-1, Clause 8.6.1, permits a reduction of the short-circuit withstand strength of the vertical distribution busbar and the outgoing feeders in relation to the main busbars "provided that these conductors are arranged so that under normal operation, an internal short-circuit between live parts and/or between live parts and earth is not to be expected." The background for this simplification is the usually higher rated operational current of the main busbar compared to the currents of the distribution busbars, for the contact systems of the withdrawable units, and in the supply lines to the functional units. Lower temperature rises are to be expected for these lower feeder currents, so that it hardly makes sense to aim at the same dynamic and thermal short-circuit withstand strength as for the main busbar.

Example:

To attain a required rated short-time withstand current of 100 kA, a 3VA2 circuit-breaker (MCCB) with a switching capacity of 100 A is used as a short-circuit protection device:

In case of a disconnection on short circuit, merely a peak current of approximately 50 kA will flow as a let-through current for a short time, so that an RMS value of 35 kA can be assumed as a maximum. It is only this reduced current which stresses the conductors in this circuit for the very short disconnection time of the circuit-breaker.

### Test of dielectric properties

According to IEC 61439-1, Clause 10.9, the dielectric properties of the switchboard must be tested considering devices with reduced dielectric properties. This means: "For this test, all the electrical equipment of the assembly shall be connected, except those items of apparatus which, according to the relevant specifications, are designed for a lower test voltage; current-consuming apparatus (e.g. windings, measuring devices, voltage surge suppression devices) in which the application of the test voltage would cause the flow of a current, shall be disconnected. Such apparatus shall be disconnected at one of their terminals unless they are not designed to withstand the full test voltage, in which case all terminals may be disconnected."

1

2

3

4

5

6

7

8

9

10

11

12

## Dimensioning of the protective conductors

According to IEC 61439-1, Clause 8.4 and 8.8, an earth continuity connection (PE, PEN) must be ensured, which must meet the following requirements in accordance with IEC 61439-1.

- According to Subclause 8.4.3.2.2:  
"All exposed-conductive-parts of the assembly shall be interconnected together and to the protective conductor of the supply or via an earthing conductor to the earthing arrangement. These interconnections may be achieved either by metal screwed connections, welding or other conductive connections or by a separate conductor providing earth continuity." Tab. 11/1 must be used for a separate protective conductor. Furthermore, certain exposed-conductive-parts of the assembly which do not constitute a danger need not be connected to the protective conductor.

This applies

- either "because they cannot be touched on large surfaces or grasped with the hand";
- or "because they are of small size (approximately 50 mm by 50 mm) or so located as to exclude any contact with live parts".

This applies to screws, rivets and nameplates. It also applies to electromagnets of contactors or relays, magnetic cores of transformers, certain parts of releases, or similar, irrespective of their size. When removable parts are equipped with a metal supporting surface, these surfaces shall be considered sufficient for ensuring earth continuity provided that the pressure exerted on them is sufficiently high.

- According to Subclause 8.4.3.2.3:  
"A protective conductor within the assembly shall be so designed that it can withstand the highest thermal and dynamic stresses arising from faults in external circuits supplied through the assembly in its installed location. Conductive structural parts may be used as a protective conductor or a part of it." Moreover, the following is required for PEN conductors:
  - Minimum cross-section  $\geq 10 \text{ mm}^2$  (Cu) or  $16 \text{ mm}^2$  (Al)
  - PEN cross-section  $\geq N$  cross-section
  - Structural parts shall not be used as PEN conductors. However, mounting rails made of copper or aluminum may be used as PEN conductors.
  - If the PEN current can reach high values (e.g. in electrical installations with many fluorescent lamps), it may be required that the PEN conductor has the same or a higher current-carrying capacity as/than the line conductor. This must be agreed separately between the assembly manufacturer and the user.
- According to Clause 8.8 (referring to terminals for protective conductors led in from the outside):  
In the absence of a special agreement between the assembly manufacturer and the user, terminals for protective conductors shall "allow the connection of copper conductors having a cross-section depending on the cross-section of the corresponding line conductors" (see Tab. 11/2).

Rated operational current $I_e$	Minimum cross-section for protective conductor
$I_e \leq 20$	$S$ <sup>1)</sup>
$20 < I_e \leq 25$	$2.5 \text{ mm}^2$
$25 < I_e \leq 32$	$4 \text{ mm}^2$
$32 < I_e \leq 63$	$6 \text{ mm}^2$
$63 < I_e$	$10 \text{ mm}^2$

<sup>1)</sup>  $S$  = cross-section of the line conductor in  $\text{mm}^2$

Tab. 11/1: Cross-sections for protective conductors made of copper acc. to Clause 8.4.3.2.2 of IEC 61439-1

Permissible cross-sectional range of line conductors $S$	Minimum cross-section of the corresponding protective conductor (PE, PEN) $S_p$ <sup>1)</sup>
$S \leq 16 \text{ mm}^2$	$S$
$16 \text{ mm}^2 < S \leq 35 \text{ mm}^2$	$16 \text{ mm}^2$
$35 \text{ mm}^2 < S \leq 400 \text{ mm}^2$	$\frac{1}{2} \times S$
$400 \text{ mm}^2 < S \leq 800 \text{ mm}^2$	$200 \text{ mm}^2$
$800 \text{ mm}^2 < S$	$\frac{1}{4} \times S$

<sup>1)</sup> The neutral current can be influenced by harmonics to a significant extent

Tab. 11/2: Minimum connection requirements for protective conductors made of copper (PE and PEN) acc. to Clause 8.8 (from outside) of IEC 61439-1



### 11.3 Degrees of Protection According to IEC 60529

IEC 60529 establishes a classification system for degrees of protection provided by an enclosure, which relates to electrical equipment with rated voltages up to 72.5 kV. The IP (international protection) code described in this standard characterizes the degrees of protection provided by enclosures against access to hazardous parts, ingress of solid foreign objects, and ingress of water, which is briefly summarized in Tab. 11/3.

Part of the code	Characteristic letter or characteristic numeral	Meaning for the protection of equipment	Meaning for the protection of persons
International protection	IP	-	-
1 <sup>st</sup> characteristic numeral		Against ingress of solid foreign objects	Against access to hazardous parts
	0	No protection (non-protected)	No protection (non-protected)
	1	≥ 50.0 mm diameter	Back of hand
	2	≥ 12.5 mm diameter	Finger
	3	≥ 2.5 mm diameter	Tool
	4	≥ 1.0 mm diameter	Wire
	5	Dust-protected	Wire
	6	Dust-tight	Wire
2 <sup>nd</sup> characteristic numeral		Against ingress of water with harmful effects	-
	0	No protection (non-protected)	
	1	Vertically dripping	
	2	Dripping (15° tilted)	
	3	Spraying water	
	4	Splashing water	
	5	Jetting water	
	6	Powerful jetting water	
	7	Temporary immersion	
	8	Continuous immersion	
Additional letter (optional)		-	Against access to hazardous parts
	A		Back of hand
	B		Finger
	C		Tool
	D		Wire
Supplementary letter (optional)		Supplementary information specific to	-
	H	High-voltage apparatus	
	M	Motion during water test	
	S	Stationary during water test	
	W	Weather conditions	

Tab. 11/3: Structure of the IP code and the meaning of characteristic numerals and code letters

## 11.4 Forms of Internal Separation According to IEC 61439-2

IEC 61439-2 describes possibilities how to subdivide power switchgear and controlgear assemblies. The following shall be attained by a subdivision into separate functional units, internal separation, or by enclosure:

- Protection against contact with hazardous parts (minimum IPXXB, where XX represents any characteristic numerals 1 and 2 of the IP code)
- Protection against ingress of solid foreign objects (minimum IP2X, where X represents any second characteristic numeral).

Internal separation can be ensured by partitions or protective covers (made of metal or non-metal materials), insulation of exposed-conductive-parts or the integrated enclosure of devices, as implemented in the molded-case circuit-breaker, for example. The forms of internal separation mentioned in IEC 61439-2 are listed in Tab. 11/4 (Form 1, 2a, 2b, 3a, 3b, 4a and 4b).

Remark: IP2X also covers IPXXB.

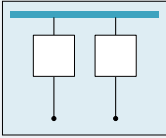
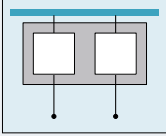
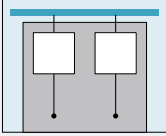
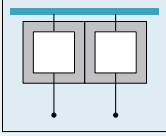
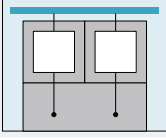
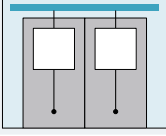
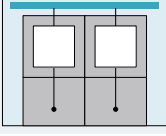
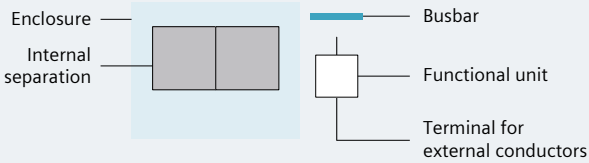
Form	Explanations	Form	Explanations	Basic circuit diagram
1	No internal separation	1	No internal separation	
2	Separation of busbars from all functional units	2a	Terminals for external conductors not separated from busbars	
		2b	Terminals for external conductors separated from busbars	
3	Separation of busbars from all functional units + Separation of all functional units from one another + Separation of terminals for external conductors and external conductors from the functional units, but not from the terminals of other functional units	3a	Terminals for external conductors not separated from busbars	
		3b	Terminals for external conductors separated from busbars	
4	Separation of busbars from all functional units + Separation of all functional units from one another + Separation of terminals for external conductors associated with a functional unit from the terminals of any other functional unit and the busbars	4a	Terminals for external conductors in same compartment as associated functional unit	
		4b	Terminals for external conductors not in the same compartment as the associated functional unit	
Legend:				

Tab. 11/4: Internal separation of assemblies in accordance with IEC 61439-2

## 11.5 Operating Currents of Three-Phase Asynchronous Motors

To convert the motor power value, Tab. 11/5 specifies guide values for the motor current at different voltages.

Apart from the motor operating currents, the inrush and starting currents are to be particularly observed for dimensioning the switching and protection devices (Fig. 11/4). According to the EU Regulation 2019/1781, in the large range between 120 W and 1,000 kW, only three-phase low-voltage motors with efficiency classes IE3 and IE4 may be put into circulation in the Economic Area of the European Union as from July 1, 2021.

On the one hand, this means a reduction of the operating currents with unchanged mechanical effect, but, on the other hand, the changes can lead to higher currents and another dynamic behavior during motor start. The switching devices from Siemens that can presently be installed in SIVACON S8 satisfy the requirements of IE3/IE4 motors, thus avoiding false tripping due to higher inrush and starting currents.

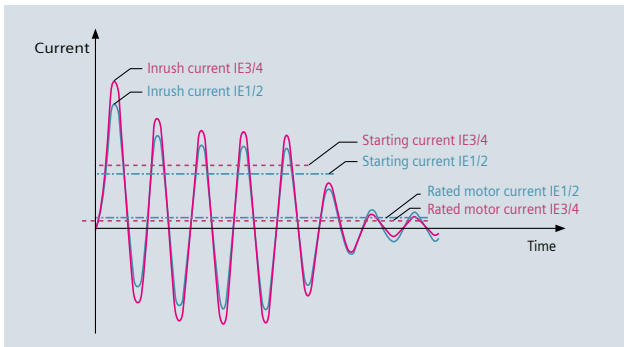

Fig. 11/4: Schematic current-time curves for the starting of motors with efficiency classes IE1/IE2 and IE3/IE4

Standard power $P$	Motor current $I$ (guide value)		
	at 400 V	at 500 V	at 690 V
0.06 kW	0.20 A	0.16 A	0.12 A
0.09 kW	0.30 A	0.24 A	0.17 A
0.12 kW	0.44 A	0.32 A	0.23 A
0.18 kW	0.60 A	0.48 A	0.35 A
0.25 kW	0.85 A	0.68 A	0.49 A
0.37 kW	1.1 A	0.88 A	0.64 A
0.55 kW	1.5 A	1.2 A	0.87 A
0.75 kW	1.9 A	1.5 A	1.1 A
1.1 kW	2.7 A	2.2 A	1.6 A
1.5 kW	3.6 A	2.9 A	2.1 A
2.2 kW	4.9 A	3.9 A	2.8 A
3 kW	6.5 A	5.2 A	3.8 A
4 kW	8.5 A	6.8 A	4.9 A
5.5 kW	11.5 A	9.2 A	6.7 A
7.5 kW	15.5 A	12.4 A	8.9 A
11 kW	22 A	17.6 A	12.8 A
15 kW	29 A	23 A	17 A
18.5 kW	35 A	28 A	21 A
22 kW	41 A	33 A	24 A
30 kW	55 A	44 A	32 A
37 kW	66 A	53 A	39 A
45 kW	80 A	64 A	47 A
55 kW	97 A	78 A	57 A
75 kW	132 A	106 A	77 A
90 kW	160 A	128 A	93 A
110 kW	195 A	156 A	113 A
132 kW	230 A	184 A	134 A
160 kW	280 A	224 A	162 A
200 kW	350 A	280 A	203 A
250 kW	430 A	344 A	250 A

Tab. 11/5: Guide values for operational currents of three-phase asynchronous motors (AC-2/AC-3) acc. to IEC 60947-4-1

## 11.6 Three-Phase Distribution Transformers

Important parameters for the connection of the SIVACON S8 low-voltage switchboard to three-phase distribution transformers are listed in Tab. 11/6.

Approximation formulas for current estimation, if there are no table values available:

For the rated current of the transformer, the following applies approximately:

$$I_n = k \cdot S_{nT}$$

For the initial symmetrical short-circuit current of the transformer, the following applies approximately:

$$I_k'' = I_n / u_{kr}$$

For example:

- Rated power of transformer  $S_{nT} = 500$  kVA
- Voltage factor  $k$ 
  - $k = 1.45$  A/kVA for a rated voltage of 400 V
  - $k = 1.1$  A/kVA for a rated voltage of 525 V
  - $k = 0.84$  A/kVA for a rated voltage of 690 V
- Rated short-circuit voltage  $u_{kr} = 4\%$

result in the following approximations for  $U_n = 400$  V:

$$I_n = (1.45 \cdot 400) \text{ A} = 725 \text{ A}$$

$$I_k'' = (725 \cdot 100 / 4) \text{ A} = 18.125 \text{ kA}$$

Rated power $S_{nT}$	Rated voltage								
	400 V AC / 50 Hz			525 V AC / 50 Hz			690 V AC / 50 Hz		
	Rated current $I_n$	Rated short-circuit voltage $u_{kr}$		Rated current $I_n$	Rated short-circuit voltage $u_{kr}$		Rated current $I_n$	Rated short-circuit voltage $u_{kr}$	
		4 %	6 %		4 %	6 %		4 %	6 %
Rated current $I_n$	Initial symmetrical short-circuit current $I_k''$ <sup>1)</sup>		Rated current $I_n$	Initial symmetrical short-circuit current $I_k''$ <sup>1)</sup>		Rated current $I_n$	Initial symmetrical short-circuit current $I_k''$ <sup>1)</sup>		
50 kVA	72 A	1,933 A	1,306 A	55 A	1,473 A	995 A	42 A	1,116 A	754 A
100 kVA	144 A	3,871 A	2,612 A	110 A	2,950 A	1,990 A	84 A	2,235 A	1,508 A
160 kVA	230 A	6,209 A	4,192 A	176 A	4,731 A	3,194 A	133 A	3,585 A	2,420 A
200 kVA	288 A	7,749 A	5,239 A	220 A	5,904 A	3,992 A	167 A	4,474 A	3,025 A
250 kVA	360 A	9,716 A	6,552 A	275 A	7,402 A	4,992 A	209 A	5,609 A	3,783 A
315 kVA	455 A	12,247 A	8,259 A	346 A	9,331 A	6,292 A	262 A	7,071 A	4,768 A
400 kVA	578 A	15,506 A	10,492 A	440 A	11,814 A	7,994 A	335 A	8,953 A	6,058 A
500 kVA	722 A	19,438 A	13,078 A	550 A	14,810 A	9,964 A	418 A	11,223 A	7,581 A
630 kVA	910 A	24,503 A	16,193 A	693 A	18,669 A	12,338 A	525 A	14,147 A	9,349 A
800 kVA	108 A	-	20,992 A	880 A	-	15,994 A	670 A	-	12,120 A
1,000 kVA	1,154 A	-	26,224 A	1,100 A	-	19,980 A	836 A	-	15,140 A
1,250 kVA	1,805 A	-	32,791 A	1,375 A	-	24,984 A	1,046 A	-	18,932 A
1,600 kVA	2,310 A	-	41,857 A	1,760 A	-	31,891 A	1,330 A	-	24,265 A
2,000 kVA	2,887 A	-	52,511 A	2,200 A	-	40,008 A	1,674 A	-	30,317 A
2,500 kVA	3,608 A	-	65,547 A	2,749 A	-	49,941 A	2,090 A	-	37,844 A
3,150 kVA	4,450 A	-	82,656 A	3,470 A	-	62,976 A	2,640 A	-	47,722 A

<sup>1)</sup>  $I_k''$  is the prospective initial symmetrical short-circuit current of the transformer in consideration of the voltage factor and the correction factor of the transformer impedance according to IEC 60909-0, without considering the system source impedance

Tab. 11/6: Rated currents and initial symmetrical short-circuit currents for three-phase distribution transformers

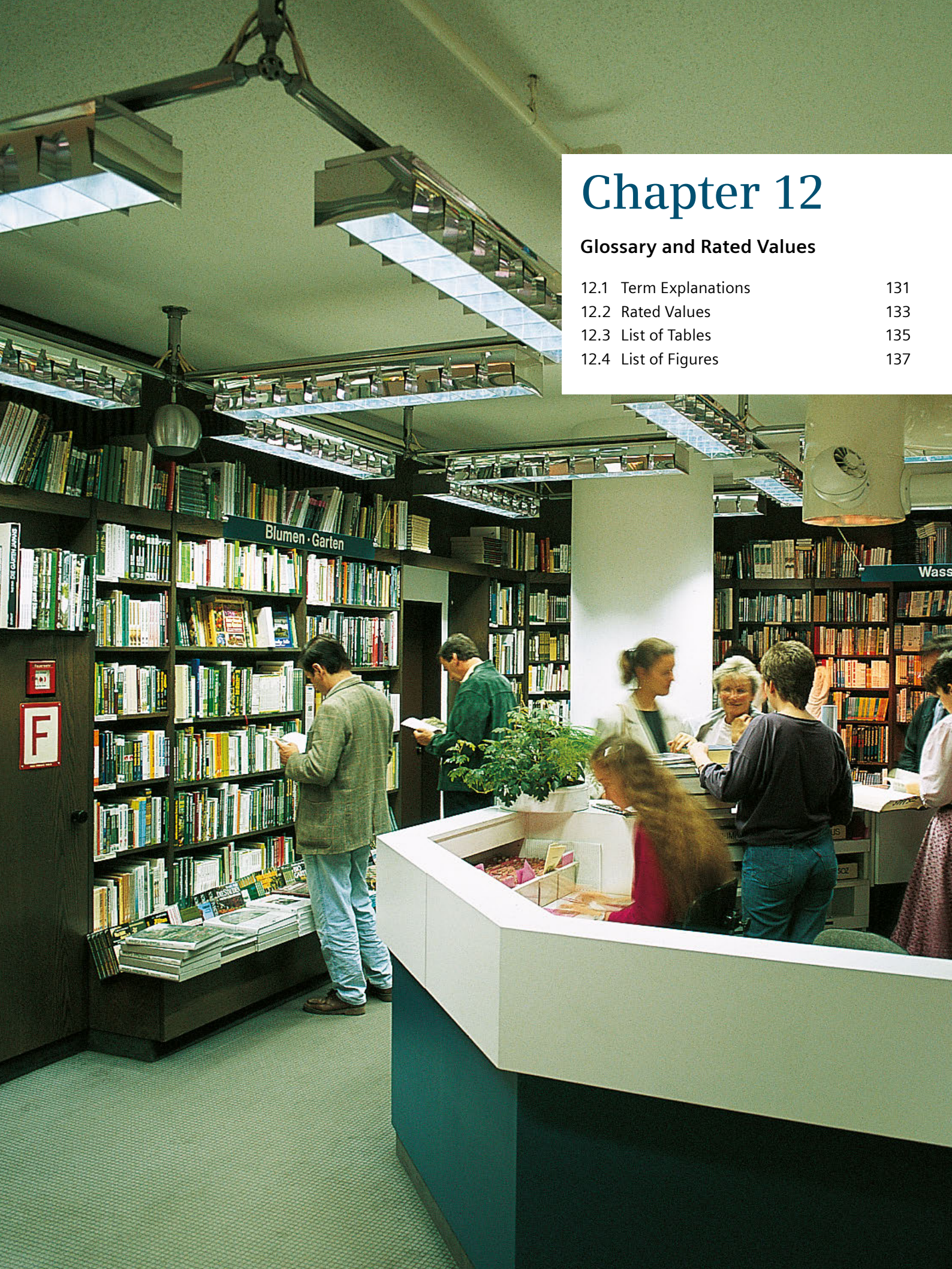

# Chapter 12

## Glossary and Rated Values

12.1	Term Explanations	131
12.2	Rated Values	133
12.3	List of Tables	135
12.4	List of Figures	137

# 12 Glossary and Rated Values

## 12.1 Term Explanations

The information provided in the two standards IEC 61439-1 and -2 is used to explain the relevant terms referred to in this planning manual:

### **Low-voltage switchgear and controlgear assembly (assembly)**

Combination of one or more low-voltage switching devices together with associated control, measuring, signaling, protective, regulating equipment, with all the internal electrical and mechanical interconnections and structural parts

### **Assembly system**

Full range of mechanical and electrical components (enclosures, busbars, functional units, auxiliary circuits and associated controls, etc.), as defined by the original manufacturer, which can be assembled in accordance with the original manufacturer's instructions in order to produce various assemblies

### **Power switchgear and controlgear assembly (PSC-assembly)**

Assembly used to distribute and control electrical energy for all types of loads, intended for industrial, commercial and similar applications where operation by ordinary persons is not intended

### **Design verification**

Verification performed on a sample of an assembly or parts of assemblies to show that the type meets the requirements of the relevant assembly standard (Note: Design verification may comprise one or more equivalent methods)

### **Verification test**

Test conducted on a sample of an assembly or parts of assemblies to verify that the type meets the requirements of the relevant assembly standard (Note: Verification tests are equivalent to type tests as described in the IEC 60439 series of standards)

### **Verification assessment**

Design verification using strict design rules and/or calculations applied to an assembly or to parts of assemblies to show that the type meets the requirements of the relevant assembly standard

### **Construction rule**

Defined rules for the construction of an assembly which may be applied as an alternative to a verification test

### **Routine verification**

Verification of each assembly performed during and/or after manufacture to confirm whether it complies with the requirements of the relevant assembly standard

### **Functional unit**

Part of an assembly comprising all the electrical and mechanical elements including switching devices that contribute to the fulfilment of the same function

### **Removable part**

Part consisting of components assembled and wired on a common support which is intended to be removed entirely from the assembly and replaced whilst the main circuit to which it is connected may be live

### **Withdrawable part (withdrawable unit)**

Removable part intended to be moved from the connected position to the isolated (disconnected) position and to a test position, if any, whilst remaining mechanically attached to the PSC-assembly

### **Connected position**

Position of a removable part when it is fully connected for its intended function

### **Test position**

Position of a withdrawable part in which the relevant main circuits are open on its supply side but not necessarily isolated and in which the auxiliary circuits are connected allowing operation tests of the incorporated device(s), the withdrawable part remaining mechanically attached to the PSC-assembly (Note: The opening can also be achieved without any mechanical movement of the withdrawable part by operation of a suitable device)

### **Isolated position (disconnected position)**

Position of a withdrawable part in which an isolating distance is established in main and auxiliary circuits on its supply side, the withdrawable part remaining mechanically attached to the PSC-assembly (Note: The isolating distance can also be established without any mechanical movement of the withdrawable part by operation of a suitable device)

### **Isolating distance**

Clearance between open contacts of withdrawable parts meeting the safety requirements specified for disconnectors

**Removed position**

Position of a removable (or withdrawable) part when it is outside the assembly, and mechanically and electrically separated from it

**Supporting structure (frame)**

Structure forming part of an assembly designed to support various components of the assembly and any enclosure

**Enclosure**

Housing affording the type and degree of protection suitable for the intended application

**Section (cubicle)**

Constructional unit of an assembly between two successive vertical delineations

**Sub-section (compartment)**

Constructional unit of an assembly between two successive horizontal or vertical delineations within a section (cubicle)

**Transport unit**

Part of an assembly or a complete assembly suitable for transportation without being dismantled

**Operating gangway within a PSC-assembly**

Space to be used by the operator for the proper operation and supervision of the PSC-assembly

**Maintenance gangway within a PSC-assembly**

Space which is accessible to authorized personnel only and primarily intended for use when servicing the installed equipment

## 12.2 Rated Values

The manufacturers of low-voltage switchgear and controlgear assemblies specify rated values in accordance with IEC 61439-1 and -2. For the low-voltage switching devices used, rated values must be stated which are in accordance with the relevant product-specific standards from the IEC 60947 series. These rated values apply to defined operating conditions and characterize the usability in an assembly.

The following rated values in accordance with IEC 61439-1 and -2 shall be the basis for configuring the assembly:

### Rated voltage $U_n$

Highest nominal voltage of the electrical system, declared by the assembly manufacturer, to which the main circuit(s) of the assembly is (are) designed to be connected.

### Rated operational voltage (of a circuit of an assembly)

$U_e$   
Value of voltage, AC (RMS) or DC (mean value), declared by the assembly manufacturer for the assembly or a circuit of an assembly, which, combined with the rated current, determines its application.

### Rated insulation voltage $U_i$

RMS withstand voltage value, assigned by the assembly manufacturer to the assembly or to a circuit of an assembly, characterizing the specified (long-term) withstand capability of the insulation.

### Rated impulse withstand voltage $U_{imp}$

Impulse withstand voltage value, assigned by the assembly manufacturer for an assembly or a circuit of an assembly, characterizing the specified withstand capability of the insulation against transient overvoltages.

### Rated current $I_n$

Value of uninterrupted current, declared by the assembly manufacturer, which can be carried without the temperature-rise of various parts of the assembly exceeding specified limits under specified conditions.

### Rated peak withstand current $I_{pk}$

Value of peak short-circuit current declared by the assembly manufacturer, that can be withstood under specified conditions.

### Rated short-time withstand current $I_{cw}$

RMS value of AC or mean value of DC short-time current, declared by the assembly manufacturer, that can be withstood under specified conditions, defined in terms of current and time.

For time values up to 3 s, the Joule integral ( $I^2 \times t$ ) is constant. For example, with  $I_{cw} = 50$  kA, 1 s, a value of  $I_{cw} = 28.9$  kA for 3 s can be calculated:

$$I_{cw}(t_2) = I_{cw}(t_1) \cdot \sqrt{\frac{t_1}{t_2}}$$

$$I_{cw}(3 \text{ s}) = 50 \text{ kA} \cdot \sqrt{\frac{1 \text{ s}}{3 \text{ s}}} = 28,9 \text{ kA}$$

### Factor $n = I_{pk} / I_{cw}$

To determine the impulse current, the RMS value of the short-circuit current must be multiplied with the factor n. Tab. 12/1 lists the values for n from IEC 61439-1.

n	cos φ	Rated short-time withstand current $I_{cw}$
1.5	0.7	$I_{cw} \leq 5 \text{ kA}$
1.7	0.7	$5 \text{ kA} < I_{cw} \leq 10 \text{ kA}$
2	0.3	$10 \text{ kA} < I_{cw} \leq 20 \text{ kA}$
2.1	0.25	$20 \text{ kA} < I_{cw} \leq 50 \text{ kA}$
2.2	0.2	$50 \text{ kA} < I_{cw}$

Tab. 12/1: Factor n as a function of cos φ and  $I_{cw}$

### Rated conditional short-circuit current $I_{cc}$

Value of the prospective short-circuit current, declared by the assembly manufacturer, that can be withstood for the total operating time (clearing time) of the SCPD under specified conditions.

### Rated current of the assembly $I_{nA}$

The rated current of the assembly is the lower value of:

- The sum of the rated currents of the incoming circuits within the assembly operated in parallel;
- The total current which the main busbar is capable of distributing in the particular assembly configuration.

### Rated operational current of a circuit $I_e$

The rated current of a circuit, declared by the assembly manufacturer, depends on the rated values of the individual items of electrical equipment in the circuit within the assembly, their arrangement and their type of application. The circuit must be capable of carrying this current when operated alone without that overtemperatures in individual components will exceed the limit values specified.



### Rated diversity factor (RDF)

Per unit value of the rated current, assigned by the assembly manufacturer, to which outgoing circuits of an assembly can be continuously and simultaneously loaded taking into account the mutual thermal influences.

The rated diversity factor may be specified

- for groups of circuits
- for the entire assembly.

The rated operational current of the circuits  $I_e$  multiplied by the rated diversity factor must be greater than or equal to the assumed load of the outgoing circuits.

The rated diversity factor assumes that several circuits in a section (cubicle) are loaded intermittently, or not fully loaded simultaneously. In the absence of an agreement between the assembly manufacturer and user concerning the actual load currents, the values of Tab. 12/2 are applied.

Type of loading	Assumed diversity factor
Power distribution: 2 - 3 circuits	0.9
Power distribution: 4 - 5 circuits	0.8
Power distribution: 6 - 9 circuits	0.7
Power distribution: 10 circuits and more	0.6
Electric actuators	0.2
Motors ≤ 100 kW	0.8
Motors > 100 kW	1

Tab. 12/2: Rated diversity factors RDF for various load types

If equipment is to be coordinated which is used in a switchboard, the rated values given in the IEC 60947 product standards shall be the basis:

### Trip class CLASS

Trip classes define time intervals within which the protection devices (overload releases of circuit-breakers or overload relays) must trip in cold state when assuming a symmetrical three-phase load of 7.2 times the setting current:

- CLASS 5, CLASS 10:  
for standard applications (normal starting)
- CLASS 20, CLASS 30, CLASS 40:  
for applications with a high starting current over a longer period of time.

In addition to the overload protection devices, the contactors and the short-circuit protection fuses must also be dimensioned for longer starting times.

### Short-circuit breaking capacity

The short-circuit breaking capacity is the short-circuit current, declared by the manufacturer, the device / motor starter is capable of breaking under specified conditions.

1

2

3

4

5

6

7

8

9

10

11

12

## 12.3 List of Tables

Tab.	Title	Page
<b>Chapter 2</b>		
2/1	Technical data, standards and approvals for the SIVACON S8 switchboard	6
2/2	Schematic overview of switchboard configurations for SIVACON S8	8 / 9
2/3	Cubicle types and busbar arrangement in the cubicles	10 / 11
2/4	Cubicle dimensions	12
2/5	Surface treatment	12
2/6	Dimensions of the corner cubicle	13
2/7	Operational ratings of the main busbar	14
2/8	Cubicle widths for earthing and short-circuiting points	15
2/9	Cable connection for the main earthing busbar	15
2/10	Basic data of the different mounting designs	16 / 17
<b>Chapter 3</b>		
3/1	General cubicle characteristics of the circuit-breaker design	21
3/2	Cubicle dimensions for busbar position at the top	22
3/3	Cubicle dimensions for busbar position at the rear	23
3/4	Cubicle dimensions for busbar position at the rear with two busbar systems in the cubicle	24
3/5	Cable connection for cubicles with 3WA	25
3/6	Rated operational currents for cable connection cubicles and couplers with a 3WA	26
3/7	Rated operational currents of the connections for the SIVACON 8PS system LD with a 3WA	26
3/8	Rated operational currents of the connections for the SIVACON 8PS system LI with a 3WA	27
3/9	Rated operational currents for withdrawable units with 3WA circuit breakers with forced ventilation	28
3/10	Rated operational currents for load cases (Fig. 3/3) of a circuit-breaker cubicle with two 3WA12 circuit-breakers in the cubicle	29
3/11	Rated operational currents for two 3WA12 ( $I_n = 1,600 \text{ A}$ ) in the cubicle	30
3/12	Rated operational currents for load cases (Fig. 3/5) of a circuit-breaker cubicle with two 3WA12 circuit-breakers connected in parallel in the cubicle	31
3/13	Cubicle dimensions for cubicles with 3 ACBs type 3WA	32
3/14	Cable connection in cubicles with up to 3 ACBs	32
3/15	Rated operational currents for special load cases of a circuit-breaker cubicle with three 3WA11 circuit-breakers in the cubicle	32
3/16	Cubicle types for outgoing feeder/incoming feeder cubicles with MCCB (front view at the top; side view at the bottom)	33
3/17	Rated operational currents for cubicles with 3VA	33
3/18	Cubicle width for direct incoming feeder / direct outgoing feeder	34
3/19	Cable connection for direct incoming feeder / direct outgoing feeder	34
3/20	Rated operational currents for direct incoming feeder	34

Tab.	Title	Page
<b>Chapter 4</b>		
4/1	General cubicle characteristics for the universal mounting design	36
4/2	Operational ratings of the vertical distribution busbar	38
4/3	Cubicle characteristics for fixed-mounted design	39
4/4	Conductor cross-sections in fixed-mounted cubicles with front door	39
4/5	Operational ratings for cable feeders	39
4/6	Cubicle characteristics for in-line switch-disconnectors	40
4/7	General cubicle characteristics for withdrawable design	40
4/8	Withdrawable units in HFD	41
4/9	Characteristics of withdrawable units in HFD	42
4/10	Connection data for main circuit	44
4/11	Connection data for auxiliary circuit	44
4/12	Number of free auxiliary contacts for withdrawable units in HFD	44
4/13	Characteristics of withdrawable units in SFD	45
4/14	Connection data for main circuit	46
4/15	Connection data for auxiliary circuit	46
4/16	Number of free auxiliary contacts for withdrawable units in SFD	46
4/17	Rated operational currents and minimum withdrawable unit heights for cable feeders in SFD / HFD	47
4/18	Sizes for normal withdrawable units	48
4/19	Sizes of small withdrawable units for fused motor feeders	49
4/20	Sizes of small withdrawable units for non-fused motor feeders	50
<b>Chapter 5</b>		
5/1	General cubicle characteristics for plug-in in-line design	52
5/2	Ratings of the vertical distribution busbar 3NJ63	53
5/3	Additional built-in components for 3NJ63	53
5/4	Derating factors for 3NJ63 fuse-links	53
5/5	Ratings of 3NJ63 cable feeders	53
5/6	Maximum possible cable connections for in-line switch-disconnectors 3NJ63	54
5/7	Conversion factors for other ambient temperatures	55
5/8	Configuration rules for 3NJ63: arrangement of in-line units in the cubicle	55
5/9	Ratings of the vertical distribution busbar SASILplus	56
5/10	Additional built-in components for SASILplus	56
5/11	Derating factors for SASILplus fuse-links	56
5/12	Ratings of the SASILplus cable feeders	56
5/13	Conversion factors for other ambient temperatures	57
5/14	Configuration rules for SASILplus: arrangement of in-line units in the cubicle	57

Tab.	Title	Page
<b>Chapter 6</b>		
6/1	General cubicle characteristics for fixed-mounted in-line design	61
6/2	Maximum possible cable connections for 3NJ4 in-line switch-disconnectors	61
6/3	Ratings of 3NJ4 cable feeders	61
6/4	Dimensions if additional built-in components are used	62
6/5	Mounting location of additional built-in components	62
6/6	Device compartment for in-line units in the second row	62
6/7	Ratings of the cable feeders for in-line units in the second row	62
6/8	General cubicle characteristics for fixed-mounted cubicles with front door	63
6/9	Ratings of the vertical distribution busbar	64
6/10	Conductor cross-sections in fixed-mounted cubicles with front door	64
6/11	Ratings of cable feeders for 3NP, 3KF and 3RV	65
6/12	Ratings of cable feeders for 3VA	66
6/13	Configuration data of the assembly kits for modular installation devices	66
6/14	General cubicle characteristics for freely configured fixed-mounted design	67
6/15	Configuration data on cubicle design for freely configured fixed-mounted design	68
6/16	Ratings of the vertical distribution busbar	68
6/17	Configuration data on mounting options for freely configured fixed-mounted design	68
6/18	Technical features of the cubicles with frequency converter design	69
6/19	Conductor cross-sections of the modules	69
6/20	Categorization of assembly kits for modular installation devices	70
<b>Chapter 7</b>		
7/1	General cubicles characteristics for reactive power compensation	74
7/2	Choked capacitor assemblies with built-in audio frequency suppressor	75
7/3	Configuration of the capacitor assemblies	76
7/4	Conversion factors F for phase angle adjustments	77
7/5	Connection cables and back-up fuses for separately installed compensation cubicles	78
<b>Chapter 8</b>		
8/1	Examples for connection of Siemens devices to the different communication systems	80
8/2	Features of PROFIBUS DP and Modbus RTU	81
8/3	Properties of a PROFIBUS cable type A	82
8/4	Distribution of the PROFINET devices and their equivalents in PROFIBUS cubicles	83
8/5	Industrial Ethernet cable, prefabricated with two RJ45 plugs (CAT 6A, TP line 4 x 2)	87

Tab.	Title	Page
8/6	PROFINET switches SCALANCE (10/100 Mbit/s) for cubicle installation	87
8/7	Mounting options in empty compartments for cubicle installation of SCALANCE switches	88
8/8	Mounting options of SCALANCE switches in the cable, head or foot compartment of universal outgoing feeder cubicles	89
8/9	Options for the SIMARIS control versions	93
<b>Chapter 9</b>		
9/1	Weights (orientation values) for selected cubicles	102
9/2	Power losses for SIVACON S8 cubicles (orientation values)	102
9/3	Normal service conditions for SIVACON S8 switchboards	103
9/4	Special service conditions for SIVACON S8 switchboards	104
<b>Chapter 10</b>		
10/1	Tests for design verification according to IEC 61439-2	106
10/2	Characteristics under conditions of internal arcing and classification according to IEC/TR 61641	109
10/3	SIVACON S8 system characteristics under conditions of arcing	111
10/4	Acceleration factor K for SIVACON S8	111
<b>Chapter 11</b>		
11/1	Cross-sections for protective conductors made of copper acc. to Clause 8.4.3.2.2 of IEC 61439-1	124
11/2	Minimum connection requirements for protective conductors made of copper (PE and PEN) acc. to Clause 8.8 (from outside) of IEC 61439-1	124
11/3	Structure of the IP code and the meaning of characteristic numerals and code letters	125
11/4	Internal separation of assemblies in accordance with IEC 61439-2	126
11/5	Guide values for operational currents of three-phase asynchronous motors (AC-2/AC-3) acc. to IEC 60947-4-1	127
11/6	Rated currents and initial symmetrical short-circuit currents for three-phase distribution transformers	128
<b>Chapter 12</b>		
12/1	Factor n as a function of $\cos \varphi$ and $I_{cw}$	132
12/2	Rated diversity factors RDF for various load types	133

1  
2  
3  
4  
5  
6  
7  
8  
9  
10  
11  
12

## 12.4 List of Figures

Fig.	Title	Page
<b>Chapter 1</b>		
1/1	Totally Integrated Power (TIP) as a holistic approach to electric power distribution	2
1/2	SIVACON S8 for all areas of application	3
1/3	Use of SIVACON S8 in power distribution	4
<b>Chapter 2</b>		
2/1	Cubicle design of SIVACON S8	7
2/2	Dimensions of the enclosure parts	12
2/3	Integration of a corner cubicle	13
2/4	Variable busbar position for SIVACON S8	14
<b>Chapter 3</b>		
3/1	Cubicles in circuit-breaker design	20
3/2	Forced ventilation in a circuit-breaker cubicle	21
3/3	Cubicle types and load cases with two 3WA12 as longitudinal coupler and incoming feeder / outgoing feeder (top: side view; bottom: front view)	29
3/4	Cubicle types with two independent 3WA as incoming feeder / outgoing feeder (top: side view; bottom: front view)	30
3/5	Cubicle types and load cases with two 3WA12 connected in parallel as incoming feeder / outgoing feeder (top: side view; bottom: front view)	31
3/6	Cubicle types with three circuit-breakers (side view)	32
3/7	Cubicles for direct incoming feeder / direct outgoing feeder	34
<b>Chapter 4</b>		
4/1	Cubicle for universal mounting design with cable connection from the front	36
4/2	Cubicle with forced ventilation for universal mounting design	37
4/3	Combination options for universal mounting design	38
4/4	Arrangement of components in fixed-mounted design (left) and connection terminals in the cable compartment (right)	39
4/5	Withdrawable design versions in Standard Feature Design (SFD; left) and High Feature Design (HFD; right)	40
4/6	Structure of a small withdrawable unit in HFD	41
4/7	Positions with disconnecting contact system in HFD	41
4/8	Front areas usable for an instrument board for small withdrawable units with a mounting height of 150 mm	43
4/9	Front areas usable for an instrument board for small withdrawable units with a mounting height of 200 mm	43
4/10	Front areas usable for an instrument board for normal withdrawable units	43
4/11	Shutter for normal withdrawable unit in HFD	44
4/12	Adapter plate for small withdrawable units	44
4/13	Positions with disconnecting contact system in SFD	45
4/14	Normal withdrawable unit in SFD with a withdrawable unit height of 100 mm	45
4/15	Open withdrawable unit compartments in SFD	46

Fig.	Title	Page
<b>Chapter 5</b>		
5/1	Cubicles for plug-in in-line design: On the left for in-line switch-disconnectors with fuses 3NJ63; on the right for in-line switch-disconnectors with fuses SASILplus	52
5/2	Plug-in in-line switch-disconnectors 3NJ63	53
5/3	Plug-in in-line switch-disconnectors SASILplus	56
<b>Chapter 6</b>		
6/1	Cubicles for fixed-mounted in-line design with 3NJ4 in-line switch-disconnectors	60
6/2	Cubicles for fixed-mounted design with front door	63
6/3	Installation of switching devices in fixed-mounted cubicles with a front cover (cover open)	64
6/4	Cable connections in fixed-mounted cubicles with front door	64
6/5	Assembly kit for modular installation devices (without cover)	66
6/6	Cubicles for freely configured fixed-mounted design	67
6/7	Cubicle with frequency converter design	69
6/8	Permissible output current for cubicles with frequency converter design	71
<b>Chapter 7</b>		
7/1	Cubicle for reactive power compensation	74
7/2	Capacitor assemblies of the reactive power compensation	75
<b>Chapter 8</b>		
8/1	RS485 connection for Modbus [source: modbus.org, 2006: Modbus over Serial Line - Specification and Implementation Guide V1.02]	81
8/2	PROFIBUS network topologies with repeater	82
8/3	PROFIBUS network topology without radial lines	82
8/4	Connection of Modbus RTU devices via a 7KM PAC4200 gateway to the Modbus TCP communication	84
8/5	Communication network with SENTRON 7KN POWERCENTER 3000 as a gateway for connection to the cloud	85
8/6	Dimensions and connections of the SENTRON 7KN POWERCENTER 3000 (dimensions in millimeters)	86
8/7	Mounting option of a SCALANCE switch with 8 ports for all cubicle types	88
8/8	Communication solutions from Siemens for SIVACON S8	90 / 91
8/9	Energy management pyramid with SIMATIC Energy Suite and SIMATIC Energy Manager	94

Fig.	Title	Page
<b>Chapter 9</b>		
9/1	Distances to obstacles	96
9/2	Gangway widths and passage heights	96
9/3	Minimum widths of gangways in case of evacuation acc. to IEC 60364-7-729	97
9/4	Cubicle arrangement for single-front (top) and double-front switchboards (bottom)	98
9/5	Permissible deviations in the installation area	99
9/6	Installation on false floors	99
9/7	Foundation frame fixing on concrete	99
9/8	Fixing points of single- and double-front switchboards	99
9/9	Fixing points for the corner cubicle	100
9/10	Cable entry for cubicles with busbar position at the top	100
9/11	Cable entry for cubicles with busbar position at the rear	101
9/12	Cable entry for double-front cubicles with busbar position in the center	101
<b>Chapter 10</b>		
10/1	Tasks and objectives of the arc fault protection	107
10/2	Arc barrier in SIVACON S8	108
10/3	Insulated main busbar in the SIVACON S8 (N insulation optional)	109
10/4	Function of the active arc fault protection for SIVACON S8	110
10/5	AQD systems (AQ 100 and DEHNshort) for SIVACON S8	110
10/6	Design of the arc fault protection system in SIVACON S8	110
10/7	Comparison of seismic scales for the classification of seismic response categories of SIVACON S8	112
10/8	EU Declaration of Conformity for SIVACON S8 in respect of the Low Voltage and EMC Directives	114
10/9	Declaration of Conformity for SIVACON S8 regarding design verification	115
10/10	Declaration of Conformity for SIVACON S8 regarding design verification – Annex Page 1/2	116
10/11	Declaration of Conformity for SIVACON S8 regarding design verification – Annex Page 2/2	117
<b>Chapter 11</b>		
11/1	Systems by type of connection to earth in accordance with IEC 60364-1	120
11/2	Line diagram for an earthing concept based on a central earthing point (CEP)	121
11/3	Double earth fault in the IT system	122
11/4	Schematic current-time curves for the starting of motors with efficiency classes IE1/IE2 and IE3/IE4	127

## Imprint

Totally Integrated Power – Consultant Support  
SIVACON S8  
Technical Planning Information

### Published by

Siemens AG  
Smart Infrastructure  
Electrification & Automation

### Editor

Siemens AG  
Tanja Berger  
E-mail: [tanja.berger@siemens.com](mailto:tanja.berger@siemens.com)

### Printed by

TV Satzstudio GmbH  
Neidhardswinden 63  
91448 Emskirchen, Germany

### Image Rights

All images and all graphics: © Siemens AG

Subject to change without prior notice. The information in this manual only includes general descriptions and/or performance characteristics, which do not always apply in the form described in a specific application, or which may change as products are developed. The required performance characteristics are only binding if they are expressly agreed at the point of conclusion of the contract.

SIVACON and TIP Totally Integrated Power are registered trademarks of Siemens AG. Any unauthorized use is prohibited. All other designations in this document may represent trademarks whose use by third parties for their own purposes may violate the proprietary rights of the owner.

All data and circuit examples without engagement.

## Siemens AG

Smart Infrastructure  
Electrification & Automation

Mozartstr. 31c  
91052 Erlangen

Germany

E-Mail: [consultant-support.tip@siemens.com](mailto:consultant-support.tip@siemens.com)

Article No.: SIDS-T10092-00-7600

Dispo 27616

06/2022 (12210.5)

All rights reserved.  
Nominal fee of €3.