



## Syllabus Content:

### Main memory

-  show understanding of the need for primary storage.
-  explain the differences between RAM and ROM memory
-  explain the differences between Static RAM (SRAM) and Dynamic RAM (DRAM)

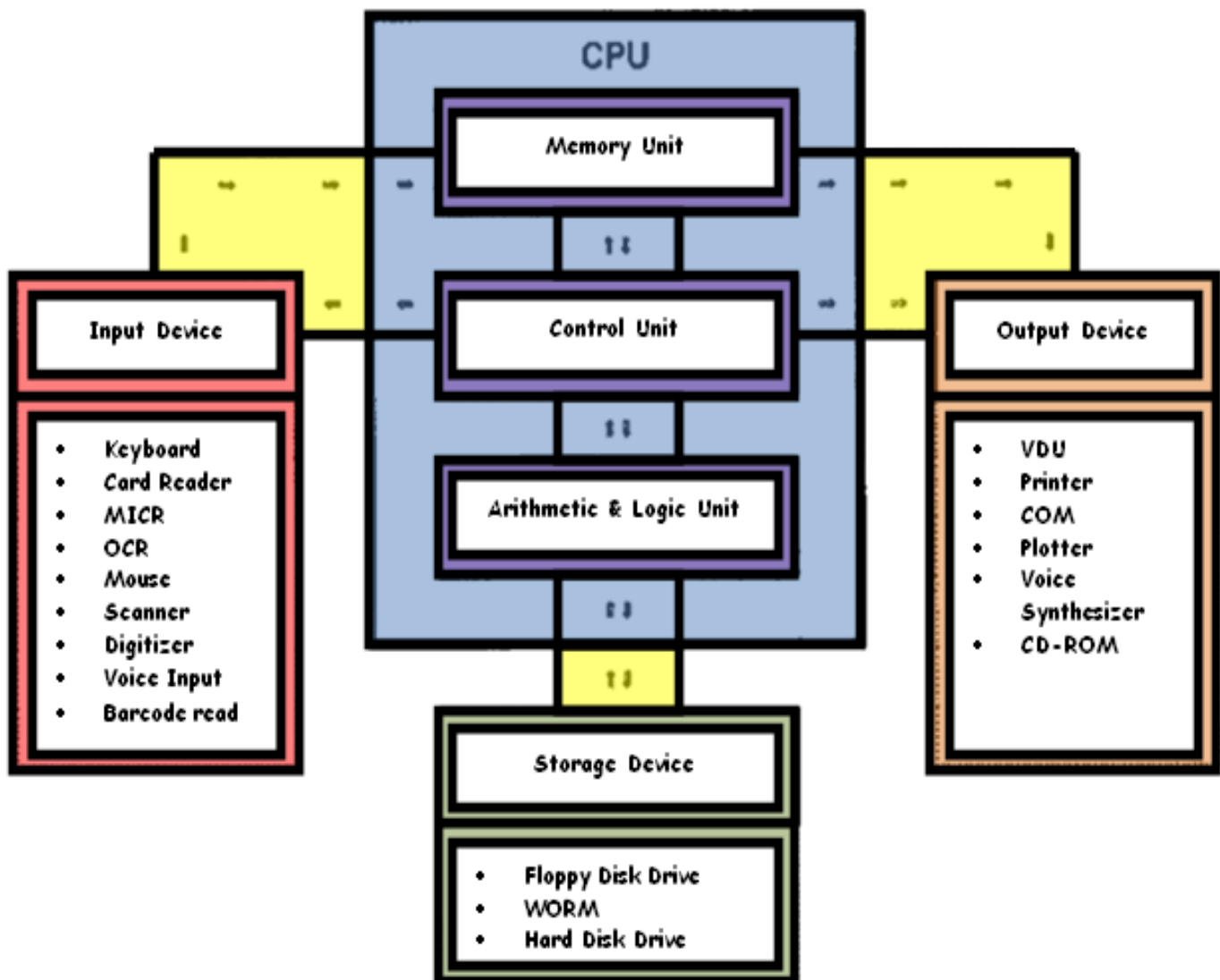

## Main Memory:

## Data Storage:

In a computer, storage is the place where data is held in an electromagnetic or optical form for access by a computer processor. There are two general usages:

1) Storage is frequently used to mean the devices and data connected to the computer through input/output operations - that is, hard disk and tape systems and other forms of storage that don't include computer memory and other in-computer storage.

2) In a more formal usage, storage has been divided into:

- a) **Primary storage:** Holds data in memory (sometimes called random access memory or **RAM, ROM**) and other "**built-in**" devices such as **the processor's L1, L2 cache**. Processor's **MEMORY CACHE** is the high speed portion of the memory; it is effective because most programs access the same data or instructions many times.
- b) **Secondary storage:** Holds data on hard disks, tapes, and other devices like USB, SD Cards, Zip and Floppy Disks and Optical disks etc.

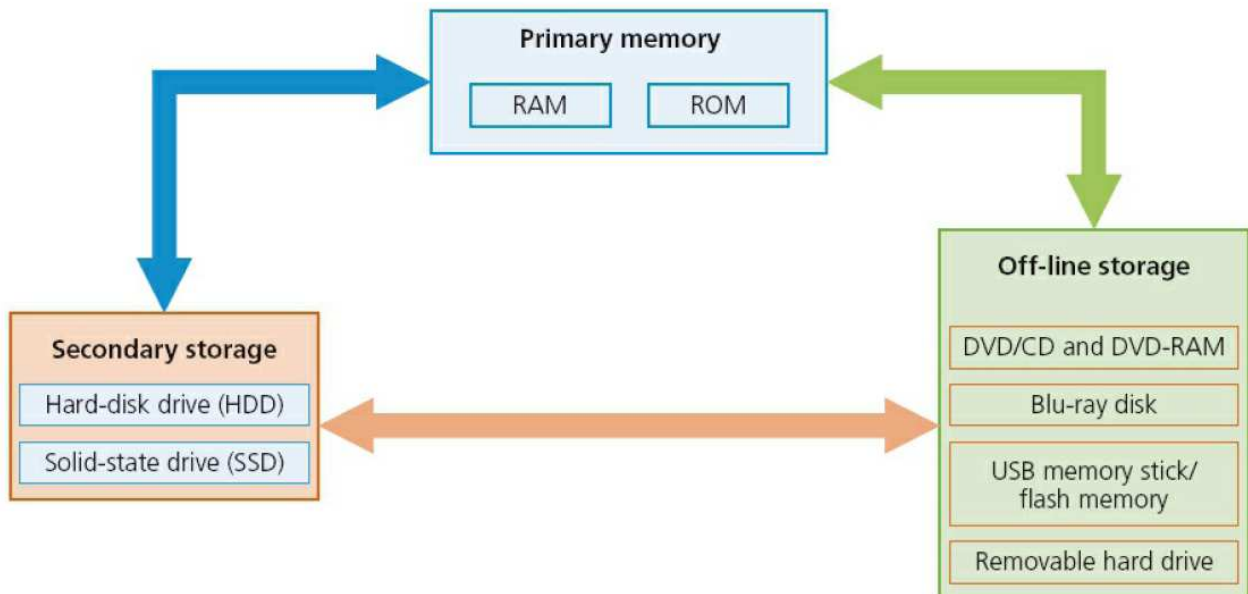

Primary storage is much faster to access than secondary storage because of the proximity of the storage to the processor or because of the nature of the storage devices. On the other hand, secondary storage can hold much more data than primary storage.

## Primary memory Random Access Memory (RAM)

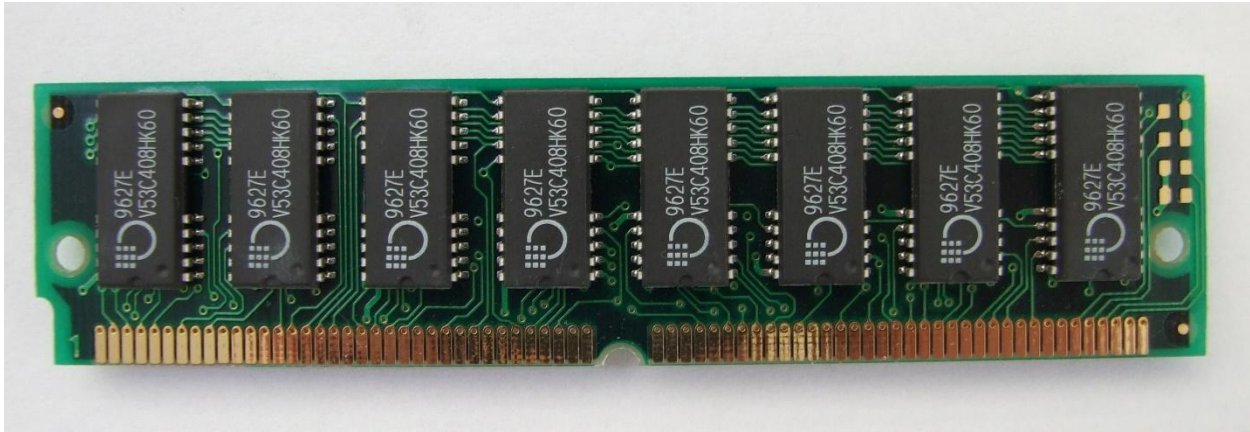

The features of RANDOM ACCESS MEMORY (RAM) are:

- 🟢 it is volatile/temporary memory (the contents of the memory are lost when the power to the RAM is turned off)
- 🟢 it is used to store:
  - data,
  - files,
  - or part of the operating system that are currently in use
- 🟢 it can be written to or read from and the contents of the memory can be changed.

In general, the larger the size of RAM the faster the computer will operate.

In reality, the RAM never runs out of memory; it continues to operate but just gets slower and slower. As the RAM becomes full, the processor has to continually access the hard disk drive to overwrite old data on RAM with new data.

By increasing the RAM size, the number of times this access operation is carried out is reduced, making the computer run faster. RAM is much faster to write to or read from than other types of memory; but its main drawback is its volatility.

Buffers are often use RAM since they need to be a fast memory and the data only needs to be held temporarily. As outlined earlier, buffers allow the processor to do other tasks while slower peripheral devices send data to and receive data from the computer.

There are currently two types of RAM technology:

- 🟢 Dynamic ram (DRAM)
- 🟢 Static RAM (SRAM).

## Dynamic RAM (DRAM)



Each DYNAMIC RAM (DRAM) chip consists of a number of transistors and capacitors.

Each of these parts is tiny since a single RAM chip will contain millions of transistors and capacitors. The function of each part is:

- 🟢 **Capacitor** – this holds the bits of information (0 or 1).
- 🟢 **Transistor** – this acts like a switch; it allows the chip control circuitry to read the capacitor or change the capacitor's value.

This type of RAM needs to be constantly REFRESHED (that is, the capacitor needs to be recharged every 15 microseconds otherwise it would lose its value). If it wasn't refreshed, the capacitor's charge would leak away very quickly, leaving every capacitor with the value 0.

DRAMs have a number of advantages over SRAMs:

- 🟢 They are much less expensive to manufacture than SRAM
- 🟢 They consume less power than SRAM
- 🟢 They have a higher storage capacity than SRAM.

## Static RAM (SRAM)

A big difference between SRAM and DRAM is that this type of memory doesn't need to be constantly refreshed. It makes use of 'flip flops' which hold each bit of memory. SRAM is much faster than DRAM when it comes to data access (typically, access time for SRAM is 25 nanoseconds and for DRAM is 60 nanoseconds).

DRAM is the most common type of RAM used in computers, but where absolute speed is essential, then SRAM is the preferred technology.

For example, the processor's MEMORY CACHE is the high speed portion of the memory; it is effective because most programs access the same data or instructions many times. By keeping as much of this information as possible in SRAM, the computer avoids having to access the slower DRAM.

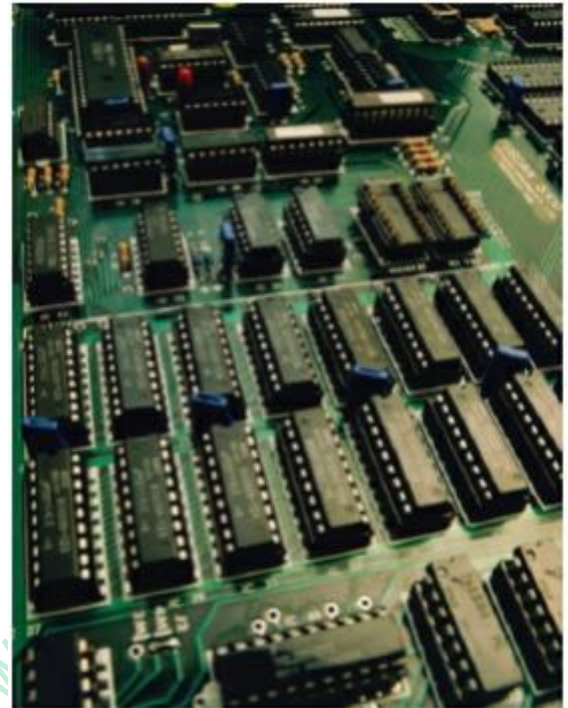

## Read Only Memory (ROM)

The main features of READ ONLY MEMORY (ROM) can be summarised as follows:

- They are non-volatile/permanent memories (the contents of the memory remain even when the power to the ROM is turned off)
- They are often used to store the start-up instructions when the computer is first switched on (for example, ROM might store the basic input/output system (BIOS))
- The data or contents of a ROM chip can only be read; they cannot be changed.

## Application

We will now consider an application, other than a computer, where both RAM and ROM chips are used. A remote-controlled toy car has a circuitry which contains both RAM and ROM chips. The remote control is a hand-held device. We will consider the function of each type of memory independently:

### ROM

- stores the factory settings such as remote control frequencies
- stores the 'start-up' routines when the toy car is first switched on
- stores the set routines; for example, how the buttons on the hand-held device control turning left, acceleration, stopping, and so on.

### RAM

- the user may wish to program in their own routines; these new instructions would be stored in the RAM chip
- the RAM chip will store the data/instructions received from the remote control

References:  
IGCSE Computer Science by Hodder Education.

LLB (IT Skills) with Sir Majid Tahir at [www.majidtahir.com](http://www.majidtahir.com)