

## PIPE EQUIPMENT SPECIALISTS LTD PRODUCT SUMMARY

### PIPE BEVELLING MACHINES

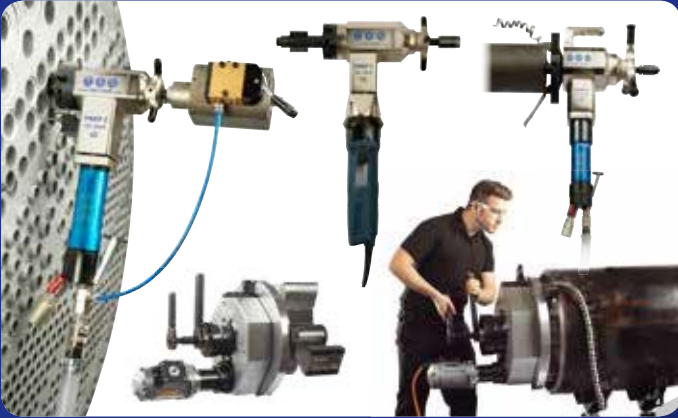

### PIPE CUTTING MACHINES



### PIPE ALIGNMENT CLAMPS



### PIPE STANDS AND ROLLERS



### PIPE PURGING EQUIPMENT



### PLATE BEVELLERS





## PIPE EQUIPMENT SPECIALISTS LTD



### About Us

With headquarters in the UK, TAG-PIPE was founded by Anthony Tagliaferro who started in the manufacture and supply of pipework fabrication machinery, tools and handling equipment in 1985, having previously worked as a welder, fabricator and toolmaker.

Over recent years TAG-PIPE has grown significantly through focusing on the importance of being close to our customers. In 2012 we opened a branch in Europe (Belgium), in 2013 a branch in the USA (Houston), in 2014 a branch in Asia (China), in 2015 a branch in Middle East (Dubai) in 2016 a branch in India (Pune) and most recently in 2017 a branch in Vietnam (Ho Chi Minh City).

Today, with offices and warehousing in 7 countries, on 4 continents, 70 employees and more than 180 partnerships and distributors worldwide, we pride ourselves in consistently offering the highest standard of both product quality and service to all our customers.

We look forward to welcoming you into our global network as a TAG-PIPE partner, distributor or end user customer and remain at your disposal at any time.

### Products

TAG-PIPE is extremely proud to be established and recognised as one of the world's leading manufacturers and suppliers of:

- Pipe Beveling Machines
- Pipe Cold Cutting Machines
- Pipe Flame Cutting and Beveling Machines
- Pipe Alignment/Welding Clamps
- Pipe Jack Stands
- Pipe Purging Equipment
- Pipe Tools
- Pipe Stoppers
- Plate Beveling Machines

### Mission Statement

*"At TAG-PIPE we aim to offer our customers a comprehensive, top quality, competitive and unrivalled range of pipework machinery and tools, this backed with great customer service supported by our 6 branches strategically located on 4 continents and our extensive and continuous expanding global network of partners and distributors."*

**Aidan Tagliaferro, Managing Director**

### Industries

Our products are used in both workshop and on-site environments across various Industries worldwide including:

- Oil and Gas
- Pipelines
- General Fabrication
- Offshore Welding
- Ship Building
- Vessel Manufacturing
- Power Generation
- Boiler Industry
- Petrochemical
- Pharmaceutical
- Refineries
- Turbine
- Nuclear
- Heat Exchangers
- Dairy, Food and Beverages and many more...



[www.TAG-PIPE.com](http://www.TAG-PIPE.com)

*Our company policy is one of continuous improvement. Products may change or vary from those illustrated.*



## Customer Service

We work extremely hard supporting and training our team of employees and network of partners and distributors to ensure that from TAG-PIPE you always receive the:

- Fastest Response Times
- Quickest Delivery Times
- Most Knowledgeable and Accurate Advice
- Committed After Sales Support



## Level of Stock

TAG-PIPE carry an unrivalled stock level, meaning no matter how large your order we expect to offer you the fastest delivery time available worldwide.

## Price

You will find our pricing to be very competitive. Give us an opportunity to quote your next project and we are confident you will be pleased! For your convenience we offer our products in the three major currencies: US Dollars, Euros and GB Pound.

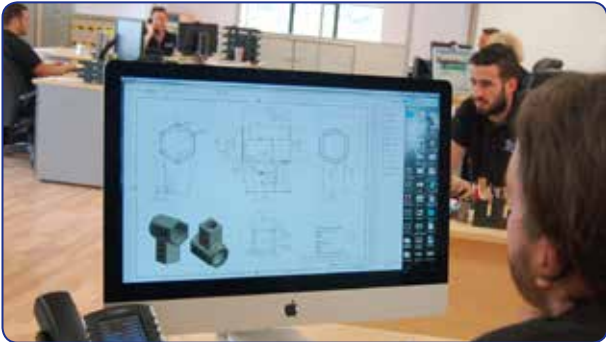

## Research and Development

Technology is always improving. At TAG-PIPE we firmly intend to move with the times and to be the trendsetters in our industry with a dedicated team of designers and technicians devoted to improving our existing products as well as innovating the next generation of pipework machinery and tools.



## Production, Assembly and Quality Control

With manufacturing partners in UK, Belgium and Italy, TAG-PIPE are proud to offer the highest quality of components manufactured wholly in Europe. All our machines are assembled in our UK facility and undergo vigorous testing and quality control, which is backed by our products being CE Certified, having Certificates of Conformity, UK Certificate of Origin and our company being ISO9001 accredited.



## Demonstrations and Training

We love to show off our products unrivalled performance and are always happy to carry out demonstrations either in our showroom facility in the UK or at your site. In addition we understand the importance of the correct operation of our machinery and tools so also offer training packages again either in our UK training facility or at your site ensuring safe, efficient and accurate operation.



## Rental Division

TAG-PIPE operates a Full, Worldwide Hire and Rental Service. With currently more than 300 machines, our hire fleet is constantly expanding. A large investment was made in 2016 with additional machinery as well as a new tailored hire software system to simplify all of your hire needs making us the best stop for all your pipework equipment rental needs.

**Please contact our designated Hire Department via any of these means: Tel: +44 (0)1869 324 144 or E-mail: [hire@tag-pipe.com](mailto:hire@tag-pipe.com)**

# PIPE BEVELLING MACHINES



**TAG Pipe Beveling Machine  
PREP 2**

**½" - 1½" (23mm - 42mm i/d)  
(optional 12.5mm)**

The smallest in our range of i/d locking, direct in-line feed end prep machines. The PREP 2 is small, light weight, yet powerful, in electric (110v or 220v), pneumatic drive or battery form.

Simultaneous external and internal beveling and facing of pipe or tubes is simple, ideal for accurate repetitive work. Its size, power and functionality, make it extremely popular in high volume heat exchanger work, tube facing, weld removal and J-prepping of the tube plate.

Available in 110v or 220v power supply.



**TAG Pipe Beveling Machine  
PREP 3**

**1" - 3" (28mm - 76mm i/d)  
(optional 20mm)**

The PREP 3 is one of our most popular i/d locking, in-line feed end prep machines. The PREP 3's power to weight ratio, in electric (110v or 220v), pneumatic drive or battery form is unrivalled.

Simultaneous external and internal beveling and facing of tubes can be performed with ease for accurate repetitive work. Its size, power and functionality, makes it extremely popular in high volume boiler repair and maintenance work, tube facing, weld removal, and J-prepping of the tube plate.

Available in 110v or 220v power supply.



**TAG Pipe Beveling Machine  
PREP 4**

**1" - 4" (23mm - 112mm i/d)**

The PREP 4 is a very popular versatile machine that is robust and extremely powerful. Used in many industries but commonly found in tough in-situ environments, such as power station shut downs.

The PREP 4 boasts an increased locking range of 1" to 4" i/d and is available in pneumatic, electric or battery.

Available in 110v or 220v power supply.



**TAG Pipe Beveling Machine  
PREP 8**

**2" - 8" (50mm - 207mm i/d)**

One of our most powerful and popular small diameter i/d locking, in-line feed end prep machines. This is mainly due to its impressive 2" to 8" working range and unrivalled power.

The PREP 8 is a portable, one man operation machine, its power to weight ratio, and offset 4 jaw tool holder (chuck) allows use of up to 4 insert or form tools to enable simultaneous external, internal beveling of even the heaviest wall pipe and tube, on site, or in the fabshop.

Available in 110v or 220v power supply.

## OPTIONS:



**Battery Motor**



**Ratchet Handles**

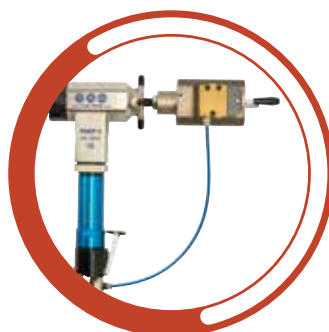

**Auto Locking**



**Elbow Shafts**

# PIPE BEVELLING MACHINES



## **TAG Pipe Beveling Machine**

### **PREP 16**

**3" - 16" (72mm - 385mm i/d)**

The PREP 16 is the first in TAG's new range of a heavy duty large diameter beveling machines.

Offering ratchet i/d jaw locking, as well as ratchet bevel feed control for effortless heavy wall preps. Offered with a 3 HP pneumatic or 1750 Watt electric motor any bevel geometry can be performed with in the impressive 3" to 16" range.

J-preps, counter boring, and facing can all be performed, simultaneously, due to its light weight, yet unrivalled power, the PREP 16 is ideal for on-site, off shore, nuclear, and other applications where precision welds are required.

Available in 110v or 220v power supply.



## **TAG Pipe Beveling Machine**

### **PREP 20**

**4" - 20" (100mm - 500mm i/d)**

The PREP 20 is an extremely powerful beveling machine, designed to give long life and accurate weld preparations in tough in-situ or engineering workshop environments.

Fully torque reacted throughout its complete range, it uses one centre heavy duty 4" locking shaft with built in plug jaws for rapid set up. Change over time from one diameter to another is achieved quickly and simply.

The PREP 20 is available in pneumatic or with a 3200 Watt heavy duty electric motor.

Available in 110v or 220v power supply.



## **TAG Pipe Beveling Machine**

### **PREP 24**

**7" - 24" (180mm - 600mm i/d)**

A powerful, heavy duty electric or pneumatic motor drives a reduction gearbox converting 3.5 HP into 12500 Nm of torque!! Rigidity and unrivalled beveling strength are ensured with a 5.9" Locking Shaft with built in plug jaws, a bolt in 6 point locking system allows the PREP 24 to cover an impressive range of 7" to 24"!

Both locking and feeding are controlled by ratchet, enabling the operator to lock into the pipe in seconds, and provide a consistent bevel feed, for the perfect surface finish, even on heavy wall pipes.

Available in 110v or 220v power supply.



## **TAG SPBM (Stationary Pipe Beveling Machine)**

**2" - 80" (50mm - 2,034mm)**

The SPBM range of stationary pipe end beveling machines are specifically designed for production of end bevels on pipes, quickly, accurately and simply.

Thanks to the stability of the SPBM Machines, every end prep is identical. These machines are the answer to Pipe fabshop requirements for maximum productivity. All materials of pipe can be bevelled. Machines can be supplied as manual, or electrically automated locking and feeding versions.



## **TAG High Speed Cutting and Beveling Machine**

**2" - 24" (50mm - 610mm)**

Automated, super fast, CNC operated pipe cutting and double beveling machine. The perfect machine for bulk pipe work prefabrication. This machine has a fully automated front and back clamping systems, automatic feeding, built in coolant system, all being controlled by a touch screen computer with programmed, easy to use pre-set parameters for all jobs.

# PIPE CUTTING MACHINES



## **TAG E-Z Fab Pipe Cutting and Beveling Machine**

**30mm - 620mm**

A self-centering, semi portable heavy duty dedicated Pipe Cutting and Beveling machine.

Operated via a Touch-Screen Delta Control, delivering signal to a heavy duty servo motor, giving the E-Z Fab unrivalled power and torque, for heavy duty material and wall thickness applications.

Never before has heavy duty process pipe cutting been so easy.

**6" Steel pipe with 22mm wall thickness – loaded into machine, cut and bevelled in 6 minutes 20 seconds!!!**

Available in 110v or 220v.

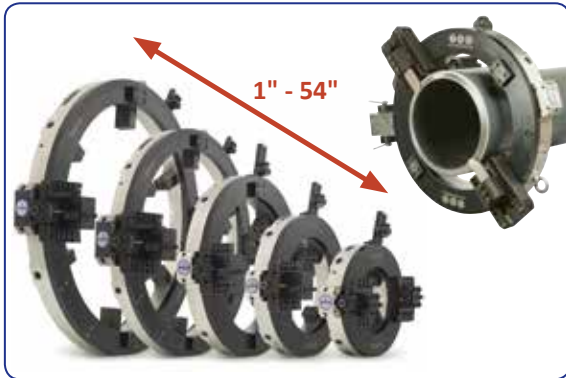

## **TAG Aluminium Split Frame Clamshells Cutting and Beveling Machines**

**25mm - 1,372mm**

The TAG Split Frame Clamshell range of portable cold pipe cutting and beveling machines are designed for ease of use, even in difficult situations.

Thanks to their low profile frame they are the perfect machines for use when access to the pipe is restricted.

The TAG range of Cut and Prep Split Frame Clamshells are available with pneumatic, servo electric motors and hydraulic motors, and will cover a range from 1" to 54" o/d (6" range per ring).

Larger sizes are available on request. Cutting and beveling can be performed simultaneously; any type of weld prep can be achieved including compound angles and "J-preps".



## **TAG Cutting and Beveling Machines**

### **Heavy Duty Steel Split Frame Clamshell**

**48" - 108"**

TAG also manufactures heavier duty steel construction split frame cutting and beveling machines. Rugged in design, and built to stand up to the most arduous of site conditions.

Available in pneumatic, electric and hydraulic power supplies, the TAG heavy duty Clamshell Cut and Prep machines can cut and bevel pipes of almost any wall thickness and any material.



## **TAG Pipecut Orbital Pipe Saws (OPS)**

**¼" - 12" (6mm - 300mm)**

The TAG Pipecut Bench Mounted Orbital Pipe Saws are the low cost and practical solution to cut almost all types of metal pipe. Cutting is executed by manually rotating the machine around the pipe. The pipe is cut with one rotation. It is powered by a powerful and sturdy electric motor equipped with speed regulator. The pipe saws produce a square, burr-free cut that does not require any further dressing.

Four models are available in the range, the TAG OPS R4 (¼" - 4½"), the TAG OPS R6 (3" - 6"), the TAG OPS R8 (6" - 8") and the TAG OPS R12 (8" - 12").



## **TAG E-Z Pipe Saw**

**1" - 24" o/d (25mm - 600mm)**

A powerful reciprocating saw, ideal for use on site.

The light weight construction and ease of set up makes the E-Z Pipe Saw ideal for site work applications. By using the pipe locking vice or chain locking device the E-Z Pipe Saw produces square cuts. The E-Z Pipe Saw is also capable of mitre cutting angles of up to 45° on up to 4" pipe. Using the correct blades most materials can be cut including stainless steel and duplex.

The E-Z Pipe Saw is available in pneumatic and electric.

# PIPE FLAME CUTTING MACHINES

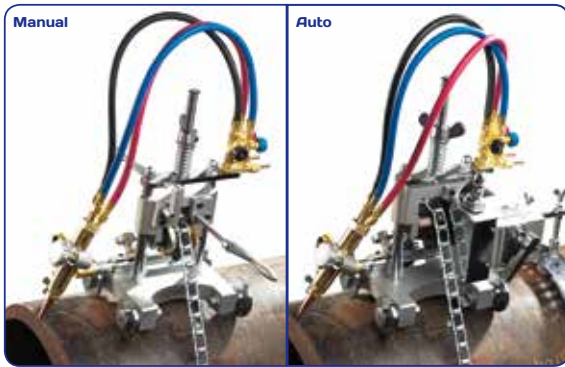

## TAG E-Z Pipecut Manual Flame Cutter 4" upwards

TAG's E-Z Pipecut portable flame cutting and bevelling chain driven machines are the economical solution for cutting and bevelling pipe from 4" upwards. The E-Z Pipecut is small and compact, strong and reliable. This machine is manually hand cranked around the pipe by the operator.

## TAG E-Z Pipecut Auto Flame Cutter 4" upwards

TAG's E-Z Pipecut is also available as an automatic model. Driven around the pipe by an electric motor with a remote control, once the speed is set correctly to the wall thickness of the pipe the E-Z Pipecut Auto will cut and bevel the pipe without the need for intervention from the operator. Available in 110v or 220v power supply.



## TAG E-Z Pipecut Magnetic Flame Cutter 4" upwards

A new addition to TAG's Flame Cutting range is the E-Z Pipecut Magnetic, two sets of magnetic rollers are built into the machine body to hold the machine to the pipe as cutting and bevelling is performed.

The TAG E-Z Pipecut Magnetic can be used for parallel, vertical and inverted cutting.

The machine body is made from aluminium making the E-Z Pipecut Magnetic light weight, yet durable.

TAG offers a guide band assembly to ensure 100% square cuts and bevels on pipe diameters above 16".

Available in 110v or 220v power supply.

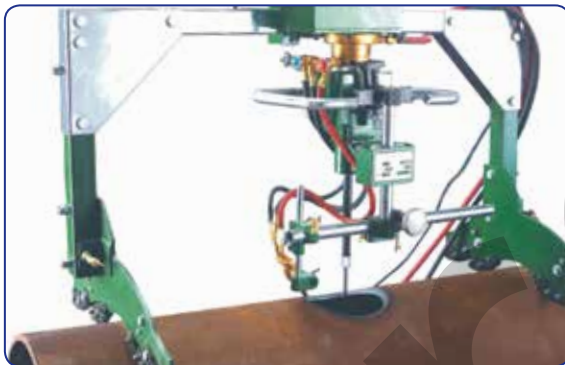

## TAG E-Z Pipecut Hole Cutter 3" - 24" (80mm - 600mm)

TAG's E-Z Pipecut Hole Cutter is designed for cutting precise T-joint circles, or any hole on the surface of pipes, pressure vessels and heat exchangers.

This can be done from the inside or the outside of the vessel.

Easy to operate, light weight and compact in design, the E-Z Pipecut Hole Cutter will also cut and bevel holes into flat plates.

Available in 110v or 220v power supply.



## TAG E-Z Pipecut Short Saddle Machine 2" - 36" o/d

Designed for cutting and bevelling fish mouth, shapes and contours on pipes. Our short saddle machines are the only single piece, short saddle machine on the market, providing you with consistently square and accurate cuts - cut after cut - year after year.

Our short saddle machines can be used for plasma or water jet cutting in either the vertical, or horizontal position. They are designed to be dropped on the pipe like a saddle or slipped on from the end.

**NOTE: ALL TAG E-Z PIPECUT MACHINES CAN BE SUPPLIED FOR USE WITH OXYACETYLENE OR PROPANE. ATTACHMENTS TO SUIT PLASMA TORCHES ARE ALSO AVAILABLE FOR CERTAIN MODELS.**

# FLANGE FACING MACHINES



## TAG FLANGE FACING MACHINES

i/d and o/d locking available 0" - 275"

TAG offers an extensive range of both i/d and o/d locking machines, for flange facing, seal groove machining, weld preparation and counter-boring. The TAG range of Flange Facers feature innovative locking and self centering (on certain models), combined with multi-position motor for power transmission, enabling unmatched rigidity compared with similar machines, especially in applications on larger diameters where greater accuracy can be guaranteed.

Variable auto feed for radial and axial movements make the TAG Flange Facing machines ready for any on-site repair.

# PLATE BEVELLING MACHINES



## TAG PMM155 Handheld Plate Beveller

From 1.5mm Plate thickness

TAG's range of handheld beveling machines are the most durable and versatile on the market. The range is capable of beveling and radiusing straight edges, shapes, contours and holes from 20° to 60°.

Using tungsten carbide inserts the machines can bevel from 1.5mm up to 40mm on Aluminium plate and an impressive 16mm on Carbon and Stainless Steel!!

These units can also be used for dressing and de-burring, and is available with a range of radius heads and inserts. Available in electric 110v or 220v power supply.



## TAG PMM200 and PMM200SS Handheld Plate Bevelers

Plate thickness 6mm - 60mm (21mm max bevel width)

The PMM200 is a new generation, easy to use, portable, heavy duty machine designed for beveling steel plates prior to welding. This beveling machine is fitted with two milling heads each holding six inserts, allowing smooth operation and exceptional efficiency, capable of angles from 0° to 60°.

The PMM200 incorporates many safety features. It has a state of the art electronic control module protecting the operator, machine and tools. It is equipped with guide rolls, which make it easy and light to operate.

TAG have now released the PMM200SS Model, this model is dedicated to the beveling of stainless steels, and other harder materials.



The TAG Plate Bevel Pro 18 is also available as an upside-down version.

## TAG Plate Bevel Pro 18

Plate thickness ¼" - 1½" (18mm max bevel width)

The TAG Plate Bevel Pro 18 is our most popular portable plate edge-beveling machine. As with all models the TAG Plate Bevel Pro 18 offers automatic self-feeding of the plate when beveling small strips or, once positioned on a large plate will travel along the edge with no requirement for intervention by the operator. Angles from 22.5° to 55° can be machined without any additional accessory.

The TAG Plate Bevel Pro 18 is fitted with a two-speed motor, enabling the operator to reduce the speed according to the material to be machined, thus dramatically increasing the life of the milling tool when beveling stainless steel and more exotic materials.



The TAG Plate Bevel Pro 28 is also available as an upside-down version.

## TAG Plate Bevel Pro 28

Plate thickness ⅝" - 2" (28mm max bevel width)

The TAG Plate Bevel Pro 28 gives a clean, bevelled, weld ready surface with no thermal distortion saving time and money. As with all models the TAG Plate Bevel Pro 28 offers automatic self-feeding.

The TAG Plate Bevel Pro 28 can bevel radii and curved plate such as a pre-rolled vessel/heat exchanger.

The TAG Plate Bevel Pro 28 is fitted with a two-speed motor, enabling the operator to reduce the speed according to the material to be machined, thus dramatically increasing the life of the milling tool when beveling stainless steel and more exotic materials.



2 Plate Beveling Machines In One!!!

## TAG Plate Bevel Pro HS50

Plate thickness ⅝" - 3" (70mm) (62mm max bevel width)

The most powerful high speed portable plate edge beveller in the world, the HS50 is capable of beveling plate thicknesses of up to 70mm with a maximum bevel width of an incredible 62mm - at any angle from 15° to 60°!

**THE HS50 CAN BEVEL THE TOP, OR THE UNDERSIDE OF THE PLATE, DUE TO ITS UNIQUE 3D CRADLE.**

Using a high speed milling head with tungsten carbide inserts, the HS50 leaves a superior mirror finish, bevel, perfect for welding and also cosmetic purposes, such as ramps or floor plates. When you need big bevels, on heavy plate, the TAG Plate Bevel Pro HS50 is the answer.



# PIPE ALIGNMENT CLAMPS

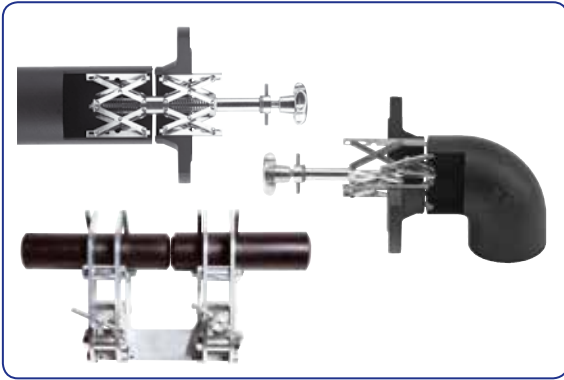

## TAG E-Z Fit Internal Spider Alignment Clamps

10mm - 940mm i/d

A new addition to our range of welding fit-up clamps is the Spider series of internal clamps. These i/d locking clamps enable one man operation in the fit-up of a variety of fittings, including elbows, flanges, T-pieces from 10mm to 940mm i/d.

The unique locking system enables the operator to make minor adjustment to the fit-up prior to welding. When you need rapid and precise fit-ups, the Spider series of pipe clamps are the answer.



## TAG E-Z Fit Red Pipe Clamps

1" - 12" o/d

As the name suggests the E-Z Fit Red Pipe Clamps are quick and easy to use. Three sizes of clamps are available covering a range of pipe from 1" to 12" nominal bore. Instant centring combines speed accuracy and safety. These clamps are used on pipe-to-pipe, flanges, elbows, T-pieces and reducers.

The E-Z Fit Red Pipe Clamps can be used on stainless steel without any additional accessories due to the feet and screws being made from stainless steel, preventing contamination of the pipe.

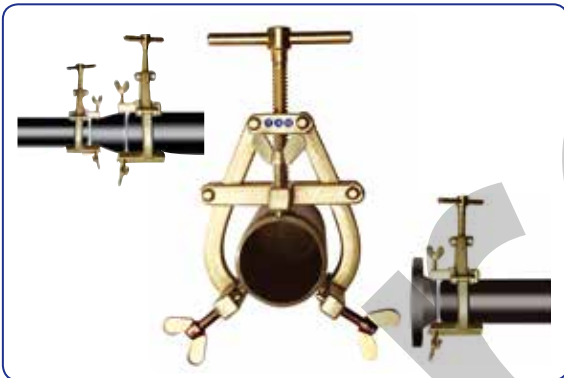

## TAG E-Z Fit Gold Pipe Clamps

1" - 14" o/d

The E-Z Fit range boasts a range from 1" to 14" o/d and manufactured from forged steel for increased strength.

Stainless steel roller balls are fitted as standard to the wing bolts.

The E-Z Fit Gold Clamps can be used on stainless steel by fitting the optional stainless steel feet to prevent contamination.



## TAG E-Z Fit Single Chain Pipe Clamps

1" - 72" o/d

Designed to offer the welder the best of both worlds. Firstly, a clamp with the strength and ability to align and lightly reform pipes, and secondly, light weight design and construction for ease of use. The feet of the clamp can be positioned equally around the chain to achieve an accurate pipe alignment in very little time.

The E-Z Fit Single Chain Clamp can fit up elbows, T-pieces, flanges, end caps and most other pipe fittings. Models are available for carbon and stainless steel.

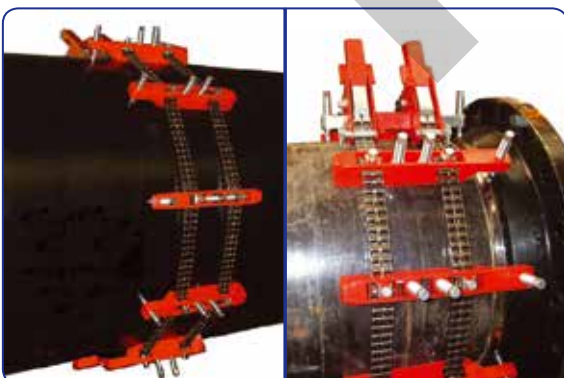

## TAG E-Z Fit Double Chain Pipe Clamps

10" - 240" o/d

Our E-Z Fit range of Double Chain Pipe Clamps are designed for the aligning and reforming of pipes and vessels with diameters up to 6 meters (20') with large schedules, our design can reform up to schedule 80 and align all schedules.

Our specialised heavy duty clamping feet and double chain lock devices can deal with the most difficult of reforming jobs with operational ease. These clamps can be supplied for use with Carbon or Stainless Steel and all clamps are supplied in their own durable colour coded storage cases. These clamps are the strongest on the market.

# PIPE STANDS



## TAG Fixed Pipe Tri-Stands

Our Fixed Pipe Stands are the best on the market, constructed from box section for strength and safety.

**Pipe Size Capacity: 1" - 12" (Optional up to 24")**

**Pipe Load Capacity: 1.5 Ton / 1,585kg / 3,500lbs**

**Height Adjustable: 71cm - 122cm / 27.5" - 48"**

Our pipe stands are available with a choice of slip-on, or interchangeable head styles for rotation or transferal movement of pipe and plate. Our ranges of pipe stands are the cost effective solution to any pipe handling problem.



## TAG Folding Pipe Tri-Stands

Designed with folding legs for easy storage and transportation and constructed from box section, giving identical strength and performance as our fixed stands.

**Pipe Size Capacity: 1" - 12" (Optional up to 24")**

**Pipe Load Capacity: 1.5 Ton / 1,585kg / 3,500lbs**

**Height Adjustable: 71cm - 122cm / 27.5" - 48"**

Our pipe stands are available with a choice of slip-on, or interchangeable head styles for rotation or transferal movement of pipe and plate. Our ranges of pipe stands are the cost effective solution to any pipe handling problem.

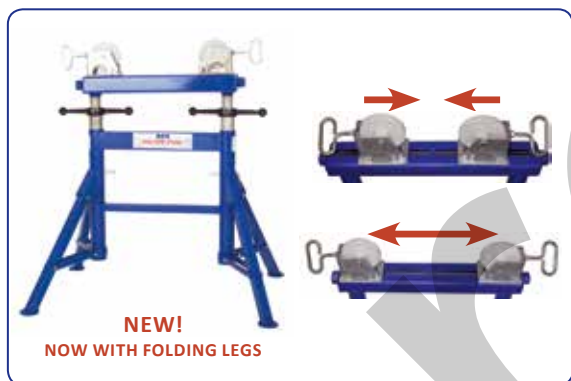

## TAG Duo Pipe Stands

The Duo Pipe Stands are height adjustable and use the quick 'change' self centering style heads, which can be locked to hold the pipe in position.

**Pipe Size Capacity: 2" - 36"**

**Pipe Load Capacity: 2.4 Ton / 2,400kg / 5,290lbs**

**Height Adjustable: 74cm - 122cm / 29" - 48"**

Roller wheel heads are available for rotation and ball bearing heads for transferal movement of both carbon and stainless steel pipe.



## TAG Quattro Pipe Stands

The Quattro Pipe Stands are the solution to heavy duty pipe handling.

**Pipe Size Capacity: 1" - 36"**

**Pipe Load Capacity: 2.2 Ton / 2,265kg / 5,000lbs**

**Height Adjustable: 61cm - 112cm / 24" - 44"**

The Quattro can be supplied with lockable castor wheels so pipe can be moved around a workshop or site, without using a crane or forklift. Head styles are available for rotational or transferal movement.

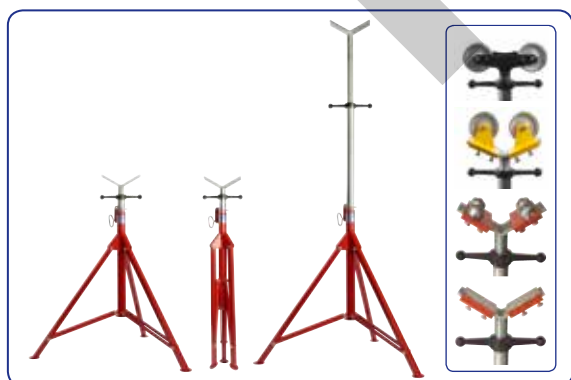

## TAG High Pipe Stand

The TAG Pipe 6ft (180cm) folding jack allows a pipe fabricator to hold pipe in a safe position up to 6ft tall.

**Pipe Size Capacity: 1" - 12"**

**Pipe Load Capacity: 0.45 Ton / 450kg / 1,000lbs**

**Height Adjustable: 99cm - 180cm / 39" - 72"**

The folding design with handle allows easy transportation into tight spaces and the bottom T-Handle locks the jack open while minimising stand wobble.

# PIPE STANDS AND ROLLERS



## TAG Tri Chain Vice Stand

A simple but effective solution to small bore pipe handling.

**Pipe Size Capacity:** ½" - 6"

**Height:** 36" / 91cm

The TAG Tri Chain Vice Stand is a proven design used in construction sites around the globe. TAG offer the same features and quality as other brands but at the most competitive price.



## TAG Mega Pipe Stands

The TAG Mega Pipe Stands fit nicely between the more common Pipe Jack and Pipe Stand lines and the much heavier duty Turning Roll products that are available in the market today.

**Pipe Size Capacity:** 4" - 60"

**Pipe Load Capacity:** 3 Ton - 8 Ton / 3,000kg - 8,000kg / 6,600lbs - 17,600lbs

The Mega Pipe Stand safely holds larger diameter heavy wall pipe off the ground at an ergonomic height, while allowing the slight height adjustment for fit ups via the twin 1¼" solid acme rods. You can also remove the wheels to use the V-Head to hold pipe rather than rotate.



## TAG Floor/Bench Mounted Pipe Stands

These stands are designed to be either floor or bench mounted. Available with 4 head styles to suit pipe from 2" to 48".

**Pipe Size Capacity:** 2" - 48"

**Pipe Load Capacity:** 2.4 Ton / 2,400kg / 5,290lbs

The floor/ bench stands can be used for pipe rotation, transferral movement, or both using the ball transfer head option. Nylon wheels are also available when working with stainless steel and other exotic materials to prevent contamination.



## TAG Pipe Rotators

Automated and Semi-Automated work handling systems

**Max Drive Cap:** 1.0 Ton / 1,000kg / 2,200lbs

**Turning Capacity:** 115mm - 500mm / 4" - 20"

**Wheel Linear Speed:** 0.2 - 2m/min

Our NEW entry level 1 Ton rotator set (1 drive unit + 1 idler) with foot pedal control and fine speed adjustment is proving to be most popular in fabrication workshops across the globe!

Available in 110v or 220v power supply.



## TAG Pipe Rack Rollers and Launchers

### Heavy Duty Beam Clamp and Rigging Rollers

- Twelve configurations from 1 Ton to 10 Ton capacities
- Three sizes from 2" to 60" pipe diameters
- Urethane wheels with sealed bearings
- Easy replace wheels bolt off and on in minutes
- Changes from rack roller to pipe launcher in minutes
- Comes ready to use on Stainless Steel

# PIPE HANDLING



## TAG Pipe Buggy and Dolly

**The safe and easy way to move pipe around the job site**

The Pipe Buggy offers a safe method of handling and moving pipes of up to 6.1m in length and 450kg around the workshop or site easily, avoiding damage to the pipe as a result of it being dragged along the ground.

TAG Pipe's Pipe Dolly is used in many field operations allowing the transportation of pipe without the need for a gas or electric powered lift.

	PIPE BUGGY	PIPE DOLLY
Pipe Size	1" - 12" (25mm - 323mm)	1" - 20" (25mm - 500mm)
Pipe Load Capacity	450kg / 990lbs	1,000kg / 2,200lbs
Pipe Length	6.1m (20')	7.3m (24')



## TAG Pipe Cradles and Slings

**TAG Pipe Cradles and Slings are an effective way to move pipe, specifically designed for pipeline installation projects**

- Durable 90a urethane coating designed for multiple uses
- Sealed anti-friction bearings
- Measures 4 inch thread width x 4.5 inch diameter
- Designed for use with 3/8" wire rope
- Machined hub for smooth wheel rotation



## TAG Fitup, Layout and Marking Tools

**TAG supply a comprehensive range of measuring, marking and layout tools for all pipe fitting and welding applications**

The range of products includes: Wrap-a-rounds, Contour Markers, Combination Adapters, Centering Heads, Flange Aligners, Radius Markers, Burning Guides and Soapstones. TAG offers a complete range of marking, measuring and layout tools and accessories for the pipe fitter/welder.

Rotary Earth Clamps are simple yet effective tools for eliminating earth lead twisting and tangling during work piece rotation. Providing a stable earth for circumferential welding of pipes and fittings and eliminating weld pinholes and imperfections caused by poor earthing.

# TUNGSTEN ELECTRODE GRINDERS



## TAG Handy Point Plus Tungsten Grinder

**The elite handheld grinding machine for tungsten electrode**

The Handy Point Plus is a portable Tungsten grinder that is both environmentally friendly and has the ability to grind repeatable quality points on Tungsten electrodes for TIG and plasma welding. The Handy Point Plus is equipped with an integrated, replaceable dust filter, protecting the operator and the environment against the potentially harmful dust produced during electrode grinding.

Available in 110v or 220v power supply.



## TAG Pro Point Plus Tungsten Grinder and Cutter

**The ultimate in electrode grinding for optimal TIG and Plasma welding**

The Pro Point Plus patented wet grinder demonstrates an eco friendly way to grind perfect, accurate angles on tungsten electrodes – and therefore perfect TIG or Plasma welding. Pro Point Plus is constructed with a unique disposal container that automatically collects all toxic dust particles, eliminating the need for a separate exhaust system. Cold wet grinding combined with the diamond wheels high grinding speed ensures that the tungsten electrode always has a polished and even surface. The Pro Point Plus is supplied with a cutting wheel to allow the cutting of electrodes as short as 10mm, perfect for orbital welding systems.

Available in 110v or 220v power supply.

# PIPE PURGING EQUIPMENT

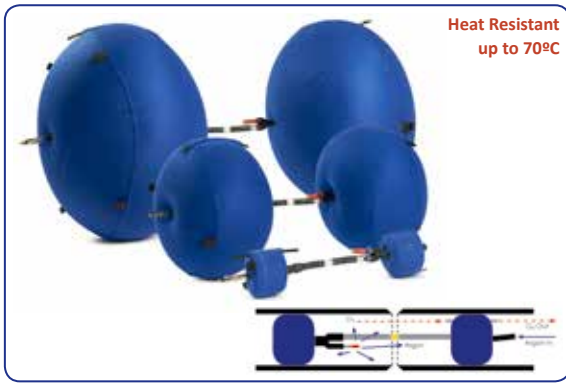

Heat Resistant  
up to 70°C

## TAG Purge Bag Systems

2" - 24" (50mm - 610mm)

Our Inflatable Pipe Purging Systems are designed to maximise time and minimise cost. Two inflatable bladders are joined by a armoured gas hose. Using inert gas (such as argon) to first inflate both bladders on either side of the weld before releasing the gas (via a pre set valve) into the chamber they have created, forcing the oxygen out through exhaust tubes built into the bladders. The Oxygen is removed so the welder can weld the pipes without the risk of oxidation.

Once the gas flow is stopped the bags deflate and are easily removed from the pipe. Used in conjunction with our Purge Monitors, these systems enable the welder to produce highest quality welds in very little time and with no Oxidisation.

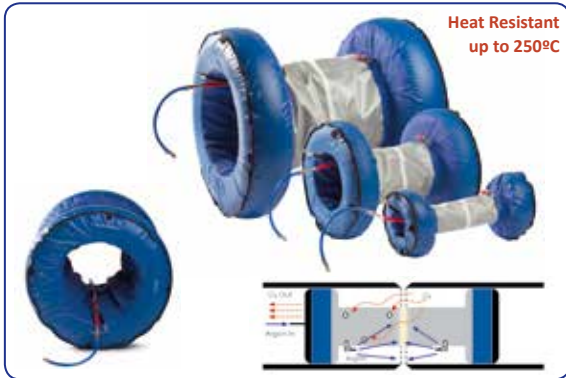

Heat Resistant  
up to 250°C

## TAG Rapid Purge Bag System

8" - 80" (190mm - 2,044mm)

The Rapid Pipe Purge systems take gas purging to the next level. The inflatable bladders are housed in heat resistant material. The unique design of these systems means that the volume to purge is further reduced, by localising it to the weld root. Whether 6" or 80" pipe, these light weight, yet rugged systems allow easy withdrawal from the pipe once deflated, even round bends and elbows! For fast, precise welds, with minimal gas usage, Rapid Purge is the solution for every pipe welder when the weld quality of exotic material is critical. Used in conjunction with our Purge Monitor, these systems enable the welder to produce highest quality welds in very little time and with no Oxidisation.

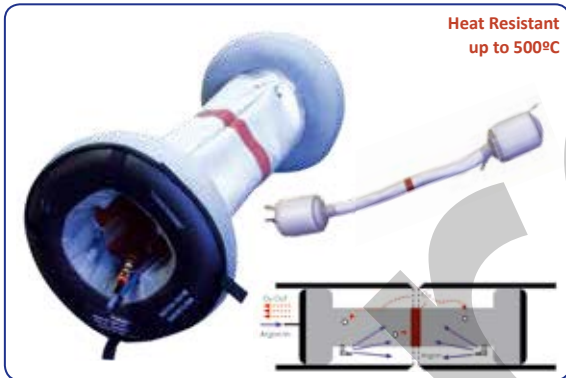

Heat Resistant  
up to 500°C

## TAG Heat Resistant Purge Systems

2" - 80" (50mm - 2,044mm)

The TAG Pipe Purge Bag, Rapid Purge Systems and Inflatable Pipe Stoppers are all available as heat resistant versions. Designed for use when high temperatures will be encountered during the process of pipe welding; such as pre-heated pipework and pipes where very high temperatures are required for welding. These versions of our inflatable Pipe purging systems are heat resistant up to 350°C (572°F) for up to 24 hours, or up to 500°C for short periods of time, as with the standard systems, the heat resistant systems are available for all pipe diameters from 2" to 80" (50 to 2,044mm).

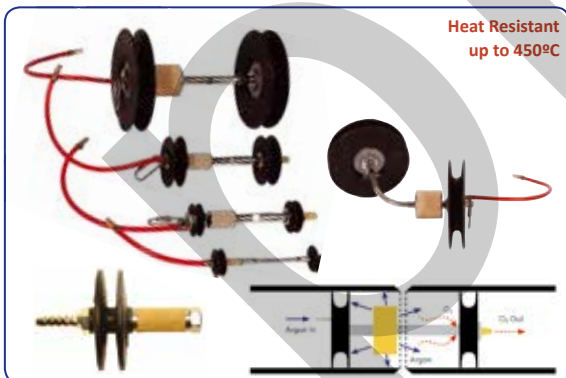

Heat Resistant  
up to 450°C

## TAG Double Seal Purge System

½" - 12" (16mm - 320mm)

The TAG Double Seal System is the latest innovation in purging processes and has been designed to further reduce both inert gas use and purging time. The gas is diffused into the chamber through a built in diffuser in the rigid, flexible or spring braided hose and exits through the exhaust holes in the second double disc unit. This process of gas diffusion provides an even flow of gas and prevents any gas turbulence behind the weld, thereby minimising the risk of oxygen in the welding chamber while, at the same time, achieving an extremely short purge time. Used in conjunction with our Purge Monitors, these systems will give you extremely short purge times result in valuable cost savings in gas and time.



Heat Resistant  
up to 300°C

## TAG Gas Cylinder Purge Systems

14" - 24" (350mm - 620mm)

Gas Cylinders are available for pipes from 350mm to 620mm diameter. These tools have two heat-resistant sealing lips, taking 300°C for up to one hour. These cylinders have extremely short purge times of 1½ - 2½ minutes for all dimensions.

The Gas cylinders are designed with pull-through balls to enable the unit to be easily retrieved out of a straight section of pipe, or a pipe with a series of bends or elbows. The purge volume is isolated, so there is no need to purge the entire length of pipe to be welded, thereby minimising gas usage.

# PIPE PURGING MONITORS



## **TAG Handy Purge 100SC**

### **New Improved Self Calibrating Weld Purge Monitor**

**Measures Oxygen down to 0.01% (100ppm)**

The Handy Purge 100SC is a light weight, yet robust handheld, entry level, toolbox weld purge monitor, measuring the level of Oxygen to 0.01% (100 parts per million). Suitable for many exotic material pipe weld applications.

This latest model uses an upgraded sensor and features Self Calibration, for increased accuracy and speed of monitoring.

Used in conjunction with TAG purging systems the Handy Purge 100SC will dramatically reduce both inert gas usage and purging times.



## **TAG Handy Purge Pro 5 Weld Purge Monitor**

**The most accurate handheld digital oxygen monitor**

**Measures oxygen levels down to 0.0005% (5ppm)**

The Handy Purge Pro 5 is the Rolls Royce of portable Weld Purge monitors, measuring the level of oxygen in the designated atmosphere down to 5 ppm!!!

The Handy Purge Pro 5 Weld Purge Monitor is essential for reading oxygen levels for titanium welding. A rechargeable battery pack and multi range power plug are standard features of the Handy Purge Pro 5, and light weight and ergonomic shape make it the ideal portable instrument for all orbital welding applications.



## **TAG Pro Purge 1 Weld Purge Monitor**

**Measures Oxygen levels down to 0.00005% (0.5ppm)**

The Pro Purge 1 Weld Purge Monitor is the ideal tool for many welding applications where critical weld standards are required. Used for Production of Semi-conductors, Nuclear, Aerospace, Pharmaceutical, Energy, Dairy, Brewery and Food processing where strict welding guide lines to eliminate weld-quality issues associated with atmosphere contaminated welds are required.

The Pro Purge 1 Weld Purge Monitor contains a stabilised zirconium oxide cell with a regulated heater to maintain a cell temperature of 750°C, which enables it to accurately measure, levels down to as low as 0.5 ppm.

# PIPE STOPPERS



## **TAG Expanding Pipe Stoppers**

**½" - 72" (13mm - 1,800mm)**

**STEEL - NYLON - ALUMINIUM**

Pipe stoppers, or drain plugs as they are sometimes known, are used to temporarily seal the end of a pipe or opening for many different testing applications. Pipe stoppers are mainly used to seal off from water, gases and foreign objects in newly laid pipes, or pipework systems that are under repair.

TAG's range of Pipe stoppers are available in a number of different styles to suit many applications for pipe sizes from ½" to 72". Special Pipe stoppers are also available for pressure testing.



## **TAG Inflatable Pipe Stoppers**

**2" - 80" (50mm - 2,035mm)**

TAG offers a range of shapes and sizes of inflatable stoppers, suitable for all applications. Made from a natural rubber bladder covered in waterproof polyurethane coated nylon (or a heat resistant nomex/kevlar mix) to prevent friction and static electricity build up.

Through tubes can be supplied with the stoppers when they are required for weld purging applications.

When deflated, the inflatable stoppers can be inserted and withdrawn with ease.

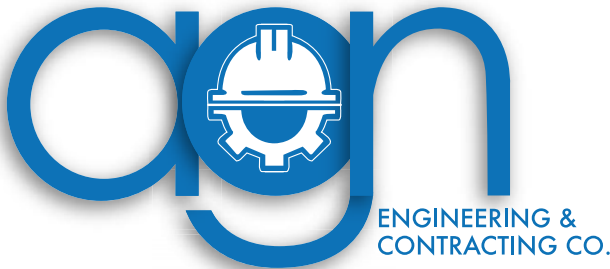

**AGN** is an established Engineering and Contracting company in Amman, Jordan; **AGN** was founded in 2018.

Our engineers and construction professionals qualify us to deliver excellent quality, safety and the opportunity to provide value engineering options to achieve the best results at a competitive price.

We offer a whole package of construction services ranging from engineering, new construction, renovation, inspections, material selection, installations and maintenance.

#### Specialties:

Power Piping, Pipe Fabrication, Equipment Erection, Machining Work, Alloy Welding Works, Welding, Steel Structure Erection and Fabrication, Alignment, Painting Works, Insulation, Cladding, Surface Treatment, Sandblasting Works, Renewable Energy System Erection, Instrument, Control Works, Electrical Works, Firefighting Systems, HVAC Systems, Heating Systems, Drainage, Water Systems, Design and Engineering, Testing, Commissioning, Power Plant Maintenance Services, Cranes and Heavy Lifting.

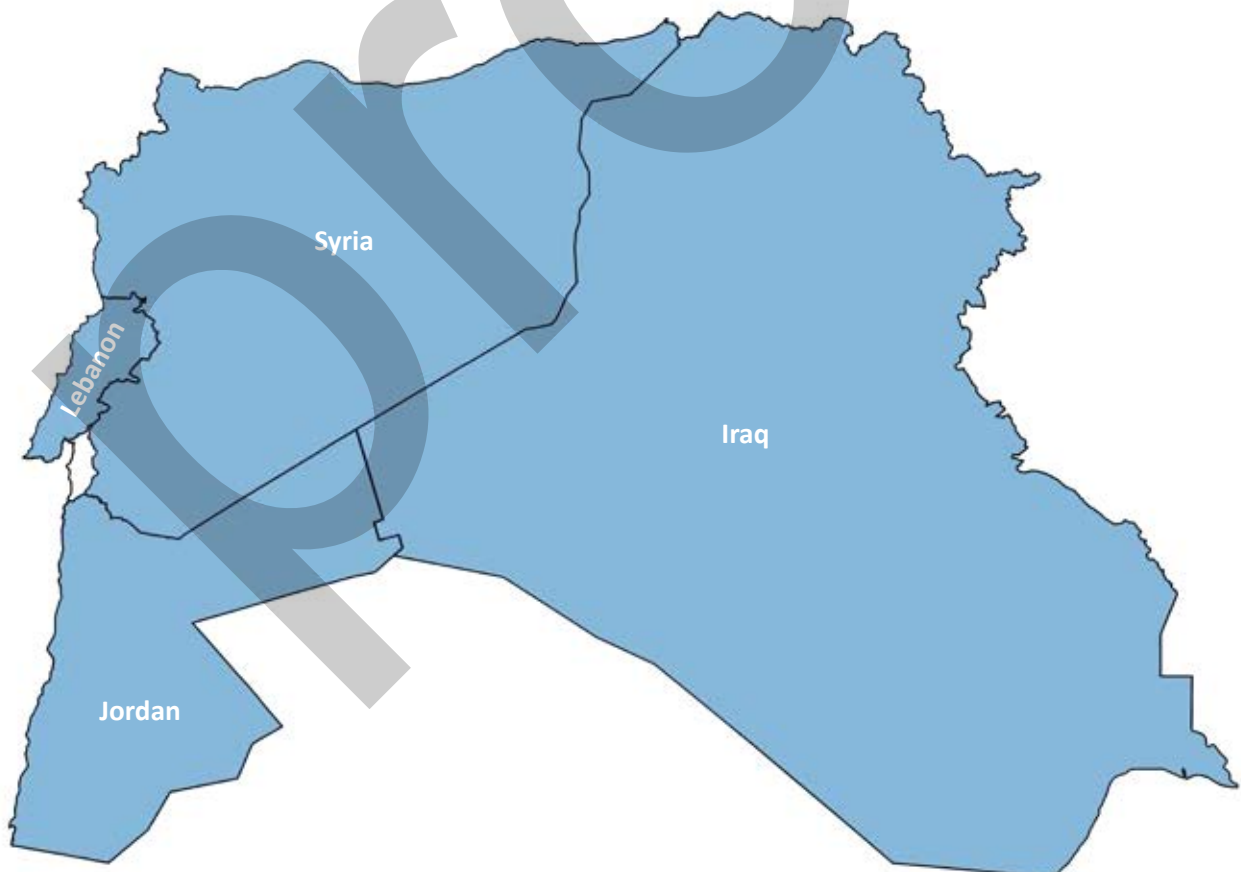

**AGN Engineering & Contracting Co.**

Al Bayader Street, 2nd Floor Al Salam Building, Amman, Kingdon of Jordan

Tel: +962 797 574 020 | E-mail: a.kilani@agn-contracting.com



# PIPE EQUIPMENT SPECIALISTS LTD PRODUCTS INCLUDE:

### PIPE BEVELLING MACHINES

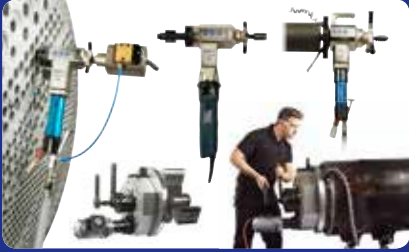

### PIPE CUTTING MACHINES



### PIPE ALIGNMENT CLAMPS



### PIPE STANDS AND ROLLERS



### PIPE PURGING EQUIPMENT



### PLATE BEVELLERS



North America

Europe

Asia

Middle East

India

Africa

South America

Australia



### TAG Head Office

TAG PIPE EQUIPMENT SPECIALISTS LTD  
Unit 15 & 16 Grendon Industrial Estate, Grendon Underwood,  
Aylesbury, Buckinghamshire, HP18 0QX England

Tel: +44 (0)1869 324 144 E-mail: sales@tag-pipe.com

[www.TAG-PIPE.com](http://www.TAG-PIPE.com)



### Your Local Distributor

AGN Engineering & Contracting Co.  
Al Bayader Street, 2nd Floor Al Salam Building,  
Amman, Kingdom of Jordan

Tel: +962 797 574 020

[www.TAG-PIPE.com](http://www.TAG-PIPE.com)

## Overseas Branches



### USA Branch

TAG PIPE EQUIPMENT SPECIALISTS INC  
527 Michigan Street, South Houston  
Houston, Texas 77587, USA  
Tel: +1 713 660 1427  
E-mail: sales-usa@tag-pipe.com



### Europe Branch

TAG PIPE EQUIPMENT SPECIALISTS BVBA  
Mosten 13, 9160 Lokeren  
Belgium  
Tel: +32 486 46 62 93  
E-mail: sales-europe@tag-pipe.com



### Middle East Branch

TAG PIPE EQUIPMENT SPECIALISTS FZE  
Al Ittihad Street, P.O. Box 3763  
Dubai, United Arab Emirates  
Tel: +971 (0)50 680 3107  
E-mail: sales-me@tag-pipe.com



### India Branch

TAG PIPE EQUIPMENT SPECIALISTS PVT  
Plot No. PAP 3, D 3 Block,  
Chinchwad, Pune 411 019  
Tel: +91 20 6573 4333  
E-mail: sales-india@tag-pipe.com



### Asia Branch

TAG PIPE EQUIPMENT SPECIALISTS PTE  
Yinhe Bridge West, Beichen District  
Tianjin, China  
Tel: +86 139 2001 5417  
E-mail: sales-asia@tag-pipe.com