



Publisher:
Solare Datensysteme GmbH
Fuhrmannstr. 9
72351 Geislingen-Binsdorf
Germany

International support
Tel.:+49 7428 9418 -640
Fax:+49 7428 9418 -280

e-mail: support@solar-log.com

Italy
Technical support: +39 0471 631032
e-mail: italy-support@solar-log.com

France
Technical support: +33 97 7909708
e-mail: france-support@solar-log.com

Switzerland
Technical support: +41 565 355346
e-mail: switzerland-fl-support@solar-log.com

United States
Technical support: +1 203 702 7189
e-mail: usa-support@solar-log.com

Table of Contents

Inverter	21
1 General	22
2 Connections	23
2.1 Solar-Log™ PIN assignment RS485 A / C or RS485/422 B	23
2.2 RJ45.....	26
2.3 RJ11 Configuration	27
3 Bus Termination.....	28
3.1 Bus Termination (RS485 or RS485/422)	28
4 Connecting the inverters.....	30
4.1 Switch off the inverters and Solar-Log™.....	31
5 ABB.....	32
5.1 ABB PVS300/800.....	32
5.2 ABB PRO-33TL	34
5.3 ABB Central Inverters	35
5.4 ABB-Power-One/Aurora/PVI/TRIO/UNO.....	36
5.5 ABB - Sunspec via RS485.....	38
5.6 ABB - Sunspec via Ethernet.....	41
6 Advanced Energy.....	43
6.1 Advanced Energy - AE-1	43
6.2 Advanced Energy - AE-3	45
6.3 Advanced Energy - AE-TX.....	47
7 AEG.....	49
7.1 AEG PS.....	49
7.2 AEG Protect	51

8	Albatech.....	53
8.1	Albatech APL Trifase 15 / 20.....	53
8.2	Albatech APL Monofase.....	55
9	ALPHA-SOL	57
9.1	ALPHA-SOL	57
10	AROS Solar Technology.....	60
10.1	AROS Solar Technology (RS422).....	60
10.2	AROS Solar Technology (RS485).....	62
11	Astronergy.....	64
11.1	Astronergy.....	64
12	Aten.....	66
12.1	Aten.....	66
13	Autarco	68
13.1	Autarco	68
14	Benning	70
14.1	Benning.....	70
15	Bonfiglioli (formerly Vectron)	72
15.1	Bonfiglioli.....	72
16	CanadianSolar	74
16.1	CanadianSolar - CSI-CT series	74
16.2	CanadianSolar - CSI-GS/GI series.....	76
17	Carlo Gavazzi	78
17.1	Carlo Gavazzi - ISMG model	78
17.2	Carlo Gavazzi - HINRG model.....	80

18	Chint Power	82
18.1	Chint Power (CPS SC and CPS SCE to 20k)	82
18.2	Chint Power (CPS 20k+).....	84
18.3	Chint Power Modbus (DO - DO/HE)	86
18.4	Chint Power Modbus (DO/US).....	88
19	CMS	90
19.1	CMS	90
20	Conergy	92
20.1	Conergy (only Solar-Log 1000, 1900 and 2000)	92
21	CyberPower	94
21.1	CyberPower	94
22	Danfoss	96
22.1	Danfoss	96
23	Delta	98
23.1	Delta (RS485).....	98
23.2	Delta RPI (Standard).....	100
23.3	Delta RPI - Sunspec Protokoll.....	102
24	Diehl Ako	104
24.1	Diehl Ako	104
25	Eaton	105
25.1	Eaton	105
26	EEl	107
26.1	EEl	107
27	Effekta	108

27.1	Effekta.....	108
27.2	Effekta KS Multitracker.....	110
27.3	Effekta KS Singletracker	112
28	EHE.....	114
28.1	EHE N1k5TL to N50kTL.....	114
28.2	EHE N10k to N100k.....	116
28.3	EHE N250k to N500k-TL	118
29	EKO Energy.....	120
29.1	EKO Energy.....	120
30	Eltek.....	122
30.1	Eltek	122
30.2	Eltek central inverter	124
31	Enfinity.....	126
31.1	Enfinity.....	126
32	Europa-Solar AG.....	128
32.1	Europa-Solar AG.....	128
33	Evoco.....	130
33.1	Evoco.....	130
34	Fronius.....	132
34.1	Fronius with ComCard	132
34.2	Fronius RL.....	134
34.3	Fronius Symo/Galvo/ECO Series.....	135
34.4	Fronius Symo / Fronius Symo Hybrid via Ethernet	136
35	Gefran.....	138
35.1	Gefran	138

36	General Electric inverters (GE)	141
36.1	General Electric inverters (GE).....	141
37	Generic Sunspec Driver	142
38	GESOLAR	144
38.1	GESOLAR.....	144
39	Ginlong	146
39.1	Ginlong.....	146
40	GMDE	149
40.1	GMDE	149
41	GoodWe	151
41.1	GoodWe (RS422)	151
41.2	GoodWe (RS485)	153
42	Growatt	156
42.1	Growatt.....	156
43	GTec	160
43.1	GTec	160
44	Helios Systems	162
44.1	Helios Systems HSI	162
44.2	Helios Systems - Central Inverters	164
45	HiQ Solar	165
45.1	TrueString.....	165

46	Huawei.....	167
46.1	Huawei Sun2000 V1.....	167
46.2	Huawei Sun2000 V2.....	170
47	Hyundai	172
47.1	Hyundai HPC-050HT-E and HPC-100HT-E.....	172
47.2	Hyundai HPC-250HT-E.....	174
48	Ingeteam	176
48.1	INGECON® SUN 1Play TL M	176
48.2	INGECON® SUN 3Play TL.....	178
48.3	INGECON® SUN 3Play TL M	180
48.4	INGECON® SUN 3Play 40TL U M480	182
48.5	INGECON® SUN 3Play 100k	184
49	INVT iMARS.....	186
49.1	INVT iMARS / MG-Serie / BG-Serie	186
50	JFY.....	188
50.1	SUNTREE JFY	188
51	Kaco	190
51.1	Kaco - Powador	190
51.2	Kaco - PVI Blue Planet	192
52	Kehua	194
52.1	Kehua (Single phase)	194
52.2	Kehua (3-phase)	196
53	KLNE.....	198
53.1	KLNE (Solartec and Sunteams)	198
54	Kostal and Solar-Fabrik	200
54.1	Kostal Piko and Solar-Fabrik Inverter Convert T (RS485)	200
54.2	Kostal Piko MP	202

54.3	Kostal Piko IQ.....	204
54.4	Kostal Plenticore plus	206
54.5	Kostal Ethernet Version.....	208
55	Kstar.....	210
55.1	Kstar Multitracker	210
55.2	Kstar Singletracker.....	212
56	Mastervolt.....	214
56.1	Mastervolt (RS485)	214
57	Mitsubishi.....	216
57.1	Mitsubishi with RS485 interface	216
58	Motech.....	218
58.1	Motech (RS485).....	218
59	Oelmaier.....	220
59.1	Oelmaier.....	220
60	Omnik	222
60.1	Omnik (RS422).....	222
60.2	Omnik (RS485).....	224
61	Omron	226
61.1	Omron.....	226
62	Pairan.....	228
62.1	Pairan.....	228
63	Phoenixtec	230
63.1	Phoenixtec.....	230

64	Platinum (formerly Diehl Ako)	232
64.1	Platinum with RS485 interface	232
64.2	Platinum H.....	234
65	Polycab	236
65.1	Polycab	236
66	Powercom	239
66.1	Powercom	239
67	Power-One/Aurora	242
67.1	Power-One/Aurora	242
68	PrimeVOLT	244
68.1	PrimeVOLT.....	244
69	PVPowered	246
69.1	PV Powered – central inverter RS485.....	246
69.2	PV Powered - string inverter	248
70	Q3	249
70.1	Q3 3000-6600	249
70.2	Q3 12000-14000	251
70.3	QX3.....	253
70.4	QY.....	255
71	RCT Power	257
71.1	RCT Power	257
72	REFUSOL	259
72.1	REFUSOL	259
73	REP	262

73.1	REP	262
74	Reverberi	264
74.1	Reverberi (EDI Series).....	264
75	Riello	266
75.1	Riello	266
76	Rishabh Instruments Pvt. Ltd.	268
76.1	Rishabh - Radius	268
77	SAJ	270
77.1	Suntrio/Sununo/R5.....	270
78	SALICRU	272
78.1	SALICRU EQX	272
78.2	SALICRU EQXLV	274
79	Samil Power	275
79.1	Samil Power	275
80	Santerno	277
80.1	Santerno	277
81	Schneider Electric.....	279
81.1	Schneider Electric SunEzy.....	279
81.2	Schneider Electric Xantrex GT30E	281
81.3	Schneider Electric Conext.....	282
81.4	Schneider Conext Sunspec (RS485)	284
81.5	Schneider Conext CL60 Sunspec (Ethernet).....	286
82	Schüco	287
82.1	IPE CN series	287

82.2	IPE CT series	289
82.3	IPE SN series.....	291
82.4	SGL series (RS485)	293
83	Shindengen	295
83.1	Shindengen	295
84	SIEL.....	297
84.1	SIEL (single phase).....	297
84.2	SIEL (3-phase).....	300
85	Siemens	301
85.1	Siemens	301
86	Siliken	304
86.1	Siliken Central inverters	304
87	SiNeng.....	306
87.1	SiNeng CP/EP.....	306
87.2	SiNeng SP.....	308
88	SMA	310
88.1	Overview.....	310
88.2	SMA connection using special RS485 piggyback card.....	311
88.3	Connect SMA with original SMA RS485 piggy back and the SMA RS485 data module.....	314
88.4	SMA Bluetooth mode	316
88.5	SMA Meter Connection Box	318
88.6	SMA SOLID Q	319
88.7	SMA Speedwire	321
88.8	SMA - Sunny Central.....	323
88.9	SMA - Sunny Tripower CORE1	324
88.10	SMA - Sunspec Modbus.....	325
88.11	SMA - Sunny Tripower Modbus.....	327
89	SOCOMEK	329
89.1	SOCOMEK Sunsys B20E.....	329
89.2	SOCOMEK Sunsys B12/B30.....	331

90	SofarSolar.....	333
90.1	SofarSolar.....	333
91	SolarEdge.....	335
91.1	SolarEdge.....	335
92	SolarMax.....	337
92.1	SolarMax – S, MT, P, TS, TS-SV and HT- series	337
92.2	SolarMax - C series	340
92.3	SolarMax – Cx series	342
92.4	SolarMax – E series.....	344
92.5	SolarMax via Ethernet interface.....	346
93	SolaX Power	347
93.1	SolaX Power X1	347
93.2	SolaX Power X3	349
94	Solectria.....	351
94.1	Solectria V1 (>9k).....	351
94.2	Solectria V2 (<9k).....	353
94.3	Solectria V3 (<3k).....	355
94.4	Solectria V4.....	357
94.5	Solectria V5.....	359
95	Solutronic.....	361
95.1	Solutronic SP25-55 (RS485).....	361
95.2	Solutronic (SP)80, 100, 120, (SE)40S1, 40S2, 50S2, 60S2 (RS485).....	363
96	Steca.....	365
96.1	Steca.....	365
96.2	Steca (>=17k).....	367
97	Sungrow.....	369
97.1	Sungrow.....	369

98	SunPower	371
98.1	SunPower SPR-F-Model with Fronius ComCard.....	371
98.2	SunPower SPR-M-Model connection using special RS485 piggyback card.....	373
98.3	SunPower SPR-M-Model connect with original SMA RS485 piggy back and the SMARS485 data module	376
99	Suntigua	378
99.1	Suntigua.....	378
100	Sunville	380
100.1	Sunville	380
101	Sunways.....	382
101.1	Sunways - AT/NT/PT	382
102	Surpass SSE	384
102.1	Surpass SSE / SPS-Serie.....	384
103	Sustainable Energy.....	386
103.1	Sustainable Energy.....	386
104	TBEA.....	388
104.1	TBEA	388
105	Trannergy.....	390
105.1	Trannergy.....	390
106	Vaillant.....	392
106.1	Vaillant – auroPOWER VPI /1 and VPI (RS485).....	392
107	Valenia	394
107.1	Valenia	394

108 Vectron	396
108.1 Vectron	396
109 Vision	397
109.1 Vision Multitracker	397
109.2 Vision Singletracker	399
110 Voltwerk	401
110.1 Voltwerk (only Solar-Log 1000, 1900 and 2000)	401
111 WINAICO	403
111.1 WINAICO	403
112 Würth.....	406
112.1 Würth SolarStar-Series	406
113 Yaskawa.....	408
113.1 Yaskawa.....	408
114 Zentral Solar Deutschland ZSD.....	410
114.1 Zentral Solar Deutschland TLQ (RS485).....	410
114.2 Zentral Solar Deutschland ZSD - zentralpower	412
115 Zeversolar	413
115.1 Zeversolar.....	413
116 Zucchetti Centro Sistemi S.p.a.....	415
116.1 Azzuro	415
117 Appendix	417
117.1 SMA mixed wiring.....	417
117.2 Interconnection of Kaco Powador inverters.....	418

Meter	419
1 External Power Meter	420
1.1 Recording Energy Flows with External Power Meters	420
2 Solar-Log™ Meter Operating Modes	422
2.1 Explanation of the Solar-Log™ Meter Operating Modes	422
3 General Information on Wiring	423
3.1 Wiring for SO meter	423
3.2 Wiring for RS485 meter.....	423
3.3 Wiring meters to record self-consumption.....	423
4 Solar-Log™ PRO	427
4.1 Solar-Log™ PRO1 Mod (single phase).....	427
4.2 Solar-Log™ PRO2 Mod (single phase).....	430
4.3 Solar-Log™ PRO380 Mod.....	433
4.3 Solar-Log™ PRO380-CT	436
5 Inepro	440
5.1 Inepro 75D.....	440
5.2 Inepro 1250D.....	442
6 Iskra	444
6.1 Iskra WS0021	444
6.2 Iskra WS0031	445
6.3 Iskra WS1102.....	446
7 Janitza UMG 104 / UMG 604 / UMG 604-PRO (Utility Meter)	447
7.1 Janitza UMG 104 / UMG 604 / UMG 604-PRO.....	447
7.2 Janitza UMG 604 / UMG 604-PRO via Ethernet	452
8 Larsen & Toubro	453
8.1 Larsen & Toubro (WDM313CDNC).....	453

9	Mikro PowerMeter	455
9.1	Mikro PowerMeter DPM680.....	455
10	Schneider Electric.....	457
10.1	Schneider EM6400S (3-phase).....	457
10.2	Schneider EM6400NG (3-phase)	459
11	Secure Meters.....	461
11.1	Secure Meters (3-phase).....	461
Battery Systems		463
1	ABB Microgrid (Hybridsystem)	464
1.1	ABB Microgrid (Hybrid system).....	464
2	Kyocera Inverter/Battery System.....	466
2.1	Kyocera Inverter/Battery System.....	466
3	Phonosolar	468
3.1	PhonoCube 7.2 (Battery Hybrid System).....	468
4	QCells (hybrid system).....	470
4.1	Q-Home + ESS-G1 (hybrid system).....	470
5	RCT Power Storage AC (Battery system)	472
5.1	RCT Power Storage AC	472
6	RCT Power Storage DC (Hybrid system)	474
6.1	RCT Power Storage DC.....	474
7	SMA - Sunny Island Battery system	476

7.1	SMA - Sunny Island (Battery sytem).....	476
8	sonnen	478
8.1	sonnen Eco 6.0 / 7.0.....	478
8.2	sonnen Eco 8.0.....	480
9	VARTA Battery System.....	482
9.1	VARTA House.....	482
9.2	VARTA Industrial.....	485
	Heating rods	488
1	EGO Smart Heater	489
1.1	EGO Smart Heater (RS485)	489
1.2	EGO Smart Heater via Ethernet.....	491
2	Heating rod MyPv AC ELWA-E	493
2.1	Heating rod MyPv AC ELWA-E via Ethernet	493
	Heating pumps.....	495
1	CTA Heat Pumps.....	496
1.1	CTA Optiheat Products	496
2	Hoval Heat Pumps.....	498
2.1	HOVAL TopTronic-E	498
3	IDM Heat Pumps	499
3.1	IDM Heat Pumps.....	499
4	Stiebel-Eltron	500

4.1	Stiebel Eltron Heat pumps (ISG)	500
Sensors.....		503
1	Sensor Basic.....	504
2	Sensor Box Professional.....	507
2.1	Technical Information.....	507
2.2	Mechanical Installation Sensor Box Professional	507
2.3	Wiring the Data Cable with the Solar-Log™	508
2.4	Starting Up at the Solar-Log™	509
2.5	Technical Data	509
3	Sensor Box Professional Plus.....	510
3.1	Technical Information.....	510
3.2	Mechanical Installation Optional Sensors.....	510
3.3	Mechanical Installation Optional Sensors.....	511
3.4	Wiring the Data Cable with the Solar-Log™	511
3.5	Starting Up at the Solar-Log™	512
3.6	Technical Data	512
Pyranometer		513
1	Kipp & Zonen - Pyranometer	514
1.1	Kipp & Zonen - Pyranometer	514
2	Lufft - Pyranometer	516
2.1	Lufft - Pyranometer.....	516
3	Rainwise - PVMet™-200 (Weather station)	518
3.1	PVMet™-200 (Weather station)	518
Smart Plug components.....		520

1	Allnet Network Power Socket.....	521
1.1	Allnet Network Power Socket.....	521
2	Smart Relay Station	523
2.1	Smart Relay Station.....	523
3	Solar-Log™ Smart Relay Box	524
3.1	Solar-Log™ Smart Relay Box	524
4	WeMo Insight Switch	526
4.1	WeMo Insight Switch.....	526
	Power Charging Stations.....	527
1	Keba - Power Charging Station.....	528
1.1	Keba - Power Charging Station (KeContact P20 / P30).....	528
	List of figures.....	530

01

Inverter

1 General

This manual is intended for use by solar energy technicians / installers and professional electricians for Solar-Log™. It should be noted that the installation and commissioning of the individual components is only to be performed by properly trained specialists.

Please refer to Chapter 4 „Connecting Inverters“ for more information.

Additional information on the individual series, models and components is available in the [Component Database](#) on our website.

Our product documentation is being constantly updated and expanded.

The current versions of the documents can be downloaded from our website:
<https://www.solar-log.com/en/support/downloads/manuals>

The descriptions in this manual refer to firmware version 4.2.5 and 5.0.1

2 Connections

2.1 Solar-Log™ PIN assignment RS485 A / C or RS485/422 B

PIN	RS485 A	RS485/422 B	RS422
1	Data+	Data+	T/RX+
2	12 V	12 V	12 V
3	GND	GND	GND
4	Data-	Data-	Data-
5			T/RX+
6			T/RX-

The connection labels Data+/Data- are specific to the manufacturer and may also be labeled A/B, or similar.

Solar-Log 50 PIN assignment

PIN	RS485-A	RS485-B	RS422
1	Data+	-	T/RX+
2	24V	-	24V
3	GND	-	GND
4	Data-	-	T/RX-
5	-	Data+	R/TX+
6	-	Data-	R/TX-

Solar-Log Base PIN assignment

PIN	RS485-A	RS485-B	RS422
6	Data+	-	T/RX+
7	24V	-	24V
8	GND	-	GND
9	Data-	-	T/RX-
10	-	Data+	R/TX+
11	-	24V	-
12	-	GND	-
13	-	Data-	R/TX-

Solar-Log Base PIN assignment

PIN	Power	S ₀ IN	RS485-A/B	RS422
Pin	Assignment	-	-	-
1 (red)	V _{in} (24 V _{DC})	-	-	-
2 (blue)	Ground	-	-	-
3 (lime green)	Functional earth	-	-	-
4 (grey)	-	S ₀ IN+	-	-
5 (grey)	-	S ₀ IN-	-	-
6 (white)	-	-	Data+	T/RX+
7 (yellow)	-	-	24V - ext.	24V - ext.
8 (olive green)	-	-	GND	GND
9 (brown)	-	-	Data-	T/RX-
10 (white)	-	-	Data+	R/TX+
11 (yellow)	-	-	24V	-
12 (olive green)	-	-	GND	-
13 (brown)	-	-	Data-	R/TX-

Solar-Log™ PIN assignment comparison

RS485 Interface

Solar-Log™ A / C	Solar-Log 50 A	Solar-Log 50 B	Solar-Log Base RS485-A	Solar-Log Base RS485-B
1 Data+	1 Data+	1 -	6 Data+	6 -
2 12 V	2 24V	2 -	7 24V	7 -
3 GND	3 GND	3 -	8 GND	8 -
4 Data-	4 Data-	4 -	9 Data-	9 -
	5 -	5 Data+	10 -	10 Data+
	6 -	6 Data-	11 -	11 24V
			12 -	12 GND
			13 -	13 Data-

RS422 Interface

Solar-Log™ B	Solar-Log 50	Solar-Log Base
1 T/RX+	1 T/RX+	6 T/RX+
2 12V	2 24V	7 24V
3 GND	3 GND	8 GND
4 T/RX-	4 T/RX-	9 T/RX-
5 R/TX+	5 R/TX+	10 R/TX+
6 R/TX-	6 R/TX-	11 -
		12 -
		13 R/TX-

2.2 RJ45

Some inverter manufacturers use RJ45 jacks on their units.

The pin assignments are manufacturer-specific.

The connection with the interface(s) of the Solar-Log™ must be made as described for the respective inverter.

Refer to the following document for the numbering of the pins for the RJ45 connection.

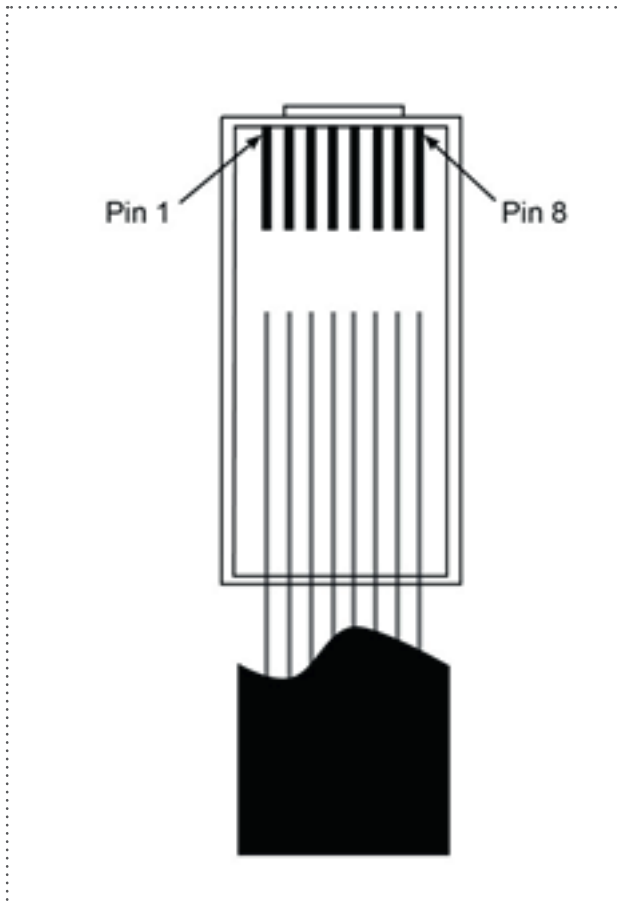

Fig.: RJ45 plug pin assignments



Caution

Risk of damage to the unit!

The Solar-Log™ also has an RJ45 socket, which must never be connected to the RJ45 socket on the inverter.

- ▶ Only connect inverters via the RS485/422 Solar-Log™ interface(s).

2.3 RJ11 Configuration

Some inverter manufacturers use RJ11 jacks on their units.

The pin assignments are manufacturer-specific.

The connection with the interface(s) of the Solar-Log™ must be made as described for the respective inverter.

Refer to the following document for the numbering of the pins for the RJ45 connection.

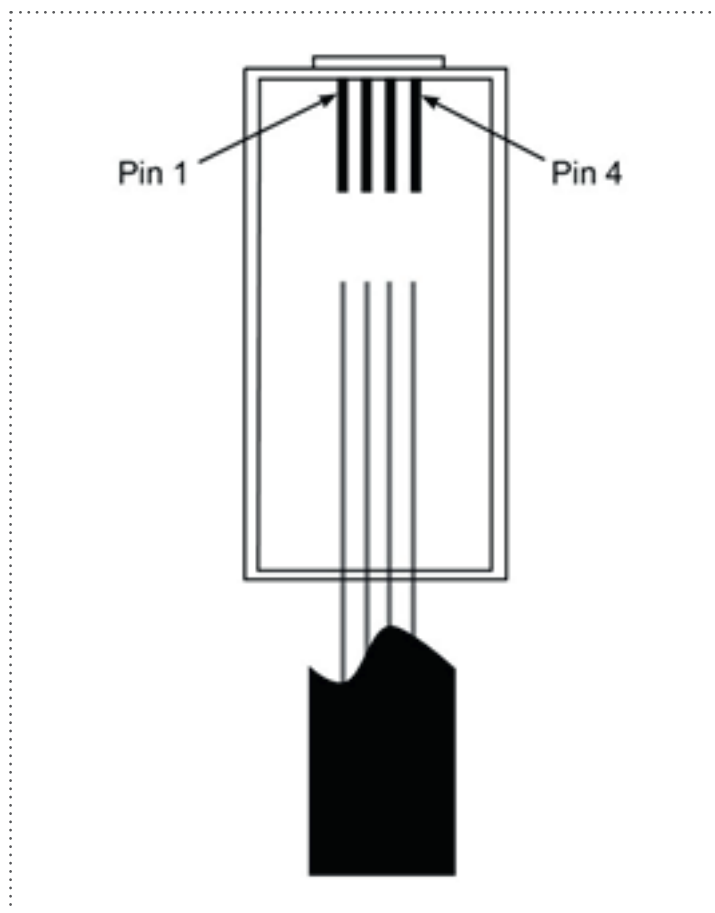

Fig.: RJ11 plug pin assignments



Caution

Risk of damage to the unit!

The Solar-Log™ has an RJ45 socket, which must never be connected to the RJ11 socket on the inverter.

- ▶ Only connect inverters via the RS485/422 Solar-Log™ interface(s).

3 Bus Termination

3.1 Bus Termination (RS485 or RS485/422)

There are many causes of communication interference in a RS485 bus; one of them is bus reflexion. A reflexion occurs when the transmitter signal is not completely absorbed by the load. That is why the source impedance should correspond to the load impedance and line surge impedance since this allows the full signal power to be reached with only minimal reflexion. The serial communication of the RS485 interface operates most efficiently when the source and load impedance is at 120 ohms. Consequently, the RS485 standard recommends a bus cable with a line surge impedance of $Z_0 = 120$ ohms. To avoid reflexion in the bus, the beginning and end of the bus cable has to be terminated according to the line surge impedance.

Here are two bus topology examples:

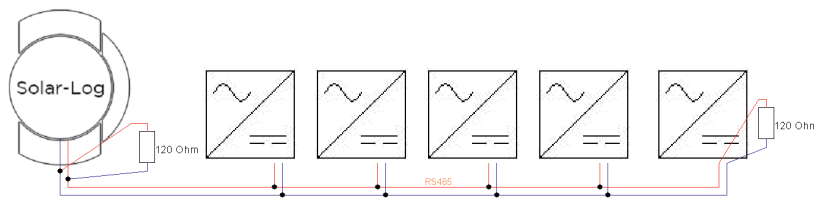

Fig.: Example 1 of bus topology

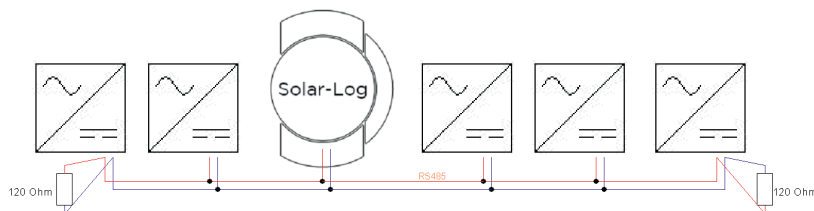

Fig.: Example 2 of bus topology



Note

Other bus topologies (e.g. star topologies) are outside the specifications and should be avoided.

- ▶ In addition, it is important to note: The slower the baud rate, the more unsusceptible the bus is regarding the connection and the topology.



Note

Since many inverter manufacturers have integrated their own termination methods for the bus connection, e.g. dip switches or jumpers, it is important to first refer to the manufacturer's inverter manual.

4 Connecting the inverters

As each inverter manufacturer uses different wiring connections and connectors, the corresponding data cables must be adapted correctly.

- You will find the terminal strip block wiring diagram to connect the inverters in table form in the following sections on connecting inverters.



Note

Solare Datensysteme GmbH supplies suitable connection cables for most inverter manufacturers.

Always read the manufacturer-specific instructions for connecting the data cable. You will find these instructions in the manufacturer's documentation.

However, when assigning the inverter wiring on the Solar-Log™ (RS485/422 B connection), follow the instructions in this manual, otherwise the inverters will not be detected by Solar-Log™.



Danger

Risk of death by electric shock if inverters are opened.

- ▶ Never open the inverter housing when the inverter is connected to power.
 - ▶ Switching inverters off.
 - ▶ Always read the installation and safety instructions given in the manual for the corresponding inverter.
 - ▶ Any work on inverters must only be carried out by trained electricians.
-



Caution

Damage to the electrical components in inverters and on interface cards due to electrostatic discharge.

- ▶ Avoid contact with component connections and plug contacts.
 - ▶ Before picking up the component, ground yourself by holding the PE or the unpainted part of the inverter housing.
-



Caution

Damage to the electrical components of the Solar-Log™ due to the wiring of the Solar-Log™!

- ▶ Switching the Solar-Log™ off.
-

4.1 Switch off the inverters and Solar-Log™

Switching inverters off

Always turn off all of the inverters first before making a cable connection between the Solar-Log™ and the connections inside the inverter; and before installing an interface card in the inverter,

To do this, read the manufacturer's documentation for the inverter, and proceed as follows:

1. Disconnect the AC side
2. Disconnect the DC side
3. Wait at least 5 minutes until the condensers in the inverters have discharged.

Switching the Solar-Log™ off

- Remove the power plug from the socket or the "Power 12 V" jack on the Solar-Log™.

5 ABB

5.1 ABB PVS300/800

Termination	Addressing	Interface
Yes	Yes	RS485

Select "ABB: PVS Central" during the inverter detection.

Overview

- Where to connect: X4 terminal block under the cover.
- Communication address must be allocated.
- 3-pin wiring.
- Installation steps:
 - Switch off the inverters and Solar-Log™.
 - Connect inverters to the Solar-Log™.
 - Connect the inverters to each other.

Connect inverters to the Solar-Log™

The wiring is done using a

- self-made cable connection with terminal block connector.

Procedure

1. Unscrew the side cover as shown in the inverter's instructions.
2. If you are making the cable yourself, connect the wires as shown in the following diagram:

Solar-Log™ terminal strip connector	Solar-Log Base RS485 (A) / (B)	X4 terminal block inverter
Terminal		PIN
▶ 1 (Data+)	▶ (A) 6 or (B) 10 (Data+)	▶ 1 - Data+
▶ 3 GND	▶ (A) 8 or (B) 12 GND	▶ 3 - GND
▶ 4 (Data-)	▶ (A) 9 or (B) 13 (Data-)	▶ 2 - Data-

3. If no further inverter is connected, terminate the inverter according to the instructions for the inverter.
4. Screw the inverter cover on again.
5. Insert the terminal block connector into the Solar-Log™ RS485 socket.

Connect the inverters to each other

- Where to connect: X4 terminal block under the cover.

Allocate communication address

- Recommendation: Continuous numbering starting with 1.
- Address range: 1 - 247.
- Procedure: Start according to the inverter's instructions.

Procedure

1. Unscrew the side cover as shown in the inverter's instructions.
2. Connect the self-made RS-485 cable to the X4 terminal block on inverter 1.
3. Connect the self-made RS-485 cable to the X4 terminal block on inverter 2.
4. Connect the other inverters to each other in the same way.
5. Terminate in the last inverter according to the inverter instructions.
6. Screw the inverter cover on again.

5.2 ABB PRO-33TL

Termination	Addressing	Interface
Yes	Yes	RS485

Select "ABB-PRO-33TL" during the inverter detection.

Overview

- Where to connect: X2 terminal block under the cover.
- Communication address must be allocated.
- 3-pin wiring.
- Installation steps.
 - Switch off the inverters and Solar-Log™.
 - Connect inverters to the Solar-Log™.
 - Connect the inverters to each other.

Connect inverters to the Solar-Log™

The wiring is done using a

- self-made cable connection with terminal block connector.

Procedure

1. Unscrew the side cover as shown in the inverter's instructions.
2. If you are making the cable yourself, connect the wires as shown in the following diagram:

Solar-Log™ terminal strip connector	Solar-Log Base RS485 (A) / (B)	X2 terminal block inverter
Terminal		PIN
▶ 1 (Data+)	▶ (A) 6 or (B) 10 (Data+)	▶ 1 - Data+
▶ 3 GND	▶ (A) 8 or (B) 12 GND	▶ 3 - GND
▶ 4 (Data-)	▶ (A) 9 or (B) 13 (Data-)	▶ 2 - Data-

3. If no further inverter is connected, terminate the inverter according to the instructions for the inverter.
4. Screw the inverter cover on again.
5. Insert the terminal block connector into the Solar-Log™ RS485 socket.

Connect the inverters to each other

- Where to connect: X2 terminal block under the cover.

Procedure

1. Unscrew the side cover as shown in the inverter's instructions.
2. Connect the self-made RS-485 cable to the X2 terminal block on inverter 1.
3. Connect the self-made RS-485 cable to the X2 terminal block on inverter 2.
4. Connect the other inverters to each other in the same way.
5. Terminate in the last inverter according to the inverter instructions.
6. Screw the inverter cover on again.

5.3 ABB Central Inverters

Termination	Addressing	Interface
No	Yes	LAN

Select "ABB: PVS Central" during the inverter detection.

Overview

- Interface not integrated; Retrofit components (with the label "RETA-01").
- Connected using network cable (patch cable) and Ethernet router or switch.
- Communication address must be allocated.
- Installation steps:
 - Allocate communication address.
 - Connect inverters to the Solar-Log™.
 - Connect the inverters to each other.

Allocate communication address

- Recommendation: Continuous numbering starting with 1; address range 1 to 254.
- Setting: Using the inverter operating display.
- Procedure: Before connecting to the Ethernet router or switch and allocating the IP address.

Connect inverters and the Solar-Log™.

The wiring is done using a

- network cable (patch cable) and the
- Ethernet router or switch.

Procedure

1. Set different unit IDs on each inverter in accordance with the inverter's instructions.
2. Connect the Solar-Log™ and the inverter to the router or switch.
3. Assign an IP address to every inverter. Assign the IP addresses according to the inverter's instructions.

The first three number blocks like the Solar-Log™, e.g. 192.168.178.49.

The fourth number block: an address that is available, e.g. 192.168.178.50.

5.4 ABB-Power-One/Aurora/PVI/TRIO/UNO

Termination	Addressing	Interface
Switch	Yes	RS485

Select "ABB: PVI/TRIO/Ultra/UNO" during the inverter detection.

Overview

- Interface integrated.
Sometimes different interfaces are used for indoor and outdoor models.
- Where to connect: RS485 terminal strips inside the inverter.
- 3-pin wiring.
- Communication address must be allocated.
- Installation steps:
 - Switch off the inverters and Solar-Log™.
 - Connect inverters to the Solar-Log™.
 - Connect the inverters to each other.
 - Allocate communication address.

Connect inverters to the Solar-Log™

The wiring is done using a

- ready-made Power One data cable (optional extra; not supplied)
- or
- self-made, shielded 3 wire data cable and terminal block connector.

Procedure

1. Open the inverter as shown in the inverter's instructions.
2. Pull the free wires through the wire opening in the inverter.
3. If you are making the cable yourself, connect the wires as shown in the following diagram:

Solar-Log™ terminal strip connector	Solar-Log Base RS485 (A) / (B)	Inverter terminal strip (Outdoor)
Terminal		Terminal
▶ 1 (Data+)	▶ (A) 6 or (B) 10 (Data+)	▶ +T/R (PC)
▶ 3 GND	▶ (A) 8 or (B) 12 GND	▶ GND
▶ 4 (Data-)	▶ (A) 9 or (B) 13 (Data-)	▶ -T/R (PC)

4. If no further inverter is connected, terminate the inverter:
In the inverter, set the DIP switch for the terminal resistor to ON.
5. Close the inverter if no other inverters are to be connected.
6. Insert the terminal block connector into the Solar-Log™ RS485 socket.

Connect the inverters to each other

- Connect using a 3 pin, shielded data cable.
- Where to connect: RS485 terminal strips inside the inverter.

Procedure

1. Open the inverter as shown in the inverter's instructions.
2. Connect terminals +T/R, -T/R and RTN of inverter 1 to the corresponding terminals on inverter 2.
3. Connect the other inverters to each other in the same way.
4. Terminate in the last inverter.
Set the DIP switch for the terminal resistor to ON.
5. Close inverters.

Allocate communication address

- Recommendation: Continuous numbering from Solar-Log™, starting from 2 (not 1!).
- Setting: Using the inverter operating display.
- Procedure: Start according to the inverter's instructions.

5.5 ABB - Sunspec via RS485

Termination	Adressing	Interface
Switch	Yes	RS485

Selections available under „ABB: Sunspec“

Overview

- Integrated interface.
- Where to connect: RJ 45 socket, on the outside of the inverter's interface card.
- 2-pin wiring.
- The communication address has to be assigned.
- Installation steps:
 - Switch off the inverters and the Solar-Log™.
 - Connect the inverters to the Solar-Log™.
 - Connect the inverters to each other.
 - Set the communication address according to the inverter's instructions.

Connect the inverters to the Solar-Log™

The wiring is done using a

- ready-made data cable (optional accessory; not supplied)
- or
- self-made RS485 data cable with RJ45 plug and terminal block connector.



Caution

Risk of damage to the unit!

The Solar-Log™ also has an RJ45 socket, which must never be connected to the RJ45 socket on the inverter.

- ▶ Only connect inverters via the RS485/422 Solar-Log™ interface(s).

Procedure

1. If you are making the cable yourself, connect the wires as shown in the following diagram:



Note

The RS485-2 interfaces have to be used in order to communicate with the Solar-Log™. Do not use the RS481-1 interface. (Refer to the inverter's manual.)

Solar-Log™ terminal strip connector	Solar-Log Base RS485 (A) / (B)	RJ45 inverter
Terminal		PIN
▶ 1 (Data+)	▶ (A) 6 or (B) 10 (Data+)	▶ 3+ T/R
▶ 3 GND	▶ (A) 8 or (B) 12 GND	▶ 7 RTN
▶ 4 (Data-)	▶ (A) 9 or (B) 13 (Data-)	▶ 5- T/R

2. Insert the RJ45 plug into the RJ45 IN socket on the first inverter.
3. Terminate the inverter if no additional inverters are to be connected:
Set the DIP switch for the terminal resistor to ON.
4. Insert the terminal block connector into the Solar-Log™ RS485 socket.

Connect the inverters to each other

- Connect using the RS485 data cable with RJ45 plug;
Connection cables between the inverters are supplied with the inverters. Use these.
- Where to connect: RJ45 socket on the inside of the inverter.

Procedure

1. Insert the RJ45 plug into the RJ45 Out socket on the first inverter.
2. Insert the other end of the cable into the RJ45 In socket on second inverter.
3. Connect the other inverters to each other in the same way.
4. Terminate the inverter if no additional inverters are to be connected:
Set the DIP switch for the terminal resistor to ON.

Assign the communication address

1. Recommendation: Continuous numbering starting with 2.
Address range 2 - 63.
2. Setting: Start according to the inverter’s instructions.



Note

The inverter address settings are configured with the „Aurora Manager LITE“ software. (Refer to the manufacturer’s manual)



Note

The inverter has two RS485 communications ports. „Modbus“ has to be defined as the protocol. The default protocol for both ports is „Aurora.“ This can be modified with the „Aurora Manager LITE“ software.(Refer to the manufacturer’s manual)



Note

The communication has to be terminated on both ends of the bus.



Note

The total length of the communication cable should not exceed 1000 meters.
A maximum of 62 inverters can be connected to one RS485 bus.



Note

The inverter's PM management is deactivated by default. If the inverter is to be remotely managed, the PM management has to be activated with the „Aurora Manager LITE“ software. (Refer to the manufacturer's manual)

5.6 ABB - Sunspec via Ethernet

Termination	Addressing	Interface
No	Yes	LAN

Selections available under ABB; Type: „Sunspec“; Interface: „Ethernet.“

Overview

- Integrated interface.
- The IP address for the inverter has to be either assigned via DHCP or a static IP has to be assigned.
- Connected using network cable (patch cable) and Ethernet router.
- Installation steps:
 - Turn the Solar-Log™ off.
 - Turn the inverters off.
 - Connect inverters to the router.
 - Connect the Solar-Log™ to the router.

Connect the inverters to the Solar-Log™

- The wiring is done using a network cable (patch cable/crossover cable) and the Ethernet router.

Connect the inverters to each other

The inverters are connected together using the RJ45 interface and, if needed, a router.

Follow the connection setup according to the inverter's instructions.

Assigning IP addresses

- In addition to a static, fixed IP, a dynamic IP address can also be assigned.
- Please select an IP address with the same class C subnet as the Solar-Log™.
- Example: The Solar-Log™ has the IP address 192.168.178.49.
- The inverter in this case has to have a free IP address in the same range (from 192.168.178.1 to 192.168.178.254).
- Procedure: Start according to the inverter's instructions.

*Dynamic IP address (DHCP) for detection and communication:

The Solar-Log™, inverter and router have to be set to obtain their IP addresses automatically (DHCP) and be in the same class C subnet.



Note

The setting „ModTCP Server“ has to be activated in the inverter in order to be able to communicate with Sunspec-Ethernet. This setting cannot be adjusted via the inverter's display. The inverter has to be adjusted via a device with a wireless function. More information below under „Setting up the Inverter.“

Setting up the Inverter:

A device with a wireless function such as a laptop, tablet or smartphone is required to set up and configure the inverter.

The following steps are necessary:

- Connect the inverter to a power outlet.
- Activate the wireless function of the device used.
- Connect the device to the inverter's access point (a network with the name ABB-XX-XX-XX-XX-XX-XX appears in the last, the Xs are the hexadecimal number of the MAC address (the MAC address is printed on the wireless identification label on the side of the inverter).
- Enter „ABBSOLAR“ as the password for the inverter's access point.
- Open the internet browser and enter the IP address to access the configuration wizard menu: 192.168.117.1 (default address that is always active).
- The configuration wizard starts.
- Refer to the inverter's installation manual for the next steps.



Note

Please also note the instructions the inverter's installation manual of the inverter for the set up and configuration!

Detection via the Solar-Log™ WEB Interface

- For detection on the Solar-Log™, select the device class under the menu [Configuration | Device | Definition | Interface](#) with the plus symbol and then select ABB as the manufacturer, Sunspec as the type and the interface. Confirm your selection with **OK**.
- Save your selections and then start the Device Detection under [Configuration | Device | Detection](#) and start the device detection.

Detection from the Solar-Log 1200

- When using the Solar-Log 1200, the detection can also be started from the display. Select the settings ► **Start ► Initial Configuration ► SPage 2 „Devices“ ► ADD** and select „Inverter,“ „ABB-Sunspec“ and the interface „Ethernet.“ Save and start the Device Detection.

6 Advanced Energy

6.1 Advanced Energy - AE-1

Termination	Addressing	Interface
Switch	Yes	RS485

Select "Steca" during the inverter detection.

Overview

- Integrated interface.
- Where to connect: RJ socket, on the outside of the inverter's interface card.
- 2-pin wiring.
- Communication address must be allocated.
- Installation steps:
 - Switch off the inverters and Solar-Log™.
 - Connect inverters to the Solar-Log™.
 - Connect the inverters to each other.
 - Allocate communication address.

Connect inverters to the Solar-Log™

The wiring is done using a

- ready-made data cable (optional extra; not supplied)
- or
- self-made RS485 data cable with RJ45 plug and terminal block connector.



Caution

Risk of damage to the unit!

The Solar-Log™ also has an RJ45 socket, which must never be connected to the RJ45 socket on the inverter.

- ▶ Only connect inverters via the RS485/422 Solar-Log™ interface(s).

Procedure

1. If you are making the cable yourself, connect the wires as shown in the following diagram:

Solar-Log™ terminal strip connector	Solar-Log Base RS485 (A) / (B)	RJ45 inverter
Terminal		PIN
▶ 1 (Data+)	▶ (A) 6 or (B) 10 (Data+)	▶ 1
▶ 4 (Data-)	▶ (A) 9 or (B) 13 (Data-)	▶ 2

2. Insert the RJ45 plug into any RJ45 socket on the first inverter.
3. If no further inverter connected, terminate the inverter:
On the inverter insert the connection plug into the free RJ45 socket.
4. Insert the terminal block connector into the Solar-Log™ RS485 socket.

Connect the inverters to each other

- Connect using the RS485 data cable with RJ45 plug;
Connection cables between the inverters are supplied with the inverters. Use these.
- Where to connect: RJ45 socket on the outside of the inverter.

Procedure

1. Insert the RJ45 plug into the free RJ45 socket on the first inverter.
2. Insert the other end of the wire into any RJ45 socket on inverter 2.
3. Connect the other inverters to each other in the same way.
4. Terminate the last inverter.
Insert the connection plug into the free RJ45 socket.

Allocate communication address

1. Recommendation: Continuous numbering starting with 1.
2. Setting: Using the rotating switch on the inverter interface card.
3. Procedure: Start according to the inverter's instructions.

6.2 Advanced Energy - AE-3

Termination	Addressing	Interface
Terminating plug	Yes	RS485

Select "RefuSol. Native" during the inverter detection.

Overview

- Integrated interface.
- Where to connect: RJ45 socket on the bottom of the inverter.
- 2-pin wiring.
- Communication address must be allocated.
- Installation steps:
 - Switch off the inverters and Solar-Log™.
 - Connect inverters to the Solar-Log™.
 - Connect the inverters to each other.
 - Allocate communication address.

Connect inverters to the Solar-Log™

The wiring is done using a

- self-made, shielded 2 wire data cable and terminal block connector.

Procedure

1. Connect wires as shown in the diagram below.

Solar-Log™ terminal strip connector	Solar-Log Base RS485 (A) / (B)	RS485 inverter socket
Terminal		PIN
▶ 1 (Data+)	▶ (A) 6 or (B) 10 (Data+)	▶ 2
▶ 4 (Data-)	▶ (A) 9 or (B) 13 (Data-)	▶ 3

2. If no further inverter is connected, terminate the inverter:
On the sockets „RS485 OUT“ with REFUSOL round plugs bypass the connections PIN1 to PIN2 and PIN3 to PIN4.
3. Close the inverter if no other inverters are to be connected.
4. Insert the terminal block connector into the Solar-Log™ RS485 socket.

Connect the inverters to each other

- Connect using
 - 2-wire, shielded data cable and.
 - 4-pin „SACC-M12MS-4SC“ plug (two plugs included with the inverter).
- Where to connect: RS485 sockets on the bottom of the inverter.

The RS485 IN and OUT sockets are each double connections so that the wiring can be continued to the next inverter.

Procedure

1. Connect the data cable to the „SACC-M12MS-4SC“ plug as shown in the inverter’s instructions.
2. Insert one plug into the OUT (X14B) socket of inverter 1.
3. Insert the other end of the wire into the IN socket (X15B) on inverter 2.
4. Connect the other inverters to each other in the same way.
5. Terminate the last inverter.
On the sockets „RS485 OUT“ with REFUSOL round plugs bypass the connections PIN1 to PIN2 and PIN3 to PIN4.
6. Close inverters.

Allocate communication address

- Recommendation: Continuous numbering starting with 1; highest possible address: 31.

Set the following parameters on the inverter’s operating display:

1. Press „F1“, select **Numerical list**, press „ENTER“.
2. Set parameter number **2000** [password protection], press „ENTER“ twice.
3. Enter **72555**, press „ENTER“.
4. Set parameter number **0406**, press „ENTER“.
5. Select sub parameter **0406,3**, press „ENTER“.
6. Enter figure for communication **x**.
[x = continuous numbering starting with 1; highest possible address: 31], press „ENTER“. 31], press „ENTER“.

After configuring on the display:

1. Using the installed DC isolating switch turn the inverters on and off briefly so that the settings are activated.
2. Set the date and time on the inverter as shown in the inverter instructions.

Allocate communication address

- Recommendation: Continuous numbering starting with 1.
- Setting: Using the inverter operating display.
- Procedure: Start according to the inverter’s instructions.



Note

To use active and reactive power management, all of the inverters need to be set to:

- ▶ Protocol 1
- ▶ 57600 baud
- ▶ Parameter 1164 = 2

6.3 Advanced Energy - AE-TX

Termination	Addressing	Interface
Jumper	Yes	RS485

Select "PVPowered" during the inverter detection.

Overview

- Integrated interface.
- Where to connect: Modbus Slave socket on interface card.
- 3-pin wiring.
- Communication address must be allocated.
- Installation steps:
 - Switch off the inverters and Solar-Log™.
 - Connect inverters to the Solar-Log™.
 - Set the address of the inverters.
 - Connect the inverters to each other.

Connect inverters to the Solar-Log™

The wiring is done using a

- self-made 3 pin connection cable and terminal block connector.



Note

The transfer rate for Modbus (RS485) on delivery to the customer is set to 9600bps. Please check these settings.

Procedure

1. Open the inverter as shown in the inverter's instructions.
2. Pull the free wires through the wire opening in the inverter.
3. If you are making the cable yourself, connect the wires as shown in the following diagram:

Solar-Log™ terminal strip connector	Solar-Log Base RS485 (A) / (B)	RJ45 inverter
Terminal		PIN
▶ 1 (Data+)	▶ (A) 6 or (B) 10 (Data+)	▶ 2 - D+
▶ 3 GND	▶ (A) 8 or (B) 12 GND	▶ 1 - GND
▶ 4 (Data-)	▶ (A) 9 or (B) 13 (Data-)	▶ 3 - D-

4. If no further inverter connected, terminate the inverter.
Inside the inverter set the supplied jumper from „J4“ to „J5“.
5. Setting the address for the inverter: Set SW1 to „0“ and SW2 to „1“ in order to set the parameters for the inverter with the address „01“.
6. Close the inverter if no other inverters are to be connected.
7. Insert the terminal block connector into the Solar-Log™ RS485 socket.

Connect the inverters to each other

The wiring is done using a

- self-made connection cable and terminal block connector.
- Where to connect: Terminal strip inside the inverter.

Procedure

1. Open the inverter as shown in the inverter's instructions.
2. Pull the free wires through the wire opening in the inverter.
3. Connect terminals GND, D+ and D- of inverter 1 to the corresponding terminals on inverter 2.
4. Connect the other inverters to each other in the same way.
5. Terminate the last inverter according to the inverter instructions.
Inside the inverter set the supplied jumper from „J4“ to „J5“.
6. Address the individual inverters in accordance with the manufacturer's handbook: Inverter 1 should be the inverter that is directly connected to the Solar-Log™. To this end, set SW1 to „0“. Depending on the position of the inverter in the bus, SW2 should be set to 1-9.
If more than 9 inverters are to be connected to one Solar-Log™, please read the manufacturer's instructions for further information.
7. Close the inverter if no other inverters are to be connected.
8. Insert the terminal block connector into the Solar-Log™ RS485 socket.

7 AEG

7.1 AEG PS

Termination	Addressing	Interface
Yes	No	RS422

Select "AEG: Protect PV (PS)" during the inverter detection.

Overview

- Interface not integrated; Retrofit RS485 interface card.
- 4-pin cable – only on RS485/422 B or C connection of the Solar-Log™.
- Communication address does not have to be assigned.
- Multi-string technology.

AEG inverters are fitted with 1 or 3 MPP trackers depending on the model. Each string input is monitored separately and ideally adjusted to the connected modules.

The Solar-Log™ automatically detects how many inverters and strings are active during inverter detection.



Note

The order in which the inverters are displayed in the Solar-Log™ after detection is random. We strongly recommend that you change the order of the inverters immediately after detection at startup, in the [Configuration | Devices | Configuration | Order](#) dialog box.

- ▶ The inverters can be identified using the displayed serial number.

- Installation steps:
 - Switch off the inverters and Solar-Log™.
 - Install the RS485 interface in the inverter.
 - Connect inverters to the Solar-Log™.
 - Connect the inverters to each other.

Installing the RS485 interface

Procedure

- ▶ Insert the RS485 interface in the bottom of the inverter in accordance with the interface card installation instructions and screw in.

Connect inverters to the Solar-Log™

The wiring is done using a

- ready-made data cable (optional extra; not supplied)
- or
- self-made, shielded 4 wire data cable and terminal block connector.



Note

Only connect inverter using the RS485/422 B or C interface.

Procedure

1. Open the inverter as shown in the inverter's instructions.
2. Pull the free wires through the wire opening in the inverter.
3. If you are making the cable yourself, connect the wires as shown in the following diagram:

Solar-Log™ terminal strip connector	Solar-Log Base RS422	Inverter terminal strip
Terminal		Terminal
▶ 1 (T/RX+)	▶ 6 (T/RX+)	▶ R+
▶ 4 (T/RX-)	▶ 9 (T/RX-)	▶ R-
▶ 5 (R/TX+)	▶ 10 (R/TX+)	▶ T+
▶ 6 (R/TX-)	▶ 13 (R/TX-)	▶ T-

4. If no further inverter is connected, terminate the inverter according to the instructions for the inverter.
5. Close the inverter if no other inverters are to be connected.
6. Insert the terminal block connector into the Solar-Log™ RS485/422 B or C socket.

Connect the inverters to each other

- Connect using a 4 wire, shielded data cable.
- Where to connect: Terminal strip inside the inverter (on the retrofitted RS485 interface).

Procedure

1. Open the inverter as shown in the inverter's instructions.
2. Connect terminals R+, R-, T+ and T- of inverter 1 to the corresponding terminals on inverter 2.
3. Connect the other inverters to each other in the same way.
4. Terminate the last inverter according to the inverter instructions.
5. Close inverters.

7.2 AEG Protect

Termination	Addressing	Interface
Terminating plug	No	RS485

Select "AEG: Protect PV (3PH)" during the inverter detection.

Overview

- Supported models PV 10; 12.5 and 15.
- Where to connect: 2 RJ45 sockets on the right on the side cover.
- Communication address does not have to be assigned.
- 4-pin wiring.
- Installation steps:
 - Switch off the inverters and Solar-Log™.
 - Connect inverters to the Solar-Log™.
 - Connect the inverters to each other.

Connect inverters to the Solar-Log™

The wiring is done using a

- ready-made RJ45 data cable (optional extra; not supplied)
- or
- self-made cable connection with RS485 data cable and terminal block connector.

Procedure

1. Unscrew the side cover as shown in the inverter's instructions.
2. If you are making the cable yourself, connect the wires as shown in the following diagram:

Solar-Log™ terminal strip connector	Solar-Log Base RS485 (A) / (B)	RJ45 inverter
Terminal		PIN
▶ 1 (Data+)	▶ (A) 6 or (B) 10 (Data+)	▶ 6
▶ 3 GND	▶ (A) 8 or (B) 12 GND	▶ 1
▶ 3 GND	▶ (A) 8 or (B) 12 GND	▶ 2
▶ 4 (Data+)	▶ (A) 9 or (B) 13 (Data-)	▶ 3



Caution

Risk of damage to the unit!

The Solar-Log™ also has an RJ45 socket, which must never be connected to the RJ45 socket on the inverter.

- ▶ Only connect inverters via the RS485/422 Solar-Log™ interface(s).

3. If no further inverter connected, terminate the inverter:
 Insert the supplied connection plug into any free RJ45 socket on the inverter.
 The connection plug is an 8-pin dummy plug with bridged wires: Bridge wires 3 and 4 and wires 5 and 6.
4. Screw the inverter cover on again.
5. Insert the terminal block connector into the Solar-Log™ RS485 socket.

Connect the inverters to each other

- Connect using a network cable (patch cable).
- Where to connect: 2 RJ45 sockets on the right on the side cover.

Procedure

1. Unscrew the side cover as shown in the inverter's instructions.
2. Insert the RJ45 plug into any RJ45 socket on inverter 1.
3. Insert the other end of the wire into any RJ45 socket on inverter 2.
4. Connect the other inverters to each other in the same way.
5. Terminate the last inverter.
Insert the connection plug into the free RJ45 socket.
6. Screw the inverter cover on again.

8 Albatech

8.1 Albatech APL Trifase 15 / 20

Termination	Addressing	Interface
Jumper	Yes	RS485

Inverters from different Albatech model ranges (APL monophase / triphase) cannot be mixed on an RS485 connection. The correct range must be selected when selecting inverters.

Overview

- Integrated interface.
- Where to connect: Terminal strip inside the inverter.
- 3-pin wiring.
- Communication address must be allocated.
- Installation steps:
 - Allocate communication address.
 - Switch off the inverters and Solar-Log™.
 - Connect inverters to the Solar-Log™.
 - Connect the inverters to each other.



Note

If more than 32 inverters are connected a signal amplifier must be installed in the RS485 bus in accordance with the manufacturer.

Connect inverters to the Solar-Log™

The wiring is done using a

- self-made, shielded 3 wire data cable and terminal block connector.

It is connected to the inverter as shown in the following diagram. The inverters are terminated on pin 9/10 of J1. Both the first and also the last inverter must be terminated.

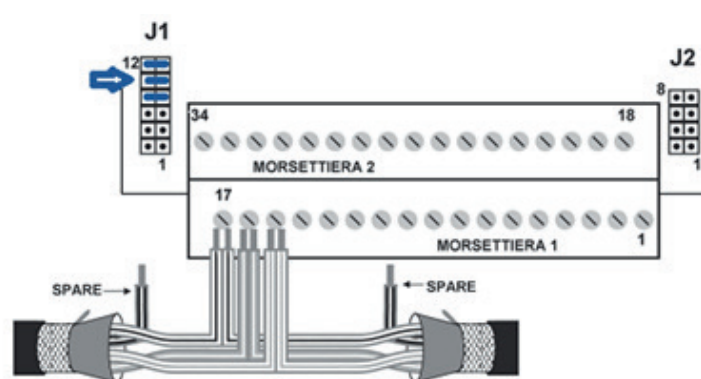

Fig.: Albatech APL block connector

Procedure

1. Switch off the inverters and Solar-Log™.
2. Unscrew the side cover as shown in the inverter’s instructions.
3. Pull the free wires through the wire opening in the inverter.
4. If you have made the cable connection yourself, connect the wires as shown in the following diagram:

Solar-Log™ terminal strip connector	Solar-Log Base RS485 (A) / (B)	Inverter terminal strip
Terminal		PIN
▶ 1 (Data +)	▶ (A) 6 or (B) 10 (Data+)	▶ 15 (RS485 +)
▶ 3 GND	▶ (A) 8 or (B) 12 GND	▶ 17 GND
▶ 4 (Data-)	▶ (A) 9 or (B) 13 (Data-)	▶ 16 (RS485 -)

5. Connect data cable to RS485+, RS485- and grounded terminals.
6. If no further inverter is connected, terminate the inverter:
To terminate set the jumper at J1 to pins 9 and 10.
7. Screw the inverter cover on again.
8. Insert the terminal block connector into the Solar-Log™ RS485 socket.

Connect the inverters to each other

The wiring is done using a

- self-made, shielded 3 wire data cable.
- Where to connect: Terminal strip inside the inverter.

Procedure

1. Switch off the inverters and Solar-Log™.
2. Unscrew the side cover as shown in the inverter’s instructions.
3. Connect data cable to RS485+, RS485- and grounded terminals.
4. Connect the other inverters to each other in the same way.
5. Terminate on the first and last inverters.
6. Set the jumper at J1 to pins 9 and 10.
7. Screw the inverter cover on again.
8. Insert the terminal block connector into the Solar-Log™ RS485 socket.

Allocate communication addresses

Before the inverters can be detected addresses must be allocated to them. To do this you must connect to the unit either via the Ethernet or RS232. You will find details on this procedure in the inverter’s handbook. Now set another address (1 - 247) from the modbus parameters for each inverter and leave the baud rate at 19200 bit/s.

8.2 Albatech APL Monofase

Termination	Addressing	Interface
Jumper	Yes	RS485

APL Monofase 2.0/3.0/4.0/5.0

Inverters from different Albatech model ranges (APL monophase / triphase) cannot be mixed on an RS485 connection. The correct range must be selected when selecting inverters.

Overview

- Interface not integrated; Upgrade the Albatech RS485 interface.
- 3-pin wiring.
- Communication address must be allocated.
- Installation steps:
 - Switch off the inverters and Solar-Log™.
 - Install the RS485 interface in the inverter.
 - Connect inverters to the Solar-Log™.
 - Connect the inverters to each other.
 - Allocate communication address.

Installing the RS485 interface

Procedure

- ▶ Install the RS485 interface in the inverter in accordance with the interface card installation instructions.

Connect inverters to the Solar-Log™

The wiring is done using a

- ready-made data cable (optional extra; not supplied)
- or
- self-made, shielded 3 wire data cable and terminal block connector.

Procedure

1. Open the inverter as shown in the inverter's instructions.
2. If you are making the cable yourself, connect the wires as shown in the following diagram:

Solar-Log™ terminal strip connector Solar-Log Base RS485 (A) / (B) Inverter terminal strip

Terminal		Terminal
▶ 1 (Data+)	▶ (A) 6 or (B) 10 (Data+)	▶ Pin 2 - D+
▶ 3 GND	▶ (A) 8 or (B) 12 GND	▶ Pin 3 - GND
▶ 4 (Data-)	▶ (A) 9 or (B) 13 (Data-)	▶ Pin 1 - D-

3. If no further inverter connected, terminate the inverter:
Set the jumper on the RS485 interface card to ON.
4. Close the inverter if no other inverters are to be connected.
5. Insert the terminal block connector into the Solar-Log™ RS485 socket.

Connect the inverters to each other

- Connect using a 3 wire, shielded data cable.
- Where to connect: on the upgraded RS485 interface.

Procedure

1. Open the inverter as shown in the inverter's instructions.
2. Using the data cable connect terminals „Pin 2-RS485-A (+)“, „Pin 3-GND“ and „Pin 1-RS485-B (-)“ of inverter 1 to the corresponding terminals on inverter 2.
3. Connect the other inverters to each other in the same way.
4. Terminate the last inverter.
5. Set the jumper on the RS485 interface card to ON.
6. Close inverters.

Allocate communication address

- Recommendation: Continuous numbering starting with 1.
- Setting: Using the inverter operating display.
- Procedure: Start according to the inverter's instructions.

9 ALPHA-SOL

9.1 ALPHA-SOL

Termination	Addressing	Interface
Switch	Yes	RS485

Overview

- Interface not integrated; Retrofit RS485 interface card.
- 4-pin wiring.
- Communication address must be allocated.
- Installation steps:
 - Allocate communication address.
 - Switch off the inverters and Solar-Log™.
 - Install the RS485 interface in the inverter.
 - Connect inverters to the Solar-Log™.
 - Connect the inverters to each other.

Allocate communication address

- Recommendation: Continuous numbering starting with 1.
- Setting: Using the DIP switch on the interface card.

Before installing the RS485 interface card:

- ▶ Allocate the communication address using the 8 interface card DIP switches:

Example - Communication address 1:

On								
Off								
DIP switch								

Example - Communication address 2:

On								
Off								
DIP switch								

Example - Communication address 3:

On								
Off								
DIP switch								

Example - Communication address 4:

On								
Off								
DIP switch								

Example - Communication address 5:

On								
Off								
DIP switch								

You will find more information at:

http://en.wikipedia.org/wiki/Binary_number.

Installing the RS485 interface

Procedure

- ▶ Install the RS485 interface in the inverter in accordance with the interface card installation instructions.

Connect inverters to the Solar-Log™

The wiring is done using a

- ready-made BKL2 data cable (optional extra; not supplied)

or

- self-made, shielded 4 wire data cable and terminal block connector.

Procedure

1. Open the inverter as shown in the inverter's instructions.
2. Pull the free wires through the wire opening in the inverter.
3. If you are making the cable yourself, connect the wires as shown in the following diagram:

Solar-Log™ terminal strip connector	Solar-Log Base RS485 (A) / (B)	Inverter terminal strip
Terminal		Terminal
▶ 1 (Data+)	▶ (A) 6 or (B) 10 (Data+)	▶ R+
▶ 1 (Data+)	▶ (A) 6 or (B) 10 (Data+)	▶ T+
▶ 4 (Data-)	▶ (A) 9 or (B) 13 (Data-)	▶ R-
▶ 4 (Data-)	▶ (A) 9 or (B) 13 (Data-)	▶ T-

1. If no further inverter is connected, terminate the inverter according to the instructions for the inverter.
2. Close the inverter if no other inverters are to be connected.
3. Insert the terminal block connector into the Solar-Log™ RS485 socket.

Connect the inverters to each other

- Connect using a 4 wire, shielded data cable.
- Where to connect: Terminal strip inside the inverter on the retrofitted RS485 interface card.

Procedure

1. Open the inverter as shown in the inverter's instructions.
2. Connect terminals R+, T+, R- and R+ of inverter 1 to the corresponding terminals on inverter 2.
3. Connect the other inverters to each other in the same way.
4. Terminate in the last inverter according to the inverter instructions.
5. Close inverters.

10 AROS Solar Technology

10.1 AROS Solar Technology (RS422)

Termination	Addressing	Interface
Yes	No	RS422

Select "AROS: SIRIO RS422" during the inverter detection.

Overview

- Integrated interface.
- Where to connect: Terminal strip inside the inverter.
- 4-pin cable only on RS485/422 B or C connection of the Solar-Log™.
- Communication address does not have to be assigned.



Note

The order in which the inverters are displayed in the Solar-Log™ after detection is random. We strongly recommend that you change the order of the inverters immediately after detection at startup in the [Configuration | Device | Configuration | Order](#) menu box.

- ▶ The inverters can be identified using the displayed serial number.

- Installation steps:
 - Switch off the inverters and Solar-Log™.
 - Connect inverters to the Solar-Log™.
 - Connect the inverters to each other.

Connect inverters to the Solar-Log™

The wiring is done using a

- self-made cable connection with terminal block connector.



Note

Only connect inverter using the RS485/422 B or C interface.

Procedure

1. If you are making the cable yourself, connect the wires as shown in the following diagram:

Solar-Log™ terminal strip connector	Solar-Log Base RS422	Inverter terminal strip
Terminal		PIN
▶ 1 (T/RX+)	▶ 6 (T/RX+)	▶ R+
▶ 4 (T/RX-)	▶ 9 (T/RX-)	▶ R-
▶ 5 (R/TX+)	▶ 10 (R/TX+)	▶ T+
▶ 6 (R/TX-)	▶ 13 (R/TX-)	▶ T-

2. If no further inverter is connected, terminate the inverter according to the instructions for the inverter.
3. Insert the terminal block connector into the Solar-Log™ RS485/422 B or C socket.

Connect the inverters to each other

- Connect using a 4 wire, shielded data cable.
- Where to connect: Terminal strip inside the inverter.

Procedure

1. Open the inverter as shown in the inverter's instructions.
2. Connect terminals R+, R-, T+ and T- of inverter 1 to the corresponding terminals on inverter 2.
3. Connect the other inverters to each other in the same way.
4. Terminate in the last inverter according to the inverter instructions.
5. Close inverters.

10.2 AROS Solar Technology (RS485)

Termination	Addressing	Interface
Yes	No	RS485

Select "AROS: SIRIO RS485" during the inverter detection.

Overview

- Integrated interface.
- Where to connect: Terminal strip inside the inverter.
- 3-pin wiring.
- Communication address does not have to be assigned.



Note

The order in which the inverters are displayed in the Solar-Log™ after detection is random. We strongly recommend that you change the order of the inverters immediately after detection at startup in the [Configuration | Device | Configuration | Order](#) menu box.

- ▶ The inverters can be identified using the displayed serial number.

- Installation steps
 - Switch off the inverters and Solar-Log™.
 - Connect inverters to the Solar-Log™.
 - Connect the inverters to each other.

Connect inverters to the Solar-Log™

The wiring is done using a

- self-made cable connection with terminal block connector.

Procedure

1. If you are making the cable yourself, connect the wires as shown in the following diagram:

Solar-Log™ terminal strip connector	Solar-Log Base RS485 (A) / (B)	RJ45 inverter
Terminal		PIN
▶ 1 (Data+)	▶ (A) 6 or (B) 10 (Data+)	▶ A (+)
▶ 3 GND	▶ (A) 8 or (B) 12 GND	▶ GND
▶ 4 (Data-)	▶ (A) 9 or (B) 13 (Data-)	▶ B (-)

2. If no further inverter is connected, terminate the inverter according to the instructions for the inverter.
3. Insert the terminal block connector into the Solar-Log™ RS485 socket.

Connect the inverters to each other

- Connect using a 3 wire, shielded data cable.
- Where to connect: Terminal strip inside the inverter.

Procedure

1. Open the inverter as shown in the inverter's instructions.
2. Connect terminals A+, GND and B- on inverter 1 to the corresponding terminals on inverter 2.
3. Connect the other inverters to each other in the same way.
4. Terminate the last inverter according to the inverter instructions.
5. Close inverters.

11 Astronergy

11.1 Astronergy

Termination	Addressing	Interface
-	Yes	RS485

Select „Astronergy“ during the inverter detection.

Overview

- Integrated interface.
- Where to connect: Round sockets on the outside of the inverter.
- 2-pin wiring.
- Communication address must be allocated.
- Installation steps:
 - Switch off the inverters and Solar-Log™.
 - Connect inverters to the Solar-Log™.
 - Connect the inverters to each other.
 - Allocate communication address.

Connect inverters to the Solar-Log™

The wiring is done using a

- self-made, shielded 2 wire data cable with round plug and terminal block connector.
- The round plugs required can be obtained from the inverter manufacturer.

Procedure

1. If you are making the cable yourself, connect the wires as shown in the following diagram:

Solar-Log™ terminal strip connector	Solar-Log Base RS485 (A) / (B)	Inverter round socket
Terminal		PIN
▶ 1 (Data+)	▶ (A) 6 or (B) 10 (Data+)	▶ 2 (+)
▶ 4 (Data-)	▶ (A) 9 or (B) 13 (Data-)	▶ 1 (-)

2. Insert the round plug into any COM round socket on the inverter.
3. Insert the terminal block connector into the Solar-Log™ RS485 socket.

Connect the inverters to each other

- Wiring using 2 pin cable with round plugs.
- Where to connect: Round sockets on the outside of the inverter.

Procedure

1. Insert the round plug into any round socket on inverter 1.
2. Insert the other end of the cable into any round socket on inverter 2.
3. Connect the other inverters to each other in the same way.
4. Insert the terminal block connector into the Solar-Log™ RS485 socket.

Allocate communication address

- Recommendation: Continuous numbering starting with 1.
- Address range: 1 - 125.
- Setting: Using the inverter operating display.
- Procedure: Start according to the inverter's instructions.

12 Aten

12.1 Aten

Termination	Addressing	Interface
-	No	RS485

Overview

- Integrated interface.
- Where to connect: RJ14 socket on the outside of the inverter.
- 2-pin wiring.
- Communication address does not have to be assigned.

Installation steps

- Switch off the inverters and Solar-Log™.
- Connect inverters to the Solar-Log™.
- Connect the inverters to each other.

Connect inverters to the Solar-Log™

The wiring is done using a self-made, shielded 2 wire data cable and terminal block connector.

Procedure

1. If you are making the cable yourself, connect the wires as shown in the following diagram

Solar-Log™ terminal strip connector	Solar-Log Base RS485 (A) / (B)	Inverters
RS485/422 B		RJ 14 socket
▶ 1 (Data+)	▶ (A) 6 or (B) 10 (Data+)	▶ Pin 2 - Data +
▶ 4 (Data-)	▶ (A) 9 or (B) 13 (Data-)	▶ Pin 4 - Data -

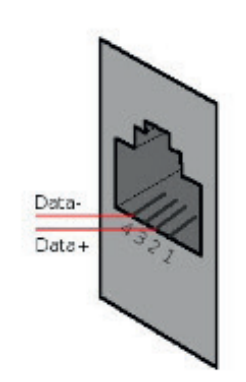

Fig.: RJ14 socket pin allocation

2. Close the inverter if no other inverters are to be connected.
3. Insert the terminal block connector into the Solar-Log™ RS485 socket.

Connect the inverters to each other

- Connect using a 2 wire, shielded data cable.
- Where to connect: RJ14 sockets.

Procedure

1. Open the inverter as shown in the inverter's instructions.
2. Insert the self-made cable with the RJ14 plug into any RJ14 socket on inverter 1.
3. Insert the RJ11 cable into the 2nd RJ11 socket on inverter 1 and into any RJ11 socket on inverter 2.
4. Connect the other inverters to each other in the same way.
5. Close inverters.
6. Insert the terminal block connector into the Solar-Log™ RS485 socket.

13 Autarco

13.1 Autarco

Termination	Addressing	Interface
Yes	Yes	RS485

Select „Autarco“ during the inverter detection.

Supported series:

- SX series
- MX series
- LX series
- XLX series
- UX series
- SX Mark II series
- MX Mark II series

Overview:

- Integrated interface.
- Where to connect: RJ45 socket, inside the inverter.
- 2-pin wiring.
- Communication address must be allocated.
- Installation steps:
 - Switch off the inverters and Solar-Log™.
 - Connect inverters to the Solar-Log™.
 - Connect the inverters to each other.
 - Allocate communication address.

Connecting the inverter to Solar-Log™

The wiring is done using a

- self-made cable connection with RJ45 plug and terminal block connector.

Procedure:

1. If you are making the cable yourself, connect the wires as shown in the following diagram:

Solar-Log™ terminal strip connector Solar-Log Base RS485 (A) / (B) Inverter RJ45

Terminal		Pin
▶ 1 (Data+)	▶ (A) 6 or (B) 10 (Data+)	▶ 1 RS485 A
▶ 1 (Data+)	▶ (A) 6 or (B) 10 (Data+)	▶ 4 RS485 A
▶ 4 (Data-)	▶ (A) 9 or (B) 13 (Data-)	▶ 2 RS485 B
▶ 4 (Data-)	▶ (A) 9 or (B) 13 (Data-)	▶ 5 RS485 B

2. Plug the RJ45 into the RJ45 OUT socket of the inverter.
3. If no further inverter is connected, terminate the inverter according to the instructions for the inverter.
4. Insert the terminal block connector into the Solar-Log™ RS485 socket.

Connect the inverters to each other

- Wiring via 2-wire shielded data cable.
- Where to connect: RJ45 socket.
- Wiring according to the instructions of the inverter manufacturer.
- Terminate the last inverter according to the instructions of the inverter manufacturer.

Allocate communication address

- Recommendation: Continuous numbering starting with 1.
- Default setting in the inverter: Communication address 1.
- Setting: Via inverter operating display.
- Procedure: According to the instructions of the inverter manufacturer.

Detection via the Solar-Log™ WEB Interface

- For detection on the Solar-Log™, select the device class under the menu Configuration | Device | Definition | Interface with the plus symbol and then select Autarco as the manufacturer. Confirm your selection with OK.
- Save your selections and then start the Device Detection under Configuration | Device | Detection.

Detection from the Solar-Log 1200

- When using the Solar-Log 1200, the detection can also be started from the display. Select the settings Start
▶ Initial Configuration ▶ Page 2 „Device“ ▶ Add and select the manufacturer Autarco from there. Save and start the Device Detection.

14 Benning

14.1 Benning

Termination	Addressing	Interface
No	Yes	LAN

Overview

- Integrated interface.
- The inverter's IP address has to be assigned.
- Connected using network cable (patch cable) and Ethernet router or switch.
- Installation steps:
 - The inverter's has to be assigned a static IP address.
 - Switch off the inverters and Solar-Log™.
 - Connect inverters to the Solar-Log™ (RJ45).
 - Connect the inverters to each other (RJ45).

Connect inverters to the Solar-Log™

The wiring is done using a

- network cable (patch cable/crossover cable) and the
- Ethernet router or switch.

Connect the inverters to each other

The inverters are connected together using

the RJ45 interface and, if needed, a router or switch.

Connection setup according to the inverter's instructions.

Assigning IP addresses

- A static IP address has to be assigned to the inverter via the display.
- Please select an IP address with the same class C subnet as the Solar-Log™.
For example: The Solar-Log™ has the IP address 192.168.178.49.
The inverter in this case has to have a free IP address in the same range (from 192.168.178.1 to 192.168.178.254).
- Procedure: Start according to the inverter's instructions.



Note

Each inverter has to be individually reachable via the network. For this, the network interface has to be activated for every inverter (select "Activate LAN" under the LAN menu) and the inverter needs to be connected to the local access network (LAN) via a switch.

Detection via the Solar-Log™ WEB Interface

- For detection on the Solar-Log™ , select the device class under the menu Configuration | Device | Definition | Interface with the plus symbol and then select Benning as the manufacturer. Confirm your selection with OK.
- Save your selections and then start the Device Detection under Configuration | Device | Detection.

Detection from the Solar-Log 1200

- When using the Solar-Log 1200, the detection can also be started from the display. Select the settings □Start ► Initial Configuration ► Page 2 „Device“ ► Add and select the manufacturer Benning from there. Save and start the Device Detection.



Note for feed-in management

Supported by Solar-Log starting with inverter firmware version 19.



Note

Using the inverter's web interface, select "External control via network interface" under "Settings ► Installation ► Grid Company Settings ► Power Reduction," and under "cos(phi) Settings."

15 Bonfiglioli (formerly Vectron)

15.1 Bonfiglioli

Termination	Addressing	Interface
DIP switch	Yes	RS485

Overview

- Integrated interface.
- Where to connect: Terminal strip inside the inverter.
- 3-pin wiring.
- Communication address must be allocated.
- Installation steps:
 - Switch off the inverters and Solar-Log™.
 - Connect inverters to the Solar-Log™.
 - Connect the inverters to each other.
 - Allocate communication address.

Connect inverters to the Solar-Log™

The wiring is done using a

- self-made, shielded 3 wire data cable with a terminal block connector.

Procedure

1. Get access to the inverter interface.
2. If you are making the cable yourself, connect the wires as shown in the following diagram:

Solar-Log™ terminal strip connector	Solar-Log Base RS485 (A) / (B)	Terminal strip inside the inverter
Terminal		RS485 terminal
▶ 1 (Data+)	▶ (A) 6 or (B) 10 (Data+)	▶ 1 A (Data+)
▶ 3 GND	▶ (A) 8 or (B) 12 GND	▶ 6 GND
▶ 4 (Data-)	▶ (A) 9 or (B) 13 (Data-)	▶ 3 B (Data-)

3. If no further inverter is connected, terminate the inverter:
In the inverter, set the DIP switch S1 for the terminal resistor to ON.
4. Insert the terminal block connector into the Solar-Log™ RS485 socket.

Connect the inverters to each other

- Where to connect: Terminal strip inside the inverter.
- 3-pin wiring.

Procedure

1. Get access to the inverter interface.
2. If you are making the cable yourself, connect the wires as shown in the following diagram:

Terminal strip inside the inverter	Terminal strip inside the inverter
RS485 terminal	RS485 terminal
▶ 1 A (Data+)	▶ 2 A (Data+)
▶ 6 GND	▶ 6 GND
▶ 3 B (Data-)	▶ 4 B (Data-)

3. Connect terminals on inverter 1 to the corresponding terminals on inverter 2.
4. Connect the other inverters to each other in the same way.
5. If no further inverter is connected, terminate the inverter:
Set the DIP S1 switch for the terminal resistor to ON.
6. Insert the terminal block connector into the Solar-Log™ RS485 socket.

Allocate communication address

- Recommendation: Continuous numbering starting with 1 going to 30.
- Setting: Using the inverter DIP switch.
- Procedure: Start according to the inverter's instructions.



Note

A maximum of 20 inverters can be connected per RS485 bus.

16 CanadianSolar

16.1 CanadianSolar - CSI-CT series

Termination	Addressing	Interface
No	Yes	RS485

The following types are to be connected according to this diagram:

- CSI-23KTL-CT
- CSI-28KTL-CT
- CSI-36KTL-CT

Select the inverter CanadianSolar for the inverter detection.

Overview

- Integrated interface.
- Where to connect: RJ45 socket on the outside of the inverter.
- 2-pin wiring.
- The communication addresses (1-247) have to be assigned.
- Installation steps:
 - Switch off the inverters and Solar-Log™.
 - Connect inverters to the Solar-Log™.
 - Connect the inverters to each other.
 - Allocate communication address.



Caution

Risk of damage to the unit!

The Solar-Log™ also has an RJ45 socket, which must never be connected to the RJ45 socket on the inverter.

- ▶ Only connect inverters via the RS485/422 Solar-Log™ interface(s).

Connect inverters to the Solar-Log™

The wiring is done using a

- self-made, shielded 2 wire data cable with a RJ45 socket and a terminal block connector.

Procedure

1. If you are making the cable yourself, connect the wires as shown in the following diagram:

Solar-Log™ terminal strip connector	Solar-Log Base RS485 (A) / (B)	RJ45 socket
Terminal		PIN
▶ 1 (Data+)	▶ (A) 6 or (B) 10 (Data+)	▶ 1 (+)
▶ 4 (Data-)	▶ (A) 9 or (B) 13 (Data-)	▶ 3 (-)

2. Insert the RJ45 plug into the RJ45 socket on the inverter.
3. Insert the terminal block connector into the Solar-Log™ RS485 socket.

Connect the inverters to each other

- Connect using a network cable (patch cable).
- Where to connect: RJ45 sockets on the outside of the inverter.

Procedure

1. Insert the RJ45 plug into the RJ45 socket on the first inverter.
2. Insert the other end of the wire into any RJ45 socket on inverter 2.
3. Connect the other inverters to each other in the same way.
4. Insert the terminal block connector into the Solar-Log™ RS485 socket.

Allocate communication address

- Recommendation: Continuous numbering starting with 1.
- Address range: 1 - 247.
- Setting: Using the inverter operating display.
- Procedure: Start according to the inverter's instructions.

16.2 CanadianSolar - CSI-GS/GI series

Termination	Addressing	Interface
Yes	Yes	RS485

Supported series:

- CSI-GS
- CSI-GI

Overview

- Integrated interface.
- Where to connect: Between the COM round sockets on the outside of the inverter.
- 2-pin wiring.
- Communication address must be allocated.
- Installation steps:
 - Switch off the inverters and Solar-Log™.
 - Connect inverters to the Solar-Log™.
 - Connect the inverters to each other.
 - Allocate communication address.

Connect inverters to the Solar-Log™

The wiring is done using a

- ready-made data cable (supplied with the inverter).
- or
- self-made, shielded 2 wire data cable with round plug and terminal block connector.

Procedure:

1. If you are making the cable yourself, connect the wires as shown in the following diagram:

Solar-Log™ terminal strip connector	Solar-Log Base RS485 (A) / (B)	Inverter RJ45
Terminal		Pin
▶ 1 (Data+)	▶ (A) 6 or (B) 10 (Data+)	▶ 1 RS485 A
▶ 1 (Data+)	▶ (A) 6 or (B) 10 (Data+)	▶ 4 RS485 A
▶ 4 (Data-)	▶ (A) 9 or (B) 13 (Data-)	▶ 2 RS485 B
▶ 4 (Data-)	▶ (A) 9 or (B) 13 (Data-)	▶ 5 RS485 B

2. Insert the RJ45 connector into the inverter's COM2 socket.
3. Terminate the inverter according to the manufacturer's instructions if no additional inverters are to be connected.
4. Insert the terminal block connector into the Solar-Log™ RS485 socket.

Connect the inverters to each other

- Wiring using CanadianSolar daisy chain cable.
- Where to connect: COM round socket on the inverter

Procedure:

1. Insert the RJ45 connector into the first inverter's COM3 socket.
2. Insert the other end of the cable into the COM2 socket on second inverter.
3. Connect the other inverters to each other in the same way.
4. Terminate the last inverter according to the inverter manufacturer's instructions.

Assign the communication address

- Recommendation: Continuous numbering starting with 1.
- Default settings on the inverter: Communication address 1.
- Setting: Using the inverter's operating display.
- Procedure: Start according to the inverter manufacturer's instructions.

17 Carlo Gavazzi

17.1 Carlo Gavazzi - ISMG model

Termination	Addressing	Interface
-	No	RS485

Select "Gavazzi ISMG" during the inverter detection.

Overview

- Integrated interface.
- Where to connect: RJ45 socket on the outside of the inverter.
- 2-pin wiring.
- Communication address does not have to be assigned.

Connect inverters to the Solar-Log™

The wiring is done using a

- ready-made BRJ2 data cable (optional extra; not supplied)
- or
- self-made, shielded 2 wire data cable and terminal block connector.

Installation steps:

- Switch off the inverters and Solar-Log™.
- Connect inverters to the Solar-Log™.
- Connect the inverters to each other.



Caution

Risk of damage to the unit!

The Solar-Log™ also has an RJ45 socket, which must never be connected to the RJ45 socket on the inverter.

- ▶ Only connect inverters via the RS485/422 Solar-Log™ interface(s).

Procedure

1. If you are making the cable yourself, connect the wires as shown in the following diagram:

Solar-Log™ terminal strip connector	Solar-Log Base RS485 (A) / (B)	Inverters
RS485/422 B		RJ 45 socket
▶ 1 (Data+)	▶ (A) 6 or (B) 10 (Data+)	▶ Pin 7
▶ 4 (Data-)	▶ (A) 9 or (B) 13 (Data-)	▶ Pin 8

2. Insert the RJ45 plug into any RJ45 socket on inverter 1.
3. Insert the terminal block connector into the Solar-Log™ RS485 socket.

Connect the inverters to each other

- Connect using a network cable (patch cable).
- Where to connect: RJ45 socket on the outside of the inverter.

Procedure

1. Insert the RJ45 plug into the free RJ45 socket on the first inverter.
2. Insert the other end of the cable into any RJ11 socket on inverter 2.
3. Connect the other inverters to each other in the same way.

17.2 Carlo Gavazzi - HINRG model

Termination	Addressing	Interface
DIP switch	Yes	RS485

Select "Gavazzi HINRG" during the inverter detection.

Overview

- Integrated interface.
- Where to connect: Terminal strip inside the inverter.
- 2-pin wiring.
- Communication address must be allocated.
- Installation steps:
 - Switch off the inverters and Solar-Log™.
 - Connect inverters to the Solar-Log™.
 - Connect the inverters to each other.
 - Allocate communication address.

Connect inverters to the Solar-Log™

The wiring is done using a

- self-made, shielded 2 wire data cable with a terminal block connector.

Procedure

1. Open the inverter as shown in the inverter's instructions.
2. If you are making the cable yourself, connect the wires as shown in the following diagram:

Solar-Log™ terminal strip connector	Solar-Log Base RS485 (A) / (B)	Terminal strip inside the inverter
Terminal		RS485 terminal
▶ 1 (Data+)	▶ (A) 6 or (B) 10 (Data+)	▶ 1 T/R 1+
▶ 4 (Data-)	▶ (A) 9 or (B) 13 (Data-)	▶ 2 T/R 1-

3. If no further inverter is connected, terminate the inverter:
In the inverter, set the DIP switch for the terminal resistor to ON.
4. Close inverters.
5. Insert the terminal block connector into the Solar-Log™ RS485 socket.

Connect the inverters to each other

- Where to connect: Terminal strip inside the inverter.
- 2-pin wiring.

Procedure

1. Open the inverter as shown in the inverter's instructions.
2. If you are making the cable yourself, connect the wires as shown in the following diagram:

Terminal strip inside the inverter	Terminal strip inside the inverter
RS485 terminal	RS485 terminal
▶ 1 T/R 1+	▶ 1 T/R 2+
▶ 2 T/R 1-	▶ 2 T/R 2-

3. Connect terminals A and B on inverter 1 to the corresponding terminals on inverter 2.
4. Connect the other inverters to each other in the same way.
5. If no further inverter is connected, terminate the inverter:
Set the DIP switch for the terminal resistor to ON.
6. Close inverters.
7. Insert the terminal block connector into the Solar-Log™ RS485 socket.

Allocate communication address

- Recommendation: Continuous numbering starting with 1.
- Setting: Using the inverter DIP switch.
- Procedure: Start according to the inverter's instructions.

18 Chint Power

18.1 Chint Power (CPS SC and CPS SCE to 20k)

Termination	Addressing	Interface
Yes	Yes	RS422

Overview

- Interface not integrated; Retrofit RS485 interface card.
- Where to connect: RJ45 socket on the outside of the inverter.
- 4-pin cable – only on RS485/422 B or C connection of the Solar-Log™.
- Communication address does not have to be assigned.



Note:

The order in which the inverters are displayed in the Solar-Log™ after detection is random. We strongly recommend that you change the order of the inverters immediately after detection at startup, in the [Configuration | Devices | Configuration | Order](#) dialog box.

- ▶ The inverters can be identified using the displayed serial number.

- Installation steps:
 - Switch off the inverters and Solar-Log™.
 - Install the RS485 interface in the inverter.
 - Connect inverters to the Solar-Log™.
 - Connect the inverters to each other.

Select the Chint CPS<20k inverter during the initial configuration.

Installing the RS485 interface

Procedure

- ▶ Insert the RS485 interface in the bottom of the inverter in accordance with the interface card installation instructions and screw in.

Connect inverters to the Solar-Log™

The wiring is done using a

- ready-made BRJ1 data cable (optional extra; not supplied)
- or
- self-made cable connection with RS485 data cable and terminal block connector.

Procedure



Caution

Risk of damage to the unit!

The Solar-Log™ also has an RJ45 socket, which must never be connected to the RJ45 socket on the inverter.

- ▶ Only connect inverters via the RS485/422 Solar-Log™ interface(s).



Note

Only connect inverter using the RS485/422 B or C interface.

1. If you are making the cable yourself, connect the wires as shown in the following diagram:

Solar-Log™ terminal strip connector	Solar-Log Base RS422	RJ45 inverter
Terminal		PIN
▶ 1 (T/RX+)	▶ 6 (T/RX+)	▶ Pin 3
▶ 4 (T/RX-)	▶ 9 (T/RX-)	▶ Pin 6
▶ 5 (R/TX+)	▶ 10 (R/TX+)	▶ Pin 1
▶ 6 (R/TX-)	▶ 13 (R/TX-)	▶ Pin 2

2. Insert the RJ45 plug into any RJ45 socket on inverter 1.
3. If no further inverter is connected, terminate the inverter according to the instructions for the inverter.
4. Insert the terminal block connector into the Solar-Log™ RS485/422 B or C socket.

Connect the inverters to each other

- Connect using a network cable (patch cable).
- Where to connect: RJ45 socket on the outside of the inverter.

Procedure

1. Insert the RJ45 plug into any RJ45 socket on inverter 1.
2. Insert the other end of the wire into any RJ45 socket on inverter 2.
3. Connect the other inverters to each other in the same way.
4. Terminate in the last inverter in accordance with the inverter instructions.

18.2 Chint Power (CPS 20k+)

Termination	Addressing	Interface
Yes	Yes	RS485

Overview

- Integrated interface.
- Where to connect: RJ45 socket on the outside of the inverter.
- 2-pin wiring.
- The communication addresses (1-32) have to be assigned.
- Installation steps:
 - Switch off the inverters and Solar-Log™.
 - Connect inverters to the Solar-Log™.
 - Connect the inverters to each other.

Select the Chint CPS20k+ inverter during the initial configuration.

Connect inverters to the Solar-Log™

The wiring is done using a

- self-made cable connection with RS485 data cable and terminal block connector.

Procedure



Caution

Risk of damage to the unit!

The Solar-Log™ also has an RJ45 socket, which must never be connected to the RJ45 socket on the inverter.

- ▶ Only connect inverters via the RS485/422 Solar-Log™ interface(s).

1. Connect wires as shown in the diagram below:

Solar-Log™ terminal strip connector	Solar-Log Base RS485 (A) / (B)	RJ45 inverter
Terminal		PIN
▶ 1 (Data+)	▶ (A) 6 or (B) 10 (Data+)	▶ 1-485+
▶ 4 (Data-)	▶ (A) 9 or (B) 13 (Data-)	▶ 3-485-

2. Insert the RJ45 plug into any RJ45 socket on inverter 1.
3. If no further inverter is connected, terminate the inverter according to the instructions for the inverter.
4. Insert the terminal block connector into the Solar-Log™ RS485 socket.

Connect the inverters to each other

- Connect using a network cable (patch cable).
- Where to connect: RJ45 socket on the outside of the inverter.

Procedure

1. Insert the RJ45 plug into any RJ45 socket on inverter 1.
2. Insert the other end of the wire into any RJ45 socket on inverter 2.
3. Connect the other inverters to each other in the same way.
4. Terminate in the last inverter in accordance with the inverter instructions.
5. Allocate communication address.

Allocate communication address

- Recommendation: Continuous numbering starting with 1.
- Address range: 1 - 32.
- Setting: Using the inverter operating display.
- Procedure: Start according to the inverter's instructions.

18.3 Chint Power Modbus (DO - DO/HE)

Termination	Addressing	Interface
No	Yes	RS485

Selection available under Chint Power: Modbus.

The following types are to be connected according to this diagram:

- CPS SCA5KTL-DO
- CPS SCA6KTL-DO
- CPS SCA7KTL-DO
- CPS SCA8KTL-DO
- CPS SCA10KTL-DO
- CPS SCA12KTL-DO
- CPS SCA8KTL-DO/HE
- CPS SCA10KTL-DO/HE
- CPS SCA12KTL-DO/HE

Select the inverter Chint-Mod for the inverter detection.

Overview

- Integrated interface.
- Where to connect: RJ45 socket on the outside of the inverter.
- 2-pin wiring.
- The communication addresses (1-247) have to be assigned.
- Installation steps:
 - Switch off the inverters and Solar-Log™.
 - Connect inverters to the Solar-Log™.
 - Connect the inverters to each other.
 - Allocate communication address.



Caution

Risk of damage to the unit!

The Solar-Log™ also has an RJ45 socket, which must never be connected to the RJ45 socket on the inverter.

- ▶ Only connect inverters via the RS485/422 Solar-Log™ interface(s).

Connect inverters to the Solar-Log™

The wiring is done using a

- self-made, shielded 2 wire data cable with a RJ45 socket and a terminal block connector.

Procedure

1. If you are making the cable yourself, connect the wires as shown in the following diagram:

Solar-Log™ terminal strip connector	Solar-Log Base RS485 (A) / (B)	RJ45 socket
Terminal		PIN
▶ 1 (Data+)	▶ (A) 6 or (B) 10 (Data+)	▶ 1 (+)
▶ 4 (Data-)	▶ (A) 9 or (B) 13 (Data-)	▶ 3 (-)

2. Insert the RJ45 plug into the RJ45 socket on the inverter.
3. Insert the terminal block connector into the Solar-Log™ RS485 socket.

Connect the inverters to each other

- Connect using a network cable (patch cable).
- Where to connect: RJ45 sockets on the outside of the inverter.

Procedure

1. Insert the RJ45 plug into the RJ45 socket on the first inverter.
2. Insert the other end of the wire into any RJ45 socket on inverter 2.
3. Connect the other inverters to each other in the same way.
4. Insert the terminal block connector into the Solar-Log™ RS485 socket.

Allocate communication address

- Recommendation: Continuous numbering starting with 1.
- Address range: 1 - 247.
- Setting: Using the inverter operating display.
- Procedure: Start according to the inverter's instructions.

18.4 Chint Power Modbus (DO/US)

Termination	Addressing	Interface
Yes	Yes	RS485

Selection available under Chint Power: Modbus

The following types are to be connected according to this diagram:

- SCA50KTL-DO/US-480
- SCA60KTL-DO/US-480

Overview

- Integrated interface
- Where to connect: Terminal strip inside the inverter.
- 3-pin wiring.
- The communication address has to be assigned.
- Installation steps
 - Switch off the inverters and the Solar-Log™.
 - Connect inverters to the Solar-Log™.
 - Connect the inverters to each other.
 - Allocate communication address.
Address range 1 to 254
Settings on the inverter's display according to the manufacturer's manual.

Connect inverters to the Solar-Log™.

The wiring is done using a

- self-made cable connection with terminal block connector.
- Where to connect: Terminal strip inside the inverter.

Procedure

1. If you are making the cable yourself, connect the wires as shown in the following diagram:

Solar-Log™ terminal strip connector	Solar-Log Base RS485 (A) / (B)	RJ45 inverter
Terminal		PIN
▶ 1 (Data+)	▶ (A) 6 or (B) 10 (Data+)	▶ RS485+
▶ 3 GND	▶ (A) 8 or (B) 12 GND	▶ GND
▶ 4 (Data-)	▶ (A) 9 or (B) 13 (Data-)	▶ RS485-

2. If no further inverter is connected, terminate the inverter according to the instructions for the inverter.
3. Insert the terminal block connector into the Solar-Log™ RS485 socket.

Connect the inverters to each other.

- Connect using a network cable (patch cable).
- Where to connect: RJ45 sockets inside the inverter.

Procedure

1. Insert the RJ45 plug into the free RJ45 socket on the first inverter.
2. Insert the other end of the wire into any RJ45 socket on inverter 2.
3. Connect the other inverters to each other in the same way.
4. Terminate the last inverter in accordance with the inverter instructions.

19 CMS

19.1 CMS

Termination	Addressing	Interface
DIP switch	Yes	RS485

Overview

- Integrated interface.
- Where to connect: Terminal strip inside the inverter.
- 2-pin wiring.
- Communication address must be allocated.
- Installation steps:
 - Switch off the inverters and Solar-Log™.
 - Connect inverters to the Solar-Log™.
 - Connect the inverters to each other.
 - Allocate communication address.

Connect inverters to the Solar-Log™

The wiring is done using a

- self-made, shielded 2 wire data cable with a terminal block connector.

Procedure

1. Open the inverter as shown in the inverter's instructions.
2. If you are making the cable yourself, connect the wires as shown in the following diagram:

Solar-Log™ terminal strip connector	Solar-Log Base RS485 (A) / (B)	Terminal strip inside the inverter
Terminal		RS485 terminal
▶ 1 (Data+)	▶ (A) 6 or (B) 10 (Data+)	▶ 1 T/R 1+
▶ 4 (Data-)	▶ (A) 9 or (B) 13 (Data-)	▶ 2 T/R 1-

3. If no further inverter connected, terminate the inverter:
In the inverter, set the DIP switch for the terminal resistor to ON.
4. Close inverters.
5. Insert the terminal block connector into the Solar-Log™ RS485 socket.

Connect the inverters to each other

- Where to connect: Terminal strip inside the inverter.
- 2-pin wiring.

Procedure

1. Open the inverter as shown in the inverter's instructions.
2. If you are making the cable yourself, connect the wires as shown in the following diagram:

Terminal strip inside the inverter	Terminal strip inside the inverter
RS485 terminal	RS485 terminal
▶ 1 T/R 1+	▶ 1 T/R 2+
▶ 2 T/R 1-	▶ 2 T/R 2-

3. Connect terminals A and B on inverter 1 to the corresponding terminals on inverter 2.
4. Connect the other inverters to each other in the same way.
5. Terminate the last inverter.
Set the DIP switch for the terminal resistor to ON.
6. Close inverters.
7. Insert the terminal block connector into the Solar-Log™ RS485 socket.

Allocate communication address

- Recommendation: Continuous numbering starting with 1.
- Setting: Using the inverter DIP switch.
- Procedure: Start according to the inverter's instructions.

20 Conergy

20.1 Conergy (only Solar-Log 1000, 1900 and 2000)



Note

Conergy inverters can only be connected to the Solar-Log 1000, 1900 and 2000, as only this one has a CAN interface.

The following description relates to inverters without transformers produced in or after 2007.

Termination	Addressing	Interface
Yes	No	CAN bus

Overview

- CAN only to be used on Solar-Log 1000, 1900 and 2000 (CAN interface).
- Integrated interface.
- Where to connect: CAN socket on the outside of the bottom of the inverter.
- Only use ready-made cable sets.

Two different special cable sets must be ordered separately.

- Prefabricated cable set between the Solar-Log 1000, 1900 and 2000 and the first inverter, including cable termination.
- Ready-made cable set with 5 pin Phoenix contact connection plug for connecting the inverters to each other.
- Depending on the number of inverters several of these cables will be required.

Maximum total cable length: 200 m

- Communication address does not have to be assigned.
- Installation steps:
 - Switch off the inverters and Solar-Log™.
 - Connect inverters to the Solar-Log™.
 - Connect the inverters to each other.

PIN assignment:

Solar-Log™ terminal strip connector	Sensor / actuator connector 5-pin
Terminal	Pin
▶ 4 not used	▶ 1 not used
▶ 5 not used	▶ 2 not used
▶ 1	▶ 3
▶ 3	▶ 4
▶ 2	▶ 5

At Solarlog™ set a 120 Ω resistor between PIN 2 and 3.

Connect the inverters to the Solar-Log 1000, 1900 and 2000.

Connection is only done using a ready-made data cable, specially for connecting to the Solar-Log 1000, 1900 and 2000 (optional extra; not supplied).

Procedure

1. Insert the CAN plug into the inverter CAN IN socket.
2. If no further inverter connected, terminate the inverter:
Insert the two 5 pin 120 Ω terminal resistors from the ready-made cable set into the CAN OUT socket.
3. Insert the terminal block connector into the Solar-Log 1000, 1900 and 2000 CAN socket.

Connecting inverters to each other (only Solar-Log 1000, 1900 and 2000)

- Connection is made only with a ready-made data cable specially for connecting the inverters to each other (optional extra: not supplied).
- Where to connect: CAN socket outside the inverter.

Procedure

1. Insert the CAN plug into any CAN OUT socket on inverter 1.
2. Insert the other end of the wire into any CAN IN socket on inverter 2.
3. Connect the other inverters to each other in the same way.
4. Terminate the last inverter.
Insert the two 5 pin 120 Ω terminal resistors from the ready-made cable set into the CAN OUT socket.

21 CyberPower

21.1 CyberPower

Termination	Addressing	Interface
Yes	Yes	RS485

Overview

- Integrated RS485 interface.
- 8-pin cable for the RS485 connection of the Solar-Log™.
- The communication addresses (1-247) have to be assigned.
- Installation steps:
 - Switch off the inverters and Solar-Log™.
 - Connect inverters to the Solar-Log™.
 - Connect the inverters to each other.
 - Allocate communication address.

Connect inverters to the Solar-Log™

The wiring is done using a

- partially ready-made RJ45 cable (not included)
- or
- self-made data cable with RJ45 plug and 6-pin terminal block connector.



Caution

Risk of damage to the unit!

The Solar-Log™ also has an RJ45 socket, which must never be connected to the RJ45 socket on the inverter.

- ▶ Only connect inverters via the RS485/422 Solar-Log™ interface(s).

Procedure

1. Connect wires as shown in the diagram:

Solar-Log™ terminal strip connector	Solar-Log Base RS485 (A) / (B)	RJ45 inverter
Terminal		PIN
▶ 1 (Data+)	▶ (A) 6 or (B) 10 (Data+)	▶ 3 RS485 A
▶ 4 (Data-)	▶ (A) 9 or (B) 13 (Data-)	▶ 4 RS485 B

2. Run the wire from the Solar-Log™ to inverter 1 through the hole for the wire on the bottom of the unit.
3. In the inverter insert the RJ45 plug into the "RS-485 out" socket.
4. Insert the terminal block connector into the Solar-Log™ RS485 socket.

Connect the inverters to each other

- Connect using a network cable (patch cable).
- Where to connect: RJ45 socket on the outside of the inverter.

Procedure

1. Insert the RJ45 plug in inverter 1 into the RJ45 socket.
2. Insert the other end of the wire into the other RJ45 socket on inverter 2.
3. Connect the other inverters to each other in the same way.
4. Insert the terminal block connector into the Solar-Log™ RS485 socket.
5. Terminate the last inverter according to the inverter instructions.

Allocate communication address

- Recommendation: Continuous numbering starting with 1.
- Address range: 1 - 247.
- Setting: Using the inverter operating display.
- Procedure: Start according to the inverter's instructions.

22 Danfoss

22.1 Danfoss

Termination	Addressing	Interface
Connection plug	No	RS485

Overview

- Integrated interface.
- Where to connect: 2 RJ45 sockets on the right on the side cover.
- Communication address does not have to be assigned.
- 4-pin wiring.
- Installation steps:
 - Switch off the inverters and Solar-Log™.
 - Connect inverters to the Solar-Log™.
 - Connect the inverters to each other.

Connect inverters to the Solar-Log™

The wiring is done using a

- ready-made RJ45 data cable (optional extra; not supplied)
- or
- self-made cable connection with RS485 data cable and terminal block connector.



Caution

The Master Mode has to be deactivated in the Pro series devices. See the manufacturer's manual for more detailed instructions.

Procedure

1. Unscrew the side cover as shown in the inverter's instructions.
2. If you are making the cable yourself, connect the wires as shown in the following diagram:

Solar-Log™ terminal strip connector	Solar-Log Base RS485 (A) / (B)	RJ45 inverter
Terminal		PIN
▶ 1 (Data+)	▶ (A) 6 or (B) 10 (Data+)	▶ 6
▶ 3 GND	▶ (A) 8 or (B) 12 GND	▶ 1
▶ 3 GND	▶ (A) 8 or (B) 12 GND	▶ 2
▶ 4 (Data-)	▶ (A) 9 or (B) 13 (Data-)	▶ 3



Caution

Risk of damage to the unit!

The Solar-Log™ also has an RJ45 socket, which must never be connected to the RJ45 socket on the inverter.

- ▶ Only connect inverters via the RS485/422 Solar-Log™ interface(s).
-

3. If no further inverter connected, terminate the inverter:
Insert the supplied connection plug into any free RJ45 socket on the inverter.
The connection plug is an 8-pin dummy plug with bridged wires: Bridge wires 3 and 4 and wires 5 and 6.
4. Screw the inverter cover on again.
5. Insert the terminal block connector into the Solar-Log™ RS485 socket.

Connect the inverters to each other

- Connect using a network cable (patch cable).
- Where to connect: 2 RJ45 sockets on the right on the side cover.

Procedure

1. Unscrew the side cover as shown in the inverter's instructions.
2. Insert the RJ45 plug into any RJ45 socket on inverter 1.
3. Insert the other end of the wire into any RJ45 socket on inverter 2.
4. Connect the other inverters to each other in the same way.
5. Terminate the last inverter.
Insert the connection plug into the free RJ45 socket.
6. Screw the inverter cover on again.

23 Delta

23.1 Delta (RS485)

Termination	Addressing	Interface
Resistor	Yes	RS485

Overview

- Integrated interface.
- Where to connect: RJ45 socket on the outside of the inverter.
- 3-pin wiring.
- Communication address must be allocated.
- Installation steps:
 - Switch off the inverters and Solar-Log™.
 - Connect inverters to the Solar-Log™.
 - Connect the inverters to each other.
 - Allocate communication address.

Connect inverters to the Solar-Log™

The wiring is done using a

- ready-made Delta data cable (optional extra; not supplied)

or

- self-made cable connection with RS485 data cable and terminal block connector.



Caution

Risk of damage to the unit!

The Solar-Log™ also has an RJ45 socket, which must never be connected to the RJ45 socket on the inverter.

- ▶ Only connect inverters via the RS485/422 Solar-Log™ interface(s).

Procedure

1. If you are making the cable yourself, connect the wires as shown in the following diagram:

Solar-Log™ terminal strip connector	Solar-Log Base RS485 (A) / (B)	RJ45 inverter
Terminal		PIN
▶ 1 (Data+)	▶ (A) 6 or (B) 10 (Data+)	▶ 7
▶ 3 GND	▶ (A) 8 or (B) 12 GND	▶ 6
▶ 4 (Data-)	▶ (A) 9 or (B) 13 (Data-)	▶ 8



Note

The PIN allocation has been changed with the new generation. 3 wired cabling functions with both generations.

2. Insert the RJ45 plug into the RJ45 socket on the inverter.
3. If no further inverter connected, terminate the inverter:
Insert the 120 Ω resistor into the free RJ45 socket.
4. Insert the terminal block connector into the Solar-Log™ RS485 socket.
5. Close the unit cover on the bottom of the inverter.

□

Connect the inverters to each other

- Connect using a network cable (patch cable)
- Where to connect: RJ45 sockets on the outside of the inverter.

Procedure

1. Insert the RJ45 plug into any RJ45 socket on inverter 1.
2. Insert the other end of the wire into any RJ45 socket on inverter 2.
3. Connect the other inverters to each other in the same way.
4. Terminate the last inverter.
Insert the 120 Ω resistor into the free RJ45 socket.

Allocate communication address

- Recommendation: Continuous numbering starting with 1.
- Set the inverter baud rate to 19200.
- Setting: Using the inverter operating display.
- Procedure: Start according to the inverter's instructions.

23.2 Delta RPI (Standard)

Termination	Addressing	Interface
Yes	Yes	RS485

Selections available under Delta Standard

Overview

- Integrated interface.
- Where to connect: Terminal strip inside the inverter.
- 3-pin wiring.
- Communication address must be allocated.
- Installation steps:
 - Switch off the inverters and the Solar-Log™.
 - Connect the inverters to the Solar-Log™.
 - Connect the inverters to each other.
 - Assign the communication address.

Connect the inverters to the Solar-Log™

The wiring is done using a

- self-made, shielded 3-wire data cable and terminal block connector.

Procedure

1. Open the inverter according to the inverter's instructions.
2. Pull the free wires through the wire opening in the inverter.
3. If you are making the cable yourself, connect the wires as shown in the following diagram:

Solar-Log™ terminal strip connector	Solar-Log Base RS485 (A) / (B)	Inverter terminal strip
Terminal		Terminal
▶ 1 (Data+)	▶ (A) 6 or (B) 10 (Data+)	▶ 3 (Data+)
▶ 3 GND	▶ (A) 8 or (B) 12 GND	▶ 2 GND
▶ 4 (Data-)	▶ (A) 9 or (B) 13 (Data-)	▶ 4 (Data-)

4. If no further inverter connected, terminate the inverter:
Set the switch inside the inverter to ON and all other inverters to OFF.
5. Close the inverter if no other inverters are to be connected.
6. Insert the terminal block connector into the Solar-Log™ RS485 socket.

Connect the inverters to each other

- Connect using a 3-wire, shielded data cable.
- Where to connect: Terminal strip inside the inverter.

The RS485 connections on the terminal strip are each double connections so that the wiring can be continued to the next inverter.

Procedure

1. Connect the data cable in the free terminals of the first inverter – 2 (GND), 3 (Data+) and 4 (Data-).
2. Connect the other end of the data cable in the free terminals of the second inverter – 2 (GND), 5 (Data+) and 6 (Data-).
3. Connect the other inverters to each other in the same way.
4. Terminate the last inverter:
Set the switch inside the inverter to ON and all other inverters to OFF.
5. Close inverters.

Assign the communication address

- Recommendation: Continuous numbering starting with 1.
- Setting: Using the inverter operating display.
- Procedure: Start according to the inverter's instructions.

23.3 Delta RPI - Sunspec Protokoll

Termination	Addressing	Interface
Switch	Yes	RS485

Selections available under Delta: Sunspec.

Supported models:

- M80U
- M88H

Overview

- Integrated interface.
- Where to connect: Terminal strip inside the inverter.
- 3-pin wiring.
- Communication address must be allocated.
- Installation steps:
 - Switch off the inverters and the Solar-Log™.
 - Connect the inverters to the Solar-Log™.
 - Connect the inverters to each other.
 - Assign the communication address.

Connect the inverters to the Solar-Log™

The wiring is done using a

- self-made, shielded 3-wire data cable and terminal block connector.

Procedure

1. Open the inverter according to the inverter's instructions.
2. Pull the free wires through the wire opening in the inverter.
3. If you are making the cable yourself, connect the wires as shown in the following diagram:

Solar-Log™ terminal strip connector	Solar-Log Base RS485 (A) / (B)	Inverter terminal strip
Terminal		Terminal
▶ 1 (Data+)	▶ (A) 6 or (B) 10 (Data+)	▶ 3 (Data+)
▶ 3 GND	▶ (A) 8 or (B) 12 GND	▶ 2 GND
▶ 4 (Data-)	▶ (A) 9 or (B) 13 (Data-)	▶ 4 (Data-)

4. If no further inverter connected, terminate the inverter:
Set the switch inside the inverter to ON and all other inverters to OFF.
5. Close the inverter if no other inverters are to be connected.
6. Insert the terminal block connector into the Solar-Log™ RS485 socket.

Connect the inverters to each other

- Connect using a 3-wire, shielded data cable.
- Where to connect: Terminal strip inside the inverter.

The RS485 connections on the terminal strip are each double connections so that the wiring can be continued to the next inverter.

Procedure

1. Connect the data cable in the free terminals of the first inverter – 2 (GND), 3 (Data+) and 4 (Data-).
2. Connect the other end of the data cable in the free terminals of the second inverter – 2 (GND), 5 (Data+) and 6 (Data-).
3. Connect the other inverters to each other in the same way.
4. Terminate the last inverter:
Set the switch inside the inverter to ON and all other inverters to OFF.
5. Close inverters.

Assign the communication address

- Recommendation: Continuous numbering starting with 1.
- Setting: Using the inverter operating display.
- Procedure: Start according to the inverter's instructions.

24 Diehl Ako

24.1 Diehl Ako

Diehl Ako inverters have been listed as „Diehl Ako“ in our firmware up to version 3.1.1. Starting with firmware version 3.1.2 they will be listed as „Platinum“.

25 Eaton

25.1 Eaton

Termination	Addressing	Interface
Yes	No	RS422

Overview

- Interface not integrated; Retrofit RS485 interface card.
- 4-pin cable – only on RS485/422 B or C connection of the Solar-Log™.
- Communication address does not have to be assigned.
- Multi-string technology.

Eaton inverters are fitted with 1 or 3 MPP trackers depending on the model. Each string input is monitored separately and ideally adjusted to the connected modules.

The Solar-Log™ automatically detects how many inverters and strings are active during inverter detection.



Note

The order in which the inverters are displayed in the Solar-Log™ after detection is random. We strongly recommend that you change the order of the inverters immediately after detection at startup, in the [Configuration | Devices | Configuration | Order](#) dialog box.

- ▶ The inverters can be identified using the displayed serial number.

- Installation steps:
 - Disconnect the power for the inverter and Solar-Log™ .
 - Connect the RS485 interface in the inverter.
 - Connect inverters to the Solar-Log™.
 - Connect the inverters to each other.

Installing the RS485 interface

Procedure

- ▶ Insert the RS485 interface in the bottom of the inverter in accordance with the interface card installation instructions and screw in.

Connect inverters to the Solar-Log™

The wiring is done using a

- ready-made data cable (optional extra; not supplied)
- or
- self-made, shielded 4 wire data cable and terminal block connector.



Note

Only connect inverter using the RS485/422 B or C interface.

Procedure

1. Open the inverter as shown in the inverter's instructions.
2. Pull the free wires through the wire opening in the inverter.
3. If you are making the cable yourself, connect the wires as shown in the following diagram:

Solar-Log™ terminal strip connector	Solar-Log Base RS422	Inverter terminal strip
Terminal		Terminal
▶ 1 (T/RX+)	▶ 6 (T/RX+)	▶ R+
▶ 4 (T/RX-)	▶ 9 (T/RX-)	▶ R-
▶ 5 (R/TX+)	▶ 10 (R/TX+)	▶ T+
▶ 6 (R/TX-)	▶ 13 (R/TX-)	▶ T-

4. If no further inverter is connected, terminate the inverter according to the instructions for the inverter.
5. Close the inverter if no other inverters are to be connected.
6. Insert the terminal block connector into the Solar-Log™ RS485/422 B or C socket.

Connect the inverters to each other

- Connect using a 4 wire, shielded data cable.
- Where to connect: Terminal strip inside the inverter (on the retrofitted RS485 interface).

Procedure

1. Open the inverter as shown in the inverter's instructions.
2. Connect terminals R+, R-, T+ and T- of inverter 1 to the corresponding terminals on inverter 2.
3. Connect the other inverters to each other in the same way.
4. Terminate the last inverter according to the inverter instructions.
5. Close inverters.

26 EEI

26.1 EEI

Termination	Addressing	Interface
No	Yes	LAN

Overview

- Integrated interface.
- The inverter's IP address has to be assigned.
- Connected using network cable (patch cable) and Ethernet router or switch.
- Installation steps:
 - The inverter's has to be assigned a static IP address.
 - Switch off the inverters and Solar-Log™.
 - Connect inverters to the Solar-Log™ (RJ45).
 - Connect the inverters to each other (RJ45).

Connect inverters to the Solar-Log™

The wiring is done using a

- network cable (patch cable/crossover cable) and the
- Ethernet router or switch.

Connect the inverters to each other

The inverters are connected together using the RJ45 interface and, if needed, a router or switch.

Connection setup according to the inverter's instructions.

Assigning IP addresses

- A static IP address has to be assigned to the inverter via the display.
- Please select an IP address with the same class C subnet as the Solar-Log™.
For example: The Solar-Log™ has the IP address 192.168.178.49.
The inverter in this case has to have a free IP address in the same range (from 192.168.178.1 to 192.168.178.254).
- Procedure: Start according to the inverter's instructions.

Detection via the Solar-Log™ WEB Interface

- For detection on the Solar-Log™, select the device class under the menu Configuration | Device | Definition | Interface with the plus symbol and then select EEI as the manufacturer. Confirm your selection with OK.
- Save your selections and then start the Device Detection under Configuration | Device | Detection.

Detection from the Solar-Log 1200

- When using the Solar-Log 1200, the detection can also be started from the display. Select the settings Start ► Initial Configuration ► Page 2 „Device“ ► Add and select the manufacturer EEI from there. Save and start the Device Detection.

27 Effekta

27.1 Effekta

Termination	Addressing	Interface
Jumper	Yes	RS485

Select "Effekta: ES" during the inverter detection.

Overview

- Interface not integrated; Retrofit Effekta RS485 interface.
- 3-pin wiring
- Communication address must be allocated
- Installation steps
 - Switch off the inverters and Solar-Log™
 - Install the RS485 interface in the inverter
 - Connect inverters to the Solar-Log™
 - Connect the inverters to each other
 - Allocate communication address

Installing the RS485 interface

Procedure

- ▶ Install the RS485 interface in the inverter in accordance with the interface card installation instructions.

Connect inverters to the Solar-Log™

The wiring is done using a

- ready-made data cable (optional extra; not supplied)
- or
- self-made, shielded 3 wire data cable and terminal block connector.

Procedure

1. Open the inverter as shown in the inverter's instructions.
2. If you are making the cable yourself, connect the wires as shown in the following diagram:

Solar-Log™ terminal strip connector	Solar-Log Base RS485 (A) / (B)	Inverter terminal strip
Terminal		Terminal
▶ 1 (Data+)	▶ (A) 6 or (B) 10 (Data+)	▶ Pin 2 RS485 A (+)
▶ 3 GND	▶ (A) 8 or (B) 12 GND	▶ Pin 3 GND
▶ 4 (Data-)	▶ (A) 9 or (B) 13 (Data-)	▶ Pin 1 RS485 B (-)

3. If no further inverter connected, terminate the inverter:
Set the jumper on the RS485 interface card to ON.
4. Close the inverter if no other inverters are to be connected.
5. Insert the terminal block connector into the Solar-Log™ RS485 socket.

Connect the inverters to each other

- Connect using a 3 wire, shielded data cable
- Where to connect: Terminal strip inside the inverter (on the retrofitted RS485 interface).

Procedure

1. Open the inverter as shown in the inverter's instructions.
2. Using the data cable connect terminals "Pin 2-RS485-A (+)", "Pin 3-GND" and "Pin 1-RS485-B (-)" of inverter 1 to the corresponding terminals on inverter 2.
3. Connect the other inverters to each other in the same way.
4. Terminate the last inverter.
Set the jumper on the RS485 interface card to ON.
5. Close inverters.

Allocate communication address

- Recommendation: Continuous numbering starting with 1.
- Setting: Using the inverter operating display
- Procedure: Start according to the inverter's instructions

27.2 Effekta KS Multitracker

Termination	Addressing	Interface
DIP switch	Yes	RS485

Select "Effekta: KS Trio" during the inverter detection

Overview

- Integrated interface.
- 3-pin wiring.
- 2 RJ45 sockets on the outside of the inverter.
- Communication address must be allocated.
- Installation steps:
 - Switch off the inverters and Solar-Log™.
 - Connect inverters to the Solar-Log™.
 - Connect the inverters to each other.
 - Allocate communication address.
Address range 1 to 32.
Settings on the inverter's display according to the manufacturer's manual.

Connect inverters to the Solar-Log™

The wiring is done using a

- self-made cable connection with RS485 data cable and terminal block connector.



Caution

Risk of damage to the unit!

The Solar-Log™ also has an RJ45 socket, which must never be connected to the RJ45 socket on the inverter.

- ▶ Only connect inverters via the RS485/422 Solar-Log™ interface(s).

Procedure

1. If you are fabricating the cable yourself, connect the wires as shown in the following diagram:

Solar-Log™ terminal strip connector	Solar-Log Base RS485 (A) / (B)	RS485 inverter socket
Terminal		PIN
▶ 1 (Data+)	▶ (A) 6 or (B) 10 (Data+)	▶ Pin 1 (A) T/R+
▶ 3 GND	▶ (A) 8 or (B) 12 GND	▶ Pin 5 GND
▶ 4 (Data-)	▶ (A) 9 or (B) 13 (Data-)	▶ Pin 2 (B) T/R-

2. Insert the RJ45 plug into the RJ45 socket on the inverter.
3. If no further inverter connected, terminate the inverter:
Set the dip switch to "on."
4. Insert the terminal block connector into the Solar-Log™ RS485 socket.

Connect the inverters to each other

- Connect using a network cable (patch cable) (No Crossover cable).
- Where to connect: RJ45 sockets on the outside of the inverter.

Procedure

1. Insert the RJ45 plug into the free RJ45 socket on the first inverter.
2. Insert the other end of the wire into any RJ45 socket on inverter 2.
3. Connect the other inverters to each other in the same way.
4. Terminate the last inverter, set the DIP switch to "on."

Allocate communication address

- Recommendation: Continuous numbering from 1 to 32.
- Setting: Using the inverter operating display.
- Procedure: Start according to the inverter's instructions.



Note

The following setting needs to be enable so that the PM parameters can be received.
SETUP ▶ REMOTE CNTRL ▶ ENABLE

27.3 Effekta KS Singletracker

Termination	Addressing	Interface
DIP switch	Yes	RS485

Select "Effekta: KS ST/DT" during the inverter detection.

Overview

- Integrated interface.
- 3-pin wiring.
- 2 RJ45 sockets on the outside of the inverter.
- Communication address must be allocated.
- Installation steps:
 - Switch off the inverters and Solar-Log™.
 - Connect inverters to the Solar-Log™.
 - Connect the inverters to each other.
 - Allocate communication address.
 - Address range 1 to 254.
 Settings on the inverter's display according to the manufacturer's manual.

Connect inverters to the Solar-Log™

The wiring is done using a

- self-made cable connection with RS485 data cable and terminal block connector.



Caution

Risk of damage to the unit!

The Solar-Log™ also has an RJ45 socket, which must never be connected to the RJ45 socket on the inverter.

- ▶ Only connect inverters via the RS485/422 Solar-Log™ interface(s).

Procedure

1. If you are fabricating the cable yourself, connect the wires as shown in the following diagram:

Solar-Log™ terminal strip connector	Solar-Log Base RS485 (A) / (B)	RS485 inverter socket
Terminal		PIN
▶ 1 (Data+)	▶ (A) 6 or (B) 10 (Data+)	▶ Pin 1 (A) T/R+
▶ 3 GND	▶ (A) 8 or (B) 12 GND	▶ Pin 5 GND
▶ 4 (Data-)	▶ (A) 9 or (B) 13 (Data-)	▶ Pin 2 (B) T/R-

2. Insert the RJ45 plug into the RJ45 socket on the inverter.
3. If no further inverter connected, terminate the inverter:
Set the dip switch to "on."
4. Insert the terminal block connector into the Solar-Log™ RS485 socket.

Connect the inverters to each other

- Connect using a network cable (patch cable) (No Crossover cable).
- Where to connect: RJ45 sockets on the outside of the inverter.

Procedure

1. Insert the RJ45 plug into the free RJ45 socket on the first inverter.
2. Insert the other end of the wire into any RJ45 socket on inverter 2.
3. Connect the other inverters to each other in the same way.
4. Terminate the last inverter, set the DIP switch to "on."

Allocate communication address

- Recommendation: Continuous numbering from 1 to 254.
- Setting: Using the inverter operating display.
- Procedure: Start according to the inverter's instructions.

28 EHE

Ehe offers three wiring options for their various models. Some models can be connected using a bus. Please note that the wires (Data + and Data-) always have to properly connected together.

28.1 EHE N1k5TL to N50kTL

Termination	Addressing	Interface
Yes	Yes	RS485

The following types are to be connected according to this diagram:

- N1K5TL, N2KTL, N3KTL, N4KTL, N5KTL, N6KTL, N10KTL, N12KTL, N15KTL, N17KTL, N20KTL, N30KTL, N50KTL

Overview

- Integrated interface.
- Where to connect: RJ45 socket (RS485(WiFi)), on the outside of the inverter.
- 2-pin wiring.
- Communication address must be allocated.
- Installation steps:
 - Switch off the inverters and Solar-Log™.
 - Connect inverters to the Solar-Log™.
 - Connect the inverters to each other.
 - Enter the communication address on the inverter's display.
Every address may only be used once.
Address range 1 to 247.



Caution

Risk of damage to the unit!

The Solar-Log™ also has an RJ45 socket, which must never be connected to the RJ45 socket on the inverter.

- ▶ Only connect inverters via the RS485/422 Solar-Log™ interface(s).

Connect inverters to the Solar-Log™

The wiring is done using a

- self-made cable connection with terminal block connector.
- Where to connect: RJ45 socket (RS485(WiFi)), on the outside of the inverter.

Procedure

1. If you are making the cable yourself, connect the wires as shown in the following diagram:

Solar-Log™ terminal strip connector	Solar-Log Base RS485 (A) / (B)	Terminal strip inside the inverter
Terminal		PIN
▶ 1 (Data+)	▶ (A) 6 or (B) 10 (Data+)	▶ Pin 4 - 485+ (A)
▶ 4 (Data-)	▶ (A) 9 or (B) 13 (Data-)	▶ Pin 5 - 485- (B)

2. If only one inverter is to be connected, according to the manufacturer's handbook it must be terminated.
3. Insert the terminal block connector into the Solar-Log™ RS485 socket.

Connect the inverters to each other

- Connect with a shielded twisted-pair cable.
- Where to connect: RJ45 socket (RS485(WiFi)), on the outside of the inverter.

Procedure

1. If you make the cable yourself, connect the wires as shown in the diagram:

Terminal strip inside the second inverter	Terminal strip inside the second inverter
PIN	PIN
▶ Pin 4 - 485+ (A)	▶ Pin 4 - 485+ (A)
▶ Pin 5 - 485- (B)	▶ Pin 5 - 485- (B)

2. Wire the remaining inverters to each other according to the manufacturer's specifications.
3. Terminate the last inverter according to the inverter instructions.
4. Insert the terminal block connector into the Solar-Log™ RS485 socket.

The RS485 sockets are each double connections so that the wiring can also be continued to the next inverter.

Procedure

1. Connect the data cable to the free blocks A, B and G on inverter 1.
2. Connect the other end of the cable to the blocks A, B and G on inverter 2.
3. Connect the remaining inverters in the same way.
4. Terminate the last inverter according to the manufacturer's instructions.
5. Close the inverter if no other inverters are to be connected.
6. Insert the terminal block connector into the Solar-Log™ RS485 socket.

Notes on inverter addresses

- Recommendation: Continuous numbering starting with 1.
- Settings: On the inverter operating display.
- Procedure: Follow the manufacturer's documentation for the inverter.



Note

A maximum of 16 inverters can be connected per RS485 bus.

28.2 EHE N10k to N100k

Termination	Addressing	Interface
Yes	Yes	RS485

The following types are to be connected according to this diagram:

- N10K, N20K, N30K, N50K, N100K

Overview

- Integrated interface.
- Where to connect: Terminal strip inside the inverter.
- 2-pin wiring.
- Communication address must be allocated.
- Installation steps:
 - Switch off the inverters and Solar-Log™.
 - Connect inverters to the Solar-Log™.
 - Connect the inverters to each other.
 - Enter the communication address on the inverter's display.
Every address may only be used once.
Address range 1 to 247.

Connect inverters to the Solar-Log™

The wiring is done using a

- self-made cable connection with terminal block connector.
- Where to connect: Terminal strip inside the inverter.

Procedure

1. If you are making the cable yourself, connect the wires as shown in the following diagram:

Solar-Log™ terminal strip connector	Solar-Log Base RS485 (A) / (B)	Terminal strip inside the inverter
Terminal		Terminal
▶ 1 (Data+)	▶ (A) 6 or (B) 10 (Data+)	▶ JX2 - A
▶ 4 (Data-)	▶ (A) 9 or (B) 13 (Data-)	▶ JX2 - B

2. If no further inverter is connected, terminate the inverter according to the instructions for the inverter.
3. Insert the terminal block connector into the Solar-Log™ RS485 socket.

Connect the inverters to each other

- Connect with a shielded twisted-pair cable.
- Where to connect: Terminal strip inside the inverter

Procedure

1. If you make the cable yourself, connect the wires as shown in the diagram:

Terminal strip inside the first inverter	Terminal strip inside the second inverter
Terminal	Terminal
▶ JX2 - A	▶ JX2 - A
▶ JX2 - B	▶ JX2 - B

2. Wiring the remaining inverters in the same way.
3. Terminate the last inverter according to the inverter instructions.
4. Insert the terminal block connector into the Solar-Log™ RS485 socket.

Procedure

1. Connect the data cable to the blocks JX2 A and B on inverter 1.
2. Connect the data cable to the blocks JX2 A and B on inverter 2.
3. Connect the remaining inverters in the same way.
4. Terminate the last inverter according to the manufacturer's instructions.
5. Close the inverter if no other inverters are to be connected.
6. Insert the terminal block connector into the Solar-Log™ RS485 socket.

Notes on inverter addresses

- Recommendation: Continuous numbering starting with 1.
- Settings: On the inverter operating display.
- Procedure: Follow the manufacturer's documentation for the inverter.



Note

A maximum of 16 inverters can be connected per RS485 bus.

28.3 EHE N250k to N500k-TL

Termination	Addressing	Interface
Yes	Yes	RS485

The following types are to be connected according to this diagram:

- N250K, N250K-TL, N500K-TL

Overview

- Integrated interface.
- Where to connect: Terminal strip inside the inverter.
- 2-pin wiring.
- Communication address must be allocated.
- Installation steps:
 - Switch off the inverters and Solar-Log™.
 - Connect inverters to the Solar-Log™.
 - Connect the inverters to each other.
 - Enter the communication address on the inverter's display.
Every address may only be used once.
Address range 1 to 247.

Connect inverters to the Solar-Log™

The wiring is done using a

- self-made cable connection with terminal block connector.
- Where to connect: Terminal strip inside the inverter.

Procedure

1. If you are making the cable yourself, connect the wires as shown in the following diagram:

Solar-Log™ terminal strip connector Solar-Log Base RS485 (A) / (B) Terminal strip inside the inverter

Terminal		Terminal
▶ 1 (Data+)	▶ (A) 6 or (B) 10 (Data+)	▶ JX9 - A
▶ 4 (Data-)	▶ (A) 9 or (B) 13 (Data-)	▶ JX9 - B

2. If no further inverter is connected, terminate the inverter according to the instructions for the inverter.
3. Insert the terminal block connector into the Solar-Log™ RS485 socket.

Connect the inverters to each other

- Connect with a shielded twisted-pair cable.
- Where to connect: Terminal strip inside the inverter.

Procedure

1. If you make the cable yourself, connect the wires as shown in the diagram:

Terminal strip inside the first inverter	Terminal strip inside the second inverter
Terminal	Terminal
▶ JX9 - A	▶ JX9 - A
▶ JX9 - B	▶ JX9 - B

2. Wiring the remaining inverters in the same way.
3. Terminate the last inverter according to the inverter instructions.
4. Insert the terminal block connector into the Solar-Log™ RS485 socket.

Procedure

1. Connect the data cable to the blocks JX2 A and B on inverter 1.
2. Connect the data cable to the blocks JX2 A and B on inverter 2.
3. Connect the remaining inverters in the same way.
4. Terminate the last inverter according to the manufacturer's instructions.
5. Close the inverter if no other inverters are to be connected.
6. Insert the terminal block connector into the Solar-Log™ RS485 socket.

Notes on inverter addresses

- Recommendation: Continuous numbering starting with 1.
- Settings: On the inverter operating display.
- Procedure: Follow the manufacturer's documentation for the inverter.



Note

A maximum of 16 inverters can be connected per RS485 bus.

29 EKO Energy

29.1 EKO Energy

Termination	Addressing	Interface
Yes	Yes	RS485

Overview

- Integrated interface.
- Where to connect: Between the COM round sockets on the outside of the inverter.
- 2-pin wiring.
- Communication address must be allocated.
- Installation steps:
 - Switch off the inverters and Solar-Log™.
 - Connect inverters to the Solar-Log™.
 - Connect the inverters to each other.
 - Allocate communication address.

Connect inverters to the Solar-Log™

The wiring is done using a

- ready-made data cable (supplied with the inverter).
- or
- self-made, shielded 2 wire data cable with round plug and terminal block connector.

Procedure

1. If you are making the cable yourself, connect the wires as shown in the following diagram:

Solar-Log™ terminal strip connector	Solar-Log Base RS485 (A) / (B)	Inverter round socket
Terminal		Terminal
▶ 1 (Data+)	▶ (A) 6 or (B) 10 (Data+)	▶ 1
▶ 4 (Data-)	▶ (A) 9 or (B) 13 (Data-)	▶ 2

2. Insert the round plug into any COM round socket on the inverter.
3. If no further inverter is connected, terminate the inverter according to the instructions for the inverter.
4. Insert the terminal block connector into the Solar-Log™ RS485 socket.

Connect the inverters to each other

- Connect using a self-made daisy chain cable.
- Where to connect: Between the COM round sockets on the outside of the inverter.

Procedure

1. Insert the round plug into any round socket on inverter 1.
2. Insert the other end of the cable into any round socket on inverter 2.
3. Connect the other inverters to each other in the same way.
4. Terminate the last inverter according to the inverter instructions.

Allocate communication address

- Recommendation: Continuous numbering starting with 1.
- Default settings on the inverter: Communication address 1.
- Setting: Using the inverter operating display.
- Procedure: Start according to the inverter's instructions.

30 Eltek

30.1 Eltek

Termination	Addressing	Interface
Yes	Yes	RS485

Select „Eltek: Theia HE-t/HE-t UL“ during the inverter detection

Overview

- Integrated interface.
- Where to connect: Terminal strip inside the inverter.
- 2-pin wiring.
- Communication address must be allocated.
- Installation steps:
 - Switch off the inverters and Solar-Log™.
 - Connect inverters to the Solar-Log™.
 - Connect the inverters to each other.
 - Configure the inverter's communication interface.
 - Allocate communication address.

Connect inverters to the Solar-Log™

The wiring is done using a

- self-made, shielded 2 wire data cable and terminal block connector.

Procedure

1. Connect wires as shown in the diagram below:

Solar-Log™ terminal strip connector Solar-Log Base RS485 (A) / (B) Inverter terminal strip

Terminal		Terminal
▶ 1 (Data+)	▶ (A) 6 or (B) 10 (Data+)	▶ B (Data+)
▶ 4 (Data-)	▶ (A) 9 or (B) 13 (Data-)	▶ A (Data-)

2. If no further inverter is connected, terminate the inverter according to the instructions for the inverter.
3. Close the inverter cover if no other inverters are to be connected.
4. Insert the terminal block connector into the Solar-Log™ RS485 socket.

Connect the inverters to each other

The inverters are connected together using the RS485 interface. Refer to the manufacturer's inverter manual for the details on how to setup the connection.

Allocate communication address

- Recommendation: Continuous numbering starting with 1.
- Setting: Using the inverter operating display.
- Procedure: Start according to the inverter's instructions.

Other configurations

- Activate the RS485 interface Using the inverter operating display.



Note

Pay particular attention to the instructions in the installation manual regarding the address types, activating the communication interface and the master/slave mode.

30.2 Eltek central inverter

Termination	Addressing	Interface
DIP switch	Yes	RS485

Select "Eltek: Theia Central TL/TX" during the inverter detection.

Overview

- Integrated interface.
- Where to connect: Terminal strip inside the inverter.
- 3-pin wiring.
- The communication address has to be assigned (1 - 247).
- Installation steps:
 - Switch off the inverters and Solar-Log™.
 - Connect inverters to the Solar-Log™.
 - Connect the inverters to each other.
 - Configure the inverter's communication interface.
 - Allocate communication address.

Connect inverters to the Solar-Log™

The wiring is done using a

- self-made, shielded 3 wire data cable and terminal block connector.

Procedure

1. Connect wires as shown in the diagram below:

Solar-Log™ terminal strip connector	Solar-Log Base RS485 (A) / (B)	Inverter terminal strip
Terminal		Terminal
▶ 1 (Data+)	▶ (A) 6 or (B) 10 (Data+)	▶ X12.1 A (Data +)
▶ 3 GND	▶ (A) 8 or (B) 12 GND	▶ X12.3 GND
▶ 4 (Data-)	▶ (A) 9 or (B) 13 (Data-)	▶ X12.2 B (Data -)

2. If no further inverter is connected, terminate the inverter according to the instructions for the inverter.
3. Close the inverter cover if no other inverters are to be connected.
4. Insert the terminal block connector into the Solar-Log™ RS485 socket.

Connect the inverters to each other

The inverters are connected together using the RS485 interface. Refer to the manufacturer's inverter manual for the details on how to setup the connection.

Allocate communication address

- Recommendation: Continuous numbering starting with 1 going to 247.
- Setting: Using the inverter operating display.
- Procedure: Start according to the inverter's instructions.

Other configurations

- Activate the RS485 interface Using the inverter operating display.



Note

Address settings: from inverter menu: Settings ► Modbus ► Modbus Address
Please refer to the inverter instructions



Note

Please check the default values of the inverter. The inverter has to communicate with the following settings: Baud rate 9600, Data bits: 8, Parity: none and Stop bits: 2.

31 Enfinity

31.1 Enfinity

Termination	Addressing	Interface
-	Yes	RS422

Overview

- Integrated interface.
- 2 RJ11 sockets inside the inverter.
- 4-pin wiring - only on RS485/422 B or C connection of the Solar-Log™.
- Communication address does not have to be assigned.
- Installation steps:
 - Switch off the inverters and Solar-Log™.
 - Connect inverters to the Solar-Log™.
 - Connect the inverters to each other.



Note

Only connect inverter using the RS485/422 B or C interface.

Connect inverters to the Solar-Log™.

The wiring is done using a

- self-made, shielded 4 wire data cable and terminal block connector.
- Where to connect: RJ11 socket on the inverter.

Procedure

Open the inverter as shown in the inverter's instructions.

1. If you are making the cable yourself, connect the wires as shown in the following diagram:

Solar-Log™ terminal strip connector	Solar-Log Base RS422	Inverter terminal strip
Terminal		Terminal
▶ 1 (T/RX+)	▶ 6 (T/RX+)	▶ Pin 3 - RX+
▶ 4 (T/RX-)	▶ 9 (T/RX-)	▶ Pin 4- RX-
▶ 5 (R/TX+)	▶ 10 (R/TX+)	▶ Pin 1 - TX+
▶ 6 (R/TX-)	▶ 13 (R/TX-)	▶ Pin 2 TX-

2. Insert the RJ11 plug into any RJ11 socket on inverter 1.
3. Close the inverter if no other inverters are to be connected.
4. Insert the terminal block connector into the Solar-Log™ RS485/422 B or C socket.

Connect the inverters to each other

- Wiring using the RJ11 cable.
- Where to connect: RJ11 sockets.

Procedure

1. Open the inverter as shown in the inverter's instructions.
2. Insert the self-made cable with the RJ11 plug into any RJ11 socket on inverter 1. Connect the other end to the terminal plug on the Solar-Log™.
3. Insert the RJ11 cable into the second RJ11 socket on the first inverter and into any RJ11 socket on the second inverter.
4. Connect the other inverters to each other in the same way.
5. Insert the terminal block connector into the Solar-Log™ RS485/422 B or C socket.
6. Close inverters.

32 Europa-Solar AG

32.1 Europa-Solar AG

Termination	Addressing	Interface
Yes	No	RS422

Overview

- Integrated interface.
- Where to connect: RJ45 socket inside the inverter.
- 4-pin cable – only on RS485/422 B or C connection of the Solar-Log™.
- Communication address does not have to be assigned.



Note

The order in which the inverters are displayed in the Solar-Log™ after detection is random. We strongly recommend that you change the order of the inverters immediately after detection at startup, in the [Configuration | Devices | Configuration | Order](#) dialog box.

- ▶ The inverters can be identified using the displayed serial number.

- Installation steps:
 - Switch off the inverters and Solar-Log™.
 - Connect inverters to the Solar-Log™.
 - Connect the inverters to each other.

Connect inverters to the Solar-Log™

The wiring is done using a

- ready-made BRJ1 data cable (optional extra; not supplied)

or

- self-made cable connection with RS485 data cable and terminal block connector.



Caution

Risk of damage to the unit!

The Solar-Log™ also has an RJ45 socket, which must never be connected to the RJ45 socket on the inverter.

- ▶ Only connect inverters via the RS485/422 B or C-Solar-Log™ interface.

Procedure

1. Open the inverter as shown in the inverter's instructions.
2. If you are making the cable yourself, connect the wires as shown in the following diagram:

Solar-Log™ terminal strip connector	Solar-Log Base RS422	RJ45 inverter
Terminal		PIN
▶ 1 (T/RX+)	▶ 6 (T/RX+)	▶ Pin 3
▶ 4 (T/RX-)	▶ 9 (T/RX-)	▶ Pin 6
▶ 5 (R/TX+)	▶ 10 (R/TX+)	▶ Pin 1
▶ 6 (R/TX-)	▶ 13 (R/TX-)	▶ Pin 2

3. Insert the RJ45 plug into any RJ45 socket on inverter 1.
4. If no further inverter is connected, terminate the inverter according to the instructions for the inverter.
5. Close the inverter if no other inverters are to be connected.
6. Insert the terminal block connector into the Solar-Log™ RS485/422 B or C socket.

Connect the inverters to each other

- Connect using a network cable (patch cable).
- Where to connect: RJ45 socket inside the inverter.

Procedure

1. Open the inverter as shown in the inverter's instructions.
2. Insert the RJ45 plug into any RJ45 socket on inverter 1.
3. Insert the other end of the wire into any RJ45 socket on inverter 2.
4. Connect the other inverters to each other in the same way.
5. Terminate the last inverter according to the inverter instructions.
6. Close inverters.

33 Evoco

33.1 Evoco

Termination	Addressing	Interface
Yes	Yes	RS485

Overview

- Integrated interface.
- Where to connect: Between the COM round sockets on the outside of the inverter.
- 2-pin wiring.
- Communication address must be allocated.
- Installation steps:
 - Switch off the inverters and Solar-Log™.
 - Connect inverters to the Solar-Log™.
 - Connect the inverters to each other.
 - Allocate communication address.

Connect inverters to the Solar-Log™

The wiring is done using a

- ready-made data cable (supplied with the inverter)
- or
- self-made, shielded 2 wire data cable with round plug and terminal block connector.

Procedure

1. If you are making the cable yourself, connect the wires as shown in the following diagram:

Solar-Log™ terminal strip connector	Solar-Log Base RS485 (A) / (B)	Inverter round socket
Terminal		PIN
▶ 1 (Data+)	▶ (A) 6 or (B) 10 (Data+)	▶ 1
▶ 4 (Data-)	▶ (A) 9 or (B) 13 (Data-)	▶ 2

2. Insert the round plug into any COM round socket on the inverter.
3. If no further inverter is connected, terminate the inverter according to the instructions for the inverter.
4. Insert the terminal block connector into the Solar-Log™ RS485 socket.

Connect the inverters to each other

- Connect using an Evoco daisy chain cable.
- Where to connect: Between the COM round sockets on the outside of the inverter.

Procedure

1. Insert the round plug into any round socket on inverter 1.
2. Insert the other end of the cable into any round socket on inverter 2.
3. Connect the other inverters to each other in the same way.
4. Terminate the last inverter according to the inverter instructions.

Allocate communication address

- Recommendation: Continuous numbering starting with 1.
- Default settings on the inverter: Communication address 1.
- Setting: Using the inverter operating display.
- Procedure: Start according to the inverter's instructions.

34 Fronius

34.1 Fronius with ComCard

Termination	Addressing	Interface
Connection plug Bridge 4-3 + 5-6	Yes	RS422

Select "Fronius: SolarNet" during the inverter detection.

Overview

- The Fronius ComCard RS422 interface integrated as an option; otherwise can be retrofitted using "ComCard retrofit".
- Where to connect: RJ45 socket on the outside of the inverter.
- 4 wire cabling with 6-pin terminal block connector.
- Communication address must be allocated:
 - Recommendation: Continuous numbering starting with 1.
 - Setting: Using the inverter operating display.
 - Procedure: Start according to the inverter's instructions.
- Installation steps:
 - Switch off the inverters and Solar-Log™.
 - (Install Fronius ComCard RS485 interface into the inverter).
 - Connect inverters to the Solar-Log™.
 - Connect the inverters to each other.
 - Allocate communication address.

Installing Fronius ComCard RS422 interface

Procedure

- ▶ Install the Fronius ComCard RS422 interface in the inverter in accordance with the interface card installation instructions.

Connect inverters to the Solar-Log™

The wiring is done using a

- ready-made Fronius data cable (optional extra; not supplied)
- or
- self-made data cable with RJ45 plug and 6-pin terminal block connector.



Caution

Risk of damage to the unit!

The Solar-Log™ also has an RJ45 socket, which must never be connected to the RJ45 socket on the inverter.

- ▶ Only connect inverters via the RS485/422 B or C-Solar-Log™ interface.
-

Procedure

1. If you are making the cable yourself, connect the wires as shown in the following diagram:

Solar-Log™ terminal strip connector	Solar-Log Base RS422	RJ45 inverter
Terminal		PIN
▶ 1 (T/RX+)	▶ 6 (T/RX+)	▶ 4
▶ 4 (T/RX-)	▶ 9 (T/RX-)	▶ 5
▶ 5 (R/TX+)	▶ 10 (R/TX+)	▶ 3
▶ 6 (R/TX-)	▶ 13 (R/TX-)	▶ 6

2. In the inverter insert the RJ45 plug into the IN socket.
3. If no further inverter connected, terminate the inverter:
Insert the supplied connection plug into the RJ45 OUT socket on the inverter.
The connection plug is an 8-pin dummy plug with bridged wires: Bridge wires 3 and 4 and wires 5 and 6.
4. Insert the terminal block connector into the Solar-Log™ RS485/422 B or C socket.

Connect the inverters to each other

- Connect using a network cable (patch cable).
- Where to connect: RJ45 socket on the outside of the inverter.

Procedure

1. Insert the RJ45 plug in inverter 1 into the OUT socket.
2. Insert the other end of the wire into the IN socket on inverter 2.
3. Connect the other inverters to each other in the same way.
4. Terminate the last inverter.
Insert the supplied connection plug into the RJ45 OUT socket.
5. Insert the terminal block connector into the Solar-Log™ RS485/422 B socket.
6. Close inverters.

Allocate communication address

- Recommendation: Continuous numbering starting with 1.
- Setting: Using the inverter operating display.
- Procedure: Start according to the inverter's instructions.

34.2 Fronius RL

Termination	Addressing	Interface
Jumper	No	RS485

Select "Fronius: RL" during the inverter detection.

Overview

- Integrated interface.
- Where to connect: Round socket on the inverter.
- 2-pin wiring.
- Communication address does not have to be assigned.
- Installation steps:
 - Switch off the inverters and the Solar-Log™.
 - Connect the inverters to the Solar-Log™.
 - Connect the inverters to each other.

Connect the inverters to the Solar-Log™.

- The wiring is done using a self-made cable connection with the round plug and the terminal strip plug. The round plug must be obtained from the manufacturer.

Procedure

1. If you are making the cable yourself, connect the wires as shown in the following diagram:

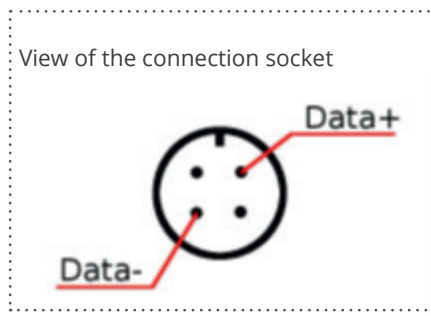

Fig.: Fronius RL round plug

Solar-Log™ terminal strip connector	Solar-Log Base RS485 (A) / (B)	Inverters
RS485/422 B		Round socket
▶ 1 (Data+)	▶ (A) 6 or (B) 10 (Data+)	▶ 1 Data +
▶ 3 GND	▶ (A) 8 or (B) 12 GND	▶ 2 use the cable shield
▶ 4 (Data-)	▶ (A) 9 or (B) 13 (Data-)	▶ 3 Data -

2. Insert the terminal block connector into the Solar-Log™ RS485 socket.

Connect the inverters to each other.

- Connect using a 2-wire, shielded data cable.
- Where to connect: Round socket on the inverter.

Procedure

1. self-made cable connection with round plug and a terminal block plug.
2. Also connect the cable to the next inverter in round plug 1.
3. Connect the other inverters to each other in the same way.

34.3 Fronius Symo/Galvo/ECO Series

For the Symo/Galvo/ECO series, Fronius offers two different inverter types:

- Symo, Galvo and ECO, as well as the light version of the series.

The instructions for wiring the inverters to the Solar-Log™ are identical to those for Fronius inverters with Com-Card. Refer to the section on „Fronius with ComCard“ for more information.

General information on the Symo / Galvo series

The standard Symo comes equipped with a data manager that acts as a bus master. The data manager has to be removed to be able to communicate with the Solar-Log™. Since the Fronius Com Card is already integrated in the Symo and Galvo models, no additional Com Card is required for network interface.

The Datamanager is not integrated into the Symo Light models.



Note

The Symo / Galvo series is pre-configured for the "Solar.Net" protocol.

- ▶ Check the settings if necessary.



Note

With the introduction of Datamanager 2.0, there is the option to set the inverter detection to slave and then it does not have to be removed.



Note

When connecting a Solar-Log™ with several Fronius inverters via Ethernet, each Fronius inverters has to have its own Datamanager and its own IP address.

General information on the ECO series:

This device is equipped with the Datamanager 2.0 by default.

The Datamanager has to be set as a slave in order for communication with the Solar-Log™ to work. The ComCard connection is a fixed component of the inverter so an additional ComCard is not required. The Light version does not come with this Datamanager so no settings need to be adjusted here.

34.4 Fronius Symo / Fronius Symo Hybrid via Ethernet

Termination	Addressing	Interface
No	Yes	LAN

Select "Fronius: SunSpec Modbus/SolarAPI" during the inverter detection.

Overview

- Integrated interface.
- The inverter's IP address has to be assigned.
- Connect using network cable (patch cable) and Ethernet router or switch.
- Installation steps:
 - The inverter has to be assigned a static IP address.
 - Switch off the inverters and the Solar-Log™.
 - Connect inverters to the Solar-Log™ (RJ45).
 - Connect the inverters to each other (RJ45).

Connect the inverters to the Solar-Log™.

The wiring is done using a

- network cable (patch cable/crossover cable) and the
- Ethernet router or switch.

Connect the inverters to each other.

The inverters are connected together using the RJ45 interface and, if needed, a router or switch.

Follow the connection setup according to the inverter's instructions.

Assigning IP addresses

- A static IP address has to be assigned to the inverter via the display.
- Please select an IP address with the same class C subnet as the Solar-Log™.
For example: The Solar-Log™ has the IP address 192.168.178.49.
The inverter in this case has to have a free IP address in the same range (from 192.168.178.1 to 192.168.178.254).
- Procedure: Start according to the inverter's instructions.



Note

The "Data export via Modbus" settings in the Fronius Symo inverter have to be changed to "TCP" in order for the inverter detection to be successful.

- ▶ Follow the procedures according to the inverter manufacturer's manual.



Note

If the settings were switched to TCP, the automatically applied inverter settings should not be changes because otherwise communication with the Solar-Log™ will not work.



Note

When connecting a Solar-Log™ with several Fronius inverters via Ethernet, each Fronius inverters has to have its own Datamanager and its own IP address.

Detection via the Solar-Log™ WEB Interface

- For detection on the Solar-Log™, select the device class under the menu [Configuration | Device | Definition | Interface](#) with the plus symbol and then select Fronius as the manufacturer. Confirm your selection with OK.
- Save your selections and then start the Device Detection under [Configuration | Device | Detection](#).

Detection from the Solar-Log 1200

- When using the Solar-Log 1200, the detection can also be started from the display. Select the settings ► Start ► Initial Configuration ► Page 2 „Device“ ► Add and select the manufacturer Fronius from there. Save and start the Device Detection.



Note

With the detection via Ethernet, it is also possible (as long they are installed) to register a connected battery and a connected consumption meter.

- ▶ An inverter is detected when it is without a connected battery and a hybrid system with a connected battery.
 - ▶ If a Fronius consumption meter is connected to the hybrid system, an additional consumption meter (bi-direction meter) is detected and recorded when it is detected by the Solar-Log™ system.
-

35 Gefran

35.1 Gefran

Termination	Addressing	Interface
Switch	Yes	RS485

Overview

- Integrated interface (two independent RS485 ports) (see Figure: Gefran RS485 terminal strip and termination).
- Where to connect: Terminal strip inside the inverter.
- 2-pin wiring.
- Communication address has to be assigned.
- Installation steps:
 - Switch off the inverters and the Solar-Log™.
 - Connect inverters to the Solar-Log™.
 - Connect the inverters to each other.
 - Allocate communication address.

Connect inverters to the Solar-Log™

The wiring is done using a

- self-made, shielded 2-wire data cable.



Note

The two independent RS485 ports allow for different ways to wire the Solar-Log™ to the inverters. In addition there are different pin assignments based on whether port A or B is used.

Procedure

1. Open the inverter as shown in the inverter's instructions.
2. If you are making the cable yourself, connect the wires as shown in the following diagram:

Solar-Log™ terminal strip connector	Solar-Log Base RS485 (A) / (B)	Terminal strip inside the inverter
Terminal		Terminal strip RS485 (TB3)
▶ 1 (Data+)	▶ (A) 6 or (B) 10 (Data+)	▶ Pin 1 or 2 (Port A) or Pin 9 or 10 (Port B)
▶ 4 (Data-)	▶ (A) 9 or (B) 13 (Data-)	▶ Pin 3 or 4 (Port A) or Pin 11 or 12 (Port B)

3. If no further inverter connected, terminate the inverter:
 - Set the switch (switch S1 for port A, switch S3 for port B) in the inverter to "1" for terminal resistance.
4. Close the inverter.
5. Insert the terminal block connector into the Solar-Log™ RS485 socket.

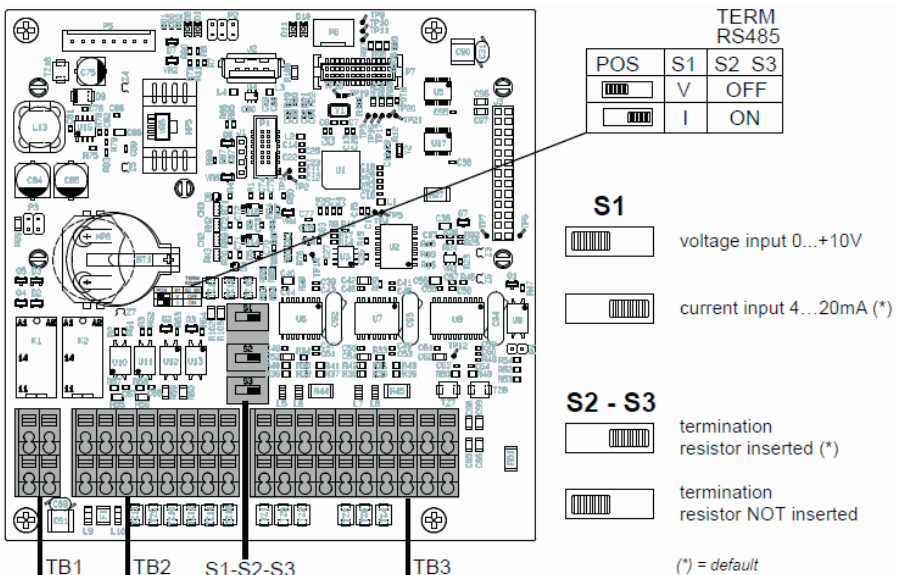

Fig.: Gefran RS485 terminal strip and termination

Connect the inverters to each other

- Where to connect: Terminal strip inside the inverter.
- 2-pin wiring.

Procedure

1. Open the inverter as shown in the inverter's instructions.
2. If you are making the cable yourself, connect the wires as shown in the following diagram:

Terminal strip inside the inverter

- Terminal RS485 (TB3)
- ▶ Pin 1 or 2 (Port A) or Pin 9 or 10 (Port B)
 - ▶ Pin 3 or 4 (Port A) or Pin 11 or 12 (Port B)

Terminal strip inside the inverter

- Terminal RS485 (TB3)
- ▶ Pin 2 or 1 (Port A) or Pin 10 or 9 (Port B)
 - ▶ Pin 4 or 3 (Port A) or Pin 12 or 11 (Port B)

3. Connect terminals on inverter 1 to the corresponding terminals on inverter 2.
4. Connect the other inverters to each other in the same way (see Figure: 2-pin terminal TB3)
5. Terminate the last inverter.
Set the switch (switch S1 for port A, switch S3 for port B) to "1" for terminal resistance.
6. Close inverters.
7. Insert the terminal block connector into the Solar-Log™ RS485 socket.

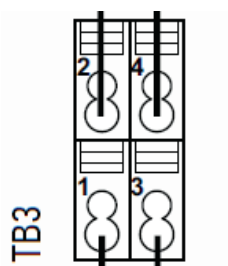

Fig.: 2-pin terminal TB3

Allocate communication address

- Recommendation: Continuous numbering starting with 1 going to 63.
- Setting: Using the inverter display.
- Procedure: Start according to the inverter's instructions.



Note

The communication port has to be configured. The settings are located in the inverter display under "Configuration -> Communication." The RS485 port used (A or B) has to be configured as follows: Baud rate: 9600bps; Settings: N81; Address: the respective bus address.

36 General Electric inverters (GE)

36.1 General Electric inverters (GE)

Termination	Addressing	Interface
No	Yes	LAN

Overview

- Integrated interface.
- Connected using network cable (patch cable) and Ethernet router or switch.
- Communication address must be allocated.
- Installation steps:
 - Allocate communication address.
 - Connect inverters to the Solar-Log™.
 - Connect the inverters to each other.

Allocate communication address

- Recommendation: Continuous numbering starting with 1.
- Setting: Using the inverter operating display.
- Procedure: Before connecting to the Ethernet router or switch and allocating the IP address.

Connect inverters and the Solar-Log™.

The wiring is done using a

- network cable (patch cable/crossover cable) and the
- Ethernet router or switch.

Procedure

1. Set different unit IDs on each inverter in accordance with the inverter's instructions.
2. Connect the Solar-Log™ and the inverter to the router or switch.
3. Allocate an IP address to each inverter using the manufacturer's IP setting kit:

The first three number blocks like the Solar-Log™, e.g. 192.168.178.49.

The fourth number block: an address that is available, e.g. 192.168.178.50.

Details on using the IP setting kit can be found in the manufacturer's SVT monitoring manual.



Note

A maximum of 32 inverters can be connected to the interface.

37 Generic Sunspec Driver

Even if the manual for a manufacturer does not explicitly have information for the recognition selection via the Sunspec protocol, it is generally still possible to implement this. „Solar-Log“ has to be selected as the manufacturer and the „Sunspec“ as the type.

The following interfaces are available: RS485 and Ethernet.

The baud rate has to be explicitly defined. The following selection options are possible:

- 2400
- 4800
- 9600
- 19200
- 57600
- 115200

The wiring depends on the manufacturer and model.

It is important to note the following on the Solar-Log™ RS485 side:

- 1 Data+
- 4 Data+
- 3 GND

Refer to Chapter 1 „Connections“ for more information.

Special inverter instructions, such as activating the Sunspec protocol, are manufacturer specific. (Refer to the manufacturer's manual).

Requirements

Compliance to the Sunspec standard is a basic prerequisite to ensure that communication via the Sunspec protocol works. This requirement is usually fulfilled when there is a Sunspec certification for each inverter module (ask the manufacturer).

- ▶ Sunspec information is available at <http://sunspec.org/download>.

In the following list contains the models required (based on the Sunspec specification) to implement data recording, and active and reactive power control with the Solar-Log™.

Support of the following Sunspec models:

- Model 1 : Common-Model-Block
 - Manufacturer
 - Serial number
- Models 101,102,103,111,112 or 113 AC values
 - Yield
 - Uac1-3 (depending on the phases)
 - Iac1-3 (depending on the phases)
 - PAC
 - Temperature
 - Status

- Error
- DC values for the missing model 160
- Model 120: General Description
 - Maximal Device Output
- Model 160 (optional): DC values for several MPP trackers
 - PDC1-6
 - IDC1-6
 - UDC1-6
- Model 123: Control parameters
 - Power reduction
 - Reactive power control



Note

„Important: In line with power reductions and reactive power control, the tabs WMaxLimPct (5), WMaxLim_Ena (9), OutPFSet(10) and OutPFSet_Ena (14) are cyclically written in the Sunspec Model 123. It could be that some of these tabs cannot be cyclically written at frequent intervals for some devices. Please contact the manufacturer of the device before using the generic Sunspec driver for power management with the Solar-Log.“

38 GESOLAR

38.1 GESOLAR

Termination	Addressing	Interface
Yes	No	RS485

Overview

- Integrated interface.
- Where to connect: RJ45 plug outside the housing floor.
- 2-pin wiring.
- Communication address does not have to be assigned.
- Installation steps:
 - Switch off the inverters and Solar-Log™.
 - Connect inverters to the Solar-Log™.
 - Connect the inverters to each other.

Connect inverters to the Solar-Log™

The wiring is done using a

- ready-made BRJ2 data cable (optional extra; not supplied)
- or
- self-made cable connection with RS485 data cable and terminal block connector.



Caution

Risk of damage to the unit!

The Solar-Log™ also has an RJ45 socket, which must never be connected to the RJ45 socket on the inverter.

- ▶ Only connect inverters via the RS485/422 Solar-Log™ interface(s).

Procedure

1. If you are making the cable yourself, connect the wires as shown in the following diagram:

Solar-Log™ terminal strip connector	Solar-Log Base RS485 (A) / (B)	RJ45 inverter
Terminal		PIN
▶ 1 (Data+)	▶ (A) 6 or (B) 10 (Data+)	▶ 7
▶ 4 (Data-)	▶ (A) 9 or (B) 13 (Data-)	▶ 8

2. Insert the RJ45 plug into the RJ45 socket on the inverter.
3. If no further inverter is connected, terminate the inverter according to the instructions for the inverter
4. Insert the terminal block connector into the Solar-Log™ RS485 socket.

Connect the inverters to each other

- Connect using a network cable (patch cable).
- Where to connect: RJ45 sockets on the outside of the inverter.

Procedure

1. Insert the RJ45 plug into any RJ45 socket on inverter 1.
2. Insert the other end of the wire into any RJ45 socket on inverter 2.
3. Connect the other inverters to each other in the same way.
4. Terminate the last inverter in accordance with the inverter instructions.

39 Ginlong

39.1 Ginlong

Termination	Addressing	Interface
Yes	Yes	RS485

Overview

- Integrated interface.
- Where to connect: Between the COM round sockets on the outside of the inverter.
- 2-pin wiring.
- Communication address must be allocated.
- Installation steps:
 - Switch off the inverters and Solar-Log™.
 - Connect inverters to the Solar-Log™.
 - Connect the inverters to each other.
 - Allocate communication address.



Note

When a device has four MPP trackers, this will be recorded as a single MPP tracker.

- ▶ With firmware version 4.1.0 or higher, four MPP trackers are recorded.

Information on the following models:

- Solis-2.5K-4G
- Solis-3K-4G
- Solis-3.6K-4G

The models mentioned are available with one or two MPP trackers.

The models with a single MPP tracker have the ST (single tracker) at the end of the model name. Since the Solar-Log™ also detects models with two MPP trackers, the MPP not being used should be deactivated.

How to deactivate the MPP tracker:

Enter the value 0 for the module field and generator power in the Module field, Output & Label section under the Configuration | Device | Configuration | Configuration menu. Then click „save.“



Note!

It is important to note that there are two different wiring types for the Ginlong model.

- ▶ Refer to the wiring table further below.

Connect inverters to the Solar-Log™

The wiring is done using a

- ready-made data cable (supplied with the inverter).
- or
- self-made, shielded 2 wire data cable with round plug and terminal block connector.

Procedure for models up to and including 15K

1. If you are making the cable yourself, connect the wires as shown in the following diagram:

Solar-Log™ terminal strip connector	Solar-Log Base RS485 (A) / (B)	Inverter COM1 (RS485)
Terminal		PIN
▶ 1 (Data+)	▶ (A) 6 or (B) 10 (Data+)	▶ 3 RS485 A
▶ 3 GND	▶ (A) 8 or (B) 12 GND	▶ 2 GND
▶ 4 (Data-)	▶ (A) 9 or (B) 13 (Data-)	▶ 4 RS485 B

2. Connect the round plug with the inverter's COM1 round socket.
3. Terminate the inverter according to the manufacturer's instructions if no additional inverters are to be connected.
4. Insert the terminal block connector into the Solar-Log™ RS485 socket.

Connect the inverters to each other

- Wiring using Ginlong's daisy chain cable.
- Connect the cables according to the inverter manufacturer's instructions.
- Terminate the last inverter according to the inverter manufacturer's instructions.

Assign the communication address

- Recommendation: Continuous numbering starting with 1.
- Default settings on the inverter: Communication address 1.
- Setting: Using the inverter operating display.
- Procedure: Start according to the inverter manufacturer's instructions.

Procedure for models 20K and larger:

1. If you are making the cable yourself, connect the wires as shown in the following diagram:

Solar-Log™ terminal strip connector	Solar-Log Base RS485 (A) / (B)	Inverter RJ45
Terminal		Pin
▶ 1 (Data+)	▶ (A) 6 or (B) 10 (Data+)	▶ 1 RS485 A
▶ 1 (Data+)	▶ (A) 6 or (B) 10 (Data+)	▶ 4 RS485 A
▶ 4 (Data-)	▶ (A) 9 or (B) 13 (Data-)	▶ 2 RS485 B
▶ 4 (Data-)	▶ (A) 9 or (B) 13 (Data-)	▶ 5 RS485 B

2. Insert the RJ45 connector into the inverter's RJ45 OUT socket.
3. Terminate the inverter according to the manufacturer's instructions if no additional inverters are to be connected.
4. Insert the terminal block connector into the Solar-Log™ RS485 socket.

Connect the inverters to each other

- Wiring using Ginlong's daisy chain cable.
- Where to connect: RJ45 socket in the inverter.

Procedure:

1. Insert the RJ45 connector into the first inverter's RJ45 OUT socket.
2. Insert the other end of the cable into the RJ45 IN socket on second inverter.
3. Connect the other inverters to each other in the same way.
4. Terminate the last inverter according to the inverter manufacturer's instructions.

Assign the communication address

- Recommendation: Continuous numbering starting with 1.
- Default settings on the inverter: Communication address 1.
- Setting: Using the inverter's operating display.
- Procedure: Start according to the inverter manufacturer's instructions.

40 GMDE

40.1 GMDE

Termination	Addressing	Interface
Yes	No	RS485

Overview

- Integrated RS485 interface.
- 2-pin cable for the RS485 connection of the Solar-Log™.
- Communication address does not have to be assigned.
- Installation steps:
 - Switch off the inverters and Solar-Log™.
 - Connect inverters to the Solar-Log™.
 - Connect the inverters to each other.

Connect inverters to the Solar-Log™

The wiring is done using a

- partially ready-made RJ45 cable (not included)
- or
- self-made data cable with RJ45 plug and 6-pin terminal block connector.



Caution

Risk of damage to the unit!

The Solar-Log™ also has an RJ45 socket, which must never be connected to the RJ45 socket on the inverter.

- ▶ Only connect inverters via the RS485/422 Solar-Log™ interface(s).

Procedure

1. Connect wires as shown in the diagram:

Solar-Log™ terminal strip connector	Solar-Log Base RS485 (A) / (B)	RJ45 inverter
Terminal		PIN
▶ 1 (Data+)	▶ (A) 6 or (B) 10 (Data+)	▶ 3 A
▶ 4 (Data-)	▶ (A) 9 or (B) 13 (Data-)	▶ 6 B

2. Run the wire from the Solar-Log™ to inverter 1 through the hole for the wire on the bottom of the unit.
3. In the inverter insert the RJ45 plug into the "RS-485 out" socket.
4. Insert the terminal block connector into the Solar-Log™ RS485 socket.

Connect the inverters to each other

- Connect using a network cable (patch cable).
- Where to connect: RJ45 socket on the outside of the inverter.

Procedure

1. Insert the RJ45 plug in inverter 1 into the RJ45 socket.
2. Insert the other end of the wire into the other RJ45 socket on inverter 2.
3. Connect the other inverters to each other in the same way.
4. Insert the terminal block connector into the Solar-Log™ RS485 socket.
5. Terminate the last inverter according to the inverter instructions.

41 GoodWe

41.1 GoodWe (RS422)

Termination	Addressing	Interface
Yes	No	RS422

Selections available under GoodWe: RS422.

Overview

- Integrated RS422 interface.
- 6-pin cable – only on RS485/422 B or C connection of the Solar-Log™.
- Communication address does not have to be assigned.
- Installation steps:
 - Switch off the inverters and Solar-Log™.
 - Connect inverters to the Solar-Log™.
 - Connect the inverters to each other.

Connect inverters to the Solar-Log™

The wiring is done using a

- partially ready-made RJ45 cable (not included)
- or
- self-made data cable with RJ45 plug and 6-pin terminal block connector.



Caution

Risk of damage to the unit!

The Solar-Log™ also has an RJ45 socket, which must never be connected to the RJ45 socket on the inverter.

- ▶ Only connect inverters via the RS485/422 Solar-Log™ interface(s).

Procedure

1. Connect wires as shown in the diagram:

Solar-Log™ terminal strip connector	Solar-Log Base RS422	RJ45 inverter
Terminal		PIN
▶ 1 (T/RX+)	▶ 6 (T/RX+)	▶ 6 Data+ (RX_RS485A)
▶ 3 GND	▶ 8 GND	▶ 4 GND
▶ 3 GND	▶ 8 GND	▶ 5 GND
▶ 4 (T/RX-)	▶ 9 (T/RX-)	▶ 3 Data- (RX_RS485B)
▶ 5 (R/TX+)	▶ 10 (R/TX+)	▶ 8 Data+ (TX_RS485A)
▶ 6 (R/TX-)	▶ 13 (R/TX-)	▶ 7 Data- (TX_RS485B)

2. Run the wire from the Solar-Log™ to inverter 1 through the hole for the wire on the bottom of the unit.

3. In the inverter insert the RJ45 plug into the "RS-485 out" socket.
4. Insert the terminal block connector into the Solar-Log™ RS485/422 B or C socket.

Connect the inverters to each other

- Connect using a network cable (patch cable).
- Where to connect: RJ45 socket on the outside of the inverter.

Procedure

1. Insert the RJ45 plug in inverter 1 into the RJ45 socket.
2. Insert the other end of the wire into the other RJ45 socket on inverter 2.
3. Connect the other inverters to each other in the same way.
4. Insert the terminal block connector into the Solar-Log™ RS485/422 B or C socket.
5. Terminate the last inverter according to the inverter instructions.

41.2 GoodWe (RS485)

Termination	Addressing	Interface
Yes	No	RS485

Selections available under GoodWe: RS485

Overview

- Integrated RS485 interface.
- Wiring at the RS485 interface of the Solar-Log™.
- The communication address does not have to be assigned.
- Installation steps:
 - Switch off the inverters and the Solar-Log™.
 - Connect the inverters to the Solar-Log™.
 - Connect the inverters to each other.

Connect the inverters to the Solar-Log™ (see tables below).

The wiring is done using a

- self-made, shielded data cable and terminal block connector.

Procedure (NS/DNS series and SDT4-10KW)

1. Connect wires as shown in the diagram:

Solar-Log™ terminal strip connector	Solar-Log Base RS485 (A) / (B)	Terminal strip in the inverter
Terminal		Terminal
▶ 1 (Data+)	▶ (A) 6 or (B) 10 (Data+)	▶ 1 RS485 +
▶ 4 (Data-)	▶ (A) 9 or (B) 13 (Data-)	▶ 2 RS485 -
▶ or		
▶ 1 (Data+)	▶ (A) 6 or (B) 10 (Data+)	▶ 5 RS485 +
▶ 4 (Data-)	▶ (A) 9 or (B) 13 (Data-)	▶ 6 RS485 -

2. Pass the cable from Solar-Log™ to inverter 1 through the cable gland on the underside of the device and connect it with terminal strip plug.
3. Plug the terminal strip plug into the RS485 terminal strip of the inverter.
4. Plug the terminal strip plug into the RS485 socket of the Solar-Log™.

Connect the inverters to each other.

- Wiring via 2-pin cable with terminal strip plug.
- Where to connect: RS485 socket in the inverter.

Procedure

1. Plug terminal strip plug into RS485 socket of inverter 1.
2. Continue wiring via RS485 socket to inverter 2 (according to manufacturer's instructions).
3. Plug the other terminal strip plug into the RS485 socket of inverter 2.
4. Connect the other inverters to each other in the same way.
5. Insert the terminal block connector into the Solar-Log™ RS485 socket.
6. Terminate the last inverter according to the inverter instructions.

Procedure (DT serie / SDT 10KL&15KW)

1. Connect wires as shown in the diagram:

Solar-Log™ terminal strip connector	Solar-Log Base RS485 (A) / (B)	Terminal strip in the inverter
Terminal		Terminal
▶ 1 (Data+)	▶ (A) 6 or (B) 10 (Data+)	▶ 1 RS485 +
▶ 4 (Data-)	▶ (A) 9 or (B) 13 (Data-)	▶ 2 RS485 -

2. Pass the cable from Solar-Log™ to inverter 1 through the cable gland on the underside of the device and connect it to the RS485-Out terminal strip.
3. Plug the terminal strip plug into the RS485 socket of the Solar-Log™.

Wechselrichter untereinander verkabeln

- Wiring via 2-pin cable with terminal strip plug.
- Where to connect:: RS485 in the inverter.

Procedure:

1. Connect inverter 1 via RS485 terminal strip according to manufacturer's instructions.
2. Connect inverter 2 via RS485 terminal strip from inverter 1 according to manufacturer's instructions.
3. Connect the other inverters to each other in the same way.
4. Insert the terminal block connector into the Solar-Log™ RS485 socket.
5. Terminate the last inverter according to the inverter instructions.

Procedure (MT serie)

1. Connect wires as shown in the diagram:

Solar-Log™ terminal strip connector	Solar-Log Base RS485 (A) / (B)	Terminal strip in the inverter
Terminal		Terminal
▶ 1 (Data+)	▶ (A) 6 or (B) 10 (Data+)	▶ 1 485_TX+
▶ 3 GND	▶ (A) 8 or (B) 12 GND	▶ 3 PE (Earth)
▶ 4 (Data-)	▶ (A) 9 or (B) 13 (Data-)	▶ 2 485_TX-
▶ or		
▶ 1 Data+	▶ (A) 6 or (B) 10 (Data+)	▶ 5 485_TX+
▶ 3 GND	▶ (A) 8 or (B) 12 GND	▶ 4 PE (Earth)
▶ 4 (Data-)	▶ (A) 9 or (B) 13 (Data-)	▶ 6 485_TX-

2. Pass the cable from Solar-Log™ to inverter 1 through the cable gland on the underside of the device and connect it with terminal strip plug.
3. Plug the terminal strip plug into the RS485 terminal strip of the inverter.
4. Plug the terminal strip plug into the RS485 socket of the Solar-Log™.

Connect the inverters to each other.

- Wiring via 3-pin cable with terminal strip plug.
- Where to connect: RS485 socket in the inverter.

Procedure:

1. Plug terminal strip plug into RS485 socket of inverter 1.
2. Continue wiring via RS485 socket to inverter 2 (according to manufacturer's instructions).
3. Plug the other terminal strip plug into the RS485 socket of inverter 2.
4. Connect the other inverters to each other in the same way.
5. Insert the terminal block connector into the Solar-Log™ RS485 socket.
6. Terminate the last inverter according to the inverter instructions.

42 Growatt

42.1 Growatt

Termination	Addressing	Interface
-	Yes	RS485



Note!

Growatt has two different wiring systems in their program. The differences are in the pin wiring. The old inverters have a round plug and 2-pin wiring, and new inverters have 3-pin wiring and a terminal block connector in the inverter.

3-pin wiring

Overview

- Integrated interface.
- Where to connect: inside the inverter.
- 3-pin wiring.
- The communication address has to be assigned.
- Installation steps:
 - Switch off the inverters and the Solar-Log™.
 - Connect the inverters to the Solar-Log™.
 - Connect the inverters to each other.
 - Assign the communication address.

Connect the inverters to the Solar-Log™

The wiring is done

- using a self-made shielded 3-wire data cable with a terminal block connector.

Procedure

1. If you are making the cable yourself, connect the wires as shown in the following diagram:

Solar-Log™ terminal strip connector	Solar-Log Base RS485 (A) / (B)	Inverter terminal strip
Terminal		Pin
▶ 1 (Data+)	▶ (A) 6 or (B) 10 (Data+)	▶ 3 (+)
▶ 4 (Data-)	▶ (A) 9 or (B) 13 (Data-)	▶ 1 (-)

2. Connect the cable's shielding with pin 2 of the inverter
3. Insert the terminal block connector into the inverter's RS485 socket.
4. Insert the terminal block connector into the Solar-Log™ RS485 socket.



Note!

The shielding on the inverter side has to be applied according to the manufacturer's connection diagram.

Explanation:

- ▶ Connecting the shielding to the ground prevents interference of any kind. However, the shielding may only be connected to the ground on one side of the data bus!

Connect the inverters together

- Wiring using a 3-pin cable with a terminal block connector.
- Where to connect: RR485 socket in the inverter.

Procedure:

1. Insert the terminal block connector into the first inverter's RS485 socket.
2. Insert the other terminal block connector into the second inverter's RS485 socket
3. Connect the other inverters to each other in the same way.
4. Insert the terminal block connector into the Solar-Log™ RS485 socket

Assign the communication address

- Recommendation: Continuous numbering starting with 1.
- Address range: 1 - 125.
- Setting: Using the inverter's operating display.
- Procedure: Start according to the inverter's instructions.

2-pin wiring

Overview

- Integrated interface
- Where to connect: Round sockets on the outside of the inverter
- 2-pin wiring
- Communication address must be allocated
- Installation steps
 - Switch off the inverters and Solar-Log™
 - Connect inverters to the Solar-Log™
 - Connect the inverters to each other
 - Allocate communication address

Connect inverters to the Solar-Log™

The wiring is done using a

- self-made, shielded 2 wire data cable with round plug and terminal block connector.
- The round plugs required can be obtained from the inverter manufacturer.

Procedure

1. If you are making the cable yourself, connect the wires as shown in the following diagram:

Solar-Log™ terminal strip connector	Solar-Log Base RS485 (A) / (B)	Inverter round socket
Terminal		PIN
▶ 1 (Data+)	▶ (A) 6 or (B) 10 (Data+)	▶ 2 (+)
▶ 4 (Data-)	▶ (A) 9 or (B) 13 (Data-)	▶ 1 (-)

2. Insert the round plug into any COM round socket on the inverter.
3. Insert the terminal block connector into the Solar-Log™ RS485 socket.

Connect the inverters to each other

- Wiring using 2 pin cable with round plugs.
- Where to connect: Round sockets on the outside of the inverter.

Procedure

1. Insert the round plug into any round socket on inverter 1.
2. Insert the other end of the cable into any round socket on inverter 2.
3. Connect the other inverters to each other in the same way.
4. Insert the terminal block connector into the Solar-Log™ RS485 socket.

Allocate communication address

- Recommendation: Continuous numbering starting with 1.
- Address range: 1 - 125
- Setting: Using the inverter operating display
- Procedure: Start according to the inverter's instructions



Note

When detecting inverters, there are two options for for Growatt in the initial configuration. "Growatt old" and "Growatt Mod". For newer models and modules with the latest firmware version version, please select "Growatt Mod", for models with older firmware versions select "Growatt old".

Inverters	Firmware version
Sungold 1500TL/2000TL/3000TL/5000TL	>= G.2.1 Modbus
Growatt 1500TL/2000TL/3000TL/4000TL/4400TL/5000TL	>= G.2.1 Modbus
Growatt 2500MTL/3000MTL	Modbus
Growatt 3600MTL/4200MTL/5000MTL	>= S.2.1 Modbus
Growatt 3600MTL-10/4200MTL-10/5000MTL-10	Modbus
Growatt 2000HF/2500HF/3000HF	Modbus
Growatt 10000UE/12000UE/18000UE/20000UE	Modbus
Growatt 4000UE/5000UE/6000UE	Modbus
Growatt 1500TL-US/2000TL-US/3000TL-US	>= U.1.5 Modbus
Growatt 3600MTL-US/4200MTL-US/5000MTL-US	>= U.1.5 Modbus
Growatt 2000HF-US/2500HF-US/3000HF-US	Modbus
Growatt 8000TL-US/9000TL-US/10000TL-US/11000TL-US	Modbus
Growatt 10000TL3-US/12000TL3-US/18000TL3-US/20000TL3-US	Modbus

43 GTec

43.1 GTec

Termination	Addressing	Interface
Yes	No	RS422

Overview

- Interface not integrated; Retrofit RS485 interface card.
- Multi-string technology
- 5-pin wiring - only on RS485/422 B or C connection of the Solar-Log™
- Communication address does not have to be assigned



Note:

The order in which the inverters are displayed in the Solar-Log™ after detection is random. We strongly recommend that you change the order of the inverters immediately after detection at startup, in the [Configuration | Devices | Configuration | Order](#) dialog box.

► The inverters can be identified using the displayed serial number.

- Installation steps
 - Switch off the inverters and Solar-Log™
 - Connect inverters to the Solar-Log™
 - Connect the inverters to each other

Installing the RS485 interface Procedure

Insert the RS485 interface in the bottom of the inverter according to the interface card installation instructions.



Note

Only connect inverter using the RS485/422 B or C interface.

Connect inverters to the Solar-Log™

The wiring is done using a

- ready-made data cable (optional extra; not supplied)
- self-made, shielded 4 wire data cable and terminal block connector.

Procedure

1. Open the inverter as shown in the inverter's instructions.
2. Pull the free wires through the wire opening in the inverter.
3. If you are making the cable yourself, connect the wires as shown in the following diagram:

Solar-Log™ terminal strip connector	Solar-Log Base RS422	RJ45 inverter
Terminal		PIN
▶ 1 (T/RX+)	▶ 6 (T/RX+)	▶ Rx +
▶ 3 GND	▶ 8 GND	▶ GND
▶ 4 (T/RX-)	▶ 9 (T/RX-)	▶ Rx-
▶ 5 (R/TX+)	▶ 10 (R/TX+)	▶ Tx+
▶ 6 (R/TX-)	▶ 13 (R/TX-)	▶ Tx-

4. If no further inverter is connected, terminate the inverter according to the instructions for the inverter.
5. Close the inverter if no other inverters are to be connected.
6. Insert the terminal block connector into the Solar-Log™ RS485/422 B or C socket.

Connect the inverters to each other

- Connect using a 4 wire, shielded data cable
- Where to connect: Terminal strip inside the inverter (on the retrofitted RS485 interface).

Procedure

- Open the inverter as shown in the inverter's instructions.
- Position the inverter up according to the diagram.
- Connect terminals R+, R-, T+ and T- of inverter 1 to the corresponding terminals on inverter 2.
- Connect the other inverters to each other in the same way.
- Terminate the last inverter according to the inverter instructions.
- Close inverters.



Note

A maximum of 32 inverters can be connected per RS422 bus.

44 Helios Systems

44.1 Helios Systems HSI

Termination	Addressing	Interface
Yes	Yes	RS485

String Inverter HSI 20

Overview

- Integrated interface
- Where to connect: RJ45 socket on the outside of the inverter
- 3-pin wiring
- Communication address must be allocated.
 - Installation steps
 - Allocate communication address
 - Switch off the inverters and Solar-Log™
 - Connect inverters to the Solar-Log™
 - Connect the inverters to each other

Connect inverters to the Solar-Log™

The wiring is done using a

- self-made cable connection with RS485 data cable and terminal block connector.

Procedure

1. Open the inverter as shown in the inverter's instructions.
2. Insert the RJ45 plug into any RJ45 socket on the first inverter.
3. If you are making the cable yourself, connect the wires as shown in the following diagram

Solar-Log™ terminal strip connector	Solar-Log Base RS485 (A) / (B)	RJ45 inverter
Terminal		PIN
▶ 1 (Data+)	▶ (A) 6 or (B) 10 (Data+)	▶ 4
▶ 3 GND	▶ (A) 8 or (B) 12 GND	▶ 3
▶ 4 (Data-)	▶ (A) 9 or (B) 13 (Data-)	▶ 5

4. If no further inverter connected, terminate the inverter.
5. Close the inverter if no other inverters are to be connected.
6. Insert the terminal block connector into the Solar-Log™ RS485 socket.



Caution

Risk of damage to the unit!

The Solar-Log™ also has an RJ45 socket, which must never be connected to the RJ45 socket on the inverter.

- ▶ Only connect inverters via the RS485/422 Solar-Log™ interface(s).

Connect the inverters to each other

- Connect using a network cable (patch cable)
- Where to connect: 2 RJ45 sockets

Procedure

1. Open the inverter as shown in the inverter's instructions.
2. Insert the RJ45 plug into any RJ45 socket on the first inverter.
3. Insert the other end of the wire into any RJ45 socket on inverter 2.
4. Connect the other inverters to each other in the same way.
5. Terminate the last inverter in accordance with the manufacturer's specifications.
6. Close the inverter if no other inverters are to be connected.
7. Insert the terminal block connector into the Solar-Log™ RS485 socket.

Central inverter

Overview

- Integrated interface
- Connected using network cable (patch cable) and Ethernet router or switch
- Communication address must be allocated.
- Installation steps
 - Allocate communication address
 - Connect inverters to the Solar-Log™
 - Connect the inverters to each other



Note

The IP addresses for the inverter must be in the same Class C network as the Solar-Log™. Alternatively, it is sufficient if the first three groups of digits in the IP addresses are the same.

Allocate communication address

- Setting: Using the inverter operating display.
Please follow the instructions in the manufacturer's manual.

Connect inverters and the Solar-Log™.

The wiring is done using a

- network cable (patch cable) and the
- Ethernet router or switch.

Procedure

1. Set different unit IPs on each inverter in accordance with the inverter's instructions.
2. Connect the Solar-Log™ and the inverter to the router or switch.

44.2 Helios Systems - Central Inverters

Termination	Addressing	Interface
No	Yes	LAN

Overview

- Integrated interface
- Connect using network cable (patch cable) and Ethernet router or switch.
- Communication address must be allocated.
- Installation steps
 - Assign the communication address.
 - Connect the inverters to the Solar-Log™.
 - Connect the inverters to each other.



Note

The IP addresses for the inverter has to be in the same Class C network as the Solar-Log™. Alternatively, it is sufficient if the first three groups of digits in the IP addresses are the same.

Assign the communication address.

- Setting: Using the inverter operating display.
Please follow the instructions in the manufacturer's manual.

Connect inverters and the Solar-Log™.

The wiring is done using a

- network cable (patch cable) and the
- Ethernet router or switch.

Procedure

1. Set different unit IPs on each inverter in accordance with the inverter's instructions.
2. Connect the Solar-Log™ and the inverter to the router or switch.

45 HiQ Solar

45.1 TrueString

Termination	Addressing	Interface
No	Yes	LAN

Supported models:

- TS208-5K75, TS480-8K (only in conjunction with TrueString Gateway)

Overview

- Integrated interface.
- Wiring the inverter (according to the manufacturer's instructions).
- Inverter addressing via TrueString Gateway (automatic).
- Connect the TrueString Gateway.
- Connect the Solar-Log™.
- Installation steps:
 - Switch off the inverters and Solar-Log™.
 - Connect the inverters to each other (according to the manufacturer's instructions).
 - Communication between inverter and TrueString Gateway (according to manufacturer's instructions).
 - Connect the TrueString Gateway to the router/switch.
 - Connect the Solar-Log™ to the router/switch.

Connect the inverters to each other

The inverters are connected together according to the inverter instructions.

Connect the Solar-Log™/ TrueString-Gateway

- Connect Solar-Log™ to router/switch.
- Connect TrueString Gateway to router/switch.
- The TrueString Gateway and the SolarLog™ must be on the same class C subnet.
Example: SolarLog™ has 192.168.178.49
In this case, the TrueString Gateway must have an IP address from the 192.168.178.xxx range (xxx represents a number between (1 - 254).

Addressing and detection of inverters

- The inverters are detected and addressed automatically via the TrueString Gateway (according to the manufacturer's instructions).

Detection via the Solar-Log™ WEB Interface

- For detection on the Solar-Log™, select the device class under the menu [Configuration | Device | Definition | Interface](#) with the plus symbol and then select „HiQ Solar“ as the manufacturer and the type. Confirm your selection with OK.
- Save your selections and then start the Device Detection under [Configuration | Device | Detection](#).

Detection from the Solar-Log 1200

- When using the Solar-Log 1200, the detection can also be started from the display. Select the settings ► Start ► Initial Configuration ► Page 2 „Device“ ► Add and select the manufacturer „HiQ Solar“ from there. Save and start the Device Detection.

46 Huawei

46.1 Huawei Sun2000 V1

Termination	Addressing	Interface
Yes	Yes	RS485

Select „Huawei: V1“ for detection.

Overview

- Integrated interface
- Where to connect:
 - RJ45 socket, inside the inverter or
 - RS485 terminal block inside the inverter (not by all models).
- 2-pin wiring
- Communication address must be allocated
- Installation steps
 - Switch off the inverters and Solar-Log™
 - Connect inverters to the Solar-Log™
 - Connect the inverters to each other



Note

When a device has four MPP trackers, this will be recorded as a single MPP tracker.

- ▶ With firmware version 4.1.0 or higher, four MPP trackers are recorded.

Connect inverters to the Solar-Log™

The wiring is done using a

- self-made cable connection with RS485 data cable and terminal block connector.

Procedure (Version RJ45 socket):

1. Open the inverter as shown in the inverter's instructions.
2. Insert the RJ45 plug into RS485-Out socket on the inverter.
3. If you are making the cable yourself, connect the wires as shown in the following diagram
4. Address the inverter according to the manufacturer's specifications.
Address range 1 to 247.
5. If no further inverter is connected, terminate the inverter according to the instructions for the inverter.
6. Close the inverter if no other inverters are to be connected.
7. Insert the terminal block connector into the Solar-Log™ RS485 socket.



Caution

Risk of damage to the unit!

The Solar-Log™ also has an RJ45 socket, which must never be connected to the RJ45 socket on the inverter.

- ▶ Only connect inverters via the RS485/422 Solar-Log™ interface(s).

Procedure (Version RS485 terminal block):

1. Open the inverter as shown in the inverter's instructions.
2. For self-assembly of the cable connection, connect the cables to the RS485 terminal block using the diagram above.
3. Connect the remaining inverters with the network cable.
4. Terminate the last inverter in accordance with the manufacturer's specifications.
5. Close the inverter if no other inverters are to be connected.
6. Insert the terminal block connector into the Solar-Log™ RS485 socket.

Connect the inverters to each other

- Connect using a network cable (patch cable).
- Where to connect: 2 RJ45 sockets.
- Wiring of the inverters according to the instructions for the inverter.

Wiring tables:

The following table is for the following models:

SUN2000-8KTL, 10KTL, 12KTL, 15KTL, 17KTL, 20KTL, 23KTL, 28KTL

Solar-Log™ terminal strip connector	Solar-Log Base RS485 (A) / (B)	RS485 terminal block (RS485-Out)
Klemme		Pin
▶ 1 (Data+)	▶ (A) 6 or (B) 10 (Data+)	▶ 1 RS485 A or 4 RS485 A
▶ 4 (Data-)	▶ (A) 9 or (B) 13 (Data-)	▶ 2 RS485 B or 5 RS485 B

Wiring tables:

The following table is for the following models:

Sun2000-33KTL, 33KTL-A, 33KTL-US, 36KTL, 36KTL-US, 40KTL, 40KTL-US, 42KTL, 45KTL-US-HV-D0, 55KTL-HV-D1/D1-001, 55KTL-IN-HV-D1 and 60KTL-HV-D1/D1-001

Solar-Log™ terminal strip connector	Solar-Log Base RS485 (A) / (B)	RS485 terminal block
Klemme		Pin
▶ 1 (Data+)	▶ (A) 6 or (B) 10 (Data+)	▶ 1 RS485 A (IN)
▶ 4 (Data-)	▶ (A) 9 or (B) 13 (Data-)	▶ 3 RS485 B (IN)

Solar-Log™ terminal strip connector	Solar-Log Base RS485 (A) / (B)	RJ45 inverter (RS485-Out)
Terminal		PIN
▶ 1 (Data+)	▶ (A) 6 or (B) 10 (Data+)	▶ 1 RS485 A or 4 RS485 A
▶ 4 (Data-)	▶ (A) 9 or (B) 13 (Data-)	▶ 2 RS485 B or 5 RS485 B

The following table is for the following models:

SUN2000-33KTL and 40KTL

Solar-Log™ terminal strip connector	Solar-Log Base RS485 (A) / (B)	RS485 terminal block
Klemme		Pin
▶ 1 (Data+)	▶ (A) 6 or (B) 10 (Data+)	▶ 6 RS485 A (Out)
▶ 4 (Data-)	▶ (A) 9 or (B) 13 (Data-)	▶ 8 RS485 B (Out)

Solar-Log™ terminal strip connector	Solar-Log Base RS485 (A) / (B)	RJ45 inverter (RS485-Out)
Terminal		PIN
▶ 1 (Data+)	▶ (A) 6 or (B) 10 (Data+)	▶ 1 RS485 A or 4 RS485 A
▶ 4 (Data-)	▶ (A) 9 or (B) 13 (Data-)	▶ 2 RS485 B or 5 RS485 B

46.2 Huawei Sun2000 V2

Termination	Addressing	Interface
Yes	Yes	RS485

Select „Huawei: V2“ for detection.

Overview

- Integrated interface
- Where to connect:
 - RJ45 socket, inside the inverter or
 - RS485 terminal block inside the inverter.
- 2-pin wiring
- Communication address must be allocated
- Installation steps
 - Switch off the inverters and Solar-Log™
 - Connect inverters to the Solar-Log™
 - Connect the inverters to each other



Note

When a device has four MPP trackers, this will be recorded as a single MPP tracker.

- ▶ With firmware version 4.1.0 or higher, four MPP trackers are recorded.

Connect inverters to the Solar-Log™

The wiring is done using a

- self-made cable connection with RS485 data cable and terminal block connector.

Procedure (Version RJ45 socket):

1. Open the inverter as shown in the inverter's instructions.
2. Insert the RJ45 plug into RS485-Out socket on the inverter.
3. If you are making the cable yourself, connect the wires as shown in the following diagram
4. Address the inverter according to the manufacturer's specifications.
Address range 1 to 247.
5. If no further inverter is connected, terminate the inverter according to the instructions for the inverter.
6. Close the inverter if no other inverters are to be connected.
7. Insert the terminal block connector into the Solar-Log™ RS485 socket.



Caution

Risk of damage to the unit!

The Solar-Log™ also has an RJ45 socket, which must never be connected to the RJ45 socket on the inverter.

- ▶ Only connect inverters via the RS485/422 Solar-Log™ interface(s).

Procedure (Version RS485 terminal block):

1. Open the inverter as shown in the inverter's instructions.
2. For self-assembly of the cable connection, connect the cables to the RS485 terminal block using the diagram above.
3. Connect the remaining inverters with the network cable.
4. Terminate the last inverter in accordance with the manufacturer's specifications.
5. Close the inverter if no other inverters are to be connected.
6. Insert the terminal block connector into the Solar-Log™ RS485 socket.

Connect the inverters to each other

- Connect using a network cable (patch cable).
- Where to connect: 2 RJ45 sockets.
- Wiring of the inverters according to the instructions for the inverter.

The following tables is for the following models:

SUN2000-50KTL-M0, 60KTL-M0, 65KTL-M0, 70KTL-C1, 75KTL-C1, 70KTL-INM0, 50KTL-JPM0, 63KTL-JPM0, 50KTL-JPM1, 100KTL-USH0, 100KTL-H1, 100KTL-H0, 90KTL-H1, 95KTL-INH0, 90KTL-H0, 63KTL-JPH0, 105KTL-H0, 100KTL-H2, 105KTL-H1, 105KTL-USH0, 90KTL-H2, 95KTL-INH1

Solar-Log™ terminal strip connector	Solar-Log Base RS485 (A) / (B)	RJ45 inverter (RS485-Out)
Terminal		PIN
▶ 1 (Data+)	▶ (A) 6 or (B) 10 (Data+)	▶ 1 RS485 A or 4 RS485 A
▶ 4 (Data-)	▶ (A) 9 or (B) 13 (Data-)	▶ 2 RS485 B or 5 RS485 B

Solar-Log™ terminal strip connector	Solar-Log Base RS485 (A) / (B)	RS485 terminal block
Klemme		Pin
▶ 1 (Data+)	▶ (A) 6 or (B) 10 (Data+)	▶ 1 RS485 A (IN)
▶ 4 (Data-)	▶ (A) 9 or (B) 13 (Data-)	▶ 3 RS485 B (IN)

47 Hyundai

47.1 Hyundai HPC-050HT-E and HPC-100HT-E

Termination	Addressing	Interface
Yes	Yes	RS485

Overview

- Integrated interface
- Where to connect: RJ45 CN socket on the outside of the inverter
- 2-pin wiring
- Communication address must be allocated
- Installation steps
 - Switch off the inverters and Solar-Log™
 - Connect inverters to the Solar-Log™
 - Connect the inverters to each other
 - Allocate communication address

Connect inverters to the Solar-Log™

The wiring is done using a

- ready-made data cable (optional extra; not supplied)

or

- self-made cable connection with RS485 data cable and terminal block connector.



Caution

Risk of damage to the unit!

The Solar-Log™ also has an RJ45 socket, which must never be connected to the RJ45 socket on the inverter.

- ▶ Only connect inverters via the RS485/422 Solar-Log™ interface(s).

Procedure

1. If you are making the cable yourself, connect the wires as shown in the following diagram:

Solar-Log™ terminal strip connector	Solar-Log Base RS485 (A) / (B)	RJ45 inverter
Terminal		PIN
▶ 1 (Data+)	▶ (A) 6 or (B) 10 (Data+)	▶ 3
▶ 4 (Data-)	▶ (A) 9 or (B) 13 (Data-)	▶ 6

2. Insert RJ45 plug into socket CN on the inverter.
3. If no further inverter is connected, terminate the inverter according to the instructions for the inverter
4. Insert the terminal block connector into the Solar-Log™ RS485 socket.

Connect the inverters to each other

- Connect using a network cable (patch cable)
- Where to connect: RJ45 sockets on the outside of the inverter.

Procedure

1. Insert the RJ45 plug into any RJ45 socket on inverter 1.
2. Insert the other end of the wire into any RJ45 socket on inverter 2.
3. Connect the other inverters to each other in the same way.
4. Terminate the last inverter in accordance with the inverter instructions.

Allocate communication address

- Recommendation: Continuous numbering starting with 1.
- Setting: Using the inverter operating display
- Procedure: Start according to the inverter's instructions

47.2 Hyundai HPC-250HT-E

Termination	Addressing	Interface
Yes	Yes	RS485

Overview

- Integrated interface
- Where to connect: 20 pin connection strip on the outside of the inverter at the top edge of the i-8142iW module
- 2-pin wiring
- Communication address must be allocated
- Installation steps
 - Switch off the inverters and Solar-Log™
 - Connect inverters to the Solar-Log™
 - Connect the inverters to each other
 - Allocate communication address

Connect inverters to the Solar-Log™

The wiring is done using a

- ready-made data cable (optional extra; not supplied)
- or
- self-made, shielded 2 wire data cable and terminal block connector.



Caution

Risk of damage to the unit!

The Solar-Log™ also has an RJ45 socket, which must never be connected to the RJ45 socket on the inverter.

- ▶ Only connect inverters via the RS485/422 Solar-Log™ interface(s).

Procedure

1. If you are making the cable yourself, connect the wires as shown in the following diagram:

Solar-Log™ terminal strip connector Solar-Log Base RS485 (A) / (B) Inverter terminal strip

Terminal		Terminal
▶ 1 (Data+)	▶ (A) 6 or (B) 10 (Data+)	▶ D1+/TxD1+
▶ 4 (Data-)	▶ (A) 9 or (B) 13 (Data-)	▶ D1-/TxD1-

2. If no further inverter is connected, terminate the inverter according to the instructions for the inverter.
3. Insert the terminal block connector into the Solar-Log™ RS485 socket.

Connect the inverters to each other

- Connect using a 2 wire, shielded data cable
- Where to connect: 20 pin connection strip on the inverter at the top edge of the i-8142iW module.

Procedure

1. Connect terminal D1+/TxD1+ on inverter 1 to terminal D1+/TxD1+ on inverter 2.
2. Connect terminal D1-/TxD1- on inverter 1 to terminal D1-/TxD1- on inverter 2.
3. Connect the other inverters to each other in the same way.
4. Terminate the last inverter in accordance with the inverter instructions.

Allocate communication address

- Recommendation: Continuous numbering starting with 1.
- Setting: Using PC software for configuring inverters.
- Procedure: Start according to the inverter's instructions.

48 Ingeteam

48.1 INGECON® SUN 1Play TL M

Termination	Addressing	Interface
Jumper P3	Yes	RS485

Supported models:

- INGECON® SUN 1Play 2.5TL M
- INGECON® SUN 1Play 3TL M
- INGECON® SUN 1Play 3.3TL M
- INGECON® SUN 1Play 3.68TL M
- INGECON® SUN 1Play 4.6TL M
- INGECON® SUN 1Play 5TL M
- INGECON® SUN 1Play 6TL M

Note:

The SUN 1Play TL M models have 1 phase and 2 MPP tracker.

Overview:

- Interface not integrated; Retrofit RS485 interface card.
- 3-pin wiring.
- Communication address must be allocated.
- Installation steps:
 - Switch off the inverters and Solar-Log™.
 - Install the RS485 interface in the inverter.
 - Connect inverters to the Solar-Log™.
 - Connect the inverters to each other.
 - Allocate communication address.

Installing the RS485 interface

Procedure

- ▶ Install the RS485 interface in the inverter in accordance with the interface card installation instructions.

Connect inverters to the Solar-Log™

The wiring is done using a

- self-made, shielded 3 wire data cable and terminal block connector.

Procedure

1. Open the inverter as shown in the inverter's instructions.
2. Pull the free wires through the wire opening in the inverter.
3. If you are making the cable yourself, connect the wires as shown in the following diagram:

Solar-Log™ terminal strip connector	Solar-Log Base RS485 (A) / (B)	Inverter terminal strip
▶ 1 (Data+)	▶ (A) 6 or (B) 10 (Data+)	▶ Pin 1 RS485 A (+)
▶ 3 GND	▶ (A) 8 or (B) 12 GND	▶ Pin 6 GND
▶ 4 (Data-)	▶ (A) 9 or (B) 13 (Data-)	▶ Pin 2 RS485 B (-)

4. If no further inverter connected, terminate the inverter:
Insert jumper JP3 into the RS485 card.
5. Close the inverter if no other inverters are to be connected.
6. Insert the terminal block connector into the Solar-Log™ RS485 socket.

Connect the inverters to each other

- Connect using a 3 wire, shielded data cable
- Where to connect: Terminal strip inside the inverter (on the retrofitted RS485 interface)

Procedure

1. Open the inverter as shown in the inverter's instructions.
2. Connect terminals "Pin 1-RS485-A (+)", "Pin 6-GND" and "Pin 2-RS485-B (-)" of inverter 1 to the corresponding terminals on inverter 2.
3. Connect the other inverters to each other in the same way.
4. Terminate the last inverter.
Insert jumper JP3 into the RS485 card.
5. Close inverters.

Allocate communication address

- Recommendation: Continuous numbering starting with 1.
- Setting: Using the inverter operating display.
- Procedure: Start according to the inverter's instructions.

48.2 INGECON® SUN 3Play TL

Termination	Addressing	Interface
Jumper	Yes	RS485

Supported models:

- INGECON® SUN 3Play 10TL
- INGECON® SUN 3Play 15TL
- INGECON® SUN 3Play 20TL
- INGECON® SUN 3Play 28TL
- INGECON® SUN 3Play 33TL

Note:

The SUN 3Play TL models have 3 phase and 1 MPP tracker.

Overview:

- Integrated interface.
- 3-pin wiring.
- Communication address must be allocated.
- Installation steps:
 - Switch off the inverters and Solar-Log™.
 - Install the RS485 interface in the inverter.
 - Connect inverters to the Solar-Log™.
 - Connect the inverters to each other.
 - Allocate communication address.

Connect inverters to the Solar-Log™

The wiring is done using a

- self-made, shielded 3 wire data cable and terminal block connector.

Procedure

1. Open the inverter as shown in the inverter’s instructions.
2. Pull the free wires through the wire opening in the inverter.
3. If you are making the cable yourself, connect the wires as shown in the following diagram:

Solar-Log™ terminal strip connector	Solar-Log Base RS485 (A) / (B)	Inverter terminal strip
Terminal		Terminal
▶ 1 (Data+)	▶ (A) 6 or (B) 10 (Data+)	▶ Pin 1 RS485 A (+)
▶ 3 GND	▶ (A) 8 or (B) 12 GND	▶ Pin 6 GND
▶ 4 (Data-)	▶ (A) 9 or (B) 13 (Data-)	▶ Pin 2 RS485 B (-)

4. If no further inverter connected, terminate the inverter:
Insert jumper into the RS485 card.
5. Close the inverter if no other inverters are to be connected.
6. Insert the terminal block connector into the Solar-Log™ RS485 socket.

Connect the inverters to each other

- Connect using a 3 wire, shielded data cable.
- Where to connect: Terminal strip inside the inverter.

Procedure

1. Open the inverter as shown in the inverter's instructions.
2. Connect terminals „Pin 1-RS485-A (+)“, „Pin 6-GND“ and „Pin 2-RS485-B (-)“ of inverter 1 to the corresponding terminals on inverter 2.
3. Connect the other inverters to each other in the same way.
4. Terminate the last inverter.
Insert jumper JP3 into the RS485 card.
5. Close inverters.

Allocate communication address

- Recommendation: Continuous numbering starting with 1.
- Setting: Using the inverter operating display.
- Procedure: Start according to the inverter's instructions.

48.3 INGECON® SUN 3Play TL M

Termination	Addressing	Interface
Jumper	Yes	RS485

Supported models:

- INGECON® SUN 3Play 10TL M
- INGECON® SUN 3Play 15TL M
- INGECON® SUN 3Play 20TL M
- INGECON® SUN 3Play 33TL M
- INGECON® SUN 3Play 40TL M480

Note:

The SUN 3Play TL M models have 3 phase and 2 MPP tracker.

Overview:

- Integrated interface.
- 3-pin wiring.
- Communication address must be allocated.
- Installation steps:
 - Switch off the inverters and Solar-Log™.
 - Connect inverters to the Solar-Log™.
 - Connect the inverters to each other.
 - Allocate communication address.

Connect inverters to the Solar-Log™

The wiring is done using a

- self-made, shielded 3 wire data cable and terminal block connector.

Procedure

1. Open the inverter as shown in the inverter's instructions.
2. Pull the free wires through the wire opening in the inverter.
3. If you are making the cable yourself, connect the wires as shown in the following diagram:

Solar-Log™ terminal strip connector Solar-Log Base RS485 (A) / (B) Inverter terminal strip

Terminal		Terminal
▶ 1 (Data+)	▶ (A) 6 or (B) 10 (Data+)	▶ Pin 1 RS485 A (+)
▶ 3 GND	▶ (A) 8 or (B) 12 GND	▶ Pin 6 GND
▶ 4 (Data-)	▶ (A) 9 or (B) 13 (Data-)	▶ Pin 2 RS485 B (-)

4. If no further inverter connected, terminate the inverter:
Insert jumper into the RS485 card.
5. Close the inverter if no other inverters are to be connected.
6. Insert the terminal block connector into the Solar-Log™ RS485 socket.

Connect the inverters to each other

- Connect using a 3 wire, shielded data cable.
- Where to connect: Terminal strip inside the inverter.

Procedure

1. Open the inverter as shown in the inverter's instructions.
2. Connect terminals „Pin 1-RS485-A (+)“, „Pin 6-GND“ and „Pin 2-RS485-B (-)“ of inverter 1 to the corresponding terminals on inverter 2.
3. Connect the other inverters to each other in the same way.
4. Terminate the last inverter.
Insert jumper into the RS485 card.
5. Close inverters.

Allocate communication address

- Recommendation: Continuous numbering starting with 1.
- Setting: Using the inverter operating display.
- Procedure: Start according to the inverter's instructions.

48.4 INGECON® SUN 3Play 40TL U M480

Termination	Addressing	Interface
Jumper	Yes	RS485

Supported models:

- INGECON® SUN 3Play 40TL U M480

Note:

The SUN 3Play 40TL U M480 model have 3 phase and 2 MPP tracker.

Overview:

- Integrated interface.
- 3-pin wiring.
- Communication address must be allocated.
- Installation steps:
 - Switch off the inverters and Solar-Log™.
 - Connect inverters to the Solar-Log™.
 - Connect the inverters to each other.
 - Allocate communication address.

Connect inverters to the Solar-Log™

The wiring is done using a

- self-made, shielded 3 wire data cable and terminal block connector.

Procedure

1. Open the inverter as shown in the inverter’s instructions.
2. Pull the free wires through the wire opening in the inverter.
3. If you are making the cable yourself, connect the wires as shown in the following diagram:

Solar-Log™ terminal strip connector	Solar-Log Base RS485 (A) / (B)	Inverter terminal strip
Terminal		Terminal
▶ 1 (Data+)	▶ (A) 6 or (B) 10 (Data+)	▶ Pin 1 RS485 A (+)
▶ 3 GND	▶ (A) 8 or (B) 12 GND	▶ Pin 6 GND
▶ 4 (Data-)	▶ (A) 9 or (B) 13 (Data-)	▶ Pin 2 RS485 B (-)

4. If no further inverter connected, terminate the inverter:
Insert jumper into the RS485 card.
5. Close the inverter if no other inverters are to be connected.
6. Insert the terminal block connector into the Solar-Log™ RS485 socket.

Connect the inverters to each other

- Connect using a 3 wire, shielded data cable.
- Where to connect: Terminal strip inside the inverter.

Procedure

1. Open the inverter as shown in the inverter's instructions.
2. Connect terminals „Pin 1-RS485-A (+)“, „Pin 6-GND“ and „Pin 2-RS485-B (-)“ of inverter 1 to the corresponding terminals on inverter 2.
3. Connect the other inverters to each other in the same way.
4. Terminate the last inverter.
Insert jumper into the RS485 card.
5. Close inverters.

Allocate communication address

- Recommendation: Continuous numbering starting with 1.
- Setting: Using the inverter operating display.
- Procedure: Start according to the inverter's instructions.

48.5 INGECON® SUN 3Play 100k

Termination	Addressing	Interface
Jumper	Yes	RS485

Supported series:

- INGECON® SUN 3Play 100k

Note:

The SUN 3Play 100k series have 3 phase and 1 MPP tracker.

Overview:

- Integrated interface.
- 3-pin wiring.
- Communication address must be allocated.
- Installation steps:
 - Switch off the inverters and Solar-Log™.
 - Connect inverters to the Solar-Log™.
 - Connect the inverters to each other.
 - Allocate communication address.

Connect inverters to the Solar-Log™

The wiring is done using a

- self-made, shielded 3 wire data cable and terminal block connector.

Procedure

1. Open the inverter as shown in the inverter’s instructions.
2. Pull the free wires through the wire opening in the inverter.
3. If you are making the cable yourself, connect the wires as shown in the following diagram:

Solar-Log™ terminal strip connector	Solar-Log Base RS485 (A) / (B)	Inverter terminal strip
Terminal		Terminal
▶ 1 (Data+)	▶ (A) 6 or (B) 10 (Data+)	▶ Pin 1 RS485 A (+)
▶ 3 GND	▶ (A) 8 or (B) 12 GND	▶ Pin 6 GND
▶ 4 (Data-)	▶ (A) 9 or (B) 13 (Data-)	▶ Pin 2 RS485 B (-)

4. If no further inverter connected, terminate the inverter:
Insert jumper into the RS485 card.
5. Close the inverter if no other inverters are to be connected.
6. Insert the terminal block connector into the Solar-Log™ RS485 socket.

Connect the inverters to each other

- Connect using a 3 wire, shielded data cable.
- Where to connect: Terminal strip inside the inverter.

Procedure

1. Open the inverter as shown in the inverter's instructions.
2. Connect terminals „Pin 1-RS485-A (+)“, „Pin 6-GND“ and „Pin 2-RS485-B (-)“ of inverter 1 to the corresponding terminals on inverter 2.
3. Connect the other inverters to each other in the same way.
4. Terminate the last inverter.
Insert jumper into the RS485 card.
5. Close inverters.

Allocate communication address

- Recommendation: Continuous numbering starting with 1.
- Setting: Using the inverter operating display.
- Procedure: Start according to the inverter's instructions.

49 INVT iMARS

49.1 INVT iMARS / MG-Serie / BG-Serie

Termination	Adressing	Interface
-	Yes	RS485

Overview

- Integrated interface
- Connection via RS485
- 3-pin wiring
- The communication address has to be assigned (is set to 1 by default)
- Installation steps
 - Switch off the inverters and Solar-Log™
 - Connect inverters to the Solar-Log™
 - Connect the inverters to each other
 - Allocate communication address

Connect inverters to the Solar-Log™

The wiring is done using a

- Self-made cable connection using the RS485 connector and the terminal block connector.

Procedure

1. If you are making the cable yourself, connect the wires as shown in the following diagram::

Solar-Log™ terminal strip connector	Solar-Log Base RS485 (A) / (B)	RS485 connector
Terminal		Pin
▶ 1 (Data+)	▶ (A) 6 or (B) 10 (Data+)	▶ 2 (RS485+)
▶ 3 GND	▶ (A) 8 or (B) 12 GND	▶ 4 GND
▶ 4 (Data-)	▶ (A) 9 or (B) 13 (Data-)	▶ 3 (RS485-)

2. RS485 connector an den Wechselrichter, gemäß Anleitung zum Wechselrichter, anschliessen
3. Klemmleistenstecker in RS485-Buchse des Solar-Log™ stecken

Connect the inverters together

- Start according to the inverter's instructions.

Assign the communication address

- Start according to the inverter's instructions.



Note Feed-in Management

Reductions of less than 10% are set to 10% with the MG series inverters.

- ▶ The BG series models can be set to 1% to 100%.
-

50 JFY

50.1 SUNTREE JFY

Termination	Addressing	Interface
Resistor	Yes	RS485

Overview

- Integrated interface
- Where to connect: RJ45 socket on the outside of the inverter
- 2-pin wiring
- Communication address must be allocated.
- Installation steps
 - Switch off the inverters and Solar-Log™
 - Connect inverters to the Solar-Log™
 - Connect the inverters to each other
 - Allocate communication address

Connect inverters to the Solar-Log™

The wiring is done using a

- self-made cable connection with RS485 data cable and terminal block connector.



Caution

Risk of damage to the unit!

The Solar-Log™ also has an RJ45 socket, which must never be connected to the RJ45 socket on the inverter.

- ▶ Only connect inverters via the RS485/422 Solar-Log™ interface(s).

Procedure

1. If you are making the cable yourself, connect the wires as shown in the following diagram:

Solar-Log™ terminal strip connector	Solar-Log Base RS485 (A) / (B)	RJ45 inverter
Terminal		PIN
▶ 1 (Data+)	▶ (A) 6 or (B) 10 (Data+)	▶ 8 +TR
▶ 4 (Data-)	▶ (A) 9 or (B) 13 (Data-)	▶ 7 -TR

2. Insert the RJ45 plug into the RJ45 socket on the inverter.
3. If no further inverter connected, terminate the inverter:
Insert the 120 Ω resistor into the free RJ45 socket.
4. Insert the terminal block connector into the Solar-Log™ RS485 socket.
5. Close the unit cover on the bottom of the inverter.

Connect the inverters to each other

- Connect using a network cable (patch cable)
- Where to connect: RJ45 sockets on the outside of the inverter.

Procedure

1. Insert the RJ45 plug into any RJ45 socket on inverter 1.
2. Insert the other end of the wire into any RJ45 socket on inverter 2.
3. Connect the other inverters to each other in the same way.
4. Terminate the last inverter.
Insert the 120 Ω resistor into the free RJ45 socket.

Allocate communication address

- Recommendation: Continuous numbering starting with 1. (1-250)
- Setting: Using the inverter operating display
- Procedure: Start according to the inverter's instructions



Note

A maximum of 31 inverters can be connected per RS485 bus.

51 Kaco

51.1 Kaco - Powador

Termination	Addressing	Interface
Yes	Yes	RS485

Overview

- Integrated interface
- Where to connect: Terminal strip inside the inverter
- 2-pin wiring
- Communication address must be allocated
- Installation steps
 - Switch off the inverters and Solar-Log™
 - Connect inverters to the Solar-Log™
 - Connect the inverters to each other
 - Allocate communication address



Note

Instructions and a diagram for wiring Kaco Powador inverters together are in the appendix.

Connect inverters to the Solar-Log™

The wiring is done using a

- partly made data cable (optional extra; not supplied)
- or
- self-made, shielded 2 wire data cable and terminal block connector.

Procedure

1. Open the inverter as shown in the inverter's instructions.
2. Pull the free wires through the wire opening in the inverter.
3. If you are making the cable yourself, connect the wires as shown in the following diagram:

Solar-Log™ terminal strip connector Solar-Log Base RS485 (A) / (B) Inverter terminal strip

Terminal		Terminal
▶ 1 (Data+)	▶ (A) 6 or (B) 10 (Data+)	▶ B
▶ 4 (Data-)	▶ (A) 9 or (B) 13 (Data-)	▶ A

4. If no further inverter connected, terminate the inverter:
Series 2 Powador: Set the DIP switch inside the inverter to ON and all other inverters to OFF.
5. Close the inverter if no other inverters are to be connected.
6. Insert the terminal block connector into the Solar-Log™ RS485 socket.

Connect the inverters to each other

- Connect using a 2 wire, shielded data cable.
- Where to connect: Terminal strip inside the inverter

The RS485 connections on the terminal strip are each double connections so that the wiring can be continued to the next inverter.

Procedure

1. Connect the data cable to the free terminals A and B of inverter 1.
2. Insert the other end of the cable into terminals A and B of inverter 2.
3. Connect the other inverters to each other in the same way.
4. Terminate the last inverter.
Series 2 Powador: Set the DIP switch inside the inverter to ON and all other inverters to OFF.
5. Close inverters.

Allocate communication address

- Recommendation: Continuous numbering starting with 1.
- Setting: Using the inverter operating display
- Procedure: Start according to the inverter's instructions



Note

The 25000xi - 33000xi Kaco inverter models are shown as 3 independent inverters in the Solar-Log™. If, for example, such inverters are available, give them addresses 1 and 2. In the Solar-Log™ the inverters will be shown internally as 1.1 / 1.2 - 2.1 / 2.2 etc.



Note

A maximum of 32 inverters can be connected per RS485 bus.

51.2 Kaco – PVI Blue Planet

Termination	Addressing	Interface
Yes	Yes	RS485

Overview

- The Solar-Log™ only works with Kaco Blue Planet inverters that have an RS485 interface. The RS232 interface is not supported.

RS232 models: RS485 interface can be retrofitted by the manufacturer.

RS485 models: Integrated interface.

- Where to connect: Terminal strip inside the inverter.
- 2-pin wiring.
- Communication address must be allocated.
- Installation steps:
 - Switch off the inverters and Solar-Log™.
 - Connect inverters to the Solar-Log™.
 - Connect the inverters to each other.
 - Allocate communication address.

Connect inverters to the Solar-Log™

The wiring is done using a

- partly fabricated data cable (optional extra; not supplied)
- or
- self-made, shielded 2 wire data cable and terminal block connector.

Procedure

1. Open the inverter as shown in the inverter's instructions.
2. Pull the free wires through the wire opening in the inverter.
3. If you are making the cable yourself, connect the wires as shown in the following diagram:

Solar-Log™ terminal strip connector Solar-Log Base RS485 (A) / (B) Inverter terminal strip

Terminal		Terminal
▶ 1 (Data+)	▶ (A) 6 or (B) 10 (Data+)	▶ B
▶ 4 (Data-)	▶ (A) 9 or (B) 13 (Data-)	▶ A

4. If no further inverter connected, terminate the inverter:
In the inverter connect the free terminal A to terminal B using the supplied 330 Ω terminating resistor.
5. Close the inverter if no other inverters are to be connected.
6. Insert the terminal block connector into the Solar-Log™ RS485 socket.

Connect the inverters to each other

- Connect using a 2 wire, shielded data cable.
- Where to connect: Terminal strip inside the inverter.

The RS485 connections on the terminal strip are each double connections so that the wiring can be continued to the next inverter.

Procedure

1. Open the inverter as shown in the inverter's instructions.
2. Connect the data cable to the free terminals A and B of inverter 1.
3. Insert the other end of the cable into terminals A and B of inverter 2.
4. Connect the other inverters to each other in the same way.
5. Terminate the last inverter.
Connect the free terminal A to terminal B using the supplied 330 Ω terminating resistor.
6. Close inverters.

Allocate communication address

- Recommendation: Continuous numbering starting with 1.
- Setting: Using the DIP switch inside the inverter.
- Procedure: Start according to the inverter's instructions



Note

A maximum of 32 inverters can be connected per RS485 bus.

52 Kehua

52.1 Kehua (Single phase)

Termination	Addressing	Interface
No	Yes	RS485

Overview

- Integrated interface.
- Where to connect:
 - Terminal strip inside the inverter.
 - Round sockets on the outside of the inverter.
- 2-pin wiring.
- Communication address must be allocated.
- Installation steps:
 - Switch off the inverters and Solar-Log™.
 - Connect inverters to the Solar-Log™.
 - Connect the inverters to each other.
 - Allocate communication address.

Connect inverters to the Solar-Log™

The wiring is done using a

- self-made, shielded 2 wire data cable with a terminal block connector.

Procedure

1. Open the inverter as shown in the inverter's instructions.
2. If you are making the cable yourself, connect the wires as shown in the following diagram

Solar-Log™ terminal strip connector	Solar-Log Base RS485 (A) / (B)	Terminal strip inside the inverter
Terminal		RS485 Terminal
▶ 1 (Data+)	▶ (A) 6 or (B) 10 (Data+)	▶ A/3
▶ 4 (Data-)	▶ (A) 9 or (B) 13 (Data-)	▶ B/4

3. Close the inverter if no other inverters are to be connected.
4. Insert the terminal block connector into the Solar-Log™ RS485 socket.

Connect the inverters to each other

- Where to connect: Terminal strip inside the inverter.
- 2-pin wiring.
- Wiring according to inverter instructions.

Alternative procedure with round socket:

Connect inverters to the Solar-Log™

The wiring is done using a

- self-made, shielded 2 wire data cable with round plug and terminal block connector.

Procedure

1. If you are making the cable yourself, connect the wires as shown in the following diagram:

Solar-Log™ terminal strip connector	Solar-Log Base RS485 (A) / (B)	Inverter round socket
Terminal		PIN
▶ 1 (Data+)	▶ (A) 6 or (B) 10 (Data+)	▶ 3
▶ 4 (Data-)	▶ (A) 9 or (B) 13 (Data-)	▶ 4

2. Insert the round plug into any COM round socket on the inverter.
3. Insert the terminal block connector into the Solar-Log™ RS485 socket.

Connect the inverters to each other

- Wiring using 2 pin cable with round plugs.
- Where to connect: Round sockets on the outside of the inverter.

Procedure

1. Insert the round plug into any round socket on inverter 1.
2. Insert the other end of the cable into any round socket on inverter 2.
3. Connect the other inverters to each other in the same way.
4. Insert the terminal block connector into the Solar-Log™ RS485 socket.

Allocate communication address

- Recommendation: Continuous numbering starting with 1.
- Address range: 1 - 247.
- Setting: According to inverter instructions.
- Procedure: Start according to the inverter's instructions.

52.2 Kehua (3-phase)

Termination	Adressing	Interface
Dip switch	Yes	RS485

Overview

- Integrated interface.
- Where to connect:
 - Terminal strip inside the inverter.
 - Round sockets on the outside of the inverter.
- 2-pin wiring.
- Communication address must be allocated.
- Installation steps:
 - Switch off the inverters and Solar-Log™.
 - Connect inverters to the Solar-Log™.
 - Connect the inverters to each other.
 - Allocate communication address.

Connect inverters to the Solar-Log™

The wiring is done using a

- self-made, shielded 2 wire data cable with a terminal block connector.

Procedure

1. Open the inverter as shown in the inverter's instructions.
2. If you are making the cable yourself, connect the wires as shown in the following diagram

Solar-Log™ terminal strip connector	Solar-Log Base RS485 (A) / (B)	Terminal strip inside the inverter
Terminal		RS485 Terminal
▶ 1 (Data+)	▶ (A) 6 or (B) 10 (Data+)	▶ A/3
▶ 4 (Data-)	▶ (A) 9 or (B) 13 (Data-)	▶ B/4

3. If no further inverter is connected, terminate the inverter according to the instructions for the inverter.
4. Close the inverter if no other inverters are to be connected.
5. Insert the terminal block connector into the Solar-Log™ RS485 socket.

Connect the inverters to each other

- Where to connect: Terminal strip inside the inverter.
- 2-pin wiring.
- Wiring according to inverter instructions.

Alternative procedure with round socket:

Connect inverters to the Solar-Log™

The wiring is done using a

- self-made, shielded 2 wire data cable with round plug and terminal block connector.

Procedure

1. If you are making the cable yourself, connect the wires as shown in the following diagram:

Solar-Log™ terminal strip connector	Solar-Log Base RS485 (A) / (B)	Inverter round socket
Terminal		PIN
▶ 1 (Data+)	▶ (A) 6 or (B) 10 (Data+)	▶ 3
▶ 4 (Data-)	▶ (A) 9 or (B) 13 (Data-)	▶ 4

2. If no further inverter is connected, terminate the inverter according to the instructions for the inverter.
3. Insert the round plug into any COM round socket on the inverter.
4. Insert the terminal block connector into the Solar-Log™ RS485 socket.

Connect the inverters to each other

- Wiring using 2 pin cable with round plugs.
- Where to connect: Round sockets on the outside of the inverter.

Procedure

1. Insert the round plug into any round socket on inverter 1.
2. Insert the other end of the cable into any round socket on inverter 2.
3. Connect the other inverters to each other in the same way.
4. Insert the terminal block connector into the Solar-Log™ RS485 socket.

Allocate communication address

- Recommendation: Continuous numbering starting with 1.
- Address range: 1 - 247.
- Setting: According to inverter instructions.
- Procedure: Start according to the inverter's instructions.

53 KLNE

53.1 KLNE (Solartec and Sunteams)

Termination	Addressing	Interface
Yes	Yes	RS485

Overview

- Integrated interface.
- Where to connect: 4-pin round socket on the button of the device.
- 2-pin wiring.
- Communication address must be allocated.
- Installation steps:
 - Switch off the inverters and Solar-Log™.
 - Connect inverters to the Solar-Log™.
 - Connect the inverters to each other.
 - Allocate communication addresses.

Connect inverters to the Solar-Log™

The wiring is done using a

- self-made cable connection with terminal block connector.
- Where to connect: 4-pin round socket on the button of the device.

Procedure

1. If you are making the cable yourself, connect the wires as shown in the following diagram:

Solar-Log™ terminal strip connector	Solar-Log Base RS485 (A) / (B)	X4 socket inverter
Terminal		PIN
▶ 1 (Data+)	▶ (A) 6 or (B) 10 (Data+)	▶ 4 - Data+
▶ 4 (Data-)	▶ (A) 9 or (B) 13 (Data-)	▶ 2 - Data-

2. If no further inverter is connected, terminate the inverter according to the instructions for the inverter.
3. Insert the terminal block connector into the Solar-Log™ RS485 socket.

Connect the inverters to each other

- Where to connect: 4-pin round socket on the button of the device.

Procedure

1. Unscrew the side cover as shown in the inverter's instructions.
2. If you are making the cable yourself, connect the wires as shown in the following diagram:

Solar-Log™ terminal strip connector Solar-Log Base RS485 (A) / (B) X4 socket inverter

Terminal		PIN
▶ 1 (Data+)	▶ (A) 6 or (B) 10 (Data+)	▶ 4 - Data+
▶ 4 (Data-)	▶ (A) 9 or (B) 13 (Data-)	▶ 2 - Data-

3. Connect the Solar-Log™ cable to socket A on the first inverter.
4. According to the same wiring diagram, connect socket B on the first inverter to socket A on the second inverter using the following diagram.

X4 socket inverter 1	X4 socket inverter 2
Terminal	PIN
▶ 2	▶ 2 - Data+
▶ 4	▶ 4 - Data-

5. Connect the other inverters to each other in the same way.
6. Terminate the last inverter in accordance with the inverter instructions.
7. Insert the terminal block connector into the Solar-Log™ RS485 socket.



Note:

According to the manufacturer's specifications, a maximum of 31 devices can be connected per RS485 bus.

54 Kostal and Solar-Fabrik

54.1 Kostal Piko and Solar-Fabrik Inverter Convert T (RS485)

Termination	Addressing	Interface
Yes	Yes	RS485

Selections available under "Kostal: Standard".

Overview

- Integrated interface.
- Where to connect: Terminal strip inside the inverter.
- 3-pin wiring.
- Communication address must be allocated.
- Multi-string technology.

Pico / Convert inverters are fitted with several MPP trackers: Each string input is monitored separately and ideally adjusted to the connected modules.

Depending on any parallel connections inside the inverter the Solar-Log™ can read the data from up to 3 individual strings.

During the inverter detection, the Solar-Log™ automatically detects how many MPP trackers are active; only the active MPP trackers are displayed. The inverter must be feeding data in for successful detection.

- Installation steps:
 - Switch off the inverters and Solar-Log™.
 - Connect inverters to the Solar-Log™.
 - Connect the inverters to each other.
 - Allocate communication address.

Connect inverters to the Solar-Log™

The wiring is done using a

- ready-made data cable (optional extra; not supplied)
- or
- self-made, shielded 3 wire data cable and terminal block connector.

Procedure

1. Open the inverter as shown in the inverter's instructions.
2. Pull the free wires through the wire opening in the inverter.
3. If you are making the cable yourself, connect the wires as shown in the following diagram:

Solar-Log™ terminal strip connector	Solar-Log Base RS485 (A) / (B)	RS485 inverter socket
Terminal		PIN
▶ 1 (Data+)	▶ (A) 6 or (B) 10 (Data+)	▶ A
▶ 3 GND	▶ (A) 8 or (B) 12 GND	▶ GND
▶ 4 (Data-)	▶ (A) 9 or (B) 13 (Data-)	▶ B

4. If no further inverter is connected, terminate the inverter according to the instructions for the inverter.
5. Close the inverter if no other inverters are to be connected.
6. Insert the terminal block connector into the Solar-Log™ RS485 socket.

Connect the inverters to each other

- Connect using a 3 wire, shielded data cable.
- Where to connect: Terminal strip inside the inverter.

Procedure

1. Open the inverter as shown in the inverter's instructions.
2. Connect terminals A, B and GND of inverter 1 to the corresponding terminals on inverter 2.
3. Connect the other inverters to each other in the same way.
4. Terminate the last inverter according to the inverter instructions.
5. Close inverters.

Allocate communication address

- Recommendation: Continuous numbering starting with 1.
- Setting: Using the software that came with the inverter.
- Procedure: Start according to the inverter's instructions

54.2 Kostal Piko MP

Termination	Addressing	Interface
Connection plug	Yes	RS485

Selections available under "Kostal: Piko MP".

Supported models:

- Kostal Piko 1.5 MP
- Kostal Piko 2.0 MP
- Kostal Piko 2.5 MP
- Kostal Piko 3.0 MP
- Kostal Piko 3.6 MP
- Kostal Piko 4.2 MP

Overview

- Integrated interface.
- Where to connect: RJ socket, on the outside of the inverter's interface card.
- 3-pin wiring.
- Communication address must be allocated.
- Installation steps:
 - Switch off the inverters and Solar-Log™.
 - Connect inverters to the Solar-Log™.
 - Connect the inverters to each other.
 - Allocate communication address (address range 1-99).

Connect inverters to the Solar-Log™

The wiring is done using a

- ready-made data cable (optional extra; not supplied)
- or
- self-made RS485 data cable with RJ45 plug and terminal block connector.



Caution

Risk of damage to the unit!

The Solar-Log™ also has an RJ45 socket, which must never be connected to the RJ45 socket on the inverter.

- ▶ Only connect inverters via the RS485/422 Solar-Log™ interface(s).

Procedure

1. If you are making the cable yourself, connect the wires as shown in the following diagram:

Solar-Log™ terminal strip connector	Solar-Log Base RS485 (A) / (B)	RJ45 inverter
Terminal		PIN
▶ 1 (Data+)	▶ (A) 6 oder (B) 10 (Data+)	▶ 1
▶ 3 GND	▶ (A) 8 or (B) 12 GND	▶ 8
▶ 4 (Data-)	▶ (A) 9 oder (B) 13 (Data-)	▶ 2

2. Insert the RJ45 plug into any RJ45 socket on the first inverter.
3. If no further inverter connected, terminate the inverter:
On the inverter insert the connection plug into the free RJ45 socket.
4. Insert the terminal block connector into the Solar-Log™ RS485 socket.

Connect the inverters to each other

- Connect using the RS485 data cable with RJ45 plug;
Connection cables between the inverters are supplied with the inverters. Use these.
- Where to connect: RJ45 socket on the outside of the inverter

Procedure

1. Insert the RJ45 plug into the free RJ45 socket on the first inverter.
2. Insert the other end of the wire into any RJ45 socket on inverter 2.
3. Connect the other inverters to each other in the same way.
4. Terminate the last inverter.
Insert the connection plug into the free RJ45 socket.

Allocate communication address

1. Recommendation: Continuous numbering starting with 1 (address range 1-99).
2. Setting: via display of the inverter.
3. Procedure: Start according to the inverter's instructions

54.3 Kostal Piko IQ

Termination	Addressing	Interface
No	Yes	LAN

Selections available under "Kostal: Modbus TCP"

Supported models:

- 4.2, 5.5, 7.0, 8.5, 10

Overview

- Integrated interface.
- Connected using network cable (patch cable) and Ethernet router or switch
- Communication address must be allocated
- Installation steps
 - Assign a static IP address
 - Switch off the inverters and Solar-Log™
 - Connect inverters to the Solar-Log™ (RJ45)
 - Connect the inverters to each other (RJ45).

Connect inverters to the Solar-Log™

The wiring is done using a

- network cable (patch cable/crossover cable) and the
- Ethernet router or switch.

Connect the inverters to each other

The inverters are connected together using the RJ45 interface and, if needed, a router or switch.

Connection setup according to the inverter's instructions.

Assigning IP addresses

- A static IP address has to be assigned to the inverter via the display.
- Please select an IP address with the same class C subnet as the Solar-Log™.
For example: The Solar-Log™ has the IP address 192.168.178.49.
The inverter in this case has to have a free IP address in the same range (from 192.168.178.1 to 192.168.178.254).
- Procedure: Start according to the inverter's instructions.

Detection via the Solar-Log™ WEB interface

- For detection on the Solar-Log™, select the device class under the menu [Configuration | Device | Definition | Interface](#) with the plus symbol and then select Kostal as the manufacturer and Modbus TCP as the type. Confirm your selection with OK.
- Save your selections and then start the Device Detection under [Configuration | Device | Detection](#) and start the device detection.

Detection from the Solar-Log 1200

- When using the Solar-Log 1200, the detection can also be started from the display. Select the settings ► Start ► Initial Configuration ► Page 2 „Device“ ► Add and select the manufacturer „Kostal: Modbus TCP“ from there. Save and start the Device Detection.



Note!

„Modbus TCP“ has to be activated to be able to communicate with the Solar-Log™.

This is done from the inverter's web menu.

Enter the IP address of the inverter into your internet browser and then go to the menu Settings / Information > Communication > sunspec / Modbus > and check the box for Modbus TCP.

54.4 Kostal Plenticore plus

Termination	Addressing	Interface
No	Yes	LAN

Selections available under "Kostal: Modbus TCP"

Supported models:

- 4.2, 5.5, 7.0, 8.5, 10

Overview

- Integrated interface.
- Connected using network cable (patch cable) and Ethernet router or switch
- Communication address must be allocated
- Installation steps
 - Assign a static IP address
 - Switch off the inverters and Solar-Log™
 - Connect inverters to the Solar-Log™ (RJ45)
 - Connect the inverters to each other (RJ45).

Connect inverters to the Solar-Log™

The wiring is done using a

- network cable (patch cable/crossover cable) and the
- Ethernet router or switch.

Connect the inverters to each other

The inverters are connected together using the RJ45 interface and, if needed, a router or switch.

Connection setup according to the inverter's instructions.

Assigning IP addresses

- A static IP address has to be assigned to the inverter via the display.
- Please select an IP address with the same class C subnet as the Solar-Log™.
For example: The Solar-Log™ has the IP address 192.168.178.49.
The inverter in this case has to have a free IP address in the same range (from 192.168.178.1 to 192.168.178.254).
- Procedure: Start according to the inverter's instructions.

Detection via the Solar-Log™ WEB interface

- For detection on the Solar-Log™, select the device class under the menu [Configuration | Device | Definition | Interface](#) with the plus symbol and then select Kostal as the manufacturer and Modbus TCP as the type. Confirm your selection with OK.
- Save your selections and then start the Device Detection under [Configuration | Device | Detection](#) and start the device detection.

Detection from the Solar-Log 1200

- When using the Solar-Log 1200, the detection can also be started from the display. Select the settings ► Start ► Initial Configuration ► Page 2 „Device“ ► Add and select the manufacturer „Kostal: Modbus TCP“ from there. Save and start the Device Detection.

**Note!**

„Modbus TCP“ has to be activated to be able to communicate with the Solar-Log™.

This is done from the inverter's web menu.

Enter the IP address of the inverter into your internet browser and then go to the menu Settings / Information > Communication > sunspec / Modbus > and check the box for Modbus TCP.

**Note!**

When detecting via Ethernet, it is also possible (if installed) to detect a connected battery.

► Without a connected battery, the Kostal Plenticore plus is detected as an inverter, with a connected battery, as a hybrid system with the associated bidirectional meter.

54.5 Kostal Ethernet Version

Termination	Addressing	Interface
No	Yes	LAN

Overview

- Integrated interface
- Connected using network cable (patch cable) and Ethernet router or switch
- Communication address must be allocated
- Installation steps
 - Assign a static IP address
 - Switch off the inverters and Solar-Log™
 - Connect inverters to the Solar-Log™ (RJ45)
 - Connect the inverters to each other (RJ45)



Note:

The RS485 bus address of every inverter has to be configured to 255 so that the Solar-Log can communicate with the inverter.

- ▶ Starting with firmware version 3.2.1, inverters set up with bus address 1 are supported.
- ▶ The bus address is determined once during the inverter detection process. For this reason, it is not possible to change it while in operation (the Solar-Log™ would then no longer be able to access the inverters). If this has accidentally happened, perform the inverter detection again to be able to access the inverter from the Solar-Log™.

Connect inverters to the Solar-Log™

The wiring is done using a

- network cable (patch cable/crossover cable) and the
- Ethernet router or switch.

Connect the inverters to each other

The inverters are connected together using the RJ45 interface and, if needed, a router or switch.

Connection setup according to the inverter's instructions.

Assigning IP addresses

- A static IP address has to be assigned to the inverter via the display.
- Please select an IP address with the same class C subnet as the Solar-Log™.
For example: The Solar-Log™ has the IP address 192.168.178.49.
The inverter in this case has to have a free IP address in the same range (from 192.168.178.1 to 192.168.178.254).
- Procedure: Start according to the inverter's instructions



Note

Each inverter must be accessible through the network individually. It is thereby necessary to activate the network interface on each inverter (under the menu item "LAN" select "Activate LAN") and to connect the inverters to the network by means of a switch.

Detection via the Solar-Log™ WEB Interface

- For detection on the Solar-Log™, select the device class under the menu Configuration | Device | Definition | Interface with the plus symbol and then select Kostal as the manufacturer. Confirm your selection with OK.
- Save your selections and then start the Device Detection under Configuration | Device | Detection.

Detection from the Solar-Log 1200

- When using the Solar-Log 1200, the detection can also be started from the display. Select the settings Start ► Initial Configuration ► Page 2 „Device“ ► Add and select the manufacturer Kostal from there. Save and start the Device Detection.



Note Power Management (Inverter Settings):

The power reduction function is only available when the "Sensors" selection has been activated under the -> Settings / Analog Inputs menu.

In order that reactive power control functions, the low-voltage guidelines have to be selected in the country settings for the inverter (e.g. "DE-NSR" for the German low-voltage guidelines).



Caution:

The country settings can only be configured once during the initial installation. If the wrong country is selected, it can be reset using the Kostal software tool "PARAKO." This tool can be obtained directly from Kostal after registering.

55 Kstar

55.1 Kstar Multitracker

Termination	Addressing	Interface
DIP switch	Yes	RS485

Select "Kstar: KSG TRIO" during the inverter detection

Overview

- Integrated interface
- 3-pin wiring
- 2 RJ45 sockets on the outside of the inverter
- Communication address must be allocated
- Installation steps
 - Switch off the inverters and Solar-Log™
 - Connect inverters to the Solar-Log™
 - Connect the inverters to each other
 - Allocate communication address
Address range 1 to 32
Settings on the inverter's display according to the manufacturer's manual

Connect inverters to the Solar-Log™

The wiring is done using a

- self-made cable connection with RS485 data cable and terminal block connector.



Caution

Risk of damage to the unit!

The Solar-Log™ also has an RJ45 socket, which must never be connected to the RJ45 socket on the inverter.

- ▶ Only connect inverters via the RS485/422 Solar-Log™ interface(s).
-

Procedure

1. If you are fabricating the cable yourself, connect the wires as shown in the following diagram.

Solar-Log™ terminal strip connector	Solar-Log Base RS485 (A) / (B)	RS485 inverter socket
Terminal		PIN
▶ 1 (Data+)	▶ (A) 6 or (B) 10 (Data+)	▶ Pin 1 (A) T/R+
▶ 3 GND	▶ (A) 8 or (B) 12 GND	▶ Pin 5 GND
▶ 4 (Data-)	▶ (A) 9 or (B) 13 (Data-)	▶ Pin 2 (B) T/R-

2. Insert the RJ45 plug into the RJ45 socket on the inverter.
3. If no further inverter connected, terminate the inverter:
Set the dip switch to "on."
4. Insert the terminal block connector into the Solar-Log™ RS485 socket.

Connect the inverters to each other

- Connect using a network cable (patch cable) (No Crossover cable)
- Where to connect: RJ45 sockets on the outside of the inverter.

Procedure

1. Insert the RJ45 plug into the free RJ45 socket on the first inverter.
2. Insert the other end of the wire into any RJ45 socket on inverter 2.
3. Connect the other inverters to each other in the same way.
4. Terminate the last inverter, set the DIP switch to "on."

Allocate communication address

- Recommendation: Continuous numbering from 1 to 32
- Setting: Using the inverter operating display.
- Procedure: Start according to the inverter’s instructions.



Note

The following setting needs to be enable so that the PM parameters can be received.
 SETUP ▶ REMOTE CNTRL ▶ ENABLE

55.2 Kstar Singletracker

Termination	Addressing	Interface
DIP switch	Yes	RS485

Select "Kstar: KSG-SM/DM" during the inverter detection

Overview

- Integrated interface
- 3-pin wiring
- 2 RJ45 sockets on the outside of the inverter
- Communication address must be allocated
- Installation steps
 - Switch off the inverters and Solar-Log™
 - Connect inverters to the Solar-Log™
 - Connect the inverters to each other
 - Allocate communication address
Address range 1 to 254
Settings on the inverter's display according to the manufacturer's manual

Connect inverters to the Solar-Log™

The wiring is done using a

- self-made cable connection with RS485 data cable and terminal block connector.



Caution

Risk of damage to the unit!

The Solar-Log™ also has an RJ45 socket, which must never be connected to the RJ45 socket on the inverter.

- ▶ Only connect inverters via the RS485/422 Solar-Log™ interface(s).

Procedure

1. If you are fabricating the cable yourself, connect the wires as shown in the following diagram.

Solar-Log™ terminal strip connector	Solar-Log Base RS485 (A) / (B)	RS485 inverter socket
Terminal		PIN
▶ 1 (Data+)	▶ (A) 6 or (B) 10 (Data+)	▶ Pin 1 (A) T/R+
▶ 3 GND	▶ (A) 8 or (B) 12 GND	▶ Pin 5 GND
▶ 4 (Data-)	▶ (A) 9 or (B) 13 (Data-)	▶ Pin 2 (B) T/R-

2. Insert the RJ45 plug into the RJ45 socket on the inverter.
3. If no further inverter connected, terminate the inverter:
Set the dip switch to "on."
4. Insert the terminal block connector into the Solar-Log™ RS485 socket.

Connect the inverters to each other

- Connect using a network cable (patch cable) (No Crossover cable)
- Where to connect: RJ45 sockets on the outside of the inverter.

Procedure

1. Insert the RJ45 plug into the free RJ45 socket on the first inverter.
2. Insert the other end of the wire into any RJ45 socket on inverter 2.
3. Connect the other inverters to each other in the same way.
4. Terminate the last inverter, set the DIP switch to "on."

Allocate communication address

- Recommendation: Continuous numbering from 1 to 254
- Setting: Using the inverter operating display.
- Procedure: Start according to the inverter's instructions.

56 Mastervolt

56.1 Mastervolt (RS485)

Termination	Addressing	Interface
Yes	No	RS485

Overview

- Integrated interface
- Where to connect: RJ45 plug outside the housing floor.
- 2-pin wiring
- Communication address does not have to be assigned
- Multi-string technology

Mastervolt inverters are fitted with 1 or 2 MPP trackers depending on the model. Each string input is monitored separately and ideally adjusted to the connected modules. Some inverters are also divided internally into 2 or even 3 individual inverters. For example, the QS6400 is recognized as 2 inverters each with 2 strings, an XL 15 as 3 independent XL5000s.

The Solar-Log™ automatically detects how many inverters and strings are active during inverter detection.



Note

A maximum of 20 inverters can be connected per RS485 bus.



Note

The order in which the inverters are displayed in the Solar-Log™ after detection is random. We strongly recommend that you change the order of the inverters immediately after detection at startup, in the [Configuration | Devices | Configuration | order](#) dialog box.

- ▶ The inverters can be identified using the displayed serial number.

- Installation steps
 - Switch off the inverters and Solar-Log™
 - Connect inverters to the Solar-Log™
 - Connect the inverters to each other

Connect inverters to the Solar-Log™

The wiring is done using a

- ready-made Mastervolt data cable (optional extra; not supplied)
- or
- self-made cable connection with RJ45 data cable and terminal block connector.



Caution

Risk of damage to the unit!

The Solar-Log™ also has an RJ45 socket, which must never be connected to the RJ45 socket on the inverter.

- ▶ Only connect inverters via the RS485/422 Solar-Log™ interface(s).

Procedure

1. If you are making the cable yourself, connect the wires as shown in the following diagram:

Solar-Log™ terminal strip connector	Solar-Log Base RS485 (A) / (B)	RJ45 inverter
Terminal		PIN
▶ 1 (Data+)	▶ (A) 6 or (B) 10 (Data+)	▶ 4
▶ 4 (Data-)	▶ (A) 9 or (B) 13 (Data-)	▶ 3

2. Insert the RJ45 plug into the RJ45 socket on the inverter.
3. If no further inverter is connected, terminate the inverter according to the instructions for the inverter.
4. Insert the terminal block connector into the Solar-Log™ RS485 socket.

Connect the inverters to each other

- Connect using a network cable (patch cable)
- Where to connect: RJ45 plug outside the housing floor

Procedure

1. Insert the RJ45 plug into any RJ45 socket on inverter 1.
2. Insert the other end of the wire into any RJ45 socket on inverter 2.
3. Connect the other inverters to each other in the same way.
4. Terminate the last inverter in accordance with the inverter instructions.

57 Mitsubishi

57.1 Mitsubishi with RS485 interface

Termination	Addressing	Interface
Switch	Yes	RS485

Overview

- Integrated interface
- Where to connect: 2 RJ11 sockets inside the inverter.
- 2-pin wiring
- Communication address must be allocated.
- Installation steps
 - Switch off the inverters and Solar-Log™
 - Connect inverters to the Solar-Log™
 - Connect the inverters to each other
 - Allocate communication address

Connect inverters to the Solar-Log™

The wiring is done using a

- ready-made RJ11 data cable (optional extra; not supplied)
- or
- self-made cable connection with RJ11 cable connection and terminal block connector.

Procedure

1. Unscrew the front plate of the inverter as shown in the inverter's instructions.
2. If you are making the cable yourself, connect the wires as shown in the following diagram:

Solar-Log™ terminal strip connector	Solar-Log Base RS485 (A) / (B)	RJ11 Inverter
Terminal		PIN
▶ 1 (Data+)	▶ (A) 6 or (B) 10 (Data+)	▶ 3
▶ 4 (Data-)	▶ (A) 9 or (B) 13 (Data-)	▶ 4

3. Insert the RJ11 plug into any RJ11 socket on inverter 1.
4. If no further inverter connected, terminate the inverter:
In the inverter, set the DIP switch for the terminal resistor to ON.
5. Screw the front plate inverter on again if no other inverters are to be connected.
6. Insert the terminal block connector into the Solar-Log™ RS485 socket.

Connect the inverters to each other

- Connect using a data cable with an RJ11 plug.
- Where to connect: 2 RJ11 sockets at the bottom left inside the inverter.

Procedure

1. Unscrew the front plate of the inverter as shown in the inverter's instructions.
2. Insert the RJ11 plug into any RJ11 socket on inverter 1.
3. Insert the other end of the cable into any RJ11 socket on inverter 2.
4. Connect the other inverters to each other in the same way.
5. Terminate the last inverter.
Set the DIP switch for the terminal resistor to ON.
6. Screw the inverter front plate on again.

Allocate communication address

- Recommendation: Continuous numbering starting with 1.
- Setting: Using the inverter operating display
- Procedure: Start according to the inverter's instructions

58 Motech

58.1 Motech (RS485)

Termination	Addressing	Interface
Yes	No	RS485

Overview

- Integrated interface
- Where to connect: RJ45 plug outside the housing floor
- 2-pin wiring
- Communication address does not have to be assigned
- Installation steps
 - Switch off the inverters and Solar-Log™
 - Connect inverters to the Solar-Log™
 - Connect the inverters to each other

Connect inverters to the Solar-Log™

The wiring is done using a

- ready-made BRJ2 data cable (optional extra; not supplied)
- or
- self-made cable connection with RS485 data cable and terminal block connector.



Caution

Risk of damage to the unit!

The Solar-Log™ also has an RJ45 socket, which must never be connected to the RJ45 socket on the inverter.

- ▶ Only connect inverters via the RS485/422 Solar-Log™ interface(s).

Procedure

1. If you are making the cable yourself, connect the wires as shown in the following diagram:

Solar-Log™ terminal strip connector	Solar-Log Base RS485 (A) / (B)	RJ45 inverter
Terminal		PIN
▶ 1 (Data+)	▶ (A) 6 or (B) 10 (Data+)	▶ 7
▶ 4 (Data-)	▶ (A) 9 or (B) 13 (Data-)	▶ 8

2. Insert the RJ45 plug into the RJ45 socket on the inverter.
3. If no further inverter is connected, terminate the inverter according to the instructions for the inverter.
4. Insert the terminal block connector into the Solar-Log™ RS485 socket.

Connect the inverters to each other

- Connect using a network cable (patch cable)
- Where to connect: RJ45 sockets on the outside of the inverter.

Procedure

1. Insert the RJ45 plug into any RJ45 socket on inverter 1.
2. Insert the other end of the wire into any RJ45 socket on inverter 2.
3. Connect the other inverters to each other in the same way.
4. Terminate the last inverter in accordance with the inverter instructions.

59 Oelmaier

59.1 Oelmaier

Termination	Addressing	Interface
Yes	Yes	RS485

Overview

- Integrated interface
- Where to connect: Terminal strip behind service cover
- 2-pin wiring
- Communication address must be allocated
- Installation steps
 - Switch off the inverters and Solar-Log™
 - Connect inverters to the Solar-Log™
 - Connect the inverters to each other
 - Allocate communication address

Connect inverters to the Solar-Log™

The wiring is done using a

- self-made, shielded 2 wire data cable with a terminal block connector.

Procedure

1. Open the inverter as shown in the inverter's instructions.
2. If you are making the cable yourself, connect the wires as shown in the following diagram:

Solar-Log™ terminal strip connector	Solar-Log Base RS485 (A) / (B)	Terminal strip inside the inverter
Terminal		Terminal
▶ 1 (Data+)	▶ (A) 6 or (B) 10 (Data+)	▶ A-Data +
▶ 4 (Data-)	▶ (A) 9 or (B) 13 (Data-)	▶ B-Data -

3. Terminate the inverter as shown in the inverter's instructions.
4. Close inverters.
5. Insert the terminal block connector into the Solar-Log™ RS485 socket.

Connect the inverters to each other

- Where to connect: Terminal strip behind service cover
- 2-pin wiring

Procedure

1. Open the inverter as shown in the inverter's instructions.
2. If you are making the cable yourself, connect the wires as shown in the following diagram:

Solar-Log™ terminal strip connector	Solar-Log Base RS485 (A) / (B)	Terminal strip inside the inverter
Terminal		RS485 terminal
▶ 1 (Data+)	▶ (A) 6 or (B) 10 (Data+)	▶ A-Data +
▶ 4 (Data-)	▶ (A) 9 or (B) 13 (Data-)	▶ B-Data -

3. Connect terminals A and B on inverter 1 to the corresponding terminals on inverter 2.
4. Connect the other inverters to each other in the same way.
5. Terminate the inverter as shown in the inverter's instructions.
6. Close inverters.
7. Insert the terminal block connector into the Solar-Log™ RS485 socket.

Allocate communication address

- Recommendation: Continuous numbering starting with 1.
- Setting: Using the solar fitter's menu on the inverter.
- Procedure: Start according to the inverter's instructions

60 Omnik

60.1 Omnik (RS422)

Termination	Addressing	Interface
No	Automatic	RS422

Overview

- Integrated interface
- Where to connect: RJ45 socket on the outside of the inverter
- 4-pin cable – only on RS485/422 B or C connection of the Solar-Log™
- Communication address does not have to be assigned



Note

The order in which the inverters are displayed in the Solar-Log™ after detection is random. We strongly recommend that you change the order of the inverters immediately after detection at startup in the [Configuration | Device | Configuration | Order](#) menu box.

- ▶ The inverters can be identified using the displayed serial number.

- Installation steps
 - Switch off the inverters and Solar-Log™
 - Connect inverters to the Solar-Log™
 - Connect the inverters to each other

Connect inverters to the Solar-Log™

The wiring is done using a

- self-made cable connection with RS485 data cable and terminal block connector.



Caution

Risk of damage to the unit!

The Solar-Log™ also has an RJ45 socket, which must never be connected to the RJ45 socket on the inverter.

- ▶ Only connect inverters via the RS485/422 B/C Solar-Log™ interface.

Procedure

1. Connect the wires for the cable connection as shown in the following diagram.

Solar-Log™ terminal strip connector	Solar-Log Base RS422	RJ45 inverter
Terminal		PIN
▶ 1 (T/RX+)	▶ 6 (T/RX+)	▶ PIN 4 RX+
▶ 4 (T/RX-)	▶ 9 (T/RX-)	▶ PIN 5 RX-
▶ 5 (R/TX+)	▶ 10 (R/TX+)	▶ PIN 3 TX+
▶ 6 (R/TX-)	▶ 13 (R/TX-)	▶ PIN 6 TX-

2. Insert the RJ45 plug into any RJ45 socket on inverter 1.
3. Insert the terminal block connector into the Solar-Log™ RS485/422 B or C socket

Connect the inverters to each other

- Connect using a network cable (patch cable)
- Where to connect: RJ45 socket outside the inverter

Procedure

1. Insert the RJ45 plug into any RJ45 socket on inverter 1.
2. Insert the other end of the wire into any RJ45 socket on inverter 2.
3. Connect the other inverters to each other in the same way.

60.2 Omnik (RS485)

Termination	Addressing	Interface
No	Automatic	RS485

Overview

- Integrated interface.
- Where to connect: RJ45 socket on the outside of the inverter.
- 3-pin wiring.
- Communication address does not have to be assigned.



Note

The order in which the inverters are displayed in the Solar-Log™ after detection is random. We strongly recommend that you change the order of the inverters immediately after detection at startup in the [Configuration | Device | Configuration | Order](#) menu box.

- ▶ The inverters can be identified using the displayed serial number.

- Installation steps
 - Switch off the inverters and Solar-Log™
 - Connect inverters to the Solar-Log™
 - Connect the inverters to each other

Retrofitting the RS485 interface card*

Procedure:

- ▶ Install the RS485 interface card into the inverter according to the installation instructions for the RS485 interface card.

Connect inverters to the Solar-Log™

The wiring is done using a

- self-made cable connection with RS485 data cable and terminal block connector.



Caution

Risk of damage to the unit!

The Solar-Log™ also has an RJ45 socket, which must never be connected to the RJ45 socket on the inverter.

- ▶ Only connect inverters via the RS485 Solar-Log™ interface.



*Note about the RS485 interface card:

In order to be able to communicate with the Solar-Log™, the RS485 interface card must be retrofitted on older Omnik devices. Newer devices are already equipped with the RS85 interface card.

Procedure

1. Connect the wires for the cable connection as shown in the following diagram.

Solar-Log™ terminal strip connector	Solar-Log Base RS485 (A) / (B)	RJ45 inverter
Terminal		PIN
▶ 1 (Data+)	▶ (A) 6 or (B) 10 (Data+)	▶ PIN 3 TX+
▶ 3 GND	▶ (A) 8 or (B) 12 GND	▶ PIN 7 GND
▶ 4 (Data-)	▶ (A) 9 or (B) 13 (Data-)	▶ PIN 6 TX-

2. Insert the RJ45 plug into any RJ45 socket on inverter 1.
3. Insert the terminal block connector into the Solar-Log™ RS485 socket

Connect the inverters to each other

- Connect using a network cable (patch cable)
- Where to connect: RJ45 socket outside the inverter

Procedure

1. Insert the RJ45 plug into any RJ45 socket on inverter 1.
2. Insert the other end of the wire into any RJ45 socket on inverter 2.
3. Connect the other inverters to each other in the same way.

61 Omron

61.1 Omron

Termination	Addressing	Interface
Bridge 9 ► 10	Yes	RS485

Overview

- Integrated interface
- Where to connect: Terminal strip inside the inverter
- 3-pin wiring
- Communication address must be allocated
- Installation steps
 - Switch off the inverters and Solar-Log™
 - Connect inverters to the Solar-Log™
 - Connect the inverters to each other
 - Allocate communication address

Connect inverters to the Solar-Log™

The wiring is done using a

- self-made, shielded 3 wire data cable and terminal block connector.

Procedure

1. Open the inverter as shown in the inverter's instructions.
2. Connect the cable as shown in the following diagram.

Solar-Log™ terminal strip connector Solar-Log Base RS485 (A) / (B) Inverter terminal strip

PIN		Terminal strip TB401
► 1 (Data+)	► (A) 6 or (B) 10 (Data+)	► Pin 4 - Data +
► 3 GND	► (A) 8 or (B) 12 GND	► Pin 3 - GND
► 4 (Data-)	► (A) 9 or (B) 13 (Data-)	► Pin 5 - Data -

3. If no further inverter connected, terminate the inverter. To do this a bridge must be inserted on the inverter between pins 9 and 10.
4. Close the inverter if no other inverters are to be connected.
5. Insert the terminal block connector into the Solar-Log™ RS485 socket.

Connect the inverters to each other

The wiring is done using a

- self-made, shielded 3 wire data cable and terminal block connector.

Procedure

1. Open the inverter as shown in the inverter's instructions.

Inverter n	Inverter n+1
Terminal strip TB401	Terminal strip TB401
▶ 6	▶ Pin 3 - GND
▶ 7	▶ Pin 4 - Data +
▶ 8	▶ Pin 5 - Data -

2. Connect terminals 6, 7 and 8 on inverter 1 to terminals 3, 4 and 5 on inverter 2.
3. Connect the other inverters to each other in the same way.
4. Terminate the last inverter.
Bridge between pins 9 and 10.
5. Close inverters.
6. Insert the terminal block connector into the Solar-Log™ RS485 socket.

Inverter settings

The following values must be set in the inverter setup:

- COM_485 to 19200bps
- COM_Pari to Even
- COM_Stop to 2bit
- Set the communication protocol to "Auto" or "Compoway/F"; not "Modbus"

Please follow the instructions in the manufacturer's handbook for this.

Allocate communication address

- Recommendation: Continuous numbering starting with 1.
- Setting: Using the inverter operating display
- Procedure: Start according to the inverter's instructions



Note

A maximum of 31 inverters can be connected per RS485 bus.

62 Pairan

62.1 Pairan

Termination	Addressing	Interface
Jumper	No	RS485

Overview

- Integrated interface
- Where to connect: Round socket on inverter
- 2-pin wiring
- Communication address does not have to be assigned

Installation steps

- Switch off the inverters and Solar-Log™
- Connect inverters to the Solar-Log™
- Connect the inverters to each other

Connect inverters to the Solar-Log™

The wiring is done using a

- self-made cable connection with the round plug and the terminal strip plug.
The round plug must be obtained from the manufacturer.

Procedure

1. If you are making the cable yourself, connect the wires as shown in the following diagram

View of the connection socket

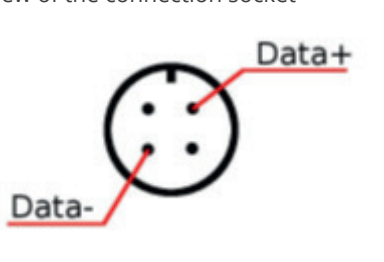

Fig.: Pairan Round socket

Solar-Log™ terminal strip connector	Solar-Log Base RS485 (A) / (B)	Inverters
PIN		Round socket
▶ 1 (Data+)	▶ (A) 6 or (B) 10 (Data+)	▶ Data +
▶ 4 (Data-)	▶ (A) 9 or (B) 13 (Data-)	▶ Data -

2. Insert the terminal block connector into the Solar-Log™ RS485 socket.

Connect the inverters to each other

- Connect using a 2 wire, shielded data cable.
- Where to connect: Round socket on inverter.

Procedure

1. self-made cable connection with round plug and a terminal block plug.
2. Also connect the cable to the next inverter in round plug 1.
3. Connect the other inverters to each other in the same way.

63 Phoenixtec

63.1 Phoenixtec

Termination	Addressing	Interface
Yes	No	RS422

Selectable under Sunville

Overview

- Interface not integrated; Retrofit RS485 interface card.
- 4-pin cable – only on RS485/422 B or C connection of the Solar-Log™
- Communication address does not have to be assigned
- Multi-string technology

The Sunville inverters are fitted with 1 or 3 MPP trackers depending on the model.

The Solar-Log™ automatically detects how many inverters and strings are active during inverter detection.



Note

The order in which the inverters are displayed in the Solar-Log™ after detection is random. We strongly recommend that you change the order of the inverters immediately after detection at startup, in the [Configuration | Devices | Configuration | Order](#) dialog box.

- ▶ The inverters can be identified using the displayed serial number.

- Installation steps
 - Switch off the inverters and Solar-Log™
 - Install the RS485 interface in the inverter
 - Connect inverters to the Solar-Log™
 - Connect the inverters to each other

Installing the RS485 interface

Procedure

Install the RS485 interface card according to the manufacturer's installation instructions.

Connect inverters to the Solar-Log™

The wiring is done using a

- ready-made data cable (optional extra; not supplied)

or

- self-made, shielded 4 wire data cable and terminal block connector.



Note

Only connect inverter using the RS485/422 B or C interface.

Procedure

1. Open the inverter as shown in the inverter's instructions.
2. Pull the free wires through the wire opening in the inverter.
3. If you are making the cable yourself, connect the wires as shown in the following diagram:

Solar-Log™ terminal strip connector	Solar-Log Base RS422	Inverter terminal strip
Terminal		Terminal
▶ 1 (T/RX+)	▶ 6 (T/RX+)	▶ R+
▶ 4 (T/RX-)	▶ 9 (T/RX-)	▶ R-
▶ 5 (R/TX+)	▶ 10 (R/TX+)	▶ T+
▶ 6 (R/TX-)	▶ 13 (R/TX-)	▶ T-

4. Close the inverter if no other inverters are to be connected.
5. Insert the terminal block connector into the Solar-Log™ RS485/422 B or C socket.

Connect the inverters to each other

- Connect using a 4 wire, shielded data cable.
- Where to connect: Terminal strip inside the inverter (on the retrofitted RS485 interface).

Procedure

1. Open the inverter as shown in the inverter's instructions.
2. Connect terminals R+, R-, T+ and T- of inverter 1 to the corresponding terminals on inverter 2.
3. Connect the other inverters to each other in the same way.
4. Close inverters.

64 Platinum (formerly Diehl Ako)

64.1 Platinum with RS485 interface

Termination	Addressing	Interface
Yes	No	RS485

Select "Platinum: EIA485" during the inverter detection

Overview

- Integrated interface
- Where to connect: RJ45 socket on the bottom of the inverter
- 2-pin wiring
- Communication address does not have to be assigned



Note

The order in which the inverters are displayed in the Solar-Log™ after detection is random. We strongly recommend that you change the order of the inverters immediately after detection at startup, in the [Configuration | Devices | Configuration | Order](#) dialog box.

- ▶ The inverters can be identified using the displayed serial number.

- Installation steps
 - Switch off the inverters and Solar-Log™
 - Connect inverters to the Solar-Log™
 - Connect the inverters to each other

Connect inverters to the Solar-Log™

The wiring is done using a

- ready-made data cable (optional extra; not supplied)
- or
- self-made cable connection with RS485 data cable and terminal block connector.

Procedure

1. If you are making the cable yourself, connect the wires as shown in the following diagram:

Solar-Log™ terminal strip connector	Solar-Log Base RS485 (A) / (B)	RJ45 inverter
Terminal		PIN
▶ 1 (Data+)	▶ (A) 6 or (B) 10 (Data+)	▶ PIN 6 (A)
▶ 4 (Data-)	▶ (A) 9 or (B) 13 (Data-)	▶ PIN 3 (B)

2. Insert the RJ45 plug into the RJ45 socket on the inverter.
3. If no further inverter is connected, terminate the inverter according to the instructions for the inverter.
4. Insert the terminal block connector into the Solar-Log™ RS485 socket.

Connect the inverters to each other

- Connect using a network cable (patch cable)
- Where to connect: RJ45 sockets on the bottom of the inverter

Procedure

1. Insert the RJ45 plug into any RJ45 socket on inverter 1.
2. Insert the other end of the wire into any RJ45 socket on inverter 2.
3. Connect the other inverters to each other in the same way.
4. Terminate the last inverter according to the inverter instructions.

64.2 Platinum H

Termination	Addressing	Interface
Yes	Yes	RS485

Select "Platinum: H-Serie" during the inverter detection

Overview

- Integrated interface
- Where to connect: Terminal strip inside the inverter
- 2-pin wiring
- Communication address must be allocated
- Installation steps
 - Switch off the inverters and Solar-Log™
 - Connect inverters to the Solar-Log™
 - Connect the inverters to each other
 - Configure the inverter's communication interface
 - Allocate communication address

Connect inverters to the Solar-Log™

The wiring is done using a

- self-made, shielded 2 wire data cable and terminal block connector.

Procedure

1. Connect wires as shown in the diagram below.

Solar-Log™ terminal strip connector	Solar-Log Base RS485 (A) / (B)	Inverter terminal strip
Terminal		Terminal
▶ 1 (Data+)	▶ (A) 6 or (B) 10 (Data+)	▶ B (Data +)
▶ 4 (Data-)	▶ (A) 9 or (B) 13 (Data-)	▶ A (Data -)

2. If no further inverter is connected, terminate the inverter according to the instructions for the inverter.
3. Close the inverter cover if no other inverters are to be connected.
4. Insert the terminal block connector into the Solar-Log™ RS485 socket.

Connect the inverters to each other

The inverters are connected together using

the RS485 interface. Refer to the manufacturer's inverter manual for the details on how to setup the connection.

Allocate communication address

- Recommendation: Continuous numbering starting with 1
- Setting: Using the inverter operating display
- Procedure: Start according to the inverter's instructions

Other configurations

- Activate the RS485 interface Using the inverter operating display.



Note

Pay particular attention to the instructions in the installation manual regarding the address types, activating the communication interface and the master/slave mode.

65 Polycab

65.1 Polycab

Termination	Addressing	Interface
Yes	Yes	RS485

Supported models:

PSIS series:

- 0.7K, 1K, 1.5K, 2.0K, 2.5K, 3K, 3.6K, 4K, 4.6K, 5K, 3K-ST, 3.6K-ST

PSIT series:

- 6K, 10K, 15K, 20K, 25K, 30K, 36K, 40K, 50K-DC

Overview

- Integrated interface
- Where to connect: Between the COM round sockets on the outside of the inverter
- 2-pin wiring
- Communication address must be allocated
- Installation steps
 - Switch off the inverters and Solar-Log™
 - Connect inverters to the Solar-Log™
 - Connect the inverters to each other
 - Allocate communication address



Note!

It is important to note that there are two different wiring types for the Polycab model.

- ▶ Refer to the wiring table further below.

Connect inverters to the Solar-Log™

The wiring is done using a

- ready-made data cable (supplied with the inverter).

or

- self-made, shielded 2 wire data cable with round plug and terminal block connector.

Procedure for models up to and including 15K

1. If you are making the cable yourself, connect the wires as shown in the following diagram:

Solar-Log™ terminal strip connector	Solar-Log Base RS485 (A) / (B)	Inverter COM1 (RS485)
Terminal		PIN
▶ 1 (Data+)	▶ (A) 6 or (B) 10 (Data+)	▶ 3 RS485 A
▶ 3 GND	▶ (A) 8 or (B) 12 GND	▶ 2 GND
▶ 4 (Data-)	▶ (A) 9 or (B) 13 (Data-)	▶ 4 RS485 B

2. Connect the round plug with the inverter’s COM1 round socket.
3. Terminate the inverter according to the manufacturer’s instructions if no additional inverters are to be connected.
4. Insert the terminal block connector into the Solar-Log™ RS485 socket.

Connect the inverters to each other

- Wiring using Polycab’s daisy chain cable.
- Connect the cables according to the inverter manufacturer’s instructions.
- Terminate the last inverter according to the inverter manufacturer’s instructions.

Assign the communication address

- Recommendation: Continuous numbering starting with 1.
- Default settings on the inverter: Communication address 1
- Setting: Using the inverter operating display
- Procedure: Start according to the inverter manufacturer’s instructions.

Procedure for models 20K and larger:

1. If you are making the cable yourself, connect the wires as shown in the following diagram:

Solar-Log™ terminal strip connector	Solar-Log Base RS485 (A) / (B)	Inverter RJ45
Terminal		Pin
▶ 1 (Data+)	▶ (A) 6 or (B) 10 (Data+)	▶ 1 RS485 A
▶ 1 (Data+)	▶ (A) 6 or (B) 10 (Data+)	▶ 4 RS485 A
▶ 4 (Data-)	▶ (A) 9 or (B) 13 (Data-)	▶ 2 RS485 B
▶ 4 (Data-)	▶ (A) 9 or (B) 13 (Data-)	▶ 5 RS485 B

2. Insert the RJ45 connector into the inverter’s COM2 socket.
3. Terminate the inverter according to the manufacturer’s instructions if no additional inverters are to be connected.
4. Insert the terminal block connector into the Solar-Log™ RS485 socket.

Connect the inverters to each other

- Wiring using Polycab’s daisy chain cable.
- Where to connect: COM round socket on the inverter

Procedure:

1. Insert the RJ45 connector into the first inverter's COM3 socket.
2. Insert the other end of the cable into the COM2 socket on second inverter.
3. Connect the other inverters to each other in the same way.
4. Terminate the last inverter according to the inverter manufacturer's instructions.

Assign the communication address

- Recommendation: Continuous numbering starting with 1.
- Default settings on the inverter: Communication address 1.
- Setting: Using the inverter's operating display.
- Procedure: Start according to the inverter manufacturer's instructions.

66 Powercom

66.1 Powercom

Termination	Addressing	Interface
Switch	Yes	RS485

Overview

- Interface not integrated; Retrofit RS485 interface card
- 4-pin wiring
- Communication address must be allocated
- Installation steps
 - Allocate communication address
 - Switch off the inverters and Solar-Log™
 - Install the RS485 interface in the inverter
 - Connect inverters to the Solar-Log™
 - Connect the inverters to each other

Allocate communication address

- Recommendation: Continuous numbering starting with 1.
- Setting: Using the DIP switch on the interface card.

Before installing the RS485 interface card:

- ▶ Allocate the communication address using the 8 interface card DIP switches:

Example - Communication address 1:

On								
Off								
DIP switch								

Example - Communication address 2:

On								
Off								
DIP switch								

Example - Communication address 3:

On								
Off								
DIP switch								

Example - Communication address 4:

On								
Off								
DIP switch								

Example - Communication address 5:

On								
Off								
DIP switch								

You will find more information at:
http://en.wikipedia.org/wiki/Binary_number.

**Installing the RS485 interface
 Procedure**

- ▶ Install the RS485 interface in the inverter in accordance with the interface card installation instructions.

Connect inverters to the Solar-Log™

The wiring is done using a

- ready-made BKL2 data cable (optional extra; not supplied)
- or
- self-made, shielded 4 wire data cable and terminal block connector.

Procedure

1. Open the inverter as shown in the inverter's instructions.
2. Pull the free wires through the wire opening in the inverter.
3. If you are making the cable yourself, connect the wires as shown in the following diagram:

Solar-Log™ terminal strip connector	Solar-Log Base RS485 (A) / (B)	Inverter terminal strip
Terminal		PIN
▶ 1 (Data+)	▶ (A) 6 or (B) 10 (Data+)	▶ R+
▶ 1 (Data+)	▶ (A) 6 or (B) 10 (Data+)	▶ T+
▶ 4 (Data-)	▶ (A) 9 or (B) 13 (Data-)	▶ R-
▶ 4 (Data-)	▶ (A) 9 or (B) 13 (Data-)	▶ T-

4. Close the inverter if no other inverters are to be connected.
5. Insert the terminal block connector into the Solar-Log™ RS485 socket.

Connect the inverters to each other

- Connect using a 4 wire, shielded data cable
- Where to connect: Terminal strip inside the inverter on the retrofitted RS485 interface card

Procedure

1. Open the inverter as shown in the inverter's instructions
2. Connect terminals R+, T+, R- and R+ of inverter 1 to the corresponding terminals on inverter 2
3. Connect the other inverters to each other in the same way
4. Close inverters

67 Power-One/Aurora

67.1 Power-One/Aurora

Termination	Addressing	Interface
Switch	Yes	RS485

Overview

- Interface integrated
 - Sometimes different interfaces are used for indoor and outdoor models
- Where to connect: RS485 terminal strips inside the inverter
- 3-pin wiring
- Communication address must be allocated
- Installation steps
 - Switch off the inverters and Solar-Log™
 - Connect inverters to the Solar-Log™
 - Connect the inverters to each other
 - Allocate communication address

Connect inverters to the Solar-Log™

The wiring is done using a

- ready-made Power One data cable (optional extra; not supplied)
- or
- self-made, shielded 3 wire data cable and terminal block connector.

Procedure

1. Open the inverter as shown in the inverter's instructions.
2. Pull the free wires through the wire opening in the inverter.
3. If you are making the cable yourself, connect the wires as shown in the following diagram:

Solar-Log™ terminal strip connector	Solar-Log Base RS485 (A) / (B)	Inverter terminal strip (Outdoor)
Terminal		Terminal
▶ 1 (Data+)	▶ (A) 6 or (B) 10 (Data+)	▶ +T/R (PC)
▶ 3 GND	▶ (A) 8 or (B) 12 GND	▶ GND
▶ 4 (Data-)	▶ (A) 9 or (B) 13 (Data-)	▶ -T/R (PC)

4. If no further inverter connected, terminate the inverter:
 - In the inverter, set the DIP switch for the terminal resistor to ON.
5. Close the inverter if no other inverters are to be connected.
6. Insert the terminal block connector into the Solar-Log™ RS485 socket.

Connect the inverters to each other

- Connect using a 3 pin, shielded data cable.
- Where to connect: RS485 terminal strips inside the inverter

Procedure

1. Open the inverter as shown in the inverter's instructions.
2. Connect terminals +T/R, -T/R and RTN of inverter 1 to the corresponding terminals on inverter 2.
3. Connect the other inverters to each other in the same way.
4. Terminate the last inverter.
Set the DIP switch for the terminal resistor to ON.
5. Close inverters.

Allocate communication address

- Recommendation: Continuous numbering from Solar-Log™, starting from 2 (not 1!).
- Setting: Using the inverter operating display
- Procedure: Start according to the inverter's instructions

68 PrimeVOLT

68.1 PrimeVOLT

Termination	Addressing	Interface
DIP switch	Yes	RS485

Overview

- Integrated interface
- Where to connect: Terminal strip inside the inverter
- 2-pin wiring
- Communication address must be allocated
- Installation steps
 - Switch off the inverters and Solar-Log™
 - Connect inverters to the Solar-Log™
 - Connect the inverters to each other
 - Allocate communication address

Connect inverters to the Solar-Log™

The wiring is done using a

- self-made, shielded 2 wire data cable with a terminal block connector.

Procedure

1. Open the inverter as shown in the inverter's instructions.
2. If you are making the cable yourself, connect the wires as shown in the following diagram:

Solar-Log™ terminal strip connector	Solar-Log Base RS485 (A) / (B)	Terminal strip inside the inverter
Terminal		RS485 terminal
▶ 1 (Data+)	▶ (A) 6 or (B) 10 (Data+)	▶ 1 T/R 1+
▶ 4 (Data-)	▶ (A) 9 or (B) 13 (Data-)	▶ 2 T/R 1-

3. If no further inverter connected, terminate the inverter:
In the inverter, set the DIP switch for the terminal resistor to ON.
4. Close inverters.
5. Insert the terminal block connector into the Solar-Log™ RS485 socket.

Connect the inverters to each other

- Where to connect: Terminal strip inside the inverter
- 2-pin wiring

Procedure

1. Open the inverter as shown in the inverter's instructions.
2. If you are making the cable yourself, connect the wires as shown in the following diagram:

Terminal strip inside the inverter	Terminal strip inside the inverter
RS485 terminal	RS485 terminal
▶ 1 T/R 1+	▶ 1 T/R 2+
▶ 2 T/R 1-	▶ 2 T/R 2-

3. Connect terminals A and B on inverter 1 to the corresponding terminals on inverter 2.
4. Connect the other inverters to each other in the same way.
5. Terminate the last inverter.
Set the DIP switch for the terminal resistor to ON.
6. Close inverters.
7. Insert the terminal block connector into the Solar-Log™ RS485 socket.

Allocate communication address

- Recommendation: Continuous numbering starting with 1.
- Setting: Using the inverter DIP switch
- Procedure: Start according to the inverter's instructions

69 PVPowered

69.1 PV Powered – central inverter RS485

Termination	Addressing	Interface
Jumper	Yes	RS485

Overview

- Integrated interface
- Where to connect: Modbus Slave socket on interface card
- 3-pin wiring
- Communication address must be allocated
- Installation steps
 - Switch off the inverters and Solar-Log™
 - Connect inverters to the Solar-Log™
 - Set the address of the inverters.
 - Connect the inverters to each other

Connect inverters to the Solar-Log™

The wiring is done using a

- self-made 3 pin connection cable and terminal block connector.



Note

The transfer rate for Modbus (RS485) on delivery to the customer is set to 9600bps. Please check these settings.

Procedure

1. Open the inverter as shown in the inverter's instructions.
2. Pull the free wires through the wire opening in the inverter.
3. If you are making the cable yourself, connect the wires as shown in the following diagram:

Solar-Log™ terminal strip connector	Solar-Log Base RS485 (A) / (B)	RJ45 inverter
Terminal		PIN
▶ 1 (Data+)	▶ (A) 6 or (B) 10 (Data+)	▶ 2 - D+
▶ 3 GND	▶ (A) 8 or (B) 12 GND	▶ 1 - GND
▶ 4 (Data-)	▶ (A) 9 or (B) 13 (Data-)	▶ 3 - D-

4. If no further inverter connected, terminate the inverter:
Inside the inverter set the supplied jumper from „J4“ to „J5“.
5. Setting the address for the inverter: Set SW1 to „0“ and SW2 to „1“ in order to set the parameters for the inverter with the address „01“.
6. Close the inverter if no other inverters are to be connected.
7. Insert the terminal block connector into the Solar-Log™ RS485 socket.

Connect the inverters to each other

The wiring is done using a

- self-made connection cable and terminal block connector.
- Where to connect: Terminal strip inside the inverter

Procedure

1. Open the inverter as shown in the inverter's instructions.
2. Pull the free wires through the wire opening in the inverter.
3. If you are making the cable yourself, connect the wires as shown in the following diagram:

Solar-Log™ terminal strip connector	Solar-Log Base RS485 (A) / (B)	RJ45 inverter
Terminal		PIN
▶ 1 (Data+)	▶ (A) 6 or (B) 10 (Data+)	▶ 2 - D+
▶ 3 GND	▶ (A) 8 or (B) 12 GND	▶ 1 - GND
▶ 4 (Data-)	▶ (A) 9 or (B) 13 (Data-)	▶ 3 - D-

4. Connect terminals GND, D+ and D- of inverter 1 to the corresponding terminals on inverter 2.
5. Connect the other inverters to each other in the same way.
6. Terminate the last inverter in accordance with the manufacturer's specifications.
Inside the inverter set the supplied jumper from "J4" to "J5"
7. Address the individual inverters in accordance with the manufacturer's handbook: Inverter 1 should be the inverter that is directly connected to the Solar-Log™. To this end, set SW1 to "0". Depending on the position of the inverter in the bus, SW2 should be set to 1-9.
If more than 9 inverters are to be connected to one Solar-Log™, please read the manufacturer's instructions for further information.
8. Close the inverter if no other inverters are to be connected.
9. Insert the terminal block connector into the Solar-Log™ RS485 socket.

69.2 PV Powered - string inverter

Termination	Addressing	Interface
No	Yes	LAN

Overview

- Integrated interface
- Connected using network cable (patch cable) and Ethernet router or switch
- Communication address must be allocated.
- Installation steps
 - Allocate communication address
 - Connect inverters to the Solar-Log™
 - Connect the inverters to each other

Allocate communication address

- Recommendation: Continuous numbering starting with 1.
- Setting: Using the inverter operating display
- Procedure: Before connecting to the Ethernet router or switch and allocating the IP address.

Assigning IP addresses

- Please select an IP address with the same class C subnet as the Solar-Log™.
For example: The Solar-Log™ has the IP address 192.168.178.49.
The inverter in this case has to have a free IP address in the same range (from 192.168.178.1 to 192.168.178.254).
- Procedure: Start according to the inverter's instructions

Connect inverters and the Solar-Log™.

The wiring is done using a

- network cable (patch cable) and the
- Ethernet router or switch.

Procedure

1. Set different unit IDs on each inverter in accordance with the inverter's instructions.
2. Connect the Solar-Log™ and the inverter to the router or switch.

70 Q3

70.1 Q3 3000-6600

Termination	Addressing	Interface
Yes	Yes	RS485



Note

The same protocol must be selected on both devices In order to ensure correct communication between the Solar-Log™ and the inverters.

Protocol selection for device detection:

- Q3: Protocol 1
- Q3: Protocol 9

The following types are to be connected according to this diagram:

- QX3000
- QX4200
- OX5500
- QX6600

Overview

- Integrated interface
- Where to connect: Between the COM round sockets on the outside of the inverter
- 3-pin wiring
- Communication address must be allocated
- Installation steps
 - Switch off the inverters and Solar-Log™
 - Connect inverters to the Solar-Log™
 - Connect the inverters to each other
 - Allocate communication address

Connect inverters to the Solar-Log™

Connecting is done using a self-made, shielded 3 wire data cable and terminal block connector.

Procedure

1. Connect wires as shown in the diagram below.

Solar-Log™ terminal strip connector	Solar-Log Base RS485 (A) / (B)	Inverter terminal strip
Terminal		Terminal
▶ 1 (Data+)	▶ (A) 6 or (B) 10 (Data+)	▶ 1 (RS485-A)
▶ 3 GND	▶ (A) 8 or (B) 12 GND	▶ 3 (GND)
▶ 4 (Data-)	▶ (A) 9 or (B) 13 (Data-)	▶ 2 (RS485-B)

2. If no further inverter is connected, terminate the inverter according to the instructions for the inverter.
3. Insert the terminal block connector into the Solar-Log™ RS485 socket.

Connect the inverters to each other

- Connect using a self-made daisy chain cable.
- Where to connect: X2 connection socket on outside of the inverter.

Procedure

1. Insert the plug into socket X2 on inverter 1.
2. Insert the other end of the wire into the X2 socket on inverter 2.
3. Connect the other inverters to each other in the same way.
4. Terminate the last inverter in accordance with the inverter instructions.

Allocate communication address

- Recommendation: Continuous numbering starting with 1.
- Default settings on the inverter: Communication address 1
- Setting: Using the inverter operating display Notes
 - Select Address for ProLog in the Communication / RS485 menu
 - Set Protocol type COM 1 to 9 in the Communication menu
- Procedure: Start according to the inverter's instructions

70.2 Q3 12000-14000

Termination	Addressing	Interface
Yes	Yes	RS485



Note

The same protocol must be selected on both devices In order to ensure correct communication between the Solar-Log™ and the inverters.

Protocol selection for device detection:

- Q3: Protocol 1
- Q3: Protocol 9

The following types are to be connected according to this diagram:

- QX12000
- QX14000

Overview

- Integrated interface
- Where to connect: Round pin plug on the outside of the inverter
- 3-pin wiring
- Communication address must be allocated
- Inverters must be grounded otherwise this could lead to problems with inverter detection
- Installation steps
 - Switch off the inverters and Solar-Log™
 - Connect inverters to the Solar-Log™
 - Connect the inverters to each other
 - Allocate communication address

Connect inverters to the Solar-Log™

- self-made, shielded 3 wire data cable and terminal block connector.

Procedure

1. If you are making the cable yourself, connect the wires as shown in the following diagram:

Solar-Log™ terminal strip connector	Solar-Log Base RS485 (A) / (B)	Inverter terminal strip
Terminal		Terminal
▶ 1 (Data+)	▶ (A) 6 or (B) 10 (Data+)	▶ 2 - Data +
▶ 3 GND	▶ (A) 8 or (B) 12 GND	▶ 3 - Ground
▶ 4 (Data-)	▶ (A) 9 or (B) 13 (Data-)	▶ 4 - Data -

2. Terminate pin 1 on the terminal block connector and pin 4 on the Solar-Log™ using the 120 Ω terminal resistor.
3. Terminate on the inverter in accordance with the manufacturer's handbook.
4. Insert the terminal block connector into the Solar-Log™ RS485 socket.

Connect the inverters to each other

- Connection in the master-slave data network using an 1:1 cable with M12 plug connector (available as an optional extra from Q3). Sockets X6 and X7 are connected to each other electrically.
- Where to connect: Round pin plug on the outside of the inverter.

Procedure

1. Insert the plug into the X6 socket on inverter 1.
2. Insert the other end of the wire into the X7 socket on inverter 2.
3. Connect the other inverters to each other in the same way.
4. Terminate the last inverter according to the manufacturer's instructions.

Allocate communication address

- Setting: Using the inverter's control panel.
Recommendation: Continuous numbering starting with 1.
- Procedure: Start according to the inverter's instructions

70.3 QX3

Termination	Addressing	Interface
No	Yes	LAN

Select "Q3:QX3" during the device detection

The following types are to be connected according to this diagram:

- QX³4000
- QX³5000
- QX³6000
- QX³7000
- QX³8000
- QX³10000
- QX³13000
- QX³15000
- QX³18000

Overview

- Integrated interface
- The inverter's IP address has to be assigned.
- Connected using network cable (patch cable) and Ethernet router or switch
- Installation steps
 - The inverter's has to be assigned a static IP address.
 - Switch off the inverters and Solar-Log™
 - Connect inverters to the Solar-Log™ (RJ45).
 - Connect the inverters to each other (RJ45).

Connect inverters to the Solar-Log™

The wiring is done using a

- network cable (patch cable/crossover cable) and the
- Ethernet router or switch.

Connect the inverters to each other

The inverters are connected together using the RJ45 interface and, if needed, a router or switch.

Connection setup according to the inverter's instructions.

Assigning IP addresses

- A static IP address has to be assigned to the inverter via the display.
- Please select an IP address with the same class C subnet as the Solar-Log™.
For example: The Solar-Log™ has the IP address 192.168.178.49.
The inverter in this case has to have a free IP address in the same range (from 192.168.178.1 to 192.168.178.254).
- Procedure: Start according to the inverter's instructions



Note

Each inverter has to be individually reachable via the network. For this, the network interface has to be activated for every inverter (select "Activate LAN" under the LAN menu) and the inverter needs to be connected to the local access network (LAN) via a switch.

Detection via the Solar-Log™ WEB Interface

- For detection on the Solar-Log™, select the device class under the menu Configuration | Device | Definition | Interface with the plus symbol and then select "Q3:QX3" as the manufacturer. Confirm your selection with OK.
- Save your selections and then start the Device Detection under Configuration | Device | Detection.

Detection from the Solar-Log 1200

- When using the Solar-Log 1200, the detection can also be started from the display. Select the settings Start ► Initial Configuration ► Page 2 „Device“ ► Add and select the manufacturer "Q3:QX3" from there. Save and start the Device Detection.



Note for feed-in management

Supported by Solar-Log
starting with inverter firmware version 19



Note

Using the inverter's web interface, select "External control via network interface" under "Settings ► Installation ► Grid Company Settings ► Power Reduction," and under "cos(phi) Settings."

70.4 QY

Termination	Addressing	Interface
Yes	Yes	RS485



Note

The same protocol must be selected on both devices in order to ensure correct communication between the Solar-Log™ and the inverters.

Protocol selection for device detection:

- Q3: Protocol 1
- Q3: Protocol 9

Supported models:

- QY3000/1
- QY3000
- QY4000
- QY5000

Overview

- Integrated interface
- Where to connect: Round pin plug on the outside of the inverter.
- 3-pin wiring
- Communication address must be allocated.
- Inverters must be grounded otherwise this could lead to problems with inverter detection.
- Installation steps
 - Switch off the inverters and Solar-Log™
 - Connect inverters to the Solar-Log™
 - Connect the inverters to each other
 - Allocate communication address

Connect inverters to the Solar-Log™

- ready-made data cable (optional extra; not supplied)
- or
- self-made, shielded 3 wire data cable and terminal block connector.

Procedure

1. If you are making the cable yourself, connect the wires as shown in the following diagram:

Solar-Log™ terminal strip connector	Solar-Log Base RS485 (A) / (B)	Inverter terminal strip
Terminal		Terminal
▶ 1 (Data+)	▶ (A) 6 or (B) 10 (Data+)	▶ 2 - Data +
▶ 3 GND	▶ (A) 8 or (B) 12 GND	▶ 3 - Ground
▶ 4 (Data-)	▶ (A) 9 or (B) 13 (Data-)	▶ 4 - Data -

2. Terminate pin 1 on the terminal block connector and pin 4 on the Solar-Log™ using the 120 Ω terminal resistor.

3. Terminate on the inverter in accordance with the manufacturer's handbook.
4. Close the inverter if no other inverters are to be connected.
5. Insert the terminal block connector into the Solar-Log™ RS485 socket.

Connect the inverters to each other

- Connection in the master-slave data network using an 1:1 cable with M12 plug connector.
- Sockets X6 and X7 are connected to each other electrically.
- Where to connect: Round pin plug on the outside of the inverter.

Procedure

1. Insert the plug into the X6 socket on inverter 1.
2. Insert the other end of the wire into the X7 socket on inverter 2.
3. Connect the other inverters to each other in the same way.
4. Terminate the last inverter according to the manufacturer's instructions.

Allocate communication address

- Setting: Using the inverter's control panel, parameter 89 in the communication menu.
Recommendation: Continuous numbering starting with 1.
Set this in the SSP address menu item.
- Procedure: Start according to the inverter's instructions



Note

The mode Fixed cos Phi has to be set according to the manufacturer's specifications for all of the inverters to use active and reactive power management.

71 RCT Power

71.1 RCT Power

Termination	Addressing	Interface
Yes	Yes	RS485

Selections available under: „RCT Power“

Supported models:

- Power Inverter 4.0, Power Inverter 5.0, Power Inverter 6.0

Overview

- Integrated interface.
- Where to connect: Terminal strip X102 inside the inverter.
- 2-pin wiring.
- The communication address has to be assigned.
- Installation steps:
 - Switch off the inverters and the Solar-Log™.
 - Connect the inverters to the Solar-Log™.
 - Assign the communication address.
 - Terminate inverter.

Connect the inverters to the Solar-Log™

The wiring is done using a:

- self-made, shielded 2-wire data cable and terminal block connector.



Note

The RCT PowerApp has to be downloaded from the PlayStore in order to adjust the inverter's address. Wire connections according to the app instructions.

Procedure:

1. Open the inverter according to the inverter's instructions.
2. Connect the wires for the cable connection as shown in the following diagram:

Solar-Log™ terminal strip connector	Solar-Log Base RS485 (A) / (B)	Terminal strip X102
Terminal		Pin
▶ 1 (Data+)	▶ (A) 6 or (B) 10 (Data+)	▶ +
▶ 4 (Data-)	▶ (A) 9 or (B) 13 (Data-)	▶ -

3. Terminate the inverter according to the inverter's instructions if no additional inverters are to be connected.
4. Close the inverter if no other inverters are to be connected.
5. Insert the terminal block connector into the Solar-Log™ RS485 socket.

Connect the inverters to each other.

- Where to connect: Terminal strip X102 inside the inverter.
- Connect the inverters to each other according to the inverter instructions.

Assign the communication address

- Recommendation: Continuous numbering starting with 1 going to 250.
- Setting: via RCT PowerApp.
- Procedure: According to the RCT PowerApp instructions.



Note!

A maximum of 32 devices can be connected per RS485 bus.

Note on the inverter:

Please note that the latest software version (min. 4733) is installed on the RCT Power device and the RS485 working mode is set to „Modbus Slave“ in the APP. (default setting)

To do this, please proceed as follows:

Start „RCT Power App“ and continue:

Click on „  “ ► Log in, password „Installer“ ► Device ► Settings ► Interfaces ► RS485.

Select the option „Modbus Slave“ under „RS485 working mode“ and enter the communication address of the inverter under „RS485 address“. After completing the setting, press „Flash“.

72 REFUSOL

72.1 REFUSOL

Termination	Addressing	Interface
Terminating plug	Yes	RS485



Note

The same protocol must be selected on both devices In order to ensure correct communication between the Solar-Log™ and the inverters.

Protocol selection for device detection:

- RefuSol: Native (for PM control)
- RefuSol: Generic

Overview

- Integrated interface
- Where to connect: RJ45 socket on the bottom of the inverter
- 2-pin wiring
- Communication address must be allocated
- Installation steps
 - Switch off the inverters and Solar-Log™
 - Connect inverters to the Solar-Log™
 - Connect the inverters to each other
 - Allocate communication address

Instructions for older Solar-Log™/ Refu installations

- Set compatibility



Note

To use active and reactive power management, all of the inverters need to be set to:

- ▶ Protocol 1
- ▶ 57600 baud
- ▶ Parameter 1164 = 2

Connect inverters to the Solar-Log™

The wiring is done using a

- self-made, shielded 2 wire data cable and terminal block connector.

Procedure

1. Connect wires as shown in the diagram below.

Solar-Log™ terminal strip connector	Solar-Log Base RS485 (A) / (B)	RS485 inverter socket
Terminal		PIN
▶ 1 (Data+)	▶ (A) 6 or (B) 10 (Data+)	▶ 2
▶ 4 (Data-)	▶ (A) 9 or (B) 13 (Data-)	▶ 3

2. If no further inverter connected, terminate the inverter:
On the sockets "RS485 OUT" with REFUSOL round plugs bypass the connections PIN1 to PIN2 and PIN3 to PIN4.
3. Close the inverter if no other inverters are to be connected.
4. Insert the terminal block connector into the Solar-Log™ RS485 socket.

Connect the inverters to each other

- Connect using
 - 2-wire, shielded data cable and
 - 4-pin "SACC-M12MS-4SC" plug (two plugs included with the inverter)
- Where to connect: RS485 sockets on the bottom of the inverter.

The RS485 IN and OUT sockets are each double connections so that the wiring can be continued to the next inverter.

Procedure

1. Connect the data cable to the "SACC-M12MS-4SC" plug as shown in the inverter's instructions.
2. Insert one plug into the OUT (X14B) socket of inverter 1.
3. Insert the other end of the wire into the IN socket (X15B) on inverter 2.
4. Connect the other inverters to each other in the same way.
5. Terminate the last inverter.
On the sockets "RS485 OUT" with REFUSOL round plugs bypass the connections PIN1 to PIN2 and PIN3 to PIN4.
6. Close inverters.

Allocate communication address

- Recommendation: Continuous numbering starting with 1; highest possible address: 31

Set the following parameters on the inverter's operating display:

1. Press "F1", select **Numerical list**, press "ENTER".
2. Set parameter number **2000** [password protection], press "ENTER" twice.
3. Enter **72555**, press "ENTER"
4. Set parameter number **0406**, press "ENTER"
5. Select sub parameter **0406,3**, press "ENTER"
6. Enter figure for communication x
[x = continuous numbering starting with 1; highest possible address: 31], press "ENTER". 31], press "ENTER".

After configuring on the display:

1. Using the installed DC isolating switch turn the inverters on and off briefly so that the settings are activated.
2. Set the date and time on the inverter as shown in the inverter instructions.

Older Solar-Log™ / Refusol installations: Set compatibility

With older Solar-Log™ / Refusol installations the inverter had to be set with additional parameters for Solar-Log™ compatibility. This is only still necessary if an inverter has been replaced because it was faulty or if the system is extended. In these cases the new inverters must also be provided with the extended parameters again.

The extended parameters are only available starting from inverter firmware version 800.2.20 or higher. The firmware version can be checked on the inverter menu:

► "F1" / Numerical list / Parameters 1.1 to 1.3

Current firmware versions and update instructions can be found at www.refu-elektronik.com/en.

Set the following parameters on the inverter's operating display:

1. Press "F1"
2. Select Numerical list, press "ENTER".
3. Set parameter number 0407 press "ENTER"
4. Select sub parameter 0407,3, press "ENTER"
5. Enter "2"
[Communication type RS485: Solarlog], press "ENTER".31], press "ENTER".
6. Set parameter number 0420 press "ENTER"
7. Select sub parameter 0420,3, press "ENTER"
8. Enter the numerical value 9600, press "ENTER"
9. Using the installed DC isolating switch turn the inverters on and off briefly so that the settings are activated.



Note

The numerical value "2" under point 5 in the settings refers to the old Solar-Log protocol and the value "1" to the native protocol for active and reactive power control.

The value under point 8 refers to the inverter's baud rate and is 9600 for the old Solar-Log protocol and 57600 for the native protocol.

Allocate communication address

- Recommendation: Continuous numbering starting with 1.
- Setting: Using the inverter operating display
- Procedure: Start according to the inverter's instructions



Note

To use active and reactive power management, all of the inverters need to be set to:

- Protocol 1
- 57600 baud
- Parameter 1164 = 2



Note

A maximum of 31 inverters can be connected per RS485 bus.

73 REP

73.1 REP

Termination	Addressing	Interface
DIP switch	Yes	RS485

Overview

- Integrated interface
- Where to connect: Terminal strip inside the inverter
- 2-pin wiring
- Communication address must be allocated.
- Installation steps
 - Switch off the inverters and Solar-Log™
 - Connect inverters to the Solar-Log™
 - Connect the inverters to each other
 - Allocate communication address

Connect inverters to the Solar-Log™

The wiring is done using a

- self-made, shielded 2 wire data cable with a terminal block connector.

Procedure

1. Open the inverter as shown in the inverter's instructions.
2. If you are making the cable yourself, connect the wires as shown in the following diagram:

Solar-Log™ terminal strip connector	Solar-Log Base RS485 (A) / (B)	Terminal strip inside the inverter
Terminal		RS485 terminal
▶ 1 (Data+)	▶ (A) 6 or (B) 10 (Data+)	▶ 1 T/R 1+
▶ 4 (Data-)	▶ (A) 9 or (B) 13 (Data-)	▶ 2 T/R 1-

3. If no further inverter connected, terminate the inverter:
In the inverter, set the DIP switch for the terminal resistor to ON.
4. Close inverters.
5. Insert the terminal block connector into the Solar-Log™ RS485 socket.

Connect the inverters to each other

- Where to connect: Terminal strip inside the inverter
- 2-pin wiring

Procedure

1. Open the inverter as shown in the inverter's instructions.
2. If you are making the cable yourself, connect the wires as shown in the following diagram:

Terminal strip inside the inverter	Terminal strip inside the inverter
RS485 terminal	RS485 terminal
▶ 1 T/R 1+	▶ 1 T/R 2+
▶ 2 T/R 1-	▶ 2 T/R 2-

3. Connect terminals A and B on inverter 1 to the corresponding terminals on inverter 2.
4. Connect the other inverters to each other in the same way.
5. Terminate the last inverter.
Set the DIP switch for the terminal resistor to ON.
6. Close inverters.
7. Insert the terminal block connector into the Solar-Log™ RS485 socket.

Allocate communication address

- Recommendation: Continuous numbering starting with 1.
- Setting: Using the inverter DIP switch.
- Procedure: Start according to the inverter's instructions.

74 Reverberi

74.1 Reverberi (EDI Series)

Termination	Addressing	Interface
Yes	Yes	RS485

Overview

- Integrated interface
- Where to connect: Terminal strip inside the inverter
- 4-pin wiring
- Communication address must be allocated.
- Installation steps
 - Switch off the inverters and Solar-Log™
 - Connect inverters to the Solar-Log™
 - Allocate communication address
 - Terminate inverter

Connect inverters to the Solar-Log™

The wiring is done using a

- ready-made data cable (optional extra; not supplied)

Procedure:

1. Open the inverter as shown in the inverter's instructions.
2. Pull the free wires through the wire opening in the inverter.
3. If you are making the cable yourself, connect the wires as shown in the following diagram:

Solar-Log™ terminal strip connector	Solar-Log Base RS485 (A) / (B)	Terminal strip inverter
Terminal		PIN
▶ 1 (Data+)	▶ (A) 6 or (B) 10 (Data+)	▶ 5
▶ 1 (Data+)	▶ (A) 6 or (B) 10 (Data+)	▶ 7
▶ 4 (Data-)	▶ (A) 9 or (B) 13 (Data-)	▶ 4
▶ 4 (Data-)	▶ (A) 9 or (B) 13 (Data-)	▶ 6

4. If no further inverter connected, terminate the inverter:
5. Close the inverter if no other inverters are to be connected.
6. Insert the terminal block connector into the Solar-Log™ RS485 socket.

Connect the inverters to each other

- Where to connect: Terminal strip inside the inverter
- 4-pin wiring

Procedure

1. Open the inverter as shown in the inverter's instructions.
2. Connect the other inverters to each other in the same way.
3. Terminate the last inverter.
4. Close inverters.
5. Allocate communication address.
6. Recommendation: Continuous numbering from Solar-Log™, starting from 2 (not 1!). Last address at 247.
7. Setting: Using the inverter operating display.
8. Procedure: Start according to the inverter's instructions.



Note

A maximum of 31 inverters can be connected per RS485 bus.

75 Riello

75.1 Riello

Termination	Addressing	Interface
Yes	No	RS422

Overview

- Interface not integrated; Retrofit RS485 interface card.
- 4-pin cable – only on RS485/422 B or C connection of the Solar-Log™
- Communication address does not have to be assigned.
- Multi-string technology

Riello inverters are fitted with 1 or 3 MPP trackers depending on the model. Each string input is monitored separately and ideally adjusted to the connected modules.

The Solar-Log™ automatically detects how many inverters and strings are active during inverter detection.



Note

The order in which the inverters are displayed in the Solar-Log™ after detection is random. We strongly recommend that you change the order of the inverters immediately after detection at startup, in the [Configuration | Devices | Configuration | Order](#) dialog box.

- ▶ The inverters can be identified using the displayed serial number.

- Installation steps
 - Switch off the inverters and Solar-Log™
 - Install the RS485 interface in the inverter
 - Connect inverters to the Solar-Log™
 - Connect the inverters to each other

Installing the RS485 interface Procedure

- ▶ Insert the RS485 interface in the bottom of the inverter in accordance with the interface card installation instructions and screw in.

Connect inverters to the Solar-Log™

The wiring is done using a

- ready-made data cable (optional extra; not supplied)
- or
- self-made, shielded 4 wire data cable and terminal block connector.



Note

Only connect inverter using the RS485/422 B or C interface.

Procedure

1. Open the inverter as shown in the inverter's instructions.
2. Pull the free wires through the wire opening in the inverter.
3. If you are making the cable yourself, connect the wires as shown in the following diagram:

Solar-Log™ terminal strip connector	Solar-Log Base RS422	Inverter terminal strip
Terminal		Terminal
▶ 1 (T/RX+)	▶ 6 (T/RX+)	▶ R+
▶ 4 (T/RX-)	▶ 9 (T/RX-)	▶ R-
▶ 5 (R/TX+)	▶ 10 (R/TX+)	▶ T+
▶ 6 (R/TX-)	▶ 13 (R/TX-)	▶ T-

4. If no further inverter is connected, terminate the inverter according to the instructions for the inverter.
5. Close the inverter if no other inverters are to be connected.
6. Insert the terminal block connector into the Solar-Log™ RS485/422 B or C socket.

Connect the inverters to each other

- Connect using a 4 wire, shielded data cable
- Where to connect: Terminal strip inside the inverter (on the retrofitted RS485 interface)

Procedure

1. Open the inverter as shown in the inverter's instructions.
2. Connect terminals R+, R-, T+ and T- of inverter 1 to the corresponding terminals on inverter 2.
3. Connect the other inverters to each other in the same way.
4. Terminate the last inverter according to the inverter instructions.
5. Close inverters.

76 Rishabh Instruments Pvt. Ltd.

76.1 Rishabh - Radius

Termination	Addressing	Interface
-	Yes	RS485

Selections available under Rishabh; Type: „Radius“; Interface: „RS485“

Supported models:

- 10KwAE 1mppt
- 10KwAE 2mppt
- 12KwAE 1mppt
- 12KwAE 2mppt
- 15KwAE 2mppt
- 18KwAE 2mppt
- 20KwAE 2mppt
- 20KwAE 3mppt
- 10KwEE 1mppt
- 15KwEE 1mppt
- 20KwEE 1mppt

Overview

- Integrated interface.
- Where to connect: Terminal strip inside the inverter.
- 2-pin wiring.
- The communication address has to be assigned.
- Installation steps:
 - Switch off the inverters and the Solar-Log™.
 - Connect the inverters to the Solar-Log™.
 - Assign the communication address.
 - Terminate inverter.

Connect the inverters to the Solar-Log™

The wiring is done using a:

- self-made, shielded 2-wire data cable and terminal block connector.



Note

Rishabh have two RS485 connections (A and B). Due to the required baud rate of 38400, Solar-Log™ only supports the RS485 A connection.

Procedure:

1. Open the inverter according to the inverter's instructions.
2. Connect the wires for the cable connection as shown in the following diagram:

Solar-Log™ terminal strip connector	Solar-Log Base RS485 (A) / (B)	Terminal strip inverter RS485 A
Terminal		PIN assignments for RS485 A
▶ 1 (Data+)	▶ (A) 6 or (B) 10 (Data+)	▶ A1
▶ 4 (Data-)	▶ (A) 9 or (B) 13 (Data-)	▶ B1

3. Terminate the inverter according to the inverter's instructions if no additional inverters are to be connected.
4. Close the inverter if no other inverters are to be connected.
5. Insert the terminal block connector into the Solar-Log™ RS485 socket.

Connect the inverters to each other

- Where to connect: Terminal strip inside the inverter.
- Connect the inverters to each other according to the inverter instructions.

Assign the communication address

- Recommendation: Continuous numbering starting with 1 going to 50.
- Setting: Using the inverter's operating display.
- Procedure: Start according to the inverter's instructions.

77 SAJ

77.1 Suntrio/Sununo/R5

Termination	Addressing	Interface
-	Yes	RS485

Select „SAJ“ during the inverter detection.

Supported series:

- Suntrio
- Sununo
- R5

Overview

- Integrated interface.
- Where to connect: Round sockets on the outside of the inverter.
- 3-pin wiring.
- Communication address must be allocated.
- Installation steps:
 - Switch off the inverters and Solar-Log™.
 - Connect inverters to the Solar-Log™.
 - Connect the inverters to each other.
 - Allocate communication address.

Connect inverters to the Solar-Log™

The wiring is done using a

- self-made, shielded 3 wire data cable with round plug and terminal block connector.

Procedure

1. If you are making the cable yourself, connect the wires as shown in the following diagram:

Solar-Log™ terminal strip connector	Solar-Log Base RS485 (A) / (B)	Inverter round socket
Terminal		PIN
▶ 1 (Data+)	▶ (A) 6 or (B) 10 (Data+)	▶ PIN A
▶ 3 GND	▶ (A) 8 or (B) 12 GND	▶ GND
▶ 4 (Data-)	▶ (A) 9 or (B) 13 (Data-)	▶ PIN B

2. Insert the round plug into any COM round socket on the inverter.
3. Insert the terminal block connector into the Solar-Log™ RS485 socket.

Connect the inverters to each other

- Wiring using 3 pin cable with round plugs.
- Where to connect: Round sockets on the outside of the inverter.

Procedure

1. Insert the round plug into any round socket on inverter 1.
2. Insert the other end of the cable into any round socket on inverter 2.
3. Connect the other inverters to each other in the same way.
4. Insert the terminal block connector into the Solar-Log™ RS485 socket.

Allocate communication address

- Recommendation: Continuous numbering starting with 1.
- Address range: 1 - 247.
- Setting: Using the inverter operating display.
- Procedure: Start according to the inverter's instructions.

78 SALICRU

78.1 SALICRU EQX

Termination	Addressing	Interface
Yes	No	RS422

Overview

- Interface not integrated; Retrofit RS485 interface card.
- 4-pin cable – only on RS485/422 B or C connection of the Solar-Log™
- Communication address does not have to be assigned
- Multi-string technology

The inverters are fitted with 1 or 3 MPP trackers depending on the model. Each string input is monitored separately and ideally adjusted to the connected modules.

The Solar-Log™ automatically detects how many inverters and strings are active during inverter detection.



Note

The order in which the inverters are displayed in the Solar-Log™ after detection is random. We strongly recommend that you change the order of the inverters immediately after detection at startup, in the [Configuration | Devices | Configuration | Order](#) dialog box.

- ▶ The inverters can be identified using the displayed serial number.

- Installation steps
 - Switch off the inverters and Solar-Log™
 - Install the RS485 interface in the inverter
 - Connect inverters to the Solar-Log™
 - Connect the inverters to each other

Procedure

- ▶ Insert the RS485 interface in the bottom of the inverter in accordance with the interface card installation instructions and screw in.

Connect inverters to the Solar-Log™

The wiring is done using a

- ready-made BKL1 data cable (optional extra; not supplied)
- or
- self-made, shielded 4 wire data cable and terminal block connector.



Note

Only connect inverter using the RS485/422 B or C interface.

Procedure

1. Open the inverter as shown in the inverter's instructions.
2. Pull the free wires through the wire opening in the inverter.
3. If you are making the cable yourself, connect the wires as shown in the following diagram:

Solar-Log™ terminal strip connector	Solar-Log Base RS422	Inverter terminal strip
Terminal		Terminal
▶ 1 (T/RX+)	▶ 6 (T/RX+)	▶ R+
▶ 4 (T/RX-)	▶ 9 (T/RX-)	▶ T+
▶ 5 (R/TX+)	▶ 10 (R/TX+)	▶ R-
▶ 6 (R/TX-)	▶ 13 (R/TX-)	▶ T-

4. If no further inverter is connected, terminate the inverter according to the instructions for the inverter.
5. Close the inverter if no other inverters are to be connected.
6. Insert the terminal block connector into the Solar-Log™ RS485/422 B or C socket.

Connect the inverters to each other

- Connect using a 4 wire, shielded data cable
- Where to connect: Terminal strip inside the inverter (on the retrofitted RS485 interface)

Procedure

1. Open the inverter as shown in the inverter's instructions.
2. Connect terminals R+, R-, T+ and T- of inverter 1 to the corresponding terminals on inverter 2.
3. Connect the other inverters to each other in the same way.
4. Terminate the last inverter according to the inverter instructions.
5. Close inverters.

78.2 SALICRU EQXLV

Termination	Addressing	Interface
Resistor	Yes	RS485

Overview

- Integrated interface
- 2-pin wiring
- Communication address must be allocated.
- Installation steps
 - Switch off the inverters and Solar-Log™
 - Connect inverters to the Solar-Log™
 - Connect the inverters to each other
 - Allocate communication address

Connect inverters to the Solar-Log™

The wiring is done using a

- ready-made data cable (optional extra; not supplied)
- or
- self-made, shielded 2 wire data cable and terminal block connector.

Procedure

1. If you are making the cable yourself, connect the wires as shown in the following diagram:

Solar-Log™ terminal strip connector	Solar-Log Base RS485 (A) / (B)	Inverter terminal strip
Terminal		Terminal
▶ 1 (Data+)	▶ (A) 6 or (B) 10 (Data+)	▶ 4 (A in)
▶ 4 (Data-)	▶ (A) 9 or (B) 13 (Data-)	▶ 3 (B in)

2. If no further inverter connected, terminate the inverter:
Insert 120 Ω terminal resistor.
3. Insert the terminal block connector into the Solar-Log™ RS485 socket.

Connect the inverters to each other

- Connect using a 2 wire, shielded data cable
- Where to connect: Terminal strip inside the inverter

Procedure

1. Connect terminal 2 (A out) on inverter 1 to terminal 4 (A in) on inverter 2.
2. Connect terminal 1 (B out) on inverter 1 to terminal 3 (B in) on inverter 2.
3. Connect the other inverters to each other in the same way.
4. Terminate the last inverter. Insert 120 Ω terminal resistor.

Allocate communication address

- Recommendation: Continuous numbering starting with 1.
- Setting: Using PC software for configuring inverters.
- Procedure: Start according to the inverter's instructions

79 Samil Power

79.1 Samil Power

Termination	Addressing	Interface
-	No	RS422

Overview

- Integrated interface
- 2 RJ11 sockets inside the inverter.
- 4-pin wiring - only on RS485/422 B or C connection of the Solar-Log™
- Communication address does not have to be assigned



Note

Only connect inverter using the RS485/422 B or C interface.

Installation steps

- Switch off the inverters and Solar-Log™
- Connect inverters to the Solar-Log™
- Connect the inverters to each other

Connect inverters to the Solar-Log™.

The wiring is done using a

- ready-made data cable (optional extra; not supplied)
- self-made, shielded 4 wire data cable and terminal block connector.

Procedure

1. Open the inverter as shown in the inverter's instructions.
2. If you are making the cable yourself, connect the wires as shown in the following diagram:

Solar-Log™ terminal strip connector	Solar-Log Base RS422	Inverter SolarRiver*	Inverter SolarLake
RS485/422 B		RJ 11 socket	RJ45 socket
▶ 1 (T/RX+)	▶ 6 (T/RX+)	▶ 2 R+	▶ 3 R+
▶ 4 (T/RX-)	▶ 9 (T/RX-)	▶ 1 R-	▶ 6 R-
▶ 5 (R/TX+)	▶ 10 (R/TX+)	▶ 4 T+	▶ 1 T+
▶ 6 (R/TX-)	▶ 13 (R/TX-)	▶ 3 T-	▶ 2 T-

*Some of the SolarRiver models use the same connection as SolarLake. Setup the wiring according to SolarLake in this case.



Note:

The wiring above refers to the RJ45 or RJ11 socket.

3. Insert the RJ11 plug into any RJ11 socket on inverter 1.
4. Close the inverter if no other inverters are to be connected.
5. Insert the terminal block connector into the Solar-Log™ RS485/422 B or C socket.

Connect the inverters to each other

- Connect using a 4 wire, shielded data cable
- Where to connect: RJ11 sockets

Procedure

Open the inverter as shown in the inverter's instructions.

1. Insert the self-made cable with the RJ11 plug into any RJ11 socket on inverter 1.
2. Insert the RJ11 cable into the 2nd RJ11 socket on inverter 1 and into any RJ11 socket on inverter 2.
3. Connect the other inverters to each other in the same way.
4. Close inverters.
5. Insert the terminal block connector into the Solar-Log™ RS485/422 B or C socket.



Note

A maximum of 32 inverters can be connected to the RS422 bus.

80 Santerno

80.1 Santerno

Termination	Addressing	Interface
Yes	Yes	RS485

Overview

- Integrated interface
- Where to connect: 9 pin socket on the outside of the housing floor.
- 2-pin wiring.
- Communication address must be allocated.
- Installation steps
 - Switch off the inverters and Solar-Log™
 - Install the RS485 interface in the inverter
 - Connect inverters to the Solar-Log™
 - Connect the inverters to each other
 - Allocate communication address

Connect inverters to the Solar-Log™

The wiring is done using a

- ready-made Santerno data cable (optional extra; not supplied)
- or
- self-made, shielded 2 wire data cable with a 9 pin plug and a terminal block connector.

Procedure

1. If you are making the cable yourself, connect the wires as shown in the following diagram:

Solar-Log™ terminal strip connector	Solar-Log Base RS485 (A) / (B)	Inverter terminal strip
Terminal		Terminal
▶ 1 (Data+)	▶ (A) 6 or (B) 10 (Data+)	▶ 1 (A-Line)
▶ 4 (Data-)	▶ (A) 9 or (B) 13 (Data-)	▶ 2 (B-Line)

2. Insert the plug into socket A on the inverter.
3. If no further inverter connected, terminate the inverter:
Connect socket A on the Santerno Solar-Log™ data cable to the plug of the first Santerno inverter data cable.
4. Insert the terminal block connector into the Solar-Log™ RS485 socket.

Connect the inverters to each other

- Santerno inverter data cable (optional extra; not supplied)
- Where to connect: 9 pin socket on the outside of the housing floor.

Procedure

1. Insert the Santerno inverter data cable plug into socket B of the first inverter.
2. Insert the Santerno inverter data cable plug into socket C of the first inverter.
3. Insert the plug on the other end of the cable into socket C of the second inverter.
4. Connect the other inverters to each other using socket C.
5. Terminate the last inverter.
Connect socket A on the Santerno Solar Log™ data cable to the plug of the first Santerno data cable.

Allocate communication address

- Recommendation: Continuous numbering starting with 1.
- Setting: Using the inverter operating display
- Procedure: Start according to the inverter's instructions

81 Schneider Electric

81.1 Schneider Electric SunEzy

Termination	Addressing	Interface
Yes	No	RS422

Select "Schneider Electric: SunEzy" for the device detection.

Overview

- Interface not integrated; Retrofit RS485 interface card.
- 4-pin cable – only on RS485/422 B or C connection of the Solar-Log™
- Communication address does not have to be assigned
- Multi-string technology

The inverters are fitted with 1 or 3 MPP trackers depending on the model. Each string input is monitored separately and ideally adjusted to the connected modules.

The Solar-Log™ automatically detects how many inverters and strings are active during inverter detection.



Note

The order in which the inverters are displayed in the Solar-Log™ after detection is random. We strongly recommend that you change the order of the inverters immediately after detection at startup in the [Configuration | Device | Configuration | Order](#) menu box.

- ▶ The inverters can be identified using the displayed serial number.

- Installation steps
 - Switch off the inverters and Solar-Log™
 - Install the RS485 interface in the inverter
 - Connect inverters to the Solar-Log™
 - Connect the inverters to each other

Installing the RS485 interface

Procedure

- ▶ Insert the RS485 interface in the bottom of the inverter in accordance with the interface card installation instructions and screw in.

Connect inverters to the Solar-Log™

The wiring is done using a

- ready-made BKL1 data cable (optional extra; not supplied)
- or
- self-made, shielded 4 wire data cable and terminal block connector.

**Note**

Only connect inverter using the RS485/422 B or C interface.

Procedure

1. Open the inverter as shown in the inverter's instructions.
2. Pull the free wires through the wire opening in the inverter.
3. If you are making the cable yourself, connect the wires as shown in the following diagram:

Solar-Log™ terminal strip connector	Solar-Log Base RS422	Inverter terminal strip
Terminal		Terminal
▶ 1 (T/RX+)	▶ 6 (T/RX+)	▶ R+
▶ 4 (T/RX-)	▶ 9 (T/RX-)	▶ R-
▶ 5 (R/TX+)	▶ 10 (R/TX+)	▶ T+
▶ 6 (R/TX-)	▶ 13 (R/TX-)	▶ T-

4. If no further inverter is connected, terminate the inverter according to the instructions for the inverter.
5. Close the inverter if no other inverters are to be connected.
6. Insert the terminal block connector into the Solar-Log™ RS485/422 B or C socket.

Connect the inverters to each other

- Connect using a 4 wire, shielded data cable
- Where to connect: Terminal strip inside the inverter (on the retrofitted RS485 interface)

Procedure

1. Open the inverter as shown in the inverter's instructions.
2. Connect terminals R+, R-, T+ and T- of inverter 1 to the corresponding terminals on inverter 2.
3. Connect the other inverters to each other in the same way.
4. Terminate the last inverter according to the inverter instructions.
5. Close inverters.

81.2 Schneider Electric Xantrex GT30E

Termination	Addressing	Interface
-	No	Sub D9 socket

Select "Schneider Electric: XantrexGT30E" for the device detection.

Overview

- Integrated interface
- Where to connect: Sub D 9 socket X51 inside the inverter.
- 2-pin wiring
- Communication address must be allocated to the inverter.
- Installation steps
 - Switch off the inverters and Solar-Log™
 - Connect inverters to the Solar-Log™
 - Connect the inverters to each other

Connect inverters to the Solar-Log™

The wiring is done using a

- ready-made data cable (optional extra; not supplied)
- self-made, shielded 2 wire data cable and terminal block connector

Procedure:

1. Open the inverter as shown in the inverter's instructions.
2. If you are making the cable yourself, connect the wires as shown in the following diagram

Solar-Log™ terminal strip connector	Solar-Log Base RS485 (A) / (B)	Inverters
Terminal		Sub D9 socket X51
▶ 1 (Data+)	▶ (A) 6 or (B) 10 (Data+)	▶ 8
▶ 4 (Data-)	▶ (A) 9 or (B) 13 (Data-)	▶ 6

3. Close the inverter if no other inverters are to be connected.
4. Insert the terminal block connector into the Solar-Log™ RS485 socket.

Connect the inverters to each other

- Connect using a 2 wire, shielded data cable
- Where to connect: Sub D 9 socket X51 inside the inverter.

Procedure

1. If you are making the cable yourself, connect the wires as shown in the following diagram

Solar-Log™ terminal strip connector	Solar-Log Base RS485 (A) / (B)	Inverters
RS485/422 B		Sub D9 socket X51
▶ 1 (Data+)	▶ (A) 6 or (B) 10 (Data+)	▶ 8
▶ 4 (Data-)	▶ (A) 9 or (B) 13 (Data-)	▶ 6

2. Connect the other inverters to each other in the same way (1:1).
3. Close the inverter if no other inverters are to be connected.
4. Insert the terminal block connector into the Solar-Log™ RS485 socket.

81.3 Schneider Electric Conext

Termination	Addressing	Interface
-	Yes	RS485

Select "Schneider Electric: Conext CL/RL/TL" for the device detection.

Overview

- Integrated interface
- Where to connect: RJ45 socket on the outside of the inverter
- 3-pin wiring
- Communication address must be allocated.
- Installation steps
 - Allocate communication address
 - Switch off the inverters and Solar-Log™
 - Connect inverters to the Solar-Log™
 - Connect the inverters to each other

Connect inverters to the Solar-Log™

The wiring is done using a

- self-made cable connection with RS485 data cable and terminal block connector.

Procedure

1. Open the inverter as shown in the inverter's instructions.
2. Insert the RJ45 plug into any RJ45 socket on the first inverter.
3. If you are making the cable yourself, connect the wires as shown in the following diagram
4. If only one inverter is to be connected this must be terminated.

Solar-Log™ terminal strip connector	Solar-Log Base RS485 (A) / (B)	Inverters
Terminal		PIN
▶ 1 (Data+)	▶ (A) 6 or (B) 10 (Data+)	▶ 4
▶ 3 GND	▶ (A) 8 or (B) 12 GND	▶ 8
▶ 4 (Data-)	▶ (A) 9 or (B) 13 (Data-)	▶ 5

5. Close the inverter if no other inverters are to be connected.
6. Insert the terminal block connector into the Solar-Log™ RS485 socket.



Caution

Risk of damage to the unit!

The Solar-Log™ also has an RJ45 socket, which must never be connected to the RJ45 socket on the inverter.

- ▶ Only connect inverters via the RS485/422 Solar-Log™ interface(s).

Connect the inverters to each other

- Connect using a network cable (patch cable)
- Where to connect: 2 RJ45 sockets

Procedure

1. Open the inverter as shown in the inverter's instructions.
2. Insert the RJ45 plug into any RJ45 socket on the first inverter.
3. Insert the other end of the wire into any RJ45 socket on inverter 2.
4. Connect the other inverters to each other in the same way.
5. Terminate the last inverter in accordance with the manufacturer's specifications.
6. Close the inverter if no other inverters are to be connected.
7. Insert the terminal block connector into the Solar-Log™ RS485 socket.

81.4 Schneider Conext Sunspec (RS485)

Termination	Addressing	Interface
Switch	Yes	RS485

Select "Schneider ElectricConext Sunspec" for the device detection.

Supported models:

- CL60
- CL125

Overview

- Integrated interface
- Where to connect: RJ45 socket on the outside of the inverter
- 3-pin wiring
- Communication address must be allocated
- Installation steps
 - Allocate communication address
 - Switch off the inverters and Solar-Log™
 - Connect inverters to the Solar-Log™
 - Connect the inverters to each other

Connect inverters to the Solar-Log™

The wiring is done using a

- self-made cable connection with RS485 data cable and terminal block connector.

Procedure

1. Open the inverter as shown in the inverter's instructions.
2. Insert the RJ45 plug into RJ45-Out socket on the first inverter.
3. If you are making the cable yourself, connect the wires as shown in the following diagram:

Solar-Log™ terminal strip connector	Solar-Log Base RS485 (A) / (B)	Inverter RS485
Terminal		Pin
▶ 1 (Data+)	▶ (A) 6 or (B) 10 (Data+)	▶ A+
▶ 3 GND	▶ (A) 8 or (B) 12 GND	▶ GND
▶ 4 (Data-)	▶ (A) 9 or (B) 13 (Data-)	▶ B-

4. If no further inverter is connected, terminate the inverter according to the instructions for the inverter.
5. Close the inverter if no other inverters are to be connected.
6. Insert the terminal block connector into the Solar-Log™ RS485 socket.



Caution

Risk of damage to the unit!

The Solar-Log™ also has an RJ45 socket, which must never be connected to the RJ45 socket on the inverter.

- ▶ Only connect inverters via the RS485/422 Solar-Log™ interface(s).

Connect the inverters to each other

- Connect using a network cable (patch cable).
- Where to connect: 2 RJ45 sockets.

Procedure

1. Open the inverter as shown in the inverter's instructions.
2. Insert the RJ45 plug into the RJ45 out socket on the first inverter.
3. Insert the other end of the cable into the RJ45 in socket on second inverter.
4. Connect the other inverters to each other in the same way.
5. Terminate the last inverter in accordance with the manufacturer's specifications.
6. Close the inverter if no other inverters are to be connected.
7. Insert the terminal block connector into the Solar-Log™ RS485 socket.

Assign the communication address

- Recommendation: Continuous numbering starting with 1 (address range 1 to 247).
- Setting: Using the inverter's operating display.
- Procedure: Start according to the inverter's instructions.

81.5 Schneider Conext CL60 Sunspec (Ethernet)

Termination	Addressing	Interface
No	Yes	LAN

Overview

- Integrated interface
- The inverter's IP address has to be assigned
- Connected using network cable (patch cable) and Ethernet router or switch
- Installation steps
 - The inverter's has to be assigned a static IP address
 - Switch off the inverters and Solar-Log™
 - Connect inverters to the Solar-Log™ (RJ45)
 - Connect the inverters to each other (RJ45)

Connect inverters to the Solar-Log™

The wiring is done using a

- network cable (patch cable/crossover cable) and the
- Ethernet router or switch.

Connect the inverters to each other

The inverters are connected together using the RJ45 interface and, if needed, a router or switch.

Connection setup according to the inverter's instructions.

Assigning IP addresses

- A static IP address has to be assigned to the inverter via the display.
- Please select an IP address with the same class C subnet as the Solar-Log™.
For example: The Solar-Log™ has the IP address 192.168.178.49.
The inverter in this case has to have a free IP address in the same range (from 192.168.178.1 to 192.168.178.254).
- Procedure: Start according to the inverter's instructions

Detection via the Solar-Log™ WEB Interface

- For detection on the Solar-Log™, select the device class under the menu Configuration | Device | Definition | Interface with the plus symbol and then select Schneider as the manufacturer. Confirm your selection with OK.
- Save your selections and then start the Device Detection under Configuration | Device | Detection.

Detection from the Solar-Log 1200

- When using the Solar-Log 1200, the detection can also be started from the display. Select the settings □Start ► Initial Configuration ► Page 2 „Device“ ► Add and select the manufacturer Schneider from there. Save and start the Device Detection.

82 Schüco

82.1 IPE CN series

Termination	Addressing	Interface
Terminating plug	Yes	RS485

Selectable under Refusol

Overview

- Integrated interface.
- Where to connect: RJ45 socket on the bottom of the inverter.
- 2-pin wiring.
- Communication address must be allocated.
- Installation steps
 - Switch off the inverters and Solar-Log™.
 - Connect inverters to the Solar-Log™.
 - Connect the inverters to each other.
 - Allocate communication address.



Note

To use active and reactive power management, all of the inverters need to be set to:

- ▶ Protocol 1
- ▶ 57600 baud
- ▶ Parameter 1164 = 2

Connect inverters to the Solar-Log™

The wiring is done using a

- self-made, shielded 2 wire data cable and terminal block connector.

Procedure

1. Connect wires as shown in the diagram below.

Solar-Log™ terminal strip connector	Solar-Log Base RS485 (A) / (B)	RS485 inverter socket
Terminal		PIN
▶ 1 (Data+)	▶ (A) 6 or (B) 10 (Data+)	▶ 2
▶ 4 (Data-)	▶ (A) 9 or (B) 13 (Data-)	▶ 3

2. If no further inverter connected, terminate the inverter:
On the sockets „RS485 OUT“ with REFUSOL round plugs bypass the connections PIN1 to PIN2 and PIN3 to PIN4.
3. Close the inverter if no other inverters are to be connected.
4. Insert the terminal block connector into the Solar-Log™ RS485 socket.

Connect the inverters to each other

- Connect using
 - 2-wire, shielded data cable and
 - 4-pin „SACC-M12MS-4SC“ plug.
- Where to connect: RS485 sockets on the bottom of the inverter.

The RS485 IN and OUT sockets are each double connections so that the wiring can be continued to the next inverter.

Procedure

1. Connect the data cable to the „SACC-M12MS-4SC“ plug as shown in the inverter's instructions.
2. Insert one plug into the OUT (X14B) socket of inverter 1.
3. Insert the other end of the wire into the IN socket (X15B) on inverter 2.
4. Connect the other inverters to each other in the same way.
5. Terminate the last inverter.
On the sockets „RS485 OUT“ with REFUSOL round plugs bypass the connections PIN1 to PIN2 and PIN3 to PIN4.
6. Close inverters.

Allocate communication address

- Recommendation: Continuous numbering starting with 1; highest possible address: 31.
- Procedure: Start according to the inverter's instructions.

82.2 IPE CT series

Termination	Addressing	Interface
DIP switch	Yes	RS485

Selectable under Bonfiglioli

Overview

- Integrated interface.
- Where to connect: Terminal strip inside the inverter.
- 3-pin wiring.
- Communication address must be allocated.
- Installation steps
 - Switch off the inverters and Solar-Log™.
 - Connect inverters to the Solar-Log™.
 - Connect the inverters to each other.
 - Allocate communication address.

Connect inverters to the Solar-Log™

The wiring is done using a

- self-made, shielded 3 wire data cable with a terminal block connector.

Procedure

1. Get access to the inverter interface
2. If you are making the cable yourself, connect the wires as shown in the following diagram:

Solar-Log™ terminal strip connector	Solar-Log Base RS485 (A) / (B)	Terminal strip inside the inverter
Terminal		RS485 terminal
▶ 1 (Data+)	▶ (A) 6 or (B) 10 (Data+)	▶ 1 A (Data+)
▶ 3 GND	▶ (A) 8 or (B) 12 GND	▶ 6 GND
▶ 4 (Data-)	▶ (A) 9 or (B) 13 (Data-)	▶ 3 B (Data-)

3. If no further inverter connected, terminate the inverter:
In the inverter, set the DIP switch S1 for the terminal resistor to ON.
4. Insert the terminal block connector into the Solar-Log™ RS485 socket.

Connect the inverters to each other

- Where to connect: Terminal strip on the inverter
- 3-pin wiring

Procedure

1. Get access to the inverter interface
2. If you are making the cable yourself, connect the wires as shown in the following diagram:

Terminal strip inside the inverter	Terminal strip inside the inverter
RS485 terminal	RS485 terminal
▶ 1 A (Data+)	▶ 2 A (Data+)
▶ 6 GND	▶ 6 GND
▶ 3 B (Data-)	▶ 4 B (Data-)

3. Connect terminals on inverter 1 to the corresponding terminals on inverter 2.
4. Connect the other inverters to each other in the same way.
5. Terminate the last inverter.
Set the DIP S1 switch for the terminal resistor to ON.
6. Insert the terminal block connector into the Solar-Log™ RS485 socket.

Allocate communication address

- Recommendation: Continuous numbering starting with 1 going to 30
- Procedure: Start according to the inverter's instructions



Note

A maximum of 20 inverters can be connected per RS485 bus.

82.3 IPE SN series

Termination	Addressing	Interface
Yes	Yes	RS485

Selectable under Sunways

Overview

- Integrated interface.
- Where to connect: Terminal strip inside the inverter.
 - 750 V models: 4 RS485 terminals on 10 pin terminal strip.
 - 850 V models: 4 pin RS485 terminal strip.
- 2-pin wiring.
- Communication address must be allocated.
- Installation steps
 - Switch off the inverters and Solar-Log™.
 - Connect inverters to the Solar-Log™.
 - Connect the inverters to each other.
 - Allocate communication address.

Connect inverters to the Solar-Log™

The wiring is done using a

- ready-made Sunways data cable (optional extra; not supplied)
- or
- self-made, shielded 2 wire data cable and terminal block connector.

Procedure

1. Open the inverter as shown in the inverter's instructions.
2. Pull the free wires through the wire opening in the inverter.
3. If you are making the cable yourself, connect the wires as shown in the following diagram:

Solar-Log™ terminal strip connector	Solar-Log Base RS485 (A) / (B)	Inverter terminal strip
Terminal		Terminal
▶ 1 (Data+)	▶ (A) 6 or (B) 10 (Data+)	▶ RS485+
▶ 4 (Data-)	▶ (A) 9 or (B) 13 (Data-)	▶ RS485-

4. If no further inverter is connected, terminate the inverter according to the instructions for the inverter.
5. Close the inverter if no other inverters are to be connected.
6. Insert the terminal block connector into the Solar-Log™ RS485 socket.

Connect the inverters to each other

- Connect using a 2 wire, shielded data cable
- Where to connect: Terminal strip inside the inverter
 - 750 V models: 4 RS485 terminals on 10 pin terminal strip
 - 850 V models: 4 pin RS485 terminal strip

The RS485 connections on the terminal strip are each double connections so that the wiring can be continued to the next inverter.

Procedure

1. Open the inverter as shown in the inverter's instructions.
2. Connect terminals RS485+ and RS485- on all inverters to the two data cable wires in accordance with the inverter instructions.
3. Terminate the last inverter in accordance with the inverter instructions.
4. Close inverters.

Allocate communication address

- Recommendation: Continuous numbering starting with 1.
- Setting: Using the inverter operating display
- Procedure: Start according to the inverter's instructions

82.4 SGI series (RS485)

Termination	Addressing	Interface
Terminating plug	Yes	RS485

Selectable under Schüco

Overview

- Integrated interface
- Where to connect: RJ45 socket on the bottom of the inverter
- 2-pin wiring
- Communication address must be allocated.
- Installation steps
 - Switch off the inverters and Solar-Log™
 - Connect inverters to the Solar-Log™
 - Connect the inverters to each other
 - Allocate communication address

Connect inverters to the Solar-Log™

The wiring is done using a

- ready-made data cable (optional extra; not supplied)
- or
- self-made cable connection with RS485 data cable and terminal block connector.



Caution

Risk of damage to the unit!

The Solar-Log™ also has an RJ45 socket, which must never be connected to the RJ45 socket on the inverter.

- ▶ Only connect inverters via the RS485/422 Solar-Log™ interface(s).

Procedure

1. If you are making the cable yourself, connect the wires as shown in the following diagram:

Solar-Log™ terminal strip connector	Solar-Log Base RS485 (A) / (B)	RJ45 inverter
Terminal		PIN
▶ 1 (Data+)	▶ (A) 6 or (B) 10 (Data+)	▶ 3 (A)
▶ 4 (Data-)	▶ (A) 9 or (B) 13 (Data-)	▶ 6 (B)

2. Open the unit cover on the bottom of the inverter.
3. Insert the RJ45 plug into the RJ45 socket on the inverter.
4. If no further inverter connected, terminate the inverter:
Insert the IP20 terminal plug into a free RJ45 socket (not strictly required for cables up to 100 m long).
5. Insert the terminal block connector into the Solar-Log™ RS485 socket.
6. Close the unit cover on the bottom of the inverter.

Connect the inverters to each other

- Connect using a network cable (patch cable)
- Where to connect: RJ45 sockets on the bottom of the inverter

Procedure

1. Open the unit cover on the bottom of the inverter.
2. Insert the RJ45 plug into any RJ45 socket on inverter 1.
3. Insert the other end of the wire into any RJ45 socket on inverter 2.
4. Connect the other inverters to each other in the same way.
5. Terminate the last inverter.
Insert the IP20 terminal plug into a free RJ45 socket (not strictly required for cables up to 100 m long).
6. Close the unit cover on the bottom of the inverter.

Allocate communication address

- Recommendation: Continuous numbering starting with 1.
- Setting: Using the inverter operating display
- Procedure: Start according to the inverter's instructions

83 Shindengen

83.1 Shindengen

Termination	Addressing	Interface
Yes	Yes	RS485

Overview

- Integrated interface
- Where to connect: Terminal strip inside the inverter
- 3-pin wiring
- Communication address must be allocated.
- Installation steps
 - Switch off the inverters and Solar-Log™
 - Connect inverters to the Solar-Log™
 - Connect the inverters to each other
 - Allocate communication address

Connect inverters to the Solar-Log™

The wiring is done using a

- self-made, shielded 3 wire data cable with a terminal block connector.

Procedure

1. Open the inverter as shown in the inverter's instructions.
2. If you are fabricating the cable yourself, connect the wires as shown in the following diagram.

Solar-Log™ terminal strip connector	Solar-Log Base RS485 (A) / (B)	Terminal strip inside the inverter
Terminal		RS485 terminal
▶ 1 (Data+)	▶ (A) 6 or (B) 10 (Data+)	▶ 30 A (+)
▶ 3 GND	▶ (A) 8 or (B) 12 GND	▶ 31 GND
▶ 4 (Data-)	▶ (A) 9 or (B) 13 (Data-)	▶ 13 B (-)

3. If no further inverter is connected, terminate the inverter according to the instructions for the inverter.
4. Close inverters.
5. Insert the terminal block connector into the Solar-Log™ RS485 socket.

Connect the inverters to each other

- Where to connect: Terminal strip inside the inverter
- 3-pin wiring

Procedure

1. Open the inverter as shown in the inverter's instructions.
2. If you are fabricating the cable yourself, connect the wires as shown in the following diagram.

Terminal strip inside the inverter	Terminal strip inside the inverter
RS485 terminal	RS485 terminal
▶ 30 A (+)	▶ 30 A (+)
▶ 31 GND	▶ 31 GND
▶ 13 B (-)	▶ 13 B (-)

3. Connect terminals on inverter 1 to the corresponding terminals on inverter 2.
4. Connect the other inverters to each other in the same way.
5. If no further inverter is connected, terminate the inverter according to the instructions for the inverter.
6. Close inverters.
7. Insert the terminal block connector into the Solar-Log™ RS485 socket.

Allocate communication address

- Recommendation: Continuous numbering from 1 to 30
- Procedure: Start according to the inverter's instructions.



Note

A maximum of 30 inverters can be connected per RS485 bus.

84 SIEL

84.1 SIEL (single phase)

Termination	Addressing	Interface
Yes	Yes	RS485

Supported models:

- Soleil 1F (1-phase) 1,5, 2, 3, 4, 5, 6
- Soleil 10 TL
- Soleil M 1.5, 2, 4, 4.6, 6

Overview

- Interface not integrated; Retrofit RS485 interface card
- 2-pin wiring
- The communication address has to be assigned
- Installation steps
 - Allocate communication address
 - Switch off the inverters and Solar-Log™
 - Install the RS485 interface in the inverter
 - Connect inverters to the Solar-Log™
 - Connect the inverters to each other

Allocate communication address

- Recommendation: Continuous numbering starting with 1.
- Setting: Using the DIP switch on the interface card.

Before installing the RS485 interface card:

- ▶ Allocate the communication address using the 8 interface card DIP switches:

Example - Communication address 1:

On	<input type="checkbox"/>	<input checked="" type="checkbox"/>	<input checked="" type="checkbox"/>	<input checked="" type="checkbox"/>	<input checked="" type="checkbox"/>	<input checked="" type="checkbox"/>	<input checked="" type="checkbox"/>	<input checked="" type="checkbox"/>
Off	<input checked="" type="checkbox"/>	<input type="checkbox"/>	<input type="checkbox"/>	<input type="checkbox"/>	<input type="checkbox"/>	<input type="checkbox"/>	<input type="checkbox"/>	<input type="checkbox"/>
DIP switch	<input type="checkbox"/>	<input type="checkbox"/>	<input type="checkbox"/>	<input type="checkbox"/>	<input type="checkbox"/>	<input type="checkbox"/>	<input type="checkbox"/>	<input type="checkbox"/>

Example - Communication address 2:

On	Black	White	Black	Black	Black	Black	Black	Black
Off	White	Black	White	White	White	White	White	White
DIP switch	Grey	Grey	Grey	Grey	Grey	Grey	Grey	Grey

Example - Communication address 3:

On	White	White	Black	Black	Black	Black	Black	Black
Off	Black	Black	White	White	White	White	White	White
DIP switch	Grey	Grey	Grey	Grey	Grey	Grey	Grey	Grey

Example - Communication address 4:

On	Black	Black	White	Black	Black	Black	Black	Black
Off	White	White	Black	White	White	White	White	White
DIP switch	Grey	Grey	Grey	Grey	Grey	Grey	Grey	Grey

Example - Communication address 5:

On	White	Black	White	Black	Black	Black	Black	Black
Off	Black	White	Black	White	White	White	White	White
DIP switch	Grey	Grey	Grey	Grey	Grey	Grey	Grey	Grey

You will find more information at:

http://en.wikipedia.org/wiki/Binary_number.

Installing the RS485 interface Procedure

- Install the RS485 interface in the inverter in accordance with the interface card installation instructions.

Connect inverters to the Solar-Log™

The wiring is done using a

- self-made, shielded 2 wire data cable and terminal block connector.

Procedure

1. Open the inverter according to the inverter’s instructions.
2. If you are fabricating the cable yourself, connect the wires as shown in the following diagram.

Solar-Log™ terminal strip connector	Solar-Log Base RS485 (A) / (B)	Inverter terminal strip
Terminal		Terminal
▶ 1 (Data+)	▶ (A) 6 or (B) 10 (Data+)	▶ R+
▶ 4 (Data-)	▶ (A) 9 or (B) 13 (Data-)	▶ R-

3. If no further inverter is connected, terminate the inverter according to the instructions for the inverter.
4. Close the inverter if no other inverters are to be connected.
5. Insert the terminal block connector into the Solar-Log™ RS485 socket.

Connect the inverters to each other

- Connect using a 2-wire, shielded data cable.
- Where to connect: Terminal strip inside the inverter on the retrofitted RS485 interface card

Procedure

1. Open the inverter according to the inverter’s instructions.
2. Connect terminals T+ and T-on inverter 1 to terminals R+ and R- on inverter 2.

Terminal strip connection inverter 1	Terminal strip inverter 2
Terminal	Terminal
▶ T+	▶ R+
▶ T-	▶ R-

3. Connect the other inverters to each other in the same way.
4. Terminate the last inverter in accordance with the inverter instructions.
5. Close the inverter.

84.2 SIEL (3-phase)

Termination	Addressing	Interface
Yes	Yes	RS485

Supported models:

- Soleil 3F (3-phase) 10, 15, 20
- DSP (only in connection with the SIEL SCB and a valid license)

Overview

- Interface not integrated; Retrofit RS485 interface card.
- 3-pin wiring.
- The communication address has to be assigned.
- Installation steps
 - Allocate communication address.
 - Switch off the inverters and the Solar-Log™.
 - Install the RS485 interface in the inverter
 - Connect the inverters to the Solar-Log™.
 - Connect the inverters to each other.

Allocate communication address.

- Start according to the inverter's instructions.

Installing the RS485 interface

Procedure

- ▶ Install the RS485 interface in the inverter in accordance with the interface card installation instructions.

Connect the inverters to the Solar-Log™.

The wiring is done using a

- self-made, shielded 3-wire data cable and terminal block connector.

Procedure

1. Open the inverter according to the inverter's instructions.
2. If you are making the cable yourself, connect the wires as shown in the following diagram:

Solar-Log™ terminal strip connector Solar-Log Base RS485 (A) / (B) Inverter terminal strip

Terminal		Terminal
▶ 1 (Data+)	▶ (A) 6 or (B) 10 (Data+)	▶ 27 Data+
▶ 3 GND	▶ (A) 8 or (B) 12 GND	▶ 30 GND
▶ 4 (Data-)	▶ (A) 9 or (B) 13 (Data-)	▶ 28 Data-

3. If no further inverter is connected, terminate the inverter according to the instructions for the inverter
4. Close the inverter if no other inverters are to be connected.
5. Insert the terminal block connector into the Solar-Log™ RS485 socket.

Connect the inverters to each other.

- Connect the wires according to the inverter's instructions.

85 Siemens

85.1 Siemens

Termination	Addressing	Interface
Resistor	Yes	RS485



Note

The same protocol must be selected on both devices In order to ensure correct communication between the Solar-Log™ and the inverters.

Protocol selection for device detection:

- RefuSol: Native (for PM control)
- RefuSol: Generic

Overview

- Integrated interface
- Where to connect: RJ45 socket on the bottom of the inverter
- 2-pin wiring
- Communication address must be allocated.
- Installation steps
 - Switch off the inverters and Solar-Log™
 - Connect inverters to the Solar-Log™
 - Connect the inverters to each other
 - Allocate communication address

Connect inverters to the Solar-Log™

To connect the Solar-Log™ and the inverters prepare cables with the following pin allocation.

Connecting the Solar-Log™ to the first inverter

Solar-Log™ (4/6 pin terminal plug)	Solar-Log Base RS485 (A) / (B)	First inverter - RS485 IN (4-pin round plug)
▶ 1 Data+)	▶ (A) 6 or (B) 10 (Data+)	▶ Pin 2
▶ 4 (Data-)	▶ (A) 9 or (B) 13 (Data-)	▶ Pin 3

If no further inverter connected, terminate the inverter (see following item "Bus termination").

Connect the inverters to each other

Inverters must be connected to each other using shielded data cables via the RS485 connections located on the SINVERT PVM.

The following illustration shows the main connection diagram.

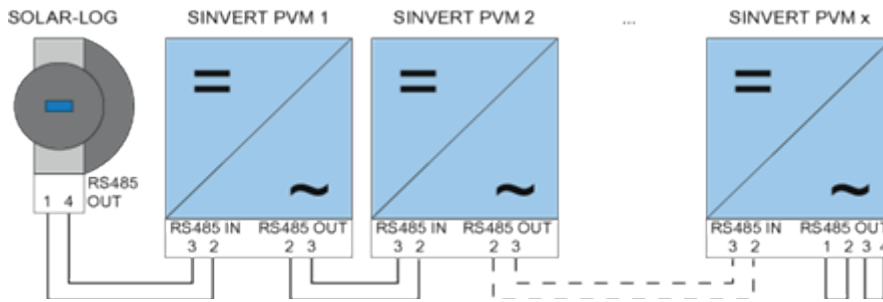

Fig.: Siemens – connecting inverters together

Use the SACC-M12MS-4SC connectors supplied with the inverter for data cables.

- Connect them as shown in the diagram.
- Connect the bus cable on the last inverter to the RS485 OUT socket using a terminal resistor.

**Inverter - RS485 OUT
(4-pin round plug)**

- ▶ Pin 2
- ▶ Pin 3

**Inverter - RS485 IN
(4-pin round plug)**

- ▶ Pin 2
- ▶ Pin 3

Bus termination

The bus must be terminated on the RS485 OUT connection of the last inverter with 120Ω.

To do this use the internal 120 Ω resistor and wire the following pins in a round 4-pin plug with two jumpers.

Inverter - RS485 OUT (4-pin round plug)

- ▶ Pin 1
- ▶ Pin 2
- ▶ Pin 3
- ▶ Pin 4

- Insert this plug into the RS485 OUT socket of the last inverter.

Setting parameters

- Parameters are set using the display on the inverter.
- The date and time must be correctly set and the password "72555" entered before the communication settings.
- The communication parameters are set in the sub-menu "F1 -> Configuration -> Communication -> RS 485."
- The individual menu items are selected with the arrow keys ↑↓ and confirmed by pressing ENTER.
- A consecutive communication address must be allocated to each SINVERT PVM. It is advisable to arrange the addresses consecutively beginning with 1, i.e. 1, 2, 3 up to a maximum of 31. The Solar-Log™ has address "0".
- The baud rate should be set to 57600. Baud rate 9600 must only be used when using the wireless package.

How to set communication address parameters

1. Select "USS address" and press ENTER.
2. Enter the numerical value xx [Address] and press ENTER.
3. Select "Baud rate" and press ENTER.
4. Enter the numerical value [Baud rate] and press ENTER.
5. Select "Protocol" and press ENTER.
6. Select protocol type "1" and press ENTER.

After the parameters have been set on the display the inverter must be switched off for one minute using the installed DC isolation switch. The settings are now applied and set to active. The configuration procedure is described in the manufacturer's handbook. Starting with Solar-Log™ firmware version 2.0.3 (Nov.09) no other parameters must be set on the inverter. The setting up (commissioning) can be continued immediately.

Solar-Log™ compatibility with older PVM installations

With older Solar-Log™ / PVM installations the inverter had to be set with additional parameters for Solar-Log™ compatibility. This is only still necessary if an inverter has been replaced because it was faulty or if the system has been extended. Only in these cases must the additional parameters be set again on the new inverters.



Note

A maximum of 31 inverters can be connected per RS485 bus.

86 Siliken

86.1 Siliken Central inverters

Termination	Addressing	Interface
No	Yes	LAN

Overview

- Integrated interface
- The inverter's IP address has to be assigned.
- Connected using network cable (patch cable) and Ethernet router or switch
- Installation steps
 - The inverter's has to be assigned a static IP address.
 - Switch off the inverters and Solar-Log™
 - Connect inverters to the Solar-Log™ (RJ45).
 - Connect the inverters to each other (RJ45).

Connect inverters to the Solar-Log™

The wiring is done using a

- network cable (patch cable/crossover cable) and the
- Ethernet router or switch.

Connect the inverters to each other

The inverters are connected together using the RJ45 interface and, if needed, a router or switch.

Connection setup according to the inverter's instructions.

Assigning IP addresses

- A static IP address has to be assigned to the inverter via the display.
- Please select an IP address with the same class C subnet as the Solar-Log™.
For example: The Solar-Log™ has the IP address 192.168.178.49.
The inverter in this case has to have a free IP address in the same range (from 192.168.178.1 to 192.168.178.254).
- Procedure: Start according to the inverter's instructions



Note

Each inverter has to be individually reachable via the network. For this, the network interface has to be activated for every inverter, according to the inverter's instructions, and the inverter needs to be connected to the local access network (LAN) via a switch.

Detection via the Solar-Log™ WEB Interface

- For detection on the Solar-Log™ , select the device class under the menu Configuration | Device | Definition | Interface with the plus symbol and then select Siliken as the manufacturer. Confirm your selection with OK.
- Save your selections and then start the Device Detection under Configuration | Device | Detection.

Detection from the Solar-Log 1200

- When using the Solar-Log 1200, the detection can also be started from the display. Select the settings □Start ► Initial Configuration ► Page 2 „Device“ ► Add and select the manufacturer Siliken from there. Save and start the Device Detection.

87 SiNeng

87.1 SiNeng CP/EP

Termination	Addressing	Interface
Yes	Yes	RS485

Selections available under SiNeng; Type: „CP/EP“; Interface: „RS485“

Supported models:

- CP-1000-B, CP-2000-B□
- EP-1260-A□EP-0500-A,EP-0630-A,EP-1000-A,EP-2000-A,EP-1000-B

Overview

- Integrated interface.
- Where to connect: Terminal block inside the inverter.
- 2-pin wiring.
- The communication address has to be assigned.
- Installation steps:
 - Switch off the inverters and the Solar-Log™.
 - Connect the inverters to the Solar-Log™.
 - Set the communication address according to the inverter's instructions.
 - Address range 1 - 247.
 - Terminate the inverter according to the inverter's instructions.

Connect the inverters to the Solar-Log™.

- The wiring is done using a self-made, shielded 2-wire data cable and terminal block connector.

Procedure:

1. Open the inverter according to the inverter's instructions.
2. Connect the wires for the cable connection as shown in the following diagram:

Solar-Log™ terminal strip connector	Solar-Log Base RS485 (A) / (B)	Terminal strip inverter RS485 A
Terminal		PIN assignments for RS485 A
▶ 1 (Data+)	▶ (A) 6 or (B) 10 (Data+)	▶ 485A+
▶ 4 (Data-)	▶ (A) 9 or (B) 13 (Data-)	▶ 485A-

3. Terminate the inverter according to the inverter's instructions if no additional inverters are to be connected.
4. Close the inverter if no other inverters are to be connected.
5. Insert the terminal block connector into the Solar-Log™ RS485 socket.

Connect the inverters to each other

- Where to connect: Terminal block inside the inverter.
- Connect the inverters to each other according to the inverter instructions.

Assign the communication address

- Recommendation: Continuous numbering starting with 1.
- Setting: Using the inverter's operating display.
- Procedure: Start according to the inverter's instructions.

Detection via the Solar-Log™ WEB Interface

- For detection on the Solar-Log™, select the device class under the menu [Configuration | Device | Definition | Interface](#) with the plus symbol and then select SiNeng as the manufacturer, CP/EP as the type and the interface. Confirm your selection with **OK**.
- Save your selections and then start the Device Detection under [Configuration | Device | Detection](#) and start the device detection.

Detection from the Solar-Log 1200

- When using the Solar-Log 1200, the detection can also be started from the display. Select the settings ► **Start ► Initial Configuration ► Page 2 „Devices“ ► ADD** and select „Inverter,“ „SiNeng“ and the interface „RS485.“ Save and start the Device Detection.

87.2 SiNeng SP

Termination	Addressing	Interface
Yes	Yes	RS485

Selections available under SiNeng; Type: „SP“; Interface: „RS485“

Supported models:

- CSP-8K, SP-10K, SP-12K, SP-20K, SP-40K, SP-50K, SP-60K, SP-40KLB, SP-50KLB, SP-60LB, SP70KLB

Overview

- Integrated interface.
- Where to connect: Terminal block inside the inverter.
- 2-pin wiring.
- The communication address has to be assigned.
- Installation steps:
 - Switch off the inverters and the Solar-Log™.
 - Connect the inverters to the Solar-Log™.
 - Set the communication address according to the inverter's instructions.
 - Address range 1 - 247.
 - Terminate the inverter according to the inverter's instructions.

Connect the inverters to the Solar-Log™.

- The wiring is done using a self-made, shielded 2-wire data cable and terminal block connector.

Procedure:

1. Open the inverter according to the inverter's instructions.
2. Connect the wires for the cable connection as shown in the following diagram:

Solar-Log™ terminal strip connector	Solar-Log Base RS485 (A) / (B)	Terminal strip inverter RS485 A
Terminal		PIN assignments for RS485 A
▶ 1 (Data+)	▶ (A) 6 or (B) 10 (Data+)	▶ 485A+
▶ 4 (Data-)	▶ (A) 9 or (B) 13 (Data-)	▶ 485A-

3. Terminate the inverter according to the inverter's instructions if no additional inverters are to be connected.
4. Close the inverter if no other inverters are to be connected.
5. Insert the terminal block connector into the Solar-Log™ RS485 socket.



Note

The termination is carried out via a software tool, please observe the instructions in the inverter manual.

Connect the inverters to each other

- Where to connect: Terminal block inside the inverter.
- Connect the inverters to each other according to the inverter instructions.

Assign the communication address

- Recommendation: Continuous numbering starting with 1.
- Setting: Via operating display (on the inverter) or via APP or via a software tool (please follow the inverter instructions).
- Procedure: Start according to the inverter's instructions.

Detection via the Solar-Log™ WEB Interface

- For detection on the Solar-Log™, select the device class under the menu [Configuration | Device | Definition | Interface](#) with the plus symbol and then select SiNeng as the manufacturer, SP as the type and the interface. Confirm your selection with **OK**.
- Save your selections and then start the Device Detection under [Configuration | Device | Detection](#) and start the device detection.

Detection from the Solar-Log 1200

- When using the Solar-Log 1200, the detection can also be started from the display. Select the settings ► [Start ► Initial Configuration ► Page 2 „Devices“ ► ADD](#) and select „Inverter,“ „SiNeng“ and the interface „RS485.“ Save and start the Device Detection.



Note

A maximum of 32 inverters can be connected per RS485 bus.

88 SMA

88.1 Overview

SMA inverters do not have an integrated RS485 interface.

However, the following RS485 interfaces can be retrofitted to SMA inverters:

- Special RS485 piggyback card (by Solare Datensysteme GmbH)
- Original SMA RS485 piggyback card (by SMA)

Both piggyback cards can be installed in "Sunny Boy" inverters (except for 3000/4000/5000TL-20 next generation) or "Sunny Mini Central" by SMA. The SMA RS485 data module is required for the SMA -20 and Tripower inverters.

Special RS485 piggyback card

- Only use with Solar-Log™ devices.

Piggyback mixed mode

Inverters with special RS485 piggybacks and original SMA piggybacks or data modules can be used together.

A diagram for wiring in SMA combined mode can be found in the appendix.

SMA Bluetooth mode

The Solar-Log™ BT model is compatible with Bluetooth enabled SMA inverters. On Bluetooth Solar-Log™ models it is possible to combine Bluetooth and hardwired RS485 devices but only using the RS485/422 B port. When Bluetooth operation is activated Port A becomes dedicated and restricted to 7 SMA BT inverters.



Note

Refer to the chapters in the Installation Manual when exchanging SMA inverters.

88.2 SMA connection using special RS485 piggyback card

Termination	Addressing	Interface
Jumper	No	RS485

Select "SMA: Data1" for the device detection.

Overview

- Interface not integrated; retrofit the special RS485 piggyback card
- Where to connect: Terminal strip inside the inverter on the piggyback
- Communication address does not have to be assigned
- 4-pin wiring
- Installation steps
 - Switch off the inverters and Solar-Log™
 - Installing the special RS485 piggyback in inverters
 - Connect inverters to the Solar-Log™
 - Connect the inverters to each other

Installing the special RS485 piggyback in inverters

Procedure

1. Open the inverter as shown in the inverter's instructions.
2. The Piggy Back has to be installed on the inverter's circuit board aligned to the left side under the pin contract strip (Figure 3, left).

The print "unten [down]" on the board has to be visible on the bottom left-hand side (Figure 3, right).

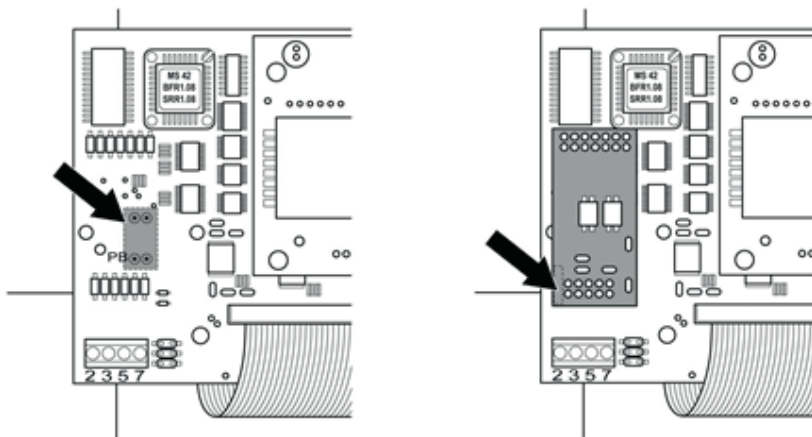

Fig.: Control board before and after installation of the piggyback



Note for Solar-Log 50 / Solar-Log Base:

The special PiggyBack must not be supplied with power via the Solar-Log 50 or Solar-Log Base. In this case a 12V power supply unit must be used.

Connect inverters to the Solar-Log™

- The wiring is done using a ready-made data cable (optional extra; not supplied) or self-made, shielded 4 wire data cable and terminal block connector.

Procedure

1. Pull the free wires through the wire opening in the inverter.
2. If you are making the cable yourself, connect the wires as shown in the following diagram:

Solar-Log™ terminal strip connector	Solar-Log Base RS485 (A) / (B)	Inverter terminal strip
Terminal		Terminal
▶ 1 (Data+)	▶ (A) 6 or (B) 10 (Data+)	▶ 2
▶ 2 12 V	▶ 12 V (see note previous page)	▶ 3
▶ 3 GND	▶ (A) 8 or (B) 12 GND	▶ 5
▶ 4 (Data+)	▶ (A) 9 or (B) 13 (Data-)	▶ 7

3. Pull the wire in the inverter through the insulation sleeve attached to the piggy back. The wire must be enclosed in the insulating hose inside the inverter.
4. Ground the connection: Connect terminal 5 on the inverter to the inverter housing using the supplied flat strip connector.

If only one inverter is to be connected it must be terminated.

Put the supplied jumper onto the lower pins on the connector strip.

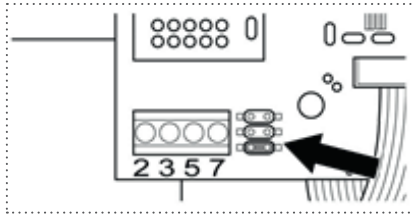

Fig.: Piggyback - insert jumper

5. Close the inverter if no other inverters are to be connected.
6. Insert the terminal block connector into the Solar-Log™ RS485 socket.

Connect the inverters to each other

- Connect using a 4 wire, shielded data cable (e.g. a 25 m ring cable, Solare Datensysteme order 220014)
- Where to connect: Terminal block in inverter (on the retrofitted RS485 interface)

Procedure

1. Pull the wire in the inverter through the insulation sleeve attached to the piggy back. The wire must be enclosed in the insulating hose inside the inverter.
2. Connect all 4 contacts (2, 3, 5, 7) on the terminal strip of inverter 1 to inverter 2



Note

A diagram for wiring in SMA combined mode can be found in the appendix.

1. Connect the other inverters to each other in the same way.
2. Terminate the last inverter.
Put the supplied jumper onto the lower pins on the connector strip.

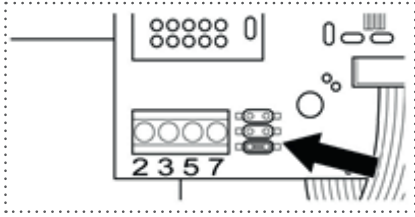

Fig.: Jumper SMA

3. Close inverters.

88.3 Connect SMA with original SMA RS485 piggy back and the SMA RS485 data module

Termination	Addressing	Interface
Resistor jumper	No	RS485

Select "SMA: Data1" for the device detection.

Overview

- Interface not integrated; retrofit the SMA RS485 piggyback card
- Where to connect: Terminal strip inside the inverter on the piggyback
- Communication address does not have to be assigned
- 3-pin wiring
- Installation steps
 - Switch off the inverters and Solar-Log™
 - Installing the original SMA RS485 piggyback in the inverter
 - Connect inverters to the Solar-Log™
 - Connect the inverters to each other

Installing the original SMA RS485 piggyback in the inverter

Procedure

- ▶ Install the original SMA RS485 piggy back in the inverter in accordance with the interface card installation instructions.

Connect inverters to the Solar-Log™

The wiring is done using a

- ready-made data cable (optional extra; not supplied)
- or
- self-made, shielded 3 wire data cable and terminal block connector.

Procedure

1. Open the inverter as shown in the inverter's instructions.
2. Pull the free wires through the wire opening in the inverter.
3. Pull the cable through the insulation tube.



Note

The wire must be enclosed in the insulating hose inside the inverter.

4. If you are making the cable yourself, connect the wires as shown in the following diagram:

Solar-Log™ terminal strip connector	Solar-Log Base RS485 (A) / (B)	Inverter terminal strip
▶ 1 (Data+)	▶ (A) 6 or (B) 10 (Data+)	▶ 2
▶ 3 GND	▶ (A) 8 or (B) 12 GND	▶ 5
▶ 4 (Data-)	▶ (A) 9 or (B) 13 (Data-)	▶ 7

5. Ground the connection: Connect terminal 5 on the inverter to the inverter housing using the supplied flat strip connector.
6. If only one inverter is to be connected it must be terminated.
Put the supplied jumper onto the lower pins on the connector strip.

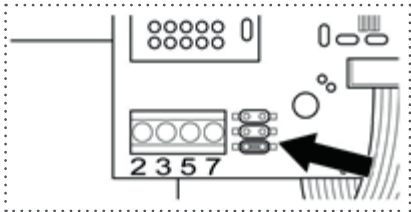

Fig.: Jumper SMA

7. Close the inverter if no other inverters are to be connected.
8. Insert the terminal block connector into the Solar-Log™ RS485 socket.

Connect the inverters to each other

- Connect using a 3 wire, shielded data cable.
- Where to connect: Terminal block in inverter (on the retrofitted RS485 interface)

Procedure

1. Open the inverter as shown in the inverter's instructions.
2. Connect the inverter in accordance with the inverter installation instructions.
3. If no further inverter connected, terminate the inverter:
Put the supplied jumper onto the lower pins on the connector strip.

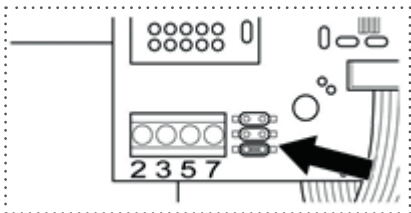

Fig.: Jumper SMA

4. Close inverters.



Note

A diagram for wiring in SMA combined mode can be found in the appendix.

88.4 SMA Bluetooth mode

Termination	Addressing	Interface
No	No	Bluetooth

Select "SMA: Data2+" for the device detection.

Bluetooth mode is only possible if the optional Bluetooth module is installed in the Solar-Log™. Bluetooth mode is possible only with Solar-Log™ BT models. All SMA Bluetooth inverters are supported, even Bluetooth Piggy Back cards.

Overview

- All SMA Bluetooth piggybacks are supported.
- Simultaneous operation with SMA SunnyBeam Bluetooth is not possible.
- Solar-Log™ BT Devices:
 - A maximum of 7 SMA Bluetooth inverters can be read
 - Possible to connect inverters from other manufactures

Bluetooth settings on the Solar-Log™

- The Solar-Log™ supports both the "direct connection" and "networked connection" modes. The models from the R2 series only have the option for "networked connections."
- Direct connection: The Solar-Log™ directly connects to each and every inverter individually. This requires that the Solar-Log™ is within range of the inverters. The NET-ID on the inverter and Solar-Log™ is set to 1.
- Networked connection (recommended): The Solar-Log™ connects to one inverter which then relays the connection signals to the other inverters. This greatly increases the range for the Bluetooth connection. Select a NET-ID between 2 and F for both the inverter and Solar-Log™ to use this mode. The NET-ID for the inverter and Solar-Log™ have to match.

Bluetooth addressing on the inverter

- Setting: Rotary switch in the inverter.
Refer to the inverter's manual for more information.

Bluetooth detection

- If possible, carry out Bluetooth detection in the room in which the inverter is installed, in order to avoid any detection errors resulting from lack of range.
- Then test the Bluetooth connection from further away. The maximum range is 50 m in a free field.
- The Easy Installation only works with NET-ID 2 on the inverter.



Note

The preset user name and password in the inverter may not be modified.



Note

The feed-in management functions are also available for the Bluetooth interface. Please note that the necessary settings have to be configured with the manufacturer's software. Please refer to the inverter's user manual for more information.



Note on the inverter detection.

For a successful inverter recognition requires the user password of the inverter in the Solar-Log™ WEB menu, under Configuration | Feed-In Management | Plant passwords to enter.

► Important:

To call the point Plant passwords must be at the interface previously SMA selected.

88.5 SMA Meter Connection Box

An energy meter with S0 output can be connected to the SMA Meter Connection Box. The Meter Connection Box then converts the S0 signal to the RS485 Bus.

The Meter Connection Box is connected to the RS485 socket the same way as with the SMA inverter. In the course of the inverter detection, the Box is recognized as an inverter - SMA is to be selected.

The configuration is done in the [Configuration | Devices | Configuration](#) menu.

Procedure

- Perform detection.
- Select the respective number.
- Enter the generator power.
- Enter the pulse factor.
- Select the type of power meter.
- Save.

88.6 SMA SOLID Q

Termination	Addressing	Interface
DIP switch	Yes	RS485

Select „SMA: SOLID-Q“ during the inverter detection

Supported model:

- SMA: SOLID-Q50

Overview

- Integrated interface
- Where to connect: Terminal strip inside the inverter
- 3-pin wiring
- The communication address has to be assigned (1 - 250)
- Installation steps
 - Switch off the inverters and Solar-Log™
 - Connect inverters to the Solar-Log™
 - Connect the inverters to each other
 - Configure the inverter's communication interface
 - Allocate communication address



Note

To activate RS485 communication, the DIP switch on the inverter has to be set to RS485-HD.

Connect inverters to the Solar-Log™

The wiring is done using a

- self-made, shielded 3 wire data cable and terminal block connector.

Procedure

1. Connect wires as shown in the diagram below.

Solar-Log™ terminal strip connector	Solar-Log Base RS485 (A) / (B)	Inverter terminal strip
Terminal		Terminal
▶ 1 (Data+)	▶ (A) 6 or (B) 10 (Data+)	▶ A PIN 1 (+)
▶ 3 GND	▶ (A) 8 or (B) 12 GND	▶ GND PIN 3
▶ 4 (Data-)	▶ (A) 9 or (B) 13 (Data-)	▶ B PIN 2 (-)

2. If no further inverter is connected, terminate the inverter according to the instructions for the inverter. (Refer to the notes below)
3. Close the inverter cover if no other inverters are to be connected.
4. Insert the terminal block connector into the Solar-Log™ RS485 socket.

Connect the inverters to each other

The inverters are connected together using the RS485 interface. Refer to the manufacturer's inverter manual for the details on how to setup the connection.

Assign the communication address

- Recommendation: Continuous numbering starting with 1 going to 250.
- Setting: Using the inverter's operating display.
- Procedure:
 - Go to the main menu.
 - Select the menu Settings > Communication Settings.
 - Press „Enter.“
 - Set the desired modbus address with the arrow keys.
 - Press „Enter“ to apply the setting.
 - Press the ESC key to stop the process..

Information on the termination:

If only one inverter is connected, both DIP switches have to be set to OFF. When several inverters are connected, the both DIP switches for the last inverters have to be set to ON and both DIP switches for the other inverters to OFF.

88.7 SMA Speedwire



Note

The trademark "Speedwire" is registered trademark of SMA Solar Technology AG in many countries.

Termination	Addressing	Interface
No	No	Ethernet/RJ45

Select "SMA: Speedwire" for the device detection.

Overview

- Integrated or retrofitted Speedwire interface
- The inverter's IP address has to be assigned.
- Connected using network cable (patch cable) and Ethernet router or switch
- Installation steps
 - The inverter's has to be assigned a static IP address
 - Switch off the inverters and Solar-Log™
 - Connect inverters to the Solar-Log™ (RJ45)
 - Connect the inverters to each other (RJ45)

Retrofitting the inverter with a SMA Speedwire module

Procedure

- ▶ Install the original Speedwire module in the inverter according to the interface card installation instructions.

Connect inverters to the Solar-Log™

The wiring is done using a

- network cable (patch cable/crossover cable) and the
- Ethernet router or switch.

Procedure

1. Open the inverter as shown in the inverter's instructions.
2. Pull the network cable through the inverter's cable opening and connect it to the Speedwire interface.
3. Close the inverter cover if no other inverters are to be connected.
4. Plug the network cable into the RJ45 socket (Ethernet) on the Solar-Log™.

Connect the inverters to each other

The inverters are connected together using the RJ45 interface and, if needed, a router or switch.

Connection setup according to the inverter's instructions.

Assigning IP addresses

- A static IP address has to be assigned to the inverter. This is set to automatic by default. Please refer to the inverter's user manual for more information.
- Please select an IP address with the same subnet as the Solar-Log™.
For example: The Solar-Log™ has the IP address 192.168.178.49.
The inverter in this case has to have a free IP address in the same range (from 192.168.178.2 to 192.168.178.254).
- Procedure: Start according to the inverter's instructions

Detection via the Solar-Log™ WEB Interface

- For detection on the Solar-Log™, select the device class under the menu Configuration | Device | Definition | Interface with the plus symbol and then select SMA as the manufacturer. Confirm your selection with OK.
- Save your selections and then start the Device Detection under Configuration | Device | Detection.

Detection from the Solar-Log 1200

- When using the Solar-Log 1200, the detection can also be started from the display. Select the settings Start ► Initial Configuration ► Page 2 „Device“ ► Add and select the manufacturer SMA from there. Save and start the Device Detection. .



Note for feed-in management

The feed-in management functions are also available for the Bluetooth interface. Please note that the necessary settings have to be configured with the manufacturer's software. Please refer to the inverter's user manual for more information.



Note

Please refer to the instructions in the manufacturer's installation manual in regard to address types.



Note

Wiring with the bus.

Only one network connection is available per inverter with the integrated Speedwire interface.

A router or switch is required when using several inverters or when using the Ethernet (RS45) interface on the Solar-Log™.



Note on the inverter detection.

For a successful inverter recognition requires the user password of the inverter in the Solar-Log™ WEB menu, under Configuration | Feed-In Management | Plant passwords to enter.

► Important:

To call the point Plant passwords must be at the interface previously SMA selected.

88.8 SMA - Sunny Central

Termination	Addressing	Interface
No	Yes	LAN

Select "SMA: Sunny Central CP" for the device detection.

Supported models:

- 500 (CP-XT, CP-US, CP-JP)
- 630 (CP-XT, CP-US, CP-JP)
- 720 (CP-XT, CP-US)
- 750 (CP-US)
- 760 (CP-XT)
- 800 (CP-XT, CP-US, CP-JP)
- 850 (CP-XT, CP-US)
- 900 (CP-XT, CP-US)
- 1000 (CP-XT)

Overview

- Integrated interface
- Connect using network cable (patch cable) and Ethernet router or switch.
- The communication address has to be assigned.
- Installation steps
 - Assign the communication address.
 - Connect the inverters to the Solar-Log™.
 - Connect the inverters to each other.

Assign the communication address.

- Assign the IP addresses according to the inverter's instructions.

Connect inverters and the Solar-Log™.

The wiring is done using a

- network cable (patch cable) and the
- Ethernet router or switch.

Procedure

1. Connect the Solar-Log™ and the inverter to the router or switch.
2. Assign an IP address to every inverter. Assign the IP addresses according to the inverter's instructions.

The first three number blocks like the Solar-Log™, e.g. 192.168.178.49.

The fourth number block: an address that is available, e.g. 192.168.178.50.

88.9 SMA - Sunny Tripower CORE1

Termination	Addressing	Interface
No	Yes	LAN

Select "SMA: Sunspec CORE1" for the device detection.

Supported models:

- STP 50-40
- STP33-US-41, STP50-US-41, STP62-US-41

Overview

- Integrated interface
- Connect using network cable (patch cable) and Ethernet router or switch.
- The communication address has to be assigned.
- Installation steps
 - Assign the communication address.
 - Connect the inverters to the Solar-Log™.
 - Connect the inverters to each other.

Assign the communication address.

- Assign the IP addresses according to the inverter's instructions.

Connect inverters and the Solar-Log™.

The wiring is done using a

- network cable (patch cable) and the
- Ethernet router or switch.

Procedure

1. Connect the Solar-Log™ and the inverter to the router or switch.
2. Assign an IP address to every inverter. Assign the IP addresses according to the inverter's instructions.

The first three number blocks like the Solar-Log™, e.g. 192.168.178.49.

The fourth number block: an address that is available, e.g. 192.168.178.50.



Note

Each inverter has to be individually reachable via the network.

To do this, activate the network interface at each inverter via the SMA SUNNY EXPLORER and connect the inverters into the network with a network switch.

Procedure:

- ▶ Set the „TCP Server“ to „On“ in the SMA SUNNY EXPLORER; Port=502.

88.10 SMA - Sunspec Modbus

Termination	Addressing	Interface
No	Yes	LAN

Select "SMA: Sunspec Modbus" for the device detection.

Supported models:

- Sunny Tripower 60
- Sunny Highpower 75-10 (Peak1/SHP75)

Overview

- Integrated interface
- The inverter's IP address has to be assigned per DHCP.
- Connect using network cable (patch cable) and Ethernet router or switch.
- Connecting the SMA Inverter Manager
- Installation steps
 - Turn the Solar-Log™ off.
 - Connect the inverters to each other.
 - Connect the inverters to the SMA Inverter Manager.
 - Connect the SMA Inverter Manager to the router/switch.
 - The inverters are assigned IP addresses via the SMA Inverter Manager per DHCP (default setting).
 - Connect the Solar-Log™ to the router/switch.

Connect the inverters to each other.

The inverters are connected together according to the inverter instructions.

Connect the inverters to the SMA Inverter Manager.

- Wire connections according to the inverter instructions.

Connecting the Solar-Log™/SMA Inverter Manager

- Connect the Solar-Log™ to the router/switch.
- Connect the SMA Inverter Manager to the router/switch.

Assigning IP addresses

- The inverters are assigned IP addresses via the SMA Inverter Manager.



Note

In order to perform the device detection for the inverters, the inverters first have to be set up according to the SMA instructions.

Detection via the Solar-Log™ WEB Interface

- For detection on the Solar-Log™, select the device class under the menu [Configuration | Device | Definition | Interface](#) with the plus symbol and then select SMA as the manufacturer and Sunspec as the type. Confirm your selection with OK.
- Save your selections and then start the Device Detection under [Configuration | Device | Detection](#).

Detection from the Solar-Log 1200

- When using the Solar-Log 1200, the detection can also be started from the display. Select the settings ► Start ► Initial Configuration ► Page 2 „Device“ ► Add and select the manufacturer „SMA: Sunspec Modbus“ from there. Save and start the Device Detection.

88.11 SMA - Sunny Tripower Modbus

Termination	Addressing	Interface
No	Yes	LAN

Select "SMA: Modbus" for the device detection.

Supported models:

- STP 3.0-3AV-40, STP 4.0-3AV-40, STP 5.0-3AV-40, STP6.0-3AV-40

Overview

- Integrated interface.
- The inverter's IP address has to be assigned.
- Connected using network cable (patch cable) and Ethernet router or switch.
- Installation steps:
 - The inverter's has to be assigned a static IP address.
 - Switch off the inverters and Solar-Log™.
 - Connect inverters to the Solar-Log™ (RJ45).
 - Connect the inverters to each other (RJ45).

Connect inverters to the Solar-Log™

The wiring is done using a

- network cable (patch cable/crossover cable) and the
- Ethernet router or switch.

Connect the inverters to each other

The inverters are connected together using the RJ45 interface and, if needed, a router or switch.

Connection setup according to the inverter's instructions.

Assigning IP addresses

- A static IP address has to be assigned to the inverter from its web menu.
- Please select an IP address with the same class C subnet as the Solar-Log™.
For example: The Solar-Log™ has the IP address 192.168.178.49.
The inverter in this case has to have a free IP address in the same range (from 192.168.178.1 to 192.168.178.254).
- Procedure: Start according to the inverter's instructions.



Note

The Modbus device ID has to be set to 3 from the SMA device's web menu in order to perform a device detection for the inverter.

Detection via the Solar-Log™ WEB Interface

- For detection on the Solar-Log™, select the device class under the menu [Configuration | Device | Definition | Interface](#) with the plus symbol and then select SMA as the manufacturer and Modbus as the type. Confirm your selection with OK.
- Save your selections and then start the Device Detection under [Configuration | Device | Detection](#).

Detection from the Solar-Log 1200

- When using the Solar-Log 1200, the detection can also be started from the display. Select the settings ► Start ► Initial Configuration ► Page 2 „Device“ ► Add and select the manufacturer „SMA: Modbus“ from there. Save and start the Device Detection.

89 SOCOME C

89.1 SOCOME C Sunsys B20E

Termination	Addressing	Interface
Yes	Yes	RS485

Selection available under SOCOME C

Overview

- Integrated interface.
- Where to connect: Terminal strip inside the inverter
- 5-pin wiring
- The communication address has to be assigned
- Installation steps
 - Switch off the inverters and Solar-Log™
 - Connect inverters to the Solar-Log™
 - Communication address according to the inverter's instructions
Address range 1 - 255
 - Terminate the inverter according to the inverter's instructions

Connect inverters to the Solar-Log™

The wiring is done using a

- self-made, shielded 5 wire data cable and terminal block connector.

Procedure:

1. Open the inverter according to the inverter's instructions.
2. Pull the free wires through the wire opening in the inverter.
3. If you are fabricating the cable yourself, connect the wires as shown in the following diagram.

Solar-Log™ terminal strip connector Solar-Log Base RS485 (A) / (B) Terminal strip inverter

Terminal		PIN
▶ 1 (Data+)	▶ (A) 6 or (B) 10 (Data+)	▶ 3
▶ 1 (Data+)	▶ (A) 6 or (B) 10 (Data+)	▶ 5
▶ 3 GND	▶ (A) 8 or (B) 12 GND	▶ 2
▶ 4 (Data-)	▶ (A) 9 or (B) 13 (Data-)	▶ 4
▶ 4 (Data-)	▶ (A) 9 or (B) 13 (Data-)	▶ 6

4. If no further inverter is connected, terminate the inverter according to the instructions for the inverter.
5. Close the inverter if no other inverters are to be connected.
6. Insert the terminal block connector into the Solar-Log™ RS485 socket.

Connect the inverters to each other

- Where to connect: Terminal strip inside the inverter
- 5-wire cabling

Procedure

1. Open the inverter according to the inverter's instructions.
2. Connect the other inverters to each other in the same way.
3. Terminate the last inverter according to the inverter instructions.
4. Close the inverter.
5. Communication address according to the inverter's instructions.
6. Recommendation: Continuous numbering starting with 1.
Address range 1 - 255.

89.2 SOCOMEK Sunsys B12/B30

Termination	Addressing	Interface
Yes	Yes	RS485

Selection available under SOCOMEK

Overview

- Integrated interface
- Where to connect: RJ45 sockets inside the inverter
- 3-pin wiring
- The communication address has to be assigned
- Installation steps
 - Switch off the inverters and Solar-Log™
 - Connect inverters to the Solar-Log™
 - Connect the inverters to each other according to the inverter instructions
 - Communication address according to the inverter's instructions
Address range 1 - 255

Connect inverters to the Solar-Log™

The wiring is done using a

- self-made cable connection with RS485 data cable and terminal block connector.

Procedure

1. Open the inverter according to the inverter's instructions.
2. If you are fabricating the cable yourself, connect the wires as shown in the following diagram.

Solar-Log™ terminal strip connector	Solar-Log Base RS485 (A) / (B)	RJ45 inverter
Terminal		PIN
▶ 1 (Data+)	▶ (A) 6 or (B) 10 (Data+)	▶ 5
▶ 3 GND	▶ (A) 8 or (B) 12 GND	▶ 7
▶ 4 (Data-)	▶ (A) 9 or (B) 13 (Data-)	▶ 4

3. Insert the RJ45 plug into the RJ45 socket on the first inverter.
4. If no further inverter is connected, terminate the inverter according to the instructions for the inverter.
5. Close the inverter if no other inverters are to be connected.
6. Insert the terminal block connector into the Solar-Log™ RS485 socket.

Connect the inverters to each other

- Connect using a data cable with an RJ45 plug.
- Where to connect: RJ45 sockets in the inverter.

Procedure

1. Open the inverter according to the inverter's instructions.
2. Insert the RJ45 plug into the RJ45 socket on the first inverter.
3. Insert the other end of the cable into the RJ45 socket on second inverter.
4. Connect the other inverters to each other in the same way.
5. Terminate the last inverter according to the inverter instructions.
6. Close the inverter.

Allocate communication address

- Recommendation: Continuous numbering starting with 1.
Address range 1 - 255.
- Procedure: Start according to the inverter's instructions.

90 SofarSolar

90.1 SofarSolar

Termination	Addressing	Interface
Yes	Yes	RS485

Selection available under SofarSolar

Supported models (Wiring via RJ45):

- SOFAR 4.4KTL-X – 12KTL-X
- SOFAR 10000TL – 20000TL
- SOFAR 30000TL – 40000TL
- SOFAR 50000TL – 70000TL

Supported models (Wiring via RS485 pin block):

- SOFAR 1100TL – 3000TL
- SOFAR 3000TLM – 6000TLM
- SOFAR 3KTLM-G2 – SOFAR 6KTLM-G2

Overview

- Integrated interface.
- Where to connect: RS485 pin block, inside the inverter.
- Where to connect: RJ45 socket inside the inverter.
- 2-pin wiring.
- The communication address has to be assigned.
- Installation steps:
 - Switch off the inverters and Solar-Log™
 - Connect inverters to the Solar-Log™.
 - Connect the inverters to each other according to the inverter instructions.

Connect inverters to the Solar-Log™ (via RJ45)

The wiring is done using a

- self-made RS485 data cable with RJ45 plug and terminal block connector.

Procedure

1. Open the inverter as shown in the inverter's instructions.
2. If you are making the cable yourself, connect the wires as shown in the following diagram:

Solar-Log™ terminal strip connector	Solar-Log Base RS485 (A) / (B)	RJ45 inverter
Terminal		Pin
▶ 1 (Data+)	▶ (A) 6 or (B) 10 (Data+)	▶ 2 RS485 A (+) (Orange)
▶ 4 (Data-)	▶ (A) 9 or (B) 13 (Data-)	▶ 1 RS485 B (-) (White and Orange)

3. In the inverter insert the RJ45 plug into the „RS-485 out“ socket.
4. If no further inverter is connected, terminate the inverter according to the instructions for the inverter.
5. Close the inverter if no other inverters are to be connected.
6. Insert the terminal block connector into the Solar-Log™ RS485 socket.

Connect the inverters to each other

- Wiring via data cable with RJ45 plug.
- Where to connect: RJ45 socket inside the inverter.

Connect inverters to the Solar-Log™ (via RS485 pin block)

The wiring is done using a

- self-made 2-pin cable connection and terminal strip connectors.

Procedure

1. Open the inverter as shown in the inverter's instructions.
2. If you are making the cable yourself, connect the wires as shown in the following diagram:

Solar-Log™ terminal strip connector Solar-Log Base RS485 (A) / (B) RS485 inverter pin block

Terminal		Pin
▶ 1 (Data+)	▶ (A) 6 or (B) 10 (Data+)	▶ TX+
▶ 4 (Data-)	▶ (A) 9 or (B) 13 (Data-)	▶ TX-

3. If no further inverter is connected, terminate the inverter according to the instructions for the inverter.
4. Close the inverter if no other inverters are to be connected.
5. Insert the terminal block connector into the Solar-Log™ RS485 socket.

Connect the inverters to each other:

- Connect the inverters to each other according to the inverter instructions.

Allocate communication address

- Recommendation: Continuous numbering starting with 1.
Address range 1-31
- Setting: Using the inverter operating display
- Procedure: Start according to the inverter's instructions



Note

A maximum of 31 inverters can be connected per RS485 bus.

91 SolarEdge

91.1 SolarEdge

Termination	Addressing	Interface
Switch	Yes	RS485

Overview

- Integrated interface
- Where to connect: Terminal strip inside the inverter
- Communication address must be allocated
- 3-pin wiring
- Installation steps
 - Switch off the inverters and Solar-Log™
 - Connect inverters to the Solar-Log™
 - Address inverter and set protocol
 - Connect the inverters to each other



Note

Installing a “SolarEdge-Gateway” on a RS485 bus, connecting SolarEdge inverters with a Solar-Log™, can lead to communication problems with the inverters. In order to ensure a correct communication with the Solar-Log™, the “Wireless package” switch must be activated on the respective I/O port in the web menu.

- ▶ The SolarEdge-Gateway is not supported on I/O port “C”, which has no wireless package option.

Connect inverters to the Solar-Log™

The wiring is done using a

- self-made cable connection with terminal block connector.

Procedure

1. Open the inverter as shown in the inverter's instructions.
2. Pull the free wires through the wire opening in the inverter.
3. If you are making the cable yourself, connect the wires as shown in the following diagram:

Solar-Log™ terminal strip connector Solar-Log Base RS485 (A) / (B) X4 socket RS485-1 inverter

Terminal		PIN
▶ 1 (Data+)	▶ (A) 6 or (B) 10 (Data+)	▶ A - Data+
▶ 3 GND	▶ (A) 8 or (B) 12 GND	▶ G - GND
▶ 4 (Data-)	▶ (A) 9 or (B) 13 (Data-)	▶ B - Data-

4. If no further inverter connected, terminate the inverter with DIP switch SW7 according to the manufacturer's instructions.
5. Screw the inverter cover on again.
6. Insert the terminal block connector into the Solar-Log™ RS485 socket.

Connect the inverters to each other

- Where to connect: Terminal strip inside the inverter

Procedure

1. Open the inverter as shown in the inverter's instructions.
2. Pull the free wires through the wire opening in the inverter.
3. If you are making the cable yourself, connect the wires as shown in the following diagram:

X4 socket RS485-1 inverter n

X4 socket RS485-1 inverter n+1

PIN		PIN
▶ A - Data+		▶ A - Data+
▶ G - GND		▶ G - GND
▶ B - Data-		▶ B - Data-

4. Connect the other inverters to each other in the same way.
5. Terminate the last inverter with DIP switch SW7 according to the manufacturer's instructions.
6. Screw the inverter cover on again.
7. Insert the terminal block connector into the Solar-Log™ RS485 socket.

Allocate communication address

- Recommendation: Continuous numbering starting with 1; highest possible address: 247.
- Setting: Using the inverter operating display
- Procedure: Start according to the inverter's instructions

Inverter settings

Two settings need to be checked on the inverter's control panel and changed if needed before performing the inverter detection.

1. **Non-SE Logger** has to be set in the **Communication // RS485-1 Conf // Device Type** menu.
2. **SunSpec** has to be activated in the **Communication // RS485-1 Conf // Protocol** menu.

92 SolarMax

92.1 SolarMax – S, MT, P, TS, TS-SV and HT- series

Termination	Addressing	Interface
No	Yes	RS485

Overview

- Integrated interface
- Where to connect: RJ45 socket on the outside of the inverter
- Where to connect HT series: RJ45 socket inside the inverter
- 2-pin wiring
- Communication address must be allocated.
- Installation steps
 - Switch off the inverters and Solar-Log™
 - Connect inverters to the Solar-Log™
 - Connect the inverters to each other
 - Allocate communication address

Connect inverters to the Solar-Log™

The wiring is done using a

- ready-made data cable (optional extra; not supplied)

or

- self-made RS485 data cable with RJ45 plug and terminal block connector.



Caution

Risk of damage to the unit!

The Solar-Log™ also has an RJ45 socket, which must never be connected to the RJ45 socket on the inverter.

- ▶ Only connect inverters via the RS485/422 Solar-Log™ interface(s).

Procedure

1. If you are making the cable yourself, connect the wires as shown in the following diagram:

Solar-Log™ terminal strip connector	Solar-Log Base RS485 (A) / (B)	RJ45 inverter
Terminal		PIN
▶ 1 (Data+)	▶ (A) 6 or (B) 10 (Data+)	▶ 7
▶ 4 (Data-)	▶ (A) 9 or (B) 13 (Data-)	▶ 8

2. Insert the RJ45 plug into any RJ45 socket on the first inverter.
3. Insert the terminal block connector into the Solar-Log™ RS485 socket.

Connect the inverters to each other

- Connect using the RS485 data cable with an RJ45 plug
- Where to connect: RJ45 socket on the outside of the inverter
- Where to connect HT series: RJ45 socket inside the inverter

Procedure

1. Insert the RJ45 plug into the free RJ45 socket on the first inverter.
2. Insert the other end of the wire into any RJ45 socket on inverter 2.
3. Connect the other inverters to each other in the same way.

Allocate communication address

- Recommendation: Continuous numbering starting with 1.
- Setting: Using the inverter operating display
- Procedure: Start according to the inverter's instructions



Notice concerning the RS485 wiring of the SolarMax P series:

The P series from SolarMax does not support RS485 "Daisy Chain" connections. This means that multiple inverters cannot be connected together on the same RS485 bus cable.

For this reason, a maximum of one inverter of the P series can be connected to the respective RS485 ports (A/B/C, max. 3) of a Solar-Log™.

- ▶ Alternatively to using the RS485 variation, you can connect multiple P series inverters to the Solar-Log™ by means the Ethernet connection to the LAN.



Note

The inverter's factory setting is communication address 255.

- ▶ On the inverter operating display set the communication address manually to 1 even if only one inverter is connected to the Solar-Log™.

S series:

- ▶ When setting the communication address on the inverter display only the RS485 interface must be activated (set at the factory), not the Ethernet interface that is also installed in the inverter.



Note regarding the HT series:

Inverter models that have more than 3 MPP trackers are subdivided by the Solar-Log™ into multiple "virtual" devices. Thus, for inverter type 32HT4, for example, with 4 MPP trackers, two virtual devices are detected.

- ▶ The reason for this is because the Solar-Log™ is limited to a maximum of 3 MPP trackers per inverter.



Note for feed-in management

The inverter itself has to be configured with MaxTalk2 (SolarMax's software) and set to "Remote mode" to be able to use reactive power management. Please refer to the inverter instructions for more information on this topic.



Note

Power reduction of the SolarMax S series inverters only works with firmware version 1.5.12800 and higher.

Devices from serial number 186288 can be provided with a firmware update by an installer.

Unfortunately, devices with a serial number < 186288 cannot be controlled.

92.2 SolarMax - C series

Termination	Addressing	Interface
No	Yes	RS485

Overview

- Integrated interface
- Where to connect: RJ45 socket on the outside of the inverter
- 6-pin wiring
- Communication address must be allocated.
- Installation steps
 - Switch off the inverters and Solar-Log™
 - Connect inverters to the Solar-Log™
 - Connect the inverters to each other
 - Allocate communication address

Connect inverters to the Solar-Log™

The wiring is done using a

- ready-made data cable (optional extra; not supplied)
- or
- self-made RS485 data cable with RJ45 plug and terminal block connector.



Caution

Risk of damage to the unit!

The Solar-Log™ also has an RJ45 socket, which must never be connected to the RJ45 socket on the inverter.

- ▶ Only connect inverters via the RS485/422 Solar-Log™ interface(s).

Procedure

1. If you are making the cable yourself, connect the wires as shown in the following diagram:

Solar-Log™ terminal strip connector	Solar-Log Base RS485 (A) / (B)	RJ45 inverter
Terminal		PIN
▶ 1 (Data+)	▶ (A) 6 or (B) 10 (Data+)	▶ 7
▶ 2 12 V	▶ (A) 7 or (B) 11	▶ 1
▶ 2 12 V	▶ (A) 7 or (B) 11	▶ 2
▶ 3 GND	▶ (A) 8 or (B) 12 GND	▶ 3
▶ 3 GND	▶ (A) 8 or (B) 12 GND	▶ 4
		5 - unused
		6 - unused
▶ 4 (Data-)	▶ (A) 9 or (B) 13 (Data-)	▶ 8

2. Insert the RJ45 plug into any RJ45 socket on the first inverter.
3. Insert the terminal block connector into the Solar-Log™ RS485 socket.

Connect the inverters to each other

- Connect using the RS485 data cable with an RJ45 plug
- Where to connect: RJ45 socket on the outside of the inverter

Procedure

1. Insert the RJ45 plug into the free RJ45 socket on the first inverter.
2. Insert the other end of the wire into any RJ45 socket on inverter 2.
3. Connect the other inverters to each other in the same way.

Allocate communication address

- Recommendation: Continuous numbering starting with 1.
- Setting: Using the inverter operating display
- Procedure: Start according to the inverter's instructions



Note

The inverter's factory setting is communication address 255.

- ▶ On the inverter operating display set the communication address manually to 1 even if only one inverter is connected to the Solar-Log™.
-



Note for feed-in management

The inverter itself has to be configured with MaxTalk2 (SolarMax's software) and set to "Remote mode" to be able to use reactive power management. Please refer to the inverter instructions for more information on this topic.

92.3 SolarMax – Cx series

Termination	Addressing	Interface
No	Yes	RS485

Overview

- Interface not integrated; Retrofit RS485 interface card
- 6-pin wiring
- Communication address must be allocated
- Installation steps
 - Switch off the inverters and Solar-Log™
 - Install the RS485 interface in the inverter
 - Connect inverters to the Solar-Log™
 - Connect the inverters to each other
 - Allocate communication address

Installing the RS485 interface

Procedure

- ▶ Install the RS485 interface in the inverter in accordance with the interface card installation instructions.

Connect inverters to the Solar-Log™

The wiring is done using a

- ready-made data cable (optional extra; not supplied)

or

- self-made cable connection using RS485 data cable with RJ45 plug and terminal block connector



Caution

Risk of damage to the unit!

The Solar-Log™ also has an RJ45 socket, which must never be connected to the RJ45 socket on the inverter.

- ▶ Only connect inverters via the RS485/422 Solar-Log™ interface(s).

Procedure

1. Open the inverter as shown in the inverter's instructions.
2. If you are making the cable yourself, connect the wires as shown in the following diagram:

Solar-Log™ terminal strip connector	Solar-Log Base RS485 (A) / (B)	RJ45 inverter
Terminal		PIN
▶ 1 (Data+)	▶ (A) 6 or (B) 10 (Data+)	▶ 7
▶ 2 12 V	▶ (A) 7 or (B) 11	▶ 1
▶ 2 12 V	▶ (A) 7 or (B) 11	▶ 2
▶ 3 GND	▶ (A) 8 or (B) 12 GND	▶ 3
▶ 3 GND	▶ (A) 8 or (B) 12 GND	▶ 4
		5 - unused
		6 - unused
▶ 4 (Data-)	▶ (A) 9 or (B) 13 (Data-)	▶ 8

3. Insert the RJ45 plug into any RJ45 socket on inverter 1.
4. Close the inverter if no other inverters are to be connected.
5. Insert the terminal block connector into the Solar-Log™ RS485 socket.

Connect the inverters to each other

- Connect using a network cable (patch cable)
- Where to connect: RJ45 socket inside the inverter (on the retrofitted RS485 interface)

Procedure

1. Open the inverter as shown in the inverter's instructions.
2. Insert the RJ45 plug into any RJ45 socket on inverter 1.
3. Insert the other end of the wire into any RJ45 socket on inverter 2.
4. Connect the other inverters to each other in the same way.
5. Close inverters.

Allocate communication address

- Recommendation: Continuous numbering starting with 1.
- Setting: Using the inverter operating display
- Procedure: Start according to the inverter's instructions



Note for feed-in management

The inverter itself has to be configured with MaxTalk2 (SolarMax's software) and set to "Remote mode" to be able to use reactive power management. Please refer to the inverter instructions for more information on this topic.

92.4 SolarMax – E series

Termination	Addressing	Interface
No	Yes	RS485

Overview

- Interface not integrated; Retrofit RS485 interface card
- 6-pin wiring
- Communication address must be allocated
- Installation steps
 - Switch off the inverters and Solar-Log™
 - Install the RS485 interface in the inverter
 - Connect inverters to the Solar-Log™
 - Connect the inverters to each other
 - Allocate communication address

Installing the RS485 interface

Procedure

- ▶ Install the RS485 interface in the inverter in accordance with the interface card installation instructions.

Connect inverters to the Solar-Log™

The wiring is done using a

- ready-made data cable (optional extra; not supplied)

or

- self-made cable connection using RS485 data cable, RJ45 plug and terminal block connector.



Caution

Risk of damage to the unit!

The Solar-Log™ also has an RJ45 socket, which must never be connected to the RJ45 socket on the inverter.

- ▶ Only connect inverters via the RS485/422 Solar-Log™ interface(s).

Procedure

1. Open the inverter as shown in the inverter's instructions.
2. If you are making the cable yourself, connect the wires as shown in the following diagram:

Solar-Log™ terminal strip connector	Solar-Log Base RS485 (A) / (B)	RJ45 inverter
Terminal		PIN
▶ 1 (Data+)	▶ (A) 6 or (B) 10 (Data+)	▶ 7
▶ 2 12 V	▶ (A) 7 or (B) 11	▶ 1
▶ 2 12 V	▶ (A) 7 or (B) 11	▶ 2
▶ 3 GND	▶ (A) 8 or (B) 12 GND	▶ 3
▶ 3 GND	▶ (A) 8 or (B) 12 GND	▶ 4
		5 - unused
		6 - unused
▶ 4 (Data-)	▶ (A) 9 or (B) 13 (Data-)	▶ 8

3. Run the wire from the Solar-Log™ to inverter 1 through the hole for the wire on the bottom of the unit.
4. In the inverter insert the RJ45 plug into the „RS-485 out“ socket.
5. Close the inverter if no other inverters are to be connected.
6. Insert the terminal block connector into the Solar-Log™ RS485 socket.

Connect the inverters to each other

- Connect using the RS485 data cable with an RJ45 plug
- Where to connect: RJ45 socket inside the inverter (on the retrofitted RS485 interface)

Procedure

1. Open the inverter as shown in the inverter's instructions.
2. Run the wire from inverter 1 to inverter 2 through the hole for the wire on the bottom of the unit.
3. Insert the RJ45 plug into the „RS485 in“ socket in inverter 1.
4. Insert the other end of the cable with the RJ45 plug into the „RS485 out“ socket in inverter.
5. Connect the other inverters using the „RS-485 in“ and „RS485 out“ sockets.
6. Two cables will be run through each inverter.
7. Close inverters.

Allocate communication address

- Recommendation: Continuous numbering starting with 1.
- Setting: Using the inverter operating display
- Procedure: Start according to the inverter's instructions



Note for feed-in management

The inverter itself has to be configured with MaxTalk2 (SolarMax's software) and set to "Remote mode" to be able to use reactive power management. Please refer to the inverter instructions for more information on this topic.

92.5 SolarMax via Ethernet interface

Termination	Addressing	Interface
No	Yes	LAN

Overview

- Integrated interface
- The inverter's IP address has to be assigned
- Connected using a network cable (patch cable) and Ethernet router or switch
- Installation steps
 - The inverter has to be assigned a static IP address
 - Switch off the inverters and Solar-Log™
 - Connect inverters to the Solar-Log™ (RJ45)
 - Connect the inverters to each other (RJ45)

Connect inverters to the Solar-Log™

The wiring is done using a

- network cable (patch cable/crossover cable) and the
- Ethernet router or switch.

Connect the inverters to each other

The inverters are connected together using the RJ45 interface and, if needed, a router or switch.

Follow the connection setup according to the inverter's instructions.

Assigning IP addresses

- A static IP address has to be assigned to the inverter via the display.
- Please select an IP address with the same class C subnet as the Solar-Log™.
For example: The Solar-Log™ has the IP address 192.168.178.49.
The inverter in this case has to have a free IP address in the same range (from 192.168.178.1 to 192.168.178.254).
- Procedure: Start according to the inverter's instructions.



Notes on inverter configuration

- ▶ The inverter's Ethernet interface has to be activated.
- ▶ Only the TCP port "12345" is supported.



Note for feed-in management

The inverter itself has to be configured with MaxTalk2 (SolarMax's software) and set to "Remote mode" to be able to use reactive power management. Please refer to the inverter instructions for more information on this topic.

93 SolaX Power

93.1 SolaX Power X1

Termination	Addressing	Interface
Yes	Automatic	RS422

The following types are to be connected according to this diagram:

- SL-TL1500, SL-TL2200, SL-TL2500, SL-TL2800, SL-TL3000, SL-TL3300T, SL-TL3600T, SL-TL4400T, SL-TL5000T

Select SolaXPower X1 during the inverter detection.

Overview

- Integrated interface
- 2 RJ45 sockets on the outside of the inverter
- 4-pin wiring - only on RS485/422 B or C connection of the Solar-Log™
- Communication address does not have to be assigned
- Installation steps
 - Switch off the inverters and Solar-Log™
 - Connect inverters to the Solar-Log™
 - Connect the inverters to each other



Note

Only connect inverter using the RS485/422 B or C interface.

Connect inverters to the Solar-Log™.

The wiring is done using a

- self-made, shielded 8 wire data cable and terminal block connector.
- Where to connect: RJ45 socket on the inverter



Caution

Risk of damage to the unit!

The Solar-Log™ also has an RJ45 socket, which must never be connected to the RJ45 socket on the inverter.

- ▶ Only connect inverters via the RS485/422 Solar-Log™ interface(s).

Procedure

1. If you make the cable yourself, connect the wires as shown in the following diagram.

Solar-Log™ terminal strip connector	Solar-Log Base RS422	RJ45 inverter
Terminal		PIN
▶ 1 (T/RX+)	▶ 6 (T/RX+)	▶ Pin 3 - TX+
▶ 4 (T/RX-)	▶ 9 (T/RX-)	▶ Pin 6 - TX-
▶ 5 (R/TX+)	▶ 10 (R/TX+)	▶ Pin 1 - RX+
▶ 6 (R/TX-)	▶ 13 (R/TX-)	▶ Pin 2 - RX-

2. Insert the RJ45 plug into any RJ45 socket on inverter 1.
3. If no further inverter is connected, terminate the inverter according to the instructions for the inverter.
4. Insert the terminal block connector into the Solar-Log™ RS485/422 B or C socket.

Connect the inverters to each other

- Connect using a RJ45 cable (patch cable).
- Where to connect: RJ45 socket.

Procedure

1. Insert the self-made cable with the RJ45 plug into any RJ45 socket on inverter 1. Connect the other end to the terminal plug on the Solar-Log™.
2. Insert the RJ45 cable into the 2nd RJ45 socket on inverter 1 and into any RJ45 socket on inverter 2.
3. Connect the other inverters to each other in the same way.
4. Insert the terminal block connector into the Solar-Log™ RS485/422 B or C socket.
5. Terminate the last inverter in accordance with the inverter instructions.



Note

A maximum of 32 inverters can be connected per RS422 bus.

93.2 SolaX Power X3

Termination	Addressing	Interface
Yes	Yes	RS485

The following types are to be connected according to this diagram:

- ZDNY-TL10000, ZDNY-TL12000, ZDNY-TL15000, ZDNY-TL17000

Select SolaXPower X3 during the inverter detection.

Overview

- Integrated interface.
- 2 RJ45 sockets on the outside of the inverter.
- 2-pin wiring.
- Communication address must be allocated.
- Installation steps
 - Switch off the inverters and Solar-Log™.
 - Connect inverters to the Solar-Log™.
 - Connect the inverters to each other
 - Allocate communication address.
Address range 1 to 247
Settings on the inverter's display according to the manufacturer's manual.

Connect inverters to the Solar-Log™.

The wiring is done using a

- self-made, shielded 8 wire data cable and terminal block connector.
- Where to connect: RJ45 socket on the inverter

Procedure

1. If you make the cable yourself, connect the wires as shown in the following diagram.

Solar-Log™ terminal strip connector	Solar-Log Base RS485 (A) / (B)	RS485 inverter socket
Terminal		PIN
▶ 1 (Data+)	▶ (A) 6 or (B) 10 (Data+)	▶ Pin 4 - Data+
▶ 4 (Data-)	▶ (A) 9 or (B) 13 (Data-)	▶ Pin 5 - Data-

2. Insert the RJ45 plug into any RJ45 socket on inverter 1.
3. If no further inverter is connected, terminate the inverter according to the instructions for the inverter.
4. Insert the terminal block connector into the Solar-Log™ RS485 socket.

Connect the inverters to each other

- Connect using a RJ45 cable.
- Where to connect: RJ45 socket.

Procedure

1. Insert the self-made cable with the RJ45 plug into any RJ45 socket on inverter 1. Connect the other end to the terminal plug on the Solar-Log™.
2. Insert the RJ45 cable into the 2nd RJ45 socket on inverter 1 and into any RJ45 socket on inverter 2.
3. Connect the other inverters to each other in the same way.
4. Insert the terminal block connector into the Solar-Log™ RS485 socket.
5. Terminate the last inverter in accordance with the inverter instructions.

Allocate communication address

1. Recommendation: Continuous numbering starting with 1.
Address range 1 - 247.
2. Setting: Using the inverter operating display.
3. Procedure: Start according to the inverter's instructions.



Note

A maximum of 32 inverters can be connected per RS485 bus.

94 Solectria

94.1 Solectria V1 (>9k)

Termination	Addressing	Interface
Yes	Yes	RS485

Selection available under Solectria V1

The following types are to be connected according to this diagram:

- PVI 10KW
- PVI 13KW
- PVI 15KW
- PVI 100KW

Overview

- Integrated interface
- Where to connect: Terminal strip inside the inverter
- 3-pin wiring
- Communication address must be allocated.
- Installation steps
 - Switch off the inverters and Solar-Log™
 - Connect inverters to the Solar-Log™
 - Connect the inverters to each other
 - Change the communication address if required.
Every address may only be used once.
Address range 1 to 16.

Connect inverters to the Solar-Log™

The wiring is done using a

- self-made cable connection with terminal block connector.
- Where to connect: Terminal strip inside the inverter

Procedure

1. If you are making the cable yourself, connect the wires as shown in the following diagram:

Solar-Log™ terminal strip connector Solar-Log Base RS485 (A) / (B) Terminal strip inside the inverter

Terminal		PIN
▶ 1 (Data+)	▶ (A) 6 or (B) 10 (Data+)	▶ RS485 A
▶ 3 GND	▶ (A) 8 or (B) 12 GND	▶ RS485 G
▶ 4 (Data-)	▶ (A) 9 or (B) 13 (Data-)	▶ RS485 B

2. If no further inverter is connected, terminate the inverter according to the instructions for the inverter.
3. Insert the terminal block connector into the Solar-Log™ RS485 socket.

Connect the inverters to each other

- Connect with a shielded twisted-pair cable.
- Where to connect: Terminal strip inside the inverter

Procedure

1. If you make the cable yourself, connect the wires as shown in the diagram:

Terminal strip inside the inverter	Terminal strip inside the inverter
PIN	PIN
▶ RS485 A	▶ RS485 A
▶ RS485 G	▶ RS485 G
▶ RS485 B	▶ RS485 B

2. Wire the remaining inverters to each other according to the manufacturer's specifications.
3. Terminate the last inverter according to the inverter instructions.
4. Insert the terminal block connector into the Solar-Log™ RS485 socket.

The RS485 connections on the terminal strip are each double connections so that the wiring can also be continued to the next inverter.

Procedure

1. Connect the data cable to the free blocks A, B and G on inverter 1.
2. Connect the other end of the cable to the blocks A, B and G on inverter 2.
3. Connect the remaining inverters in the same way.
4. Terminate the last inverter according to the manufacturer's instructions.
5. Close the inverter if no other inverters are to be connected.

Notes on inverter addresses

- Recommendation: Continuous numbering starting with 1.
- Settings: On the inverter operating display.
- Procedure: Follow the manufacturer's documentation for the inverter.



Note

Check the baud rate on the inverters. The baud rate has to be set to 19200 with one Stop Bit and No Parity (19200-8N1). Set the baud rate according to the instructions of the inverter manufacturer.

94.2 Solectria V2 (<9k)

Termination	Addressing	Interface
Yes	No	RS485

Selection available under Solectria V2

The following types are to be connected according to this scheme:

- PVI 3000
- PVI 4000
- PVI 5000
- PVI 5300

Overview

- Integrated interface
- Where to connect: RJ45 plug outside the housing floor
- 3-pin wiring
- Communication address does not have to be assigned
- Installation steps
 - Switch off the inverters and Solar-Log™
 - Connect inverters to the Solar-Log™
 - Connect the inverters to each other

Connect inverters to the Solar-Log™

The wiring is done using a

- ready-made BRJ2 data cable (optional extra; not supplied)
- or
- self-made cable connection with RS485 data cable and terminal block connector.



Caution

Risk of damage to the unit!

The Solar-Log™ also has an RJ45 socket, which must never be connected to the RJ45 socket on the inverter.

- ▶ Only connect inverters via the RS485/422 Solar-Log™ interface(s).

Procedure

1. If you are making the cable yourself, connect the wires as shown in the following diagram:

Solar-Log™ terminal strip connector	Solar-Log Base RS485 (A) / (B)	RJ45 inverter
Terminal		PIN
▶ 1 (Data+)	▶ (A) 6 or (B) 10 (Data+)	▶ 7 (TX A)
▶ 3 GND	▶ (A) 8 or (B) 12 GND	▶ 4 or 5 (GND)
▶ 4 (Data-)	▶ (A) 9 or (B) 13 (Data-)	▶ 8 (RX B)

2. Insert the RJ45 plug into the RJ45 socket on the inverter.
3. If no further inverter is connected, terminate the inverter according to the instructions for the inverter (DIP switch on the device).
4. Insert the terminal block connector into the Solar-Log™ RS485 socket.

Connect the inverters to each other

- Connect using a network cable (patch cable)
- Where to connect: RJ45 socket (RJ45 R and L) on the outside of the inverter,

Procedure

1. Insert the RJ45 plug into the free RJ45 socket on the first inverter.
2. Insert the other end of the wire into any RJ45 socket on inverter 2.
3. Connect the other inverters to each other in the same way.
4. Terminate the last inverter in accordance with the inverter instructions.



Note

Every inverter has to have an unique ID number (address) between 1 and 16. Please contact Solectria Renewables for support if you have inverters with the same ID number. Only the manufacturer can change the ID numbers.

94.3 Solectria V3 (<3k)

Termination	Addressing	Interface
Yes	Yes	RS485

Selection available under Solectria V3

The following types are to be connected according to this scheme:

- PVI 1800
- PVI 2500

Overview

- Integrated interface.
- Where to connect: Terminal strip inside the inverter.
- 3-pin wiring.
- The communication address has to be assigned.
- Installation steps
 - Switch off the inverters and Solar-Log™
 - Connect inverters to the Solar-Log™
 - Set the communication address according to the inverter's instructions. Address range 1 - 254.
 - Connect the inverters to each other.
 - Terminate the inverter according to the inverter's instructions.

Connect inverters to the Solar-Log™

The wiring is done using a

- self-made data cable.

Procedure

1. Open the inverter according to the inverter's instructions.
2. Pull the free wires through the wire opening in the inverter.
3. If you are making the cable yourself, connect the wires as shown in the following diagram:

Solar-Log™ terminal strip connector Solar-Log Base RS485 (A) / (B) Terminal strip inverter

Terminal		PIN
▶ 1 (Data+)	▶ (A) 6 or (B) 10 (Data+)	▶ 7 TX_A
▶ 3 GND	▶ (A) 8 or (B) 12 GND	▶ 4 GND
▶ 4 (Data-)	▶ (A) 9 or (B) 13 (Data-)	▶ 6 RX_B

4. If no further inverter is connected, terminate the inverter according to the instructions for the inverter.
5. Close the inverter if no other inverters are to be connected.
6. Insert the terminal block connector into the Solar-Log™ RS485 socket.

Connect the inverters to each other

- Where to connect: Inside the inverter.
- Connect the wires according to the inverter's instructions.

Procedure

1. Open the inverter according to the inverter's instructions.
2. Connect the other inverters to each other in the same way.
3. Terminate the last inverter according to the inverter instructions.
4. Close the inverter.
5. Set the communication address via the display according to the inverter's instructions. Recommendation:
Continuous numbering starting with 1. Address range 1 - 254.



Note

Check the baud rate for the inverter. The baud rate has to be set to 19200 with stop bits and without parity (19200-8N1). Follow the manufacturer's instructions for setting the baud rate.

94.4 Solectria V4

Termination	Addressing	Interface
Yes	Yes	RS485

Selection available under Solectria V4

The following types are to be connected according to this diagram:

- PVI 14TL
- PVI 20TL
- PVI 23TL
- PVI 28TL
- PVI 36TL
- PVI 50TL
- PVI 60TL

Overview

- Integrated interface
- Where to connect: Terminal strip inside the inverter.
- 4-pin wiring.
- The communication address has to be assigned.
- Installation steps
 - Switch off the inverters and the Solar-Log™.
 - Connect inverters to the Solar-Log™.
 - Connect the inverters to each other.
 - Allocate communication address.
Address range 1 to 254
Settings on the inverter's display according to the manufacturer's manual.

Connect inverters to the Solar-Log™.

The wiring is done using a

- self-made cable connection with terminal block connector.
- Where to connect: Terminal strip inside the inverter.

Procedure

1. If you are making the cable yourself, connect the wires as shown in the following diagram:

Solar-Log™ terminal strip connector	Solar-Log Base RS485 (A) / (B)	RJ45 inverter
Terminal		PIN
▶ 1 (Data+)	▶ (A) 6 or (B) 10 (Data+)	▶ RS485+
▶ 3 GND	▶ (A) 8 or (B) 12 GND	▶ GND
▶ 4 (Data-)	▶ (A) 9 or (B) 13 (Data-)	▶ RS485-

2. If no further inverter is connected, terminate the inverter according to the instructions for the inverter.
3. Insert the terminal block connector into the Solar-Log™ RS485 socket.

Connect the inverters to each other.

- Connect using a network cable (patch cable).
- Where to connect: RJ45 sockets inside the inverter.

Procedure

1. Insert the RJ45 plug into the free RJ45 socket on the first inverter.
2. Insert the other end of the wire into any RJ45 socket on inverter 2.
3. Connect the other inverters to each other in the same way.
4. Terminate the last inverter in accordance with the inverter instructions.

94.5 Solectria V5

Termination	Addressing	Interface
Jumper	Yes	RS485

Selection under „Solectria V5“

Supported models:

- PVI 3800 TL
- PVI 5200 TL
- PVI 6600 TL
- PVI 7600 TL

Overview

- Integrated interface.
- Where to connect: Terminal block inside the inverter.
- 3-pin wiring.
- The communication address has to be assigned.
- Installation steps:
 - Switch off the inverters and the Solar-Log™.
 - Connect the inverters to the Solar-Log™.
 - Connect the inverters to each other.
 - Assign the communication address.
Address range 1 - 254.
Settings on the inverter's display according to the manufacturer's manual.

Connect the inverters to the Solar-Log™

The wiring is done using a

- self-made connection cable.
- Where to connect: Terminal block inside the inverter.

Procedure

1. If you are making the cable yourself, connect the wires as shown in the following diagram:

Solar-Log™ terminal strip connector	Solar-Log Base RS485 (A) / (B)	Terminal block inside the second inverter (J1)
Terminal		PIN
▶ 1 (Data+)	▶ (A) 6 or (B) 10 (Data+)	▶ 7 TX A (RS485+)
▶ 3 GND	▶ (A) 8 or (B) 12 GND	▶ 4 GND (RS485)
▶ 4 (Data-)	▶ (A) 9 or (B) 13 (Data-)	▶ 8 RX B (RS485-)

2. Terminate the inverter if no additional inverters are to be connected:
Set the jumper to „On“ (refer to the inverter's instructions).
3. Insert the terminal block connector into the Solar-Log™ RS485 socket.

Connect the inverters to each other

- Connect with a shielded twisted-pair cable.
- Where to connect: Terminal strip inside the inverter.

Procedure

1. Open the inverter according to the inverter's instructions.
2. Connect the data cable to the terminal block in J1 of inverter 1 (according to the inverter's instructions), connect another data cable to the terminal block J2 of inverter 1 (according to the inverter's instructions), then connect it to inverter 2 via J1 (according to the inverter's instructions).
3. Connect the other inverters to each other in the same way.
4. Terminate the last inverter:
Set the jumper to „On“ (refer to the inverter's instructions).



Note

A maximum of 16 inverters can be connected per RS485 bus.
The maximum cable length is 1000 meters.

95 Solutronic

95.1 Solutronic SP25-55 (RS485)

Termination	Addressing	Interface
Yes	Yes	RS485



Note

The same protocol must be selected on both devices in order to ensure correct communication between the Solar-Log™ and the inverters.

Protocol selection for device detection:

- Solutronic: Protocol 1
- Solutronic: Protocol 9

Overview

- Integrated interface
- Where to connect: Terminal strip on the outside of the inverter
- 3-pin wiring
- Communication address must be allocated
- All inverters must be fitted with firmware version 1.2.39 or later
- Inverters must be grounded otherwise this could lead to problems with inverter detection
- Installation steps
 - Switch off the inverters and Solar-Log™
 - Connect inverters to the Solar-Log™
 - Connect the inverters to each other
 - Allocate communication address

Connect inverters to the Solar-Log™

The wiring is done using a

- ready-made data cable (optional extra; not supplied)

or

- self-made, shielded 3 wire data cable and terminal block connector.

Procedure

1. If you are making the cable yourself, connect the wires as shown in the following diagram:

Solar-Log™ terminal strip connector	Solar-Log Base RS485 (A) / (B)	Inverter terminal strip
Terminal		Terminal
▶ 1 (Data+)	▶ (A) 6 oder (B) 10 (Data+)	▶ Pin 1 RS485-A
▶ 3	▶ (A) 8 oder (B) 12 GND	▶ Pin 3 GND
▶ 4	▶ (A) 9 oder (B) 13 (Data-)	▶ Pin 2 RS485-B

2. If no further inverter connected, terminate the inverter:
You will find detailed instructions for setting the inverters on the Solutronic website.
3. Close the inverter if no other inverters are to be connected.
4. Insert the terminal block connector into the Solar-Log™ RS485 socket.

Connect the inverters to each other

- Connect using a 3 wire, shielded data cable
- Where to connect: Terminal strip on the outside of the inverter

Procedure

1. Insert the plug into the X2 socket on inverter 1.
2. Insert the other end of the wire into the X2 socket on inverter 2.
3. Connect the other inverters to each other in the same way.
4. Terminate the last inverter.
Detailed instructions for setting the inverters are available on the Solutronic website.

Allocate communication address

- Recommendation: Continuous numbering starting with 1.
- Setting: Using the inverter's control panel (starting with inverter firmware 2.62 parameter 89 and parameter 230 for older firmware versions):
- In addition, set the COM port to Protocol 1 - Solutronic protocol (parameter 265).
- Procedure: Start according to the inverter's instructions



Note

The mode „Fixed cos Phi external“ or „power reduction“ has to be set according to the manufacturer's specifications for all of the inverters to use active and reactive power management.

95.2 Solutronic (SP)80, 100, 120, (SE)40S1, 40S2, 50S2, 60S2 (RS485)

Termination	Addressing	Interface
Yes	Yes	RS485



Note

The same protocol must be selected on both devices In order to ensure correct communication between the Solar-Log™ and the inverters.

Protocol selection for device detection:

- Solutronic: Protocol 1
- Solutronic: Protocol 9

Overview

- Integrated interface
- Where to connect: Round pin plug on the outside of the inverter.
- 3-pin wiring
- Communication address must be allocated.
- All inverters must be fitted with firmware version 1.2.39 or later.
- Inverters must be grounded otherwise this could lead to problems with inverter detection.
- Installation steps
 - Switch off the inverters and Solar-Log™
 - Connect inverters to the Solar-Log™
 - Connect the inverters to each other
 - Allocate communication address

Connect inverters to the Solar-Log™

- ready-made data cable (optional extra; not supplied)
- or
- self-made, shielded 3 wire data cable and terminal block connector.

Procedure

1. If you are making the cable yourself, connect the wires as shown in the following diagram:

Solar-Log™ terminal strip connector	Solar-Log Base RS485 (A) / (B)	Inverter terminal strip
Terminal		Terminal
▶ 1 (Data+)	▶ (A) 6 or (B) 10 (Data+)	▶ 2 - Data +
▶ 3 GND	▶ (A) 8 or (B) 12 GND	▶ 3 - Ground
▶ 4 (Data-)	▶ (A) 9 or (B) 13 (Data-)	▶ 4 - Data -

2. Terminate pin 1 on the terminal block connector and pin 4 on the Solar-Log™ using the 120 Ω terminal resistor.
3. Terminate on the inverter in accordance with the manufacturer's handbook.
4. Close the inverter if no other inverters are to be connected.
5. Insert the terminal block connector into the Solar-Log™ RS485 socket.

Connect the inverters to each other

- Connection in the master-slave data network using an 1:1 cable with M12 plug connector (available as an optional extra from Solutronic).
- Sockets X6 and X7 are connected to each other electrically.
- Where to connect: Round pin plug on the outside of the inverter.

Procedure

1. Insert the plug into the X6 socket on inverter 1.
2. Insert the other end of the wire into the X7 socket on inverter 2.
3. Connect the other inverters to each other in the same way.
4. Terminate the last inverter according to the manufacturer's instructions.

Allocate communication address

- Setting: Using the inverter's control panel, parameter 89 in the communication menu.
Recommendation: Continuous numbering starting with 1.
Set this in the SSP address menu item.
- Procedure: Start according to the inverter's instructions.



Note

The mode Fixed cos Phi has to be set according to the manufacturer's specifications for all of the inverters to use active and reactive power management.

96 Steca

96.1 Steca

Termination	Addressing	Interface
Termination plug	Yes	RS485

Select "Steca: Standard" for the device detection.

Overview

- Integrated interface
- Where to connect: RJ socket, on the outside of the inverter's interface card.
- 2-pin wiring
- Communication address must be allocated.
- Installation steps
 - Switch off the inverters and Solar-Log™
 - Connect inverters to the Solar-Log™
 - Connect the inverters to each other
 - Allocate communication address

Connect inverters to the Solar-Log™

The wiring is done using a

- ready-made data cable (optional extra; not supplied)
- or
- self-made RS485 data cable with RJ45 plug and terminal block connector.



Caution

Risk of damage to the unit!

The Solar-Log™ also has an RJ45 socket, which must never be connected to the RJ45 socket on the inverter.

- ▶ Only connect inverters via the RS485/422 Solar-Log™ interface(s).

Procedure

1. If you are making the cable yourself, connect the wires as shown in the following diagram:

Solar-Log™ terminal strip connector	Solar-Log Base RS485 (A) / (B)	RJ45 inverter
Terminal		PIN
▶ 1 (Data+)	▶ (A) 6 or (B) 10 (Data+)	▶ 1
▶ 4 (Data-)	▶ (A) 9 or (B) 13 (Data-)	▶ 2

2. Insert the RJ45 plug into any RJ45 socket on the first inverter.
3. If no further inverter connected, terminate the inverter:
On the inverter insert the connection plug into the free RJ45 socket.
4. Insert the terminal block connector into the Solar-Log™ RS485 socket.

Connect the inverters to each other

- Connect using the RS485 data cable with RJ45 plug;
Connection cables between the inverters are supplied with the inverters. Use these.
- Where to connect: RJ45 socket on the outside of the inverter

Procedure

1. Insert the RJ45 plug into the free RJ45 socket on the first inverter.
2. Insert the other end of the wire into any RJ45 socket on inverter 2.
3. Connect the other inverters to each other in the same way.
4. Terminate the last inverter.
Insert the connection plug into the free RJ45 socket.

Allocate communication address

1. Recommendation: Continuous numbering starting with 1.
2. Setting: Using the rotating switch on the inverter interface card.
3. Procedure: Start according to the inverter's instructions

96.2 Steca (>=17k)

Termination	Addressing	Interface
Yes	Yes	RS485

Select "Steca: USS / >=17kW" for the device detection.

Overview

- Integrated interface
- Where to connect: RJ45 socket on the bottom of the inverter
- 2-pin wiring
- Communication address must be allocated
- Installation steps
 - Switch off the inverters and Solar-Log™
 - Connect inverters to the Solar-Log™
 - Connect the inverters to each other

Select the Steca >=17k inverter during the initial configuration.



Note

To use active and reactive power management, all of the inverters need to be set to:

- ▶ Protocol 1
- ▶ 57600 baud
- ▶ Parameter 1164 = 2

Connect inverters to the Solar-Log™

The wiring is done using a

- self-made, shielded 2 wire data cable and terminal block connector.

Procedure

1. Connect wires as shown in the diagram below.

Solar-Log™ terminal strip connector	Solar-Log Base RS485 (A) / (B)	RS485 inverter socket
Terminal		PIN
▶ 1 (Data+)	▶ (A) 6 or (B) 10 (Data+)	▶ 2
▶ 4 (Data-)	▶ (A) 9 or (B) 13 (Data-)	▶ 3

2. If no further inverter connected, terminate the inverter:
On the sockets "RS485 OUT" with SACC-M12MS-4SC round plugs bypass the connections PIN1 to PIN2 and PIN3 to PIN4.
3. Close the inverter if no other inverters are to be connected.
4. Insert the terminal block connector into the Solar-Log™ RS485 socket.

Connect the inverters to each other

Connect using

- a 2-wire shielded data cable and
- 4-pin Phoenix Contact Connection plug type "M12MS SACC-4SC SH" (two plugs included with the inverter).
- Where to connect: RS485 sockets on the bottom of the inverter.

The RS485 IN and OUT sockets are each double connections so that the wiring can be continued to the next inverter.

Procedure

1. Wiring the data cable to the "Phoenix Contact Type M12MS SACC-4SC SH" according to the manufacturer's instructions.
2. Insert one plug into the OUT (X14B) socket of inverter 1.
3. Insert the other end of the wire into the IN socket (X15B) on inverter 2.
4. Connect the other inverters to each other in the same way.
5. Terminate the last inverter.
On the sockets "RS485 OUT" with Phoenix contact type M12MS SACC-4SC SH bridge the connections PIN1 to PIN2 and PIN3 to PIN4.
6. Close inverters.

Allocate communication address

Recommendation: Continuous numbering starting with 1.

highest possible address: 31

Set the following parameters on the inverter's operating display:

- Press "F1", select **Numerical list**, press "ENTER".
- Set parameter number **2000** [password protection], press "ENTER" twice.
- Enter **72555**, press "ENTER"
- Set parameter number **0406**, press "ENTER"
- Select sub parameter **0406,3**, press "ENTER"
- Enter figure for communication **x**
[**x** = continuous numbering starting with 1; highest possible address: 31], press "ENTER". 31], press "ENTER".

After configuring on the display:

- Using the installed DC isolating switch turn the inverters on and off briefly so that the settings are activated.
- Set the date and time on the inverter as shown in the inverter instructions.

97 Sungrow

97.1 Sungrow

Termination	Addressing	Interface
120 Ω resistor	Yes	RS485

Overview

- Integrated interface.
- Where to connect: RJ45 socket.
- 2-pin wiring.
- Communication address must be allocated.
- Installation steps:
 - Switch off the inverters and Solar-Log™
 - Connect inverters to the Solar-Log™
 - Connect the inverters to each other
 - Allocate communication address



Note

When a device has four MPP trackers, this will be recorded as a single MPP tracker.

- ▶ With firmware version 4.1.0 or higher, four MPP trackers are recorded.

Connect inverters to the Solar-Log™

The wiring is done using a

- self-made shielded, 2-wire data cable with terminal block connector.

Procedure

1. If you are making the cable yourself, connect the wires as shown in the following diagram:

Solar-Log™ terminal strip connector	Solar-Log Base RS485 (A) / (B)	RJ45 socket inverter
Terminal		PIN
▶ 1 (Data+)	▶ (A) 6 or (B) 10 (Data+)	▶ 6 (Data +A)
▶ 4 (Data-)	▶ (A) 9 or (B) 13 (Data-)	▶ 3 (Data -B)

2. Insert the plug into the socket on the inverter
3. If no further inverter is connected, terminate the inverter according to the instructions for the inverter.
4. Insert the terminal block connector into the Solar-Log™ RS485 socket.

Connect the inverters to each other

- Wiring via network cable (patch cable).
- Where to connect: RJ45 socket on the outside of the inverter.

Procedure

1. Plug RJ45 plug into inverter 1 in socket „OUT“.
2. Plug the other end of the cable into the „IN“ socket of inverter 2.
3. Connect the other inverters to each other in the same way.
4. Terminate the last inverter in accordance with the inverter instructions.
5. Insert the terminal block connector into the Solar-Log™ RS485 socket.

Allocate communication address

- Recommendation: Continuous numbering starting with 1.
- Setting: Using the inverter operating display
- Procedure: Start according to the inverter's instructions

98 SunPower

98.1 SunPower SPR-F-Model with Fronius ComCard

Termination	Addressing	Interface
Connection plug Bridge 4-3 + 5-6	Yes	RS422

Select Fronius during the inverter detection

Overview

- The Fronius ComCard RS422 interface integrated as an option; otherwise can be retrofitted using „ComCard retrofit“.
- Where to connect: RJ45 socket on the outside of the inverter
- 4 wire cabling with 6-pin terminal block connector
- Communication address must be allocated.
 - Recommendation: Continuous numbering starting with 1.
 - Setting: Using the inverter operating display
 - Procedure: Start according to the inverter's instructions
- Installation steps
 - Switch off the inverters and Solar-Log™
 - (Install Fronius ComCard RS485 interface into the inverter).
 - Connect inverters to the Solar-Log™
 - Connect the inverters to each other
 - Allocate communication address

Installing Fronius ComCard RS485 interface

Procedure

- ▶ Install the Fronius ComCard RS485 interface in the inverter in accordance with the interface card installation instructions.

Connect inverters to the Solar-Log™

The wiring is done using a

- ready-made Fronius data cable (optional extra; not supplied)
- or
- self-made data cable with RJ45 plug and 6-pin terminal block connector



Caution

Risk of damage to the unit!

The Solar-Log™ also has an RJ45 socket, which must never be connected to the RJ45 socket on the inverter.

- ▶ Only connect inverters via the RS485/422 B-Solar-Log™ interface.

Procedure

1. If you are making the cable yourself, connect the wires as shown in the following diagram:

Solar-Log™ terminal strip connector	Solar-Log Base RS422	RJ45 inverter
Terminal		PIN
▶ 1 (T/RX+)	▶ 6 (T/RX+)	▶ 4
▶ 4 (T/RX-)	▶ 9 (T/RX-)	▶ 5
▶ 5 (R/TX+)	▶ 10 (R/TX+)	▶ 3
▶ 6 (R/TX-)	▶ 13 (R/TX-)	▶ 6

2. In the inverter insert the RJ45 plug into the IN socket.
3. If no further inverter connected, terminate the inverter:
Insert the supplied connection plug into the RJ45 OUT socket on the inverter.
The connection plug is an 8-pin dummy plug with bridged wires: Bridge wires 3 and 4 and wires 5 and 6.
4. Insert the terminal block connector into the Solar-Log™ RS485/422 B or C socket.

Connect the inverters to each other

- Connect using a network cable (patch cable)
- Where to connect: RJ45 socket on the outside of the inverter

Procedure

1. Insert the RJ45 plug in inverter 1 into the OUT socket.
2. Insert the other end of the wire into the IN socket on inverter 2.
3. Connect the other inverters to each other in the same way.
4. Terminate the last inverter.
Insert the supplied connection plug into the RJ45 OUT socket.
5. Insert the terminal block connector into the Solar-Log™ RS485/422 B or C socket.
6. Close inverters.

Allocate communication address

- Recommendation: Continuous numbering starting with 1.
- Setting: Using the inverter operating display
- Procedure: Start according to the inverter's instructions

98.2 SunPower SPR-M-Model connection using special RS485 piggyback card

Termination	Addressing	Interface
Jumper	No	RS485

Select "SMA: Data1" during the inverter detection

Overview

- Interface not integrated; retrofit the special RS485 piggyback card
- Where to connect: Terminal strip inside the inverter on the piggyback
- Communication address does not have to be assigned
- 4-pin wiring
- Installation steps
 - Switch off the inverters and Solar-Log™
 - Installing the special RS485 piggyback in inverters
 - Connect inverters to the Solar-Log™
 - Connect the inverters to each other

Installing the special RS485 piggyback in inverters

Procedure

1. Open the inverter as shown in the inverter's instructions.
2. The Piggy Back has to be installed on the inverter's circuit board aligned to the left side under the pin contract strip (Figure 3, left).

The print „unten [down]“ on the board has to be visible on the bottom left-hand side (Figure 3, right).

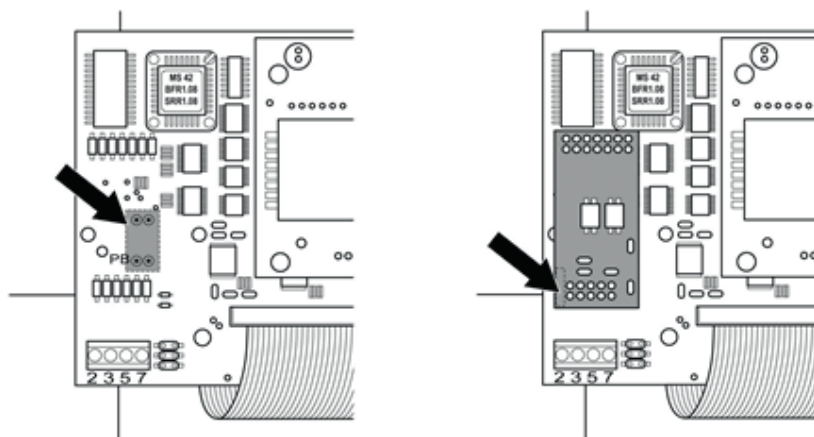

Fig.: Control board before and after installation of the piggyback



Note Solar-Log 50 / Solar-Log Base:

The special PiggyBack must not be supplied with power via the Solar-Log 50 or Solar-Log Base. In this case a 12V power supply unit must be used.

Connect inverters to the Solar-Log™

- The wiring is done using a ready-made data cable (optional extra; not supplied) or self-made, shielded 4 wire data cable and terminal block connector.

Procedure

1. Pull the free wires through the wire opening in the inverter.
2. If you are making the cable yourself, connect the wires as shown in the following diagram:

Solar-Log™ terminal strip connector Solar-Log Base RS485 (A) / (B) Inverter terminal strip

Terminal	Solar-Log Base RS485 (A) / (B)	Terminal
▶ 1 (Data+)	▶ (A) 6 or (B) 10 (Data+)	▶ 2
▶ 2 12 V	▶ 12 V (see note previous page)	▶ 3
▶ 3 GND	▶ (A) 8 or (B) 12 GND	▶ 5
▶ 4 (Data-)	▶ (A) 9 or (B) 13 (Data-)	▶ 7

3. Pull the wire in the inverter through the insulation sleeve attached to the piggy back. The wire must be enclosed in the insulating hose inside the inverter.
4. Ground the connection: Connect terminal 5 on the inverter to the inverter housing using the supplied flat strip connector.
5. If no further inverter connected, terminate the inverter: Put the supplied jumper onto the lower pins on the connector strip.

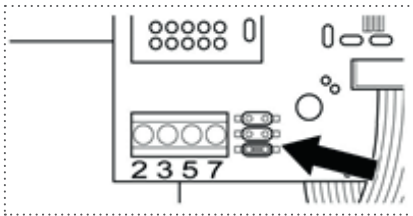

Fig.: Piggyback - insert jumper

6. Close the inverter if no other inverters are to be connected.
7. Insert the terminal block connector into the Solar-Log™ RS485 socket.

Connect the inverters to each other

- Connect using a 4 wire, shielded data cable (e.g. a 25 m ring cable, Solare Datensysteme order 220014)
- Where to connect: Terminal block in inverter (on the retrofitted RS485 interface)

Procedure

1. Pull the wire in the inverter through the insulation sleeve attached to the piggy back
The wire must be enclosed in the insulating hose inside the inverter.
2. Connect all 4 contacts (2, 3, 5, 7) on the terminal strip of inverter 1 to inverter 2



Note

A diagram for wiring in SMA combined mode can be found in the appendix.

3. Connect the other inverters to each other in the same way.
4. Terminate the last inverter.
Put the supplied jumper onto the lower pins on the connector strip.

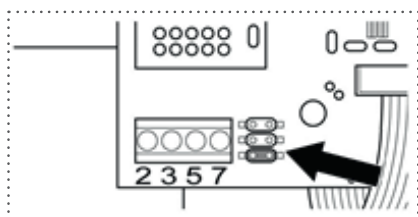

Fig.: Jumper SMA

5. Close inverters.

98.3 SunPower SPR-M-Model connect with original SMA RS485 piggy back and the SMARS485 data module

Termination	Addressing	Interface
Resistor jumper	No	RS485

Select "SMA: Data1" during the inverter detection

Overview

- Interface not integrated; retrofit the SMA RS485 piggyback card
- Where to connect: Terminal strip inside the inverter on the piggyback
- Communication address does not have to be assigned
- 3-pin wiring
- Installation steps
 - Switch off the inverters and Solar-Log™
 - Installing the original SMA RS485 piggyback in the inverter
 - Connect inverters to the Solar-Log™
 - Connect the inverters to each other

Installing the original SMA RS485 piggyback in the inverter

Procedure

- ▶ Install the original SMA RS485 piggy back in the inverter in accordance with the interface card installation instructions.

Connect inverters to the Solar-Log™

The wiring is done using a

- ready-made data cable (optional extra; not supplied)
- or
- self-made, shielded 3 wire data cable and terminal block connector.

Procedure

1. Open the inverter as shown in the inverter's instructions.
2. Pull the free wires through the wire opening in the inverter.
3. Pull the cable through the insulation tube.



Note

The wire must be enclosed in the insulating hose inside the inverter.

4. If you are making the cable yourself, connect the wires as shown in the following diagram:

Solar-Log™ terminal strip connector Solar-Log Base RS485 (A) / (B) Inverter terminal strip

Terminal		Terminal
▶ 1 (Data+)	▶ (A) 6 or (B) 10 (Data+)	▶ 2
▶ 3 GND	▶ (A) 8 or (B) 12 GND	▶ 5
▶ 4 (Data-)	▶ (A) 9 or (B) 13 (Data-)	▶ 7

- Ground the connection: Connect terminal 5 on the inverter to the inverter housing using the supplied flat strip connector.
- If no further inverter connected, terminate the inverter:
Put the supplied jumper onto the lower pins on the connector strip.

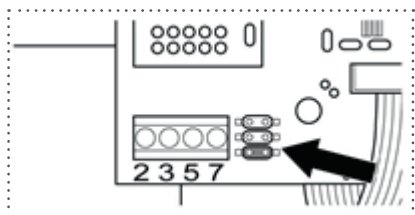

Fig.: Jumper SMA

- Close the inverter if no other inverters are to be connected.
- Insert the terminal block connector into the Solar-Log™ RS485 socket.

Connect the inverters to each other

- Connect using a 3 wire, shielded data cable.
- Where to connect: Terminal block in inverter (on the retrofitted RS485 interface)

Procedure

- Open the inverter as shown in the inverter's instructions.
- Connect the inverter in accordance with the inverter installation instructions.
- If no further inverter connected, terminate the inverter:
Put the supplied jumper onto the lower pins on the connector strip.

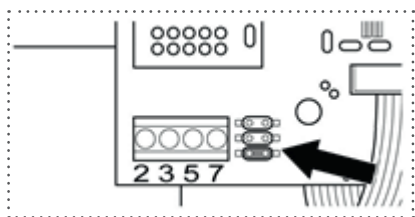

Fig.: Jumper SMA

- Close inverters.



Note

A diagram for wiring in SMA combined mode can be found in the appendix.

99 Suntigua

99.1 Suntigua

Termination	Addressing	Interface
DIP switch	Yes	RS485

Overview

- Integrated interface
- Where to connect: Terminal strip inside the inverter
- 2-pin wiring
- Communication address must be allocated.
- Installation steps
 - Switch off the inverters and Solar-Log™
 - Connect inverters to the Solar-Log™
 - Connect the inverters to each other
 - Allocate communication address

Connect inverters to the Solar-Log™

The wiring is done using a

- self-made, shielded 2 wire data cable with a terminal block connector.

Procedure

1. Open the inverter as shown in the inverter's instructions.
2. If you are making the cable yourself, connect the wires as shown in the following diagram:

Solar-Log™ terminal strip connector	Solar-Log Base RS485 (A) / (B)	Terminal strip inside the inverter
Terminal		RS485 terminal
▶ 1 (Data+)	▶ (A) 6 or (B) 10 (Data+)	▶ 1 T/R 1+
▶ 4 (Data-)	▶ (A) 9 or (B) 13 (Data-)	▶ 2 T/R 1-

3. If no further inverter connected, terminate the inverter:
In the inverter, set the DIP switch for the terminal resistor to ON.
4. Close inverters.
5. Insert the terminal block connector into the Solar-Log™ RS485 socket.

Connect the inverters to each other

- Where to connect: Terminal strip inside the inverter
- 2-pin wiring

Procedure

1. Open the inverter as shown in the inverter's instructions.
2. If you are making the cable yourself, connect the wires as shown in the following diagram:

Terminal strip inside the inverter	Terminal strip inside the inverter
RS485 terminal	RS485 terminal
▶ 1 T/R 1+	▶ 1 T/R 2+
▶ 2 T/R 1-	▶ 2 T/R 2-

3. Connect terminals A and B on inverter 1 to the corresponding terminals on inverter 2.
4. Connect the other inverters to each other in the same way.
5. Terminate the last inverter.
Set the DIP switch for the terminal resistor to ON.
6. Close inverters.
7. Insert the terminal block connector into the Solar-Log™ RS485 socket.

Allocate communication address

- Recommendation: Continuous numbering starting with 1.
- Setting: Using the inverter DIP switch
- Procedure: Start according to the inverter's instructions

100 Sunville

100.1 Sunville

Termination	Addressing	Interface
Yes	No	RS422

Overview

- Interface not integrated; Retrofit RS485 interface card.
- 4-pin cable – only on RS485/422 B or C connection of the Solar-Log™
- Communication address does not have to be assigned
- Multi-string technology

The Sunville inverters are fitted with 1 or 3 MPP trackers depending on the model. Each string input is monitored separately and ideally adjusted to the connected modules.

The Solar-Log™ automatically detects how many inverters and strings are active during inverter detection.



Note

The order in which the inverters are displayed in the Solar-Log™ after detection is random. We strongly recommend that you change the order of the inverters immediately after detection at startup, in the [Configuration | Devices | Configuration | Order](#) dialog box.

- ▶ The inverters can be identified using the displayed serial number.

- Installation steps
 - Switch off the inverters and Solar-Log™
 - Install the RS485 interface in the inverter
 - Connect inverters to the Solar-Log™
 - Connect the inverters to each other

Installing the RS485 interface Procedure

- ▶ Insert the RS485 interface in the bottom of the inverter in accordance with the interface card installation instructions and screw in.

Connect inverters to the Solar-Log™

The wiring is done using a

- ready-made data cable (optional extra; not supplied)
- or
- self-made, shielded 4 wire data cable and terminal block connector.



Note

Only connect inverter using the RS485/422 B or C interface.

Procedure

1. Open the inverter as shown in the inverter's instructions.
2. Pull the free wires through the wire opening in the inverter.
3. If you are making the cable yourself, connect the wires as shown in the following diagram:

Solar-Log™ terminal strip connector	Solar-Log Base RS422	Inverter terminal strip
Terminal		Terminal
▶ 1 (T/RX+)	▶ 6 (T/RX+)	▶ R+
▶ 4 (T/RX-)	▶ 9 (T/RX-)	▶ R-
▶ 5 (R/TX+)	▶ 10 (R/TX+)	▶ T+
▶ 6 (R/TX-)	▶ 13 (R/TX-)	▶ T-

4. Close the inverter if no other inverters are to be connected.
5. Insert the terminal block connector into the Solar-Log™ RS485/422 B or C socket.

Connect the inverters to each other

- Connect using a 4 wire, shielded data cable
- Where to connect: Terminal strip inside the inverter (on the retrofitted RS485 interface)

Procedure

1. Open the inverter as shown in the inverter's instructions.
2. Connect terminals R+, R-, T+ and T- of inverter 1 to the corresponding terminals on inverter 2.
3. Connect the other inverters to each other in the same way.
4. Close inverters.

101 Sunways

101.1 Sunways - AT/NT/PT

Termination	Addressing	Interface
Yes	Yes	RS485

Overview

- Integrated interface
- Where to connect: Terminal strip inside the inverter
 - 750 V models: 4 RS485 terminals on 10 pin terminal strip
 - 850 V models: 4 pin RS485 terminal strip
- 2-pin wiring
- Communication address must be allocated.
- Installation steps
 - Switch off the inverters and Solar-Log™
 - Connect inverters to the Solar-Log™
 - Connect the inverters to each other
 - Allocate communication address

Connect inverters to the Solar-Log™

The wiring is done using a

- ready-made Sunways data cable (optional extra; not supplied)
- or
- self-made, shielded 2 wire data cable and terminal block connector.

Procedure

1. Open the inverter as shown in the inverter's instructions.
2. Pull the free wires through the wire opening in the inverter.
3. If you are making the cable yourself, connect the wires as shown in the following diagram:

Solar-Log™ terminal strip connector	Solar-Log Base RS485 (A) / (B)	Inverter terminal strip
Terminal		Terminal
▶ 1 (Data+)	▶ (A) 6 or (B) 10 (Data+)	▶ RS485+
▶ 4 (Data-)	▶ (A) 9 or (B) 13 (Data-)	▶ RS485-

4. If no further inverter is connected, terminate the inverter according to the instructions for the inverter.
5. Close the inverter if no other inverters are to be connected.
6. Insert the terminal block connector into the Solar-Log™ RS485 socket.

Connect the inverters to each other

- Connect using a 2 wire, shielded data cable
- Where to connect: Terminal strip inside the inverter
 - 750 V models: 4 RS485 terminals on 10 pin terminal strip
 - 850 V models: 4 pin RS485 terminal strip

The RS485 connections on the terminal strip are each double connections so that the wiring can be continued to the next inverter.

Procedure

1. Open the inverter as shown in the inverter's instructions.
2. Connect terminals RS485+ and RS485- on all inverters to the two data cable wires in accordance with the inverter instructions.
3. Terminate the last inverter in accordance with the inverter instructions.
4. Close inverters.

Allocate communication address

- Recommendation: Continuous numbering starting with 1.
- Setting: Using the inverter operating display
- Procedure: Start according to the inverter's instructions

102 Surpass SSE

102.1 Surpass SSE / SPS-Serie

Termination	Addressing	Interface
-	Yes	RS485

Overview

- Integrated interface
- Connection via RS485
- 3-pin wiring
- The communication address has to be assigned (is set to 1 by default)
- Installation steps
 - Switch off the inverters and Solar-Log™
 - Connect inverters to the Solar-Log™
 - Connect the inverters to each other
 - Allocate communication address

Connect inverters to the Solar-Log™

The wiring is done using a

- Self-made cable connection using the RS485 connector and the terminal block connector.

Procedure

1. If you are making the cable yourself, connect the wires as shown in the following diagram::

Solar-Log™ terminal strip connector	Solar-Log Base RS485 (A) / (B)	RS485 connector
Terminal		Pin
▶ 1 (Data+)	▶ (A) 6 or (B) 10 (Data+)	▶ 2 (RS485+)
▶ 3 GND	▶ (A) 8 or (B) 12 GND	▶ 4 GND
▶ 4 (Data-)	▶ (A) 9 or (B) 13 (Data-)	▶ 3 (RS485-)

2. RS485 connector an den Wechselrichter, gemäß Anleitung zum Wechselrichter, anschliessen
3. Klemmleistenstecker in RS485-Buchse des Solar-Log™ stecken

Connect the inverters together

- Start according to the inverter's instructions.

Assign the communication address

- Start according to the inverter's instructions.



Note Feed-in management:

Power reductions of less than 10% are set by the inverters to 10%.

103 Sustainable Energy

103.1 Sustainable Energy

Termination	Addressing	Interface
Terminating plug	Yes	RS485

Overview

- Integrated interface
- 2-pin wiring
- Communication address must be allocated.
- Installation steps
 - Switch off the inverters and Solar-Log™
 - Connect inverters to the Solar-Log™
 - Connect the inverters to each other
 - Allocate communication address

Connect inverters to the Solar-Log™

The wiring is done using a

- ready-made data cable (optional extra; not supplied)
- or
- self-made, shielded 2 wire data cable and terminal block connector.

Procedure

1. If you are making the cable yourself, connect the wires as shown in the following diagram:

Solar-Log™ terminal strip connector	Solar-Log Base RS485 (A) / (B)	Inverter terminal strip
Terminal		Terminal
▶ 1 (Data+)	▶ (A) 6 or (B) 10 (Data+)	▶ 4 (A in)
▶ 4 (Data-)	▶ (A) 9 or (B) 13 (Data-)	▶ 3 (B in)

2. If no further inverter connected, terminate the inverter:
Insert 120 Ω terminal resistor.
3. Insert the terminal block connector into the Solar-Log™ RS485 socket.

Connect the inverters to each other

- Connect using a 2 wire, shielded data cable.
- Where to connect: Terminal strip inside the inverter.

Procedure

1. Connect terminal 2 (A out) on inverter 1 to terminal 4 (A in) on inverter 2.
2. Connect terminal 1 (B out) on inverter 1 to terminal 3 (B in) on inverter 2.
3. Connect the other inverters to each other in the same way.
4. Terminate the last inverter. Insert 120 Ω terminal resistor.

Allocate communication address

- Recommendation: Continuous numbering starting with 1.
- Setting: Using PC software for configuring inverters.
- Procedure: Start according to the inverter's instructions

104TBEA

104.1 TBEA

Termination	Addressing	Interface
120 Ω resistor	Yes	RS485

Supported models:

- TS50KTL-S

Overview

- Integrated interface
- Where to connect: Round sockets on the outside of the inverter.
- 2-pin wiring
- The communication address has to be assigned.
- Installation steps
 - Switch off the inverters and Solar-Log™
 - Connect inverters to the Solar-Log™
 - Connect the inverters to each other
 - Assign the communication address; address range 1 to 247

Connect inverters to the Solar-Log™

- self-made, shielded 2 wire data cable with round plug and terminal block connector.

Procedure

1. If you are fabricating the cable yourself, connect the wires as shown in the following diagram.

Solar-Log™ terminal strip connector	Solar-Log Base RS485 (A) / (B)	Inverter
Terminal		PIN
▶ 1 (Data+)	▶ (A) 6 or (B) 10 (Data+)	▶ A1 or A2
▶ 4 (Data-)	▶ (A) 9 or (B) 13 (Data-)	▶ B1 or B2

2. Insert the round plug into the COM round socket 1 on the inverter.
3. If no further inverter is connected, terminate the inverter according to the instructions for the inverter.
4. Insert the terminal block connector into the Solar-Log™ RS485 socket.

Connect the inverters to each other

- Connect using a data cable with a round plug
- Where to connect: Round sockets on the outside of the inverter.

Procedure

1. Insert the round plug into the COM round socket 1 on inverter 1
2. Connect additional inverters to each other according to the inverter instructions
3. Terminate the last inverter according to the inverter instructions.

Allocate communication address

- Recommendation: Continuous numbering starting with 1.
Address range 1 - 247.
- Setting: Using the inverter's operating display
- Procedure: Start according to the inverter's instructions



Note

Both bus ends have to be terminated.

105 Trannergy

105.1 Trannergy

Termination	Addressing	Interface
Yes	No	RS422

Overview

- Interface not integrated; Retrofit RS485 interface card
- 4-pin cable – only on RS422 B or C connection of the Solar-Log™
- Communication address does not have to be assigned
- Multi-string technology

The Trannergy inverters are fitted with 1 or 3 MPP trackers depending on the model. Each string input is monitored separately and ideally adjusted to the connected modules.

The Solar-Log™ automatically detects how many inverters and strings are active during inverter detection.



Note:

The order in which the inverters are displayed in the Solar-Log™ after detection is random. We strongly recommend that you change the order of the inverters immediately after detection at startup, in the [Configuration | Devices | Configuration | Order](#) dialog box.

- ▶ The inverters can be identified using the displayed serial number.

- Installation steps
 - Switch off the inverters and Solar-Log™
 - Install the RS485 interface in the inverter
 - Connect inverters to the Solar-Log™
 - Connect the inverters to each other

Installing the RS485 interface Procedure

- ▶ Insert the RS485 interface in the bottom of the inverter in accordance with the interface card installation instructions and screw in.

Connect inverters to the Solar-Log™

The wiring is done using a

- ready-made data cable (optional extra; not supplied)
- or
- self-made, shielded 4 wire data cable and terminal block connector



Note

Only connect inverter using the RS422 B or C interface.

Procedure

1. Open the inverter as shown in the inverter's instructions.
2. Pull the free wires through the wire opening in the inverter.
3. If you are making the cable yourself, connect the wires as shown in the following diagram:

Solar-Log™ terminal strip connector	Solar-Log Base RS422	Terminal strip inverter
Terminal		Terminal
▶ 1 (T/RX+)	▶ 6 (T/RX+)	▶ R+
▶ 4 (T/RX-)	▶ 9 (T/RX-)	▶ R-
▶ 5 (R/TX+)	▶ 10 (R/TX+)	▶ T+
▶ 6 (R/TX-)	▶ 13 (R/TX-)	▶ T-

4. If no further inverter is connected, terminate the inverter according to the instructions for the inverter.
5. Close the inverter if no other inverters are to be connected.
6. Insert the terminal block connector into the Solar-Log™ RS485/422 B or C socket.

Connect the inverters to each other

- Connect using a 4 wire, shielded data cable..
- Where to connect: Terminal strip inside the inverter (on the retrofitted RS485 interface)

Procedure

1. Open the inverter as shown in the inverter's instructions.
2. Connect terminals R+, R-, T+ and T- of inverter 1 to the corresponding terminals on inverter 2.
3. Connect the other inverters to each other in the same way.
4. Terminate the last inverter according to the inverter instructions.
5. Close inverters.

106 Vaillant

106.1 Vaillant – auroPOWER VPI /1 and VPI (RS485)

Termination	Addressing	Interface
Resistor Switch	Yes	RS485

Overview

- VPI until 2005 RS485 interface can be retrofitted by the manufacturer.
- Interface integrated - activate using operating display.
- Where to connect: Terminal strip inside the inverter
- 2-pin wiring
- Communication address must be allocated.
- Installation steps
 - Switch off the inverters and Solar-Log™
 - Models until 2005 Retrofit RS485 interface
 - Connect inverters to the Solar-Log™
 - Connect the inverters to each other
 - Allocate communication address

Connect inverters to the Solar-Log™

The wiring is done using a

- ready-made data cable (optional extra; not supplied)
- or
- self-made, shielded 2 wire data cable and terminal block connector.

Procedure

1. Open the inverter as shown in the inverter's instructions.
2. Pull the free wires through the wire opening in the inverter.
3. If you are making the cable yourself, connect the wires as shown in the following diagram:

Solar-Log™ terminal strip connector	Solar-Log Base RS485 (A) / (B)	Inverter terminal strip
Terminal		Terminal
▶ 1 (Data+)	▶ (A) 6 or (B) 10 (Data+)	▶ B
▶ 4 (Data-)	▶ (A) 9 or (B) 13 (Data-)	▶ A

4. If no further inverter connected, terminate the inverter:
 In the inverter connect the free terminal A to terminal B using the supplied 330 Ω terminating resistor.
 Devices without a transformer: From unit generation VPI xx00 /2 the 330 Ω resistor is switched on using the DIP switch. When the unit is delivered the terminal resistor is switched on.
5. Close the inverter if no other inverters are to be connected.
6. Insert the terminal block connector into the Solar-Log™ RS485 socket.

Connect the inverters to each other

- Connect using a 2 wire, shielded data cable
- Where to connect: Terminal strip inside the inverter

The RS485 connections on the terminal strip are each double connections so that the wiring can be continued to the next inverter.

Procedure

1. Open the inverter as shown in the inverter's instructions.
2. Connect terminal A on inverter 1 to terminal A on inverter 2.
3. Connect the other inverters to each other in the same way.
4. Terminate the last inverter. In the inverter connect the free terminal A to terminal B using the supplied 330 Ω terminating resistor.

Devices without a transformer: From unit generation VPI xx00 /2 the 330 Ω resistor is switched on using the DIP switch. When the unit is delivered the terminal resistor is switched on.

5. Close inverters.

Allocate communication address

- Recommendation: Continuous numbering starting with 1.
- Setting:
Units without transformers: using the DIP switch inside the inverter
Units with transformers: using the inverter operating display.
- Procedure: Start according to the inverter's instructions



Note

A maximum of 32 inverters can be connected per RS485 bus.

107 Valenia

107.1 Valenia

Termination	Addressing	Interface
Yes	Yes	RS485

Overview

- Integrated interface
- Where to connect: Terminal strip on internal interface card
- 3-pin wiring
- Communication address must be allocated
- Installation steps
 - Switch off the inverters and Solar-Log™
 - Connect inverters to the Solar-Log™
 - Connect the inverters to each other
 - Set the address of the inverters

Connect inverters to the Solar-Log™

The wiring is done using a

- self-made 3 pin connection cable and terminal block connector.

Procedure

1. Open the inverter as shown in the inverter's instructions.
2. If you are making the cable yourself, connect the wires as shown in the following diagram

Solar-Log™ terminal strip connector	Solar-Log Base RS485 (A) / (B)	Inverter terminal strip
Terminal		PIN
▶ 1 (Data+)	▶ (A) 6 or (B) 10 (Data+)	▶ P
▶ 3 GND	▶ (A) 8 or (B) 12 GND	▶ 0 V
▶ 4 (Data-)	▶ (A) 9 or (B) 13 (Data-)	▶ N

3. If no further inverter is connected, terminate the inverter according to the instructions for the inverter.
4. Set the address for the inverter on the inverter itself.
5. Close the inverter if no other inverters are to be connected.
6. Insert the terminal block connector into the Solar-Log™ RS485 socket.



Note

The inverter terminal strip's 5V output must not be connected to the Solar-Log™.

Connect the inverters to each other

The wiring is done using a

- self-made connection cable and terminal block connector.
- Where to connect: Terminal strip on internal interface card

Procedure

1. Open the inverter as shown in the inverter's instructions.
2. Connect terminals P, N and 0V of the first inverter 1 to the corresponding terminals on the next inverter.
3. Connect the other inverters to each other in the same way.
4. Terminate the last inverter in accordance with the manufacturer's specifications.
5. Address the individual inverters in accordance with the manufacturer's manual.
6. Close the inverter if no other inverters are to be connected.
7. Insert the terminal block connector into the Solar-Log™ RS485 socket.



Note

A maximum of 32 inverters can be connected per RS485 bus.

108 Vectron

108.1 Vectron

Inverters manufactured by Bonfiglioli Vectron GmbH were listed under „Vectron“ up to firmware version 3.1.2. Starting with firmware version 3.1.3 the name has been changed to „Bonfiglioli“.

109 Vision

109.1 Vision Multitracker

Termination	Addressing	Interface
DIP switch	Yes	RS485

Select "Vision" during the inverter detection

Overview

- Integrated interface
- 3-pin wiring
- 2 RJ45 sockets on the outside of the inverter.
- Communication address must be allocated.
- Installation steps
 - Switch off the inverters and Solar-Log™
 - Connect inverters to the Solar-Log™
 - Connect the inverters to each other
 - Allocate communication address.
Address range 1 to 32
Settings on the inverter's display according to the manufacturer's manual.

Connect inverters to the Solar-Log™

The wiring is done using a

- self-made cable connection with RS485 data cable and terminal block connector.



Caution

Risk of damage to the unit!

The Solar-Log™ also has an RJ45 socket, which must never be connected to the RJ45 socket on the inverter.

- ▶ Only connect inverters via the RS485/422 Solar-Log™ interface(s).
-

Procedure

1. If you are fabricating the cable yourself, connect the wires as shown in the following diagram.

Solar-Log™ terminal strip connector	Solar-Log Base RS485 (A) / (B)	RS485 inverter socket
Terminal		PIN
▶ 1 (Data+)	▶ (A) 6 or (B) 10 (Data+)	▶ Pin 1 (A) T/R+
▶ 3 GND	▶ (A) 8 or (B) 12 GND	▶ Pin 5 GND
▶ 4 (Data-)	▶ (A) 9 or (B) 13 (Data-)	▶ Pin 2 (B) T/R-

2. Insert the RJ45 plug into the RJ45 socket on the inverter.
3. If no further inverter connected, terminate the inverter:
Set the dip switch to "on."
4. Insert the terminal block connector into the Solar-Log™ RS485 socket.

Connect the inverters to each other

- Connect using a network cable (patch cable) (No Crossover cable)
- Where to connect: RJ45 sockets on the outside of the inverter.

Procedure

1. Insert the RJ45 plug into the free RJ45 socket on the first inverter.
2. Insert the other end of the wire into any RJ45 socket on inverter 2.
3. Connect the other inverters to each other in the same way.
4. Terminate the last inverter, set the DIP switch to "on."

Allocate communication address

- Recommendation: Continuous numbering from 1 to 32
- Setting: Using the inverter operating display.
- Procedure: Start according to the inverter's instructions.



Note

The following setting needs to be enable so that the PM parameters can be received.
 SETUP ▶ REMOTE CNTRL ▶ ENABLE

109.2 Vision Singletracker

Termination	Addressing	Interface
DIP switch	Yes	RS485

Select "Vision: VIS-SM/DM" during the inverter detection

Overview

- Integrated interface
- 3-pin wiring
- 2 RJ45 sockets on the outside of the inverter.
- Communication address must be allocated.
- Installation steps
 - Switch off the inverters and Solar-Log™
 - Connect inverters to the Solar-Log™
 - Connect the inverters to each other
 - Allocate communication address.
Address range 1 to 254
Settings on the inverter's display according to the manufacturer's manual.

Connect inverters to the Solar-Log™

The wiring is done using a

- self-made cable connection with RS485 data cable and terminal block connector.



Caution

Risk of damage to the unit!

The Solar-Log™ also has an RJ45 socket, which must never be connected to the RJ45 socket on the inverter.

- ▶ Only connect inverters via the RS485/422 Solar-Log™ interface(s).

Procedure

1. If you are fabricating the cable yourself, connect the wires as shown in the following diagram.

Solar-Log™ terminal strip connector	Solar-Log Base RS485 (A) / (B)	RS485 inverter socket
Terminal		PIN
▶ 1 (Data+)	▶ (A) 6 or (B) 10 (Data+)	▶ Pin 1 (A) T/R+
▶ 3 GND	▶ (A) 8 or (B) 12 GND	▶ Pin 5 GND
▶ 4 (Data-)	▶ (A) 9 or (B) 13 (Data-)	▶ Pin 2 (B) T/R-

2. Insert the RJ45 plug into the RJ45 socket on the inverter.
3. If no further inverter connected, terminate the inverter:
Set the dip switch to "on."
4. Insert the terminal block connector into the Solar-Log™ RS485 socket.

Connect the inverters to each other

- Connect using a network cable (patch cable) (No Crossover cable)
- Where to connect: RJ45 sockets on the outside of the inverter.

Procedure

1. Insert the RJ45 plug into the free RJ45 socket on the first inverter.
2. Insert the other end of the wire into any RJ45 socket on inverter 2.
3. Connect the other inverters to each other in the same way.
4. Terminate the last inverter, set the DIP switch to "on."

Allocate communication address

- Recommendation: Continuous numbering from 1 to 254
- Setting: Using the inverter operating display.
- Procedure: Start according to the inverter's instructions.

110 Voltwerk

110.1 Voltwerk (only Solar-Log 1000, 1900 and 2000)



Note

Voltwerk inverters can only be connected to the Solar-Log 1000, 1900 and 2000, as only this one has a CAN interface.

The following description relates to inverters without transformers produced in or after 2007.

Termination	Addressing	Interface
Yes	No	CAN bus

Overview

- CAN only to be used on Solar-Log 1000, 1900 and 2000 (CAN interface).
- Integrated interface
- Where to connect: CAN socket on the outside of the bottom of the inverter
- Only use ready-made cable sets

Two different special cable sets must be ordered separately

- Prefabricated cable set between the Solar-Log 1000, 1900 and 2000 and the first inverter, including cable termination
- Ready-made cable set with 5 pin Phoenix contact connection plug for connecting the inverters to each other

The number of cables are required depends on the number of inverters

Maximum total cable length: 200 m

- Communication address does not have to be assigned
- Installation steps
 - Switch off the inverters and Solar-Log™
 - Connect inverters to the Solar-Log™
 - Connect the inverters to each other

PIN assignment:

Solar-Log™ terminal strip connector	Sensor / actuator connector 5-pin
Terminal	Pin
4 not used	1 not used
5 not used	2 not used
▶ 1	▶ 3
▶ 3	▶ 4
▶ 2	▶ 5

At Solarlog™ set a 120 Ω resistor between PIN 2 and 3

Connect the inverters to the Solar-Log 1000, 1900 and 2000.

Connection is only done using a ready-made data cable, specially for connecting to the Solar-Log 1000, 1900 and 2000 (optional extra; not supplied).

Procedure

1. Insert the CAN plug into the inverter CAN IN socket.
2. If no further inverter connected, terminate the inverter:
Insert the two 5 pin 120 Ω terminal resistors from the ready-made cable set into the CAN OUT socket.
3. Insert the terminal block connector into the Solar-Log 1000, 1900 and 2000 CAN socket.

Connecting inverters to each other (only Solar-Log 1000, 1900 and 2000)

- Connection is made only with a ready-made data cable specially for connecting the inverters to each other (optional extra: not supplied).
- Where to connect: CAN socket outside the inverter.

Procedure

1. Insert the CAN plug into any CAN OUT socket on inverter 1.
2. Insert the other end of the wire into any CAN IN socket on inverter 2.
3. Connect the other inverters to each other in the same way.
4. Terminate in the last inverter.

Insert the two 5 pin 120 Ω terminal resistors from the ready-made cable set into the CAN OUT socket.

111 WINAICO

111.1 WINAICO

Termination	Addressing	Interface
Switch	Yes	RS485

- Interface not integrated; Retrofit RS485 interface card.
- 4-pin wiring
- Communication address must be allocated
- Installation steps
 - Allocate communication address
 - Switch off the inverters and Solar-Log™
 - Install the RS485 interface in the inverter
 - Connect inverters to the Solar-Log™
 - Connect the inverters to each other

Allocate communication address

- Recommendation: Continuous numbering starting with 1.
- Setting: Using the DIP switch on the interface card.

Before installing the RS485 interface card:

- ▶ Allocate the communication address using the 8 interface card DIP switches:

Example - Communication address 1:

On		■	■	■	■	■	■	■
Off	■							
DIP switch								

Example - Communication address 2:

On	■		■	■	■	■	■	■
Off		■						
DIP switch								

Example - Communication address 3:

On								
Off								
DIP switch								

Example - Communication address 4:

On								
Off								
DIP switch								

Example - Communication address 5:

On								
Off								
DIP switch								

You will find more information at:

http://en.wikipedia.org/wiki/Binary_number.

Installing the RS485 interface

Procedure

- ▶ Install the RS485 interface in the inverter in accordance with the interface card installation instructions.

Connect inverters to the Solar-Log™

The wiring is done using a

- ready-made BKL2 data cable (optional extra; not supplied)

or

- self-made, shielded 4 wire data cable and terminal block connector.

Procedure

1. Open the inverter as shown in the inverter's instructions.
2. Pull the free wires through the wire opening in the inverter.
3. If you are making the cable yourself, connect the wires as shown in the following diagram:

Solar-Log™ terminal strip connector	Solar-Log Base RS485 (A) / (B)	Inverter terminal strip
Terminal		Terminal
▶ 1 (Data+)	▶ (A) 6 or (B) 10 (Data+)	▶ R+
▶ 1 (Data+)	▶ (A) 6 or (B) 10 (Data+)	▶ R-
▶ 4 (Data-)	▶ (A) 9 or (B) 13 (Data-)	▶ T+
▶ 4 (Data-)	▶ (A) 9 or (B) 13 (Data-)	▶ T-

- If no further inverter is connected, terminate the inverter according to the instructions for the inverter.
- Close the inverter if no other inverters are to be connected.
- Insert the terminal block connector into the Solar-Log™ RS485 socket.

Connect the inverters to each other

- Connect using a 4 wire, shielded data cable
- Where to connect: Terminal strip inside the inverter on the retrofitted RS485 interface card

Procedure

- Open the inverter as shown in the inverter's instructions.
- Connect terminals R+, T+, R- and R+ of inverter 1 to the corresponding terminals on inverter 2.
- Connect the other inverters to each other in the same way.
- Terminate the last inverter according to the inverter instructions.
- Close inverters.

112 Würth

112.1 Würth SolarStar-Series

Termination	Addressing	Interface
No	Yes	RS485

Select "SolarMax" during the inverter detection

Supported Models:

- SolarStar a2000
- SolarStar a3000
- SolarStar a4200
- SolarStar a6000

Overview

- Integrated interface
- Where to connect: RJ45 socket on the outside of the inverter
- 6-pin wiring
- Communication address must be allocated.
- Installation steps
 - Switch off the inverters and Solar-Log™
 - Connect inverters to the Solar-Log™
 - Connect the inverters to each other
 - Allocate communication address

Connect inverters to the Solar-Log™

The wiring is done using a

- ready-made data cable (optional extra; not supplied)
- or
- self-made RS485 data cable with RJ45 plug and terminal block connector.



Caution

Risk of damage to the unit!

The Solar-Log™ also has an RJ45 socket, which must never be connected to the RJ45 socket on the inverter.

- ▶ Only connect inverters via the RS485/422 Solar-Log™ interface(s).
-

Procedure

1. If you are making the cable yourself, connect the wires as shown in the following diagram:

Solar-Log™ terminal strip connector	Solar-Log Base RS485 (A) / (B)	RJ45 inverter
Terminal		PIN
▶ 1 (Data+)	▶ (A) 6 or (B) 10 (Data+)	▶ 7
▶ 2 12 V	▶ (A) 7 or (B) 11	▶ 1
▶ 2 12 V	▶ (A) 7 or (B) 11	▶ 2
▶ 3 GND	▶ (A) 8 or (B) 12 GND	▶ 3
▶ 3 GND	▶ (A) 8 or (B) 12 GND	▶ 4
		5 - unused
		6 - unused
▶ 4 (Data-)	▶ (A) 9 or (B) 13 (Data-)	▶ 8

2. Insert the RJ45 plug into any RJ45 socket on the first inverter.
3. Insert the terminal block connector into the Solar-Log™ RS485 socket.

Connect the inverters to each other

- Connect using the RS485 data cable with an RJ45 plug.
- Where to connect: RJ45 socket on the outside of the inverter.

Procedure

1. Insert the RJ45 plug into the free RJ45 socket on the first inverter.
2. Insert the other end of the wire into any RJ45 socket on inverter 2.
3. Connect the other inverters to each other in the same way.

Allocate communication address

- Recommendation: Continuous numbering starting with 1.
- Setting: Using the inverter operating display.
- Procedure: Start according to the inverter's instructions.



Note

The inverter's factory setting is communication address 255.

- ▶ On the inverter operating display set the communication address manually to 1 even if only one inverter is connected to the Solar-Log™.



Note for feed-in management

The inverter itself has to be configured with MaxTalk2 (SolarMax's software) and set to "Remote mode" to be able to use reactive power management. Please refer to the inverter instructions for more information on this topic.

113 Yaskawa

113.1 Yaskawa

Termination	Addressing	Interface
Yes	Yes	RS485

Overview

- Integrated interface.
- Where to connect: Terminal strip inside the inverter.
- Communication address must be allocated.
- 3-pin wiring.
- Installation steps:
 - Switch off the inverters and Solar-Log™.
 - Connect inverters to the Solar-Log™.
 - Address the inverter.
 - Connect the inverters to each other.
 - Terminate the inverter as shown in the inverter's instructions.

Connect inverters to the Solar-Log™

The wiring is done using a

- self-made cable connection with terminal block connector.

Procedure

1. Open the inverter as shown in the inverter's instructions.
2. Pull the free wires through the wire opening in the inverter.
3. If you are making the cable yourself, connect the wires as shown in the following diagram:



Note

Please note that the connection label (e.g. 2-6) refers to the second row on the terminal block, connection 6).

Solar-Log™ terminal strip connector Solar-Log Base RS485 (A) / (B) RJ45 inverter

Terminal		PIN
▶ 1 (Data+)	▶ (A) 6 or (B) 10 (Data+)	▶ 2-6 D+
▶ 3 GND	▶ (A) 8 or (B) 12 GND	▶ 1-8 GND
▶ 4 (Data-)	▶ (A) 9 or (B) 13 (Data-)	▶ 2-7 D-

4. If no further inverter is connected, terminate the inverter according to the instructions for the inverter.
5. Close the inverter cover if no other inverters are to be connected.
6. Insert the terminal block connector into the Solar-Log™ RS485 socket.

Connect the inverters to each other

The inverters are connected together using the RS485 interface. Refer to the manufacturer's inverter manual for the details on how to setup the connection.

Allocate communication address

- Recommendation: Continuous numbering starting with 1; highest possible address: 247.
- Setting: Using the inverter operating display.
- Procedure: Start according to the inverter's instructions.



Note

Please refer to the manufacturer's notes in regard to the addressing in the installation manual.



Note

A maximum of 31 inverters can be connected per RS485 bus.

114 Zentral Solar Deutschland ZSD

114.1 Zentral Solar Deutschland TLQ (RS485)

Termination	Addressing	Interface
Yes	No	RS485

Overview

- Integrated interface.
- Where to connect: RJ45 plug outside the housing floor.
- 2-pin wiring.
- Communication address does not have to be assigned.
- Installation steps:
 - Switch off the inverters and Solar-Log™.
 - Connect inverters to the Solar-Log™.
 - Connect the inverters to each other.

Connect inverters to the Solar-Log™

The wiring is done using a

- ready-made BRJ2 data cable (optional extra; not supplied)
- or
- self-made cable connection with RS485 data cable and terminal block connector.



Caution

Risk of damage to the unit!

The Solar-Log™ also has an RJ45 socket, which must never be connected to the RJ45 socket on the inverter.

- ▶ Only connect inverters via the RS485/422 Solar-Log™ interface(s).

Procedure

1. If you are making the cable yourself, connect the wires as shown in the following diagram:

Solar-Log™ terminal strip connector	Solar-Log Base RS485 (A) / (B)	RJ45 inverter
Terminal		PIN
▶ 1 (Data+)	▶ (A) 6 or (B) 10 (Data+)	▶ 7
▶ 4 (Data-)	▶ (A) 9 or (B) 13 (Data-)	▶ 8

2. Insert the RJ45 plug into the RJ45 socket on the inverter.
3. If no further inverter is connected, terminate the inverter according to the instructions for the inverter.
4. Insert the terminal block connector into the Solar-Log™ RS485 socket.

Connect the inverters to each other

- Connect using a network cable (patch cable).
- Where to connect: RJ45 sockets on the outside of the inverter.

Procedure

1. Insert the RJ45 plug into any RJ45 socket on inverter 1.
2. Insert the other end of the wire into any RJ45 socket on inverter 2.
3. Connect the other inverters to each other in the same way.
4. Terminate the last inverter in accordance with the inverter instructions.

114.2 Zentral Solar Deutschland ZSD - zentralpower

Termination	Addressing	Interface
-	Yes	RS485

Overview

- Integrated interface.
- Where to connect: RJ45 socket on the outside of the inverter.
- 2-pin wiring.
- The communication addresses (1-247) have to be assigned.
- Installation steps:
 - Switch off the inverters and Solar-Log™.
 - Connect inverters to the Solar-Log™.
 - Connect the inverters to each other.
 - Allocate communication address.

Connect inverters to the Solar-Log™

The wiring is done using a

- self-made, shielded 2 wire data cable with a RJ45 socket and a terminal block connector.

Procedure

1. If you are making the cable yourself, connect the wires as shown in the following diagram:

Solar-Log™ terminal strip connector	Solar-Log Base RS485 (A) / (B)	RJ 45 socket
Terminal		PIN
▶ 1 (Data+)	▶ (A) 6 or (B) 10 (Data+)	▶ 4 (+)
▶ 4 (Data-)	▶ (A) 9 or (B) 13 (Data-)	▶ 3 (-)

2. Insert the RJ45 plug into the RJ45 socket on the inverter.
3. Insert the terminal block connector into the Solar-Log™ RS485 socket.

Connect the inverters to each other

- Wiring using 2 pin cable with round plugs.
- Where to connect: Round sockets on the outside of the inverter.

Procedure

1. Insert the RJ45 plug into the RJ45 socket on the first inverter.
2. Insert the other end of the wire into any RJ45 socket on inverter 2.
3. Connect the other inverters to each other in the same way.
4. Insert the terminal block connector into the Solar-Log™ RS485 socket.

Allocate communication address

- Recommendation: Continuous numbering starting with 1.
Address range: 1 - 247.
- Setting: Using the inverter operating display.
- Procedure: Start according to the inverter's instructions.

115 Zeversolar

115.1 Zeversolar

Termination	Addressing	Interface
Yes	No	RS422

Overview

- Interface integrated.
- Where to connect: RJ45 socket on the outside of the inverter
- 4-pin cable – only on RS485/422 B or C connection of the Solar-Log™
- Communication address does not have to be assigned



Note

The order in which the inverters are displayed in the Solar-Log™ after detection is random. We strongly recommend that you change the order of the inverters immediately after detection at startup, in the [Configuration | Devices | Configuration | Order](#) dialog box.

- ▶ The inverters can be identified using the displayed serial number.

- Installation steps
 - Switch off the inverters and Solar-Log™
 - Install the RS485 interface in the inverter
 - Connect inverters to the Solar-Log™
 - Connect the inverters to each other

Connect inverters to the Solar-Log™

The wiring is done using a

- ready-made BRJ1 data cable (optional extra; not supplied)
- or
- self-made cable connection with RS485 data cable and terminal block connector.



Caution

Risk of damage to the unit!

The Solar-Log™ also has an RJ45 socket, which must never be connected to the RJ45 socket on the inverter.

- ▶ Only connect inverters via the RS485/422 B or C-Solar-Log™ interface.



Note

Only connect inverter using the RS485/422 B or C interface.

Procedure

1. If you are making the cable yourself, connect the wires as shown in the following diagram:

Solar-Log™ terminal strip connector	Solar-Log Base RS422	RJ45 inverter
Terminal		PIN
▶ 1 (T/RX+)	▶ 6 (T/RX+)	▶ Pin 3
▶ 4 (T/RX-)	▶ 9 (T/RX-)	▶ Pin 6
▶ 5 (R/TX+)	▶ 10 (R/TX+)	▶ Pin 1
▶ 6 (R/TX-)	▶ 13 (R/TX-)	▶ Pin 2

2. Insert the RJ45 plug into any RJ45 socket on inverter 1.
3. If no further inverter is connected, terminate the inverter according to the instructions for the inverter.
4. Insert the terminal block connector into the Solar-Log™ RS485/422 B socket.

Connect the inverters to each other

- Connect using a network cable (patch cable)
- Where to connect: RJ45 socket on the outside of the inverter

Procedure

1. Insert the RJ45 plug into any RJ45 socket on inverter 1.
2. Insert the other end of the wire into any RJ45 socket on inverter 2.
3. Connect the other inverters to each other in the same way.
4. Terminate the last inverter according to the inverter instructions.



Note

All Zeperlution S, Zeperlution 3680/4000/5000 and Evershine TLC inverter models can be supplied as an additional option with an already integrated monitoring solution (ComBox) from Zeversolar. If one of these models is purchased with an integrated solution, it is not possible to connect a third-party monitoring system. Therefore there is no compatibility to Solar-Log™.

116 Zucchetti Centro Sistemi S.p.a

116.1 Azzuro

Termination	Addressing	Interface
Yes	Yes	RS485

Selection available under SofarSolar

Supported models (Wiring via RJ45):

- Azzuro 4.4KTL, 5.5KTL, 6.6KTL, 8.8KTL, 11KTL, 12KTL
- Azzuro 10000TL, 15000TL, 17000TL, 20000TL
- Azzuro 30000TL, 33000TL, 40000TL
- Azzuro 50000TL, 60000TL, 70000TL

Supported models (Wiring via RS485 pin block):

- Azzuro 1100TL, 1600TL, 2200TL, 2700TL, 3000TL
- Azzuro 3000TLM, 3680TLM, 4000TLM, 4600TLM, 5000TLM, 6000TLM
- Azzuro 3KTLM, 3.6KTLM, 4KTLM, 4.6KTLM, 5KTLM, 6KTLM

Overview

- Integrated interface.
- Where to connect: RS485 pin block, inside the inverter.
- Where to connect: RJ45 socket inside the inverter.
- 2-pin wiring.
- The communication address has to be assigned.
- Installation steps:
 - Switch off the inverters and Solar-Log™
 - Connect inverters to the Solar-Log™.
 - Connect the inverters to each other according to the inverter instructions.

Connect inverters to the Solar-Log™ (via RJ45)

The wiring is done using a

- self-made RS485 data cable with RJ45 plug and terminal block connector.

Procedure

1. Open the inverter as shown in the inverter's instructions.
2. If you are making the cable yourself, connect the wires as shown in the following diagram:

Solar-Log™ terminal strip connector	Solar-Log Base RS485 (A) / (B)	RJ45 inverter
Terminal		Pin
▶ 1 (Data+)	▶ (A) 6 or (B) 10 (Data+)	▶ 2 RS485 A (+) (Orange)
▶ 4 (Data-)	▶ (A) 9 or (B) 13 (Data-)	▶ 1 RS485 B (-) (White and Orange)

3. In the inverter insert the RJ45 plug into the „RS-485 out“ socket.
4. If no further inverter is connected, terminate the inverter according to the instructions for the inverter.
5. Close the inverter if no other inverters are to be connected.
6. Insert the terminal block connector into the Solar-Log™ RS485 socket.

Connect the inverters to each other

- Wiring via data cable with RJ45 plug.
- Where to connect: RJ45 socket inside the inverter.

Connect inverters to the Solar-Log™ (via RS485 pin block)

The wiring is done using a

- self-made 2-pin cable connection and terminal strip connectors.

Procedure

1. Open the inverter as shown in the inverter’s instructions.
2. If you are making the cable yourself, connect the wires as shown in the following diagram:

Solar-Log™ terminal strip connector	Solar-Log Base RS485 (A) / (B)	RS485 inverter pin block
▶ 1 (Data+)	▶ (A) 6 or (B) 10 (Data+)	▶ TX+
▶ 4 (Data-)	▶ (A) 9 or (B) 13 (Data-)	▶ TX-

Terminal	Solar-Log Base RS485 (A) / (B)	Pin
▶ 1 (Data+)	▶ (A) 6 or (B) 10 (Data+)	▶ TX+
▶ 4 (Data-)	▶ (A) 9 or (B) 13 (Data-)	▶ TX-

3. If no further inverter is connected, terminate the inverter according to the instructions for the inverter.
4. Close the inverter if no other inverters are to be connected.
5. Insert the terminal block connector into the Solar-Log™ RS485 socket.

Connect the inverters to each other:

- Connect the inverters to each other according to the inverter instructions.

Allocate communication address

- Recommendation: Continuous numbering starting with 1.
Address range 1-32.
- Setting: Using the inverter operating display.
- Procedure: Start according to the inverter’s instructions.



Note

A maximum of 32 inverters can be connected per RS485 bus.

117 Appendix

117.1 SMA mixed wiring

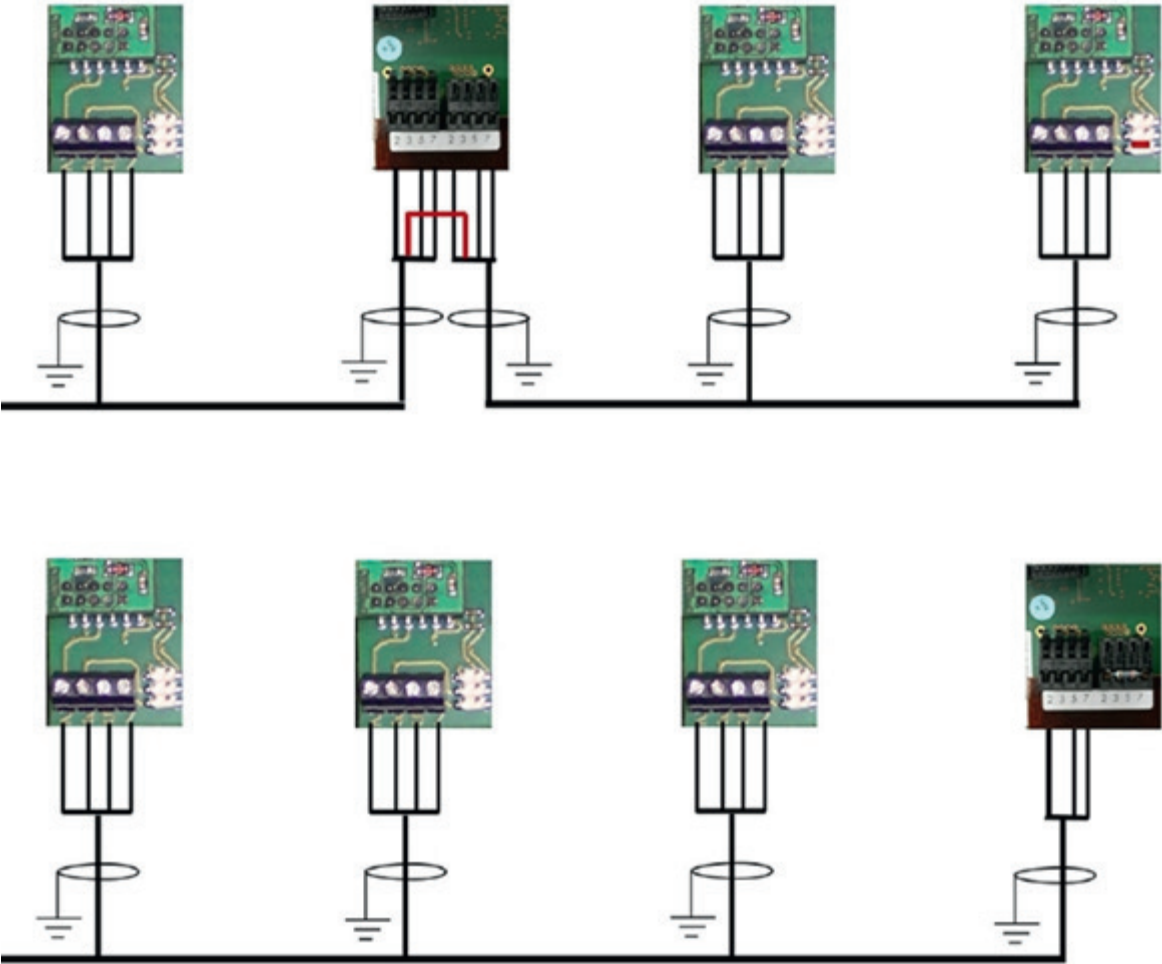

Fig.: SMA mixed wiring

117.2 Interconnection of Kaco Powador inverters

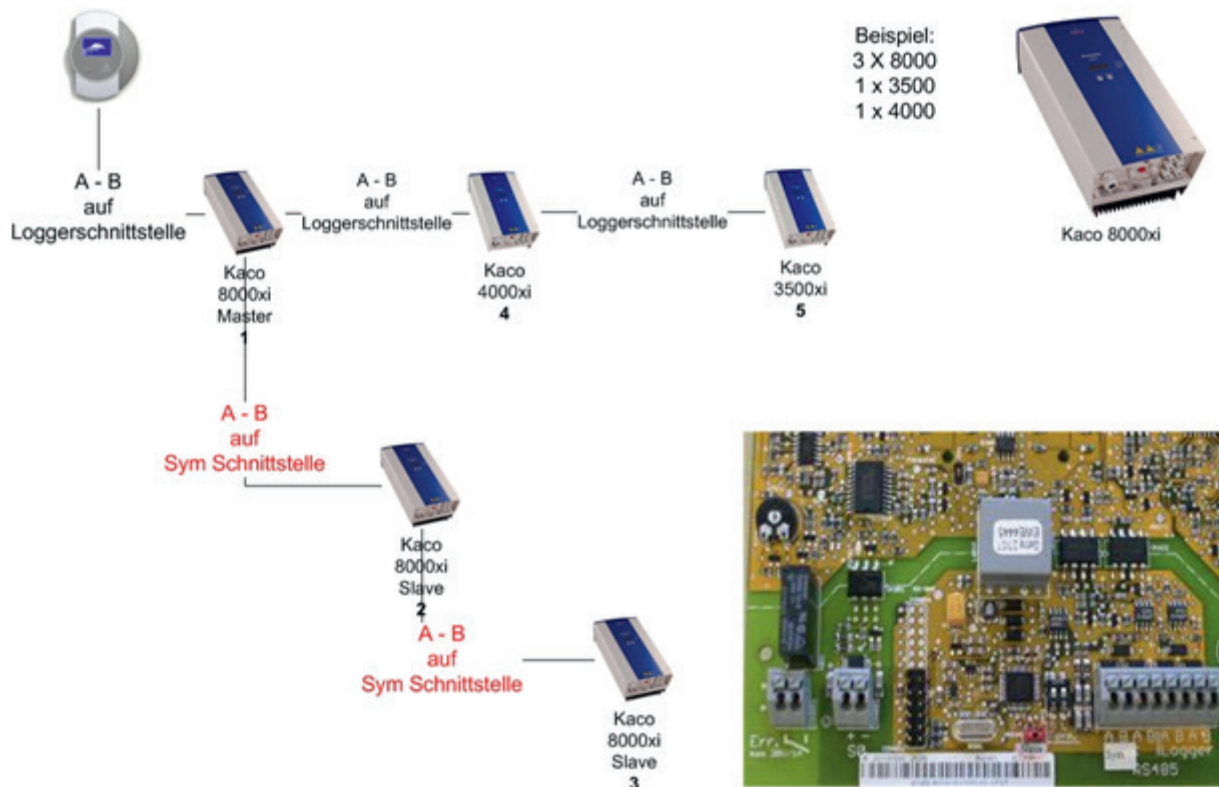

Fig.: Interconnection of Kaco Powador inverters

Instructions for Powador 6400xi and 8000xi

- Interconnection of Powador 6400Xi and 8000xi:
 - ▶ Set 1 inverter as „Master“, 2 as „Slaves“;
Read the labeling on the inverter circuit board!
 - ▶ Clamp the Solar-Log™ data cable to the „LOGGER“ terminal strip on the Master inverter.
 - ▶ Also connect the inverters to each other through the „SYM“ terminal strip
 - ▶ Connect any additional inverters through the „Logger“ terminal strip
 - ▶ On the inverter operating display:
Set the communication addresses, numbering consecutively
 - ▶ On the inverter operating display: Switch „SYM Bus“ to active
- Powador 6400Xi and 8000xi stand-alone mode:
 - ▶ Set the inverter to „Slave“, irrespective of labeling on the circuit board
 - ▶ Clamp the Solar-Log™ data cable to the „SYM Bus“ terminal strip
 - ▶ On the inverter operating display: Switch „SYM Bus“ to inactive
 - ▶ On the inverter operating display: Set the communication addresses, numbering consecutively

02

Meter

1 External Power Meter

1.1 Recording Energy Flows with External Power Meters

External power meters can be connected to every Solar-Log™ model via the S0 input and/or the RS-485 bus. Solar-Log™ devices have a varying number of S0 inputs:

S0 inputs

Solar-Log™	Number of S0 inputs
Solar-Log Base	2 x S0-In
Solar-Log 300, 1200, 1900 and 2000	2 x S0-In and 1 x S0-Out
Solar-Log ^{1000, 500}	1 x S0-In/Out
Solar-Log ²⁰⁰	1 x S0-In
Solar-Log 250	1 x S0-In

Note



The Solar-Log™ requires a S0 pulse duration of 30-40 ms. That is why we recommend using SDS tested meters that we offer.

We cannot guarantee the functionality of other products.

In addition, the maximum length between the power meters and Solar-Log™ should not exceed 10 m.

Note



Consumption meters can be assigned to plant groups.

It is only possible to assign a meter after a rule with the calculation of self-consumption has been activated in the power management configuration [Configuration | Feed-in Management](#).

External power meters/accumulating meters

With multiple phase meters, a basic distinction is made between phase-exact and accumulating meters.

Accumulating meters provide the total values from all three phases. The meter calculates the total output (to and from the grid) of the individual phases and provides this total as a single value.

In the example:

Phase 1 supplies 3 kW via an inverter (single phase).

Phase 2 refers to 2 kW (energy).

Phase 3 refers to 1 kW (energy).

With an accumulating meter, this results in a total of 0 kW.

An example of an accumulating meter is the Janitza UMG 104 or the Solar-Log™ Pro380 Mod.



Note

With the Solar-Log™, the electricity fed into the power grid from a PV plant can be limited. The actual reduction of output can be set as a fixed rate (kW or %) or dynamic with the local consumption of the generated electricity factored into the actual reduction rate. Recording the current consumption plays a key role when the local consumption is taken into account for the reduction. A consumption meter has to be installed to achieve an accuracy of +/- 2%. It is not generally possible to achieve this accuracy with just a bidirectional meter at the grid connection point. The feed-in limits may be exceeded and there could be irregularities due to different measuring, reading and control intervals. That is why we strongly discourage such installation and the use of S0 meters.



Note

The Solar-Log™ offers the option of a „Fixed Regulation of X% with the Calculation of Self-Consumption.“ A general requirement for the fixed regulation of X% is that the inverters used allow the Solar-Log™ to limit the output. There is a major difference between Solar-Log™ compatible inverters when it comes to power reductions. Some inverters cannot be limited to 0 watts or 0% of the generator output; they produce a certain amount of residual power even when the output is set to zero. This needs to be considered when designing plants with 0% output reduction. For example, the base load always needs to be greater than the residual power output. There is also a distinct difference between the reaction times of various inverters. The reaction time also depends on the number of devices installed. It is not recommended to use S0 meters for 0% reductions.

- ▶ For these reasons, Solare Datensysteme GmbH cannot guarantee an absolute 0% feed-in reduction.
- ▶ It is always necessary to consult the grid operator about the reduction.

2 Solar-Log™ Meter Operating Modes

2.1 Explanation of the Solar-Log™ Meter Operating Modes

There are various setting options when configuring meters in Solar-Log™. These are in particular:

- Battery meter (bi-directional meter):
 - Records the battery charges and discharges.
- Deactivated: The recording of consumption has been or is deactivated.
- Meter for the entire plant: The entire production from all of the inverters.
- Sub-consumer: Meter to record the individual consumption from appliances that was already recorded with a consumption meter.
- Utility Meter (U+I) (only Solar-Log 2000): Meter for control and reduction functions - including current measurements if necessary with current transformers.
- Utility Meter (U) (only Solar-Log 2000): Meter for control and reduction functions - only voltage measurements.
- Utility Meter (U+I) + Consumption Meter (bi-directional) (only Solar-Log 2000):
Meters that are used as Utility Meters (U+I) can also be used as consumption meters (bi-directional) in this mode.
- Consumption meter: Meter that only records the consumption.
- Consumption meter (Bi-directional meter): Meter that records consumption and production collectively - the actual consumption is determined by monitoring the inverters.
- Generator: The meter values are considered inverter values.



Note

Please make sure that the counter configuration under [Configuration | Devices | Configuration | Configuration](#) in the section „Module field, power & lable“, the value entered in the „Maximum AC power“ field, the measuring range to be recorded and the scaling of the consumption graph, in the Solar-Log™, as well as in the WEB.

3 General Information on Wiring

3.1 Wiring for S0 meter

The S0 connection for external power meters is connected to a 6-pin S0A-In/Out connection (S0-IN A and S0-OUT) or to a 4-pin S0-IN B as follows:

S0 meters in general

S0 Solar-Log™	Solar-Log Base	Power meter
PIN		Assignment
▶ 1	▶ 4	▶ S0+
▶ 2	▶ 5	▶ S0-
▶ 3		
▶ 4		

Place a cable bridge between pin 3 and 4 on the Solar-Log™. No bridge at Solar-Log Base.

3.2 Wiring for RS485 meter

The meter's RS485 output can be connected to any RS485 interface (A, B and C) on the Solar-Log™.

Overview

- 2-pin wiring.
- The communication address has to be assigned.

Installation steps

- Switch off the meter and Solar-Log™.
- Connect the meter to the Solar-Log™.

3.3 Wiring meters to record self-consumption

There are two options to record self-consumption via the Solar-Log™:

- Measuring just the consumption.
- Measuring with bi-directional measurements (two-way measurements) at the grid connection point behind the utility company meter.

Fundamentally, a separate meter needs to be installed to record energy consumption.

The meters used by utility companies generally cannot be used to send data to the Solar-Log™.

3.3.1 Meter connection options to record the total consumption via an RS485/S0 interface.

This meter has to measure the total consumption of the house.
The meters installed by grid operators, or two-way meters, cannot be used to implement this function.

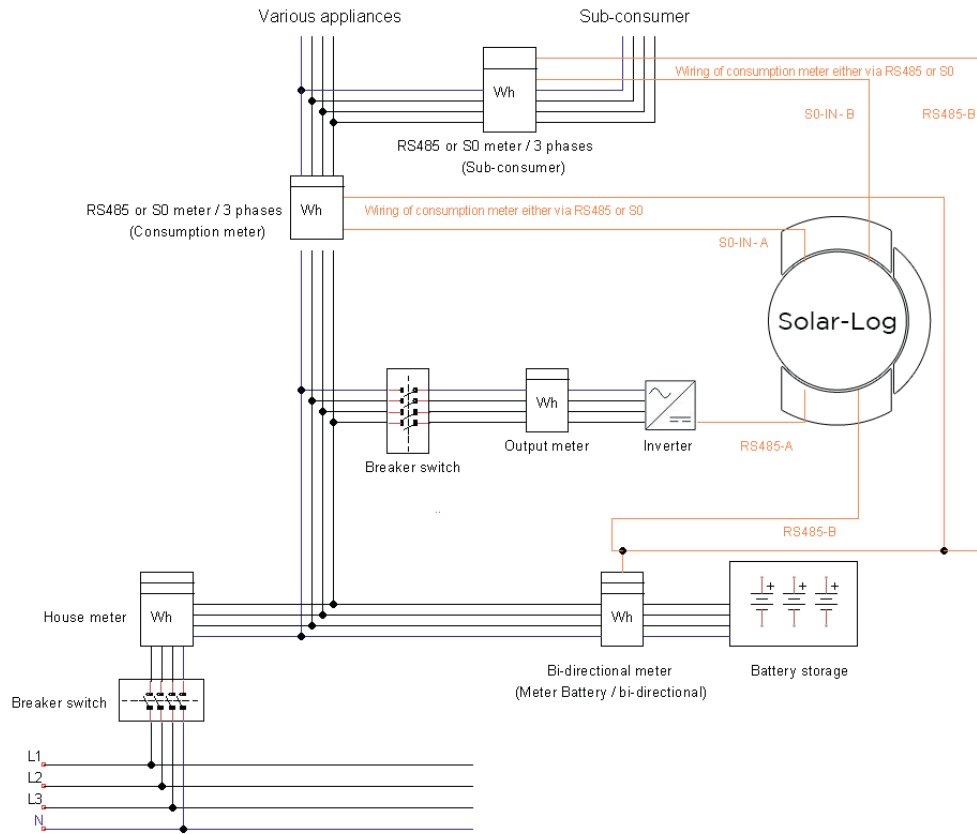

Fig.: Wiring diagram to record self-consumption. (optional with battery storage)

3.3.2 Meter connection options for bi-directional recording of the total consumption via only an RS485 interface.

If there is feed-in in a sub-distribution, the option mentioned above can be used. In this case, the the amount of feed-in power and power obtained from the grid can be recorded with a bi-directional meter. With this, the Solar-Log™ can calculate the consumption.

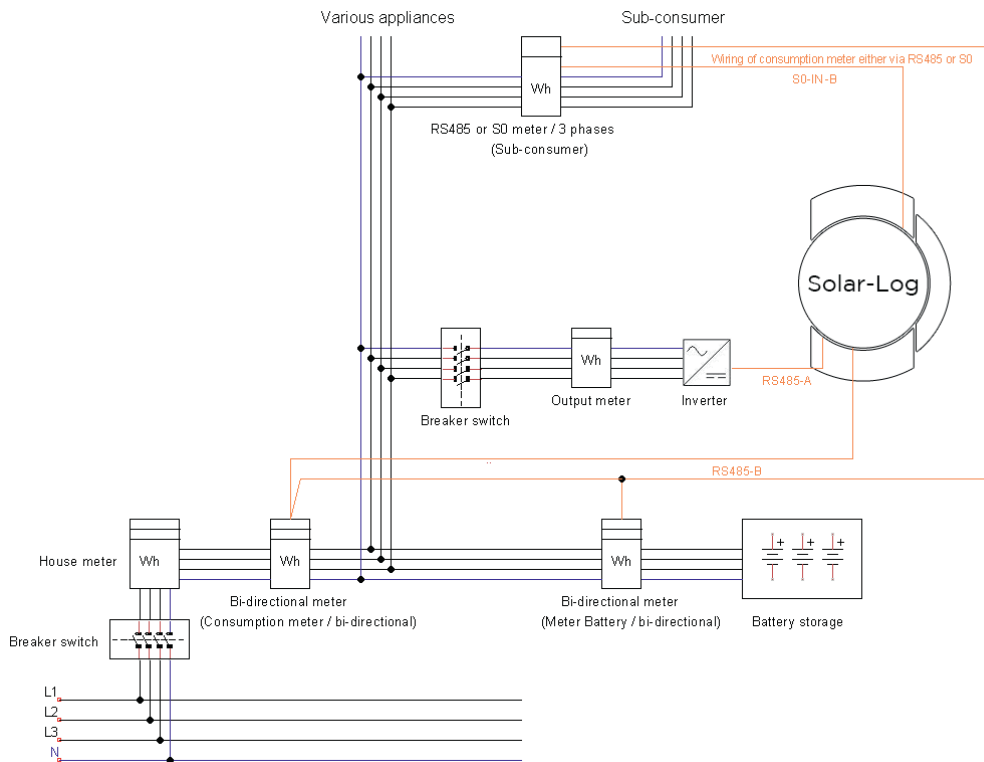

Fig.: Wiring diagram for recording self-consumption – bi-directional meter. (optional with battery storage)

Important information on possible options when using meters for recording consumption:

- Bi-directional meters (only via RS485) in the operating mode „Consumption meter (bi-directional):“ It is only possible to have one meter per Solar-Log™ device. Additional meters are only possible as „sub-consumption meters.“
- Uni-directional meters (RS485 or S0) in the operating mode „Consumption meter:“ It is possible to have several meters connected to a single Solar-Log™ device as consumption meters – the consumption value is totaled together. Additional meters are also possible in the „Consumption meter“ operating mode.
- Meters in the „Consumption meter“ operating mode are used to display the consumption values from individual appliances. These consumption values have already been recorded in the total consumption values by the uni- and bi-directional meters.



Note

With the Solar-Log™, the electricity fed into the power grid from a PV plant can be limited. The actual reduction of output can be set as a fixed rate (kW or %) or dynamic with the local consumption of the generated electricity factored into the actual reduction rate. Recording the current consumption plays a key role when the local consumption is taken into account for the reduction. A consumption meter has to be installed to achieve an accuracy of +/- 2%. It is not generally possible to achieve this accuracy with just a bidirectional meter at the grid connection point. The feed-in limits may be exceeded and there could be irregularities due to different measuring, reading and control intervals. That is why we strongly discourage such installation and the use of S0 meters.



Note

The Solar-Log™ offers the option of a „Fixed Regulation of X% with the Calculation of Self-Consumption.“ A general requirement for the fixed regulation of X% is that the inverters used allow the Solar-Log™ to limit the output. There is a major difference between Solar-Log™ compatible inverters when it comes to power reductions. Some inverters cannot be limited to 0 watts or 0% of the generator output; they produce a certain amount of residual power even when the output is set to zero. This needs to be considered when designing plants with 0% output reduction. For example, the base load always needs to be greater than the residual power output. There is also a distinct difference between the reaction times of various inverters. The reaction time also depends on the number of devices installed. It is not recommended to use S0 meters for 0% reductions.

- ▶ For these reasons, Solare Datensysteme GmbH cannot guarantee an absolute 0% feed-in reduction.
- ▶ It is always necessary to consult the grid operator about the reduction.

4 Solar-Log™ PRO

4.1 Solar-Log™ PRO1 Mod (single phase)

Selections available under „Solar-Log/Pro/RS485“

Overview

- The communication address has to be assigned.
- 2-pin wiring.
- Installation steps:
 - Switch off the meter and the Solar-Log™.
 - Connect the meter to the Solar-Log™.



Note

The communication address is set to 1 by default, but can be adjusted if several meters are connected to one RS485 bus.

Max. number of counters: approx. 60 counters on the bus

Range: approx. 1000m*

* Please note that the maximum number of counters can vary, depending on the installed level converter, baud rate and other installation circumstances.

Connect the meter to the Solar-Log™

The wiring is done using a

- self-made cable connection with a terminal block connector.

Connection diagram

According to circuit type 1000 (DIN 43856)

L-IN Terminal 1	Supply line input phase „L1“
L-OUT Terminal 3	Supply line output phase „L1“
Terminal 4 „N“	Neutral conductor connection „N“
Terminal 6 „N“	Neutral conductor connection „N“
Terminal 20, 21	S ₀ pulse output
Terminal 23,24	ModBus connection terminal 23 -> A, 24 -> B

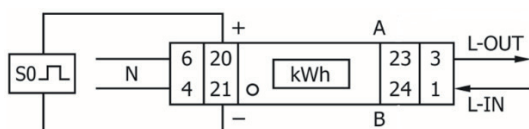

Fig.: Pin assignment

Connection diagram for different operating modes

The meter connections are labeled IN and OUT

Solar-Log™ PRO1 Mod (RS485 or S0) connection assignments

▶ As consumption or sub-consumer meter	Connection to the grid (IN) – connection for appliances (OUT)
▶ As generator / production meter	Connection for the production (IN) – connection to the grid (OUT)

Solar-Log™ PRO1 Mod connection assignments (only RS485)

▶ As a battery meter (bi-directional)	Connection to the production/grid (IN) – connection to the battery (OUT)
---------------------------------------	--

Cable connection via RS485:

Solar-Log™ terminal strip connector	Solar-Log 50	Solar-Log Base RS485 (A) / (B)	Solar-Log™ PRO1 Mod
Terminal			PIN
▶ 1 (Data+)	▶ 1 or 5	▶ (A) 6 or (B) 10 (Data+)	▶ 23 (A)
▶ 4 (Data-)	▶ 4 or 6	▶ (A) 9 or (B) 13 (Data-)	▶ 24 (B)



Note

If the meter is the last device on the bus, it has to be terminated at connection block 23 and 24 with a resistor (120 ohm / 0.25W).



Note

The Inepro PRO1 Mod cannot be connected to the inverters with a single bus. For this reason, use one RS485 connection for the inverters and one RS485 connection for the Solar-Log™ PRO1 Mod.

- ▶ A combination with a M&T sensor as well as with the Solar-Log™ PRO380 Mod and Solar-Log™ Pro380-CT in the same bus is possible.

Possible meter operating modes for the Solar-Log™ PRO1 Mod via RS485:

- Battery meter (bi-directional)
- Sub-consumption meter
- Consumption meter
- Generator

Cable connection via S0 (in):

Solar-Log™ S ₀ terminal block	Solar-Log Base	Solar-Log™ PRO1-Mod
Pin assignment		Pin assignment
▶ 1 - S0+	▶ 4 - S0+	▶ 20 - S0+
▶ 2 - S0-	▶ 5 - S0-	▶ 21 - S0-
▶ 3		
▶ 4		

Place a cable bridge between pin 3 and 4 on the Solar-Log™. No bridge at Solar-Log Base.

Possible meter operating modes for the Solar-Log™ PRO1 Mod via S0 connection:

- Total plant meter
- Sub-consumption meter
- Consumption meter
- Generator

Meter's impulse factor:

1000 p / kWh



Note the S0 pulse length for the Solar-Log™ PRO1-Mod.

The following values for the S0 pulse length are known:

- ▶ ≤ 5625W = pulse length 32ms
- ▶ > 5625W = pulse length 11,2ms

The Solar-Log™ can process a S0 pulse with at least a length of 30 ms. This means a maximum pulse length of 5625W can be defined for the S0 output of the Solar-Log™ PRO1 Mod.

4.2 Solar-Log™ PRO2 Mod (single phase)

Selections available under „Solar-Log/Pro/RS485“

Overview

- The communication address has to be assigned.
- 2-pin wiring.
- Installation steps:
 - Switch off the meter and the Solar-Log™.
 - Connect the meter to the Solar-Log™.



Note

The communication address is set to 1 by default, but can be adjusted if several meters are connected to one RS485 bus.

Max. number of counters: approx. 60 counters on the bus

Range: approx. 1000m*

* Please note that the maximum number of counters can vary, depending on the installed level converter, baud rate and other installation circumstances.

Connect the meter to the Solar-Log™

The wiring is done using a

- self-made cable connection with a terminal block connector.

Connection diagram

According to circuit type 1000 (DIN 43856)

L-IN Terminal 1	Supply line input phase „L1“
L-OUT Terminal 3	Supply line output phase „L1“
Terminal 4 „N“	Neutral conductor connection „N“
Terminal 6 „N“	Neutral conductor connection „N“
Terminal 18, 19	S ₀ pulse output „Forward“ (terminal 18 = „+“)
Terminal 20,21	S ₀ pulse output „Reverse“ (terminal 20 = „+“)

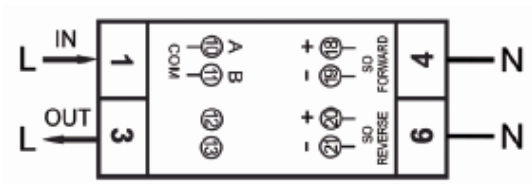

Fig.: Pin assignment

Connection diagram for different operating modes

The meter connections are labeled IN and OUT

Solar-Log™ PRO2 Mod (RS485 or S0) connection assignments

▶ As consumption or sub-consumer meter	Connection to the grid (IN) – connection for appliances (OUT)
▶ As generator / production meter	Connection for the production (IN) – connection to the grid (OUT)

Solar-Log™ PRO2 Mod connection assignments (only RS485)

▶ As a battery meter (bi-directional)	Connection to the production/grid (IN) – connection to the battery (OUT)
---------------------------------------	--

Cable connection via RS485:

Solar-Log™ terminal strip connector	Solar-Log 50	Solar-Log Base RS485 (A) / (B)	Solar-Log™ PRO2 Mod PIN
▶ 1 (Data+)	▶ 1 or 5	▶ (A) 6 or (B) 10 (Data+)	▶ 10 (A)
▶ 4 (Data-)	▶ 4 or 6	▶ (A) 9 or (B) 13 (Data-)	▶ 11 (B)



Note

If the meter is the last device on the bus, it has to be terminated at connection block 23 and 24 with a resistor (120 ohm / 0.25W).



Note

The Inepro PRO2 Mod cannot be connected to the inverters with a single bus. For this reason, use one RS485 connection for the inverters and one RS485 connection for the Solar-Log™ PRO2 Mod.

- ▶ A combination with a M&T sensor as well as with the Solar-Log™ PRO380 Mod and Solar-Log™ Pro380-CT in the same bus is possible.

Possible meter operating modes for the Solar-Log™ PRO2 Mod via RS485:

- Battery meter (bi-directional)
- Sub-consumption meter
- Consumption meter
- Generator

Cable connection via S0 (in):

Solar-Log™ S ₀ terminal block	Solar-Log Base	Solar-Log™ PRO2-Mod
Pin assignment		Pin assignment
▶ 1 - S0+	▶ 4 - S0+	▶ 18 - S0+
▶ 2 - S0-	▶ 5 - S0-	▶ 19 - S0-
▶ 3		
▶ 4		

Place a cable bridge between pin 3 and 4 on the Solar-Log™. No bridge at Solar-Log Base.

Possible meter operating modes for the Solar-Log™ PRO2 Mod via S0 connection:

- Total plant meter
- Sub-consumption meter
- Consumption meter
- Generator

Meter's impulse factor:

1000 p / kWh

4.3 Solar-Log™ PRO380 Mod

Selections available under Solar-Log Pro

Overview

- The communication address has to be assigned.
- 2-pin wiring.
- Installation steps:
 - Switch off the meter and the Solar-Log™.
 - Connect the meter to the Solar-Log™.



Note

The communication address is set to 1 by default, but can be adjusted if several meters are connected to one RS485 bus.

Max. number of counters: approx. 60 counters on the bus

Range: approx. 1000m*

* Please note that the maximum number of counters can vary, depending on the installed level converter, baud rate and other installation circumstances.

Connect the meter to the Solar-Log™.

The wiring is done using a

- self-made cable connection with a terminal block connector.

Connection diagram

according to circuit type 1000 (DIN 43856)

Input "L1, L2, L3"	Supply line input phase "L1, L2, L3"
Output "L1, L2, L3"	Supply line output phase "L1, L2, L3"
Terminal "N"	Neutral conductor connection "N"
Terminal 18, 19	S_o pulse output "FOWARD" (terminal 18 = "+")
Terminal 20, 21	S_o pulse output "REVERSE" (terminal 20 = "+")
Terminal 22, 23	ModBus connection terminal 22 -> A, 23 -> B
Terminal 24, 25	External tariff switching (230V AC)

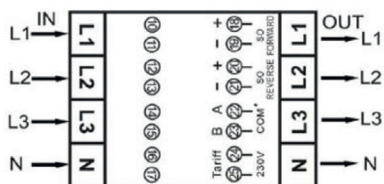

Fig.: Pin assignment

Connection diagram for different operating modes

The meter connections are labeled IN (bottom) and OUT (top).

Solar-Log™ Pro380 Mod (RS485 or S0) connection assignments

▶ As consumption or sub-consumer meter	Connection to the grid (IN) – connection for appliances (OUT)
▶ As inverter / production meter	Connection for the production (IN) – connection to the grid (OUT)

Solar-Log™ Pro380 Mod connection assignments (only RS485)

▶ As a consumption meter (bi-directional)	Connection for grid (OUT) – connection to the house/ plant (IN) (installation position according to the arrow system)
▶ As battery meter (bi-directional):	Connection to the production/grid (IN) – connection to the battery (OUT)

Cable connection via RS485:

Solar-Log™ terminal strip connector	Solar-Log 50	Solar-Log Base RS485 (A) / (B)	Solar-Log™ PRO380 Mod
Terminal			PIN
▶ 1 (Data+)	▶ 1 or 5	▶ (A) 6 or (B) 10 (Data+)	▶ 22 (A)
▶ 4 (Data-)	▶ 4 or 6	▶ (A) 9 or (B) 13 (Data-)	▶ 23 (B)



Note

If the meter is the last device on the bus, it has to be terminated at connection block 22 and 23 with a resistor (120 ohm / 0.25W).



Note

The Solar-Log™ PRO380 Mod cannot be connected to the inverters with a single bus.

For this reason, use one RS485 connection for the inverters and one RS485 connection for the Solar-Log™ PRO380 Mod.

▶ A combination with a M&T sensor as well as with the Solar-Log™ PRO1 Mod and Solar-Log™ Pro380-CT in the same bus is possible.

Possible meter operating modes for the Solar-Log™ PRO380 Mod via RS485:

- Battery meter (bi-directional)
- Total plant meter
- Sub-consumption meter
- Consumption meter
- Consumption meter (bi-directional)
- Generator

Cable connection via S0 (IN):

Solar-Log™ S ₀ terminal block	Solar-Log Base	Solar-Log™ PRO380 Mod
Pin assignment		Pin assignment
▶ 1 - S0+	▶ 4 - S0+	▶ 18 - S0+
▶ 2 - S0-	▶ 5 - S0-	▶ 19 - S0-
▶ 3		
▶ 4		

Place a cable bridge between pin 3 and 4 on the Solar-Log™. No bridge at Solar-Log Base.

Possible meter operating modes for the Solar-Log™ PRO380 Mod via S0 connection (IN):

- Total plant meter
- Sub-consumption meter
- Consumption meter
- Generator

Impulse factor of the meter:

1000 p / kWh

4.3 Solar-Log™ PRO380-CT

Selections available under Solar-Log Pro



Important!

The converter ratio can only be set once with this transformer-connected meter.

- ▶ It is essential to clarify which converter ratio is to be set for the meter before the initial installation.

When the meter is connected to power, the display alternates between „Set CT“ and „CT5 0005.“. If one of the arrow keys is pressed, the first number from the left blinks. Using the arrow keys, define the secondary power between /1A and /5A and confirm the selection by pressing both of the arrow keys at the same time for 3 seconds. After that, define the primary power by selecting the 4 numbers from left to right with the arrow keys. The primary power can be freely set between 0005 and 9995. The first three digits can be between 0 and 9 and the last digit between 0 and 5. Confirm every number by pressing both arrow keys for 3 seconds.

The converter ratio has now been set and cannot be modified.

Overview

- The communication address has to be assigned.
- 2-pin wiring.
- Installation steps:
 - Switch off the meter and the Solar-Log™.
 - Connect the meter to the Solar-Log™.



Note

The communication address is set to 1 by default, but can be adjusted if several meters are connected to one RS485 bus.

Max. number of counters: approx. 60 counters on the bus

Range: approx. 1000m*

* Please note that the maximum number of counters can vary, depending on the installed level converter, baud rate and other installation circumstances.

Connect the meter to the Solar-Log™.

The wiring is done using a

- self-made cable connection with a terminal block connector.

Connection diagram

according to circuit type 1000 (DIN 43856)

CT 1 (in) terminal k (s1) / (out) terminal I (s2)	10 Volts Phase 1 (10/11 internally bridged)
CT 2 (in) terminal k (s1) / (out) terminal I (s2)	12 Volts Phase 2 (12/13 internally bridged)
CT 3 (in) terminal k (s1) / (out) terminal I (s2)	14 volts phase 3 (14/15 internally bridged)
Terminal "N"	Neutral conductor connection "N"
Terminal 18, 19	S _o pulse output "FORWARD" (terminal 18 = "+")
Terminal 20, 21	S _o pulse output "REVERSE" (terminal 20 = "+")
Terminal 22, 23	ModBus connection terminal 22 -> A, 23 -> B
Terminal 24, 25	External tariff switching (230V AC)

The SO signal for the supply is not used when a meter is connected to the Solar-Log™.

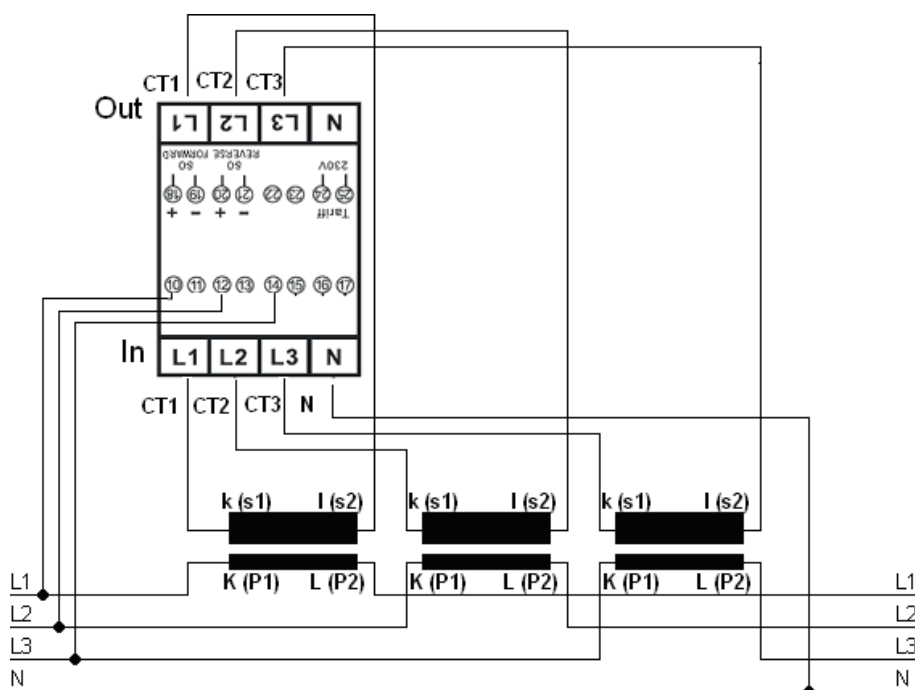

Fig.: Pin assignment

Note



We recommend using a fuse to safeguard the connection lines for the voltage measurement in accordance with the local laws and regulations and with appropriate isolating switches and overload protection devices.

Connection diagram for different operating modes

The pin assignments refer to the figure above.

Solar-Log™ Pro380 CT (RS485 or S0) connection assignments

▶ As consumption or sub-consumer meter	Access to the grid on converter K(P1) - outgoing line to appliance on converter L(P2)
▶ As generator / meter for the entire plant	Access to production on converter K(P1) - outgoing line to the grid on converter L(P2)

Solar-Log™ Pro380 CT connection assignments (only RS485)

▶ As a consumption meter (bi-directional)	Access to the grid on converter L(P2) - outgoing line to house/plant on converter K(P1) (installation position according to the arrow system) (Starting with firmware version 3.4.2, the metering direction (report) for consumption meters in bi-direction mode can be set in the Solar-Log™.)
▶ As a battery meter (bi-directional)	Access to production/grid on converter K(P1) - outgoing line to the battery on converter L(P2)

Cable connection via RS485:

Solar-Log™ terminal strip connector	Solar-Log 50	Solar-Log Base RS485 (A) / (B)	Solar-Log™ PRO380-CT (COM)
Terminal			PIN
▶ 1 (Data+)	▶ 1 or 5	▶ (A) 6 or (B) 10 (Data+)	▶ 22 (A)
▶ 4 (Data-)	▶ 4 or 6	▶ (A) 9 or (B) 13 (Data-)	▶ 23 (B)



Note

If the meter is the last device on the bus, it has to be terminated at connection block 22 and 23 with a resistor (120 ohm / 0.25W).



Note

The Solar-Log™ PRO380 CT cannot be connected to the inverters with a single bus. For this reason, use one RS485 connection for the inverters and one RS485 connection for the Solar-Log™ PRO380 CT.

- ▶ A combination with a M&T sensor as well as with the Solar-Log™ PRO380 Mod and Solar-Log™ Pro1 Mod in the same bus is possible.

Possible meter operating modes for the Solar-Log™ PRO380 CT via RS485:

- Battery meter (bi-directional)
- Total plant meter
- Sub-consumption meter
- Consumption meter
- Consumption meter (bi-directional)
- Generator

Cable connection via S0 (IN):

Solar-Log™ S ₀ terminal block	Solar-Log Base	Solar-Log™ PRO380-CT
Pin assignment		Pin assignment
▶ 1 - S0+	▶ 4 - S0+	▶ 18 - S0+
▶ 2 - S0-	▶ 5 - S0-	▶ 19 - S0-
▶ 3		
▶ 4		

Place a cable bridge between pin 3 and 4 on the Solar-Log™. No bridge at Solar-Log Base.

Possible meter operating modes for the Solar-Log™ PRO380 CT via S0 connection (IN):

- Total plant meter
- Sub-consumption meter
- Consumption meter
- Generator

Meter's impulse factor:

10000 p / kWh

5 Inepro

5.1 Inepro 75D

Selections available under Inepro / DMM

Overview

- The communication address cannot be freely assigned.
- 2-pin wiring.
- Installation steps:
 - Switch off the meter and the Solar-Log™.
 - Connect the meter to the Solar-Log™.

Connect the meter to the Solar-Log™.

The wiring is done using a

- self-made cable connection with a terminal block connector.

Cable connection via RS485:

Solar-Log™ RS485 terminal block	Solar-Log 50	Solar-Log Base RS485 (A) / (B)	Inepro 75D
Pin assignment			Pin assignment
▶ 1 (Data+)	▶ 1 or 5	▶ (A) 6 or (B) 10 (Data+)	▶ 8 - RS485A
▶ 4 (Data-)	▶ 4 or 6	▶ (A) 9 or (B) 13 (Data-)	▶ 7 - RS485B

Possible meter operating modes for the Inepro 75D meter via RS485:

- Total plant metert
- Sub-consumption meter
- Consumption meter
- Generator

Cable connection via S0:

Solar-Log™ S ₀ terminal block	Solar-Log Base	Inepro 75D
Pin assignment		Pin assignment
▶ 1 - S0+	▶ 4 - S0+	▶ 6 - S0+
▶ 2 - S0-	▶ 5 - S0-	▶ 5 - S0-
▶ 3		
▶ 4		

Place a cable bridge between pin 3 and 4 on the Solar-Log™. No bridge at Solar-Log Base.

Possible meter operating modes for the Inepro 75D meter via S0:

- Total plant meter
- Sub-consumption meter
- Consumption meter
- Generator

Impulse factor of the meter:

1600 p / kWh



Note

The Inepro 75D cannot be used on the same bus input with RS422 connected inverters.



Note

The Inepro 75D meters are automatically assigned the mod bus address 234 by Solar-Log™ during the detection process.

This address is therefore not allowed to be used for other devices.

After the configuration, the display on the Inepro meter alternates between the meter status and the address display (ID=EA). This can be used to check if Solar-Log™ has correctly detected the meter.

All RS485 meters have to be terminated with a 120Ω resistor between the two pins used.

5.2 Inepro 1250D

Selections available under Inepro / DMM

Overview

- The communication address cannot be freely assigned.
- 2-pin wiring.
- Installation steps:
 - Switch off the meter and the Solar-Log™.
 - Connect the meter to the Solar-Log™.

Connect the meter to the Solar-Log™.

The wiring is done using a

- self-made cable connection with a terminal block connector.

Cable connection via RS485:

Solar-Log™ RS485 terminal block	Solar-Log 50	Solar-Log Base RS485 (A) / (B)	Inepro 1250D
Pin assignment			Pin assignment
▶ 1 (Data+)	▶ 1 or 5	▶ (A) 6 or (B) 10 (Data+)	▶ 11 - RS485A
▶ 4 (Data-)	▶ 4 or 6	▶ (A) 9 or (B) 13 (Data-)	▶ 10 - RS485B

Possible meter operating modes for the Inepro meter 1250D via RS485:

- Total plant meter
- Sub-consumption meter
- Consumption meter
- Generator

Cable connection via S0:

Solar-Log™ S ₀ terminal block	Solar-Log Base	Inepro 1250D
Pin assignment		Pin assignment
▶ 1 - S0+	▶ 4 - S0+	▶ 9 - S0+
▶ 2 - S0-	▶ 5 - S0-	▶ 8 - S0-
▶ 3		
▶ 4		

Place a cable bridge between pin 3 and 4 on the Solar-Log™. No bridge at Solar-Log Base.

Possible meter operating modes for the Inepro 1250D meter via S0:

- Total plant meter
- Sub-consumption meter
- Consumption meter
- Generator

Impulse factor of the meter:

400 p / kWh

Connection diagram for different operating modes

Solar-Log™ Inepro 1250D (RS485 or S0) connection assignments

▶ As consumption or sub-consumer meter	Connection to the grid (IN) – connection for appliances (OUT)
▶ As inverter / production meter	Connection for the production (IN) – connection to the grid (OUT)



Note

The Inepro 1250D cannot be used on the same bus input with RS422 connected inverters.



Note

All three phases have to be connected for the Solar-Log™ to accurately detect the meter.

If an Inepro 1250D is used, the PRG button on the meter must be pressed and held down during entire detection process.

If it is not possible to hold down the PRG button during the whole process, we recommend provisionally connecting the meter to the Solar-Log™ with a short cable after the installation in order to be able to press and hold down the PRG button during entire detection process.

In a second detection attempt with the inverter, the meter is then detected by the Solar-Log™ even if the PRG button is not pressed.

The detection of an Inepro 1250D in an existing installation can take up to 15 minutes. After the detection, a restructuring of the data takes places which can take up to 45 minutes depending on the amount of data on the devices.



Note

The Inepro 1250D meters are automatically assigned the mod bus address 234 by Solar-Log™ during the detection process.

This address is therefore not allowed to be used for other devices.

After the configuration, the display on the Inepro meter alternates between the meter status and the address display (ID=EA). This can be used to check if Solar-Log™ has correctly detected the meter.

All RS485 meters have to be terminated with a 120Ω resistor between the two pins used.

6 Iskra

6.1 Iskra WS0021

Overview

- 2-pin wiring.
- Installation steps:
 - Switch off the meter and the Solar-Log™.
 - Connect the meter to the Solar-Log™.

Connect the meter to the Solar-Log™.

The wiring is done using a

- self-made cable connection with a terminal block connector.

Cable connection via S0:

Solar-Log™ S₀ terminal block

Solar-Log Base

Iskra WS0021

Pin assignment

▶ 1 - S0+

▶ 4 - S0+

▶ 9 - S0-

▶ 2 - S0-

▶ 5 - S0-

▶ 8 - S0+

▶ 3

▶ 4

Place a cable bridge between pin 3 and 4 on the Solar-Log™. No bridge at Solar-Log Base.

Possible meter operating modes for the Iskra WS0021 meter via S0:

- Total plant meter
- Sub-consumption meter
- Consumption meter
- Generator

Impulse factor of the meter:

1000 p / kWh

6.2 Iskra WS0031

Overview

- 2-pin wiring.
- Installation steps:
 - Switch off the meter and the Solar-Log™.
 - Connect the meter to the Solar-Log™.

Connect the meter to the Solar-Log™.

The wiring is done using a

- self-made cable connection with a terminal block connector.

Cable connection via S0:

Solar-Log™ S ₀ terminal block	Solar-Log Base	Iskra WS0031
Pin assignment		Pin assignment
▶ 1 - S0+	▶ 4 - S0+	▶ S0+
▶ 2 - S0-	▶ 5 - S0-	▶ S0-
▶ 3		
▶ 4		

Place a cable bridge between pin 3 and 4 on the Solar-Log™. No bridge at Solar-Log Base.

Possible meter operating modes for the Iskra WS0031 meter via S0:

- Total plant meter
- Sub-consumption meter
- Consumption meter
- Generator

Impulse factor of the meter:

500 p / kWh

6.3 Iskra WS1102

Selections available under Iskra

Overview

- 2-pin wiring.
- Installation steps:
 - Switch off the meter and the Solar-Log™.
 - Connect the meter to the Solar-Log™.

Connect the meter to the Solar-Log™.

The wiring is done using a

- self-made cable connection with a terminal block connector.

Cable connection via RS485:

Solar-Log™ RS485 terminal block	Solar-Log 50	Solar-Log Base RS485 (A) / (B)	Iskra WS1102
Pin assignment			Pin assignment
▶ 1 (Data+)	▶ 1 or 5	▶ (A) 6 or (B) 10 (Data+)	▶ A+ (23)
▶ 4 (Data-)	▶ 4 or 6	▶ (A) 9 or (B) 13 (Data-)	▶ B- (24)

Possible meter operating modes for the Iskra WS1102 meter via RS485:

- Total plant meter
- Sub-consumption meter
- Consumption meter
- Generator



Note

If the meter is the last device on the bus, it has to be terminated at connection block A (23) and B (24) with a resistor (120 ohm).



Note

A maximum of 32 devices can be connected per bus.

7 Janitza UMG 104 / UMG 604 / UMG 604-PRO (Utility Meter)

7.1 Janitza UMG 104 / UMG 604 / UMG 604-PRO

The Solar-Log™ Utility Meter is a universal metering device. It can be integrated in both low- and medium-voltage networks (via a transformer) and is needed for various functions:

- controlling voltage-dependent reactive power via the Q(U) function
- controlling reactive power at the feeding point
- recording the measurement data needed for the response signals sent to the grid operator

Only voltage measurements are required for voltage-dependent reactive power reduction Q(U). However, we still recommend using both current and voltage measurements to be able to check that the reduction function is operating properly. Current and voltage measurements are needed for the other functions.

Utility Meter supply voltage:

- 95-240Vac, 45-65Hz or 135-340Vdc

The Utility Meter's measuring inputs have the following limits:

- Voltage line conductor AC (without a voltage transformer): 10...300 V AC.
- Voltage phase AC (without a voltage transformer): 17...520 V AC.
- Current (without a current transformer) 0.005, 7.5 A.
- Frequency of the fundamental component: 45 ..65 Hz.

The limit may not be exceeded. For this reason, a measuring transformer needs to be installed for most applications.

We recommend the following transformer ratio:

- Voltage: Secondary 100V
e.g. at 20kV grid converter 20000:100V.
- Current: Secondary 5A
e.g. 100:5A.



Note

The Utility Meter that we use is produced by the company Janitza. Refer to the Janitza UMG 104 / UMG 604 / UMG 604-PRO manual for further technical details. We cannot guarantee the functionality of other Janitza devices.

- ▶ The operating modes Utility Meter (U / U+I) is only possible with the Solar-Log 1000 and 2000.
-



Note

The Utility Meter cannot be connected to the inverters with a single bus. For this reason, use one RS485 connection for the inverters and one RS485 connection for the Utility Meter.

Connecting the Utility Meter to the power grid

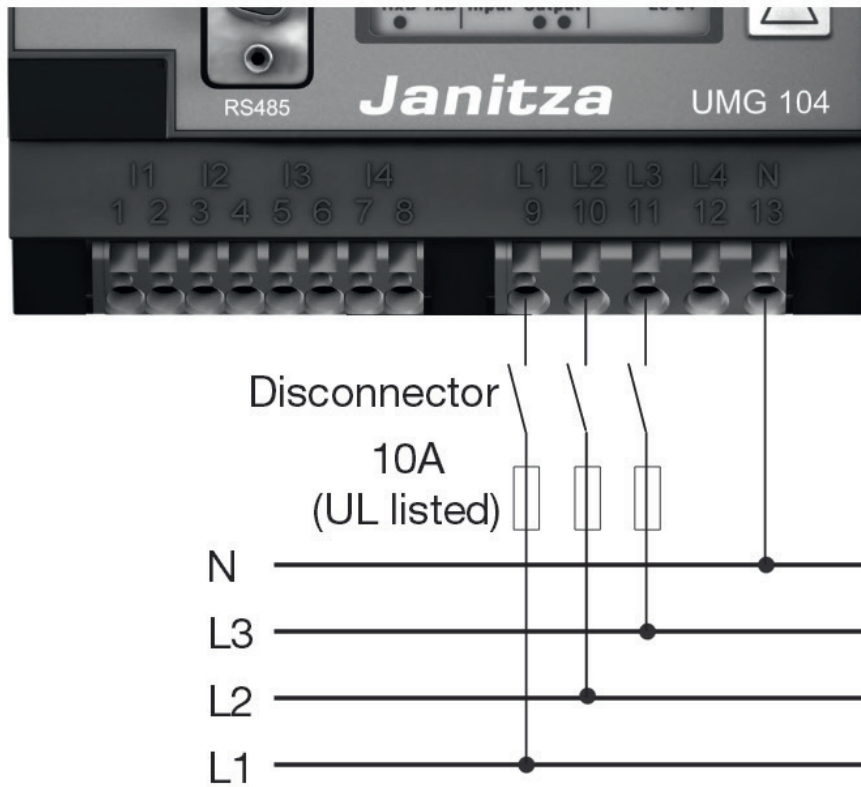

Fig.: Example - UMG 104 Utility Meter connection diagram for voltage measurements in low-voltage power grids

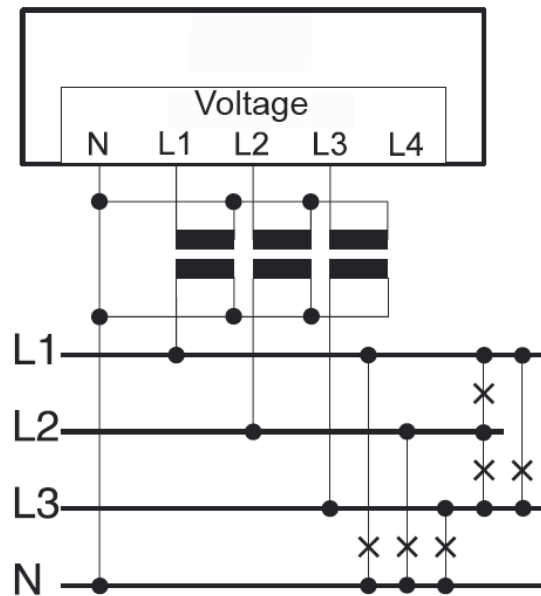

Fig.: Utility Meter connection diagram for voltage measurements with current transformers (medium voltage)

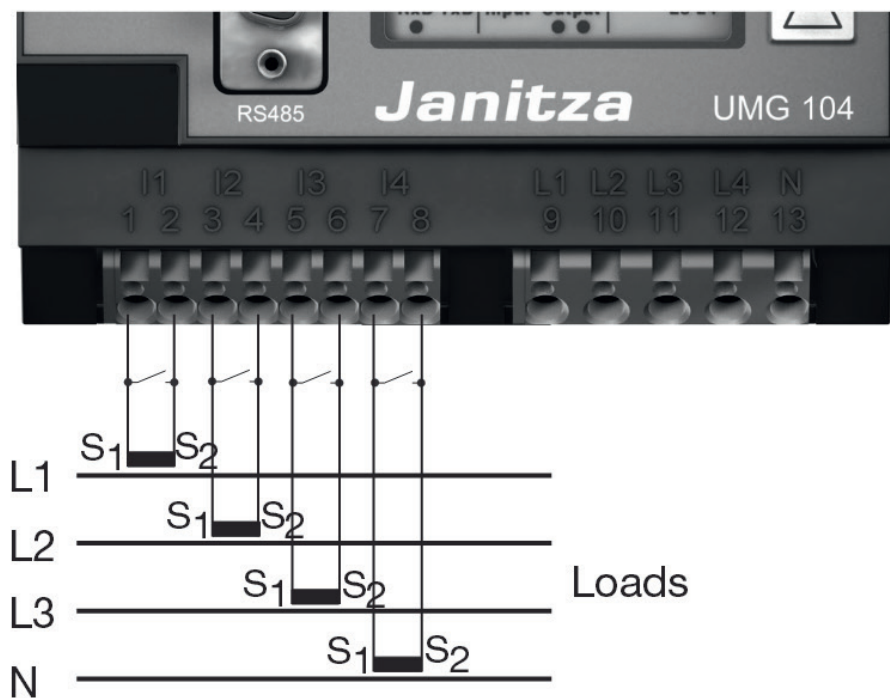

Fig.: Example - UMG 104 Utility Meter connection diagram for current measurements with current transformers

Procedure

- Enter the supply voltage into the Utility Meter



Note

We recommend using a fuse to safeguard the connection lines for the supply voltage. Please follow the instructions in the Janitza UMG 104 / UMG 604 / UMG 604-PRO manual.



Note

Supply voltages that do not correspond to the specifications on the rating plate can cause malfunctions and damage the device.



Caution

The inputs for the supply voltage are dangerous to touch.



Note

The measurement voltage must in effect be at least 10V or an exact measurement is not possible.

Cable connection via RS485:

1. Connect the wires as shown in the following diagram:

Solar-Log™ terminal strip connector	Solar-Log 50	Solar-Log Base RS485 (A) / (B)	Utility meter terminal strip
Terminal			PIN
▶ 1 (Data+)	▶ 1 or 5	▶ (A) 6 or (B) 10 (Data+)	▶ 22
▶ 4 (Data-)	▶ 4 or 6	▶ (A) 9 or (B) 13 (Data-)	▶ 23

2. Insert the terminal block connector into the Solar-Log™ RS485 socket.

- The RS485 bus must be terminated.
Install a 120 Ohm, 0.25 W resistor between pin 22 and 23 of the Utility Meter to terminate.
- Configuring the Utility Meter from the display
Setting MODBUS Address (PRG 200 = 1)
Setting Baud rate RS485 (PRG 202 = 2)
Setting Mode (PRG 203 = 0)
Setting Current converter primary (PRG 000)
Setting Current converter secondary (PRG 001)
Setting Voltage converter primary (PRG 002)
Setting Voltage converter secondary (PRG 003)
Refer to the accompanying manual of the device for the UMG 104 / UMG 604 / UMG 604-PRO configuration procedure.



Note

The parameter settings need to be adjusted before device detection.
If the parameters differ, the Utility Meter will not be detected by the Solar-Log™.

- Perform an inverter detection
See the installation manual, Chapter „Performing inverter detections.“
- Configure the Utility-Meter under [Configuration | Devices | Configuration](#), select the corresponding [Operating mode](#) and click on [Save](#).

Check

- Does the Utility Meter display a positive value for inverters feeding power, the current output (kW)?
If this is not the case, the current measurements are incorrectly connected.
If necessary, switch the polarity of measuring inputs.



Note

When replacing the polarity, the cable must not be energized, since the converter can be destroyed otherwise.

Possible meter operating modes for the Janitza UMG 104 / UMG 604 / UMG 604-PRO via RS485:

- Battery meter (bi-directional)
- Total plant meter
- Sub-consumer
- Utility Meter (U)
- Utility Meter (U+I)
- Utility Meter (U+I) + Consumption Meter (bi-directional)
- Consumption meter
- Consumption meter (bi-directional)
- Generator

Connection assignments / installation position of the Janitza UMG 104 / UMG 604 / UMG 604-PRO (Utility Meter) in connection with the Solar-Log™



Note

Check the installation position of the current transformers for the different operating modes of the Janitza UMG 104 / UMG 604 / UMG 604-PRO.



Note

Check that the phase assignment of the voltage measurements for the current measurements is correct.

The following output values are recorded in the various operating modes when the installation position is correct.

Operating mode	Output value
▶ As a Utility Meter (U+I)	with positive output value (kW) for feed-in
▶ As total plant meter	with positive output value (kW) for feed-in
▶ As an inverter	with positive output value (kW) for feed-in
▶ As a consumption or sub-consumer meter:	with positive output value (kW) for consumption
▶ As a consumption meter (bi-directional)	When the production is greater than the consumption, positive output values (kW) (installation position according to the arrow system) (From firmware 3.4.2, the counting directions (evaluation) can be changed in the Solar-Log™ of consumption meters in bi-directional mode in the device configuration.)
▶ As a battery meter (bi-directional)	<ul style="list-style-type: none"> ▶ When the battery storage is being charged, positive output values (kW). ▶ When the battery storage is being discharged, negative output values (kW).

7.2 Janitza UMG 604 / UMG 604-PRO via Ethernet

Termination	Addressing	Interface
No	Yes	LAN

Overview

- Integrated interface.
- Connect using network cable (patch cable) and Ethernet router or switch.
- A static IP address must be assigned.
- Installation steps:
 - Switch off the Janitza device and the Solar-Log™.
 - Connect the Janitza device to the Solar-Log™.

Connect Janitza to the Solar-Log™

The wiring is done using a

- network cable (patch cable/crossover cable) and the
- Ethernet router or switch.

Assign the IP address for detection and communication:

IP addresses assignment according to manufacturer's instructions. Both devices need to be in the same subnet mask.

Detection via the Solar-Log™ WEB Interface

- For detection on the Solar-Log™, select the device class under the menu [Configuration | Device | Definition | Interface](#) with the plus symbol and then select Janitza as the manufacturer. Confirm your selection with OK.
- Save your selections and then start the Device Detection under [Configuration | Device | Detection](#).

Detection from the Solar-Log 1200

- When using the Solar-Log 1200, the detection can also be started from the display. Select the settings [Start ► Initial Configuration ► Page 2 „Device“ ► Add](#) and select the manufacturer Janitza from there. Save and start the Device Detection.



Note

The meter operating modes via Ethernet are identical to those of the RS485 version.

8 Larsen & Toubro

8.1 Larsen & Toubro (WDM313CDNC)

Selections available under L&T

Overview

- The communication address has to be assigned.
- 2-pin wiring.
- Installation steps:
 - Switch off the meter and the Solar-Log™.
 - Connect the meter to the Solar-Log™.

Connect the meter to the Solar-Log™.

The wiring is done using a

- self-made cable connection with a terminal block connector.

Cable connection via RS485:

Solar-Log™ RS485 terminal block	Solar-Log 50	Solar-Log Base RS485 (A) / (B)	L&T WDM313CDNC
Pin assignment			Pin assignment
▶ 1 (Data+)	▶ 1 or 5	▶ (A) 6 or (B) 10 (Data+)	▶ 9 D+
▶ 4 (Data-)	▶ 4 or 6	▶ (A) 9 or (B) 13 (Data-)	▶ 10 D-

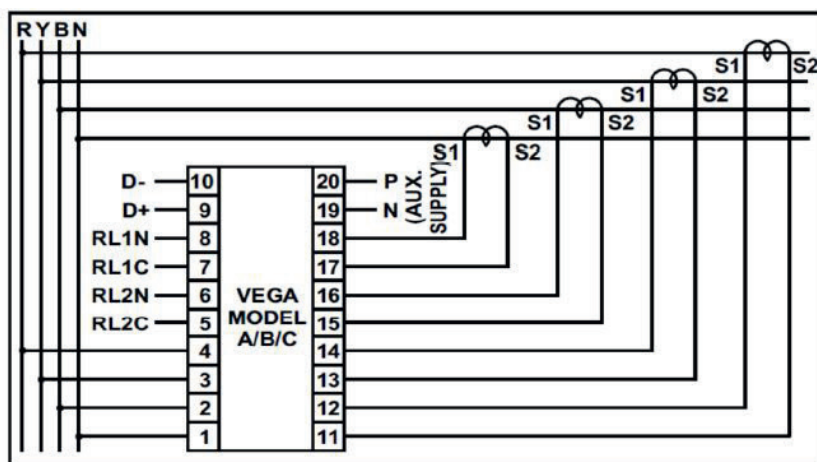

Fig.: Pin assignment



Note

The following parameters need to be checked before the device detection to ensure that the meter is detected.

Assign the communication address (start with 1).

Baud rate: 9600 bps

Data bits: 8

Stop bits: 1

Parity: even

► The settings are adjusted via the device's display. (Please refer to the notes and instructions in the manufacturer's manual for instructions.)

Possible meter operating modes for the L&T WDM313CDNC via RS485:

- Battery meter (bi-directional)
- Total plant meter
- Sub-consumer
- Utility Meter (U)
- Utility Meter (U+I)
- Utility Meter (U+I) + Consumption Meter (bi-directional)
- Consumption meter
- Consumption meter (bi-directional)
- Generator



Note

The meter cannot be connected to the inverters with a single bus.

For this reason, use one RS485 connection for the inverters and one RS485 connection for the meter.



Note

A maximum of 32 devices can be connected per bus.



Note!

Please refer to manufacturer's manual for information on the installation, wiring and configuration of the device.

9 Mikro PowerMeter

9.1 Mikro PowerMeter DPM680

Auswählbar unter „Mikro:DPM680“

Overview

- The communication address has to be assigned.
- 3-pin wiring.
- Installation steps:
 - Switch off the meter and the Solar-Log™.
 - Connect the meter to the Solar-Log™.

Connect the meter to the Solar-Log™.

The wiring is done using a

- self-made cable connection with a terminal block connector.

Cable connection via RS485:

Solar-Log™ RS485 terminal block	Solar-Log 50	Solar-Log Base RS485 (A) / (B)	Mikro PowerMeter DPM680
Pin assignment			Pin assignment
▶ 1 (Data+)	▶ 1 oder 5	▶ (A) 6 or (B) 10 (Data+)	▶ +
▶ 3 GND	▶ 3 GND	▶ (A) 8 or (B) 12 GND	▶ GND
▶ 4 (Data-)	▶ 4 oder 6	▶ (A) 9 or (B) 13 (Data-)	▶ -



Note

The default RS485 communication parameters for the meter are:

Baud: 38400

Data bits: 8

Parity: None

Stop bits: 1

The Solar-Log™ can only communicate with the meter when it has these settings. It is important to check the settings before performing the device detection.

- ▶ Assign the communication address (according to the manufacturer's manual).
- ▶ The settings are adjusted via the device's display. (Please refer to the notes and instructions in the manufacture's manual for instructions.)

Possible meter operating modes for the Mikro PowerMeter DPM680 via RS485:

- Battery meter (bi-directional)
- Total plant meter
- Sub-consumer
- Utility Meter (U)
- Utility Meter (U+I)
- Utility Meter (U+I) + Consumption Meter (bi-directional)
- Consumption meter
- Consumption meter (bi-directional)
- Generator



Note

A maximum of 32 devices can be connected per bus.



Note

Please refer to manufacturer's manual for information on the installation, wiring and configuration of the device.

10 Schneider Electric

10.1 Schneider EM6400S (3-phase)

Selections available under Schneider Electric

Overview

- Communication address must be allocated.
- 2-pin wiring
- Installation steps
 - Switch off the meter and the Solar-Log™.
 - Connect the meter to the Solar-Log™.

Connect the meter to the Solar-Log™.

The wiring is done using a

- self-made cable connection with a terminal block connector.

Cable connection via RS485:

Solar-Log™ RS485 terminal block	Solar-Log 50	Solar-Log Base RS485 (A) / (B)	Schneider EM4600S
Pin assignment		Pin assignment	
▶ 1 (Data+)	▶ 1 or 5	▶ (A) 6 or (B) 10 (Data+)	▶ 7 (D1)
▶ 4 (Data-)	▶ 4 or 6	▶ (A) 9 or (B) 13 (Data-)	▶ 14 (D0)

Termination: 120-ohm resistor at connection pin 7 and 14 on the meter



Note

The following parameters need to be checked before the device detection to ensure that the meter is detected.

Baud rate: 9600 bps

Data bits: 8

Stop bits: 1

Parity: even

- ▶ The settings are adjusted via the device's display. (Please refer to the notes and instructions in the meter's manual for instructions.)

Possible meter operating modes for the Schneider EM6400S via RS485:

- Battery meter (bi-directional)
- Total plant meter
- Sub-consumer
- Consumption meter
- Consumption meter (bi-directional)
- Generator



Note

The meter cannot be connected to the inverters with a single bus.
For this reason, use one RS485 connection for the inverters and one RS485 connection for the meter.



Note

A maximum of 32 devices can be connected per bus.



Note:

Please refer to manufacturer's manual for information on the installation, wiring and configuration of the device.

10.2 Schneider EM6400NG (3-phase)

Selections available under „Schneider Electric/EM6400NG“.

Overview

- The communication address has to be assigned.
- 2-pin wiring.
- Installation steps:
 - Switch off the meter and the Solar-Log™.
 - Connect the meter to the Solar-Log™.

Connect the meter to the Solar-Log™

The wiring is done using a

- self-made cable connection with a terminal block connector.

Cable connection via RS485:

Solar-Log™ RS485 terminal block	Solar-Log 50	Solar-Log Base RS485 (A) / (B)	Schneider EM4600NG
Pin assignment			Pin assignment
▶ 1 (Data+)	▶ 1 or 5	▶ (A) 6 or (B) 10 (Data+)	▶ 7 (D1 +)
▶ 4 (Data-)	▶ 4 or 6	▶ (A) 9 or (B) 13 (Data-)	▶ 14 (D0 -)

Termination: 120-ohm resistor at connection pin 7 and 14 on the meter



Note

The following parameters need to be checked before the device detection to ensure that the meter is detected.

Baud rate: 19200 bps

Data bits: 8

Stop bits: 1

Parity: even

- ▶ The settings are adjusted via the device's display. (Please refer to the notes and instructions in the meter's manual for instructions.)

Possible meter operating modes for the Schneider EM6400S via RS485:

- Battery meter (Bi-directional)
- Total plant meter
- Sub-consumer
- Consumption meter
- Consumption meter (bi-directional)
- Generator



Note

The meter cannot be connected to the inverters with a single bus.
For this reason, use one RS485 connection for the inverters and one RS485 connection for the meter.



Note

Different model series from the same manufacturer cannot be used with the same bus.



Note

A maximum of 32 devices can be connected per bus.
The maximum cable length is 900 meters.



Note

Follow the instructions in the manufacturer's manual for installation, wiring and configuration of the device.

11 Secure Meters

11.1 Secure Meters (3-phase)

Selections available under „Secure“.

Supported Series/Models:

- Series Elite 440:
- Models:
 - 445, 446, 447

Overview

- The communication address has to be assigned.
- 2-pin wiring.
- Installation steps:
 - Switch off the meter and the Solar-Log™.
 - Connect the meter to the Solar-Log™.

Connect the meter to the Solar-Log™

The wiring is done using a

- self-made cable connection with a terminal block connector.

Cable connection via RS485:

Solar-Log™ RS485 terminal block	Solar-Log 50	Solar-Log Base RS485 (A) / (B)	Secure Meter (RS485)
Pin assignment			Pin assignment
▶ 1 (Data+)	▶ 1 or 5	▶ (A) 6 or (B) 10 (Data+)	▶ +
▶ 4 (Data-)	▶ 4 or 6	▶ (A) 9 or (B) 13 (Data-)	▶ -



Note

The following parameters need to be checked before the device detection to ensure that the meter is detected:

Baud rate: 9600 bps

Data bits: 8

Stop bits: 1

Parity: Non

- ▶ The settings are adjusted via the device's display. (Please refer to the notes and instructions in the meter's manual for instructions.)

Possible meter operating modes for the Secure Meter:

- Battery meter (Bi-directional)
- Total plant meter
- Sub-consumer
- Consumption meter
- Consumption meter (bi-directional)
- Generator



Note!

Follow the instructions in the manufacturer's manual for installation, wiring and configuration of the device.

03

Battery Systems

1 ABB Microgrid (Hybridsystem)

1.1 ABB Microgrid (Hybrid system)

Termination	Addressing	Interface
No	.*	LAN

Select the hybrid system „ABB“ for the device detection.

Supported models:

- MGS100

Overview

- Integrated interface.
- Connected using network cable (patch cable) and Ethernet router.
- The communication address cannot be assigned.
- Installation steps:
 - Switch off the hybrid system and the Solar-Log™.
 - Connect the hybrid system to the Solar-Log™ (RJ45).
 - Connect the Solar-Log™ to the router.

Connect the hybrid system to the Solar-Log™

The wiring is done using a

- network cable (patch cable/crossover cable) and the
- Ethernet router.



Note!*

The ABB Microgrid has the IP address 10.10.10.1 by default. This cannot be changed. Make sure that the Solar-Log™ has a IP address in the same range.

Adjusting the Solar-Log™ IP address:

The IP address of the Solar-Log™ has to be adjusted in order to communicate with the hybrid system. From the Solar-Log™ web menu, go to [Configuration | Network | Ethernet](#) to adjust the settings.

Detection via the Solar-Log™ WEB interface

- For detection on the Solar-Log™, select the device class under the menu [Configuration | Device | Definition | Interface](#) with the plus symbol and then select the device class (hybrid system) and after that ABB as the manufacturer. Confirm your selection with OK.
- Save your selections and then start the Device Detection under [Configuration | Device | Detection](#).

Detection from the Solar-Log 1200

- When using the Solar-Log 1200, the detection can also be started from the display. Select the settings ► Start ► Initial Configuration ► Page 2 „Device“ ► Add and select the device class (hybrid system) and manufacturer „ABB“ Save and start the Device Detection.



Note

Only one ABB hybrid system can be connected to a Solar-Log™ device.

2 Kyocera Inverter/Battery System

2.1 Kyocera Inverter/Battery System

Termination	Addressing	Interface
No	Yes	RS485

Selections available under Kyocera

Overview

- Integrated interface.
- Where to connect: Terminal strip under the cover on the bottom.
- The communication address has to be assigned.
- 2-pin wiring.
- Installation steps:
 - Switch off the inverters and Solar-Log™.
 - Connect inverters to the Solar-Log™.
 - Connect the inverters/battery systems to each other.
 - Assign the communication address according to the manufacturer's manual.

Connect the inverters to the Solar-Log™.

The wiring is done using a

- self-made, shielded 4-wire data cable with a terminal block connector.

Procedure

1. Unscrew the side cover as shown in the inverter's instructions.
2. If you are making the cable yourself, connect the wires as shown in the following diagram:

Solar-Log™ terminal strip connector	Solar-Log Base RS485 (A) / (B)	Inverter terminal strip
Terminal		PIN
▶ 1 (Data+)	▶ (A) 6 or (B) 10 (Data+)	▶ 3 Data+
▶ 4 (Data-)	▶ (A) 9 or (B) 13 (Data-)	▶ 4 Data-

3. Screw the inverter cover on again.
4. Insert the terminal block connector into the Solar-Log™ RS485 socket.

Connect the inverters to each other.

- Where to connect: Terminal strip under the cover on the bottom.

Procedure

1. Unscrew the side cover as shown in the inverter's instructions.
2. Connect the self-made RS-485 cable to the terminal block on inverter 1.
3. Connect other end of the self-made RS-485 cable to the terminal block on inverter 2 or to the battery system.
4. Connect the other inverters to each other in the same way.
5. Screw the inverter cover on again.

Allocate communication address:

- Procedure: According to the manufacturer's manual.

If all of the devices have been wired, they have to be powered for detection.



Note

Only one battery system can be connected to a Solar-Log™ device.

3 Phonosolar

3.1 PhonoCube 7.2 (Battery Hybrid System)

Termination	Addressing	Interface
No	Yes	RS485

Selections available under Phonosolar

Overview

- Integrated interface.
- Where to connect: Terminal strip under the cover on the backside.
- The communication address has to be assigned.
- 2-pin wiring.
- Installation steps:
 - Switch off the PhonoCube and Solar-Log™.
 - Connect the PhonoCube to the Solar-Log™.
 - Connect the PhonoCubes to each other.
 - Allocate communication address.
Address range 1 - 247.
Settings according to the manual.

Connect the PhonoCube to the Solar-Log™

The wiring is done using a

- self-made, shielded 4-wire data cable with a terminal block connector.

Procedure

1. Unscrew the cover according to the PhoneCube instructions.
2. If you are fabricating the cable yourself, connect the wires as shown in the following diagram.

Solar-Log™ terminal strip connector	Solar-Log Base RS485 (A) / (B)	PhonoCube Terminal Strip
Terminal		PIN
▶ 1 (Data+)	▶ (A) 6 or (B) 10 (Data+)	▶ 1 - Data+
▶ 4 (Data-)	▶ (A) 9 or (B) 13 (Data-)	▶ 2 - Data-

3. Screw the PhonoCube cover on again.
4. Insert the terminal block connector into the Solar-Log™ RS485 socket.

Connect the PhonoCubes to each other

- Where to connect: Terminal strip under the cover on the backside.

Procedure

1. Unscrew the cover according to the PhoneCube instructions.
2. Connect the self-made RS-485 cable to the PhonoCube terminal block 1.
3. Connect the other end of the cable to the PhonoCube terminal block 2.
4. Connect additional PhonoCubes to each other in the same way.
5. Screw the inverter cover on again.

Allocate communication address

- Recommendation: Continuous numbering from 1 to 247
- Procedure: Start according to the PhonoCube instructions.



Note

Only one battery system can be connected to a Solar-Log™ device.



Note

When detecting a PhonoCubes, two devices are always detected. The first device consists of the inverter and the battery value. The second device consists of the consumption meter that is integrated into the PhonoCube.

4 QCells (hybrid system)

4.1 Q-Home + ESS-G1 (hybrid system)

Termination	Addressing	Interface
No	.*	LAN

Select the hybrid system „QCells“ for the device detection.

Supported models:

- ESS-G1 8.0

Overview

- Integrated interface.
- Connected using network cable (patch cable) and Ethernet router.
- The communication address cannot be assigned (only via DHCP).*
- Installation steps:
 - Switch off the hybrid system and the Solar-Log™.
 - Connect the hybrid system to the Solar-Log™ (RJ45).
 - Connect the Solar-Log™ to the router.

Connect the hybrid system to the Solar-Log™

The wiring is done using a

- network cable (patch cable/crossover cable) and the
- Ethernet router.

*Dynamic IP address (DHCP) for detection and communication:

Both the Solar-Log™ and QCells devices have to be set to obtain their IP addresses automatically (DHCP) and be in the same class C subnet.



Note!

Make sure that the DHCP server is set to always assign the same IP address to the QCells device. (Refer to the router's manual)



Note!

All of the steps in the QCells quick start guide need to be successfully carried out in order to establish communication between the Solar-Log™ and QCells device.

Detection via the Solar-Log™ WEB interface

- For detection on the Solar-Log™, select the device class under the menu [Configuration | Device | Definition | Interface](#) with the plus symbol and then select the device class (hybrid system) and after that QCells as the manufacturer. Confirm your selection with OK.
- Save your selections and then start the Device Detection under [Configuration | Device | Detection](#).

Detection from the Solar-Log 1200

- When using the Solar-Log 1200, the detection can also be started from the display. Select the settings ► Start ► Initial Configuration ► Page 2 „Device“ ► Add and select the device class (hybrid system) and manufacturer „QCells.“ Save and start the Device Detection.



Note

Only one QCells hybrid system can be connected to a Solar-Log™ device.

5 RCT Power Storage AC (Battery system)

5.1 RCT Power Storage AC

Termination	Addressing	Interface
Yes	Yes	RS485

Selections available under: „RCT Power“

Supported models:

- Power Storage AC 4.0, Power Storage AC 5.0, Power Storage AC 6.0

Overview

- Integrated interface.
- Where to connect: Terminal strip X102 inside the device.
- 2-pin wiring.
- The communication address has to be assigned.
- Installation steps:
 - Switch off the device and the Solar-Log™.
 - Connect the device to the Solar-Log™.
 - Assign the communication address.
 - Terminate device.

Connect the device to the Solar-Log™

The wiring is done using a:

- self-made, shielded 2-wire data cable and terminal block connector.



Note

The RCT PowerApp has to be downloaded from the PlayStore in order to adjust the device address. Wire connections according to the app instructions.

Procedure:

1. Open the devices according to the devices instructions.
2. Connect the wires for the cable connection as shown in the following diagram:

Solar-Log™ terminal strip connector	Solar-Log Base RS485 (A) / (B)	Terminal strip X102
Terminal		Pin
▶ 1 (Data+)	▶ (A) 6 or (B) 10 (Data+)	▶ +
▶ 4 (Data-)	▶ (A) 9 or (B) 13 (Data-)	▶ -

3. Terminate the device according to the device instructions if no additional devices are to be connected.
4. Close the device if no other devices are to be connected.
5. Insert the terminal block connector into the Solar-Log™ RS485 socket.

Connect the devices to each other

- Where to connect: Terminal strip X102 inside the device.
- Connect the devices to each other according to the device instructions.

Assign the communication address

- Recommendation: Continuous numbering starting with 1 going to 250.
- Setting: via RCT PowerApp.
- Procedure: According to the RCT PowerApp instructions.



Note!

A maximum of 32 devices can be connected per RS485 bus.

Note on the inverter:

Please note that the latest software version (min. 4733) is installed on the RCT Power device and the RS485 working mode is set to „Modbus Slave“ in the APP. (default setting)

To do this, please proceed as follows:

Start „RCT Power App“ and continue:

Click on „“ ► Log in, password „Installer“ ► Device ► Settings ► Interfaces ► RS485.

Select the option „Modbus Slave“ under „RS485 working mode“ and enter the communication address of the inverter under „RS485 address“. After completing the setting, press „Flash“.

6 RCT Power Storage DC (Hybrid system)

6.1 RCT Power Storage DC

Termination	Addressing	Interface
Yes	Yes	RS485

Selections available under: „RCT Power“

Supported models:

- Power Storage DC 4.0, Power Storage DC 5.0, Power Storage DC 6.0

Overview

- Integrated interface.
- Where to connect: Terminal strip X102 inside the device.
- 2-pin wiring.
- The communication address has to be assigned.
- Installation steps:
 - Switch off the device and the Solar-Log™.
 - Connect the device to the Solar-Log™.
 - Assign the communication address.
 - Terminate device.

Connect the device to the Solar-Log™

The wiring is done using a:

- self-made, shielded 2-wire data cable and terminal block connector.



Note

The RCT PowerApp has to be downloaded from the PlayStore in order to adjust the device address. Wire connections according to the app instructions.

Procedure:

1. Open the device according to the device instructions.
2. Connect the wires for the cable connection as shown in the following diagram:

Solar-Log™ terminal strip connector Solar-Log Base RS485 (A) / (B) Terminal strip X102

Terminal		Pin
▶ 1 (Data+)	▶ (A) 6 or (B) 10 (Data+)	▶ +
▶ 4 (Data-)	▶ (A) 9 or (B) 13 (Data-)	▶ -

3. Terminate the device according to the device instructions if no additional device are to be connected.
4. Close the device if no other device are to be connected.
5. Insert the terminal block connector into the Solar-Log™ RS485 socket.

Connect the devices to each other

- Where to connect: Terminal strip X102 inside the device.
- Connect the devices to each other according to the device instructions.

Assign the communication address

- Recommendation: Continuous numbering starting with 1 going to 250.
- Setting: via RCT PowerApp.
- Procedure: According to the RCT PowerApp instructions.



Note!

A maximum of 32 devices can be connected per RS485 bus.



Note!

The visualisation of the pac in the Solar-Log™ differs from the one in the RCT Power App, if the hybrid system is charging or discharging. In the RCT Power system the charge and the discharge of the battery are included in the pac and on the Solar-Log™ this value is not influenced by the battery.

Note on the inverter:

Please note that the latest software version (min. 4733) is installed on the RCT Power device and the RS485 working mode is set to „Modbus Slave“ in the APP. (default setting)

To do this, please proceed as follows:

Start „RCT Power App“ and continue:

Click on „“ ► Log in, password „Installer“ ► Device ► Settings ► Interfaces ► RS485.

Select the option „Modbus Slave“ under „RS485 working mode“ and enter the communication address of the inverter under „RS485 address“. After completing the setting, press „Flash“.

7 SMA - Sunny Island Battery system

7.1 SMA - Sunny Island (Battery system)

Termination	Addressing	Interface
No	Yes	LAN

Selections available under Battery/SMA/Sunny Island.

Supported models:

- SI3.0M-11
- SI4.4M-11
- SI6.0H-11
- SI8.0H-11
- SI4.4M-12
- SI6.0H-12
- SI8.0H-12

Note for models with the ending -11:

The models require a „Speedwire data module Sunny Island“ => SWDMSI-NR10 to communicate via Ethernet.

Overview

- Interface integrated (see note above).
- Connect using network cable (patch cable) and Ethernet router
- Communication address must be assigned.
- Installation steps:
 - Switch off the battery system and Solar-Log™.
 - Connect the battery system to the Solar-Log™.
 - Connecting Solar-Log™ to a router..
 - Assign the inverter's communication address according to the inverter manufacturer's instructions.

Connect the battery system to the Solar-Log™.

The wiring is done using a

- network cable (patch cable/crossover cable) and the
- Ethernet router.

Assign IP address

- A static IP address must be assigned.
- Please select an IP address with the same class C subnet as the Solar-Log™.
For example: The Solar-Log™ has the IP address 192.168.178.49.
The battery system in this case has to have a free IP address in the same range (from 192.168.178.1 to 192.168.178.254).
- Procedure: According to manufacturer's instructions.

Detection via the Solar-Log™ WEB Interface

- For detection on the Solar-Log™, select the device class under the menu [Configuration | Device | Definition | Interface](#) with the plus symbol and then select „Battery“ as the Device class and then „SMA“ as the manufacturer. Confirm your selection with **OK**.
- Save your selections and then start the Device Detection under [Configuration | Device | Detection](#).

Detection from the Solar-Log 1200

- When using the Solar-Log 1200, the detection can also be started from the display. Select the settings **Start ► Initial Configuration ► Page 2 „Device“ ► Add and select Battery and then „SMA: Sunny Island“**. Save and start the Device Detection.



Note

Only one battery system can be connected to a Solar-Log™ device.



Note

Sunny Island battery systems can be connected in a group up to 3 Sunny Island (cluster) in this group, a Sunny Island is the master, while the others are the slaves. In such cases, only the master of this cluster has to be recognized by the Solar-Log? via Ethernet.



Note

Each inverter has to be individually reachable via the network.

To do this, activate the network interface at each inverter via the SMA SUNNY EXPLORER and connect the inverters into the network with a network switch.

Procedure:

- Set the „TCP Server“ to „On“ in the SMA SUNNY EXPLORER; Port=502.

8 sonnen

8.1 sonnen Eco 6.0 / 7.0

Termination	Addressing	Interface
No	.*	LAN

Select „sonnen“ during the inverter detection

Overview

- Integrated interface
- Connect using network cable (patch cable) and Ethernet router or switch.
- The communication address cannot be assigned (only via DHCP).*
- Installation steps
 - Switch off the battery system and Solar-Log™.
 - Connect the battery system to the Solar-Log™.
 - Connect the inverters to the Solar-Log™ according to the inverter instructions.
 - Assign the inverter's communication address according to the inverter instructions (if required).

Connect the battery system to the Solar-Log™.

The wiring is done using a

- network cable (patch cable/crossover cable) and the
- Ethernet router or switch.

Connect the inverters to each other.

The inverters are connected together according to the inverter instructions.

*Dynamic IP address (DHCP) for detection and communication:

Both the Solar-Log™ and sonnen Eco 6.0 / 7.0 devices have to be set to obtain their IP addresses automatically (DHCP) and be in the same class C subnet. (The settings for DHCP according to the sonnen Eco 6.0 / 7.0 manufacturer's instructions.)

Detection via the Solar-Log™ WEB interface

- For the device detection on the Solar-Log™ select „Sonnenbatterie“ in the Network section from the Configuration | Devices | Definition menu and then click on Save..

Detection from the Solar-Log 1200

When using the Solar-Log 1200, the detection can also be started from the display.

- Select „Sonnenbatterie“ from the „Network“ interface for the detection and then start the detection.

**Note**

In addition to the battery, a consumption meter and production meter are detected (after detection, the consumption meter is active and the production meter is deactivated).

This makes it possible to monitor a plant without an inverter connection by activating the production meter in inverter mode.

**Note**

Only one battery system can be connected to a Solar-Log™ device.

8.2 sonnen Eco 8.0

Termination	Addressing	Interface
No	-*	LAN

Select „sonnen“ during the inverter detection

Overview

- Integrated interface.
- Connect using network cable (patch cable) and Ethernet router or switch.
- The communication address cannot be assigned (only via DHCP).*
- Installation steps:
 - Switch off the battery system and Solar-Log™.
 - Connect the battery system to the Solar-Log™.
 - Connect the inverters to the Solar-Log™ according to the inverter instructions.
 - Assign the inverter's communication address according to the inverter instructions (if required).

Connect the battery system to the Solar-Log™.

The wiring is done using a

- network cable (patch cable/crossover cable) and the
- Ethernet router or switch.

Connect the inverters to each other.

The inverters are connected together according to the inverter instructions.

*Dynamic IP address (DHCP) for detection and communication:

The sonnen Eco 8.0 is always set to DHCP by default and that is why it is not possible to assign a static IP address to the sonnen Eco 8.0. Both devices need to be in the same subnet mask.

Detection via the Solar-Log™ WEB interface

- For the device detection on the Solar-Log™ select „sonnen“ in the Network section from the Configuration | Devices | Definition menu and then click on Save..

Detection from the Solar-Log 1200

When using the Solar-Log 1200, the detection can also be started from the display.

- Select „sonnen“ from the „Network“ interface for the detection and then start the detection.



Note

In addition to the battery, a consumption meter and production meter are detected (after detection, the consumption meter is active and the production meter is deactivated).

This makes it possible to monitor a plant without an inverter connection by activating the production meter in inverter mode.



Note

Only one battery system can be connected to a Solar-Log™ device.

9 VARTA Battery System

9.1 VARTA House

Termination	Addressing	Interface
No	Yes*	LAN

Select „VARTA“ during the device detection (up to 4.2.0).

Select „VARTA:House“ during the device detection (Firmware 4.2.1 and higher).

Compatible Battery systems

- VARTA home
- VARTA family
- VARTA element
- VARTA pulse

Overview

- Integrated interface.
- Connected using network cable (patch cable) and Ethernet router or switch (when assigning a static IP address).
- *The Varta battery system is set to DHCP by default. However, it can also be assigned a static IP address. (Refer to the manufacturer's manual).
- Installation steps:
 - Assign a dynamic or a static IP address.
 - Switch off the battery system and Solar-Log™.
 - Connect the battery system to the Solar-Log™.
 - Connect the inverters to the Solar-Log™ according to the inverter instructions.
 - Connect the consumption meter to the Solar-Log™ according to the instructions.
 - Assign the inverter's communication address according to the inverter instructions (if required).



Note:

The following components have to be used for battery monitoring to work:

- Battery system with net energy meter (at least Varta firmware 3.0.2).
- Inverters.
- Consumption meter.

- ▶ The consumption meter is to be installed so that it not records the battery charge. In addition, the "Consumption meter includes battery charge" settings has to be deactivated in the [Configuration | Devices | Configuration | Battery menu](#) via the WEB interface.
-

Connect the battery system to the Solar-Log™.

The wiring is done using a

- network cable (patch cable/crossover cable) and the
- Ethernet router or switch (when assigning a static IP address).

Connect the inverters to each other

The inverters are connected together according to the inverter instructions.

Connect the consumption meter to the Solar-Log™.

The wiring is done using a

- RS485 or
- S0 interface.

Procedure for IP addresses assignment:

In addition to a static, fixed IP, a dynamic IP address can also be assigned.

Dynamic IP address:

Both devices, the Solar-Log™, and the VARTA battery system must be provided automatically to IP address (DHCP).

Static IP address:

- Please select an IP address with the same class C subnet as the Solar-Log™.
For example: The Solar-Log™ has the IP address 192.168.178.49.
The battery system in this case has to have a free IP address in the same range (from 192.168.178.1 to 192.168.178.254).
- Procedure: Start according to the battery system's instructions.

Detection via the Solar-Log™ WEB interface

- For the device detection on the Solar-Log™ select „VARTA:House“ in the **Network** section from the **Configuration | Devices | Definition** menu.
- Also select the proper interfaces for the meters as well as the inverters. Confirm the selection by clicking on **Save**.

Detection from the Solar-Log 1200

When using the Solar-Log 1200, the detection can also be started from the display.

- Select „VARTA:House“ from the „Network“ interface for the detection.
- Also select the proper interfaces for the meters as well as the inverters and then start the detection.



Note

Only one battery system can be connected to a Solar-Log™ device.



Note on VARTA pulse

If a Varta consumption meter is connected to the battery system, an additional consumption meter (bi-direction meter) is detected and recorded by the Solar-Log™ when it is detected. (The consumption meter is active after the detection.)

Additional information about Varta

Battery charging time shift function:

When the plant has to fulfill a percentage-based reduction (x% - EEG/subvention), the Solar-Log™ can shift the charging time of the battery to a period of peak power production, thus eliminating the need to reduce the total output. The Solar-Log™ includes the weather forecast data and plant consumption data into the calculation for battery charging management. This means that Solar-Log™ saves the typical consumption data from the past and checks this data to ensure that the battery is charged completely. The charging times are adjusted accordingly as needed.



Note

A connection to the WEB-Enerest™ portal (only HTTP) and a correct configuration of the plant location and orientation/pitch of the solar modules are necessary for accurate weather data.



Note

Not available for Solar-Log 50 and 250.

9.2 VARTA Industrial

Termination	Addressing	Interface
No	Yes*	LAN

Select „VARTA:Industrial“ during the device detection.

Compatible Battery systems.

- VARTA flex storage E
- VARTA flex storage P

Overview

- Integrated interface
- Connected using network cable (patch cable) and Ethernet router or switch (when assigning a static IP address).
- *The VARTA battery system is set to DHCP by default. However, it can also be assigned a static IP address. (Refer to the manufacturer’s manual)
- Installation steps:
 - Assign a dynamic or a static IP address.
 - Switch off the battery system and Solar-Log™.
 - Connect the battery system to the Solar-Log™.
 - Connect the inverters to the Solar-Log™ according to the inverter instructions.
 - Connect the consumption meter to the Solar-Log™ according to the instructions.
 - Assign the inverter’s communication address according to the inverter instructions (if required).



Note:

The following components have to be used for battery monitoring to work:

- Battery system with net energy meter (at least Varta firmware 3.0.2).
- Inverters.
- Consumption meter.

- ▶ The consumption meter is to be installed so that it not records the battery charge. In addition, the "Consumption meter includes battery charge" settings has to be deactivated in the [Configuration | Devices | Configuration | Battery](#) menu via the WEB interface.

Connect the battery system to the Solar-Log™.

The wiring is done using a

- network cable (patch cable/crossover cable) and the
- Ethernet router or switch (when assigning a static IP address).

Connect the inverters to each other

The inverters are connected together according to the inverter instructions.

Connect the consumption meter to the Solar-Log™.

The wiring is done using a

- RS485 or
- S0 interface.

Procedure for IP addresses assignment:

In addition to a static, fixed IP, a dynamic IP address can also be assigned.

Dynamic IP address:

Both devices, the Solar-Log™, and the VARTA battery system must be provided automatically to IP address (DHCP).

Static IP address:

- Please select an IP address with the same class C subnet as the Solar-Log™.
For example: The Solar-Log™ has the IP address 192.168.178.49.
The battery system in this case has to have a free IP address in the same range (from 192.168.178.1 to 192.168.178.254).
- Procedure: Start according to the battery system's instructions.

Detection via the Solar-Log™ WEB interface

- For the device detection on the Solar-Log™ select „VARTA:Industrial“ in the **Network** section from the **Configuration | Devices | Definition** menu.
- Also select the proper interfaces for the meters as well as the inverters. Confirm the selection by clicking on **Save**.

Detection from the Solar-Log 1200

When using the Solar-Log 1200, the detection can also be started from the display.

- Select „VARTA:Industrial“ from the „Network“ interface for the detection.
- Also select the proper interfaces for the meters as well as the inverters and then start the detection.



Note

Only one battery system can be connected to a Solar-Log™ device.



Note

If a Varta consumption meter is connected to the battery system, an additional consumption meter (bi-direction meter) is detected and recorded by the Solar-Log™ when it is detected. (The consumption meter is active after the detection.)



Note

The Varta Industrial battery system cannot be used with the Solar-Log 50.

Additional information about Varta

Battery charging time shift function:

When the plant has to fulfill a percentage-based reduction (x% - EEG/subvention), the Solar-Log™ can shift the charging time of the battery to a period of peak power production, thus eliminating the need to reduce the total output. The Solar-Log™ includes the weather forecast data and plant consumption data into the calculation for battery charging management. This means that Solar-Log™ saves the typical consumption data from the past and checks this data to ensure that the battery is charged completely. The charging times are adjusted accordingly as needed.



Note

A connection to the WEB-Enerest™ portal (only HTTP) and a correct configuration of the plant location and orientation/pitch of the solar modules are necessary for accurate weather data.



Note

Not available for Solar-Log 50 and 250.

04

Heating rods

1 EGO Smart Heater

1.1 EGO Smart Heater (RS485)

Termination	Addressing	Interface
Yes	No	RS485

Overview

- Integrated interface.
- Where to connect: Terminal strip inside the heating rod.
- 3-pin wiring.
- The communication address does not have to be assigned.
- Installation steps:
 - Switch off the heating rod and Solar-Log™.
 - Connect the heating rod to the Solar-Log™.

Connect the EGO Smart Heater to the Solar-Log™:

The wiring is done using a

- self-made, shielded 3-wire data cable and terminal block connector.

General information on managing and prioritizing the EGO Smart Heater via smart energy

The Solar-Log™ can manage and prioritize up to six EGO Smart Heaters with the smart energy function.

The connection of the Smart Heaters can be made in different ways.

Two examples should clearly illustrate the options:

Example 1

Six heating rods are connected via the Ethernet option; it is not possible to connect any additional heating rods via the RS485 interface.

Example 2

One heating rod is connected per interface via the RS485 A and RS485/422 B interface. This allows four heating rods to be connected via Ethernet.



Note

Only one EGO Smart Heating can be operated per RS485 interface.

Procedure

1. Open the heating rod according to its instructions
2. Connect wires as shown in the diagram below:

Solar-Log™ terminal strip connector	Solar-Log Base RS485 (A) / (B)	EGO Smart Heater terminal strip
Terminal		Terminal
▶ 1 (Data+)	▶ (A) 6 or (B) 10 (Data+)	▶ A RS485+
▶ 3 GND	▶ (A) 8 or (B) 12 GND	▶ C GND (Shielding)*
▶ 4 (Data-)	▶ (A) 9 or (B) 13 (Data-)	▶ B RS485-

3. Terminate the heating rod according to its instructions.
4. Close the heating rod cover.
5. Insert the terminal block connector into the Solar-Log™ RS485 socket.



Note

To ensure that the EGO heating rod control works properly, the EGO heating rod's manual temperature regulator should be set to the maximum temperature. Define the temperature that the Solar-Log™ should control via the WEB interface of the Solar-Log™ in the [Configuration | Devices | Configuration](#) menu.



*)Note

Shielding unilaterally contacted. Either on the EGO Smart Heater or on the control (remote station).

1.2 EGO Smart Heater via Ethernet

Termination	Addressing	Interface
No	.*	LAN

Overview

- Integrated interface.
- Connected using network cable (patch cable) and Ethernet router or switch.
- The communication address cannot be assigned (only via DHCP)*.
- Installation steps:
 - Switch off the heating rod and Solar-Log™.
 - Connect the heating rod to the Solar-Log™.

Connect the EGO Smart Heater to the Solar-Log™

The wiring is done using a

- network cable (patch cable) and the
- Ethernet router or switch.

*Dynamic IP address (DHCP) for detection and communication:

Both the Solar-Log™ and the EGO Smart Heater devices have to be set to obtain their IP addresses automatically (DHCP) and be in the same class C subnet.

Detection via the Solar-Log™ WEB Interface

- For detection on the Solar-Log™, select the device class under the menu [Configuration | Device | Definition | Interface](#) with the plus symbol and then select Benning as the manufacturer. Confirm your selection with OK.
- Save your selections and then start the Device Detection under [Configuration | Device | Detection](#).

Detection from the Solar-Log 1200

- When using the Solar-Log 1200, the detection can also be started from the display. Select the settings [Start ► Initial Configuration ► Page 2 „Device“ ► Add](#) and select the manufacturer EGO: Smart Heater from there. Save and start the Device Detection.



Note

With the Ethernet version of EGO can be up to 6 EGO Smart Heater, controlled and prioritized via the Smart Energy Function of the Solar-Log™.



Note

To ensure that the EGO heating rod control works properly, the EGO heating rod's manual temperature regulator should be set to the maximum temperature. Define the temperature that the Solar-Log™ should control via the WEB interface of the Solar-Log™ in the [Configuration | Devices | Configuration](#) menu.

2 Heating rod MyPv AC ELWA-E

2.1 Heating rod MyPv AC ELWA-E via Ethernet

Termination	Adressing	Interface
No	Yes	LAN

Select „MyPv“ during the inverter detection.

Overview

- Integrated interface.
- Connect using network cable (patch cable) and Ethernet router or switch.
- A static IP address must be assigned.
- Installation steps:
 - Switch off the heating rod and the Solar-Log™.
 - Connect the heating rod to the Solar-Log™.

Connect the heating rod to the Solar-Log™

The wiring is done using a

- Network cable (patch cable/crossover cable) and the
- Ethernet router or switch.

Assign the IP address for detection and communication:

The MyPV heating rod is set to DHCP by default. A static IP address must be defined in its web menu. Both devices need to be in the same subnet mask Detection via the Solar-Log™ WEB interface.

Detection via the Solar-Log™ WEB interface

- For detection on the Solar-Log™, select the device class under the menu
- [Configuration | Device | Definition | Interface](#) with the plus symbol and then select MyPv as the manufacturer. Confirm your selection with **OK**
- Save your selections and then start the Device Detection under [Configuration | Device | Detection](#) and start the device detection

Detection from the Solar-Log 1200

- When using the Solar-Log 1200, the detection can also be started from the display. Select the settings ► Start ► Initial Configuration ► Page 2 „Device“ ► Add and select the manufacturer „MyPv“ from there. Save and start the Device Detection.



Note

For the communication with the Solar-Log™ to work, the control type in the heating rod web menu has to be set to Modbus TCP and the power timeout to 60.



Note

Up to 6 heating rods can be controlled and prioritized with the Smart Energy function of the Solar-Log™.



Note

To ensure that the MyPv heating rod control works properly, the heating rod's manual temperature regulator should be set to the maximum temperature. Define the temperature that the Solar-Log™ should control via the WEB interface of the Solar-Log™ in the [Configuration | Devices | Configuration](#) menu.

05

Heating pumps

1 CTA Heat Pumps

1.1 CTA Optiheat Products

Termination	Addressing	Interface
DIP switch	-	RS485



Note

It is controlled using the Solar-Log™ internal relay.

Important:

The change-over contact for the controller is 230 V AC. Since the Solar-Log™ relay only allows 24 V, an auxiliary relay is required.



Note

It is connected to the heat pump using a Siemens OCI adapter.



Note

An external meter is required to record the power consumption of the heat pump. We recommend installing a compatible meter (e.g. Solar-Log PRO380) in front of the heat pump in „subconsumer“ mode.

Supported Models:

- OH-1es-5, 6, 8, 11, 14 and 18

Required controllers and accessories:

- RVS61F.843/169
- OCI modul

Connection suggestion for control:

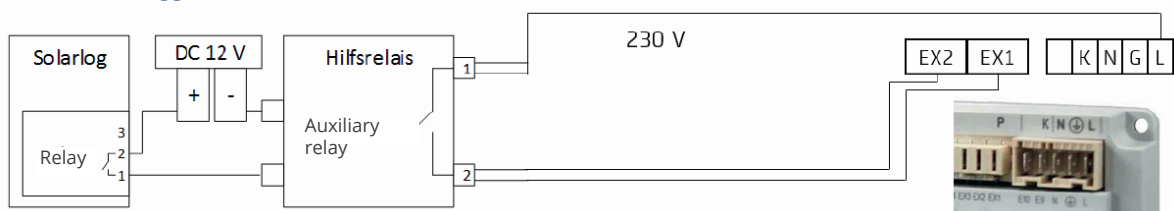

Fig.: Connection of the control to the auxiliary relay.

Overview (Siemens OCI Adapter)

- Where to connect: Connection terminals in the OOCI adapter.
- 3-pin wiring.
- Communication address is set to „1“ by default on the controller side..
- Installation steps:
 - Switch off the OCI adapter and the Solar-Log™.
 - Connect the OCI adapter to the Solar-Log™.

Connect the Siemens OCI adapter to the Solar-Log™

The cabling meets the requirements of RS485 wiring:

- + and - via a twisted pair of wires preferably shielded, GND any cable.

Procedure

1. Open the OCI adapter according the manufacturer's instructions.
2. Connect the wires for the cable connection as shown in the following diagram:

Solar-Log™ terminal strip connector Solar-Log Base RS485 (A) / (B) Siemens OCI adapter terminal connection block

Pin		Pin
▶ 1 (Data+)	▶ (A) 6 or (B) 10 (Data+)	▶ +
▶ 3 GND	▶ (A) 8 or (B) 12 GND	▶ G
▶ 4 (Data-)	▶ (A) 9 or (B) 13 (Data-)	▶ -

3. Terminate the OCI adapter with the DIP switches (both both DIP switches set to „ON“).
4. Close the OCI adapter according the manufacturer's instructions.
5. Insert the terminal block connector into the Solar-Log™ RS485 socket.



Note

The CTA service partner installs the signal lines to the Siemens controller in the heat pump. The installer takes care of the signal line connection to the auxiliary relay or Solar-Log™.



Note

A license code is required to activate the CTA heat pump. This code has to be purchased from Solare Datensysteme GmbH. Go to the following WEB site:

<https://www.solar-log.com/en/solutions-service/licenses/>

Detection via the Solar-Log™ WEB Interface

- To control the heat pump, a detection must be carried out at Solar-Log™, select the device class „Switch“ under the menu **Configuration | Device | Definition | Interface** with the plus symbol and then select „Solar-Log™“ as the manufacturer. Confirm the selection by clicking on „OK“.
- For data acquisition of the heat pump, repeat the step by clicking on the plus symbol, select device class „Heat pump“ and then select „CTA“ as the manufacturer and the interface on the heat pump (OCI adapter). Click on „OK.“.
- Save your selections and then start the Device Detection under **Configuration | Device | Detection** and start the device detection.

2 Hoval Heat Pumps

2.1 HOVAL TopTronic-E

Supported models:

- Thermalia comfort, comfort H, twin, twin H, dual, dual H
- Belaria compact IR, twin I, twin IR, twin A, twin AR

Required Controller and Accessories:

- TopTronic E
- Modbus Gateway Module



Note

The heat pump is controlled by the Solarlog's internal relay. Refer to the Hoval Heat Pump (TopTronic E) Installation below.

- ▶ An auxiliary relay is not required.
-

Hoval Heat Pump (TopTronic E) Installation:

- Connect the Hoval Modbus Gateway to the heat pump controller via the CAN bus.
- Connect the Hoval Modbus Gateway to the router via Ethernet.
- Connect the heat pump controller (Hoval TTE Controller) to the „Variable Input 2 (VI2)“ of the Solar-Log™ (Wiring via the Solar-Log™'s relay. Refer to the table below.).
- Connect the Solar-Log™ to the router via Ethernet.

Solar-Log™ Relay	Heat Pump Controller (TTE Controller)
Pin	Pin (VE2/IMP)
▶ 1	▶ 1
▶ 2	▶ 2



Important!

It is important to note the serial number/identification and the password of the Hoval Modbus Gateway (included with the Gateway) so that the heat pumps can be registered in the Hoval Desk Account.

3 IDM Heat Pumps

3.1 IDM Heat Pumps

Termination	Addressing	Interface
No	Yes	LAN

Overview

- Integrated interface.
- The IDM heat pump's IP address must be adapted.
- Connected using network cable (patch cable) and Ethernet router or switch (when assigning a static IP address).
 - Another option is to connect directly to the main board of the navigator with a crossover cable.
- Installation steps
 - Assign a static IP address to the IDM heat pump or set the IDM heat pump to DHCP.
 - Connect the IDM heat pump to a switch (with a static IP address) or Ethernet router.
 - Connect the Solar-Log™ to a switch (with a static IP address) or Ethernet router.

Assigning IP addresses

- Configure the address according to the manufacturer's manual.
- The DHCP range (IP address) for the heat pump has to be in the same subnet as the Solar-Log™.
- Procedure: According to the manufacturer's manual.

Detection from the Solar-Log™

- For the detection on the Solar-Log™, select „IDM“ as the manufacturer in the [Configuration | Devices | Definition](#) menu from the [Network](#) section. Confirm the selection with [Save](#).

Detection from the Solar-Log 1200

- When using the Solar-Log 1200, the detection can also be started from the display. Select „IDM“ as the manufacturer for the inverter detection from the „[network](#)“ interface and start the detection.



Note

The IDM heat pump has to have Navigator 1.7.

4 Stiebel-Eltron

4.1 Stiebel Eltron Heat pumps (ISG)

Termination	Addressing	Interface
No	Yes	LAN

Overview

- Integrated interface.
- The Stiebel-Eltron heat pump's IP address must be adapted.
- Connected using network cable (patch cable) and Ethernet router or switch (when assigning a static IP address).
- Installation steps:
 - Assign heat pump a static IP address or via DHCP (enabled by default).
 - Connect the heat pump to a switch (with a static IP address) or Ethernet router.
 - Connect the Solar-Log™ to a switch (with a static IP address) or Ethernet router.

Assigning IP addresses

- Configure the address according to the manufacturer's manual.
- The DHCP range (IP address) for the heat pump has to be in the same subnet as the Solar-Log™.
- Procedure: According to the manufacturer's manual.

Detection via the Solar-Log™ WEB Interface

- For detection on the Solar-Log™, select the device class under the menu **Configuration | Device | Definition | Interface** with the plus symbol and then select Stiebel-Eltron as the manufacturer. Confirm your selection with OK.
- Save your selections and then start the Device Detection under **Configuration | Device | Detection**.
- After the detection, Stiebel-Eltron appears as a switching device in the **Configuration | Smart Energy | Switching Groups** menu.
- Assign the switch contact of the Stiebel heat pump to a switching group (the switch contact only needs to be defined in the software, no hardware is required) and configure the specific control for the heat pump. For more information on Smart Energy such as configuration, functionality and application examples, refer to Chapter 5.2: „Controlling Heat Pumps with a Grid Company Blocking Signal“ (https://www.solar-log.com/manuals/manuals/en_GB/SolarLog_Manual_Smart_Energy_EN_01.pdf).
- The heat pump appears in the **Diagnostics | Smart Energy | Status (current)** and history menu (also with several temperature values that are retrieved and recorded from the heat pump).

Detection from the Solar-Log 1200

- When using the Solar-Log 1200, the detection can also be started from the display. Select the settings ► **Start ► Initial Configuration ► Page 2 „Device“ ► Add** and select the manufacturer Stiebel-Eltron from there. Save and start the Device Detection.

You have to access the Solar-Log™ WEB interface to complete the configuration.

Subsequent procedure:

- After the detection, Stiebel-Eltron appears as a switching device in the **Configuration | Smart Energy | Switching Groups** menu.
- Assign the switch contact of the Stiebel heat pump to a switching group (the switch contact only needs to be defined in the software, no hardware is required) and configure the specific control for the heat pump. For more information on Smart Energy such as configuration, functionality and application examples, refer to Chapter 5.2: „Controlling Heat Pumps with a Grid Company Blocking Signal“ (https://www.solar-log.com/manuals/manuals/en_GB/SolarLog_Manual_Smart_Energy_EN_01.pdf).
- The heat pump appears in the **Diagnostics | Smart Energy | Status (current)** and **history** menu (also with several temperature values that are retrieved and recorded from the heat pump).



Note

If the threshold configured for the surplus in the Solar-Log™ is exceeded, the heat pump receives a protocol-level release signal. This signal is checked by the heat pump control and released there.



Note

Without the assignment of a switching group, although data from the heat pump is recorded, it is not visualized in the web interface.



Note

DHCP is enabled by default. DHCP has to be disabled in order to manually assign an IP address (refer to the Stiebel-Eltron manual).



Note

In order to receive data from the Stiebel-Eltron heat pump, the "Stiebel ISG" (Internet Service Gateway) has to be installed in addition and a license is required for the existing Modbus interface in the ISG.

- ▶ Contact Stiebel-Eltron directly regarding the license.



Note

Only one Stiebel-Eltron heat pump can be connected and visualized per Solar-Log™.

Additional information

It is recommended to record the consumption of the heat pump with a suitable meter (eg: Solar-Log™ PRO380), as the heat pump itself does not transmit any consumption values.

This meter, defined as an Sub-consumption meter, can also be assigned to the responsible switching group in order to optimize the surplus determination. The heat pump is thus also visualized in the consumption graphic.

06

Sensors

1 Sensor Basic

Properties

- Sensor element: Crystalline solar cell, 20 mm x 34 mm
- Measurement range irradiance: 0 - 1400 W/m²
- Error of max. +/- 2 K at 25 °C cell temperature
- Sensorelement: KTY83-110
- Measurement range cell temperature: -25 - +75 °C
- Error of max. 8 % (FSR) at vertical light beam and under standard test condition (STC)
- Differential data communication
- Cable prolongable up to 50 m (165 feet)

Sensor Case

Material	Powder-coated aluminum
Mounting Plate	3 mm powder-coated Aluminum with 4 x M8-drill holes
Drill Size (WxHxD)	138 mm x 38 mm x 64 mm (with mounting plate)
Weight	ca. 440 g
Protection Class	IP67
Ambient Temperature	-20 - +70 °C
Temperature Range	-25 - +85 °C
Relative Air Humidity	20 - 95 %

Electronics

Power Supply	8 - 28 Vdc, via RS485 Data Cable from Solar-Log™
Supply Current	Typical 10 mA
Communication Port	RS485
Protocol	Solar-Log™, 9600 Baud, 8N1
Connection Cable	<ul style="list-style-type: none"> • 4 pole, 3 m (10 feet), weather and uv resistant (LiY(St) 11 Y (4 x 0,14) • prolongable up to 50 m (165 feet)

Instruction for Mounting

Install the irradiance sensor with the same orientation and declination as the PV generator, most suitable in the plane with the pv generator. Choose an unshaded location for the irradiance sensor. To prevent snow on the sensor choose a location sidewise or above, but not below the PV generator. Usually an overlapped mounting trace of the PV generator can be used for mechanical installation of the irradiance sensor. Otherwise use another suitable assembling aid for mechanical installation of the sensor.

Recommended Mounting

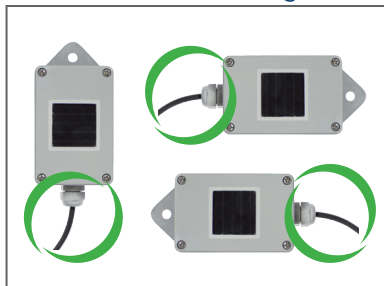

Not allowed

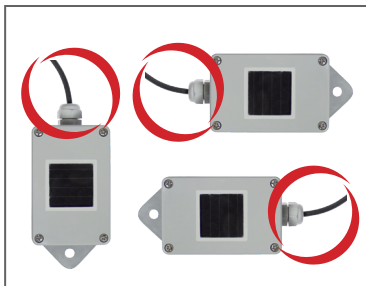

Attention!

Opening the sensor is not necessary for installing the sensor. Opening the sensor will void your warranty!

Cabling for the data line to the Solar-Log™



Attention!

Interchanging the connection cables may result in damage to sensor.

- The connection cable is 4-wire and includes the 12 V power supply and the data line to the Solar-Log™
- No separate power supply is required
- The connection cable can be extended (up to 50 m), however, at least a voltage of 8 V should be measured at the end of the cable
- The cable must also be suitably protected in outside areas. The cabling in inside areas can consist of a shielded data cable
- The Sensor Basic is connected to a RS485 interface parallel to the inverter bus (min. Firmware 2.5) or to an unused RS485 interface on the Solar-Log™
- The cable shielding must have an equipotential bond
- The four wires in the connection cable must be joined to the 4-pin connector of the Solar-Log™. The wire assignments are printed on the back of the sensor and are made as follows:

Terminal block connector Solar-Log™	Solar-Log Base RS485 (A) / (B)	Sensor Basic Cable
▶ 1 (Data+)	▶ (A) 6 or (B) 10 (Data+)	▶ Brown Data+
▶ 2 (+12V)	▶ (A) 7 or (B) 11 (24 V)	▶ Red +12Vdc (Vcc)
▶ 3 GND	▶ (A) 8 or (B) 12 GND	▶ Black 0 V (GND)
▶ 4 (Data-)	▶ (A) 9 or (B) 13 (Data-)	▶ Orange Data-

Startup

1. When the Solar-Log™ is switched on, the Sensor Basic is also powered up automatically
2. The Sensor Basic must then be configured on the desired RS485 interface:
3. Use the web interface to access the Solar-Log™ configuration menu.
4. Select "M&T Sensor" for the inverter selection in the [Configuration | Devices | Definition | Interfaces](#) menu in the sector [Device class | Manufacturer](#).
5. Carry out the inverter detection. The Sensor Basic is integrated with the system in the same way as an inverter.

2 Sensor Box Professional

2.1 Technical Information

The Sensor Box Professional is equipped with a high-quality monocrystalline solarcell. This very reliable and rugged sensor are designed for longlasting outdoor use (IP65).

The Solar-Log™ continuously compares the production of the PV-Plant with the measurements of the sensor. If the Solar-Log™ detects a definable difference an error message will be generated.



Attention!

Opening the sensor is not necessary and would lead to a loss of guarantee.

2.2 Mechanical Installation Sensor Box Professional

The Sensor Box Professional must be mounted parallel; this means the same adjustment and pitch as the solar-modules, fastened with screws on the substructure. The sensor should be mounted at a place where there are no shadows. A complex mounting of a cell-temperature-sensor is not necessary, it is included within the irradiance sensor.

Recommended Mounting

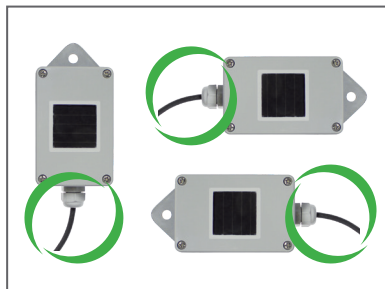

Not allowed

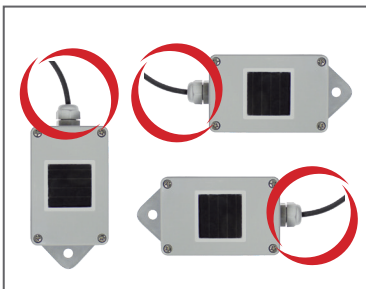

When mounting the sensor, please take care that the cable is mounted as seen in this figure.

2.3 Wiring the Data Cable with the Solar-Log™

The Sensor Box Professional is connected via the RS485 gateway with the Solar-Log™. The 4-core connection cable between the irradiance sensor and the Solar-Log™ is used for data exchange and 12 V power supply. A separate mains adapter is not necessary.

The connection cable can be extended (max 50 m). Please be sure that the supply voltage 10,5 VDC reaches the end of the connection cable. For longer distance please use a cable with bigger wire cross section.

For outdoor use, the connection must be protected in conformity with IP54. For indoor wiring, please use a shielded data cable. The shield of the cable must be connected with a potential equalisation. The 4 wires of the connection cable have to be connected with the Solar-Log™ connection plug.



Warning!

Interchanging the connection cables may result in damage to sensor.

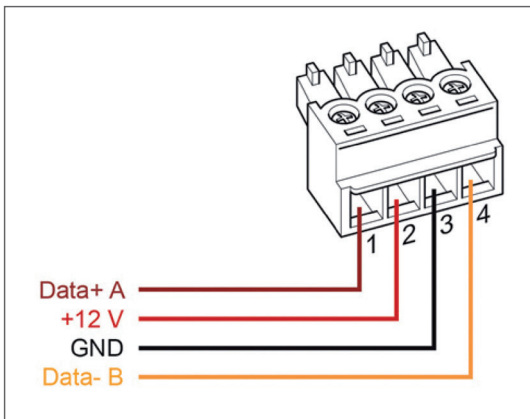

Connection plug Solar-Log™	Solar-Log Base RS485 (A) / (B)	Sensor Box Professional
▶ 1 (Data+)	▶ (A) 6 or (B) 10 (Data+)	▶ Data+ A (brown)
▶ 2 (+12V)	▶ (A) 7 or (B) 11 (24 V)	▶ +12V (red)
▶ 3 GND	▶ (A) 8 or (B) 12 GND	▶ GND (black)
▶ 4 (Data-)	▶ (A) 9 or (B) 13 (Data-)	▶ Data- B (orange)

2.4 Starting Up at the Solar-Log™

By switching-on the Solar-Log™, it will provide power to the Sensor Box Professional. Afterwards, the Sensor Box Professional must be configured to the free RS485-port:

- Open the dialogue Configuration | Devices | Definition | Interfaces in the WEB menu of the Solar-Log™. Please refer to the Installation Manual in chapter “Connecting accessories”, “Installation” and “Configuring connected devices”.
- Select under Devices class „Sensor“ and under Manufacturer „M&T Sensor“.
- Carry out device detection.

The Sensor Box Professional is integrated with the system in the same way as an inverter. The further configuration could be handled with the Solar-Log™ web interface.

2.5 Technical Data

Sensor Box Professional

Dimensions, weight	W/H/D in mm: 145/85/40, 360 g
Housing	Powder-coated aluminum
Protection mode	IP65
Operating temperature	-20 °C to +70 °C
Power supply	Via RS485 data cable from Solar-Log™ (10,5-28 V _{DC})
Supply Current	Typical 10 mA
Communication Port	RS485
Protocol	Solar-Log™, 9600 Baud, 8N1
Irradiance	Irradiance : ± 5 % (0 W/m ² to 1400 W/m ²) Cell-temperature: ± 1K (-20 °C to +70 °C) / ± 2 K (-40 °C to +85 °C)
Installation	with screws on the substructure
Connection cable	<ul style="list-style-type: none"> ● 4 pole, 3 m (10 feet), weather and uv resistant (LiY(St) 11 Y (4 x 0,14) ● prolongable up to 50 m (165 feet)
Conformity	CE :DIN EN-61000-6-1:2007 and DIN EN-61000-6-3:2007

3 Sensor Box Professional Plus

3.1 Technical Information

The Sensor Box Professional Plus is equipped with a high-quality monocrystalline solarcell. This very reliable and rugged sensor as well as the component parts are designed for longlasting outdoor use (IP65).

The Solar-Log™ continuously compares the production of the PV-Plant with the measurements of the sensor. If the Solar-Log™ detects a definable difference an error message will be generated.



Attention!

Opening the sensor is not necessary and would lead to a loss of guarantee.

3.2 Mechanical Installation Optional Sensors

The Sensor Box Professional Plus must be mounted parallel; this means the same adjustment and pitch as the solar-modules, fastened with screws on the substructure. The sensor should be mounted at a place where there are no shadows. A complex mounting of a cell-temperature-sensor is not necessary, it is included within the irradiance sensor.

Recommended Mounting

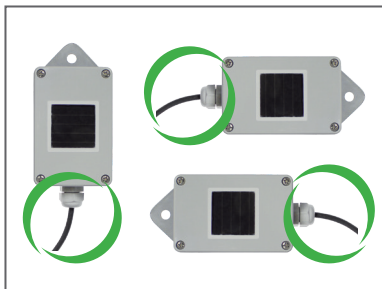

Not allowed

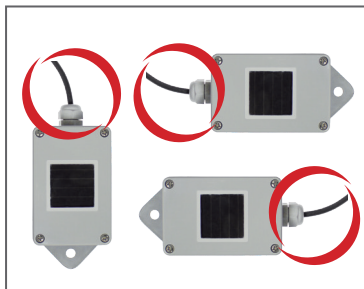

When mounting the sensor, please take care that the cable is mounted as seen in this figure.

3.3 Mechanical Installation Optional Sensors

The temperature sensor should be mounted with a wall bracket at a shadowy location. The 3-pin connector must be screwed into the irradiance sensor.

The wind wheel should be mounted with the mounting angle at the highest and most exposed location. The 2-pin connector must be screwed into the irradiance sensor.



Attention!

The cables of the optional sensors can not be extended. The sensor must be mounted horizontally.

3.4 Wiring the Data Cable with the Solar-Log™

The Sensor Box Professional Plus is connected via the RS485 gateway with the Solar-Log™. The 4-core connection cable between the irradiance sensor and the Solar-Log™ is used for data exchange and 12 V power supply. A separate mains adapter is not necessary.

The connection cable can be extended (max 50 m). Please be sure that the supply voltage 10,5 VDC reaches the end of the connection cable. For longer distance please use a cable with bigger wire cross section.

For outdoor use, the connection must be protected in conformity with IP54. For indoor wiring, please use a shielded data cable. The shield of the cable must be connected with a potential equalisation. The 4 wires of the connection cable have to be connected with the Solar-Log™ connection plug.



Warning!

Interchanging the connection cables may result in damage to sensor.

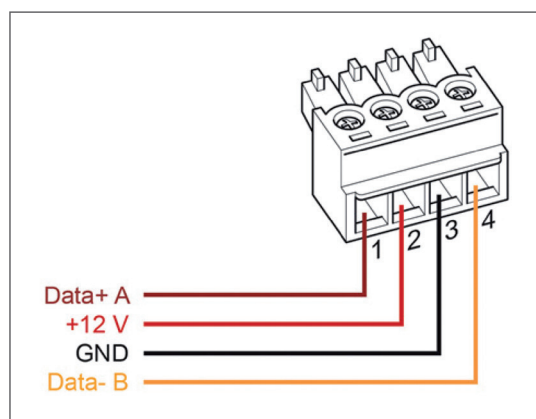

Connection plug Solar-Log™	Solar-Log Base RS485 (A) / (B)	Sensor Box Professional Plus
▶ 1 (Data+)	▶ (A) 6 or (B) 10 (Data+)	▶ Data+ A (brown)
▶ 2 (+12V)	▶ (A) 7 or (B) 11 (24 V)	▶ +12V (red)
▶ 3 GND	▶ (A) 8 or (B) 12 GND	▶ GND (black)
▶ 4 (Data-)	▶ (A) 9 or (B) 13 (Data-)	▶ Data- B (orange)

3.5 Starting Up at the Solar-Log™

By switching-on the Solar-Log™, it will provide power to the Sensor Box Professional Plus. Afterwards, the Sensor Box Professional Plus must be configured to the free RS485-port:

- Open the dialogue [Configuration | Devices | Definition | Interfaces](#) in the WEB menu of the Solar-Log™. Please refer to the Installation Manual in chapter “Connecting accessories”, “Installation” and “Configuring connected devices”.
- Select under Devices class „Sensor“ and under Manufacturer „M&T Sensor“.
- Carry out device detection.

The Sensor Box Professional Plus is integrated with the system in the same way as an inverter. The further configuration could be handled with the Solar-Log™ web interface.

3.6 Technical Data

Sensor Box Professional Plus

Dimensions, weight	W/H/D in mm: 145/85/40, 360 g
Housing	Powder-coated aluminum
Protection mode	IP65
Operating temperature	-20 °C to +70 °C
Power supply	Via RS485 data cable from Solar-Log™ (10,5-28 VDC),
Supply current	Typical 10 mA
Communication Port	RS485
Protocol	Solar-Log™, 9600 Baud, 8N1
Irradiance	Irradiance : ± 5 % (0 W/m2 to 1400 W/m2) Cell-temperature: ± 1K (-20 °C to +70 °C) / ± 2 K (-40 °C to +85 °C)
Installation	with screws on the substructure
Connection cable	<ul style="list-style-type: none"> • 4 pole, 3 m (10 feet), weather and uv resistant (LiY(St) 11 Y (4 x 0,14) • prolongable up to 50 m (165 feet)
Conformity	CE :DIN EN-61000-6-1:2007 and DIN EN-61000-6-3:2007

07

Pyranometer

1 Kipp & Zonen - Pyranometer

1.1 Kipp & Zonen - Pyranometer

Termination	Addressing	Interface
Yes	No	RS485

Selections available under Kipp & Zonen

supported models:

- SMP3
- SMP11

Overview

- Integrated interface.
- Where to connect: Round socket on the bottom.
- Communication address must be allocated.
- 4-pin wiring.
- Installation steps:
 - Switch off the pyranometer and the Solar-Log™.
 - Connect the pyranometer to the Solar-Log™.

Connect the pyranometer to the Solar-Log 1000, 1200, 1900 or 2000.

The wiring is done using a

- ready-made data cable (supplied with the pyranometer).

Pin assignment:

Solar-Log™ terminal strip connector	Solar-Log Base RS485 (A) / (B)	X4 socket RS485-1 pyranometer
Terminal		PIN
▶ 1 (Data+)	▶ (A) 6 or (B) 10 (Data+)	▶ 4 - B / + (yellow)
▶ 2 12 V	▶ (A) 7 or (B) 11 (24 V)	▶ 7 - 12 V (white)
▶ 3 GND	▶ (A) 8 or (B) 12 GND	▶ 8 - Ground / GND (black)
▶ 4 (Data-)	▶ (A) 9 or (B) 13 (Data-)	▶ 5 - A / - (gray)

Termination:

Please contact Kipp & Zonen for information on termination.



Note

Only one pyranometer can be connected and visualized per Solar-Log™ device.



Note

Check and/or set the following parameters according to the manufacturer's instructions:

Baud rate: 19200, Data bits: 8, parity: even, parity bit: 1.

2 Lufft - Pyranometer

2.1 Lufft - Pyranometer

Termination	Addressing	Interface
-	No	RS485

Selections available under Lufft

Supported Models:

- WS 501 UMB
- WS 503

Overview

- Integrated interface.
- Where to connect: Round socket on the bottom.
- Communication address does not have to be assigned.
- 4-pin wiring.
- Installation steps:
 - Switch off the pyranometer and the Solar-Log™.
 - Connect the pyranometer to the Solar-Log™.

Connect the pyranometer to the Solar-Log 1000, 1200, 1900 or 2000.

The wiring is done using a

- self-made, shielded 4-wire data cable with a terminal block connector.

Procedure

1. If you are making the cable yourself, connect the wires as shown in the following diagram:

Solar-Log™ terminal strip connector	Solar-Log Base RS485 (A) / (B)	X4 socket RS485-1 pyranometer
Terminal		PIN
▶ 1 (Data+)	▶ (A) 6 or (B) 10 (Data+)	▶ RS485 A (green)
▶ 2 12 V	▶ (A) 7 or (B) 11 (24 V)	▶ Positive voltage supply (brown)
▶ 3 GND	▶ (A) 8 or (B) 12 GND	▶ Ground (GND) (white)
▶ 4 (Data-)	▶ (A) 9 or (B) 13 (Data-)	▶ RS485 B (yellow)

Termination:

Please contact Lufft for information on termination.



Note

Only one pyranometer can be connected and visualized per Solar-Log™ device.



Note

Check and/or set the following parameters according to the manufacturer's instructions:

Baud rate: 19200, Data bits: 8, parity: none, Stop bits: none, select UMB binary protocol and device ID:

1

3 Rainwise - PVMet™-200 (Weather station)

3.1 PVMet™-200 (Weather station)

Termination	Addressing	Interface
-*	No	RS485

Selections available under Sensor/Rainwise/PVMet200.

Overview

- Integrated interface.
- Where to connect: Terminal strip on circuit board under the cover.
- Communication address does not have to be assigned.
- 4-pin wiring.
- Installation steps:
 - Switch of the PVMet™-200 and the Solar-Log™.
 - Connect the PVMet™-200 to the Solar-Log™.

Connect the PVMet™-200 to the Solar-Log™.

The wiring is done using a

- self-made, shielded 4-wire data cable with a terminal block connector.

Procedure

1. If you are making the cable yourself, connect the wires as shown in the following diagram:

Solar-Log™ terminal strip connector	Solar-Log Base RS485 (A) / (B)	Terminal strip on circuit board
Terminal		PIN
▶ 1 (Data+)	▶ (A) 6 or (B) 10 (Data+)	▶ RS485 A-
▶ 3 GND	▶ (A) 8 or (B) 12 GND	▶ Ground/GND
▶ 4 (Data-)	▶ (A) 9 or (B) 13 (Data-)	▶ RS485 B+

*Termination:

Please contact Rainwise for information on termination.



Note

Only one PVMet™ -200 can be connected and visualized per Solar-Log™ device.



Note

The device has to be operate in Modbus mode (default) so that the PVMet™ 200 (weather station) can communicate with the Solar-Log™. (Parameter settings according to the manufacturer's instructions).



Note

The bus address of the Rainwise PVMet™ 200 is set to 60 by default.



Note

Check and/or set the following parameters according to the manufacturer's instructions:
Baud rate: Baud rate 9600, Data bits: 8, Parity: none, Stop bits: 1.



Note

The maximum bus length is 1200 meters.

08

Smart Plug components

1 Allnet Network Power Socket

1.1 Allnet Network Power Socket

Allnet network power sockets can switch connect electronic devices on and off. These switching operations can be set manual, time-controlled or based on consumption levels. Allnet network power sockets can be integrated into the local network with a LAN cable connection. Follow the following steps to be able to use these functions with the Solar-Log™:

Procedure:

1. Connect the Allnet socket to a laptop or PC with a LAN cable and plug the Allnet device into a power socket.
2. Click on Control Panel.
3. and then go to the Network and Sharing Center (for other operating systems, refer to the instructions for setting the IP address).
4. Click on Local Area Connection to open the Status window and then click on Properties.
5. Select the Internet Protocol Version 4 (TCP/IPv4) and then click on Properties.

Important!

Note the displayed values before you change them because you will need them again later.

6. Adjust the displayed values as follows (using the following IP address):
 IP address: 192.168.0.101
 Subnet mask: 255.255.255.0
 Gateway: 0.0.0.0
 Confirm the settings with „OK.“
7. Enter the IP address 192.168.0.100 as the URL in your browser to access the Allnet menu.
8. Click on settings and go to [Configuration | LAN Settings](#).
9. Configure a separate IP address for every Allnet network power socket. The new IP address need to match the range for the existing network (refer to your computer's original settings).
 For example, if our computer's original IP address was 192.168.178.2 and the next address is free, the Allnet network power sockets would start with 192.168.178.3 and continue. The Subnet mask is 255.255.255.0 by default and must be the same for every device in the subnet. The gateway is typically the IP address of the router or switch to which the computer is connected again later. Save the settings when they are completed.
10. After adjusting the networks settings for the network power sockets, change the values for your computer's networking settings back to the original values.
11. The configuration is then finished.



Note

ALL3075v3:

To ensure functionality with the Solar-Log™, the ALL3075v3 still has to be set to remote control in the Allnet network socket configuration.

Connecting the Allnet network power socket to the Solar-Log™

The Allnet socket has to be defined with the device detection function to connect to the Solar-Log™. From the WEB interface of the Solar-Log™ go to Configuration | Devices | Definition and select the device class „Switch“ with the blue plus symbol and then Allnet as the manufacturer followed by the type and number of devices. Confirm the selection with OK and start the detection from the Configuration | Devices | Detection menu. Let the detection process run completely. After that, select the corresponding devices from the Configuration | Devices | Configuration menu, enter the IP address and perform the rest of the setup. Click on save once everything is finished.

The last step is configuring the Smart Energy Logics. Refer to the Solar-Log™ Smart Energy Manual for more information. It is available from our website (<https://www.solar-log.com/en/support/downloads>).

2 Smart Relay Station

2.1 Smart Relay Station

Refer to the Smart Relay Station PDF on our for website for more details: <https://www.solar-log.com/en/support/downloads/>.

3 Solar-Log™ Smart Relay Box

3.1 Solar-Log™ Smart Relay Box

The Smart Relay Box makes it possible to switch 8 relays via the Smart Energy control logic depending on the current production (surplus).

The Relay Box has:

- 4 inverter contacts
- 4 make contacts

Characteristics of the relays:

Maximum current load:

0.5 A @ 120 V_{AC}

0.25 A @ 240 V_{AC}

1 A @ 30V_{DC}

0.3 A @ 110V_{DC}

Procedure:

- Connect the Relay Box to the RS485 bus of the Solar-Log™ according to the following diagram:

Relay Box Wiring

Terminal block connector
RS485 Solar-Log™

Solar-Log Base RS485 (A) / (B)

Relay Box
Terminal block
connector

Article Number: 255656

PIN

▶ 1 (Data+)

▶ (A) 6 oder (B) 10 (Data+)

▶ Data + (Y)

▶ 4 (Data-)

▶ (A) 9 oder (B) 13 (Data-)

▶ Data - (G)

- Device detection is not necessary for this device.
- The device only has to be selected from the [Configuration | Smart Energy](#) menu to be activated.
- The power comes from the top-hat-rail power supply that was included with the Relay Box.



Note

The Relay Box has to be defined and activated as a switch in the [Configuration | Devices | Definition | Interfaces](#) with the plus symbol to be able to configure it.



Note
The Solar-Log™ Smart Relay Box cannot be connected together with inverters on an RS485 interface. The Relay Box requires its own separate RS485 bus. It is possible to combine the Utility Meter with sensors.



Note
The Solar-Log™ Smart Relay Box cannot be connected together with PM+ packages on a Solar-Log™.

Relay output assignments

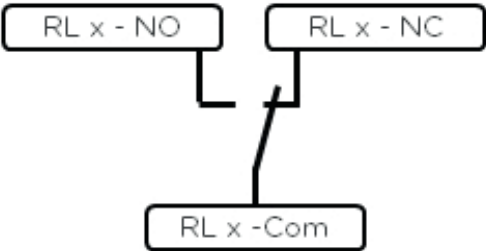

Fig.: Smart Relay Box relay output (change-over contact) diagram

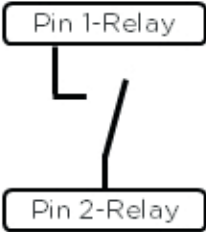

Fig.: Smart Relay Box relay output (make contact) diagram

4 WeMo Insight Switch

4.1 WeMo Insight Switch

With the WeMo Insight Switch, home appliances and electronic devices can be connected to a Wi-Fi network, allowing the devices to be remotely turned on and off. The WeMo Insight Switch can also monitor the devices and will send information about the device's energy usage directly to your smartphone or tablet. Follow the subsequent instructions to be able to use these functions with the Solar-Log™.

Procedure:

1. Connect a desktop/laptop and the Solar-Log™ to the router with a LAN cable.
2. Download the WeMo app to your smartphone or tablet.
3. Reset the WeMo Insight Switch (press the reset button for 5 seconds while turning on the power for the WeMo Insight Switch).
4. The WeMo searches for the smartphone or tablet via WiFi.
5. Start the WeMo app and connect the WeMo Insight Switch to the router's WiFi network.
6. Connect to the Solar-Log™'s WEB interface with the desktop/laptop and go to the [Configuration | Devices | Definition](#) menu.
7. Select the device class „Switch“ with the +plus button.
8. Select „Belkin“ as the manufacturer and „WeMo Insight“ as the type. Enter the number of devices and click on save.
9. Then start the device detection from the [Configuration | Devices | Detection](#) menu.
10. The connection is now established.



Note

A direct connection between the Solar-Log™ WiFi and WeMo is not possible. The Solar-Log™ has to be connected to a router via a LAN cable or to be in a network.

The last step is configuring the Smart Energy Logics. Refer to the Solar-Log™ Smart Energy Manual for more information. It is available from our website (<http://www.solar-log.com/en/service-support/downloads/manuals/current-product.html>).

09

Power Charging Stations

1 Keba - Power Charging Station

1.1 Keba - Power Charging Station (KeContact P20 / P30)

Termination	Addressing	Interface
No	Yes	LAN

Supported models:

- KeContact P20
 - c series
 - x series
- KeContact P30
 - c series
 - x series

Overview

- Connected using network cable (patch cable) and Ethernet router or switch.
- Installation steps:
 - Connect the Keba power charging station to a switch or Ethernet router.
 - Connect the Solar-Log™ to a switch or Ethernet router.

Assigning IP addresses

- Configure the address according to the manufacturer's manual.
- The DHCP range (IP address) for the Keba power charging station has to be in the same subnet as the Solar-Log™.
- The charging station always obtains its IP address via DHCP. That is why the router for the charging station must always assign the same IP address (static). (Refer to the router's manual).

Detection via the Solar-Log™ WEB Interface

- For detection on the Solar-Log™, select the device class under the menu [Configuration | Device | Definition | Interface](#) with the plus symbol and then select Keba as the manufacturer. Confirm your selection with OK.
- Save your selections and then start the Device Detection under [Configuration | Device | Detection](#).

Detection from the Solar-Log 1200

- When using the Solar-Log 1200, the detection can also be started from the display. Select the settings ► Start ► Initial Configuration ► Page 2 „Device“ ► Add and select the manufacturer Keba from there. Save and start the Device Detection.



Note

Adjust the DIP switches on the Keba charging station as follows so that it receives the commands from the Solar-Log™:

- ▶ DSW1.1: OFF (X1 deactivated).
- ▶ DSW1.3: ON (UDP activated).

DIP switch - DSW2.1-2.: IP settings (refer to the Keba manual).

List of figures

Fig.: RJ45 plug pin assignments.....	27
Fig.: RJ11 plug pin assignments.....	28
Fig.: Example 1 of bus topology.....	29
Fig.: Example 2 of bus topology.....	29
Fig.: Albatech APL block connector.....	54
Fig.: RJ14 socket pin allocation.....	67
Fig.: Fronius RL round plug.....	135
Fig.: Gefran RS485 terminal strip and termination.....	140
Fig.: 2-pin terminal TB3.....	140
Fig.: Pairan Round socket.....	229
Fig.: Siemens – connecting inverters together.....	303
Fig.: Control board before and after installation of the piggyback.....	312
Fig.: Piggyback - insert jumper.....	313
Fig.: Jumper SMA.....	314
Fig.: Jumper SMA.....	316
Fig.: Jumper SMA.....	316
Fig.: Control board before and after installation of the piggyback.....	374
Fig.: Piggyback - insert jumper.....	375
Fig.: Jumper SMA.....	376
Fig.: Jumper SMA.....	378
Fig.: Jumper SMA.....	378
Fig.: SMA mixed wiring.....	418
Fig.: Interconnection of Kaco Powador inverters.....	419
Fig.: Wiring diagram to record self-consumption. (optional with battery storage).....	425
Fig.: Wiring diagram for recording self-consumption – bi-directional meter. (optional with battery storage).....	426
Fig.: Pin assignment.....	428
Fig.: Pin assignment.....	431
Fig.: Pin assignment.....	435
Fig.: Example - UMG 104 Utility Meter connection diagram for voltage measurements in low-voltage power grids.....	447
Fig.: Example - UMG 104 Utility Meter connection diagram for current measurements with current transformers.....	448
Fig.: Pin assignment.....	452
Fig.: Connection of the control to the auxiliary relay.....	495
Relay.....	495
Auxiliary relay.....	495
Fig.: Smart Relay Box relay output (change-over contact) diagram.....	524
Fig.: Smart Relay Box relay output (make contact) diagram.....	524

Solare Datensysteme GmbH
Fuhrmannstraße 9
72351 Geislingen-Binsdorf
Germany
Tel: +49 7428 9418 200
Fax: +49 7428 9418 280
info@solar-log.com
www.solar-log.com
www.solarlog-WEB.com
Hotline: +49 7428 9418 660

The copyright of these instructions remains with the manufacturer. No part of these instructions may be reproduced in any form or processed, duplicated or distributed using electronic systems without the written consent of Solare Datensysteme GmbH.

Subject to change without notice.

Solare Datensysteme GmbH cannot guarantee the accuracy or completeness of the information provided and expressly refuses to accept liability for any errors or omissions in such information.

Non-compliance resulting in contradiction of the above-mentioned specifications shall result in obligation to provide compensation for damages.

All brands and trademarks contained in this manual are the sole property of the respective manufacturer, which we respect and recognize herewith. The trademark "Speedwire" is registered trademark of SMA Solar Technology AG in many countries.

SDS assume nos liability for printing errors.