

Bureau of Maintenance and Operations

Temporary Traffic Control Guidelines

Publication 213



Application

Pennsylvania has adopted the MUTCD as published by the FHWA with Pennsylvania specific modifications through Title 67 PA Code, Chapter 212, Official Traffic Control Devices, which provides for TTC on all public roads in the commonwealth.

Publication 213 and the MUTCD apply to contractors; utilities; Federal, State, County, and Municipal governments; and others performing construction, maintenance, emergency, permit work, utility work, or any other type of work on highways or so closely adjacent to a highway that workers, equipment, or materials encroach on the roadway or interfere with the normal movement of traffic. This includes special events that necessitate a need for TTC.

Deployment of TTC devices while working on or near the roadway is a legal requirement per Pennsylvania Vehicle Code, Title 75, Section 6123(a). Failure to utilize TTC devices properly is subject to fines in accordance with Title 75, Section 6123(d).

Publication 213 PATA drawings and GA drawings shall be regarded as minimum requirements. The TTC schemes shown in this publication are consistent with the general provisions found in the most recent editions of Title 67 PA Code, Chapter 212, Official Traffic Control Devices and the MUTCD as issued by FHWA. Implementation should be based on common sense; engineering judgment; the speed and volume of traffic; the duration of the operation; the exposure to potential hazards; the physical features of the highway including horizontal alignment, vertical alignment, and the presence of intersections and driveways; and other important factors.

PATA drawings present typical applications for a variety of situations commonly encountered. While not every situation is addressed, the information illustrated can generally be adapted to a broad range of conditions. In many instances, an appropriate TTC plan is achieved by combining features from various PATA drawings. Elements of multiple PATAs may be combined, without PennDOT DTU approval, if minimum standards are satisfied. TTC setups that do not meet minimum standards require PennDOT DTU approval prior to implementation.

GA drawings are supplemental to the PATAs and may be combined with PATAs to achieve the appropriate TTC plan.

Specific types of work listed in Title 67, Chapter 212.402, are exempt from the requirements contained in this publication, however work must be accomplished in a manner that will provide an adequate degree of safety for workers and the public.

Emergency work may be initiated without prior compliance with this publication and the MUTCD, provided safety measures and TTC are brought into compliance with this publication or the MUTCD as soon as possible. Refer to Title 67, Chapter 212.414, for additional information.

Reference Materials

Pennsylvania Consolidated Statutes Title 67 (Transportation)

Pennsylvania Consolidated Statutes Title 75 (The Vehicle Code)

PennDOT Publication 13M, Design Manual Part 2 – Highway Design

PennDOT Publication 35, Qualified Products List for Construction

PennDOT Publication 46, Traffic Engineering Manual

PennDOT Publication 108, Sign Foreman's manual

PennDOT Publication 111, Pavement Markings and Signing Standards TC-8600 and TC-8700

PennDOT Publication 149, Traffic Signal Design Handbook

PennDOT Publication 234, Flagging Handbook

PennDOT Publication 236, Handbook of Approved Signs

PennDOT Publication 408, Specifications

PennDOT Publication 445, Safety Policy Handbook

Information regarding TTC is found in:

- Manual on Uniform Traffic Control Devices, Part 6 (Federal Highway Administration)
- PA Code Title 67 (Transportation), Chapter 212 (Official Traffic-Control Devices)
- U.S. Department of Transportation, FHWA 2011 Traffic Sign Retroreflective Sheeting Identification Guide
- Quality Guidelines for TTC Devices and Features by American Traffic Safety Services Association (ATSSA)

Table of Contents

Item Description
Acronyms
Definitions
General Notes
Section A - Worksite Procedures
Section B - Flagging Operations
Section C - Channelizing Devices and Delineation
Section D - Signs
Section E - PCMS Trailer Placement, Visibility, Legibility, and Message Content
Section F - TTC Setup and Removal
Section G - Vehicle/Equipment Parking and Material Storage
Section H - Flashing Lights, Warning Lights, and Sequential Flashing Warning Lights
Section I - Pedestrians
PATA/GA Index
PATA/GA Symbols
PATA/GA Reference Charts
General Applications
Pennsylvania Typical Applications
PATA 100 Series - Conventional Highways; Short-Term Stationary Operations
PATA 200 Series - Conventional Highways; Long-Term Stationary Operations
PATA 300 Series - Conventional Highways; Mobile Operations
PATA 400 Series - Freeways & Expressways; Short-Term Stationary Operations
PATA 500 Series - Freeways & Expressways; Long-Term Stationary Operations
PATA 600 Series - Freeways & Expressways; Mobile Operations
PATA 700 Series - TTC Signal Operations
PATA 800 Series - Hauling Operations
Appendix A - TTC Sign Nomenclatures and Sizes
Appendix B - Sign Sheeting Identification Guide
Appendix C - TTC Device Quality Guidelines
Appendix D - TTC Signal Documents
Appendix E - TMC Road Work Reporting Form

Acronyms

ADT - Average Daily Traffic

AFAD - Automated Flagger Assistance Device

ANSI - American National Standards Institute

DTE - District Traffic Engineer

DTMC - District Traffic Management Center

DTU - District Traffic Unit

GA - General Application

LED - Light Emitting Diodes

FHWA - Federal Highway Administration

MUTCD - Manual on Uniform Traffic Control Devices

PATA - Pennsylvania Typical Application

PCMS - Portable Changeable Message Sign

PennDOT - Pennsylvania Department of Transportation

PTC - Pennsylvania Turnpike Commission

RCRS - Road Condition Reporting System

RTMC - Regional Traffic Management Center

SV - Shadow Vehicle

TMA - Truck Mounted Attenuator / Trailer Mounted Attenuator

TMC - Traffic Management Center

TPRS - Temporary Portable Rumble Strips

TTC - Temporary Traffic Control

Definitions

Active Work Zone - The portion of a work zone where construction, maintenance, or utility workers are on the roadway or on the shoulder of the highway, and workers are adjacent to an active travel lane. Workers are not considered adjacent to an active travel lane if they are protected by a traffic barrier and no ingress or egress to the work zone exists through an opening in the traffic barrier.

Activity Area - Area of a temporary traffic control zone comprised of the buffer space and the work space usually separated from traffic flow by channelizing devices or barrier located parallel to the travel lanes.

Available Corner Sight Distance - The maximum measured distance along a crossing highway which a driver stopped at a side road or driveway can continuously see another vehicle approaching. For the purpose of measuring the available sight distance, the height of both the driver's eye and the approaching vehicle should be assumed to be 3'-6" above the road surface. In addition, the driver's eye should be assumed to be 10' back from the near edge of the highway or the near edge of the closest travel lane if parking is permitted along the highway.

Average Daily Traffic (ADT) - Expressed as the number of vehicles per day using a given roadway. ADT is the total volume of traffic during a number of whole days-more than one day and less than one year-divided by the number of days.

Buffer Space - Area that separates traffic flow from the work space. Buffer spaces within the roadway shall remain clear of equipment, vehicles, workers, and materials. This requirement may include the adjacent shoulder as shown on the applicable PATA. The length of longitudinal buffer spaces (Distance E) may be increased for downgrades or other conditions that affect stopping sight distance.

- Longitudinal buffer space (Distance E) is measured upstream of the work space.
- Lateral buffer space is located between flowing traffic and the activity area. Width has no prescribed minimums or maximums and is to be determined on site.

Channelizing Device - The function is to warn road users of conditions created by work activities in or near the roadway and to guide road users.

Clear Zone - The total roadside border area, starting at the edge of traveled way, available for safe use by errant vehicles.

Complex Condition (TTC Signals) - A condition where driveways and/or side roads exist between the TTC signals. Additional signal installations or flaggers are required to control traffic in addition to those shown on PATA 700 series drawings.

Construction Project - Work performed as described in a contract.

Conventional Highway - Any highway other than a freeway or expressway. Conventional highways are further characterized as either Rural Highways or Urban Highways.

Corner Sight Distance - See Available Corner Sight Distance.

Downstream - A term that refers to a location that is encountered by traffic subsequent to an upstream location as it flows in an "upstream to downstream" direction.

Downstream Flagger - Flagger positioned on the downstream end of an operation. The downstream and upstream flaggers are labeled on General Application 01.

Emergency Detour Route System (EDRS) - Pre-established routes along conventional highways to guide traffic from one freeway interchange to the next interchange. Drivers may have to follow an emergency detour if a freeway is closed in at least one direction. EDRS roadways are posted with trailblazer or route marker signs.

Emergency Work - Emergencies may arise where it will be necessary to begin work even though all of the specific traffic control provisions may not be satisfied. In these cases all available safety measures shall be taken and the work zone shall be brought into compliance with this publication as soon as possible.

Engineering Judgment - The evaluation of pertinent information, and the application of appropriate principles, provisions, and practices for the purpose of deciding upon the applicability, design, operation, or installation of a TTC device. Engineering judgment shall be exercised by an engineer, or by an individual working under the supervision of an engineer, through the application of procedures and criteria established by the engineer.

Expressway - A divided arterial highway for through traffic with partial control of access and generally with grade separations at major intersections.

Freeway - A limited access highway to which the only means of ingress and egress is by interchange ramps.

Definitions

GA (General Application) - Drawings/Information within this Publication that is meant to be combined with or applied to the TTC Plan.

Highway - The entire width between the boundary lines of every way publicly maintained when any part thereof is open to the use of the public for purposes of vehicular travel.

Lateral Offset (Lateral Clearance) for TTC signs - Area between the roadway/shoulder and nearest edge of a TTC sign or support. This area shall remain clear and available for vehicles utilizing the shoulder.

Long-Term Stationary Operation - Work that occupies a location for a period of more than 72 hours.

Mobile Operation - An moving operation that proceeds downstream at least 100' every 15 minutes. Every component of the operation, excluding advanced warning signs and flagger locations, must proceed in the direction of normal traffic flow. The distance/time threshold must be met for the entire duration of the operation to utilize PATA 300 or 600 Series plans.

Multi-Lane - More than one lane moving in the same direction.

Non-Complex Condition (Temporary/Portable Traffic Signals) - A condition where driveways and/or side roads do not exist in the TTC zone utilizing temporary traffic signals. PATA 700 series drawings can be implemented and run automatically exactly as shown without flagger assistance or additional signals.

Numbered Traffic Route - A highway that has been assigned an Interstate, United States, or Pennsylvania Route Number, consisting of one, two, or three digits, sometimes with an additional designation such as business route or truck route.

PATA (Pennsylvania Typical Application) - Drawings within this publication that depict TTC conditions.

Pilot Vehicle - A Vehicle used to guide road users through TTC areas. Pilot vehicles must be equipped with a PILOT CAR FOLLOW ME (G20-4) sign on the rear and a flashing, oscillating, or revolving yellow light which is visible from any direction.

Portable Sign Post (X Base and H Base) - Rigid device with steel posts for mounting TTC devices where minimum mounting heights of at least 5' are required. Refer to PennDOT Publication 111, Standard TC-8717.

Portable Sign Support - A folding, collapsible, or telescoping device for posting TTC devices where minimum mounting heights of 1' are acceptable.

Pre-Planned Detour Route - Roadways posted to provide an alternate route in the event of a freeway closure.

Road User - A vehicle operator, bicyclist, pedestrian or animal-drawn conveyance within the highway or on a private road open for public travel.

Roadway - That portion of a highway improved, designed, or ordinarily used for vehicular travel, exclusive of the sidewalk, berm, or shoulder.

Roll Ahead Space - Space provided between the shadow vehicle and the work space in a closed lane. This space shall be clear of equipment, vehicles, workers, and materials. Shown as distance H on PATA drawings.

Rural Highway - Roads passing through areas where adjacent roadside properties are less built up than an urban area. Structures devoted to business or dwelling houses may exist, but are situated at intervals greater than 100 feet.

Shadow Vehicle - A vehicle positioned within the activity area in advance of the work space and work vehicles. TTC devices may be mounted on the vehicle to provide information to approaching drivers. Any vehicle can be used as a shadow vehicle on a conventional roadway as long as it is equipped with a flashing, oscillating, or revolving yellow light which is visible from any direction (360° visibility) and is not being used as a work vehicle. The yellow light must be activated within an active work zone. A TMA is required for shadow vehicles used on or along freeways and expressways.

Short-Term Stationary Operation - An operation that will occupy a location for up to 72 hours. The work zone will have stationary beginning and ending points. Work activity may move freely within these limits.

Shoulder - The part of a highway adjacent to the roadway which has a surface constructed with the same or similar material as the roadway. Shoulder width is measured from the center of the painted edge line to the outside edge of pavement, concrete, or finished surface.

Sidewalk - That portion of a street between curb lines, or the lateral lines of a roadway, and the adjacent property lines, intended for use by pedestrians. A 48" minimum usable width must be maintained.

Definitions

State Roadway (SR) - A highway or bridge on the system of highways and bridges over which PennDOT has assumed or has been legislatively given jurisdiction. Generally, there are two types of SR's:

- Numbered Traffic Route - A highway that has been assigned an Interstate, United States or Pennsylvania route number consisting of one, two, or three digits, sometimes with an additional designation such as business route, truck route, or similar designation.
- Quadrant Route - A highway designated with a four digit number beginning with a 1, 2, 3, or 4.

Taper - Tapers are created by using a series of devices and/or pavement markings to move traffic out of or into the normal path. Taper lengths are shown on PATA drawings as either a constant distance or as a function of a variable (L) and shall be installed at prescribed lengths. Appropriate taper length charts are provided on each PATA.

- Merging Taper - Requires the longest distance because drivers are required to merge into a common road space. Length is Distance L.
- Shifting Taper - Used for a lateral lane shift. Length is $1/2L$ (one half the Merging Taper length).
- 50' Per Lane Taper - Taper whose length is 50' per single lane of travel. Length may be extended proportionally where the required offset width is more than a single lane, but the length shall not be decreased.
- Shoulder Taper (paved shoulders having widths of 8' or more) - Required on closed shoulders and on shoulders adjacent to a closed lane when no flaggers are present. Length is $1/3L$ (one third the Merging Taper length).
- Shoulder Taper (shoulder material/widths not listed above) - Taper placement on closed shoulders is optional. If used, the length is $1/3L$ (one third the Merging Taper length).
- Downstream Taper - Used in the termination area to provide a visual cue to the driver that access is available back into the original lane or path that was closed. Length is 50' per travel lane.

TMA Truck/Trailer-Mounted Attenuators - Shall be mandatory for placement on shadow vehicles utilized on freeways and expressways, including exit and entrance ramps. The TMA is optional on other highways. The weight of the shadow vehicle must be greater than the minimum weight specified by the TMA manufacturer.

Traffic Control Device (TTC Device) - A sign, signal, marking or other device used to regulate, warn, or guide traffic, placed on, over, or adjacent to a street, highway, private road open to public travel, pedestrian facility, or shared-use path by authority of a public agency or official having jurisdiction, or, in the case of a private road open to public travel, by authority of the private owner or private official having jurisdiction.

TTC Zone - An area of a highway where road user conditions are changed because of a work zone or incident by the use of TTC devices, flaggers, uniformed law enforcement officers, or other authorized personnel.

Upstream - A term that refers to a location that is encountered by traffic prior to a downstream location as it flows in an "upstream to downstream" direction.

Upstream Flagger - Flagger positioned on the upstream end of an operation. The upstream and downstream flaggers are labeled on General Application 01.

Urban Highway - Roads in areas which are built up with structures devoted to business or dwelling houses situated at intervals of less than 100' for a distance of a quarter of a mile or more.

Warning Lights - Yellow lights that operate in steady burn or flashing mode. Warning lights on authorized vehicles may flash or revolve. Type A, B, C, and D warning lights are portable, powered, yellow, lens-directed enclosed lights.

Worker - A person on foot whose duties place him or her within the highway right-of-way, such as construction and maintenance forces, survey crews, utility crews, first responders, and law enforcement personnel.

Work Space - Area within a TTC zone that is set aside for workers, work vehicles, equipment, and material storage.

Work Vehicle - A vehicle available for use by workers within an activity area. Work vehicles shall be located outside of the buffer space and shadow vehicle roll ahead space. Work vehicles being used in active work zones must utilize flashing, oscillating, or revolving yellow lights which are visible from any direction (360° visibility).

Work Zone - The area of a highway where construction, maintenance, or utility work activities are being conducted, and in which traffic control devices are required in accordance with Title 67, Chapter 212.

Blank Page

General Notes

General Notes Section A Worksite Procedures

A-1. PennDOT TMC notification may be required prior to establishing TTC restrictions on state owned highways. Notifications aid the PennDOT TMC in maintaining situational awareness of current traffic restrictions. The following chart indicates when notification is required based on roadway type and TTC condition:

PennDOT TMC Notification				
Roadway Type	Temporary Traffic Control Condition			
	Full Road Closure	Lane Restriction >30 Minutes	Lane Restriction <30 Minutes	Shoulder Closure >15 Minutes
Freeways and Expressways	REQUIRED			
Numbered Traffic Routes and Pre-Planned Detour Routes	REQUIRED		Recommended	
Other State Roadways	REQUIRED	Recommended		

Personnel responsible for TTC at the work site shall contact the appropriate PennDOT TMC prior to placing TTC devices on the roadway or beginning work for all 'REQUIRED' conditions.

The following page contains PennDOT contact information and a statewide map showing:

- PennDOT RTMC Regions and RTMC locations.
- PennDOT Engineering District boundaries.

Implementation of an RCRS mobile application will provide users with the ability to submit information about TTC restrictions and conditions remotely. Until the application is active, advance notification should be provided to the TMC. Time reporting requirements vary depending upon whether the event is planned or unplanned:

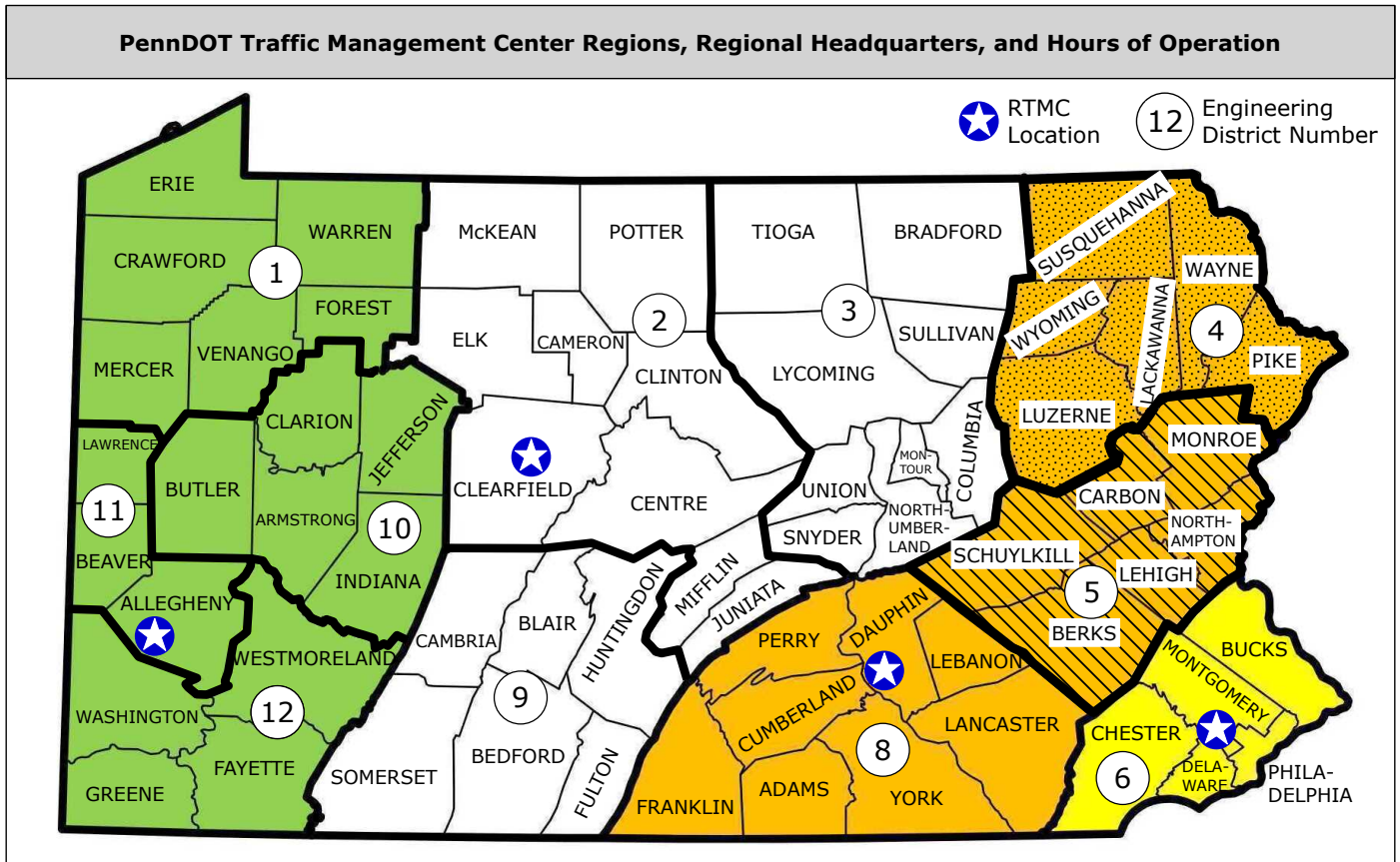
- **Planned Roadwork or Events** - Notify the TMC in writing using form TMC-100, located in Appendix E, at least 14 days in advance of the scheduled roadwork or event. This allows TMC staff time to create a planned event in RCRS. Update the TMC of changes as they occur. The event must be activated by calling the TMC (until an RCRS Mobile App is developed) at least 15 minutes prior to beginning work or setting up TTC devices.
- **Unplanned Events** - Notify the TMC in writing as soon as it is determined that the roadwork or event will occupy the roadway, but at least 15 minutes prior to beginning work or placing TTC devices.

Call the appropriate PennDOT TMC immediately after TTC conditions have ended or update RCRS remotely.

****TTC conditions on the Pennsylvania Turnpike are maintained by the PTC Operations Center. Do not call the PennDOT TMC regarding TTC on the PA Turnpike unless conditions impact a State owned highway.**

Roadwork on the PA Turnpike should be reported to the Turnpike Traffic Operations Center (717) 939-9551, extension 4644.

General Notes Section A Worksite Procedures



District	Region	Email Address	Telephone Number	Dates of Operation	Days of Operation	Operational Period	Off-Hours Contact District
1	Western	Ra-pdd1trafficunit@pa.gov	(814) 673-9661	November 01 to April 01	Everyday	24 Hours	11
2	Central	Pd-dist2-0RTMC@pa.gov	(814) 768-0725	Year-Round	Everyday	24 Hours	--
3	Central	Pd-dist2-0RTMC@pa.gov	(814) 768-0725	Year-Round	Everyday	24 Hours	--
4	Eastern	Ra-pddist40TMC@pa.gov	(570) 963-4058	Year-Round	Monday - Friday	7:00 AM to 6:00 PM	8
5	Eastern	Pd-district5-0TOC@pa.gov	(610) 871-4600	Year-Round	Monday - Friday	6:00 AM to 8:00 PM	8
6	Southeastern	Pd-district6-0RTMC@pa.gov	(610) 205-6934	Year-Round	Everyday	24 Hours	--
8	Eastern	Pd-dist8-0TMC@pa.gov	(717) 265-7600	Year-Round	Everyday	24 Hours	--
9	Central	Pd-dist2-0RTMC@pa.gov	(814) 768-0725	Year-Round	Everyday	24 Hours	--
10	Western	Pd-district11RTMC@pa.gov	(412) 429-6030	Year-Round	Everyday	24 Hours	--
11	Western	Pd-district11RTMC@pa.gov	(412) 429-6030	Year-Round	Everyday	24 Hours	--
12	Western	Pd-district11RTMC@pa.gov	(412) 429-6030	Year-Round	Everyday	24 Hours	--

General Notes Section A Worksite Procedures

A-2. TTC distances are established as follows:

Item	Distance or Variable		Note
Sign Spacing (Range)	A, B, C, D		Distance between TTC signs should be within the ranges shown on the spacing charts, but may be extended with justification.
Sign Legibility Distance	Speed (MPH)	Distance (Feet)	TTC Signs shall be entirely visible to motorists for the minimum distance specified. The distance provided is equal to the perception/reaction distance of the stopping sight distance.
	25	95	
	30	115	
	35	130	
	40	150	
	45	170	
	50	185	
	55	205	
	60	225	
	65	240	
	70	260	
Channelizing Device Spacing Within Tapers	S		Distance S = Regulatory speed limit (in feet). This is a maximum spacing between channelizing devices.
Channelizing Device Spacing Along Longitudinal Lines	2S		Distance 2S = Double the Regulatory Speed limit (in feet). This is a maximum spacing between channelizing devices.
Flagger Stations (Stationary Operation)	25'-100'		Flaggers shall stand at least 25', but no more than 100', from the nearest channelizing device placed within a taper.
Flagger Visibility	E Minimum		Flaggers shall be visible to approaching traffic for Distance E minimum.
Buffer Space	E		Buffer space should be maintained as shown, but length may be extended with justification.
Roll Ahead Space	H		Roll ahead space shall be maintained.
Distance Between Shadow Vehicles	Varies		Shadow vehicle spacing may vary depending on the operation.
Taper Lengths	L, 1/2L, 1/3L, 50' Per Lane		Taper lengths shall be maintained.
Work Space	Varies		Work space length varies depending on field conditions.

A-3. The needs and control of all road users (motorists, bicyclists, and pedestrians, including persons with disabilities in accordance with the Americans with Disabilities Act of 1990) through a TTC zone shall be an essential part of highway construction, maintenance operations, utility work, and the management of traffic incidents.

A-4. Do not perform work over lanes open to live traffic unless authorized by the PennDOT DTE. Work taking place on maintenance platforms, catwalks, open boom trucks, etc., requires closure of the lane(s) immediately below. This restriction does not apply to work within an enclosed environment (e.g. inside a walk-in permanent dynamic message sign).

A-5. All detour routes involving state-designated highways shall be approved by the appropriate PennDOT DTE prior to being posted. Detours involving local highways should be approved by local authorities prior to being posted. All necessary signs shall be in place before any detour route is opened to traffic.

A-6. Pavement markings (lane line and/or center line), of more than 250 linear feet on a highway, that are covered or destroyed by construction, maintenance, utility, permit, or other work must be replaced before terminating work each day. The replacement markings may be standard pavement markings or temporary markings as included in PennDOT Publication 408, Section 901.3(k) or in the MUTCD, Section 6F.78.

General Notes Section A Worksite Procedures

A-7. Workers engaged in or entering into any field operation are required to wear hard hats meeting ANSI Type I requirements and high-visibility vests, t-shirts, or sweatshirts which meet the ANSI Class 2 or 3 safety garment requirements. A raincoat or jacket which meets ANSI Class 2 or 3 safety garment requirements may be worn during inclement weather. Furthermore:

- All visitors and others present on a work site in an official capacity must comply with the requirements.
- PennDOT employees shall refer to Publication 445, Safety Policy Handbook, and any applicable PennDOT memoranda regarding Personal Protective Equipment (PPE) and work attire.
- Emergency, incident responders, and law enforcement personnel within TTC zones should wear high-visibility public safety vests that meet the performance requirements of the ANSI/ISEA 207-2011 (Refer to MUTCD, Section 1A.11).

A-8. Work vehicles and shadow vehicles are authorized vehicles as defined in Title 75, Section 102. Authorized vehicles are approved to be equipped with yellow or amber flashing, oscillating, or revolving lights which are visible from any direction (360° visibility). Other colors such as white, clear, red, or blue shall not be used on authorized vehicles. The installation or use of additional flashing lights (e.g. strobe lights) in existing vehicular lighting modules/assemblies (i.e. headlights, parking lights, taillights) is prohibited. Refer to The Pennsylvania Code, Chapter 173 for more information.

A-9. Parking may be prohibited along conventional highways in conjunction with TTC conditions. Coordinate with local authorities to request temporary parking prohibition signing and enforcement.

A-10. During construction projects, existing traffic signals within the TTC zone and along detour routes may require timing and/or phasing modifications to accommodate temporary traffic patterns. The primary contractor is responsible to submit a letter to the PennDOT DTE to either confirm that existing traffic signal timing is adequate to control temporary traffic patterns without a significant decrease in the level of service, or that traffic signal timings will require modification to maintain acceptable levels of service. This letter shall be received prior to placing TTC devices. The PennDOT DTE may request a copy of the capacity analysis report. The contractor is required to abide by the temporary signal permit process prior to beginning work if signal modifications are recommended by the PennDOT DTU. Refer to Publication 46, Chapter 12 and Publication 149, Chapter 14.

A-11. When temporary conditions will restrict or prohibit turning movements at signalized intersections and the condition is expected to be in place for more than 30 consecutive days, the PennDOT DTU should review the traffic signal phasing and timing plan to determine whether an alternate phasing and timing plan should be used to address the temporary condition. The entity responsible for the temporary condition shall comply with PennDOT DTU guidance.

A-12. Mobile operations that occupy the roadway, shoulder, or berm shall proceed in the direction of normal traffic flow.

A-13. Temporary pavement markings are required for long-term operations except where channelizing devices are placed in accordance with General Note C-7. If temporary edge lines will be applied to temporary concrete barrier, the lower sloping surface of the barrier shall be thoroughly cleaned by high-pressure water blasting before applying pavement marking paint or pavement marking tape. Refer to PennDOT Publication 46, Section 6.7.

A-14. Bridge inspection teams working on freeways and expressways shall utilize two shadow vehicles to protect workers and work vehicles. A distance of at least 1000' should be maintained between shadow vehicles while remaining on the same side of the roadway as the inspection team.

A-15. Shadow vehicles may be used in emergency situations to protect concrete barrier blunt ends. PennDOT DTE approval is required if the shadow vehicle will remain in place for more than three days.

A-16. Flares (incendiary or electronic) may be placed on the shoulder within the advance warning area of a TTC zone to provide additional conspicuity due to adverse weather, roadway geometry, etc. Flares may only be used while work is in active progress. Debris from incendiary devices shall be removed upon work completion. Except for emergency conditions or police activity, flares shall not be placed on the roadway or within the activity area.

A-17. All TTC devices erected for maintenance and protection of traffic shall be removed as soon as practical when they are no longer needed. When work is suspended for short periods of time, TTC devices erected for the maintenance and protection of traffic shall be removed or covered when they are no longer appropriate.

A-18. To the extent practicable, the length of work zones shall be appropriate to the work in progress so that motorists do not increase speed after passing through a long stretch with no sign of work activity. Lane restrictions shall be minimized to prevent traffic congestion and unsafe traffic conditions.

A-19. An Arrow Board operating in Merge Mode (displaying an arrow or chevrons) is required only for stationary or moving lane closures on multi-lane roadways.

General Notes

Section B

Flagging Operations

B-1. All flaggers shall be trained as per PennDOT Publication 408, Section 901.3(y). Because flaggers are responsible for public safety and make the greatest contact with the public, it is essential to practice safe traffic control and public contact techniques. Flaggers must demonstrate the following abilities:

- Receive and communicate specific instructions clearly, firmly, and courteously.
- Move and maneuver quickly in order to avoid danger from errant vehicles.
- Control signaling devices in order to provide clear and positive guidance.
- Maintain situational awareness, protect the work crew, and provide direction to the traveling public.

B-2. Flaggers must be clearly visible to traffic for Distance E minimum.

B-3. Flaggers must be aware of their public image at all times. Unprofessional behavior, such as utilizing electronic devices for personal use, is prohibited while performing flagging duties. Flaggers shall not perform work unrelated to traffic control or perform duties while sitting in or standing near a vehicle.

B-4. Upstream and Downstream flagger stations are shown on PATA and GA drawings. Additional flaggers may be required to control traffic at side roads and driveways.

B-5. Flaggers must be in communication with each other. Communication methods may include two-way radios, hand signals, a pilot vehicle driver, etc.

B-6. Flagger stations shall be illuminated at night. Install temporary lighting to adequately illuminate flagger stations without creating a glare that is hazardous to road users. Permanent light sources that may exist in the TTC area, such as roadway luminaires, are not sufficient to fulfill this requirement.

B-7. When a highway-rail grade crossing exists within the work zone, or it is anticipated that queues resulting from the lane closure might extend through a highway-rail grade crossing, provisions shall be made to eliminate conflicts, which may require placing a flagger at the crossing. Coordination with the railroad is required.

B-8. Flaggers shall use a stop/slow paddle, a red flag, or an AFAD to control road users approaching a TTC zone. The use of hand movements alone without a paddle, flag, or AFAD to control traffic is prohibited except for law enforcement personnel or emergency responders at incident scenes as described in MUTCD, Section 6I-01.

B-9. The stop/slow paddle:

- Shall be used to control traffic approaching from a single direction.
- Shall be held by hand and under control at all times. Traffic cones, carts, etc. shall not be used to hold the device.
- Shall display an 18" minimum stop sign on one face and a diamond shaped slow sign on the opposite face.
- Sign faces shall have sheeting of an approved type and listed in PennDOT Publication 35 (Bulletin 15).
- Shall be attached to a shaft that has a minimum length of 72".
- May incorporate either white or red flashing lights on the STOP face and either white or yellow flashing lights on the SLOW face (Refer to MUTCD, Section 6E.03).

B-10. The red flag:

- Shall be used by a flagger stationed within an intersection controlling traffic from multiple directions.
- Shall be red or fluorescent orange/red in color (standard orange flags commonly used on TTC signs are unacceptable for controlling traffic).
- Shall be a minimum size of 24" square and securely fastened to a staff approximately 36" in length.
- Shall be retroreflective when used during night operations.

General Notes
Section B
Flagging Operations

B-11. Flaggers shall not control traffic from within a signalized intersection while the traffic signal is functioning in Automatic Mode (cycling green-yellow-red). Traffic signals shall be changed to Flashing Mode while a flagger is stationed within the signalized intersection. Most traffic signals have a Manual Mode, which can be operated from the roadside, however permission must be received from the signal permittee. Signals shall resume automatic operation immediately upon conclusion of manual flagging. Assistance from the PennDOT DTU or local officials is required to change traffic signal operation modes.

B-12. Flaggers used during mobile operations should proceed through signalized intersections in compliance with traffic signals.

B-13. Flaggers controlling traffic approaching from a single direction should stand on the shoulder or in the closed lane prior to stopping traffic. A flagger may stand in the open lane after traffic has stopped.

B-14. A red wand (flashlight) may be used to supplement the stop/slow paddle or red flag. The flashlight shall have a red glow cone and emit a steady-burn (non-flashing) light. The red wand shall not be used by itself to control traffic.

B-15. Flaggers should hold stopped traffic for as little time as possible.

General Notes
Section C
Channelizing Devices and Delineation

C-1. Channelizing devices are divided into two categories; short-term and long-term (Refer to General Application 11-A for channelizing device details):

- For operations up to 72 hours, short-term or long-term devices may be used.
- For operations greater than 72 hours, long-term devices shall be used.

C-2. Cones may only be used as a channelizing device for operations where work is in active progress. If the work is in active progress for greater than 72 hours, a long-term device shall be used.

C-3. Cones shall be made of any plastic polymer, plastic copolymer, or rubber elastomer than can be compounded to meet PennDOT specifications for traffic cones.

C-4. All channelizing devices shall have retroreflective sheeting of a type approved by PennDOT and listed in PennDOT Publication 35 (Bulletin 15). Refer to General Application 11-A.

C-5. Channelizing devices that form tapers shall be visible to approaching traffic for a distance equal to or greater than the Sign Legibility Distance shown in General Note A-2.

C-6. Barricades and vertical panels with stripes shall have alternating orange and white retroreflective stripes sloping downward at an angle of 45 degrees in the direction traffic is to pass. Refer to General Application 11-B.

C-7. Channelizing devices may be substituted for temporary longitudinal edge line pavement markings and downstream tapers if the devices are spaced at a maximum distance in feet equal to the regulatory speed limit. Channelizing devices cannot be substituted for the upstream taper, lane line, or center line pavement markings.

C-8. Channelizing devices placed on roadways should be placed on the same side of the line as the work space to reduce the impact to motorists in adjacent lanes. Minimum lane width of 10' shall be provided.

C-9. Tapers within a travel lane shall utilize a minimum of 6 channelizing devices. Additional channelizing devices may be required based on the regulatory speed limit. Channelizing devices should be equally spaced within tapers.

C-10. Shoulder tapers are required during non-flagging operations when paved shoulders have a width of 8' or more.

C-11. Channelizing devices used to form a taper may differ from the longitudinal section. However, all of the devices used within the taper or longitudinal section must be of the same type (e.g. the same type of cone are used within the taper while drums are used within the longitudinal section).

C-12. Type III barricades have no maximum area regarding size of signs mounted on the device, however the total weight of all signs shall not exceed 25 pounds.

C-13. When a light mounted on a barricade has a separate battery case, the case must be placed either on the ground or attached 20" maximum above the ground to the post or base leg.

C-14. Sandbag ballast shall be placed on the end of each leg of Type II and Type III barricades to provide stability.

C-15. Temporary concrete barrier shall have delineation that conforms with PennDOT Publication 111, TC-8604 Sheet 2 of 4.

General Notes

Section D

Signs

D-1. Signs shall be mounted on portable sign supports, portable sign posts, barricades, or by methods commonly associated with permanent signs. Refer to General Application 10 for TTC Sign Installation.

D-2. TTC warning signs shall have an orange background and black border/legend. Warning signs with pink backgrounds are intended for incident management areas, but orange warning signs may be used if pink signs are not available.

D-3. Sign sheeting shall be listed in Publication 35 (Bulletin 15). Signs manufactured with a mesh or transparent quality are prohibited. Refer to the 2011 Traffic Sign Retroreflective Sheeting Identification Guide in Appendix B of this publication or PennDOT Publication 46, Exhibits 2-3 and 2-4, for retroreflective material and level information. Signs bearing Type VII through XI retroreflective material are considered equivalent and interchangeable.

D-4. When TTC signs are installed in a TTC zone, permanent signs that provide a conflicting message shall be covered or removed. See PennDOT Publication 408, Section 901.3(a), for details on covering signs.

D-5. When a FLAGGER SYMBOL (W20-7) sign is displayed, a flagger must be present.

D-6. TTC signs may be mounted on Type III barricades. TTC signs for pedestrians/bicyclists may be mounted on Type I or Type II barricades.

D-7. Do not mount TTC warning signs on existing sign installations. This could result in mounting heights below the minimum standard, display an improper sign grouping, and could provide too much information for drivers to comprehend. Drivers need adequate time to read, comprehend, and react to information provided on each sign. TTC devices shall not be attached to utility poles or other structures unless the owner grants written permission and signs can be properly positioned.

D-8. Sign sizes are shown in Appendix A. Refer to PennDOT Publication 236 for additional information.

D-9. Do not place sign supports on sidewalks, bicycle facilities, or areas designated for pedestrian or bicycle traffic unless there are no suitable alternative locations; an exception is made for signs related to sidewalk and/or bicycle facility closures which are directed towards pedestrians and bicyclists. If sign supports are placed on sidewalks, an accessible path of 48" minimum width shall be provided. This accessible path must remain clear for pedestrian use.

D-10. Install supplemental TTC signs prior to the first TTC sign in the advance warning area if traffic approaching the TTC zone is queued beyond the first TTC sign. Standard TTC signs or a PCMS with an appropriate message may be utilized.

D-11. On Conventional highways, advance warning TTC signs are required along the right side of the highway. Supplemental TTC signs may be placed along the left side of the roadway if the conventional highway is a one-way or divided highway.

D-12. On Freeways/Expressways, two options are provided for advance warning TTC sign placement:

- Option 1 - Install TTC signs along the left and right side of the highway (Refer to PATA 400 or 500 Series).
- Option 2 - Install TTC signs and two PCMS on the right side of the highway (Refer to PATA 400 or 500 Series).

D-13. Orange flags or yellow flashing warning lights may be placed on TTC warning signs to increase conspicuity. Flags and lights shall not be used simultaneously on a sign. Flags or lights shall not block the sign face.

D-14. TTC signs specific to an operation may be used as an alternative to the ROAD WORK AHEAD (W20-1) sign.

D-15. TTC warning signs mounted on portable sign supports that do not meet the minimum mounting heights (Refer to GA 10) should not be used for a duration of more than three days.

D-16. Distances posted on TTC signs with 'Miles' as the unit of measure shall utilize whole numbers and/or proper fractions with denominators of 2, 4, or 8. The use of decimals is prohibited.

D-17. TTC signs must be installed on side roads during stationary operations. Refer to General Application 06.

D-18. TTC signs shall be installed so that the entire sign face is visible to approaching traffic. Refer to the Sign Legibility Distances shown in General Note A-2.

D-19. Sandbags are the only acceptable form of ballast for TTC signs and barricades. Ballast should be kept to the minimum amount needed and placed on the ground.

D-20. Ballast shall be placed on the end of each leg of Type III barricades and Portable Sign Posts to provide stability.

D-21. TTC signs placed near side roads and driveways shall not limit sight distance of a driver entering the highway.

General Notes

Section E

PCMS Trailer Placement, Visibility, Legibility, and Message Content

E-1. PCMS messages provided on approved TTC plans shall be displayed exactly as shown. If messages are not provided and/or other messages are desired, follow guidance provided in MUTCD, Section 2L.05 to create a proper message. Contact the DTMC, RTMC, or PennDOT DTU to request approval prior to posting alternate messages. Approved messages may be saved for future use. Alteration of a previously approved message is considered a new message and requires approval.

E-2. PCMS should be placed off the shoulder and behind barrier. Where barrier is not available to shield the PCMS, it should be placed off the shoulder and outside of the clear zone. If a PCMS has to be placed within the clear zone, it shall be delineated with retroreflective TTC devices. Refer to General Application 09.

E-3. PCMS should be visible from 1/2 mile under both day and night conditions. Visibility is associated with the point where the PCMS is first detected, whereas legibility is the point where the message on the PCMS can be read. PCMS messages with two phases shall be legible for at least 600' under night conditions and 800' under day conditions. If these distances cannot be achieved, the PCMS shall not display more than one phase.

E-4. PCMS boards shall automatically adjust their brightness under varying light conditions in order to maintain legibility.

E-5. PCMS boards on trailers or vehicles shall have a minimum height of 7' from the road surface to the bottom of the sign while messages are displayed.

E-6. Each PCMS message shall consist of no more than two phases. A phase shall consist of no more than three lines of text. Each phase shall be understood by itself regardless of the sequence in which it is read. The display time for each phase should be at least 2 seconds, and the total display time for both messages shall be 8 seconds maximum.

E-7. If more than two phases are needed to display a message, additional PCMS should be used. When multiple PCMS are needed, they should be placed on the same side of the roadway and should be separated from each other by a distance of at least 1000' on freeways/expressways and a distance of at least 500' on conventional highways.

E-8. Letter height requirements for PCMS messages:

- 18" minimum for trailer-mounted PCMS along roadways with speed limits of 45 MPH or higher.
- 12" minimum for trailer-mounted PCMS along roadways with speed limits of 40 MPH or lower.
- 10" minimum for vehicle-mounted PCMS.

E-9. PCMS messages shall display only traffic operational, regulatory, warning, and guidance information.

E-10. PCMS Messages shall not include advertising, animation, rapid flashing, dissolving, exploding, scrolling, or other dynamic elements. Telephone numbers (except for 911 and 511) and website addresses shall not be displayed on PCMS located within PennDOT right-of-way.

E-11. PCMS messages shall be displayed in the English language unless another language is requested by the PennDOT District Executive or an individual holding a higher position within PennDOT or Commonwealth Government.

E-12. PCMS messages shall consist of all upper-case letters with each line of text centered on the board. Exceptions are made for full-matrix boards when displaying an exact duplicate of standard signs containing the name of places and streets.

E-13. PCMS messages providing advance notice of scheduled work or restrictions should include the weekday (name or date) that the event or restriction will begin:

- Display the date (DD/MM) if the event is more than seven days away. Update this message one week prior to the event by replacing the date with the weekday name.
- Display a weekday name (e.g. Monday) when the work is within seven days.

E-14. PCMS trailers are equipped with housing boxes for equipment and batteries. All housings shall be locked while the PCMS is deployed on a work site, regardless of active message display, or when stored within PennDOT right-of-way. This is to provide public safety by deterring unauthorized access to programming hardware, software, and power sources.

E-15. The colors used for legends on PCMS shall comply with those shown in MUTCD, Table 2A-5.

E-16. When PCMS are not being used to display TTC messages, they should be relocated to outside the clear zone or shielded behind a traffic barrier and turned away from traffic.

General Notes

Section F

TTC Setup and Removal

F-1. TTC shall be established in accordance with the following:

- Custom plan created and approved for the work site.
- PennDOT: Publication 213, Temporary Traffic Control Guidelines.
- FHWA: Manual On Uniform Traffic Control Devices.

F-2. PATA drawings may be combined to make a TTC plan without PennDOT DTE approval if standards are satisfied.

F-3. Install TTC components in the following order:

- a) Advance warning area (install signs then place flaggers, if used).
- b) Transition area.
- c) Activity area.
- d) Termination area.

F-4. Remove TTC components in the following order:

- a) Termination area.
- b) Activity area.
- c) Transition area (remove channelizing devices from roadway then cease flagging duties, if flaggers are used).
- d) Advance warning area.

F-5. Shadow vehicles:

- Required (equipped with a TMA) on freeways and expressways where workers are present. Where more than one work space exists within a lane closure, additional shadow vehicles may be utilized.
- Required (equipped with a TMA) on freeways and expressways where needed to protect drivers from potentially hazardous conditions when workers are not present. Where more than one work space exists within a lane closure, additional shadow vehicles may be utilized.
- Required on conventional highways unless labeled as 'Optional' on the PATA drawing or corresponding notes page.
- Shall have active flashing, oscillating, or revolving yellow lights during operations. Hazard warning lights and turn signals are not considered flashing lights for this purpose.

F-6. Consider using temporary longitudinal barrier to protect workers in all multi-lane TTC zones if the speed limit is 45 MPH or greater, workers are present within one lane width of an active lane, and a lane or shoulder is closed continuously for more than three days. Refer to PennDOT Publication 72M, Roadway Construction Standards, for barrier installation details.

F-7. Paved shoulders may be used for motorists if they are structurally sound, have sufficient width and depth to safely support traffic, and are free of debris. Shoulders used for traffic during long-term operations may require extra attention, such as:

- Mill and fill existing edge line and shoulder rumble strips.
- Eradicate and paint new white edge lines.
- Review the condition and elevation of inlet grates. Tack-weld grate inlets to frames.
- Refer to PennDOT Publication 13M, Design Manual Part 2, for cross slope information.

F-8. Workers on freeways and expressways shall not walk across lanes of live traffic for the purpose of installing or removing TTC devices. Methods for sign installation and removal along both sides of a freeway or expressway are shown on GA 07.

F-9. Where the regulatory speed limit changes within a TTC zone, use the higher limit to determine sign spacing and use the lower limit to determine channelizing device spacing.

General Notes
Section F
TTC Setup and Removal

F-10. Most permanent traffic signals are owned, operated, and maintained by the local municipality. Contact the municipality prior to the start of work to request placing the signal operation in flash mode, unless a temporary signal permit is in effect.

F-11. Where multiple TTC zones overlap, efforts should be made to coordinate TTC device placement so motorists do not experience a confusing, repetitive, or conflicting TTC zone.

F-12. When an exit ramp is closed long-term, an EXIT CLOSED sign panel with black legend and border on an orange background should be placed diagonally across the interchange/intersection guide signs.

General Notes
Section G
Vehicle/Equipment Parking and Material Storage

G-1. The buffer space shall be kept free from work activity, equipment, vehicles, and material.

G-2. When work is suspended for more than one hour, equipment, vehicles, and material shall be stored a minimum of 30' from the edge of the nearest open travel lane or behind a longitudinal barrier. If this cannot be accomplished, store these items as far as practical from the nearest roadway edge and delineate with channelizing devices.

G-3. Worker vehicles parked near the work site shall be placed in such a manner that it does not compromise the safety of workers, pedestrians, or road users.

General Notes
Section H
Flashing Lights, Warning Lights, and Sequential Flashing Warning Lights

H-1. Warning lights are portable, powered, yellow, lens-directed enclosed lights of the following types:

- a) Type A Low-intensity Flashing Light - Used to warn road users during nighttime hours that they are approaching or proceeding in a potentially hazardous area. May be mounted on channelizing devices.
- b) Type B High-intensity Flashing Light - Used to warn road users during both daytime and nighttime hours that they are approaching a potentially hazardous area. May be mounted on TTC signs or independent supports.
- c) Type C Steady-burn Light - Used during nighttime hours to delineate the edge of the traveled way. When used to delineate a curve, they should only be used on devices on the outside of the curve, and not the inside of the curve.
- d) Type D 360-degrees steady-burn light - Used during nighttime hours to delineate the edge of the traveled way. When used to delineate a curve, they should only be used on devices on the outside of the curve, and not the inside of the curve.
- e) Sequential Flashing Light - Used on channelizing devices that form a merging taper. Lamps provide a low-intensity steady-burn light equivalent to a Type C light with a high-intensity luminous pulse equivalent to a Type B light.
- f) High Visibility LED 3.5" Light - Triangular light may be used on portable sign supports.

H-2. Sequential flashing warning lights are required on channelizing devices forming merging tapers on freeways and expressways during long-term operations. Channelizing devices must be of a type approved for use with an auxiliary device.

H-3. The following apply to sequential flashing warning lights.

- a) Successive flashing shall occur from the upstream end of the merging taper to the downstream end of the merging taper in order to identify the desired vehicle path.
- b) Each light in the sequence shall flash at a rate of 55-75 times per minute.
- c) One sequential flashing light shall be attached to each channelizing device within the merging taper.

H-4. Type A, Type C, and Type D lights shall be visible on a clear night from a distance of 3,000'.

H-5. Type B lights shall be visible on a sunny day when viewed without the sun directly on or behind the device from a distance of 1,000'.

H-6. Warning lights shall have a minimum mounting height of 30" to the bottom of the lens.

H-7. Flashing light colors, utilization requirements and other common uses on TTC devices:

- a) Yellow - Type B flashing yellow lights are required above temporary yield signs. They are optional for use with warning signs and channelizing devices (except for sequential flashing warning lights described in General Note H-2). LED lights may be utilized on slow faces of stop/slow paddles (see MUTCD 6E.03).
- b) White - Type B flashing white lights are required on TTC signs indicating an active work zone (Act 229). LED lights may be utilized within borders of SPEED LIMIT (R2-1) signs and stop/slow paddles (Refer to MUTCD, Section 6E.03).
- c) Red - Type B flashing red lights are required above temporary stop signs. LED lights may be utilized on stop faces of stop/slow paddles (Refer to MUTCD, Section 6E.03).

General Notes
Section I
Pedestrians

I-1. Both temporary and permanent pedestrian facilities must provide access to persons with disabilities. When existing pedestrian facilities are disrupted, closed, or relocated, temporary facilities shall be detectable and include accessibility features. Sidewalk widths of 60" may be reduced to 48" if 60"x60" passing areas are provided every 200'. Refer to PennDOT Publication 13M, Design Manual 2, Chapter 6 for more information about pedestrian facilities and the Americans with Disabilities Act.

I-2. If the TTC zone affects the movement of pedestrians by closing or restricting permanent facilities, adequate pedestrian access shall be provided with temporary facilities. Refer to PennDOT Publication 13M, Design Manual 2, Chapter 6 for more information regarding pedestrian facilities and the Americans with Disabilities Act.

I-3. Work that closes pedestrian crosswalks at intersections shall be limited to one crosswalk at a time. This is to ensure pedestrians can fully navigate the intersection by using other crosswalks.

I-4. Midblock crosswalks established to create a pedestrian detour must be approved by PennDOT prior to being established on or along any state highway.

I-5. Longitudinal channelizing devices used for pedestrian traffic control shall be interlocked to delineate or channelize flow. The interlocking devices shall not have gaps that allow pedestrians to stray from the channelized path.

I-6. Longitudinal channelizing devices used for pedestrian traffic control must be in compliance with guidance provided in MUTCD, Section 6F.74.

Blank Page

PATA/GA Index

General Applications Index

General Application Description	GA Number
Component Parts of a TTC Zone	
Conventional Highways	01-A
Freeways and Expressways	01-B
Cone Placement within the Advance Warning Area	
	02
Act 229 TTC Signs	
	03
Temporary Portable Rumble Strips	
Conventional Highways	04-A
Freeways and Expressways	04-B
Work Zone Speed Limit Sign Placement	
	05
Intersection Approach Signing	
	06
TTC Devices on Freeways and Expressways	
Installation Sequence	07-A
Removal Sequence	07-B
Rolling Slow Down to Work on Both Sides Simultaneously	07-C
Lane Geometry Warning Signs	
	08
Trailer-Mounted Equipment Lateral Placement and Delineation	
	09
TTC Sign Installation Details	
	10
Channelizing Device Details, Road Closure Signs and Barricade Rail Striping Direction	
Channelizing Device Details	11-A
Road Closure Signs and Barricade Rail Striping Direction	11-B
Arrow Boards - Operating Modes, Specifications, and Display	
	12
TTC Sign Longitudinal Adjustments Due to Roadside Obstruction	
	13
Flagger Visibility on Curves	
Horizontal Curves	14-A
Vertical Curves	14-B
Seal Coat Operations and Related Warning Signs	
Condition 1 - No Pavement Markings Existing or Proposed	15-A
Condition 2 - Roadway has Pavement Markings & ADT is Less than 1000	15-B
Condition 3 - Roadway has Pavement Markings & ADT between 1000 & 5000	15-C
Condition 4 - Roadway has Pavement Markings & ADT is Greater than 5000	15-D
Merge-Then-Shift Pattern Approaching a Lane Closure	
	16
Advisory Speed Posting Guide	
	17

PATA 100 Series Index

Short-Term Stationary Operations on Conventional Highways

PATA Description	PATA Number
Work on or Beyond the Shoulder	
Single-Lane Approach - No Roadway Encroachment	101-A
Multi-Lane Approach - Right Shoulder Work - No Roadway Encroachment	101-B
Multi-Lane Approach - Left Shoulder Work - No Roadway Encroachment	101-C
Single-Lane Approach - Shoulder Work With Minor Roadway Encroachment	102
Single Lane Approach - Shoulder Work With Major Roadway Encroachment	103

Work on Single-Lane Approach	
Work Space on Roadway Center Line	104
Work Space in the Center of an Intersection	105
Work in Single-Lane and Center Line - Two Flaggers	106
Work in One-Lane - Two Flaggers	107
Work in Single-Lane - One Flagger	108
Self-Regulating Stop Control	111
Work in One-Lane with Pilot Vehicle - Two Flaggers	117
Self-Regulating Lane Shift into Opposing Lane	118
Work in Adjacent Lanes with Opposing Traffic - Two Flaggers	120
Self-Regulating Lane Shift into Center Left-Turn Lane	121
Work in Center Left-Turn Lane	122
Work within One Quadrant of a Roundabout	131
Work on One Leg Entering a Roundabout	132
Work on One Leg Exiting a Roundabout	133

Work on Multi-Lane Approach	
Work in Two Lanes, Same Direction - Two Flaggers	119
Work in Right Lane - Undivided Highway	123-A
Work in Left Lane - Undivided Highway	123-B
Work in Two Lanes, Same Direction (Lane Shift into Opposing Lane)	124
Work in Right Lane - Divided Highway	125-A
Work in Left Lane - Divided Highway	125-B
Work in Right Lane and on Lane Line	126-A
Work in Left Lane and on Lane Line	126-B
Work in Right Two Lanes (Lane Shift into Adjacent Lane)	127-A
Work in Left Two Lanes (Lane Shift into Adjacent Lane)	127-B

Road Closure with Detour	
Standard Orange Detour Signs	116-A
Red Arrow Detour Signs (ADT <1500)	116-B

Work Space Located on Sidewalks	
Sidewalk Closed with Pedestrian Detour	128
Sidewalk Closed with Pedestrian Diversion	129
Sidewalk and Crosswalk Closure with Pedestrian Detour	130

PATA 100 Series Index

Short-Term Stationary Operations on Conventional Highways

PATA Description	PATA Number
Lane Closure Ending at a T-Intersection	
Approaching a Stop Sign - Two Flaggers	109-A
Approaching a Stop Sign - Three Flaggers	109-B
Approaching All-way Stop - Two Flaggers	109-C
Approaching All-way Stop - Three Flaggers	109-D
Approaching Traffic Signal - Two Flaggers	109-E
Approaching Traffic Signal - Three Flaggers	109-F

Lane Closure Beginning at a T-Intersection	
Departing the Intersection - Two Flaggers	109-G
Departing the Intersection - Three Flaggers	109-H
Departing an All-way Stop - Two Flaggers	109-I
Departing an All-way Stop - Three Flaggers	109-J
Departing a Traffic Signal - Two Flaggers	109-K
Departing a Traffic Signal - Three Flaggers	109-L

Lane Closure Ending at a 4-Way Intersection	
Approaching an Intersection with Stop Signs on Side Roads - Two Flaggers	110-A
Approaching an Intersection with Stop Signs on Side Roads - Four Flaggers	110-B
Approaching an Intersection with Uncontrolled Side Roads - Two Flaggers	110-C
Approaching an Intersection with Uncontrolled Side Roads - Four Flaggers	110-D
Approaching an All-Way Stop Intersection - Two Flaggers	110-E
Approaching an All-Way Stop Intersection - Four Flaggers	110-F
Approaching a Yellow Flashing Traffic Signal - Two Flaggers	110-G
Approaching a Yellow Flashing Traffic Signal - Four Flaggers	110-H
Approaching a Red Flashing Traffic Signal - Two Flaggers	110-I
Approaching a Red Flashing Traffic Signal - Four Flaggers	110-J

Lane Closure Beginning at a 4-Way Intersection	
Departing an Intersection with Stop Signs on Side Roads - Two Flaggers	110-K
Departing an Intersection with Stop Signs on Side Roads - Four Flaggers	110-L
Departing an Intersection with Uncontrolled Side Roads - Two Flaggers	110-M
Departing an Intersection with Uncontrolled Side Roads - Four Flaggers	110-N
Departing an All-Way Stop Intersection - Two Flaggers	110-O
Departing an All-Way Stop Intersection - Four Flaggers	110-P
Departing a Yellow Flashing Traffic Signal - Two Flaggers	110-Q
Departing a Yellow Flashing Traffic Signal - Four Flaggers	110-R
Departing a Red Flashing Traffic Signal - Two Flaggers	110-S
Departing a Red Flashing Traffic Signal - Four Flaggers	110-T

Flagger Control with AFAD	
Flagger on Closed Lane Approach, AFAD at Other End	112
AFAD on Closed Lane Approach, Flagger at Other End	113
AFADs with Two Operators	114
AFADs with One Operator	115

PATA 200 Series Index
Long-Term Stationary Operations on Conventional Highways

PATA Description	PATA Number
Work Beyond the Shoulder	
Single-Lane Approach	201-A
Multi-Lane Approach - Right Shoulder	201-B
Multi-Lane Approach - Left Shoulder	201-C
Work on the Shoulder	
Single-Lane Approach	202-A
Multi-Lane Approach - Right Shoulder	202-B
Multi-Lane Approach - Left Shoulder	202-C
Single-Lane Approach With Roadway Encroachment	203
Work on a Single-Lane Approach	
Work Space in Center of Roadway	204
Self-Regulating Stop Control	205
Lane Shift into Opposing Lane	206
Lane Shift into Center Left-Turn Lane	207
Work in Center Left-Turn Lane	208
Work on a Multi-Lane Approach	
Work in Right Lane	209-A
Work in Left Lane	209-B
Work in Two Lanes, Same Direction (Lane Shift Into Opposing Lane)	210
Work in Right Lane of One-Way Roadway	211-A
Work in Left Lane of One-Way Roadway	211-B
Work in Right Lane with Left Lane Encroachment - Shoulder Used as Lane	212-A
Work in Left Lane with Right Lane Encroachment - Shoulder Used as Lane	212-B
Work in Right Two Lanes	213-A
Work in Left Two Lanes	213-B
Road Closure with Detour	
Detour of a Numbered Traffic Route	214
Detour of a Quadrant Route	215
Work Space Located on Sidewalks	
Sidewalk Closed with Pedestrian Detour	216
Sidewalk Closed with Pedestrian Diversion	217
Sidewalk and Crosswalk Closure with Pedestrian Detour	218
Crosswalk Closure with Pedestrian Detour	219

PATA 300 Series Index
Mobile Operations on Conventional Highways

PATA Description	PATA Number
Work on or Beyond the Shoulder	
Single-Lane Approach	301-A
Multi-Lane One-Way Approach - Right Shoulder	301-B
Multi-Lane Approach - Left Shoulder	301-C
Mowing Where Tractor Remains on or Beyond Shoulder	307

Work on Single-Lane Approach	
Two-Lane, Two-Way Approach - Mobile Flagging	302
Temporary Work Stoppage/Slowdown (Figure 302-1)	
Flagger Relocation - Walking (Figure 302-2 through 302-5)	
Flagger Relocation - Riding in Work Vehicle (Figure 302-6 through 302-9)	
Flagger Relocation - Riding in Pilot Vehicle (Figure 302-10 through 302-13)	
Workers Remain in Vehicles Throughout Operation	303

Work on Multi-Lane Approach	
Work in Right Lane - Undivided Highway	304-A
Work in Left Lane - Undivided Highway	304-B
Work in Right Lane - Divided Highway	305-A
Work in Left Lane - Divided Highway	305-B
Work in Right Lane of 3 Lane Approach	306-A
Work in Left Lane of 3 Lane Approach	306-B
Work in Center Lane of 3 Lane Approach	306-C
Mowing Where Tractor Utilizes the Roadway to Perform Operations	307

PATA 400 Series Index
Short-Term Stationary Operations on Freeways & Expressways

PATA Description	PATA Number
Work on or Beyond the Shoulder	
Work on Right Side	401-A
Work on Left Side	401-B
Work on Two-Lane Approach	
Work in Right Lane	402-A
Work in Left Lane	402-B
Work in All Lanes Requiring a Rolling Slow Down or Stoppage	408
Work on Three-Lane Approach	
Work in Right and Center Lanes	403-A
Work in Left and Center Lanes	403-B
Work Near Interchange Ramps	
Work in Right Lane Near Right-Exit Ramp	404-A
Work in Left Lane Near Left-Exit Ramp	404-B
Work in Right Lane Near Right-Entrance Ramp with YIELD Control	405-A
Work in Left Lane Near Left-Entrance Ramp with YIELD Control	405-B
Work in Right Lane Near Right-Entrance Ramp with STOP Control	406-A
Work in Left Lane Near Left-Entrance Ramp with STOP Control	406-B
Work on Ramp Shoulder (May Have Roadway Encroachment)	407
Freeway Closure	
Work Closes All Lanes - All Traffic Must Use Right-Exit	409-A
Work Closes All Lanes - All Traffic Must Use Left-Exit	409-B

PATA 500 Series Index
Long-Term Stationary Operations on Freeways & Expressways

PATA Description	PATA Number
Work Beyond the Shoulder	
Work on Right Side	501-A
Work on Left Side	501-B
Work on the Shoulder	
Work on Right Shoulder	502-A
Work on Left Shoulder	502-B
Work on Two-Lane Approach	
Work in Right Lane	503-A
Work in Left Lane	503-B
Two Lanes Shift Utilizing Left Shoulder	508-A
Two Lanes Shift Utilizing Right Shoulder	508-B
Work on Three-Lane Approach	
Work in Right and Center Lanes	504-A
Work in Left and Center Lanes	504-B
Work Near Interchange Ramps	
Work in Right Lane Near Right-Exit Ramp	505-A
Work in Left Lane Near Left-Exit Ramp	505-B
Work in Right Lane Near Right-Entrance Ramp with YIELD Control	506-A
Work in Left Lane Near Left-Entrance Ramp with YIELD Control	506-B
Work in Right Lane Near Right-Entrance Ramp with STOP Control	507-A
Work in Left Lane Near Left-Entrance Ramp with STOP Control	507-B

PATA 600 Series Index
Mobile Operations on Freeways & Expressways

PATA Description	PATA Number
Work on or Beyond the Shoulder	
Work on Right or Left Side	601
Mowing (Tractor Remains on or Beyond Shoulder)	604
Work on Two-Lane Approach	
Work in Right Lane	602-A
Work in Left Lane	602-B
Work on Three-Lane Approach	
Work in Right Lane	603-A
Work in Left Lane	603-B
Work in Two Lanes (Right & Center or Left & Center)	603-C

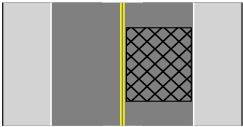



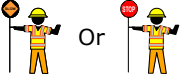














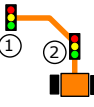


PATA 700 Series Index
TTC Signal Operations

PATA Description	PATA Number
Short-Term Operation with Non-Complex Conditions	
Pedestal-Mounted Signals	701
Trailer-Mounted Signals	702
Short-Term Operation with Complex Conditions	
Pedestal-Mounted Signals	703
Trailer-Mounted Signals	704
Long-Term Operation with Non-Complex or Complex Conditions	
Overhead Signals on Fixed Supports with Span Wire	705
Trailer-Mounted Signals	706

**PATA 800 Series Index
Hauling Operations**

PATA Description	PATA Number
Permitted Hauling Operation	
Two-Lane, Two-Way Conventional Highways	801
Multi-Lane Highways Where Passing is Allowed	802
Multi-Lane Highways Where Passing is Prohibited	803
Highways with Three Lanes in One Direction	804
Highways with More than Three Lanes in One Direction	805

PATA/GA Symbols

 <p>Work space (hatched area)</p>	 <p>SV Shadow Vehicle equipped with a TMA and Arrow Board in Merge Mode</p>
 <p>Direction of traffic flow (arrows)</p>	 <p>SV Shadow Vehicle equipped with a TMA</p>
 <p>Flagger with Stop/Slow Paddle</p>	 <p>SV Shadow Vehicle without a TMA</p>
 <p>Flagger with Red Flag</p>	 <p>PV Pilot Vehicle equipped with a flashing or revolving yellow light and G20-4 sign (PILOT CAR FOLLOW ME)</p>
 <p>Flagger Location</p>	 <p>WV Work Vehicle equipped with a flashing or revolving yellow light</p>
 <p>Channelizing Devices</p>	 <p>Mower equipped with a flashing or revolving yellow light</p>
 <p>Channelizing Devices With Sequential Flashing Lights</p>	 <p>PCMS Portable Changeable Message Sign on trailer</p>
 <p>Sign Location</p>	 <p>Flashing Arrow Board on trailer</p>
 <p>Type III Barricade</p>	 <p>Flashing Arrow Board (Merge Mode)</p>
 <p>Automated Flagger Assistance Device (AFAD)</p>	 <p>Flashing Arrow Board (Caution Mode)</p>
 <p>Type B flashing light (red) Type B flashing light (yellow) Type B flashing light (white)</p>	 <p>Portable Traffic Signal on Trailer (circles contain signal head number)</p>
 <p>Longitudinal Channelizing Device (e.g. water-filled barrier)</p>	 <p>Portable Traffic Signal on Pedestal (circles contain signal head number)</p>

PATA/GA Reference Charts

Sign Spacing, Channelizing Device Spacing, Buffer Space, and Roll Ahead Spaces									
Speed	Channelizing Devices Spacing	Sign Spacing						Buffer Space	Roll Ahead Space
		Conventional		Freeways and Expressways					
		Urban	Rural	A	B	C	D		
S (MPH)	2S (Feet)	A (Feet)	A (Feet)	A (Feet)	B (Feet)	C (Feet)	D (Feet)	E (Feet)	H (Feet)
25	50	100 - 200	500 - 800	-	-	-	-	155	150
30	60	100 - 200	500 - 800	-	-	-	-	200	150
35	70	100 - 200	500 - 800	-	-	-	-	250	150
40	80	350 - 500	500 - 800	1000	1640	2640	5280	305	150
45	90	350 - 500	500 - 800	1000	1640	2640	5280	360	150
50	100	350 - 500	500 - 800	1000	1640	2640	5280	425	250
55	110	350 - 500	500 - 800	1000	1640	2640	5280	495	250
60	120	-	-	1000	1640	2640	5280	570	250
65	130	-	-	1000	1640	2640	5280	645	250
70	140	-	-	1000	1640	2640	5280	730	250

Taper Lengths and Minimum Number of Channelizing Devices									
Speed	Merging Taper: L		Shifting Taper: 1/2L		Shoulder Taper: 1/3L		50' Per Lane Taper		
S (MPH)	Length (Feet)	Minimum Number Of Devices	Length (Feet)	Minimum Number Of Devices	Length (Feet)	Minimum Number Of Devices	Length (Feet)	Minimum Number Of Devices	
25	125	6	65	6	45	6	50	6	
30	180	7	90	6	60	6	50	6	
35	245	8	125	6	85	6	50	6	
40	320	9	160	6	110	6	50	6	
45	540	13	270	7	180	6	50	6	
50	600	13	300	7	200	6	50	6	
55	660	13	330	7	220	6	50	6	
60	720	13	360	7	240	6	50	6	
65	780	13	390	7	260	6	50	6	
70	840	13	420	7	280	6	50	6	

Taper Length Formulas						
Taper lengths shown on PATA Notes pages are based upon a full-lane offset (12'). Field conditions may justify a shorter taper length if the offset is less than 12'. Use these formulas to determine required taper length for any offset distance.	<table border="1" style="width: 100%; border-collapse: collapse;"> <tr> <td style="padding: 2px;">S=40 MPH or less</td> <td style="padding: 2px;">$L = \frac{WS^2}{60}$</td> </tr> <tr> <td style="padding: 2px;">S=45 MPH or more</td> <td style="padding: 2px;">L = WS</td> </tr> </table>	S=40 MPH or less	$L = \frac{WS^2}{60}$	S=45 MPH or more	L = WS	S = Regulatory Speed Limit (MPH) W = Width of Offset (feet) L = Length of Taper (feet)
S=40 MPH or less	$L = \frac{WS^2}{60}$					
S=45 MPH or more	L = WS					

Blank Page

General Applications

General Application 01-A Component Parts of a TTC Zone Two-Way Roadway

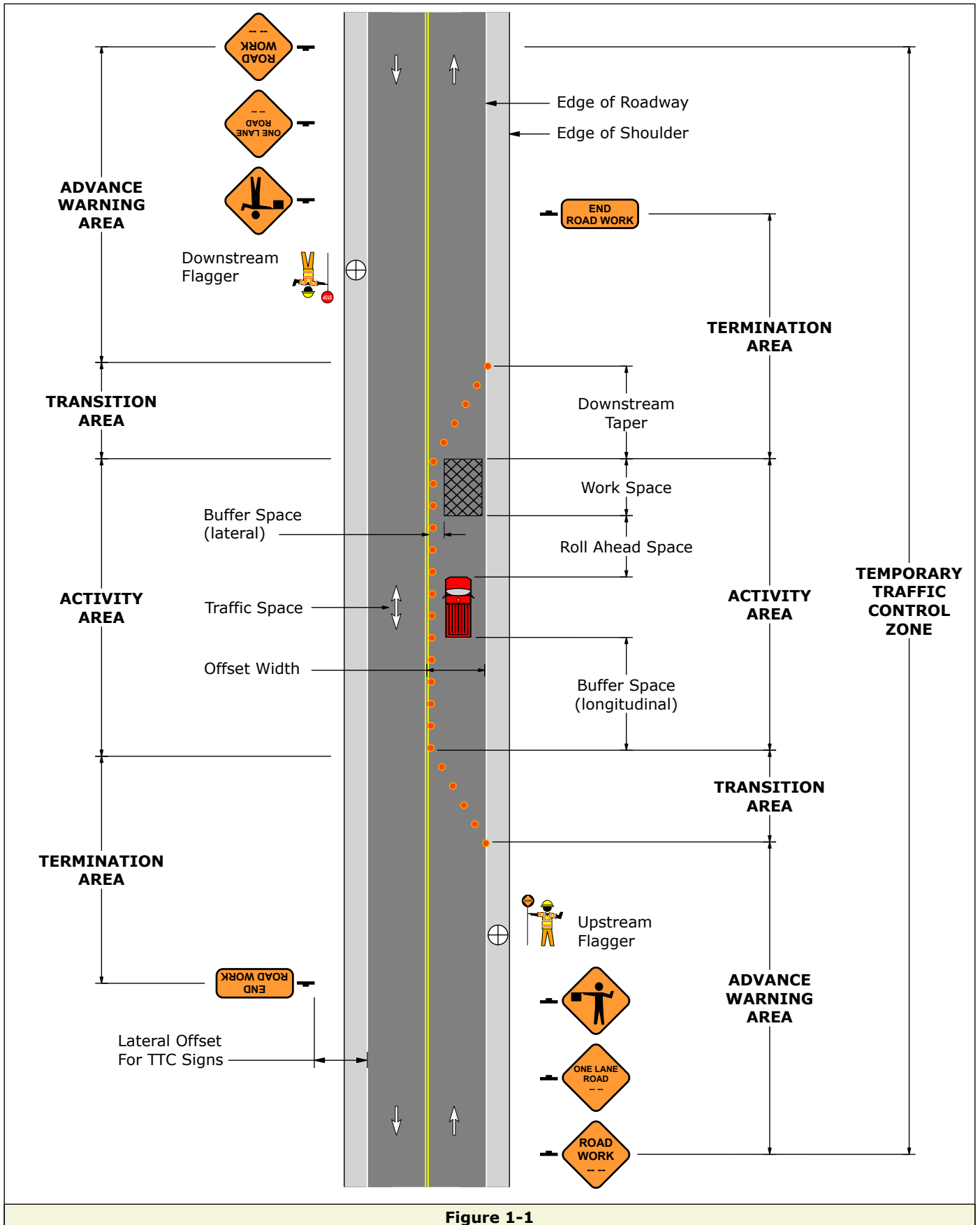


Figure 1-1

General Application 01-B Component Parts of a TTC Zone One-Way Roadway

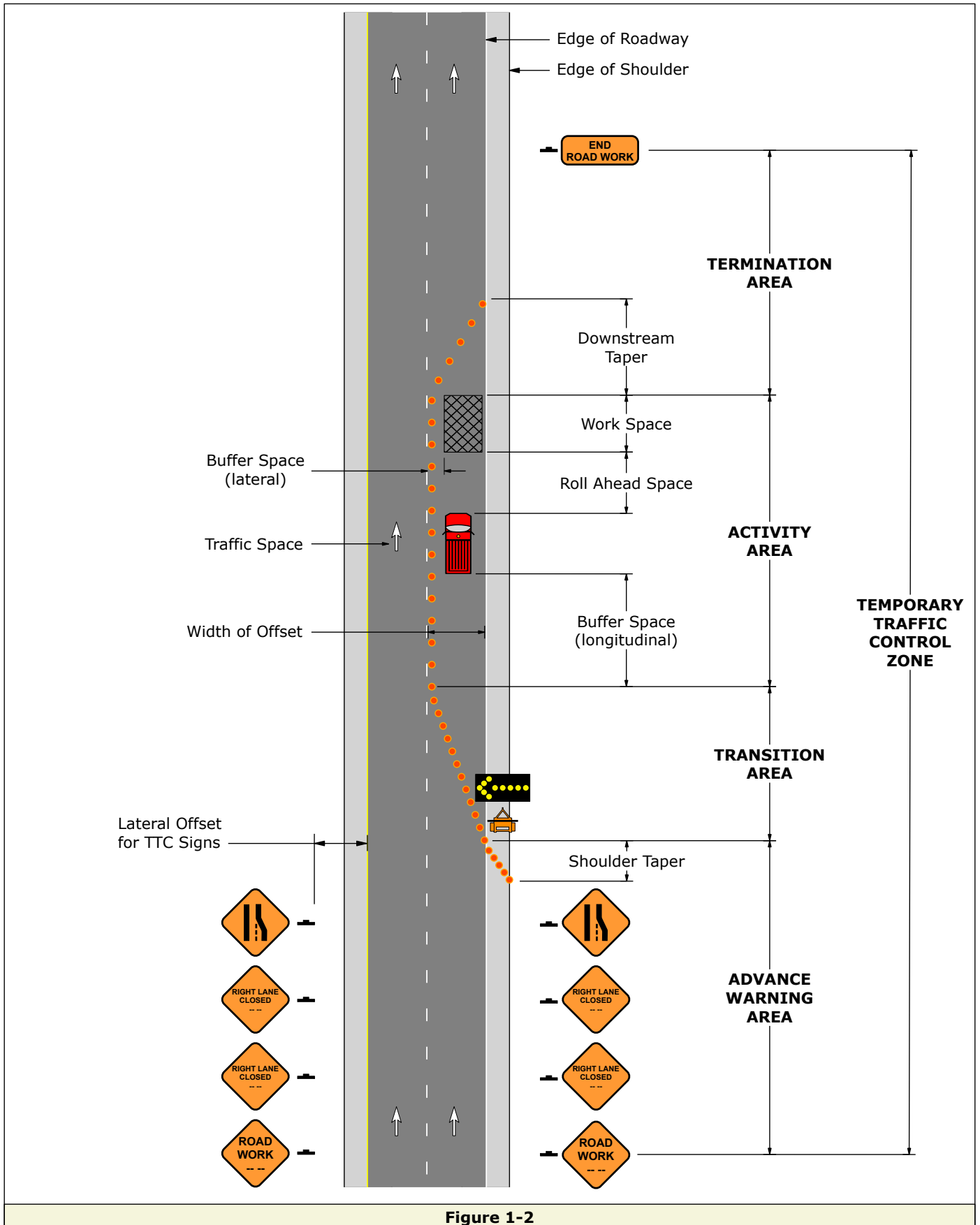
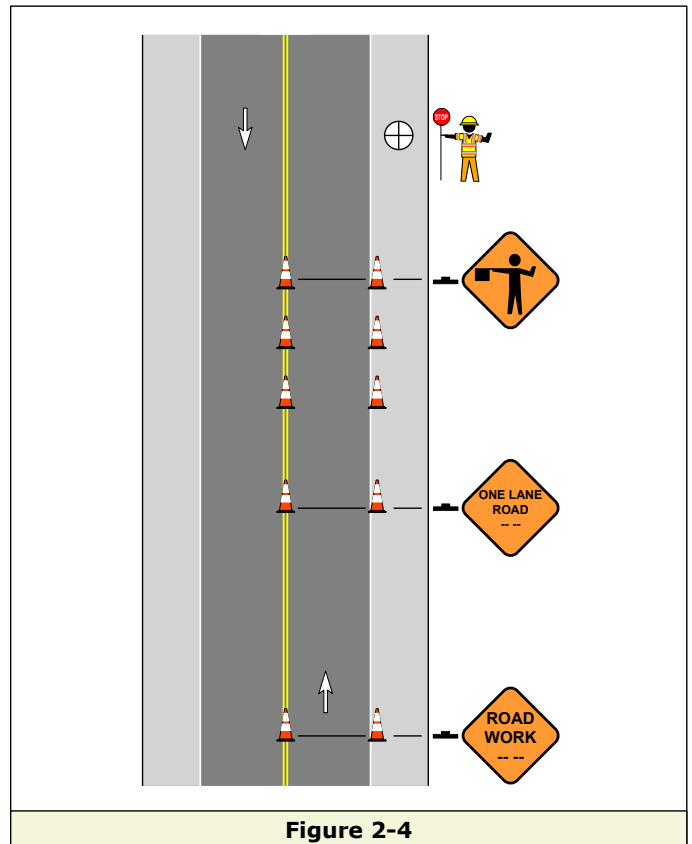
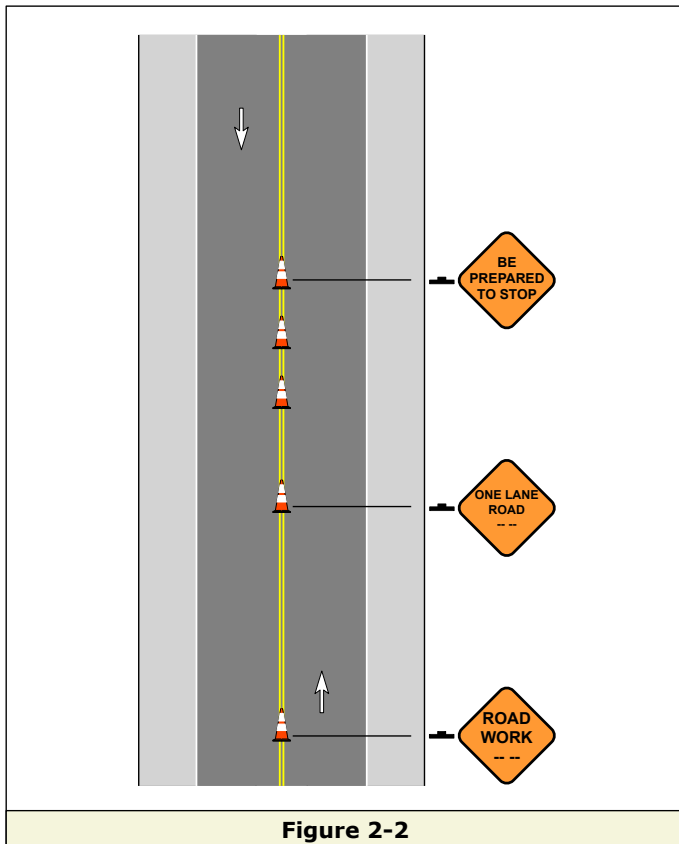
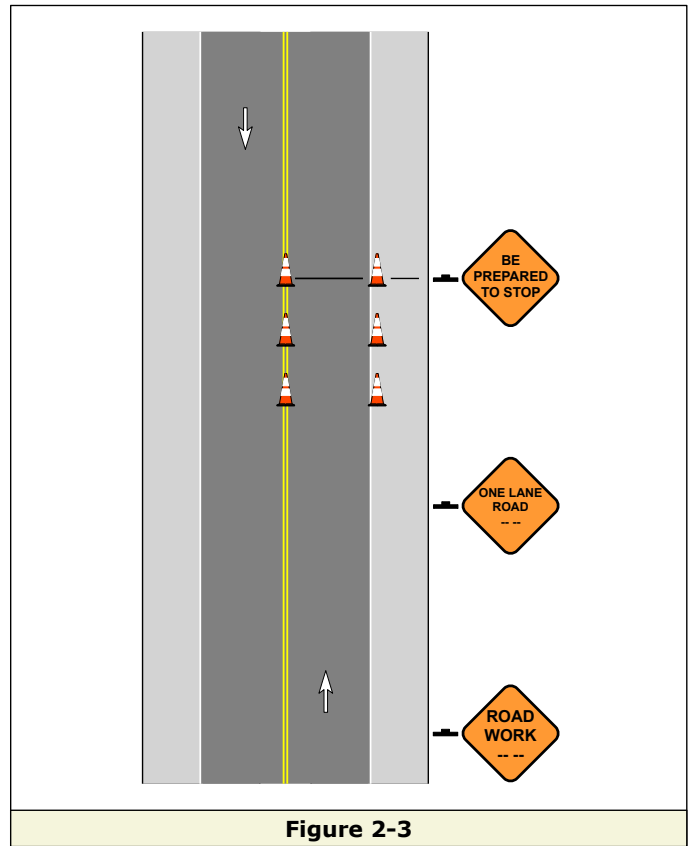
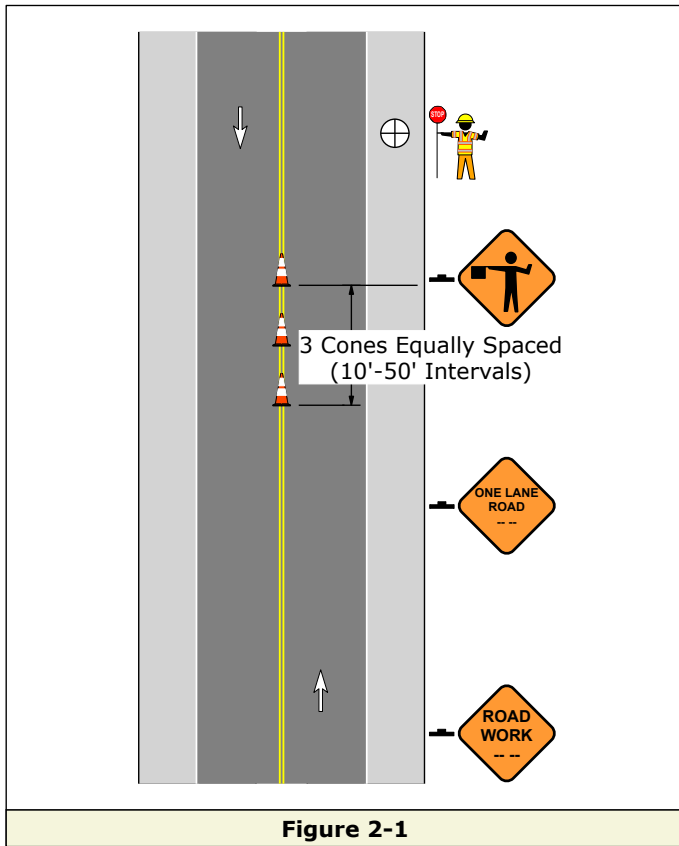


Figure 1-2

General Application 02 Cone Placement within the Advance Warning Area




1. General Application 02 provides guidance for optional cone placement within the advance warning area.

General Application 02 Cone Placement within the Advance Warning Area

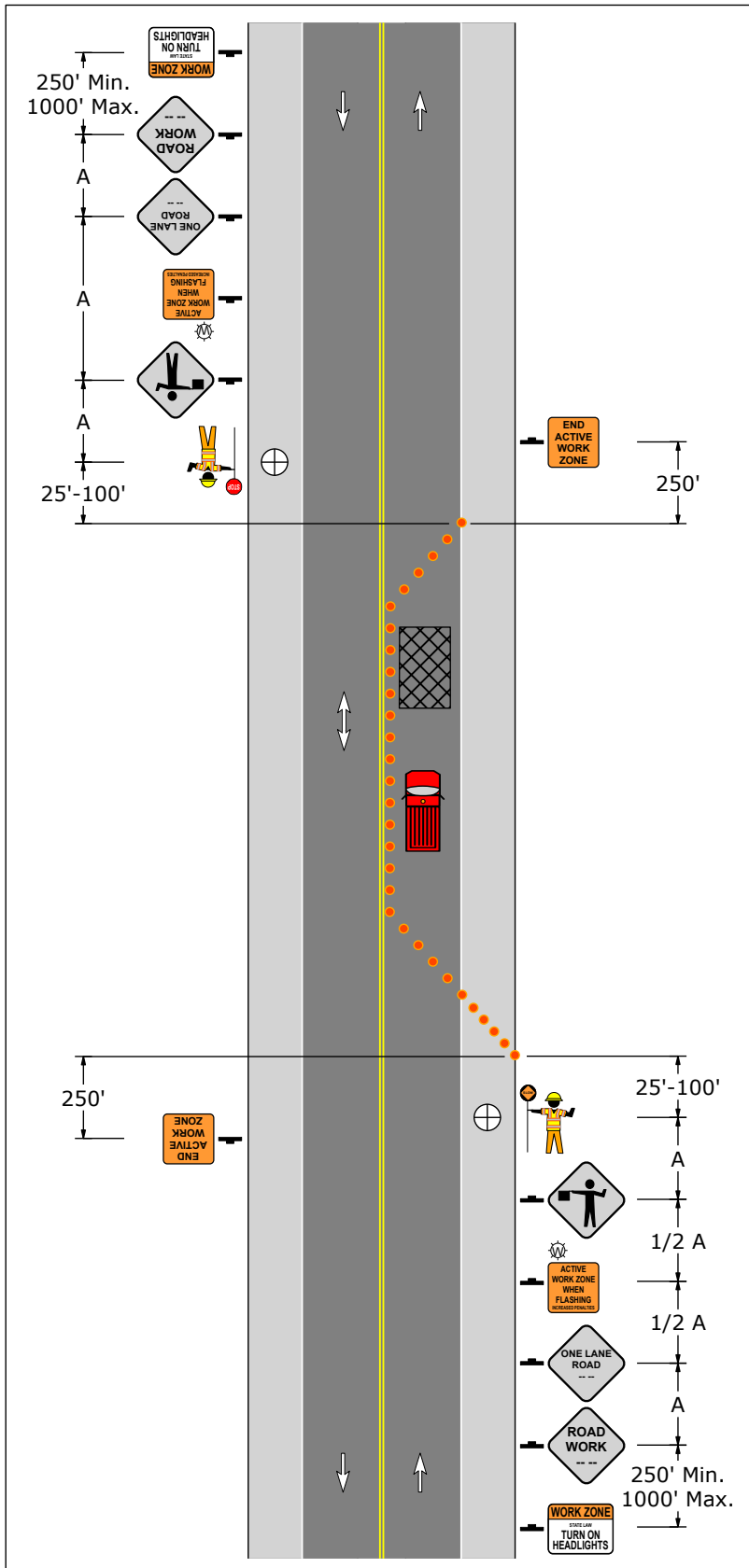


General Application 03 Act 229 TTC Signs

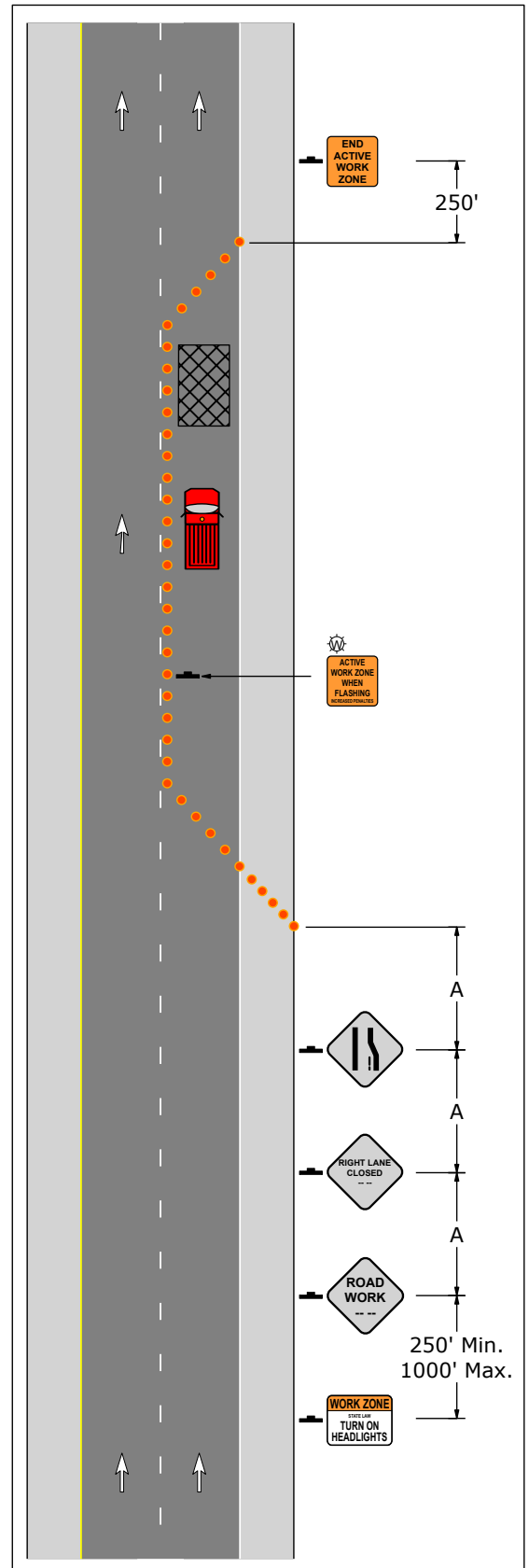
1. General Application 03 provides guidance on how to incorporate Act 229 signs on conventional highways and freeways and expressways.
2. The installation of the WORK ZONE-TURN ON HEADLIGHTS sign, ACTIVE WORK ZONE WHEN FLASHING sign, END ACTIVE WORK ZONE sign, and the flashing white light is not required for any of the following situations:
 - a) Mobile operations
 - b) Operations 1 hour or less in duration.
 - c) Stationary work where the daily duration of the construction, maintenance, or utility operation is less than 12 hours and all traffic control devices are removed from the highway at the completion of the daily operation.
 - d) The normal speed limit is 45 MPH or less.
 - e) The work is in response to an emergency condition.
3. Erect the WORK ZONE-TURN ON HEADLIGHTS sign as the first sign on each primary approach to the TTC zone at a distance of 250'-1000' prior to the first warning sign.
4. Erect the ACTIVE WORK ZONE WHEN FLASHING sign with a Type B white flashing light on each approach to an active work zone. If flaggers are present, place the signs in the advance warning area. If flaggers are not present, place the signs as close as practical to the active work space where workers are located.
5. When multiple active work zones are separated by a distance of more than 1 mile, erect a sign on each approach.
6. The Type B white flashing light attached to the ACTIVE WORK ZONE WHEN FLASHING sign shall be activated only when workers are present. The light shall be deactivated when work activity is not anticipated during the next 60 minutes.
7. When the TTC zone is on a freeway or expressway, appropriate Act 229 signing and lights shall be installed at on-ramp approaches to the work zone.
8. The END ACTIVE WORK ZONE sign is not required if an END ROAD WORK sign is posted.

Signs		
		
R22-1	W21-19	W21-20

General Application 03 Act 229 TTC Signs



**Figure 3-1
Two-Way Roadway**



**Figure 3-2
One-Way Roadway**

General Application 04-A Temporary Portable Rumble Strips Conventional Highways

1. General Application 04-A provides guidance on how to incorporate Temporary Portable Rumble Strips on conventional highways when flaggers are present.
2. TPRS shall only be utilized for lane closures during short-term operations while workers are present.
3. Do not use TPRS when the air temperature is less than 40 degrees Fahrenheit.
4. When installing TPRS, begin at the roadway centerline and continue across to the right. TPRS shall extend across the entire lane width. Any excess portion of the TPRS can be placed beyond the edge line onto the shoulder.
5. All TPRS must be the same color. The color may be black, white, or orange.



General Application 04-A Temporary Portable Rumble Strips Conventional Highways

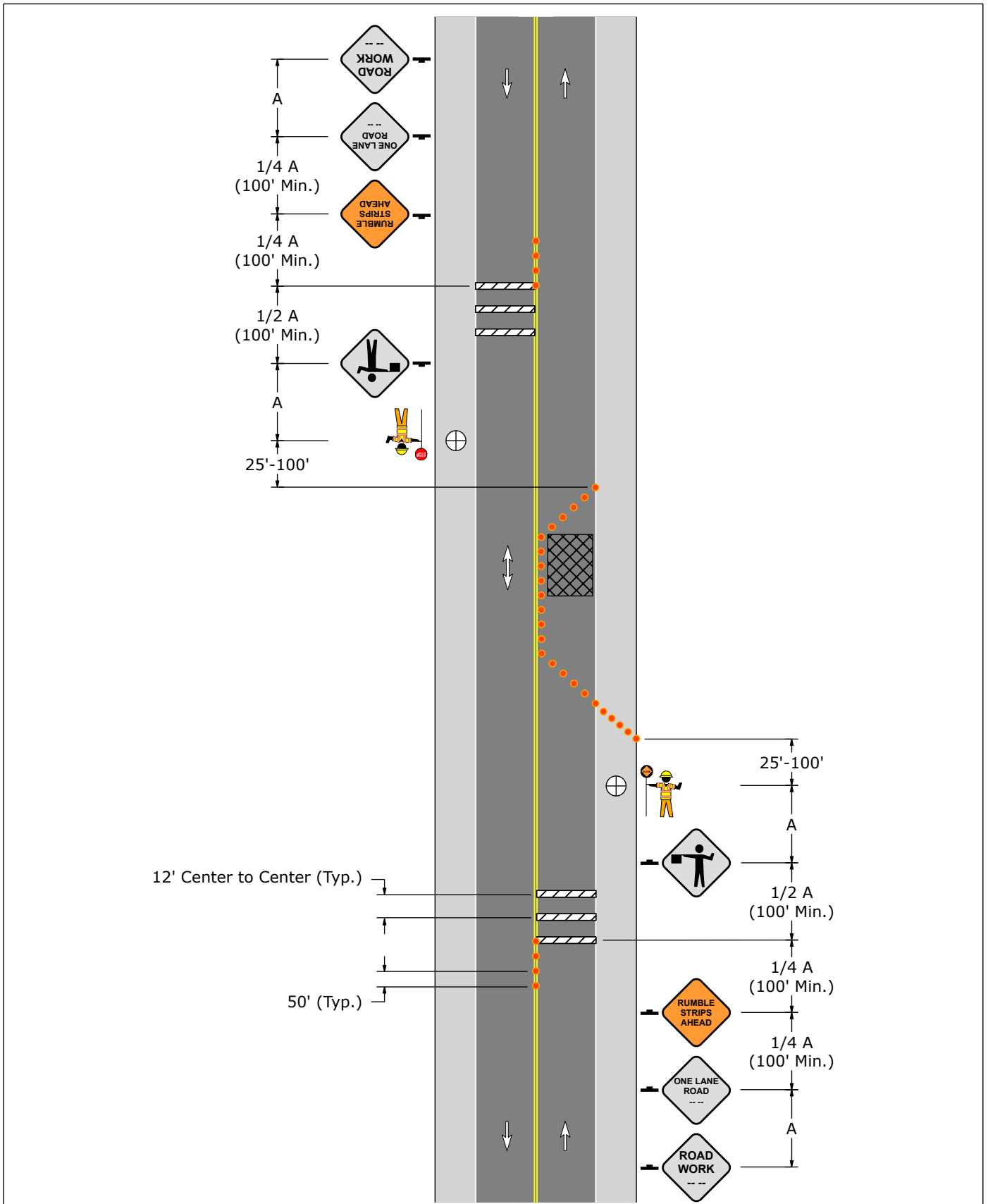





Figure 4-1





General Application 04-B Temporary Portable Rumble Strips Freeways and Expressways

1. General Application 04-B provides guidance on how to incorporate Temporary Portable Rumble Strips on freeways and expressways.
2. TPRS shall only be utilized for lane closure during short-term operations while workers are present.
3. TPRS array consists of three transversely placed rumble strips evenly spaced.
 - a) Space at 20' on center for speeds of 50 MPH and greater.
 - b) Space at 10' on center for speeds of 45 MPH or less.
4. Place the RUMBLE STRIPS AHEAD sign prior to placing TPRS.
5. Remove TPRS prior to removing advance warning signs.
6. Reset TPRS as necessary to maintain proper alignment, spacing, and location. If traffic is observed to be queuing or is expected to queue beyond the TPRS, the RUMBLE STRIPS AHEAD sign and TPRS may be relocated upstream as necessary to provide adequate warning.
7. Do not use TPRS on horizontal curves.
8. Do not use TPRS on slippery surfaces (such as wet or sandy pavement), loose gravel, heavily rutted pavements, or unpaved surfaces.
9. In the activity area, place the TPRS array midway between the taper's end and the beginning of the work space.
10. Do not use TPRS when the air temperature is less than 40 degrees Fahrenheit.
11. All TPRS must be the same color. The color may be black, white, or orange.

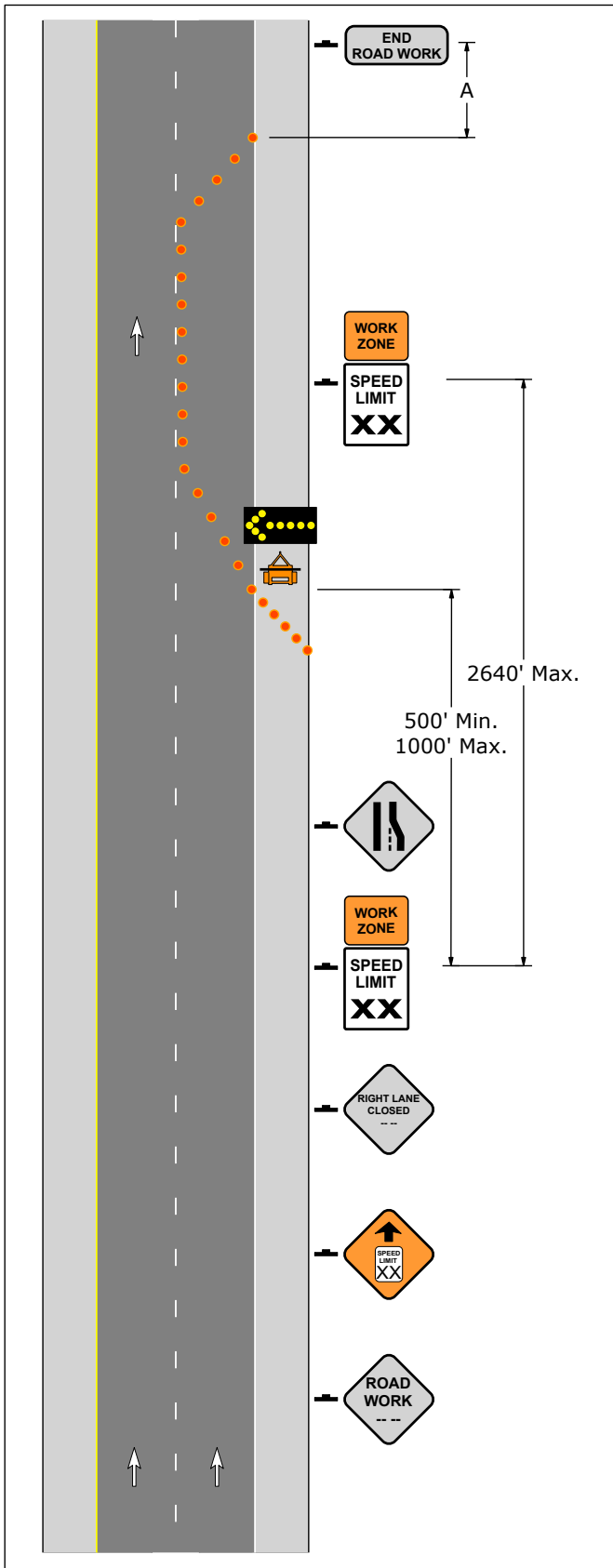
Signs		
		
W8-101	W99-1	W16-7P

General Application 05 Work Zone Speed Limit Sign Placement

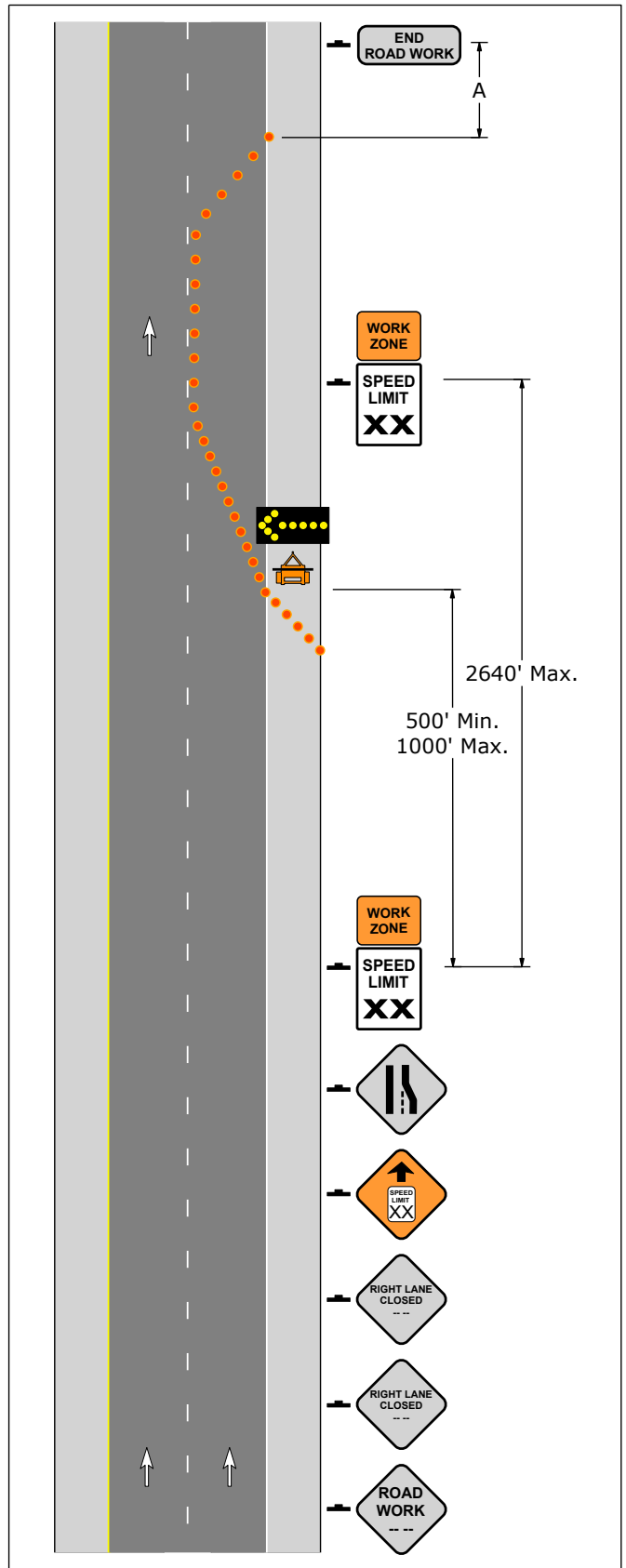
1. General Application 05 provides guidance on how to incorporate regulatory SPEED LIMIT signs within a typical TTC Zone when a reduced work zone speed limit is permitted. When the normal speed limit is reduced by more than 10 MPH, the SPEED REDUCTION warning sign is required.
2. Complete the PennDOT TE-162 form prior to posting a reduced regulatory speed limit.
3. PATA 126 (Figure 5-1) is used to illustrate conventional highways and PATA 402 (Figure 5-2) is used to illustrate freeways and expressways. Sign placement is similar with other PATA plans. The speed limit value and TTC signs may vary. The following sign installation requirements apply to TTC speed limits:
 - a) The first regulatory SPEED LIMIT sign must be installed on the right side of the roadway between 500' and 1000' in advance of the activity area.
 - b) Additional regulatory SPEED LIMIT signs must be posted downstream on the right side of the roadway with maximum 1/2 mile intervals.
 - c) All conflicting SPEED LIMIT signs shall be covered.
 - d) An END ROAD WORK sign must be installed.
 - e) Variable speed limit signs may be used in lieu of a static SPEED LIMIT signs.
4. A reduced work zone speed limit should not be installed for the entire length of the activity area if work is confined to only a portion of the total area at any one time. The reduced speed limit should only cover the area approaching and the area through which work is in progress.
5. An orange WORK ZONE sign may be mounted above a regulatory SPEED LIMIT sign to emphasize that a reduced work zone speed limit is in effect, however the WORK ZONE sign is not required to have an enforceable work zone speed limit.
6. Where variable speed limit signs or speed display trailers are used:
 - a) An appropriately sized Speed Limit (R2-1) sign shall be displayed adjacent to the speed display board.
 - b) Flashing lights, if used, shall be white.
 - c) Numbers within the display shall not flash.
7. SPEED LIMIT signs with white LED Lights within the border may be used in lieu of conventional signs. If used:
 - a) LED lights shall flash only during the hours specified on the work zone speed limit permit; flashing lights indicate that the work zone speed limit is in effect.
 - b) LED lights shall be turned off and signs shall be covered, turned from view of traffic, or removed when the work zone speed limit is not in effect.

Signs			
			
G20-5AP	R2-1	R2-1 (LED)	W3-5

General Application 05 Work Zone Speed Limit Sign Placement



**Figure 5-1
Conventional Highways**



**Figure 5-2
Freeways & Expressways**

General Application 06 Intersection Approach Signing

1. General Application 06 provides guidance on how to sign side roads and driveways. STOP signs and traffic signals shown are understood to be permanent devices.

2. Place TTC signs along side roads and driveways in accordance with the following:

TTC Sign Placement Requirements for Side Roads and Driveways		
Roadway Type	Stationary Operation	Mobile Operation
Side Road (State or Municipal)	Required	Optional
Driveway (Public or Private)	Optional	Optional




3. Tapers at side roads and intersections shall be long enough to safely accommodate turning vehicles.

4. A ROAD WORK sign is required on each side road in a stationary TTC zone.

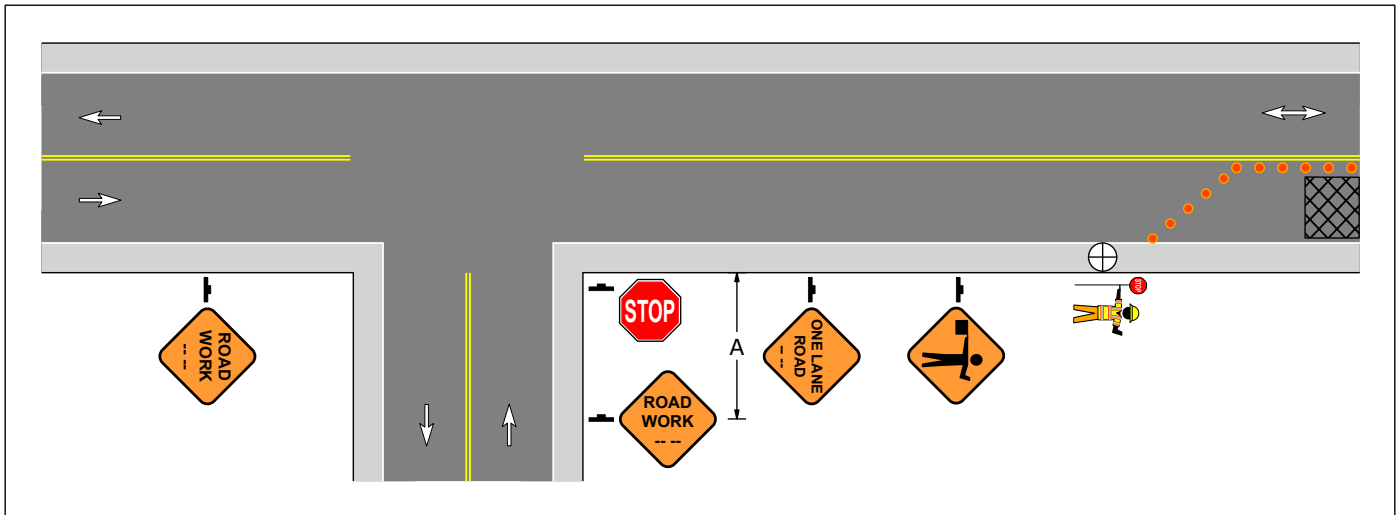
5. A FLAGGER SYMBOL sign is required on each side road in a stationary TTC zone if a flagger is controlling traffic at the intersection.

6. A BE PREPARED TO STOP sign is required on each side road in a stationary TTC zone if the following conditions apply:

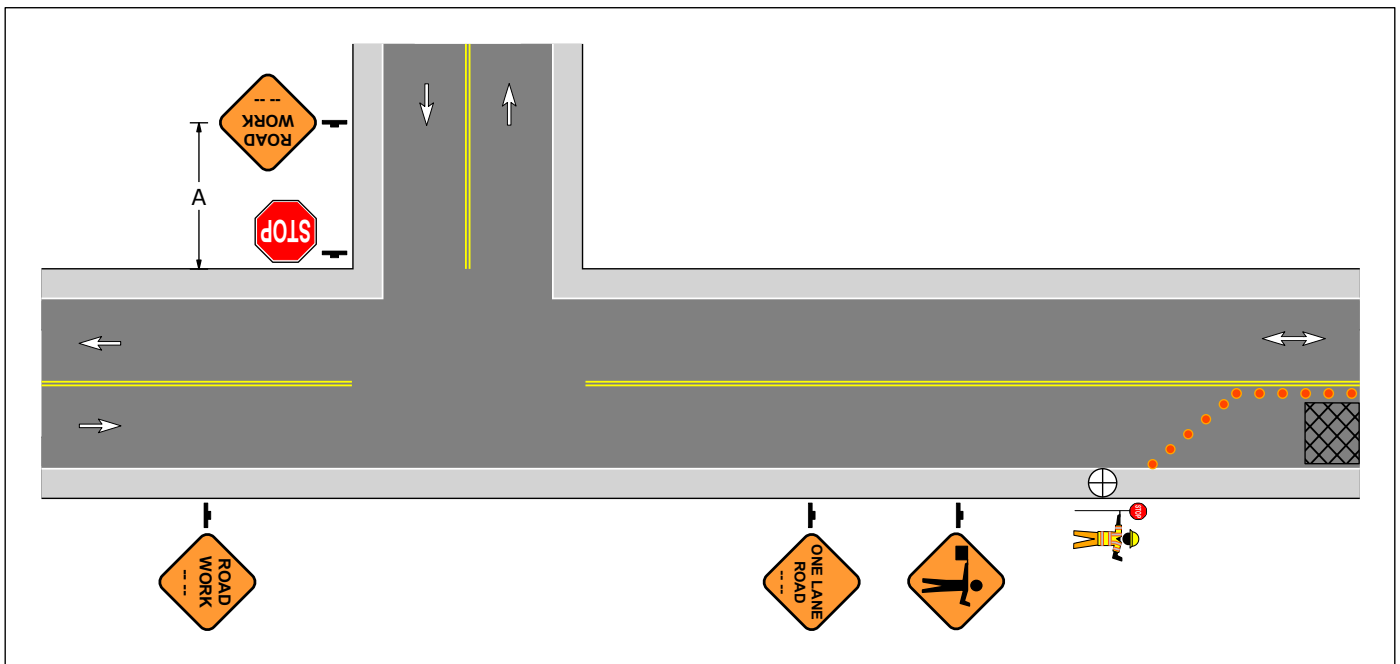
- The side road intersects the advance warning area between the FLAGGER SYMBOL sign and the flagger.
- The motorist on the side does not encounter a STOP sign, traffic signal, or flagger at the intersection.

Signs		
		
W20-1	W20-7	W3-4

**General Application 06
Intersection Approach Signing
Single Lane Approach**

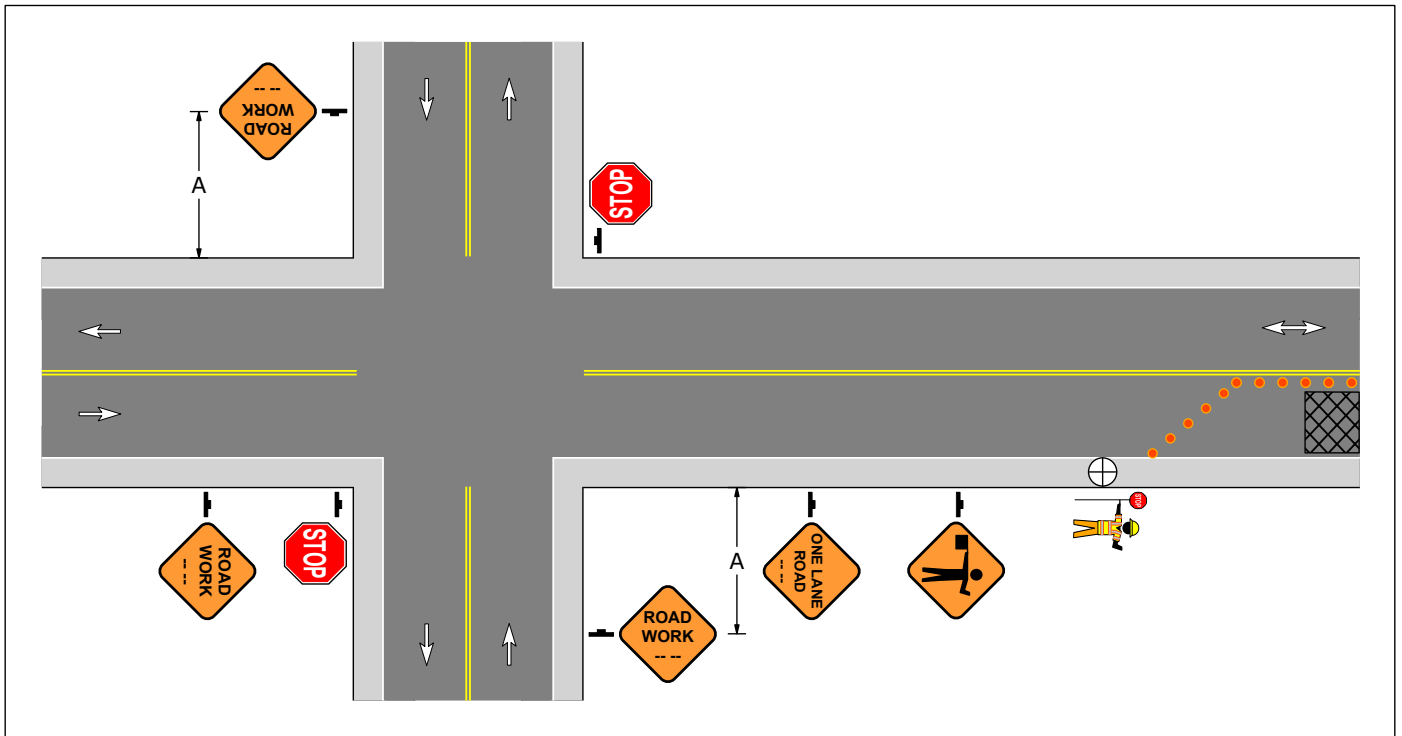


**Figure 6-1
Intersection within the Advance Warning Area**

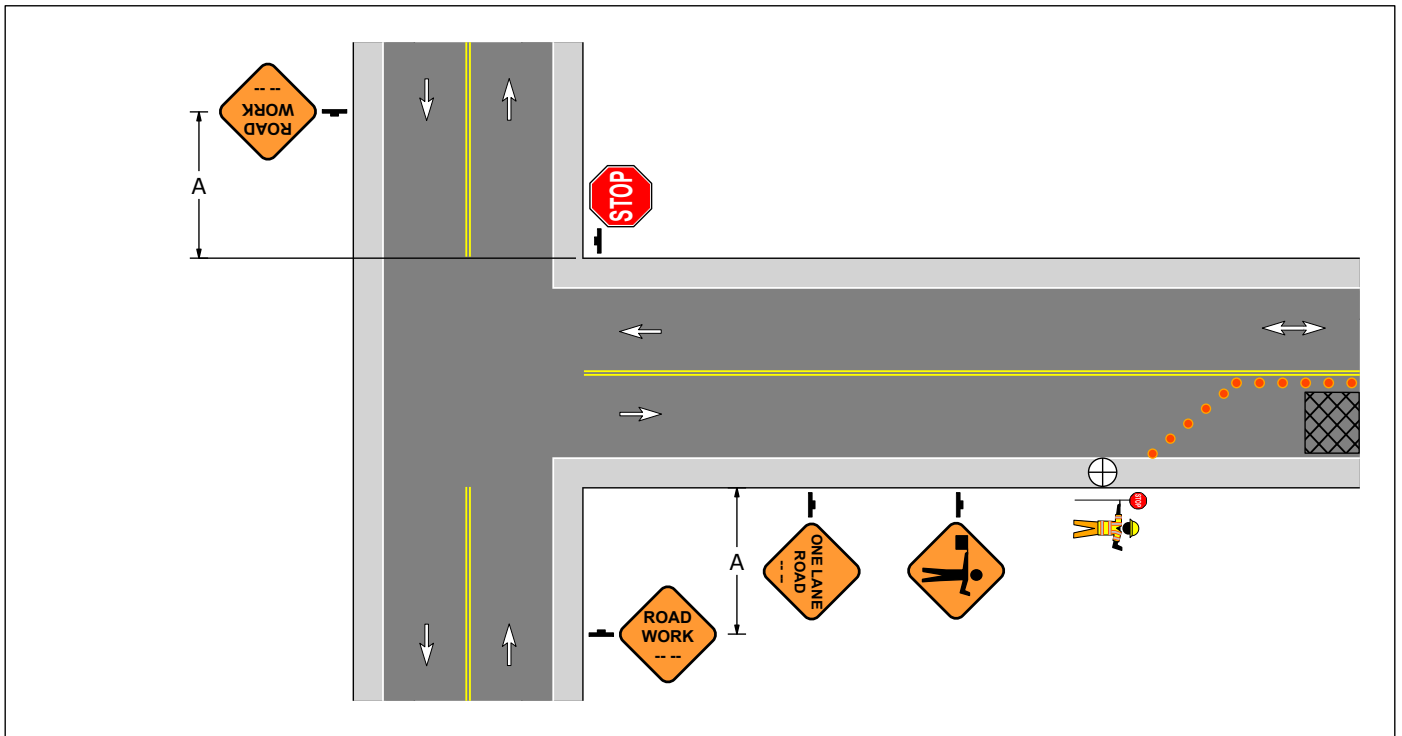


**Figure 6-2
Intersection within the Advance Warning Area**

**General Application 06
Intersection Approach Signing
Single Lane Approach**

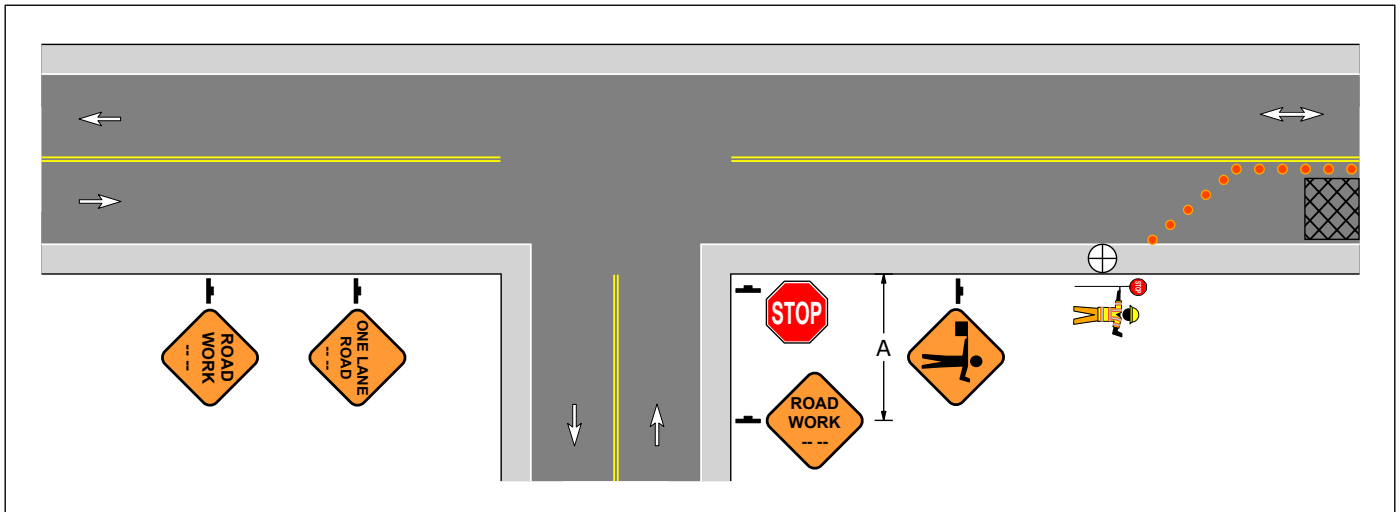


**Figure 6-3
Intersection within the Advance Warning Area**

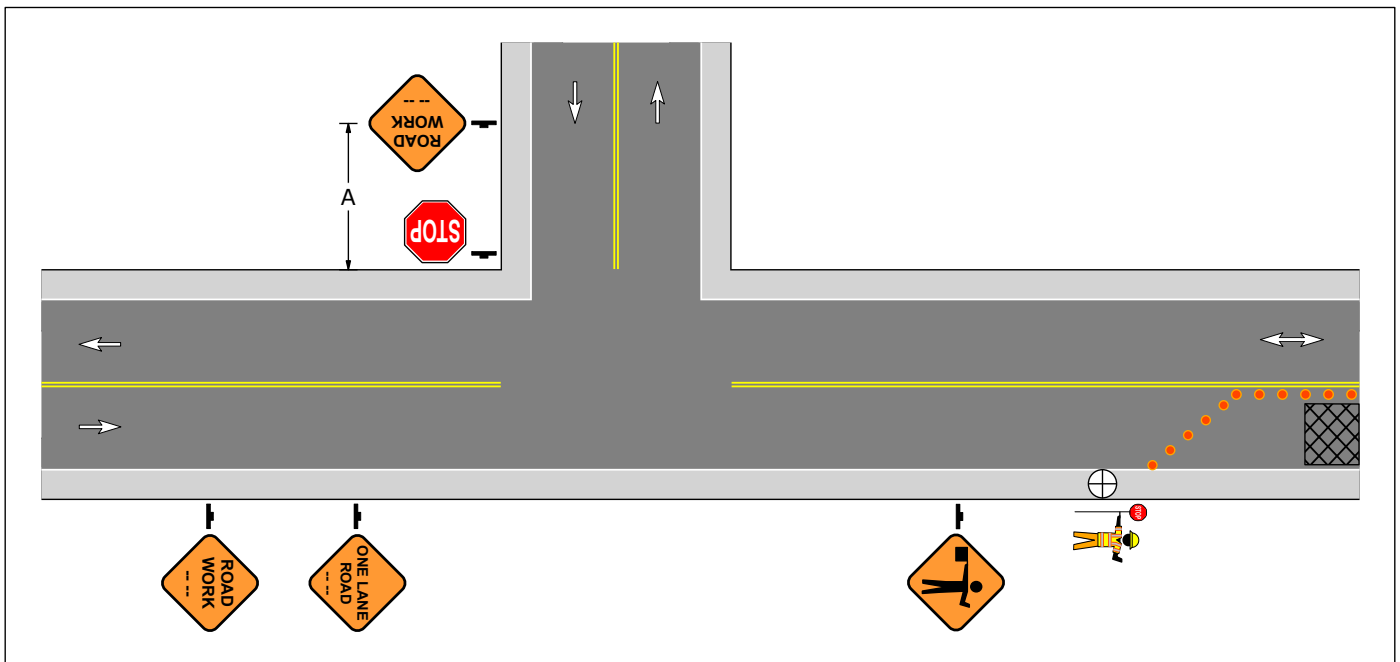


**Figure 6-4
Intersection within the Advance Warning Area**

**General Application 06
Intersection Approach Signing
Single Lane Approach**

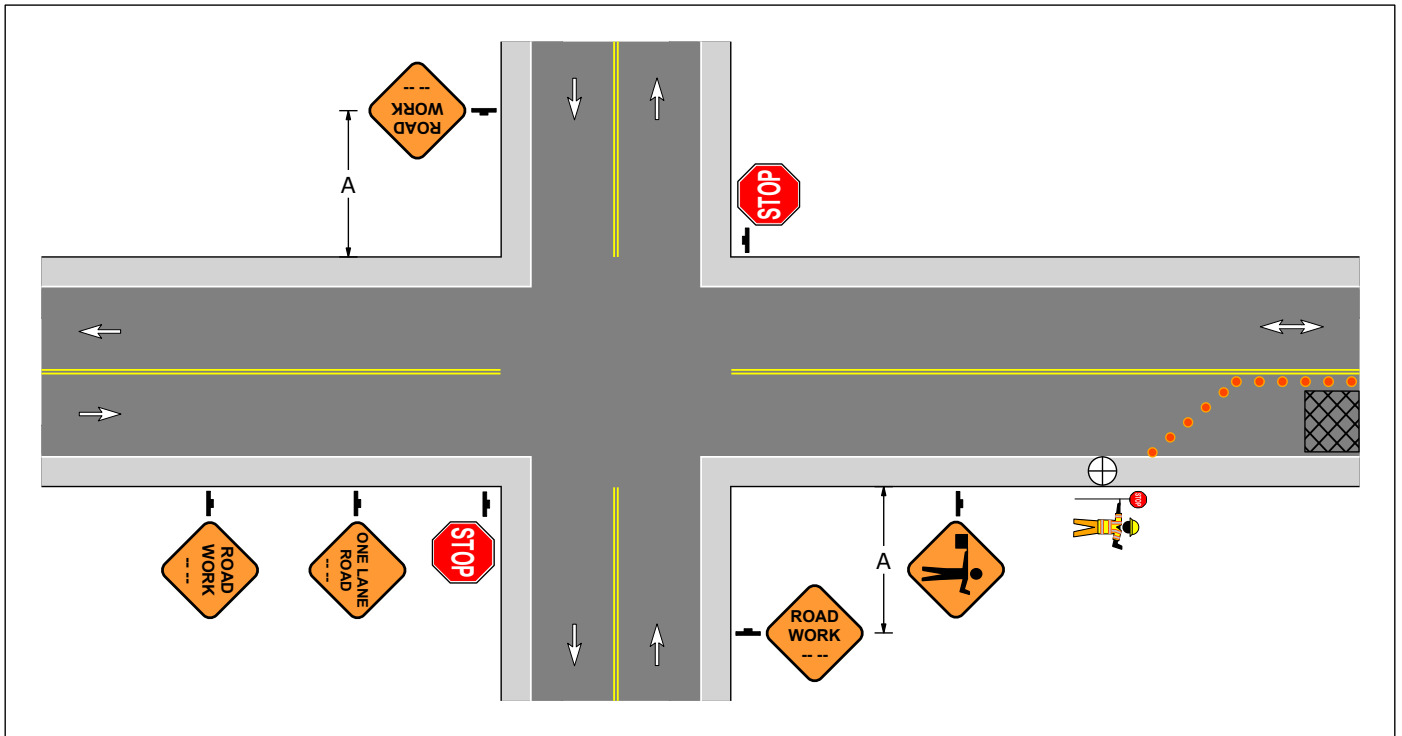


**Figure 6-5
Intersection within the Advance Warning Area**

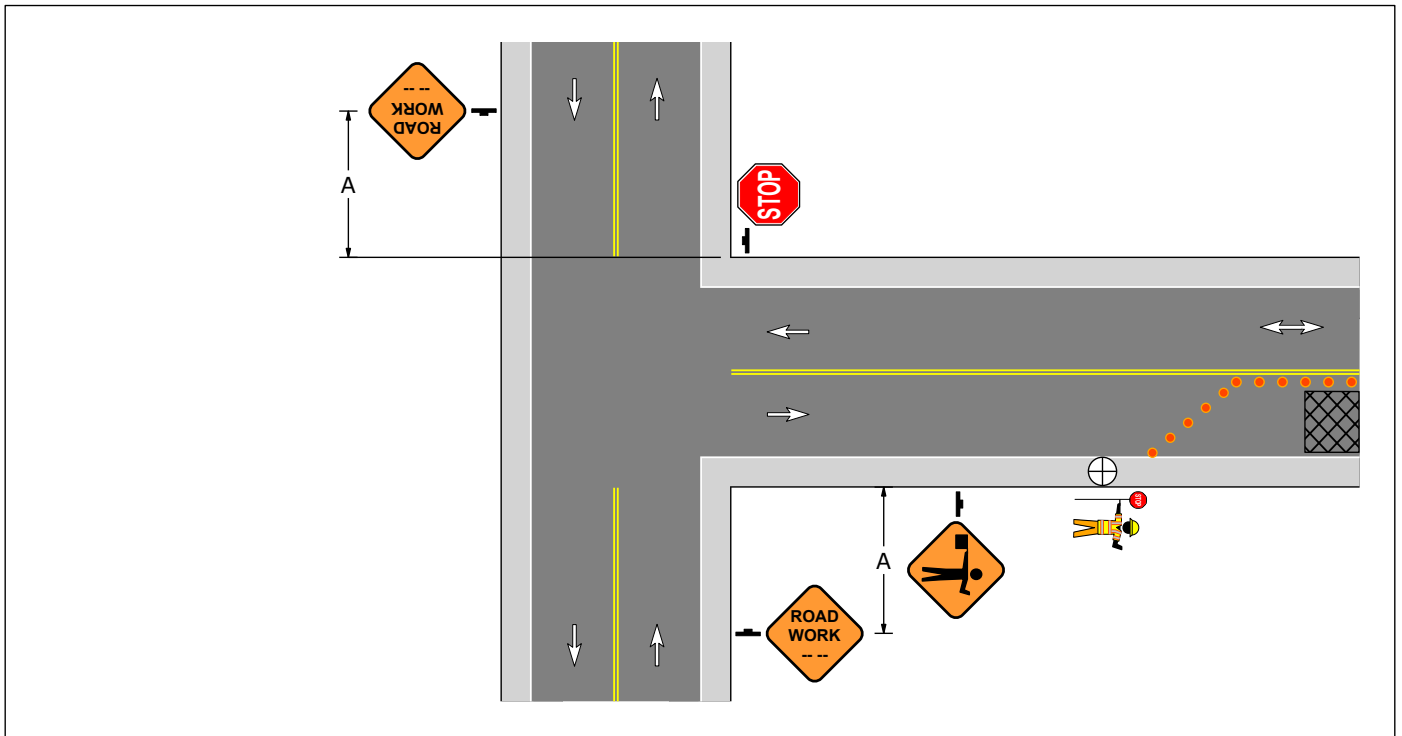


**Figure 6-6
Intersection within the Advance Warning Area**

**General Application 06
Intersection Approach Signing
Single Lane Approach**

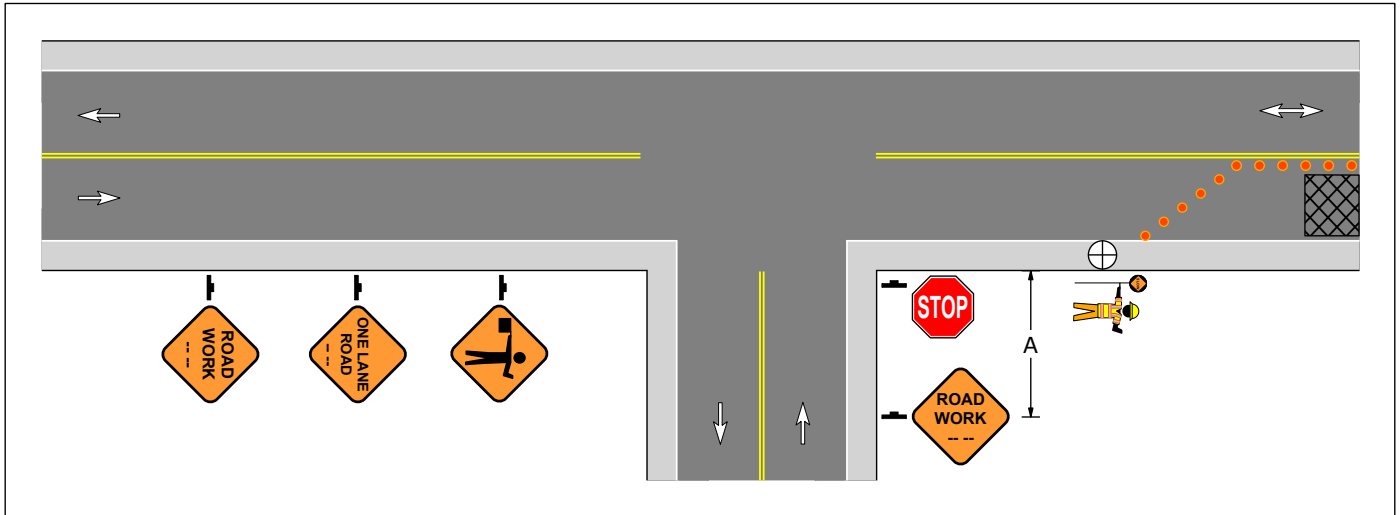


**Figure 6-7
Intersection within the Advance Warning Area**

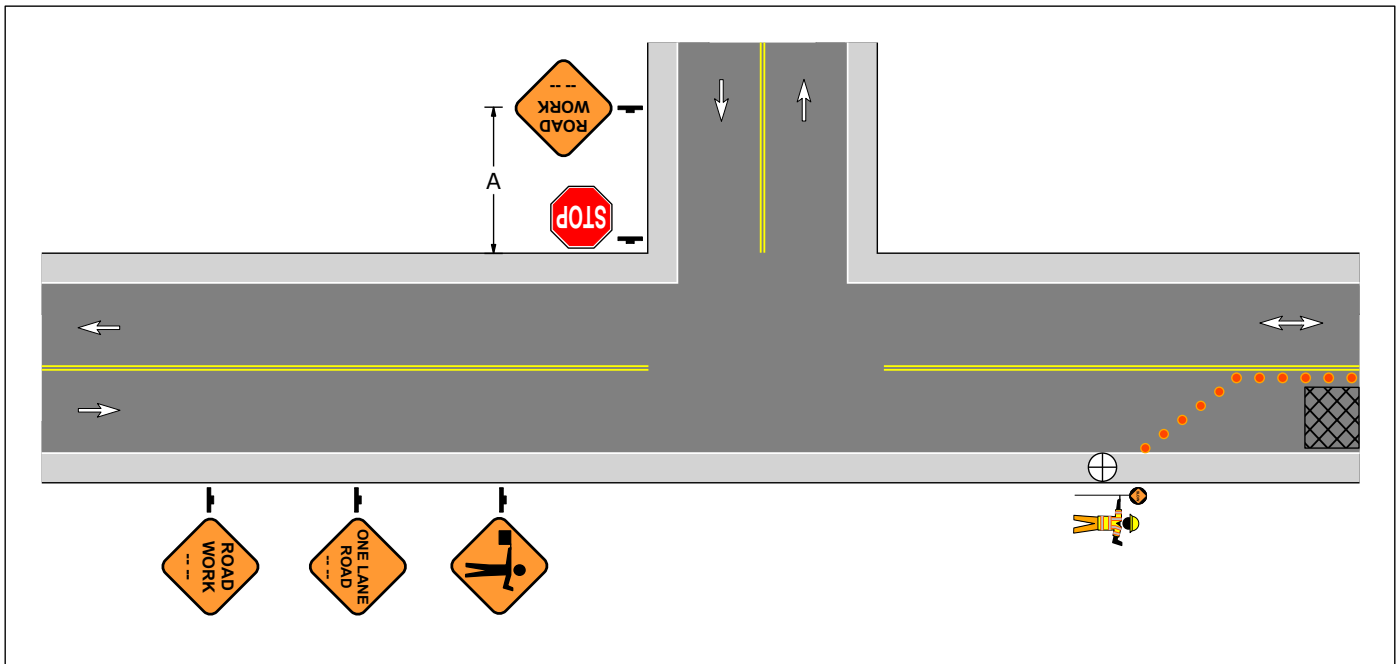


**Figure 6-8
Intersection within the Advance Warning Area**

**General Application 06
Intersection Approach Signing
Single Lane Approach**

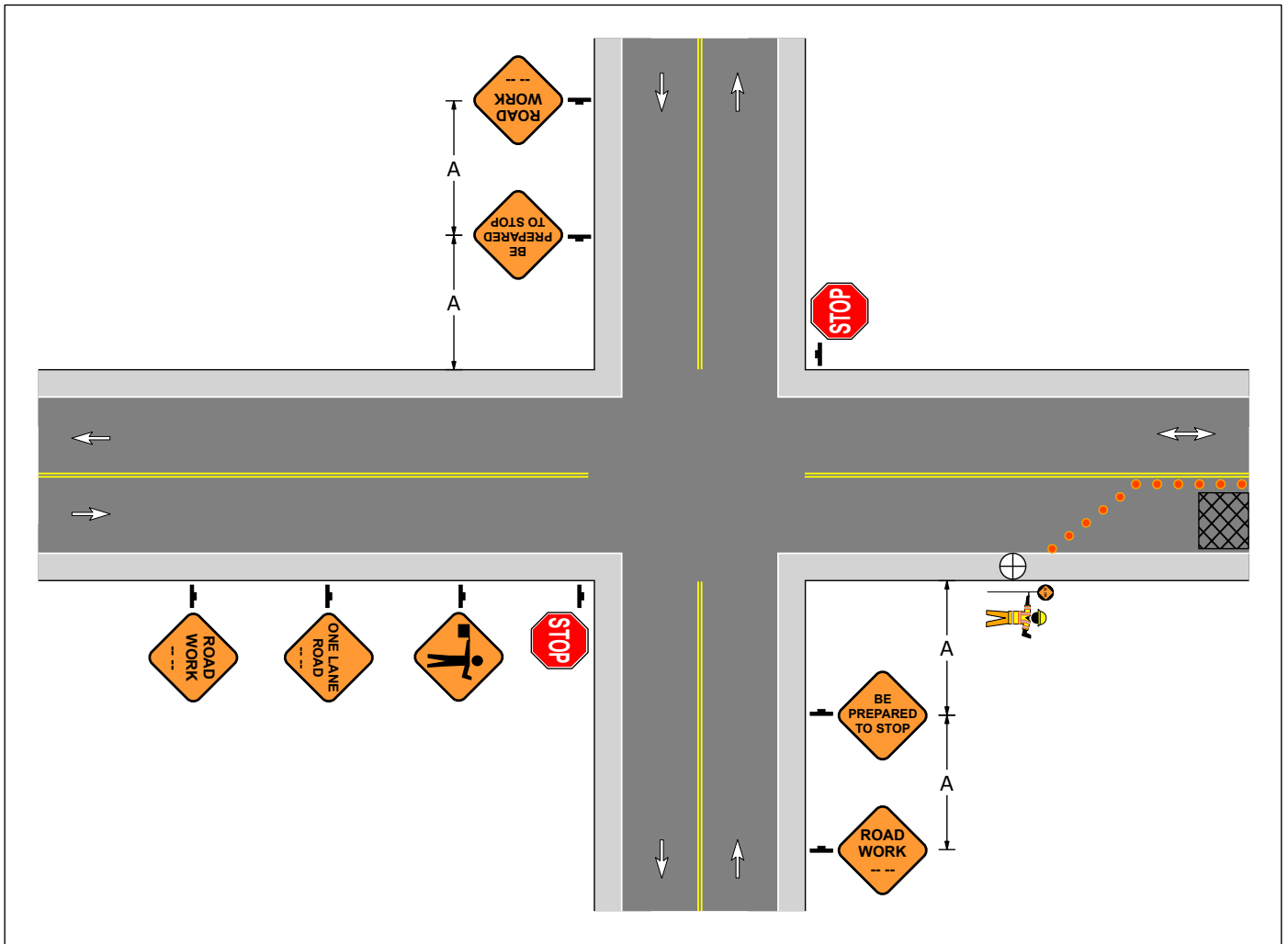


**Figure 6-9
Intersection within the Advance Warning Area**



**Figure 6-10
Intersection within the Advance Warning Area**

**General Application 06
Intersection Approach Signing
Single Lane Approach**



**Figure 6-11
Intersection within the Advance Warning Area**

General Application 06
Intersection Approach Signing
Single Lane Approach

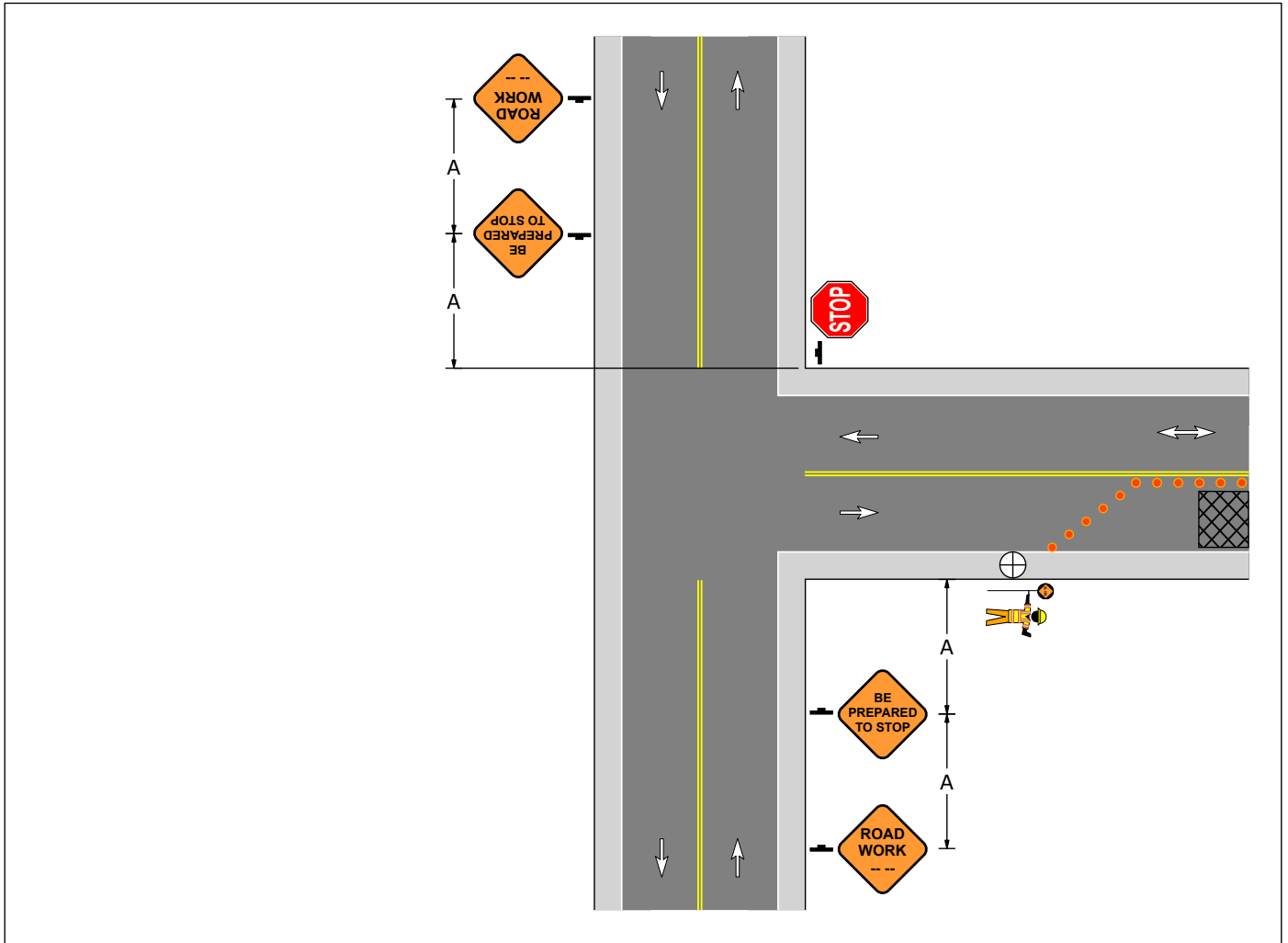
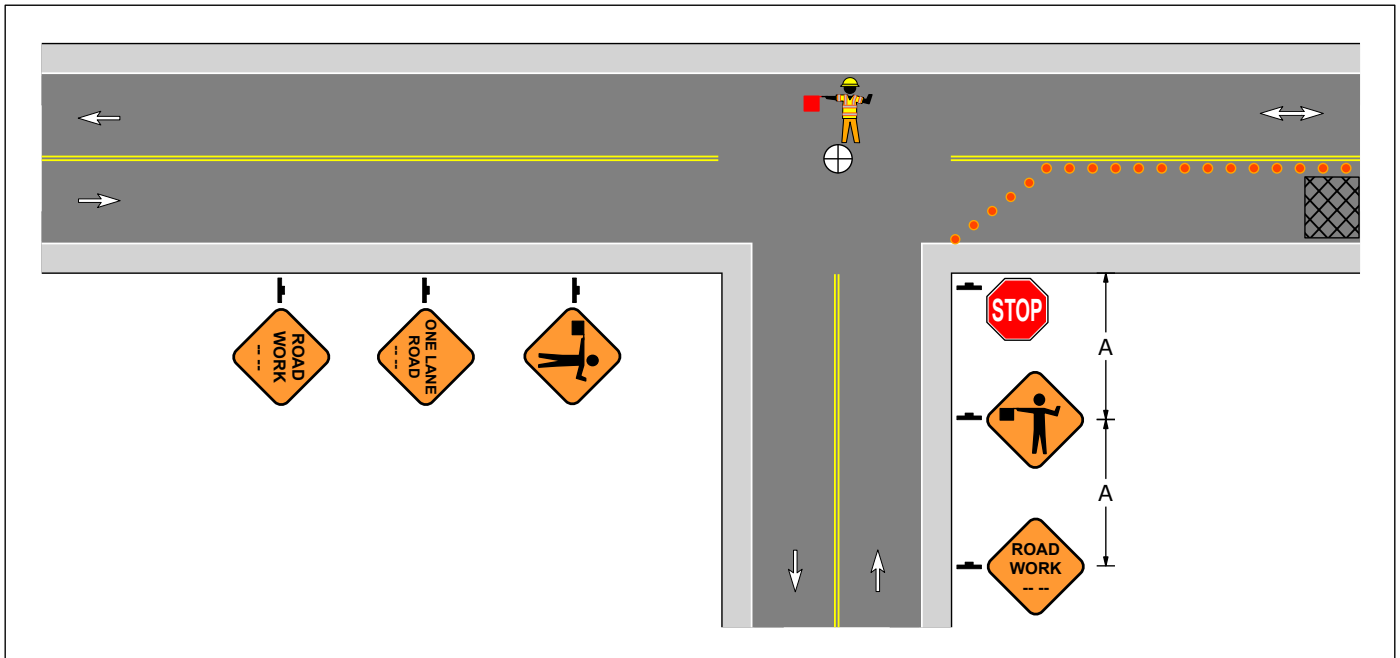
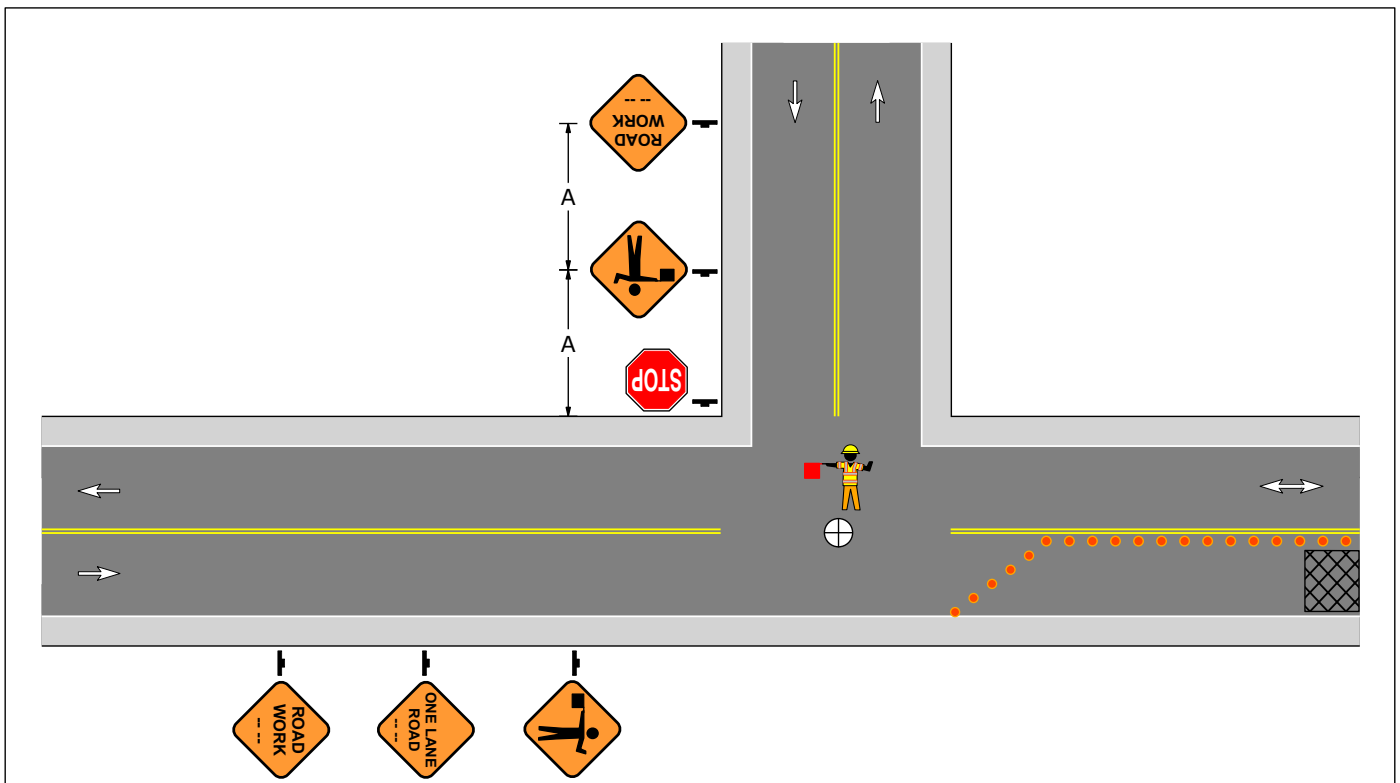


Figure 6-12
Intersection within the Advance Warning Area

**General Application 06
Intersection Approach Signing
Single Lane Approach**

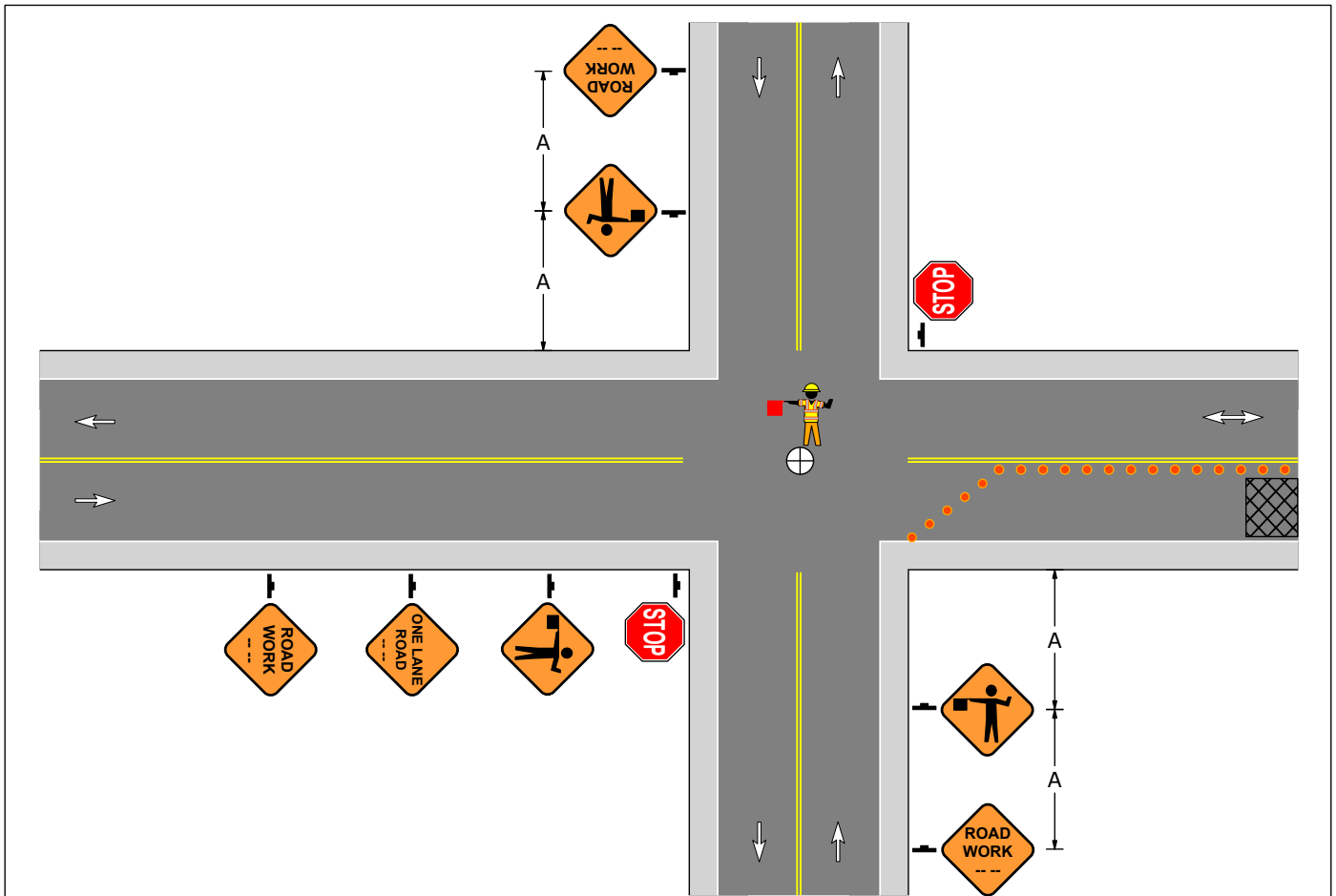


**Figure 6-13
Intersection within the Advance Warning Area**



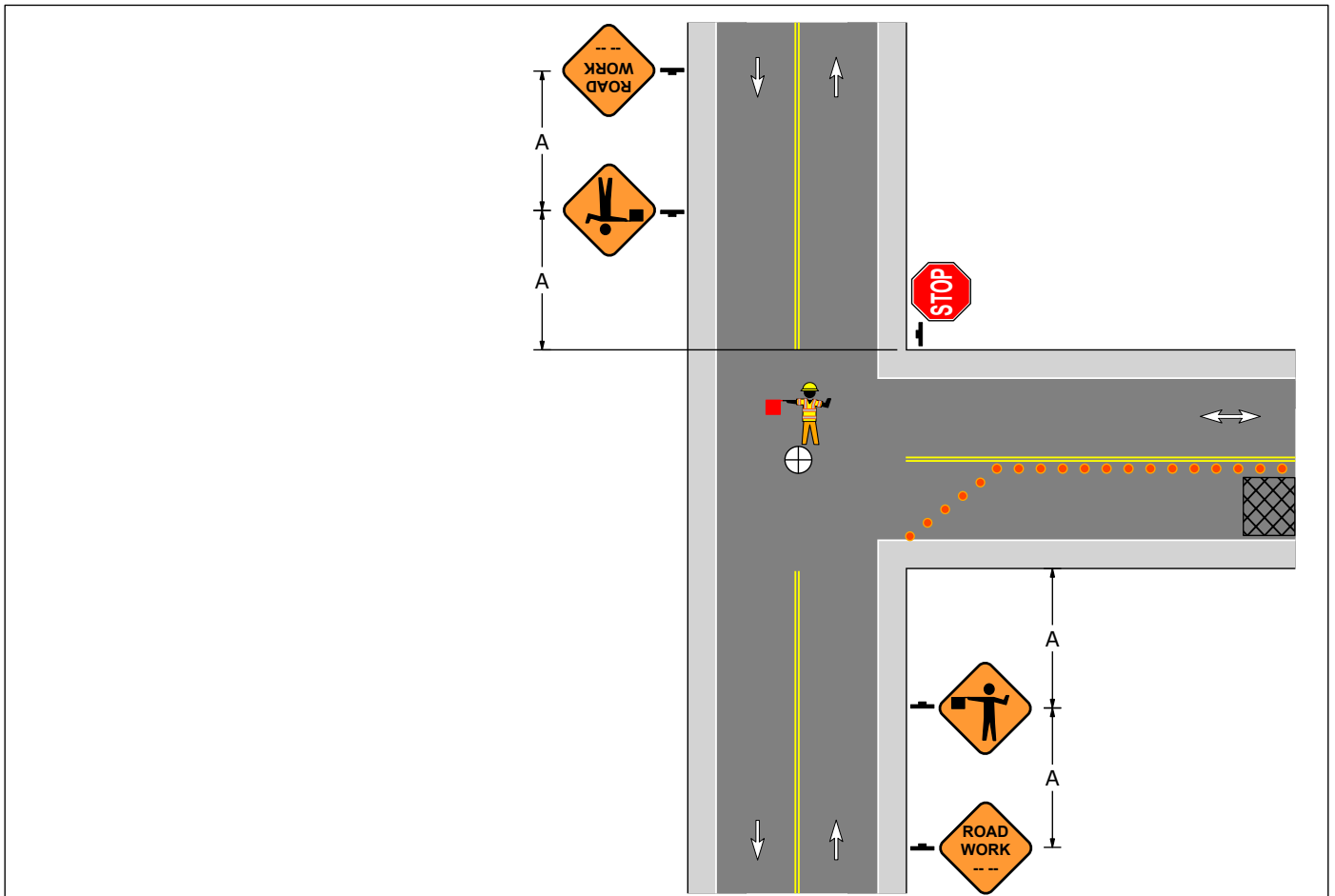
**Figure 6-14
Intersection within the Advance Warning Area**

**General Application 06
Intersection Approach Signing
Single Lane Approach**

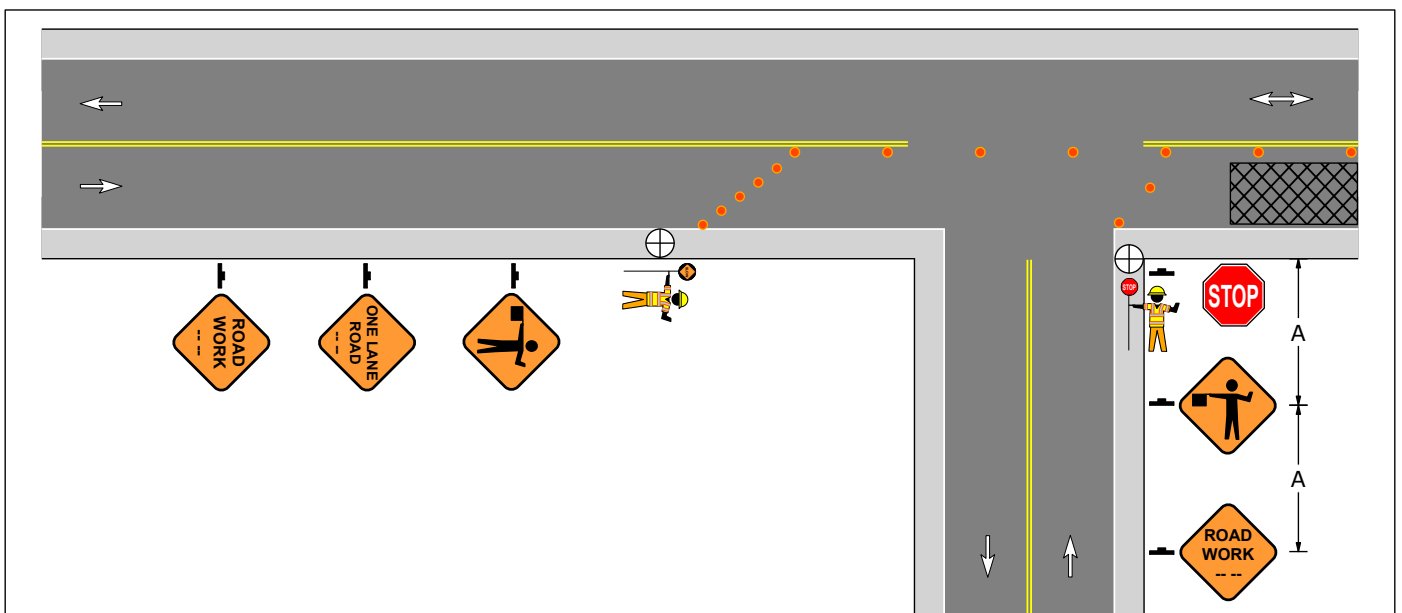


**Figure 6-15
Intersection within the Advance Warning Area**

**General Application 06
Intersection Approach Signing
Single Lane Approach**



**Figure 6-16
Intersection within the Advance Warning Area**



**Figure 6-17
Intersection within the Activity Area**

General Application 06 Intersection Approach Signing Single Lane Approach

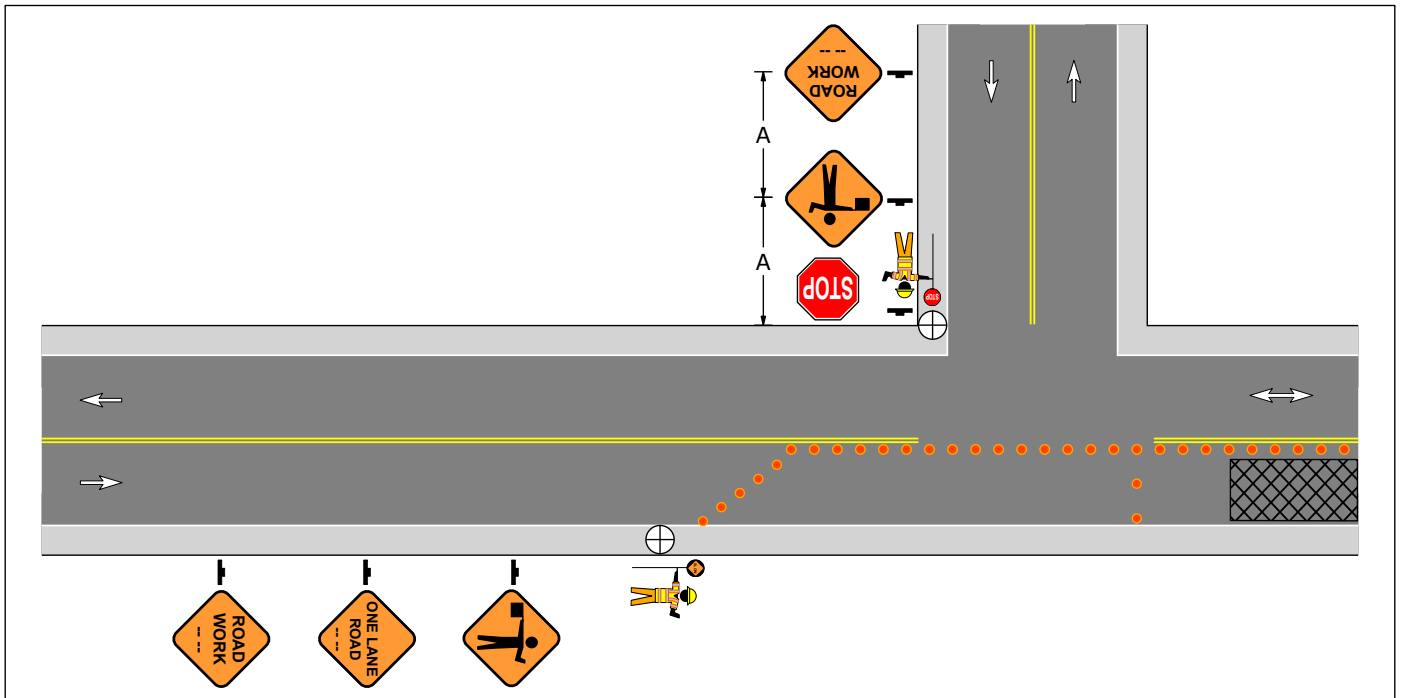


Figure 6-18
Intersection within the Activity Area

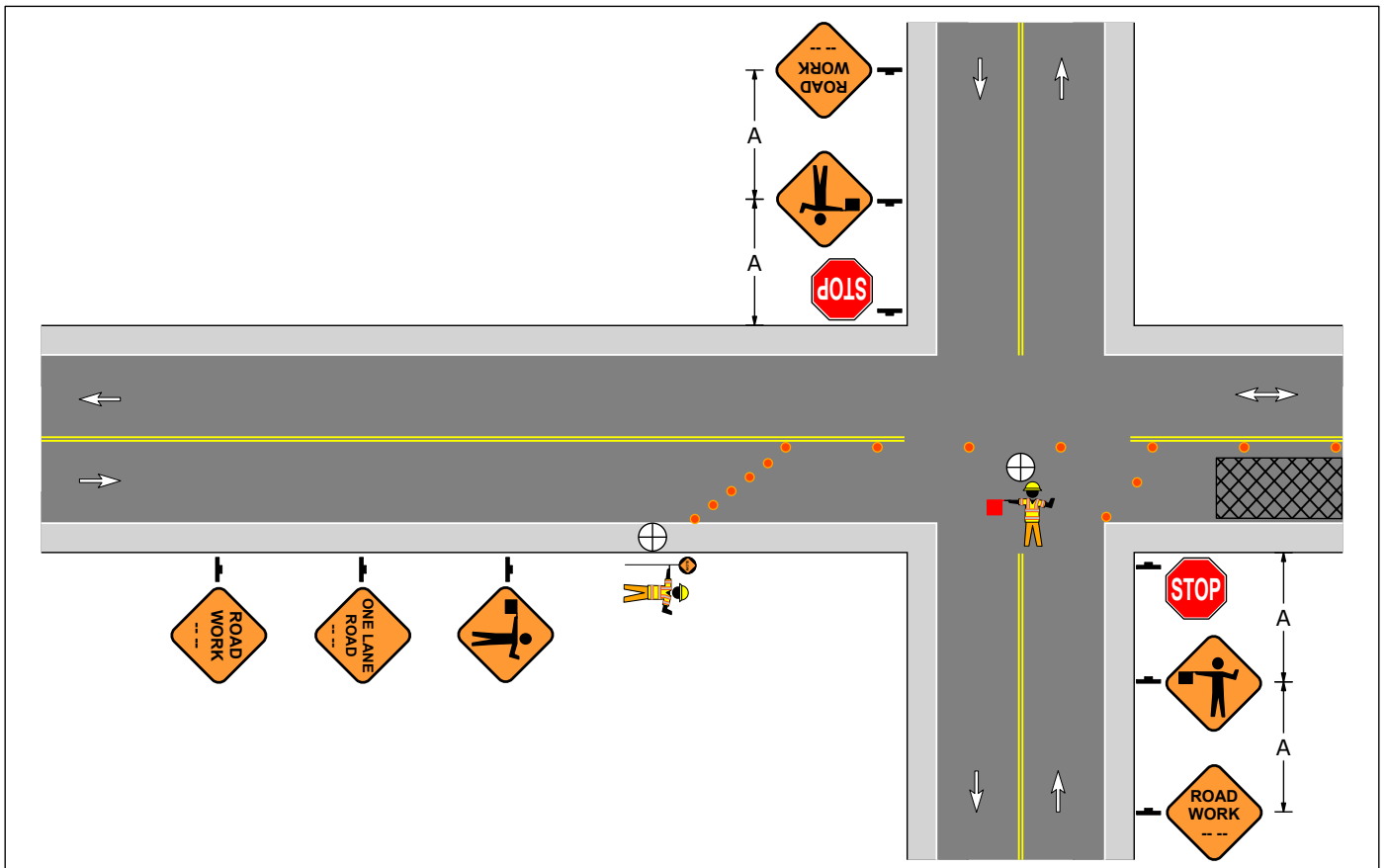


Figure 6-19
Intersection within the Activity Area

General Application 06 Intersection Approach Signing Single Lane Approach

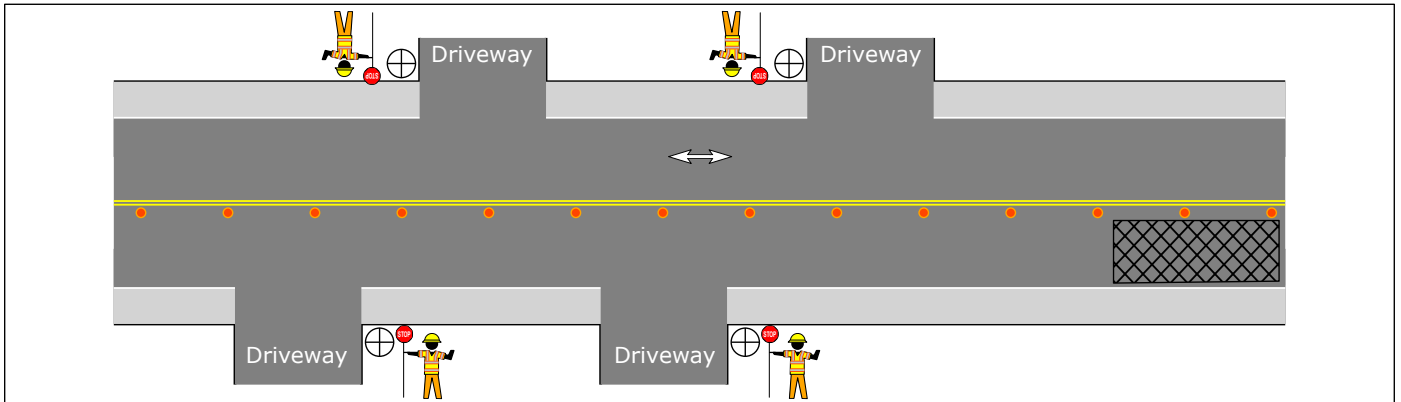
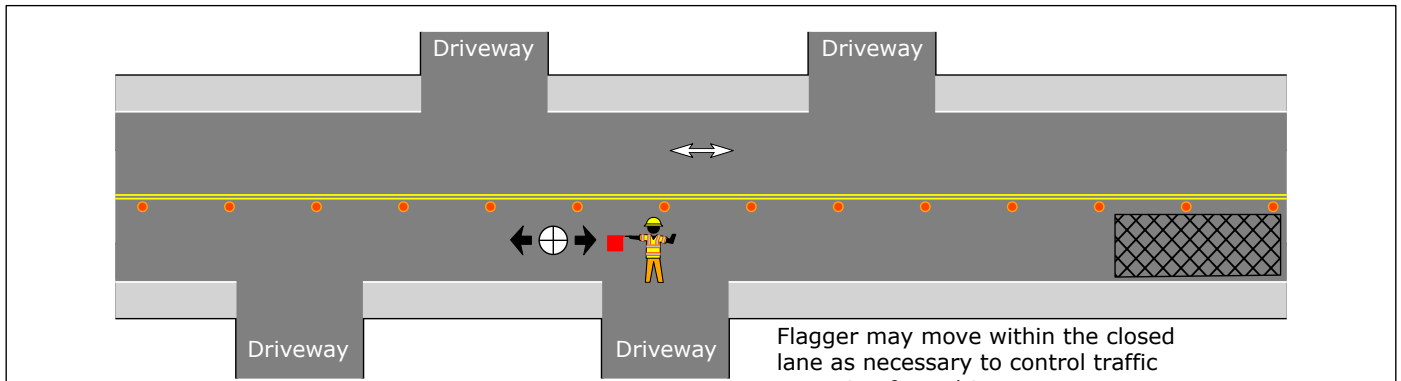
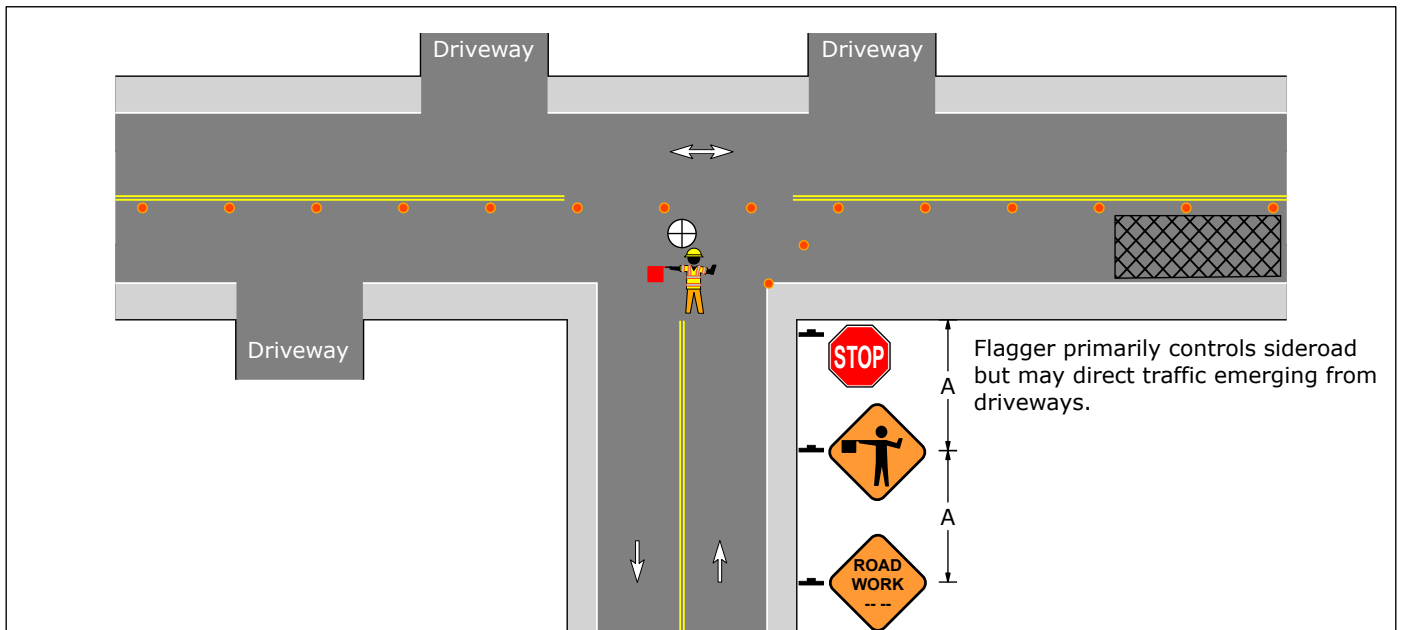


Figure 6-20
Flagger Controlling Each Driveway



Flagger may move within the closed lane as necessary to control traffic emerging from driveways.

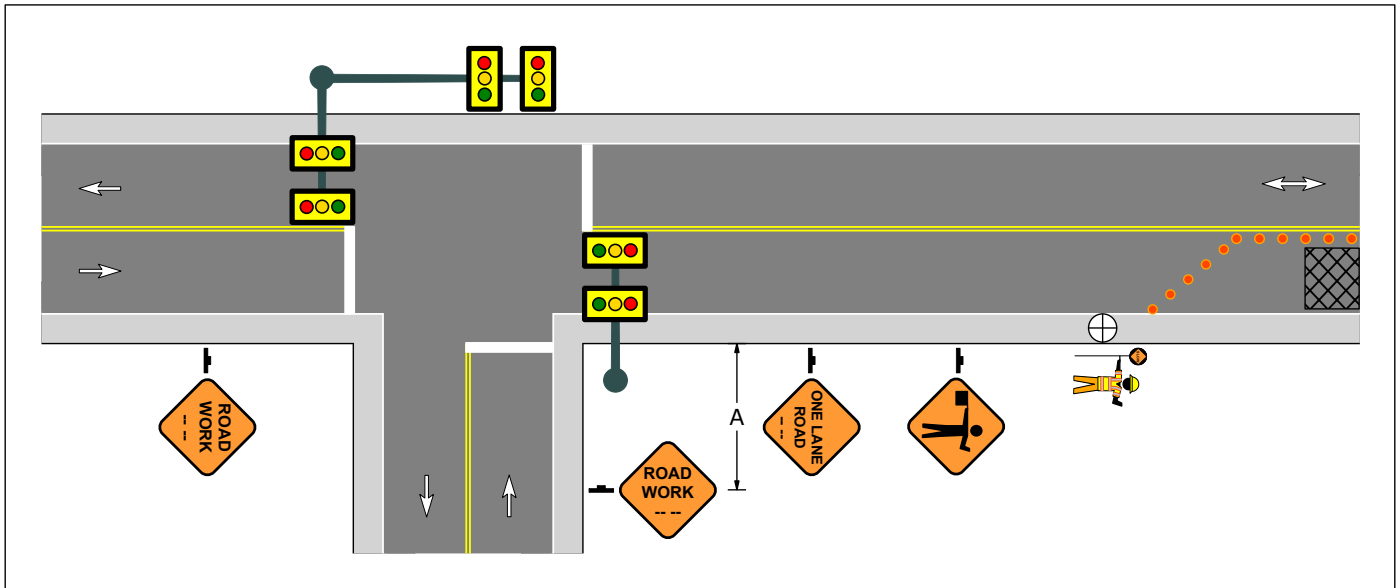
Figure 6-21
Flagger Controlling Multiple Driveways



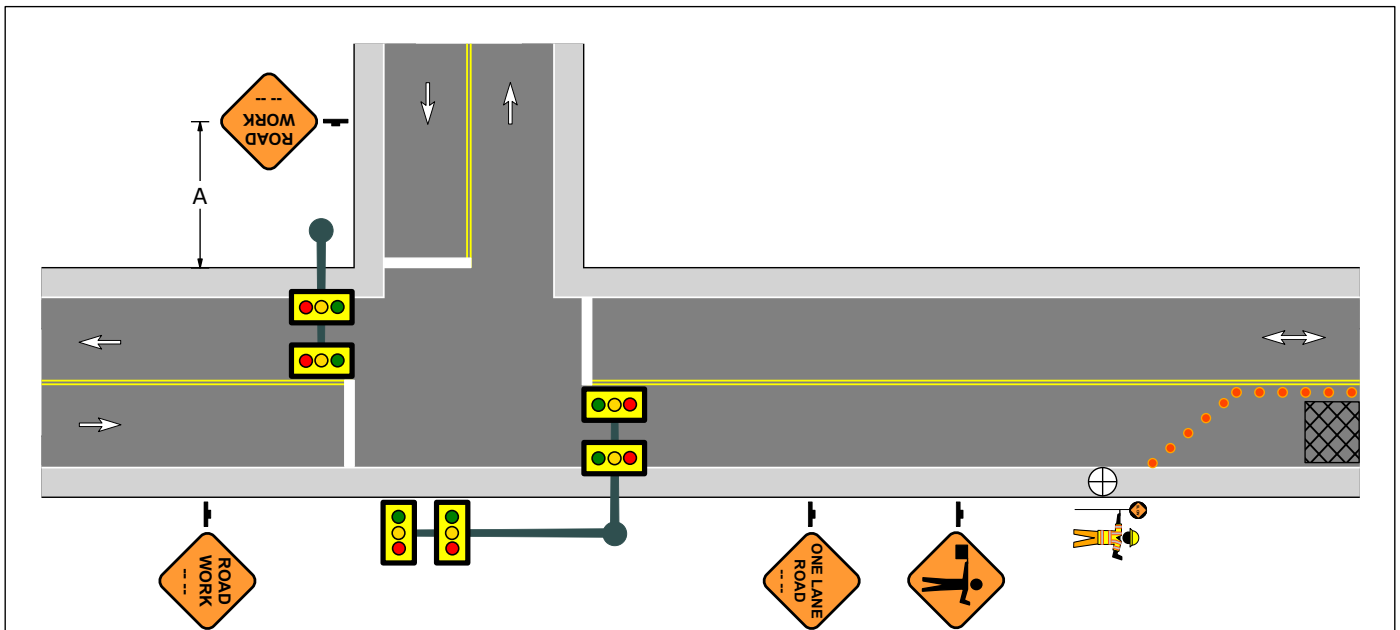
Flagger primarily controls sideroad but may direct traffic emerging from driveways.

Figure 6-22
Flagger Controlling Sideroad and Multiple Driveways

**General Application 06
Intersection Approach Signing
Single Lane Approach**

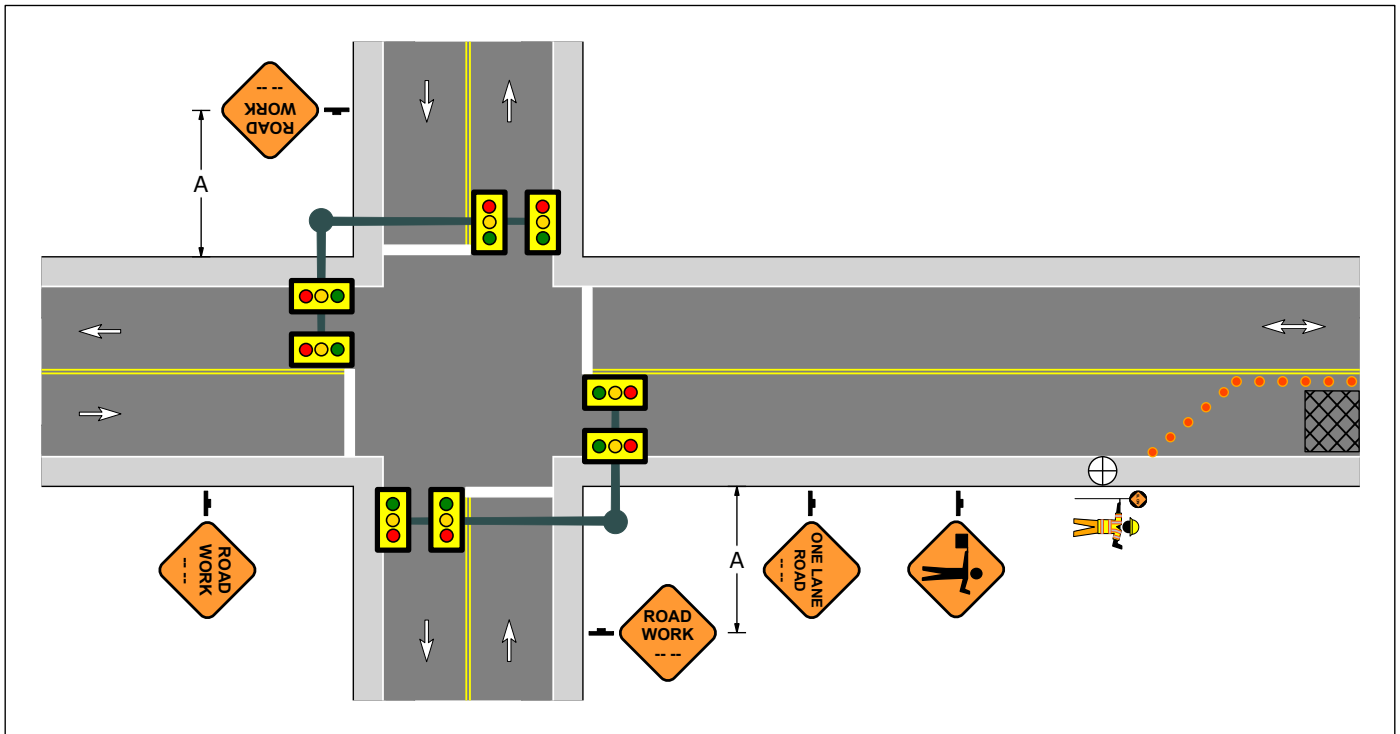


**Figure 6-23
Intersection within the Advance Warning Area**

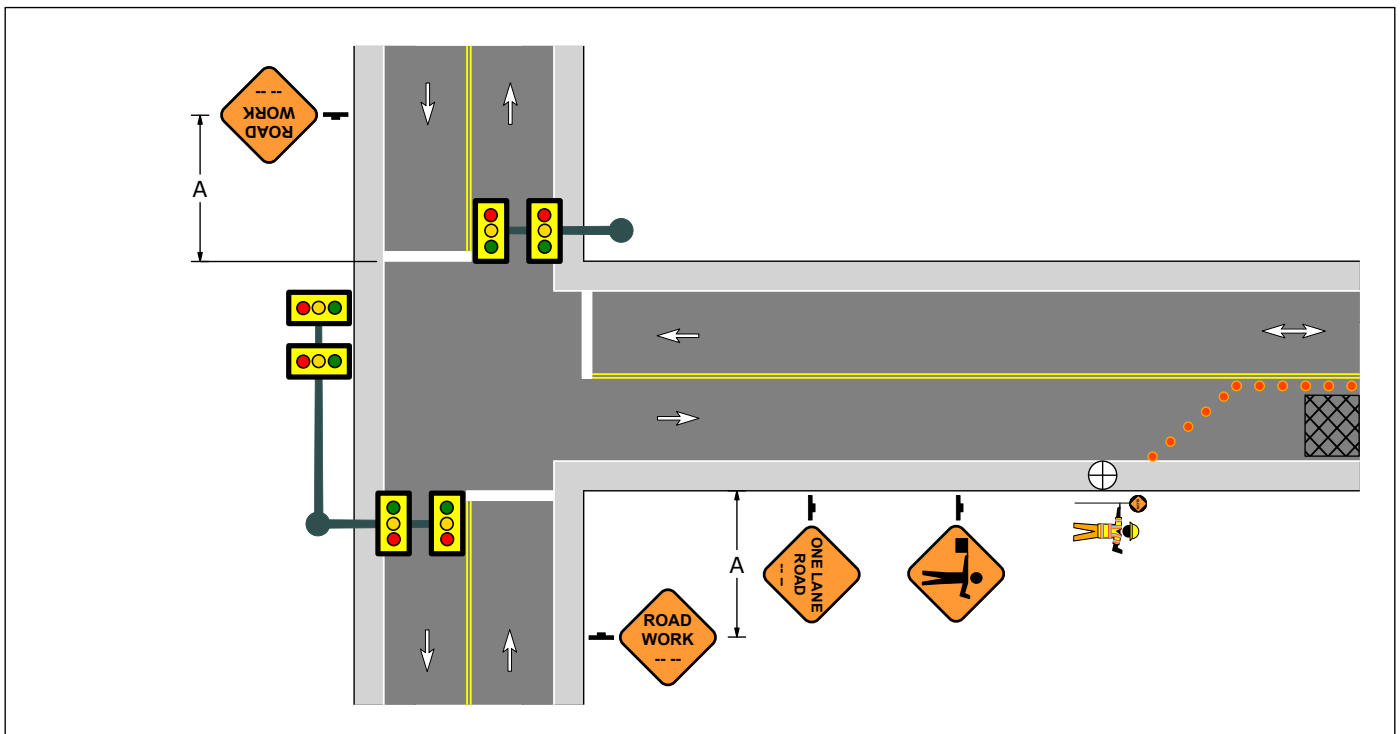


**Figure 6-24
Intersection within the Advance Warning Area**

**General Application 06
Intersection Approach Signing
Single Lane Approach**

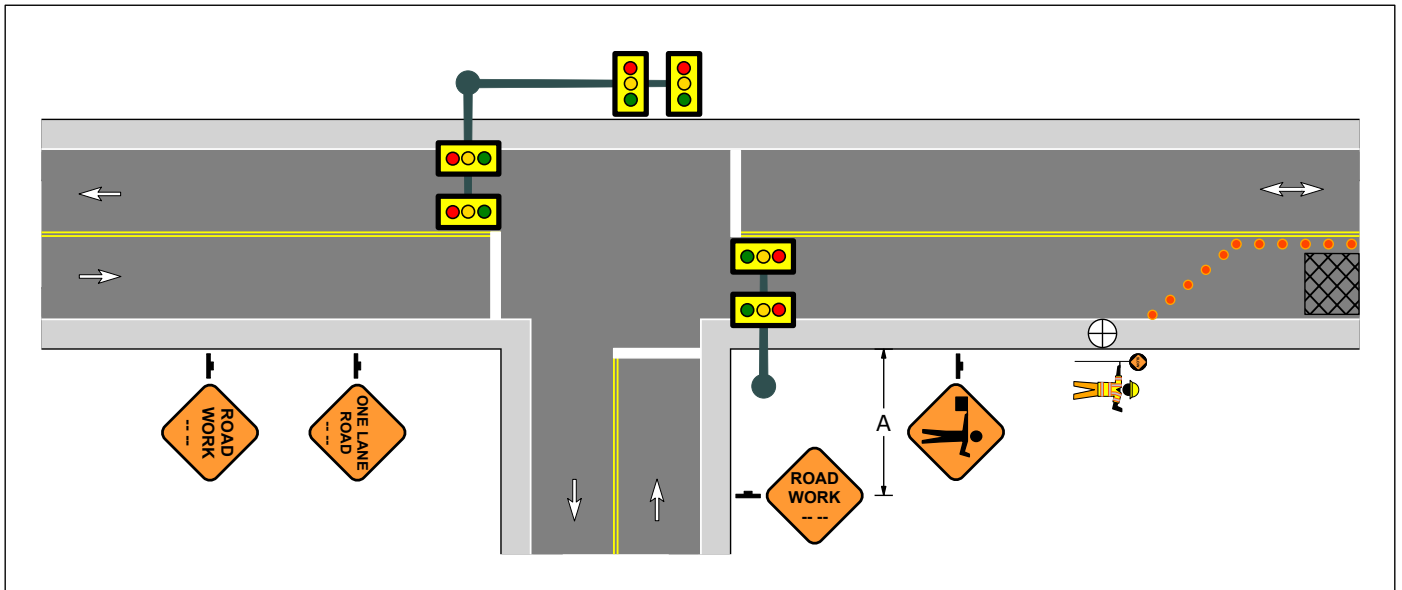


**Figure 6-25
Intersection within the Advance Warning Area**

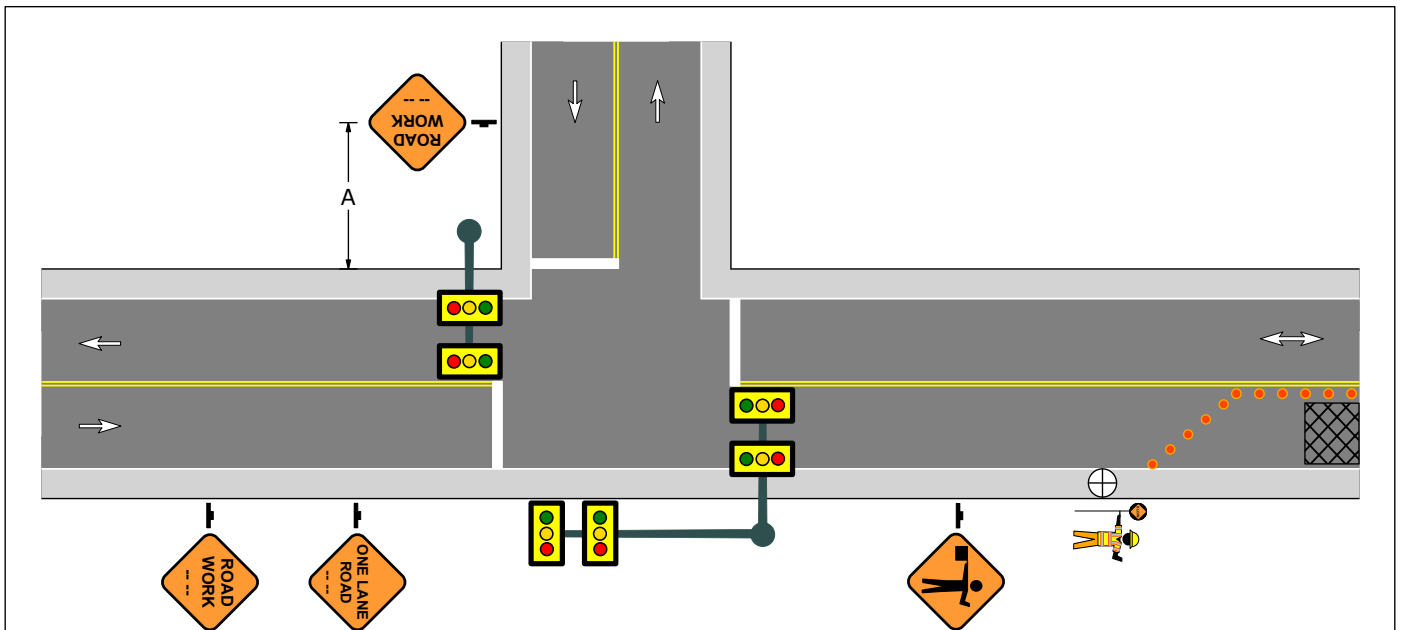


**Figure 6-26
Intersection within the Advance Warning Area**

**General Application 06
Intersection Approach Signing
Single Lane Approach**



**Figure 6-27
Intersection within the Advance Warning Area**



**Figure 6-28
Intersection within the Advance Warning Area**

General Application 06
Intersection Approach Signing
Single Lane Approach

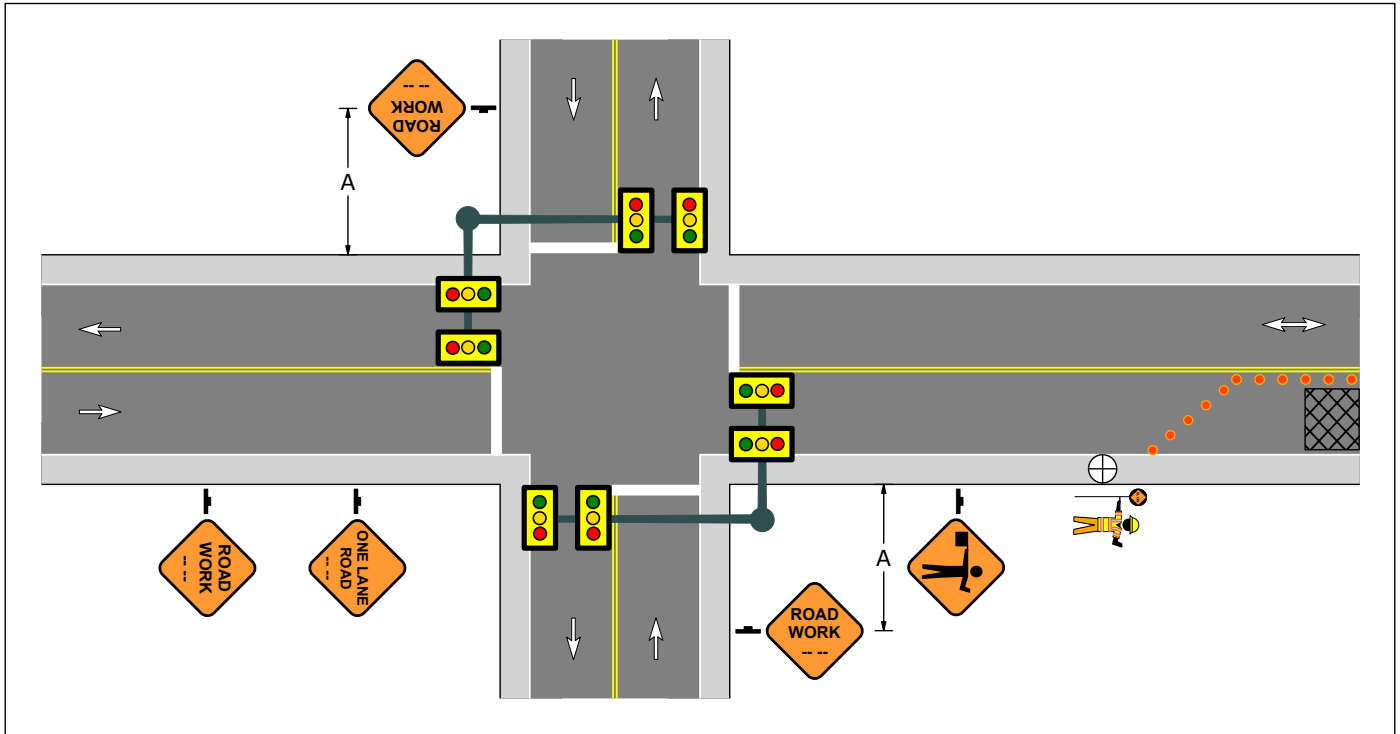


Figure 6-29
Intersection within the Advance Warning Area

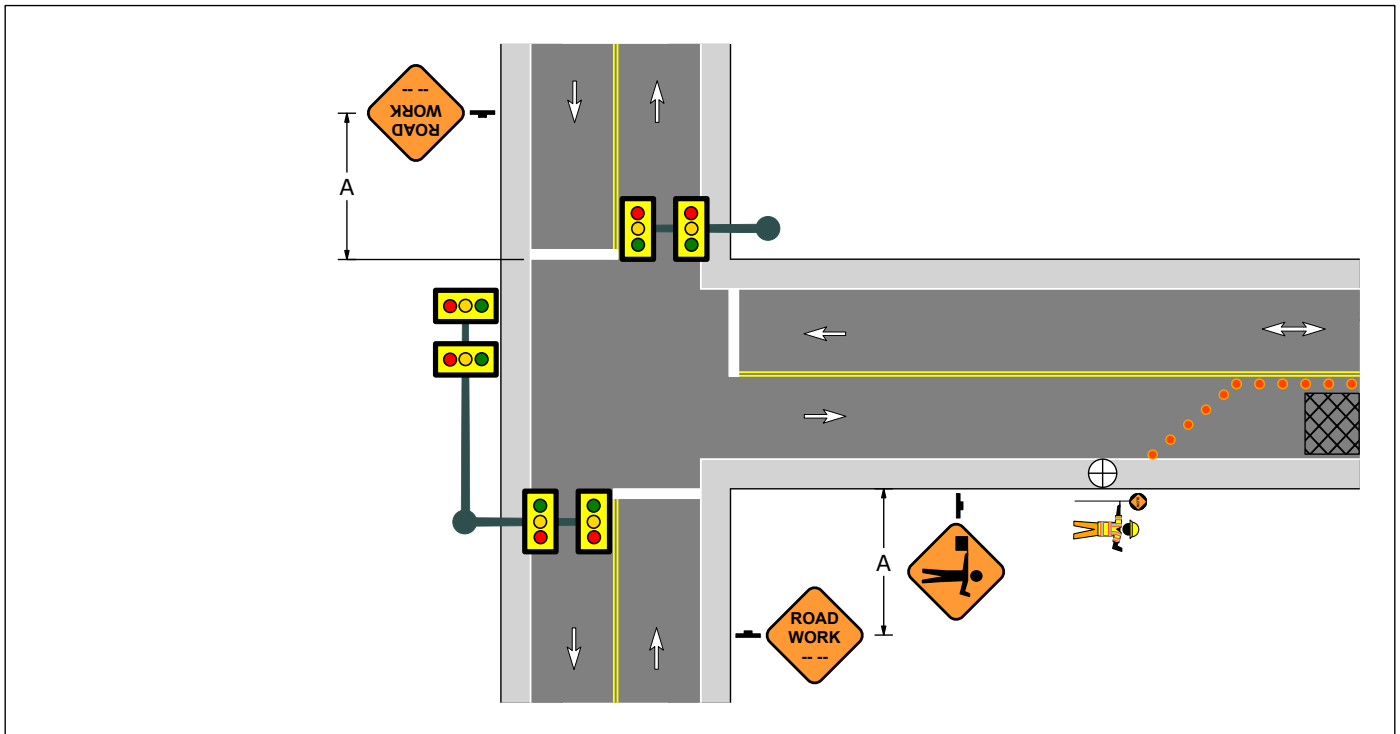


Figure 6-30
Intersection within the Advance Warning Area

General Application 06
Intersection Approach Signing
Single Lane Approach

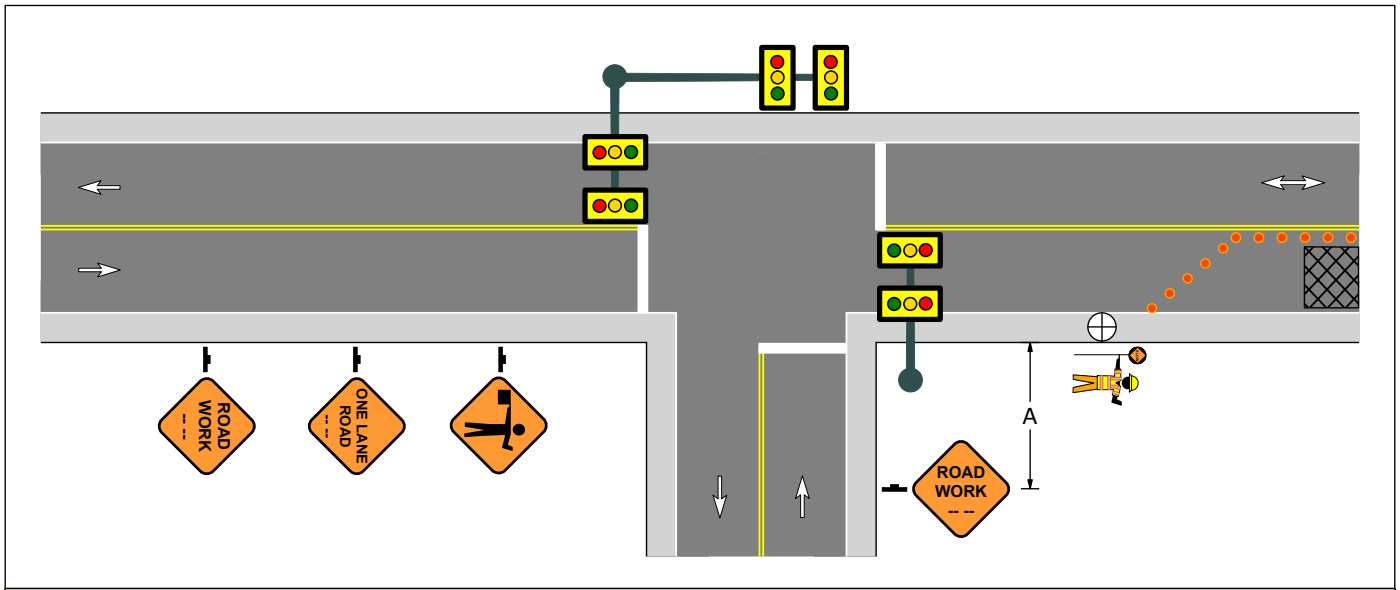


Figure 6-31
Intersection within the Advance Warning Area

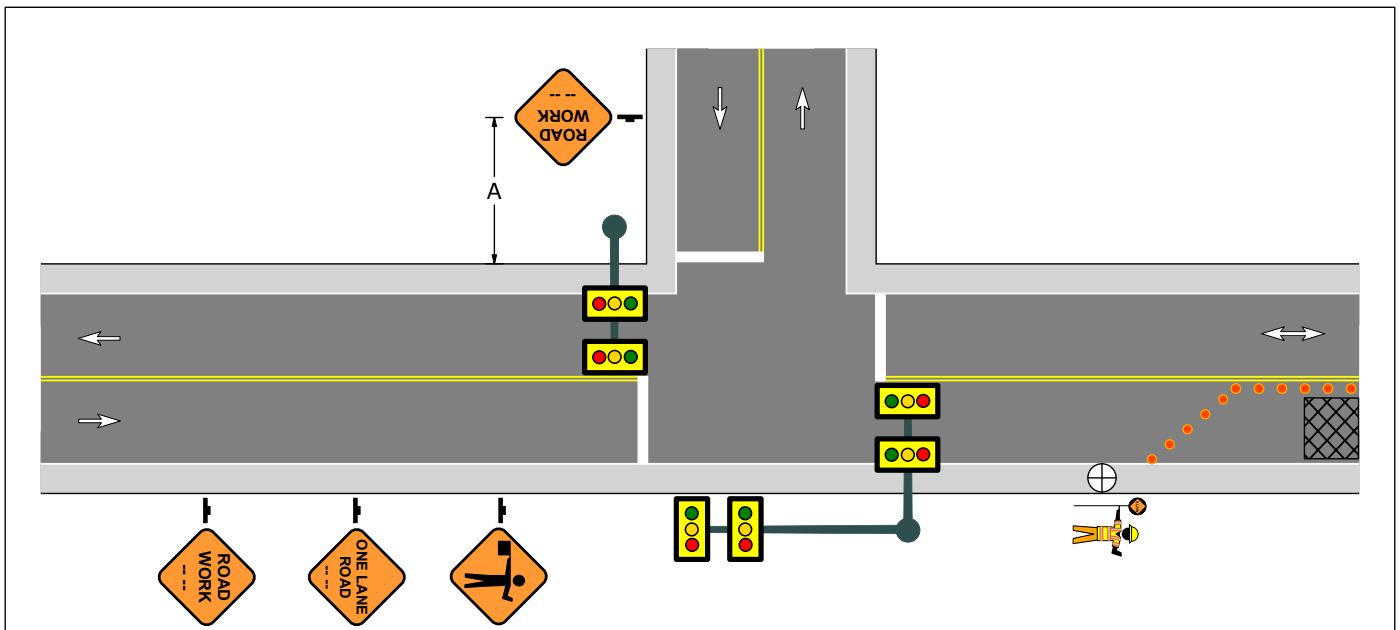
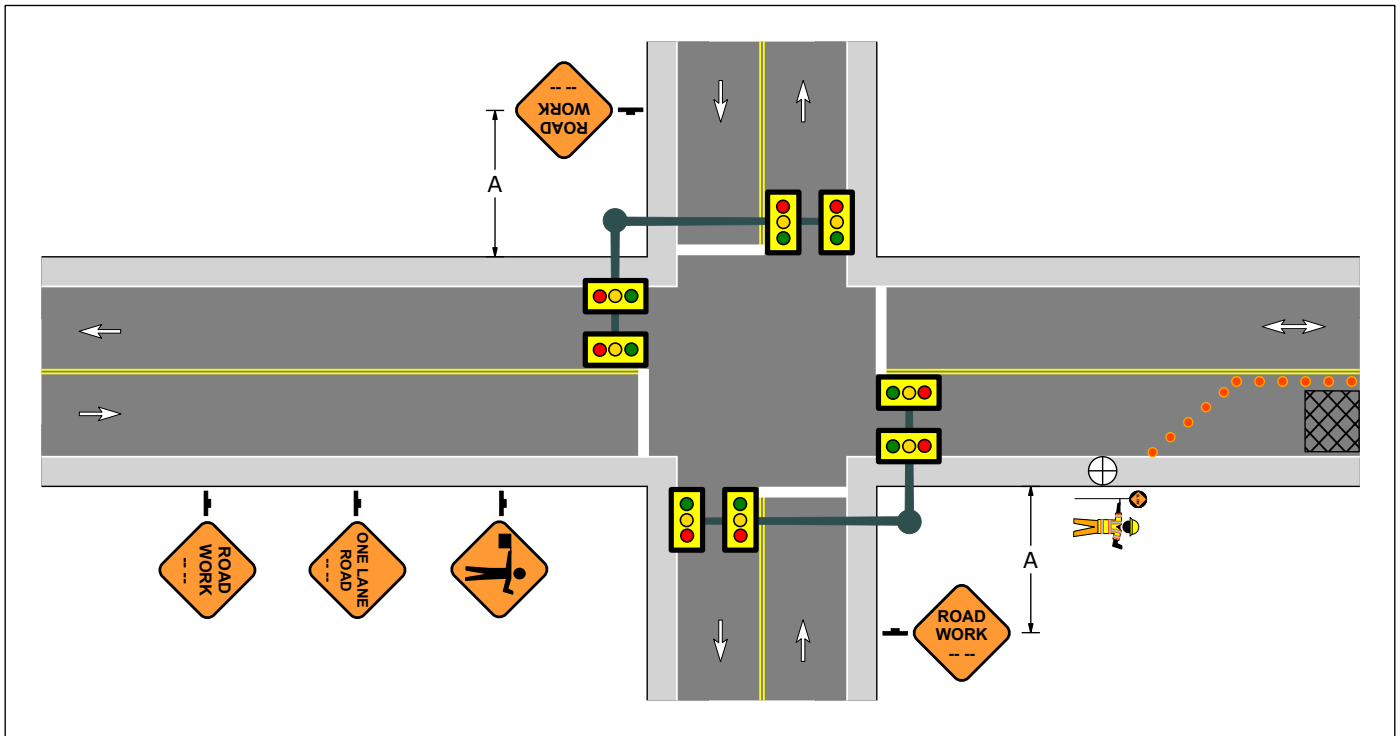
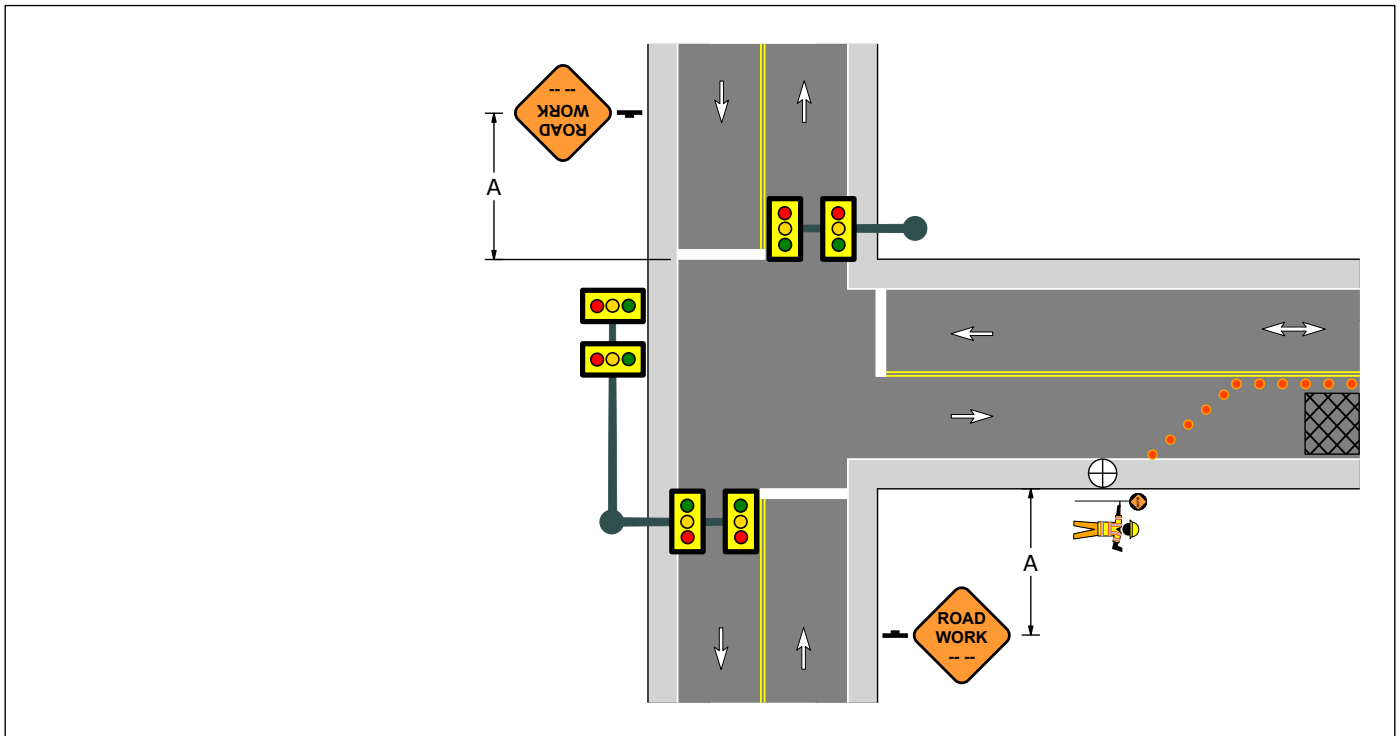


Figure 6-32
Intersection within the Advance Warning Area

**General Application 06
Intersection Approach Signing
Single Lane Approach**



**Figure 6-33
Intersection within the Advance Warning Area**



**Figure 6-34
Intersection within the Advance Warning Area**

General Application 06 Intersection Approach Signing Single Lane Approach

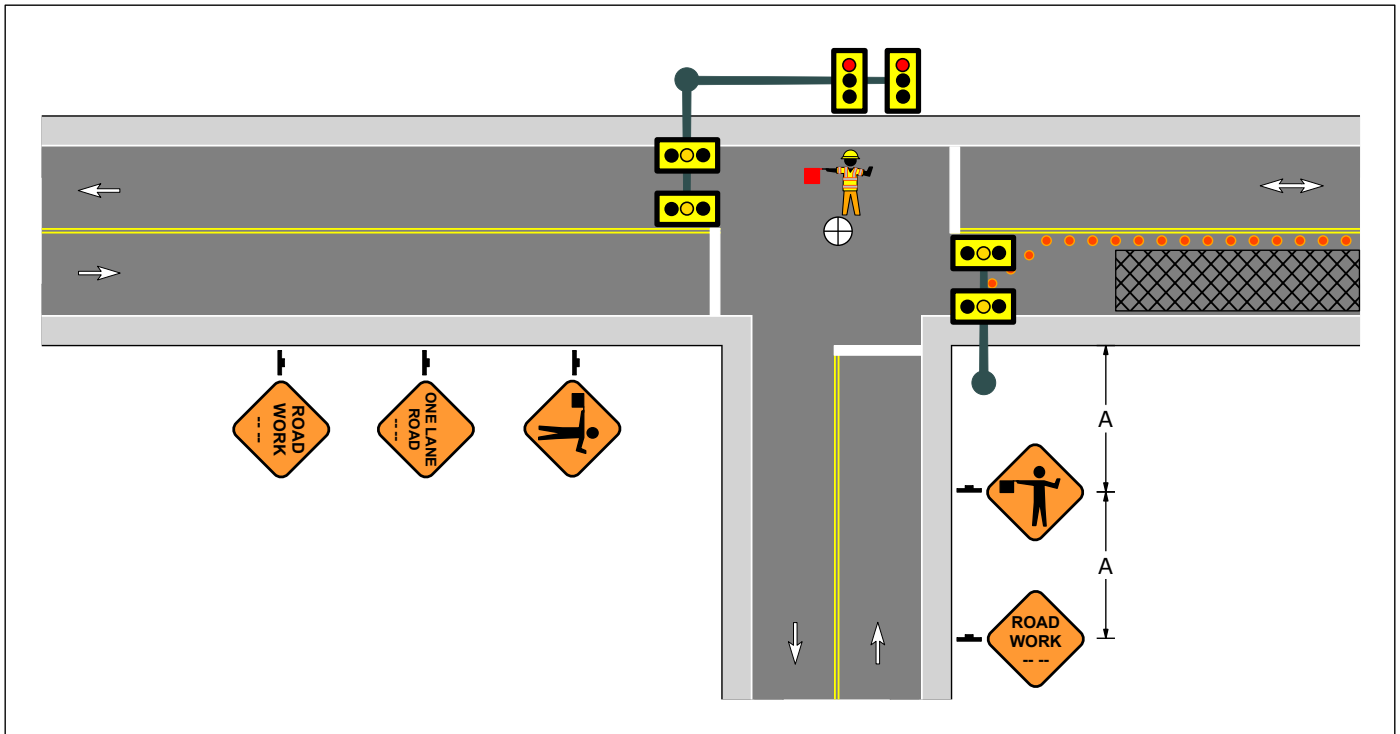


Figure 6-35
Intersection within the Advance Warning Area

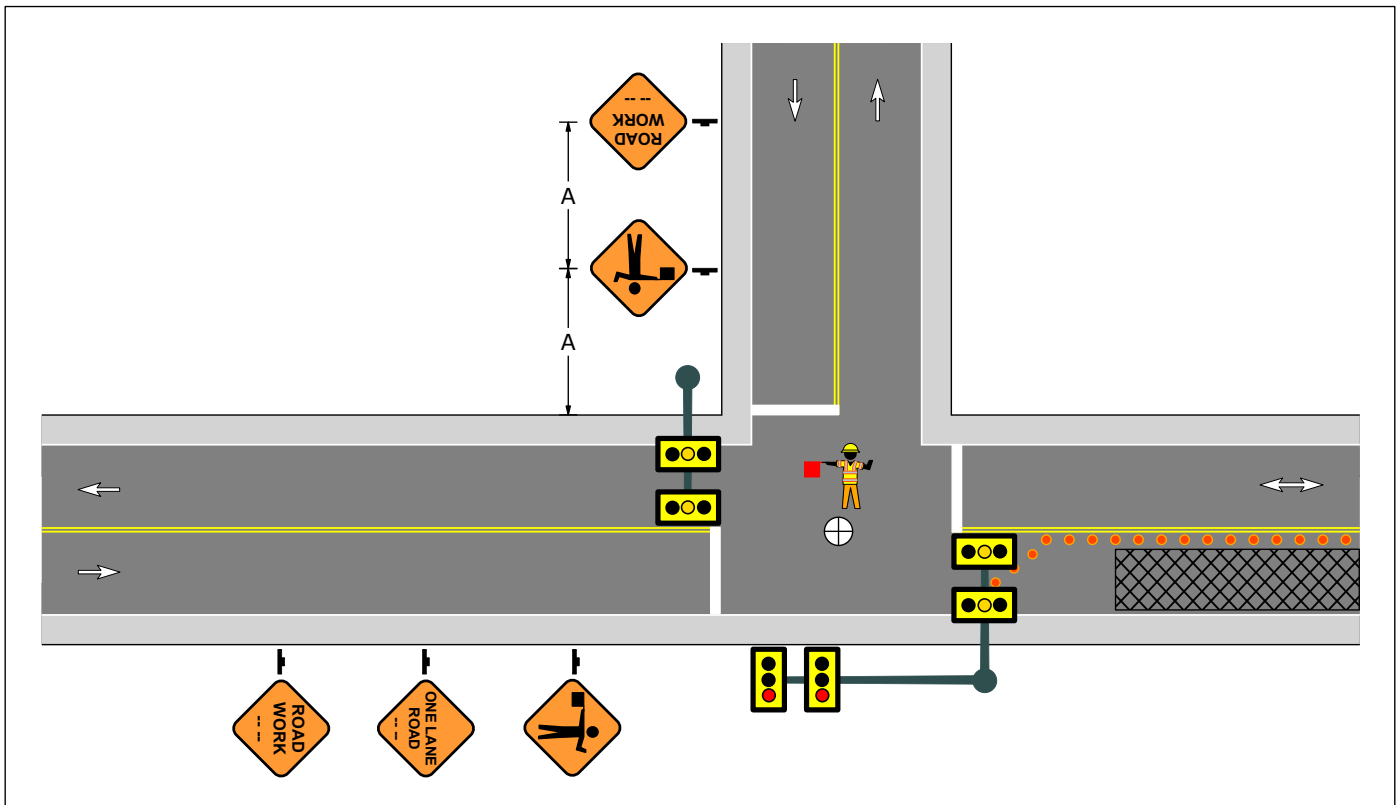
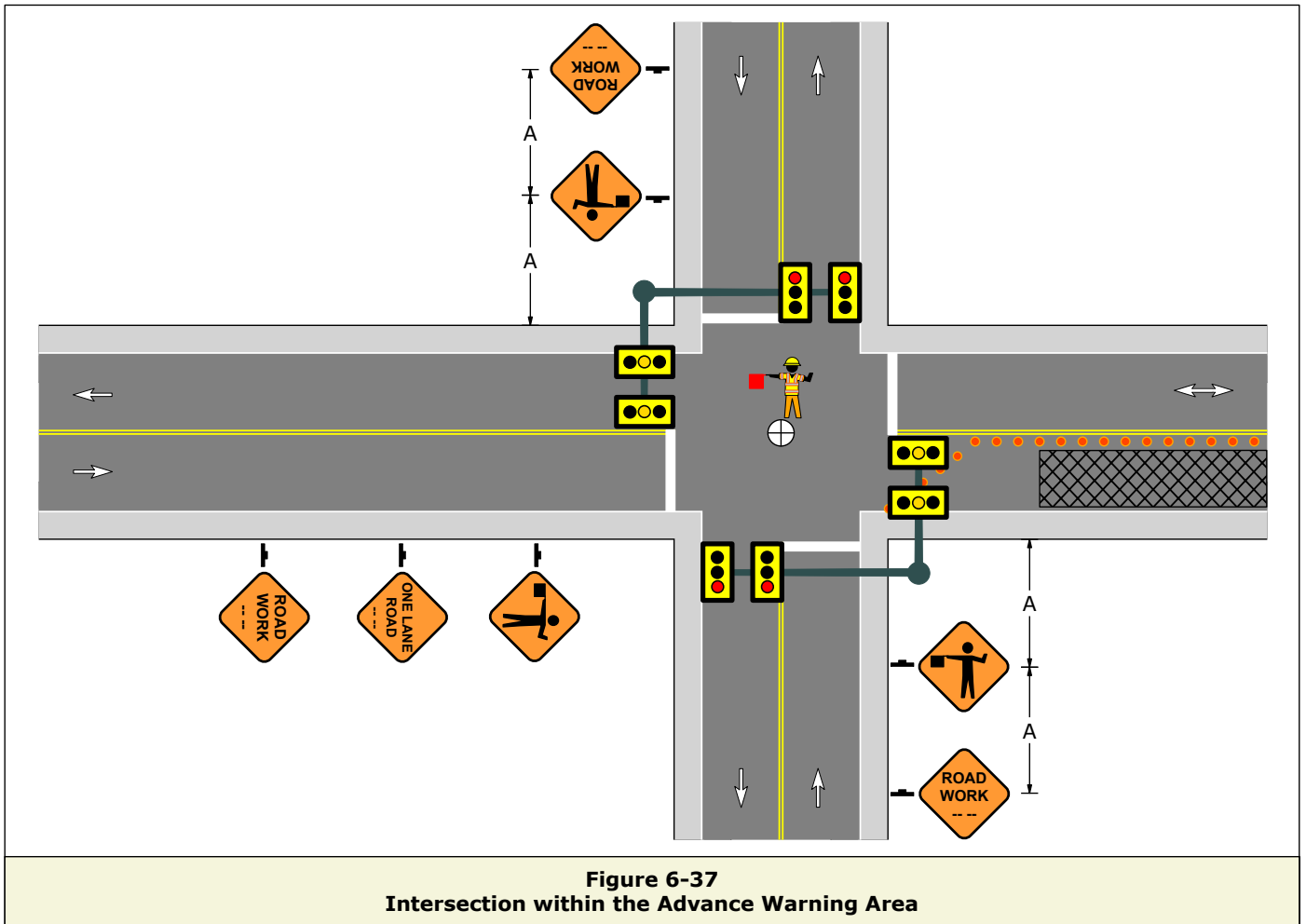


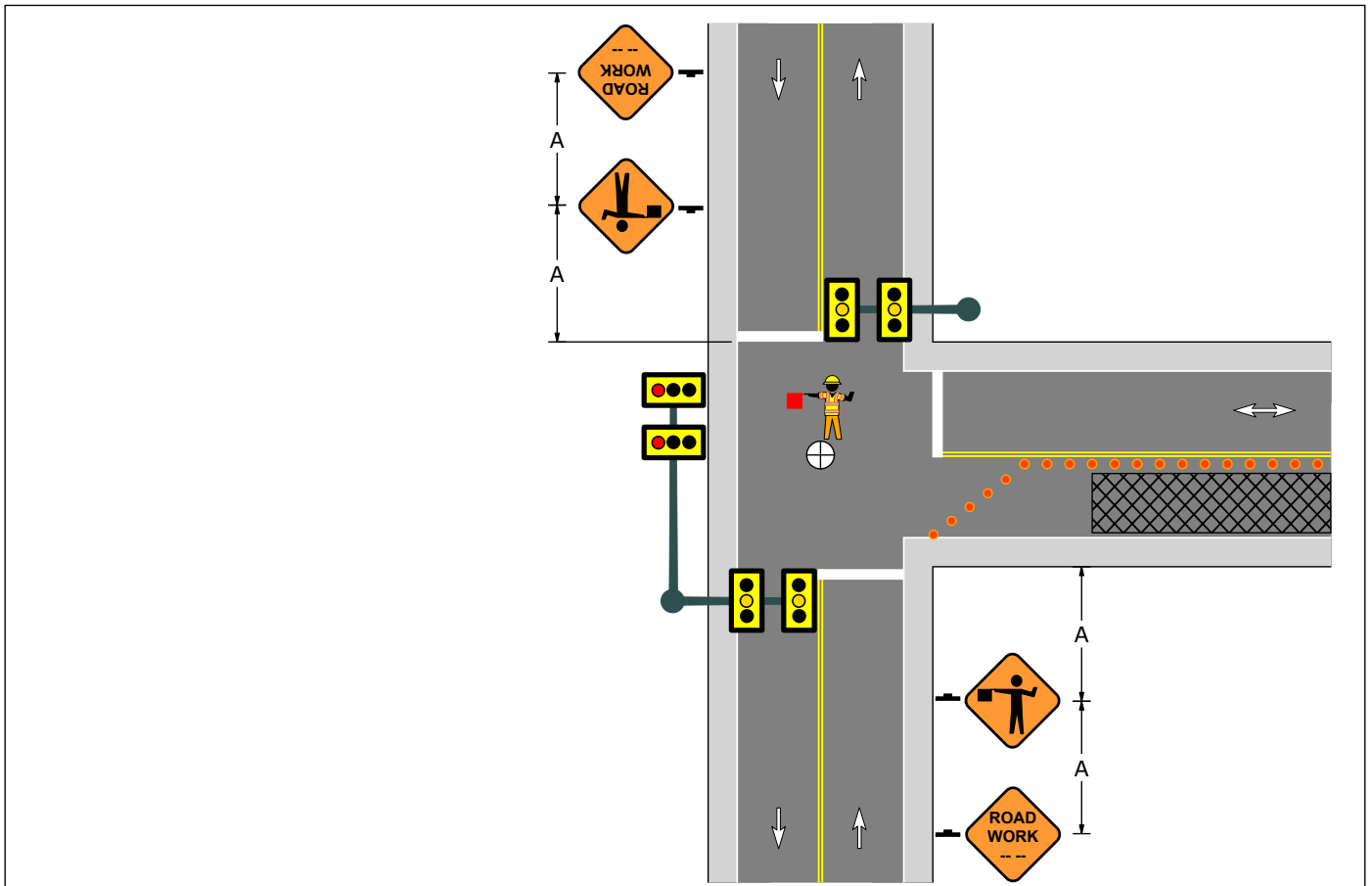
Figure 6-36
Intersection within the Advance Warning Area

**General Application 06
Intersection Approach Signing
Single Lane Approach**

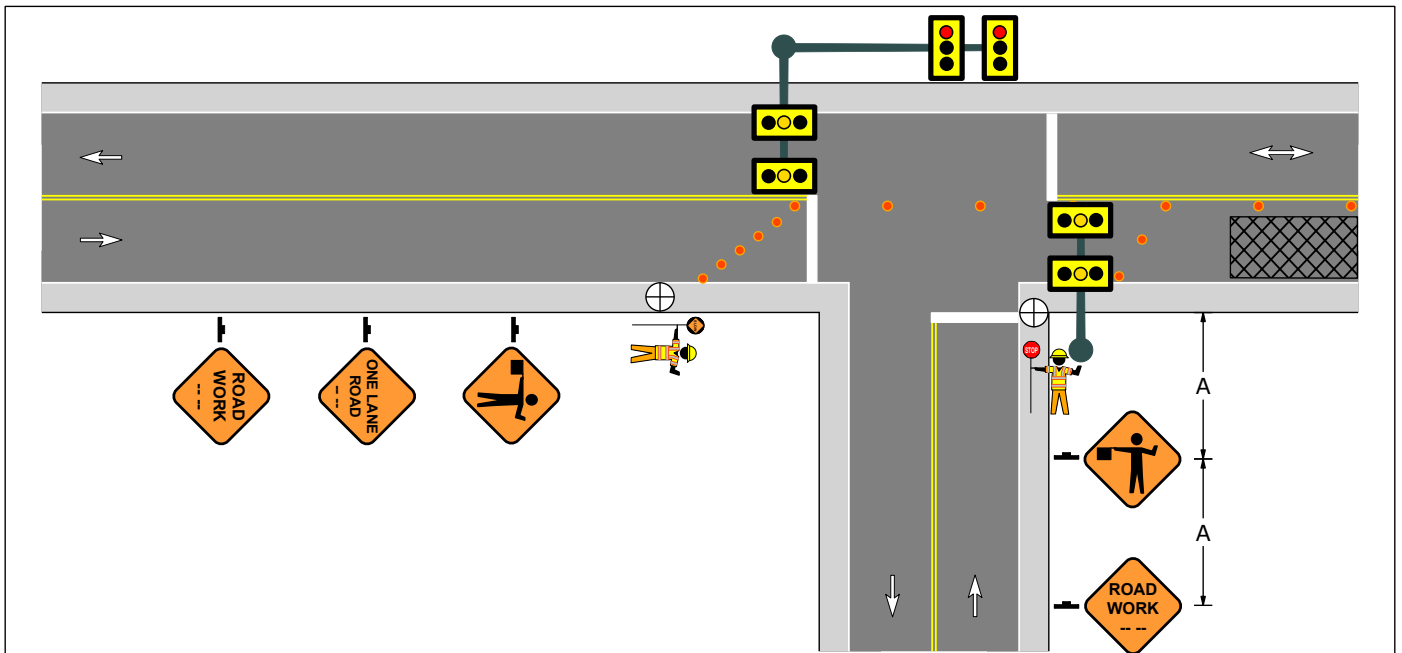


**Figure 6-37
Intersection within the Advance Warning Area**

**General Application 06
Intersection Approach Signing
Single Lane Approach**



**Figure 6-38
Intersection within the Advance Warning Area**



**Figure 6-39
Intersection within the Activity Area**

General Application 06 Intersection Approach Signing Single Lane Approach

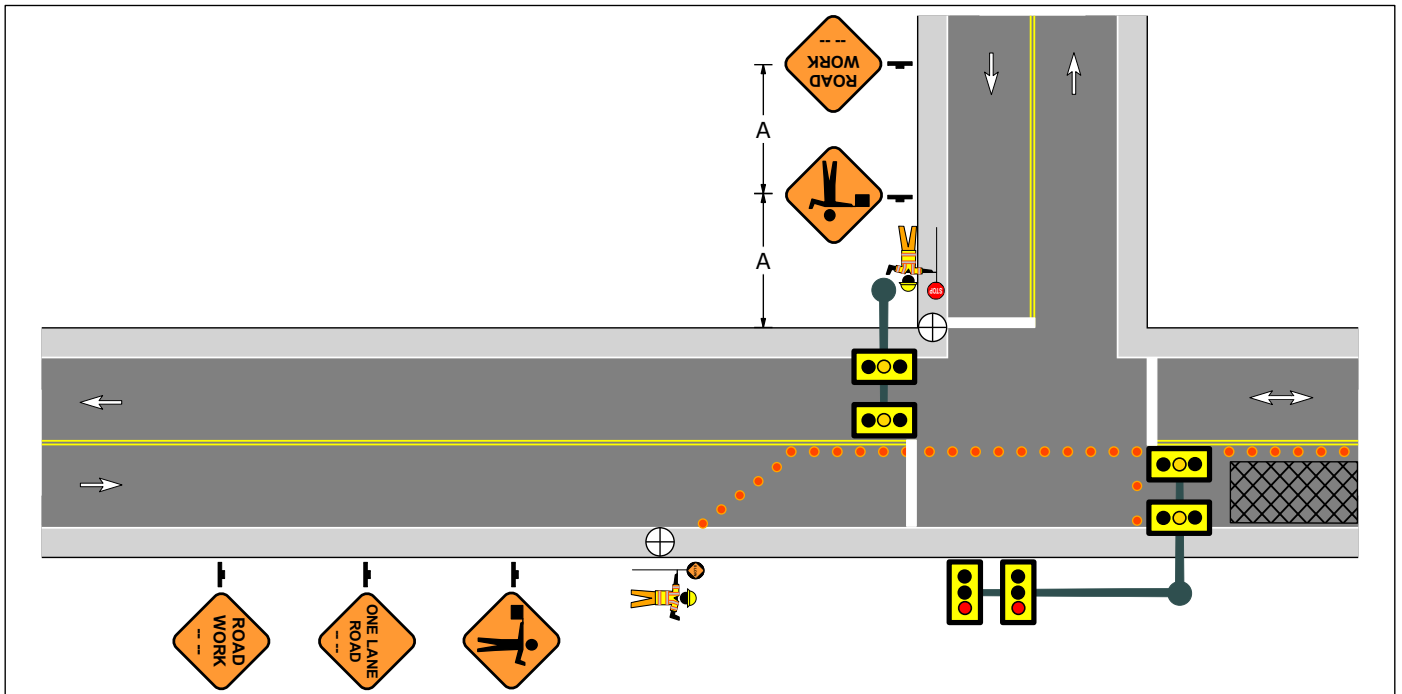


Figure 6-40
Intersection within the Activity Area

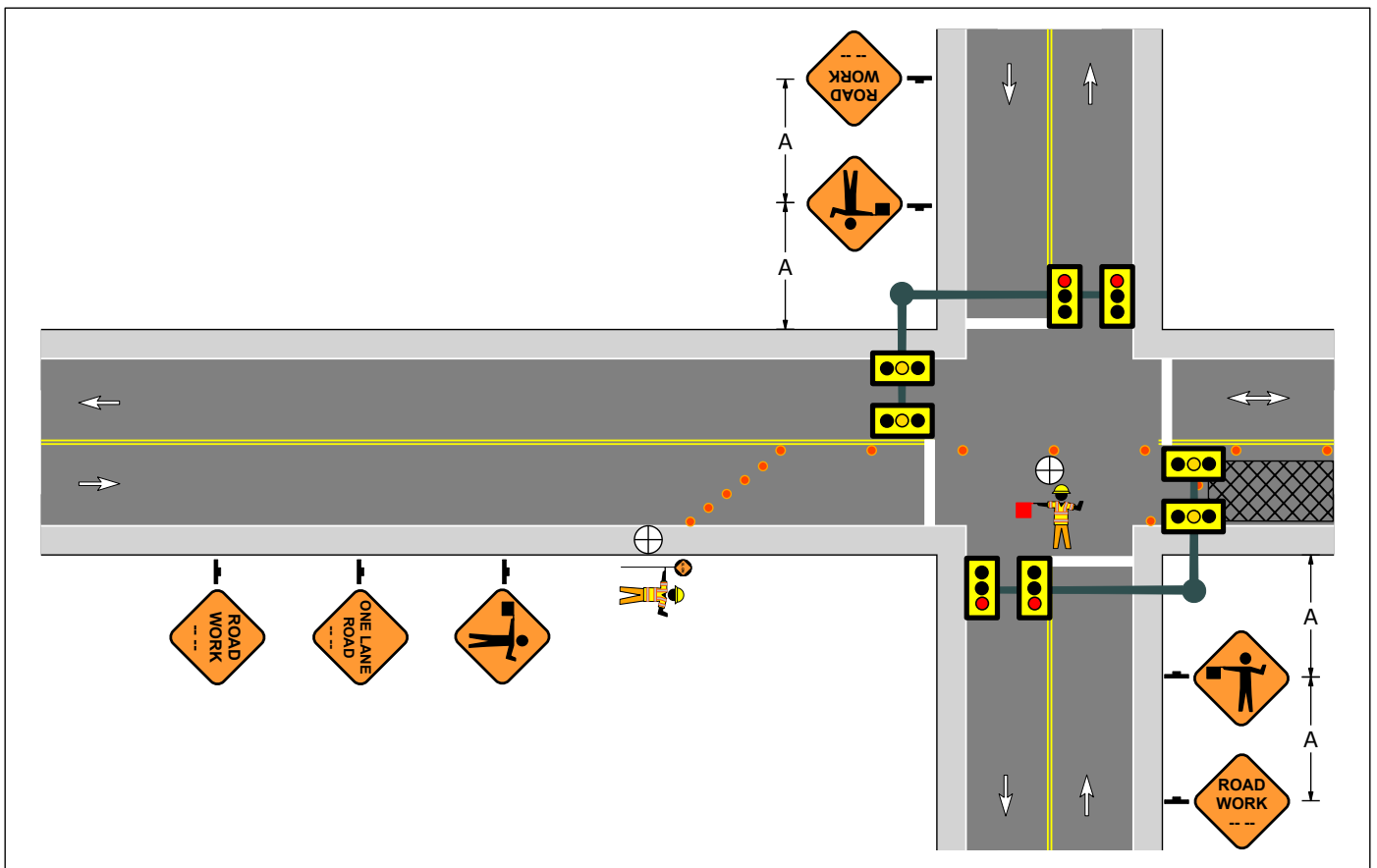
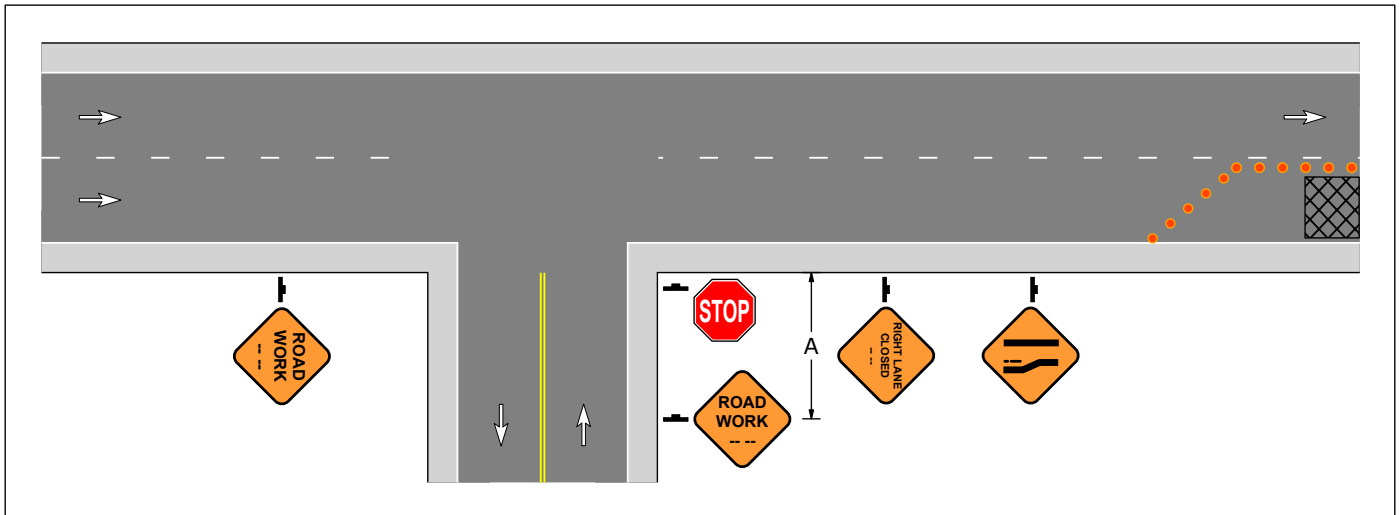
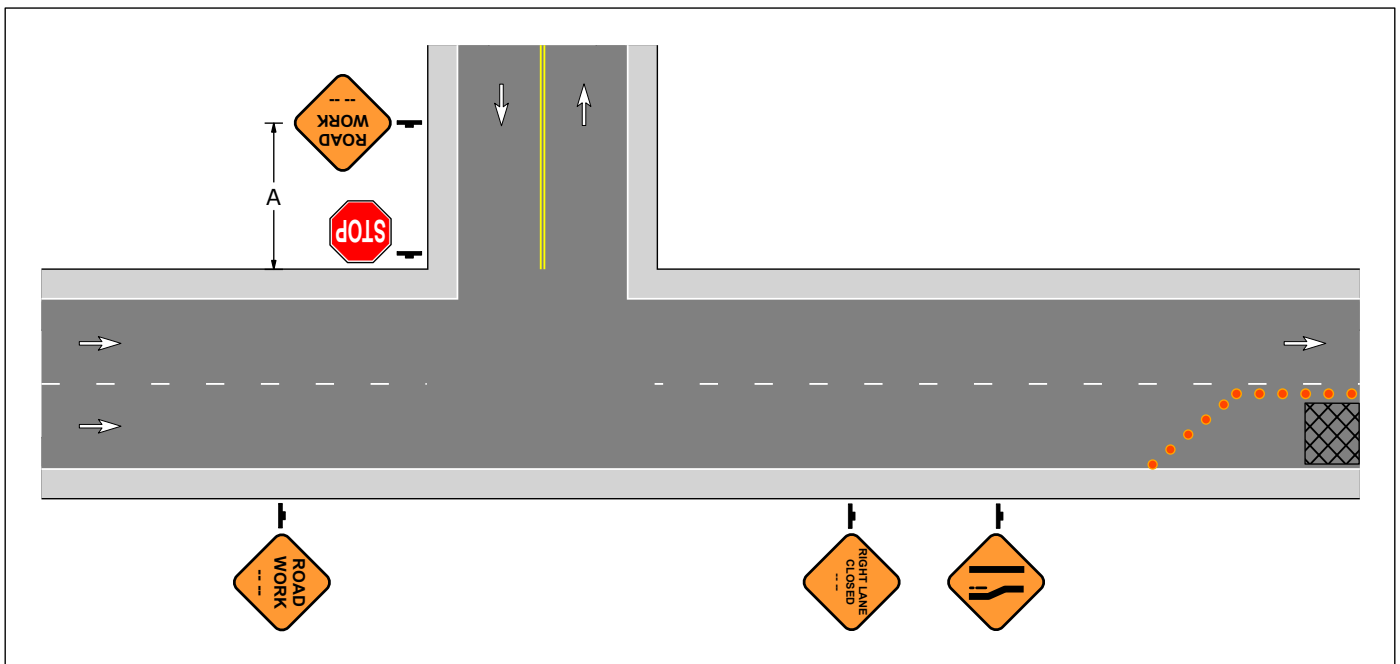


Figure 6-41
Intersection within the Activity Area

**General Application 06
Intersection Approach Signing
Multi-Lane Approach**

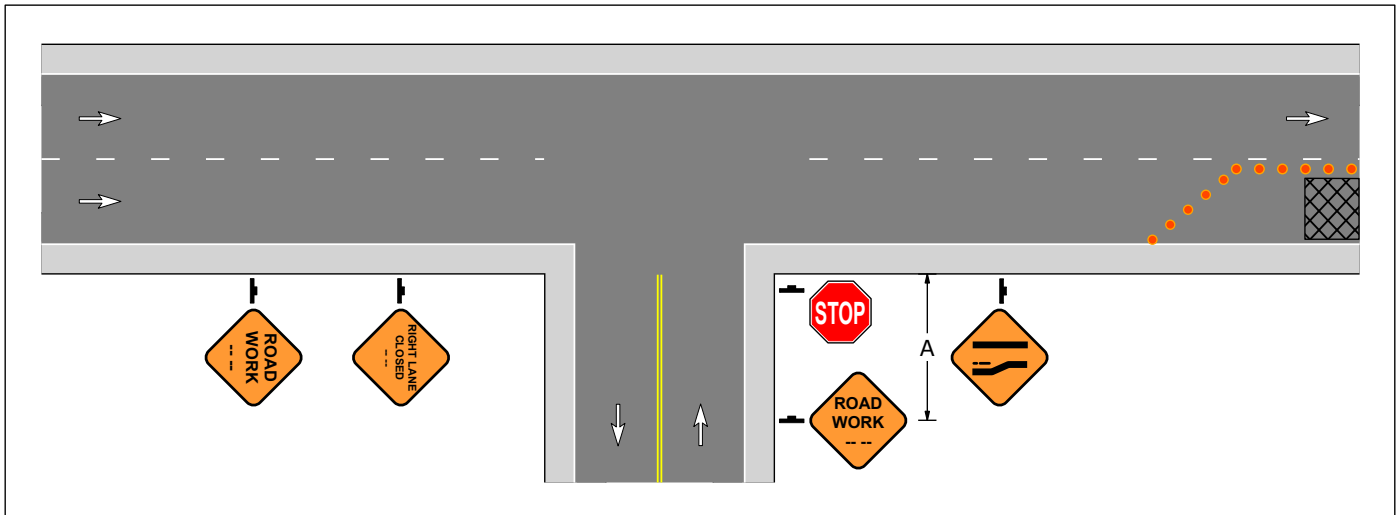


**Figure 6-42
Intersection within the Advance Warning Area**

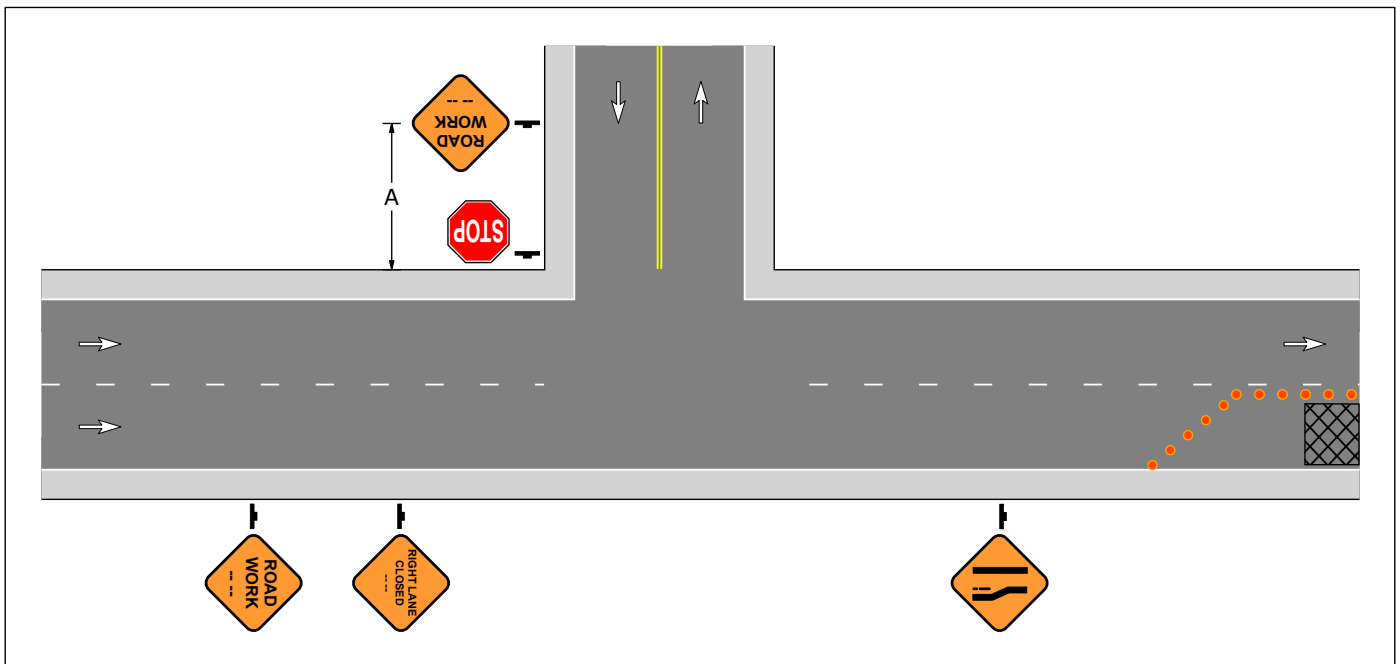


**Figure 6-43
Intersection within the Advance Warning Area**

**General Application 06
Intersection Approach Signing
Multi-Lane Approach**

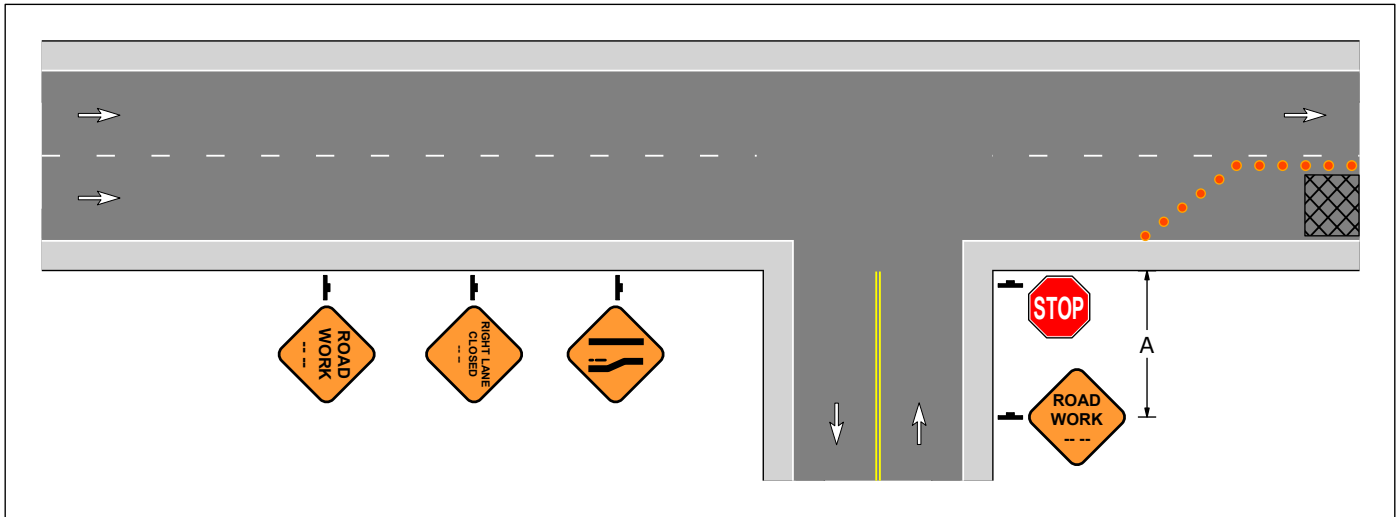


**Figure 6-44
Intersection within the Advance Warning Area**

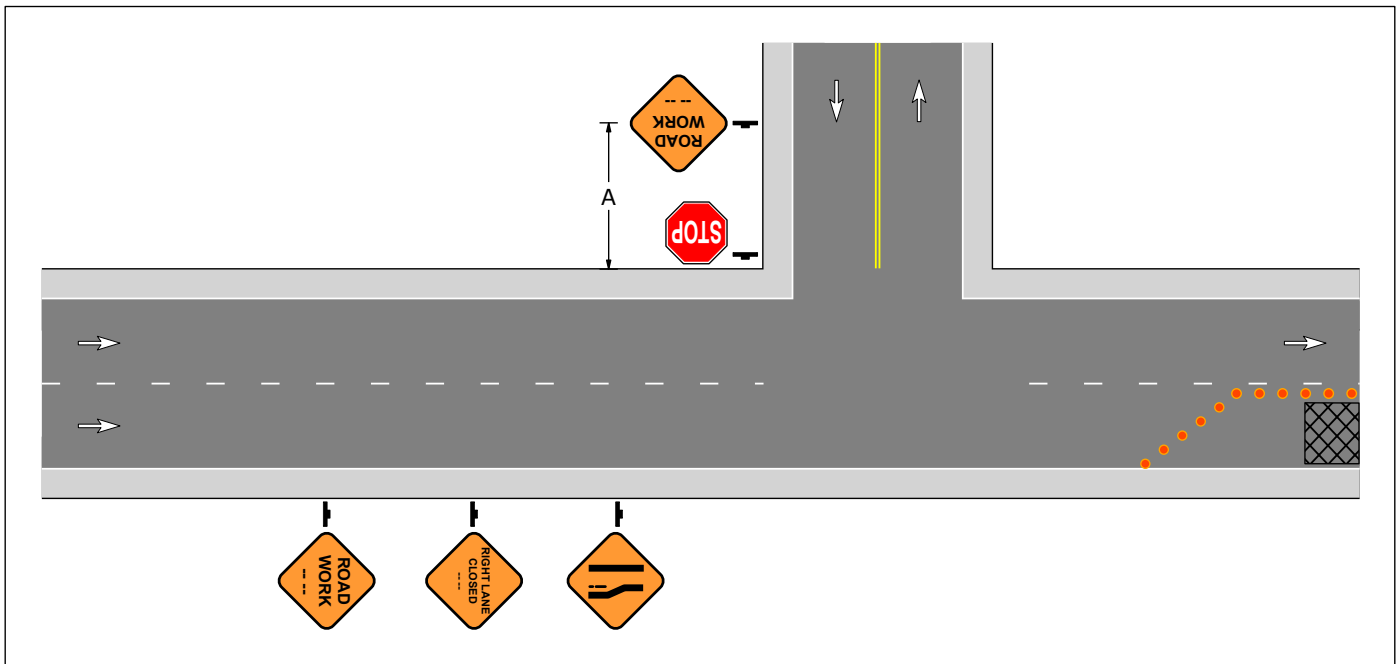


**Figure 6-45
Intersection within the Advance Warning Area**

**General Application 06
Intersection Approach Signing
Multi-Lane Approach**

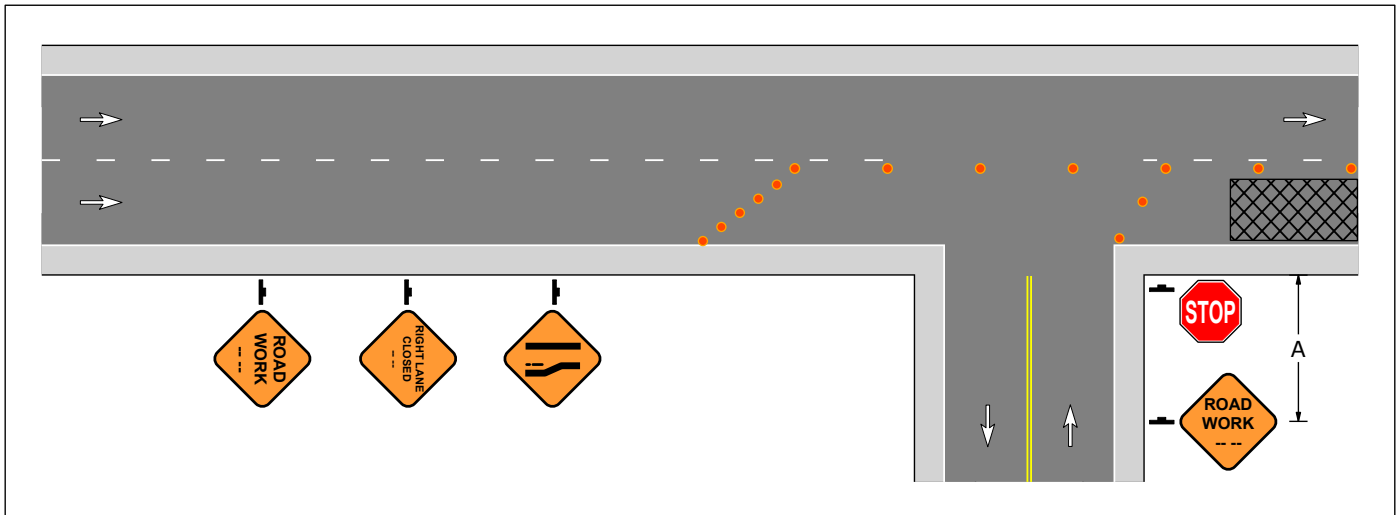


**Figure 6-46
Intersection within the Advance Warning Area**

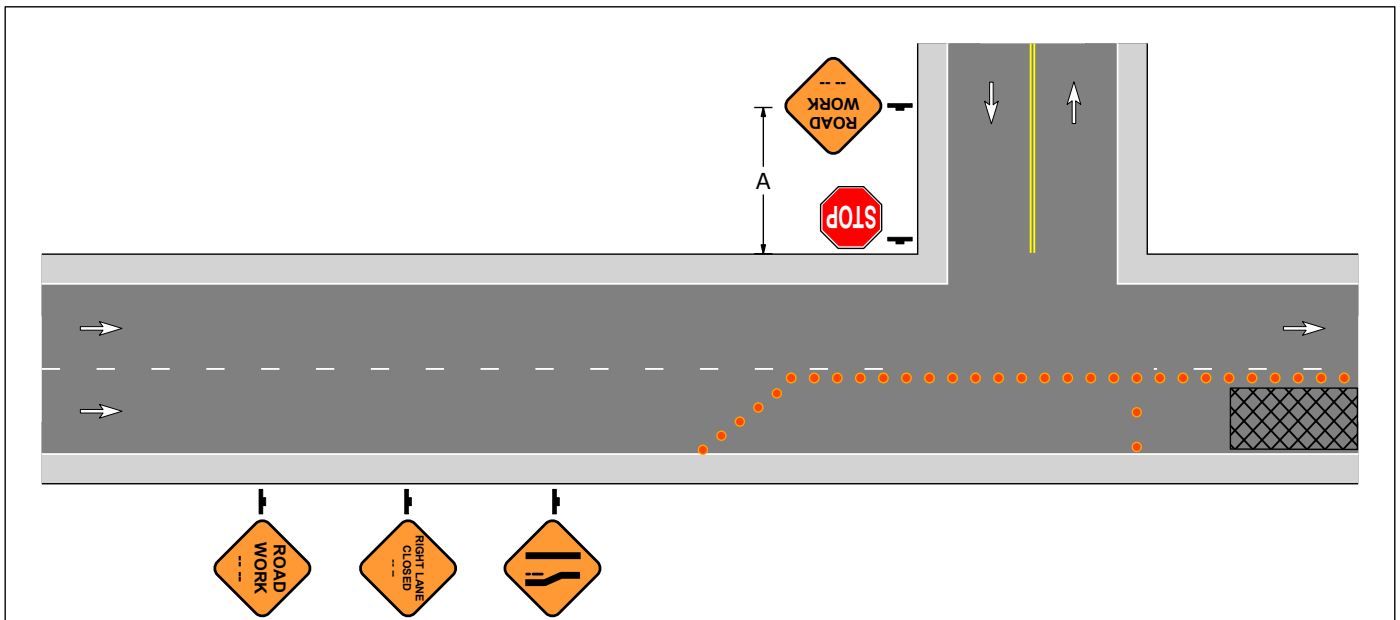


**Figure 6-47
Intersection within the Advance Warning Area**

**General Application 06
Intersection Approach Signing
Multi-Lane Approach**

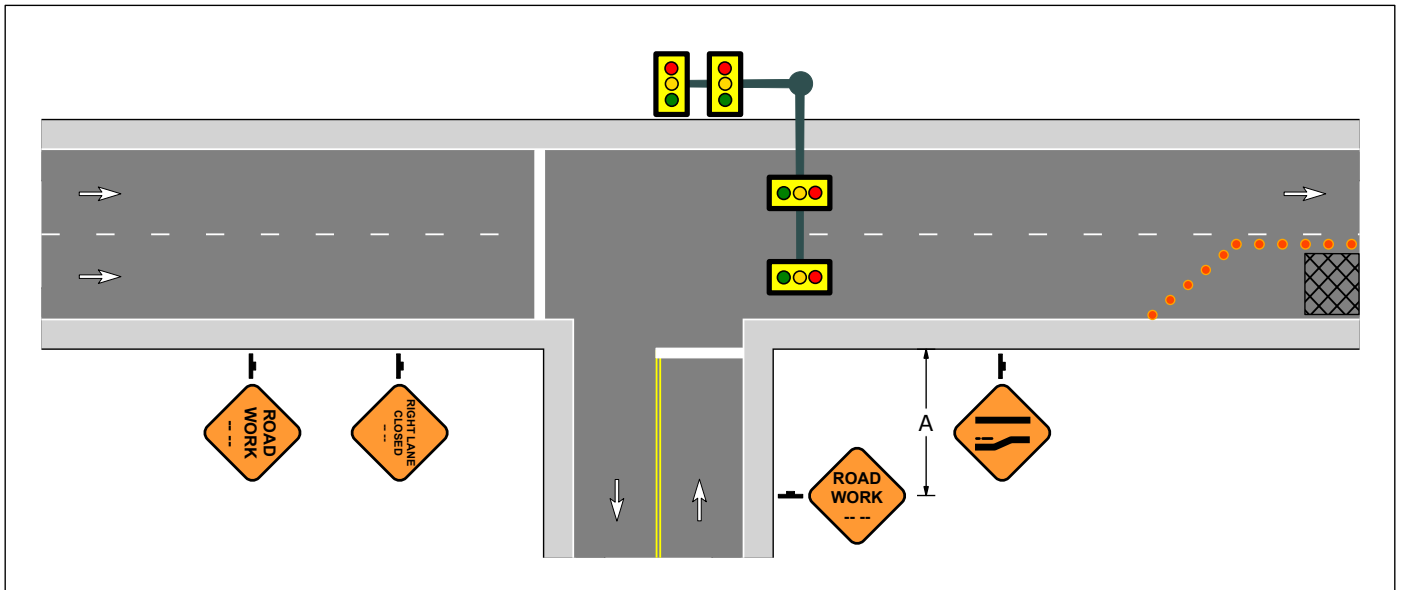


**Figure 6-48
Intersection within the Activity Area**

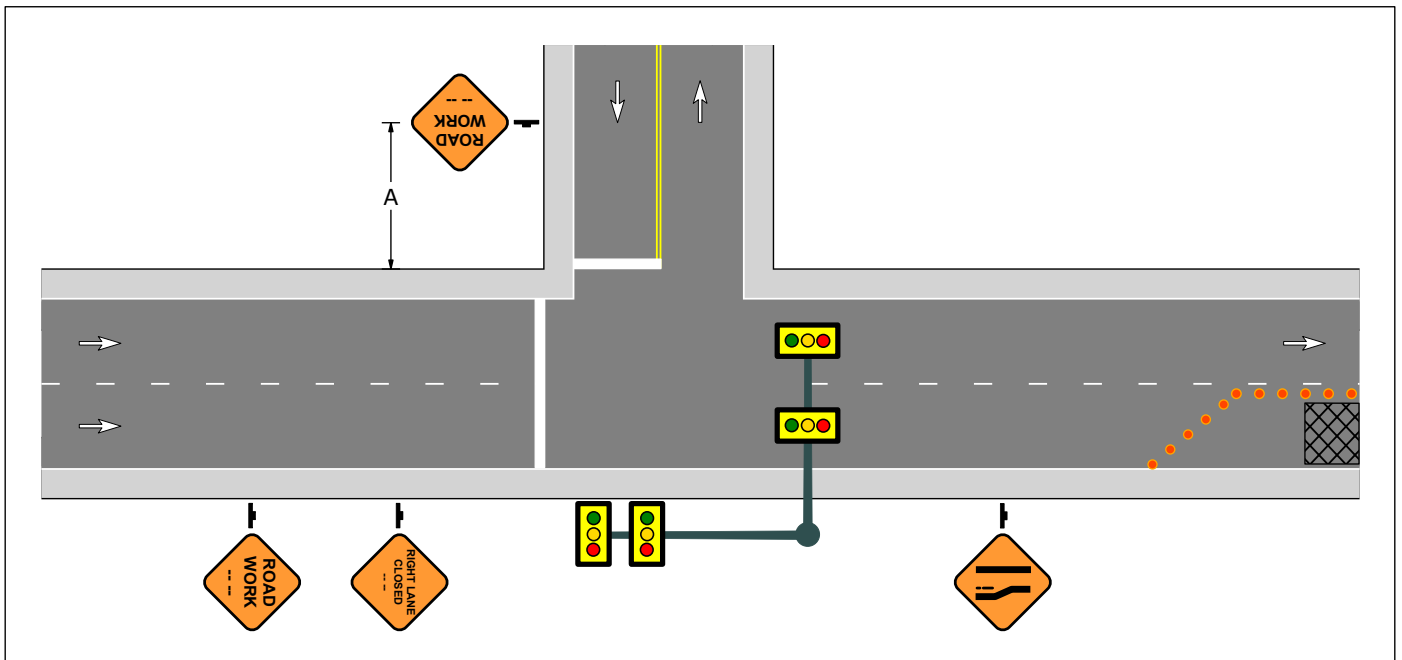


**Figure 6-49
Intersection within the Activity Area**

**General Application 06
Intersection Approach Signing
Multi-Lane Approach**

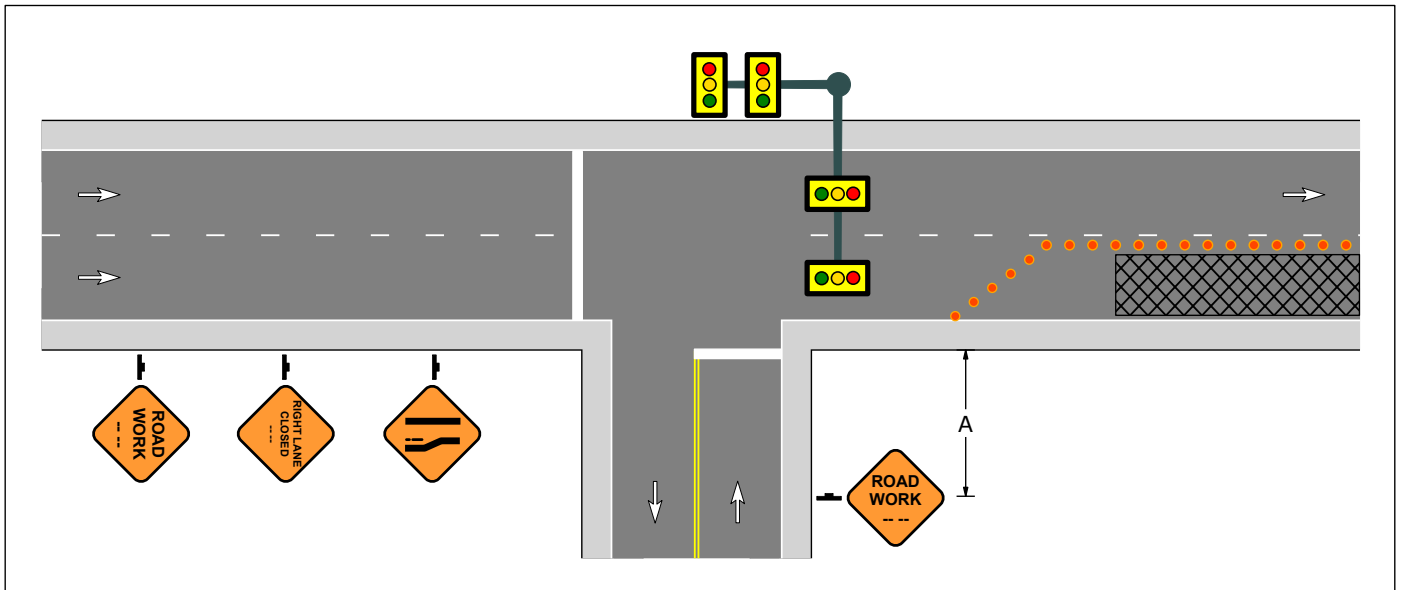


**Figure 6-52
Intersection within the Advance Warning Area**

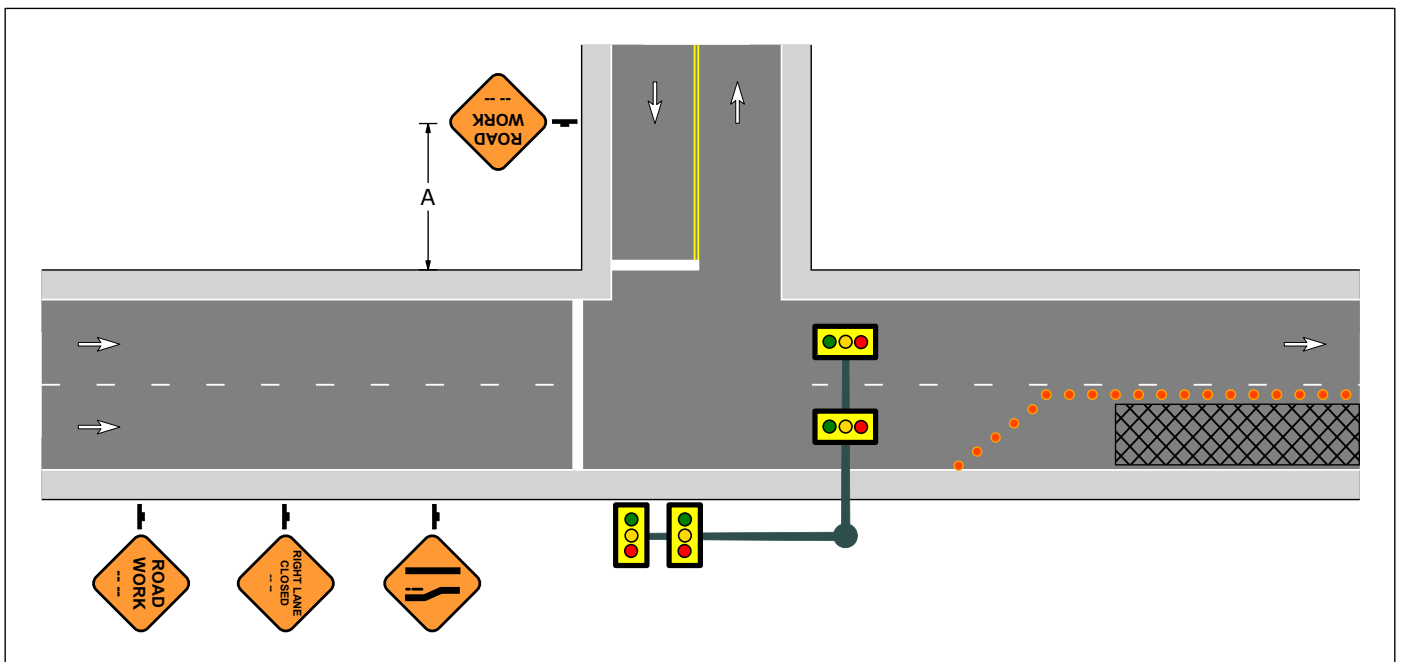


**Figure 6-53
Intersection within the Advance Warning Area**

**General Application 06
Intersection Approach Signing
Multi-Lane Approach**

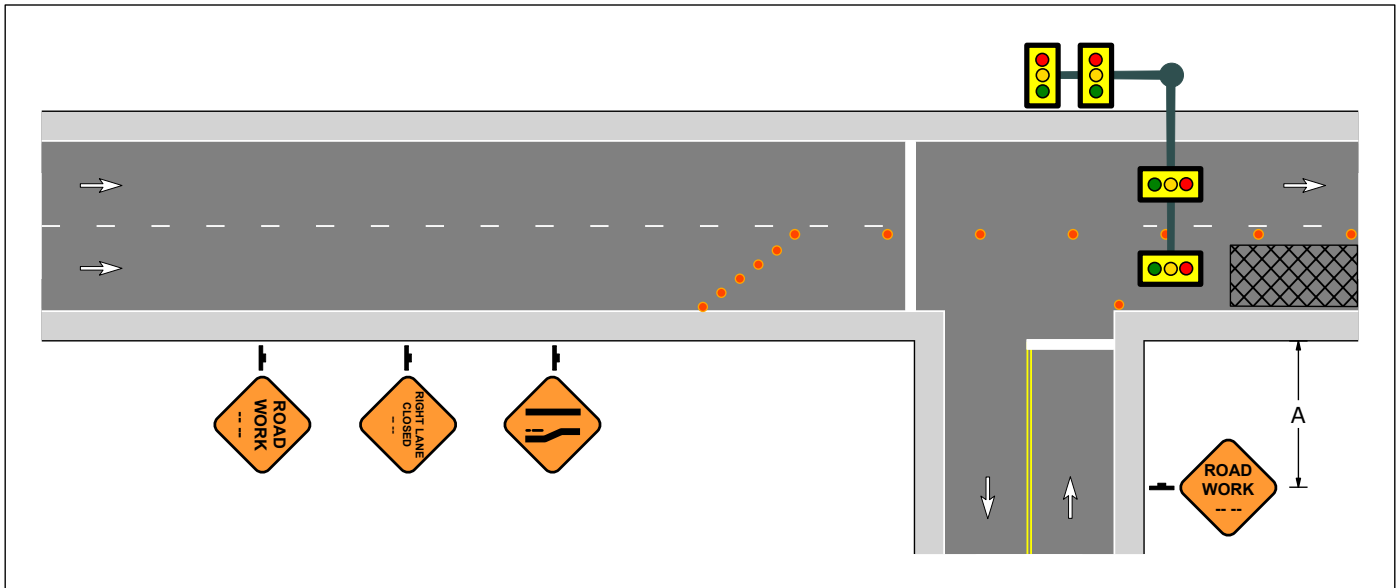


**Figure 6-54
Intersection within the Advance Warning Area**

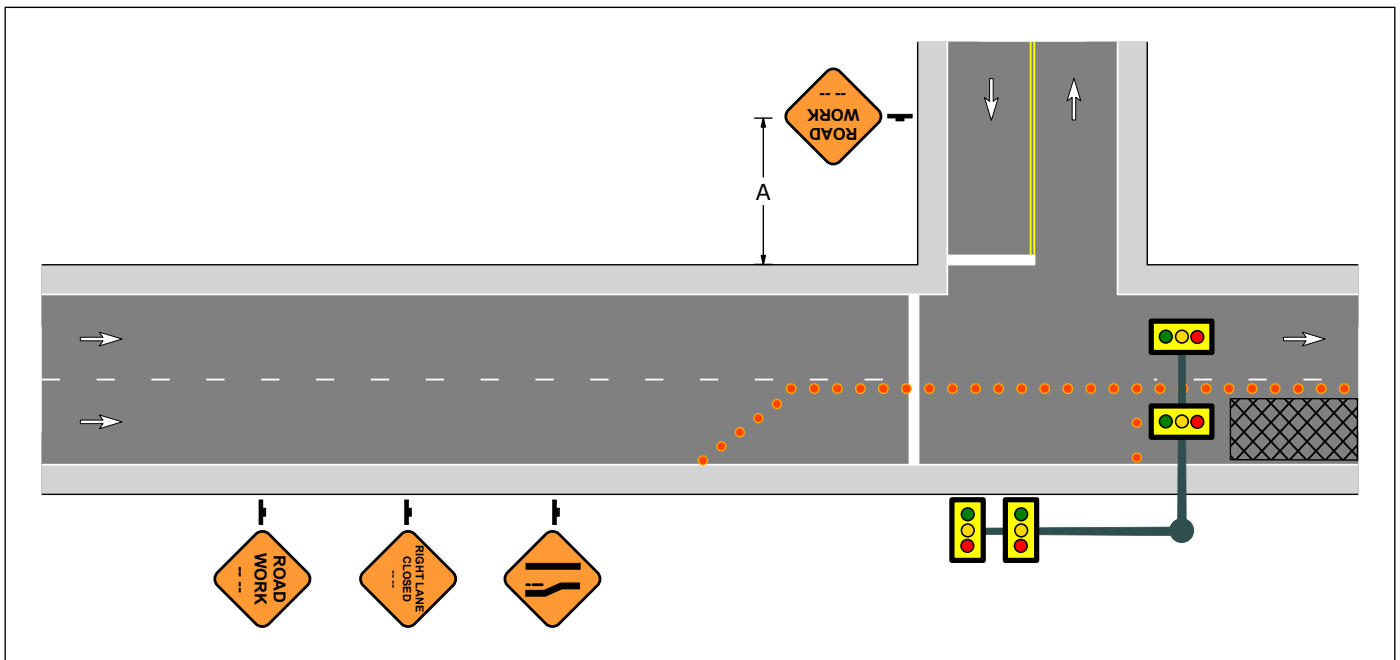


**Figure 6-55
Intersection within the Advance Warning Area**

**General Application 06
Intersection Approach Signing
Multi-Lane Approach**



**Figure 6-56
Intersection within the Activity Area**



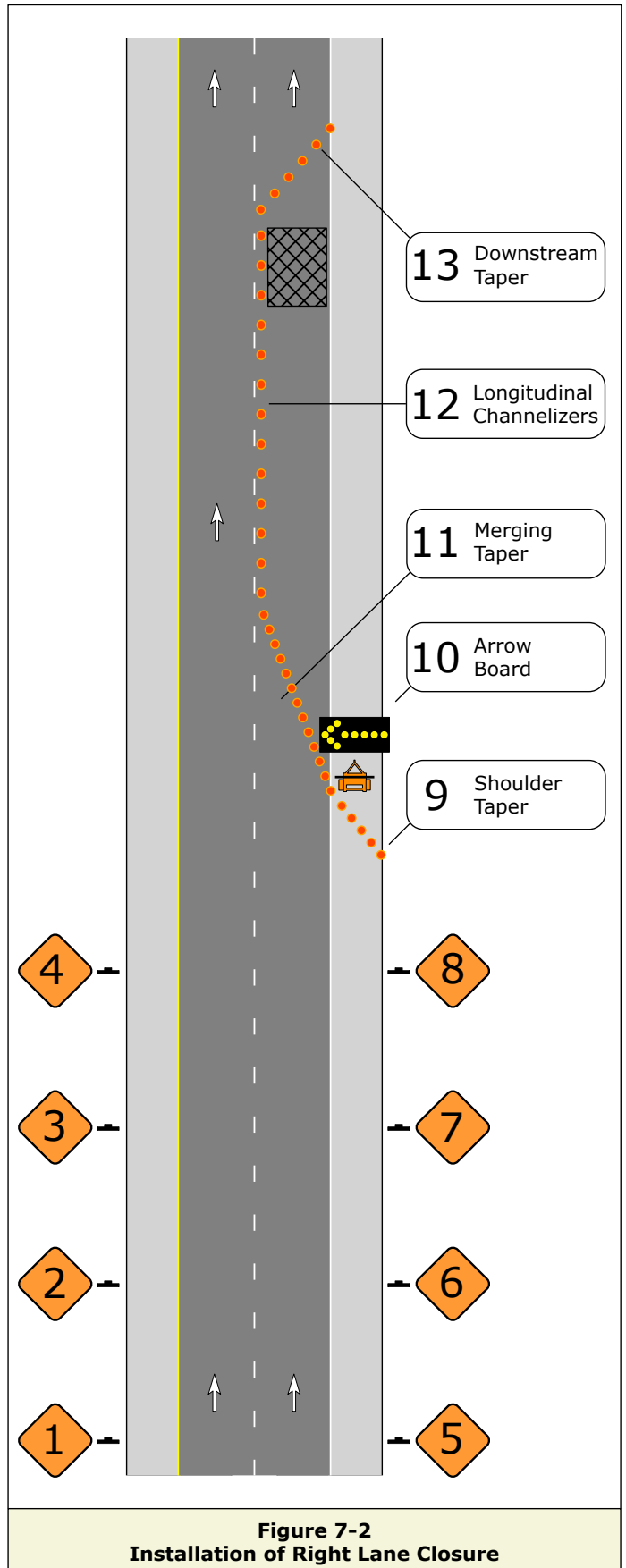
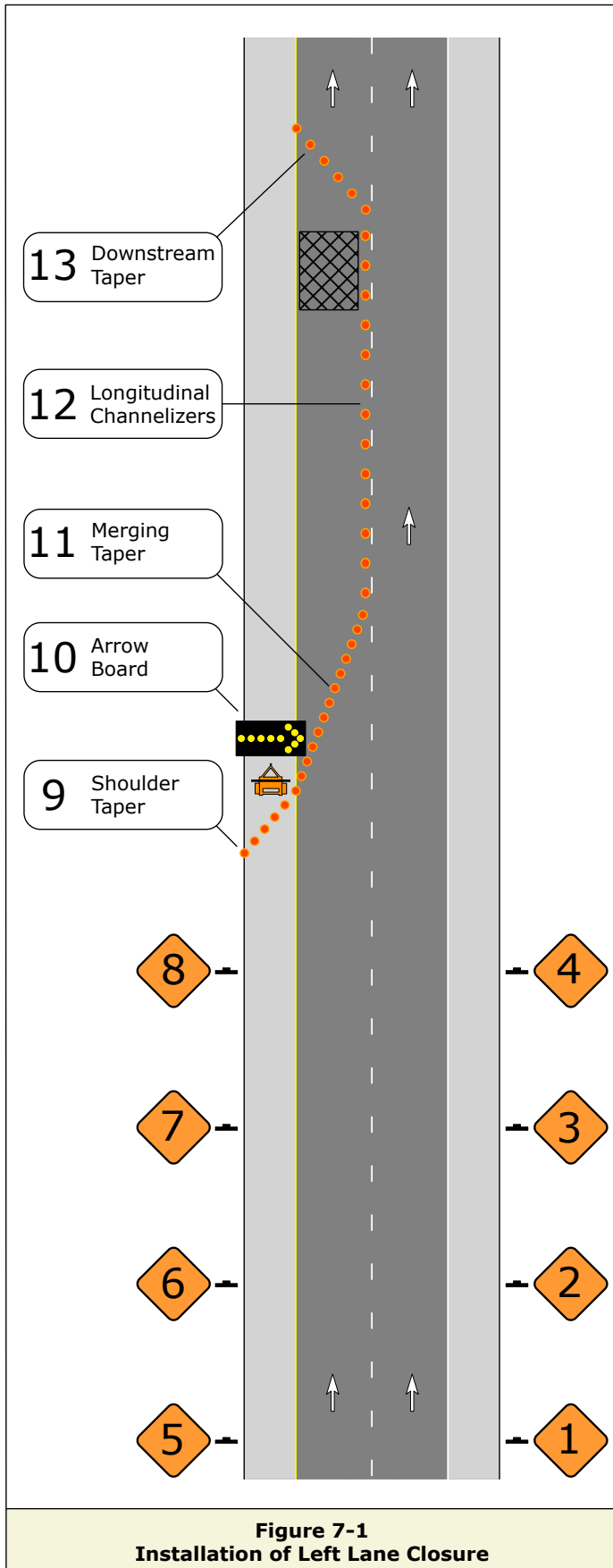
**Figure 6-57
Intersection within the Activity Area**

Blank Page

General Application 07-A TTC Device Installation Sequence on Freeways and Expressways

1. General Application 07-A provides guidance on the installation sequence of TTC devices on freeways and expressways.
2. During installation of TTC signs within the advance warning area:
 - a) Utilize PATA 601 if workers or work vehicles will remain on or beyond the shoulder.
 - b) Utilize PATA 602 if workers or work vehicles will encroach upon the roadway.
3. Channelizing devices shall be installed in the downstream direction.

General Application 07-A TTC Device Installation Sequence on Freeways and Expressways

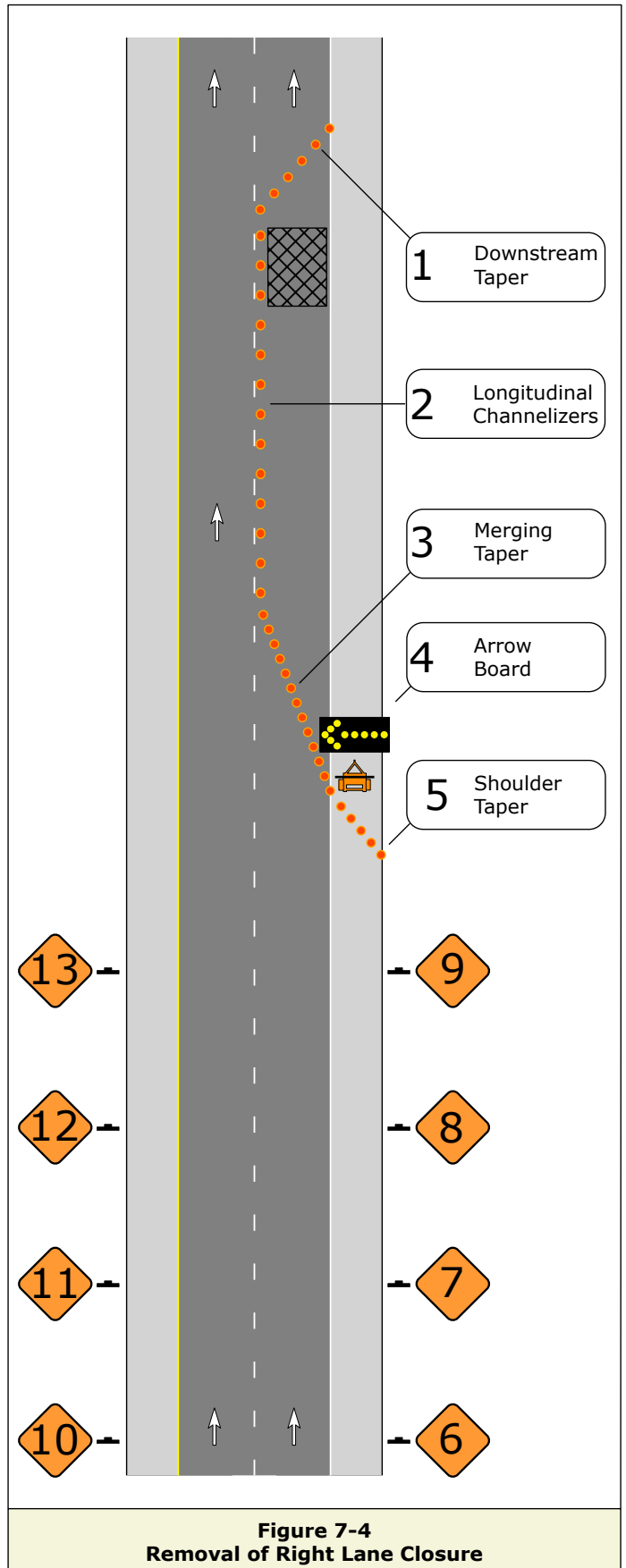
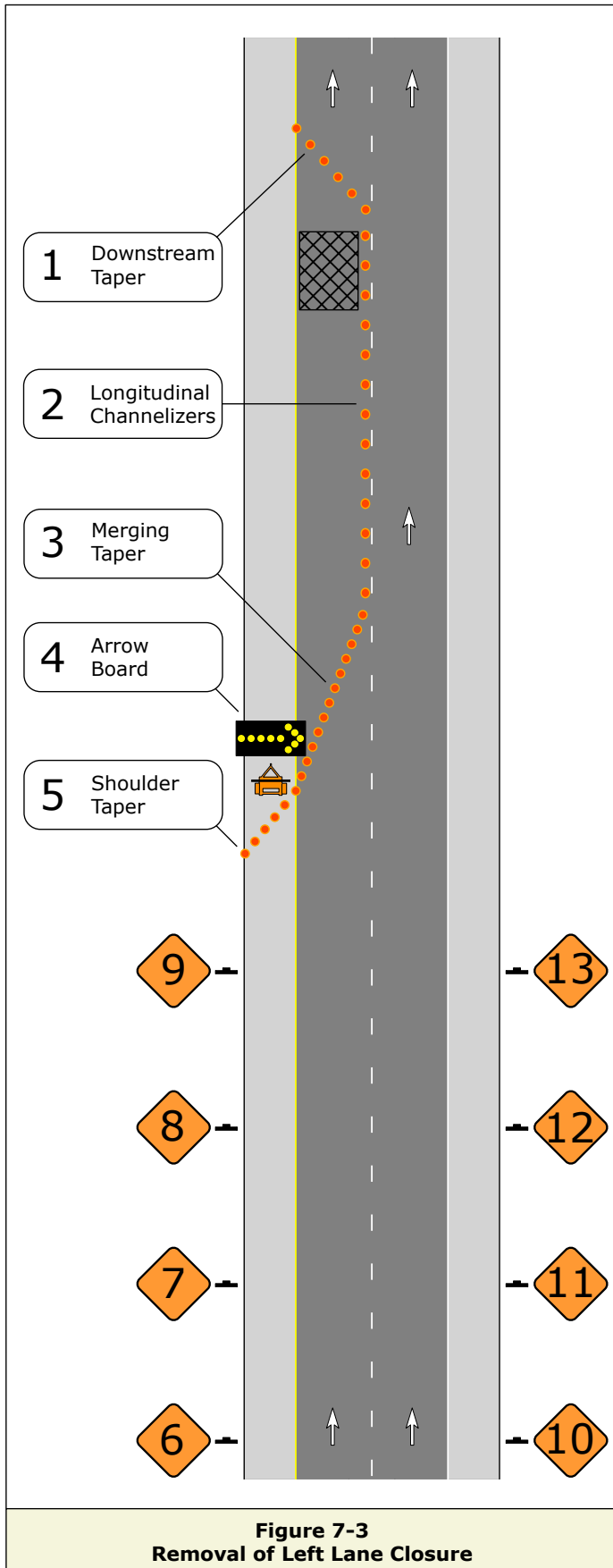


General Application 07-B

TTC Device Removal Sequence on Freeways and Expressways

1. General Application 07-B provides guidance on the removal sequence of TTC devices on freeways and expressways.
2. During removal of TTC signs within the advance warning area:
 - a) Utilize PATA 601 if workers or work vehicles will remain on or beyond the shoulder.
 - b) Utilize PATA 602 if workers or work vehicles will encroach upon the roadway.
3. Channelizing devices should be removed in the upstream direction.

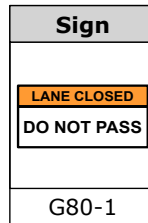
General Application 07-B TTC Device Removal Sequence on Freeways and Expressways



General Application 07-C

Rolling Slow Down to Install/Modify/Remove TTC Devices on Freeways and Expressways

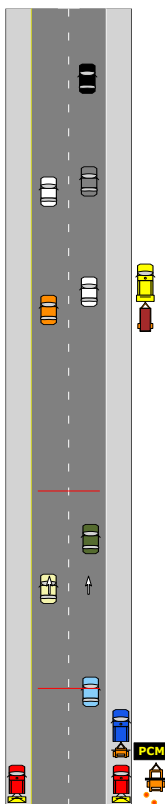
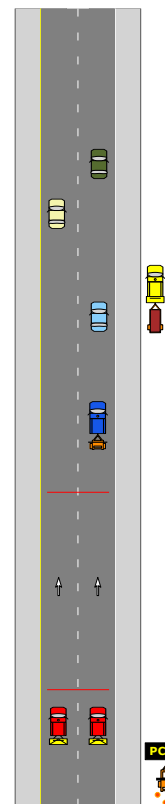
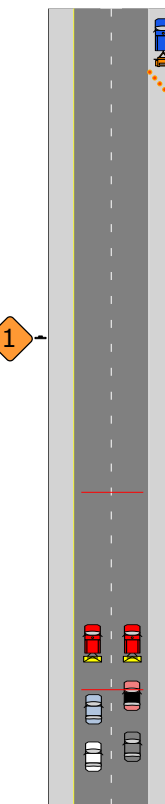
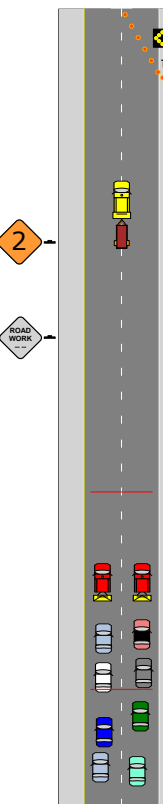












1. General Application 07-C may be used to install, change, or remove TTC devices on freeways and expressways.
2. One PCMS shall be installed upstream of SV1 & SV2. Activate the PCMS with an approved message (Refer to General Notes, Section E) during Stage 1 through Stage 7. During or upon completion of Stage 8 the PCMS message shall be changed to meet current traffic conditions or deactivated. A permanent message sign may be substituted for the PCMS if it is located in the vicinity of the required location.
3. One shadow vehicle per travel lane is required. Additional shadow vehicles may be utilized on the shoulders in line with the shadow vehicles on the roadway.
4. The first drawing depicts the overall layout of a typical lane closure with components of this installation procedure. Step-by-step instructions are shown on the final two drawings. Additional resources may be required depending upon roadway conditions.
5. Entrance ramps located within the limits of this plan must be controlled.
6. Numbers on the TTC signs show the installation and removal sequence.



General Application 07-C

Rolling Slow Down to Install/Modify/Remove TTC Devices on Freeways and Expressways

Stages 1 - 4

Stage 1	Stage 2	Stage 3	Stage 4
			
Duties	Duties	Duties	Duties
 FWT Stage vehicle along highway in front of SV1 or SV2.	 FWT Enter highway in front of SV1 and SV2 when a safe gap in traffic is observed. Follow last vehicle in line and drive by the LWV.	 FWT Drive by the LWV. Stop where the arrow board will be placed. Drop trailer, activate board, and place channelizing devices.	 FWT Place channelizing devices in merging taper and longitudinal line.
 SV1 and SV2 Stage vehicle along highway near the PCMS trailer.	 SV1 and SV2 Enter highway when safe gap in traffic occurs. Drive slowly, do not allow traffic to pass.	 SV1 and SV2 Maintain consistent low speed. Do not allow traffic to pass.	 SV1 and SV2 Maintain consistent low speed. Do not allow traffic to pass.
 LWV Stage vehicle with assembled TTC signs along highway at location where first sign will be installed.	 LWV Remain in LWV until the FWT has passed.	 LWV After the FWT has passed, install 1 signs on both sides of highway; proceed to 2 location.	 LWV Install 2 signs on both sides of highway; proceed to 3 location.

General Application 07-C

Rolling Slow Down to Install/Modify/Remove TTC Devices on Freeways and Expressways

Stages 5 - 8









Stage 5	Stage 6	Stage 7	Stage 8
Duties	Duties	Duties	Duties
FWT Continue placing channelizing devices.	FWT Monitor LWV crew. Notify SV drivers when LWV has left the roadway.	FWT Monitor activities.	Modify the PCMS message to reflect actual conditions or, if conditions warrant, the PCMS may be deactivated. See Note 2. Crew Leader shall conduct a meeting with all involved. Discuss procedures and opportunities to increase safety and reduce the amount of time the entire procedure takes.
SV1 and SV2 Maintain consistent low speed. Do not allow traffic to pass.	SV1 and SV2 Maintain consistent low speed. Do not allow traffic to pass.	SV1 and SV2 When notified by Foreman, remove SV1 & SV2 from the roadway. Traffic will begin using the new pattern immediately.	
LWV Install 3 signs on both sides of highway; proceed to 4 location.	LWV Install 4 signs on both sides of highway. Remove LWV from roadway.		

General Application 08 Lane Geometry Warning Signs

1. General Application 08 provides guidance on roadway geometry signs. Choosing the appropriate sign is based upon the horizontal alignment and the speed at which they can be safely maneuvered.

- The LANE SHIFT sign may be used for lane shifts that can be safely navigated at speeds equal to or greater than speed limit. This sign is most commonly appropriate where the offset width (W) is less than the full lane width.
- The REVERSE CURVE (W1-4) sign may be used for lane shifts where safe operating speeds are greater than 30 MPH. An ADVISORY SPEED PLAQUE (W13-1P) sign shall be placed below the sign if the maximum safe speed is less than the regulatory speed limit. This sign is most commonly appropriate where the offset width (W) is equal to or greater than the full lane width.
- The REVERSE TURN (W1-3) sign may be used for lane shifts where safe operating speeds are 30 MPH or below. An ADVISORY SPEED PLAQUE (W13-1P) sign shall be placed below the sign if the maximum safe speed is less than the regulatory speed limit.
- The DOUBLE REVERSE CURVE (W24-1) signs may be used where two lane shifts have a tangent distance of less than 600'. An ADVISORY SPEED PLAQUE (W13-1P) sign shall be placed below the sign if the maximum safe speed is less than the regulatory speed limit.

2. Refer to PennDOT Publication 46, Exhibit 2-6 for sign placement.

Signs							
							
W1-3L	W1-3R	W1-4L	W1-4R	W5-5	W24-1L	W24-1R	W13-1P

General Application 08 Lane Geometry Warning Signs

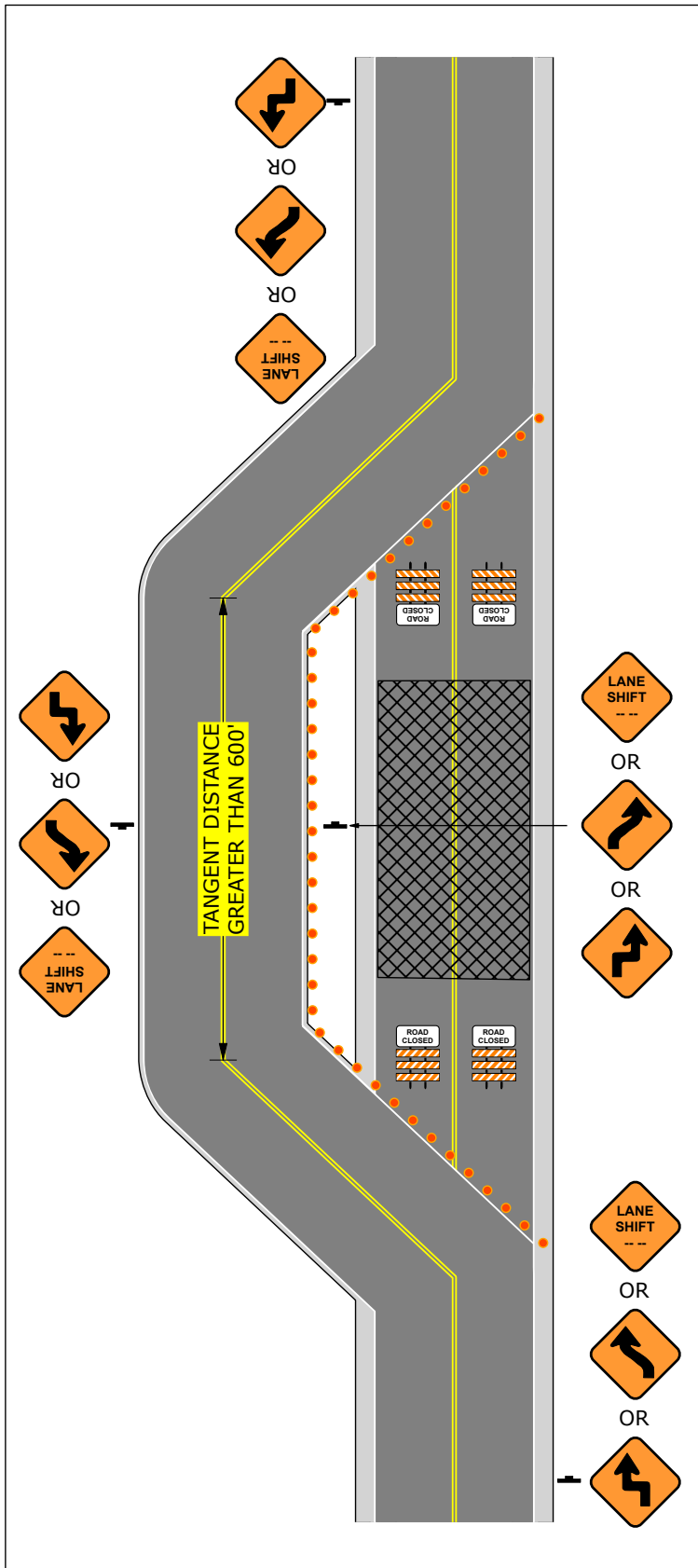


Figure 8-1
Tangent Distance Greater Than 600'

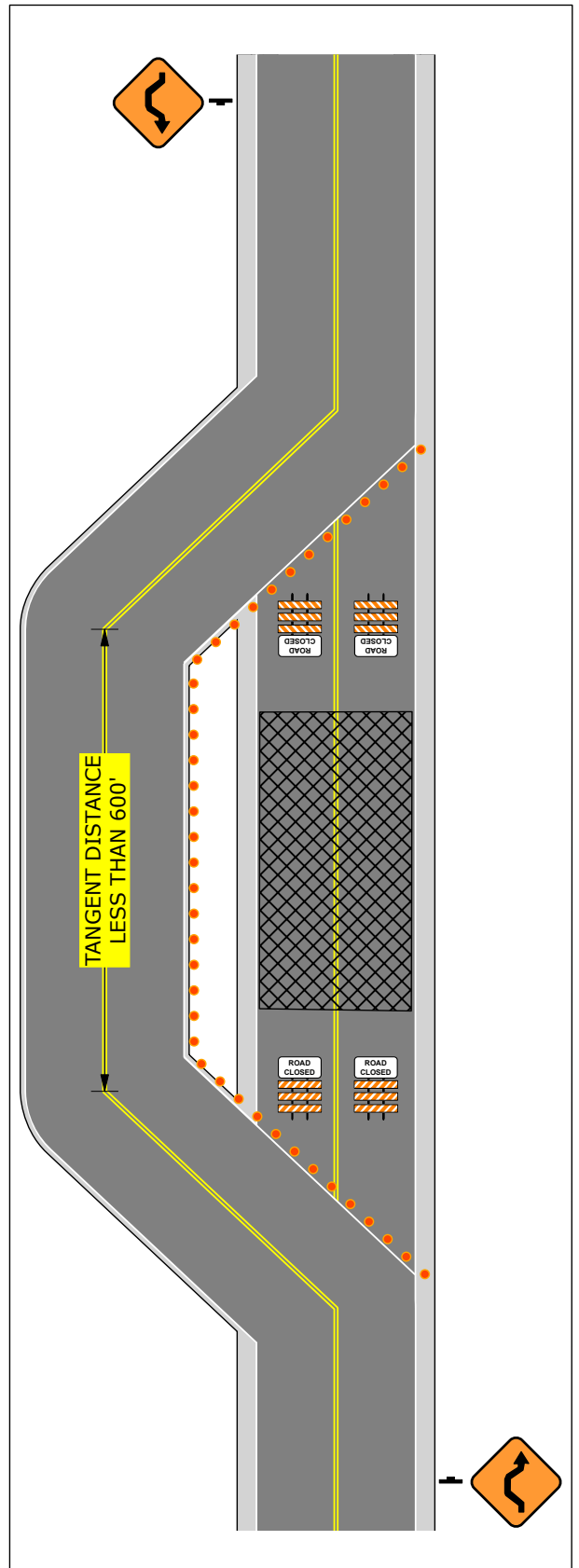


Figure 8-2
Tangent Distance Less Than 600'

General Application 09 Trailer-Mounted Equipment Lateral Placement and Delineation

1. General Application 09 provides guidance on trailer-mounted equipment placement and delineation.
2. Trailer-mounted equipment should be placed beyond the shoulder and behind a traffic barrier or at least 2' behind curb, if practical. Where a traffic barrier is not available, trailers should be placed outside of the clear zone. Trailers may be placed within the clear zone if no other suitable locations are available, however delineation is required. A typical setup for delineation is shown on this PATA, but other placement options are acceptable.
3. Retroreflective TTC devices shall be used to delineate trailers placed unprotected and within the clear zone. Drums and cones are most commonly used to satisfy this requirement. The type of channelizing devices (long-term or short-term) will depend upon the amount of time they will remain in place.
 - a) Long-term devices are required where the trailer will remain in place for more than 72 hours.
 - b) Short-term or long-term devices are required where the trailer will remain in place for up to 72 hours.
4. Trailers shall not be placed within the barrier deflection area. Refer to PennDOT Publication 13M, Table 12.4.
5. The chart shown below is provided as a quick reference guide of clear zone width requirements. It displays the largest width for each speed limit group assuming the highest Design ADT with the least traversable slope. Refer to PennDOT Publication 13M, Design Manual, Part 2, Chapter 12, for more information about clear zones.

Speed Limit (mph)	Estimated Clear Zone Width (feet)
≤40	16
45-50	24
55	26
>55	30

General Application 09 Trailer-Mounted Equipment Lateral Placement and Delineation

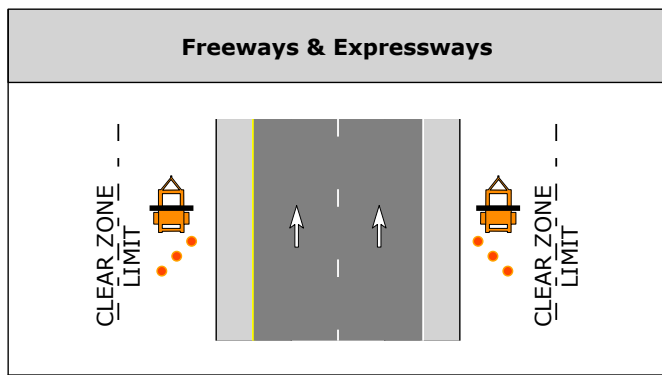
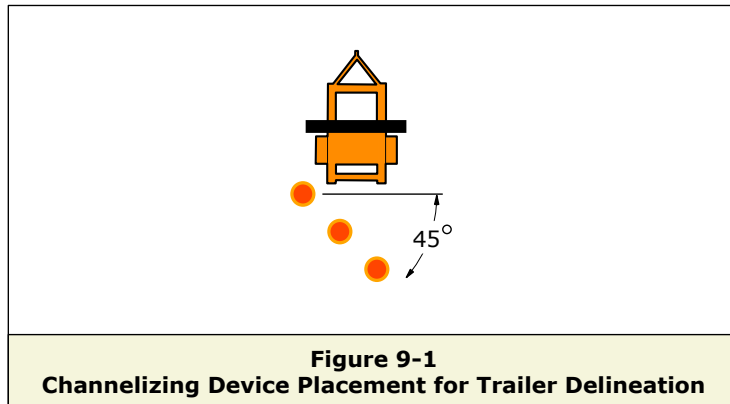


Figure 9-2
Unprotected Trailer within Clear Zone
Delineation is Required

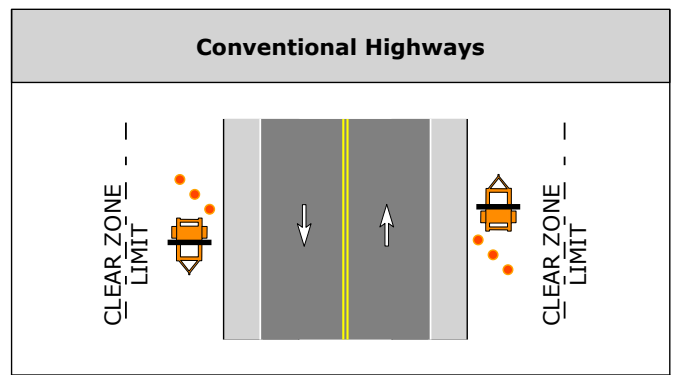


Figure 9-4
Unprotected Trailer within Clear Zone
Delineation is Required

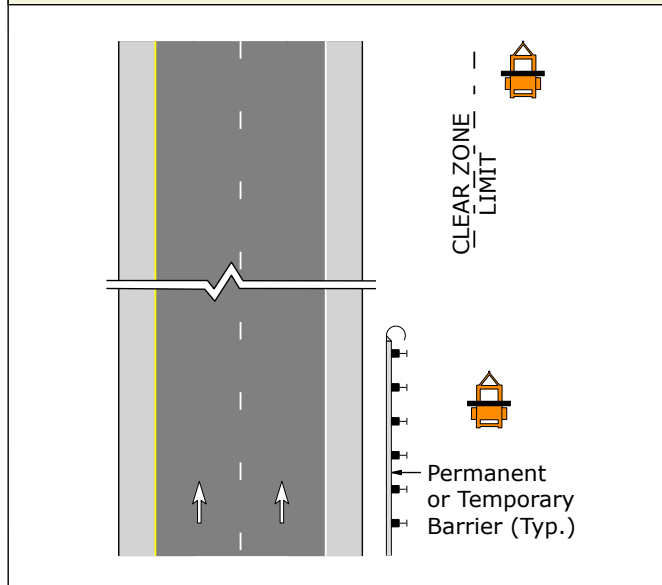


Figure 9-3
Trailer Outside Clear Zone or Behind Barrier
Delineation is Not Required

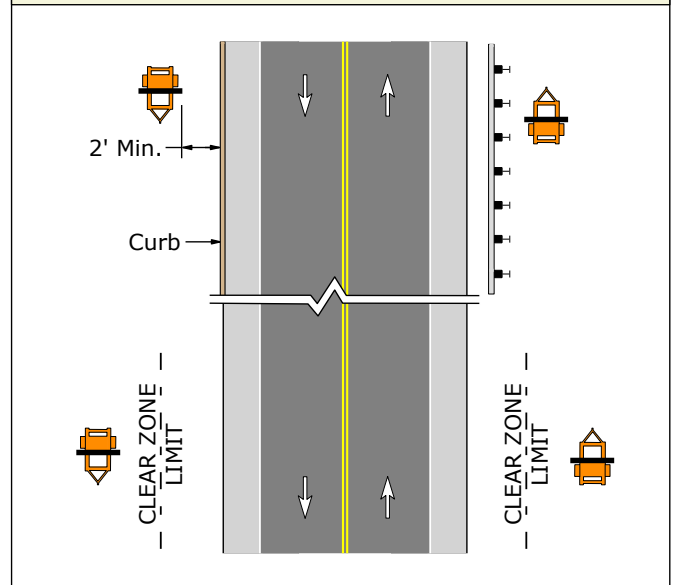


Figure 9-5
Trailer Outside Clear Zone or Behind Barrier
Delineation is Not Required

General Application 10 TTC Sign Installation

1. General Application 10 provides guidance on TTC sign installations.

2. TTC signs shall be installed at the proper lateral offset:

Highway Type	Type of Mount	Lateral Offset	
		Adjacent to Barrier	Not Adjacent to Barrier
Conventional Highways (Rural and Urban)	Portable Sign Support	2' Minimum from Roadway	
	Portable Sign Post	2' Minimum from Shoulder	
	Type III Barricade		
	Post Mounted		
Freeways and Expressways	Portable Sign Support	6' Minimum from Roadway	2' Minimum from Shoulder
	Portable Sign Post		
	Type III Barricade	6' Minimum from Roadway	
	Median Bracket		
	Post Mounted	2' Minimum from Shoulder	

3. TTC signs shall be mounted at the proper height:

Highway Type	Type of Mount	Mounting Height	
		Regulatory Sign	Non-Regulatory Sign
Rural Conventional Highway	Portable Sign Support	5' Minimum to Bottom of Sign	1' Minimum to Bottom of Sign
	Portable Sign Post	5' Minimum to Bottom of Sign and 8' Minimum to Top of Sign	
	Type III Barricade	10'-8" Minimum to Top of Sign	
	Post Mounted	5' Minimum to Bottom of Sign	
Urban Conventional Highway	Portable Sign Support	7' Minimum to Bottom of Sign	1' Minimum to Bottom of Sign
	Portable Sign Post	7' Minimum to Bottom of Sign and 8' Minimum to Top of Sign	
	Type III Barricade	10'-8" Minimum to Top of Sign	
	Post Mounted	7' Minimum to Bottom of Sign	
Freeways and Expressways	Portable Sign Support	7' Minimum to Bottom of Sign	1' Minimum to Bottom of Sign
	Portable Sign Post	7' Minimum to Bottom of Sign and 8' Minimum to Top of Sign	
	Type III Barricade	10'-8" Minimum to Top of Sign	
	Median Bracket	7' Minimum to Bottom of Sign	
	Post Mounted	7' Minimum to Bottom of Sign	

4. Supplemental plaques may be attached to the post nearest the roadway or centered under the sign.

5. TTC signs may be mounted on median barrier with an approved mounting bracket. TTC signs on median barrier shall be made of roll-up vinyl, corrugated polypropylene, or another approved flexible material.

6. Attaching a portable sign support to a guiderail post is acceptable if all of the following apply:

- a) There is not enough space behind the guiderail to properly place the TTC sign.
- b) Guiderail is not the primary divider between two-way traffic.
- c) Physical damage is not left on the guiderail beam, posts, or offset blocks when the TTC sign is removed.

7. STOP signs should be placed longitudinally near the desired stopping point or within 50' upstream.

8. YIELD signs should be placed longitudinally near the desired yield point or within 50' upstream.

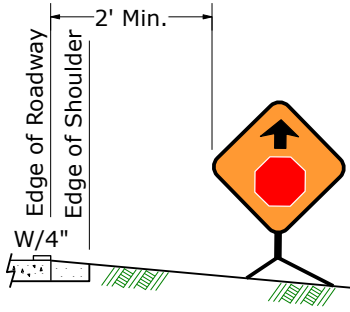
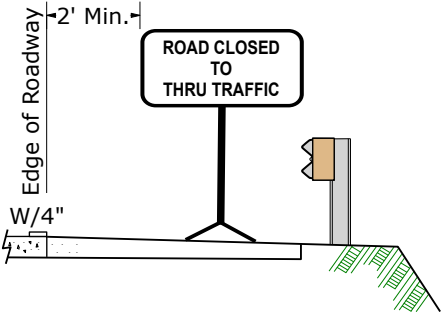
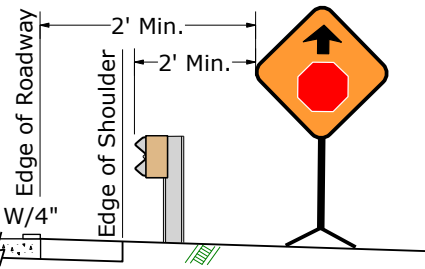
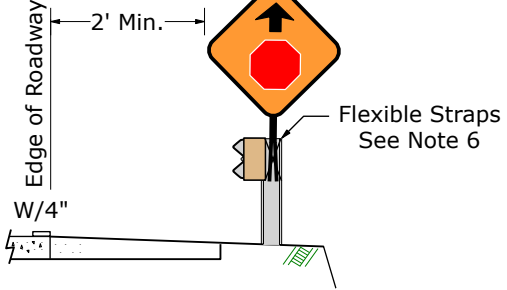
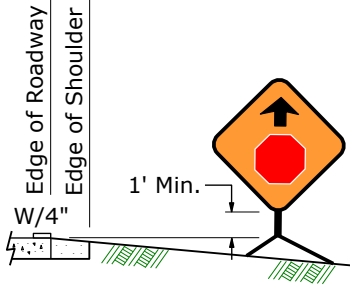
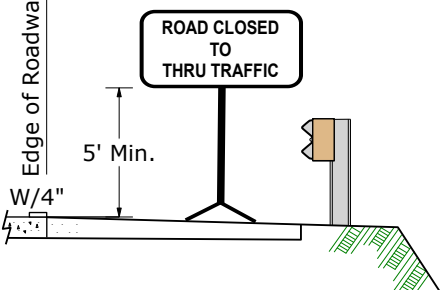
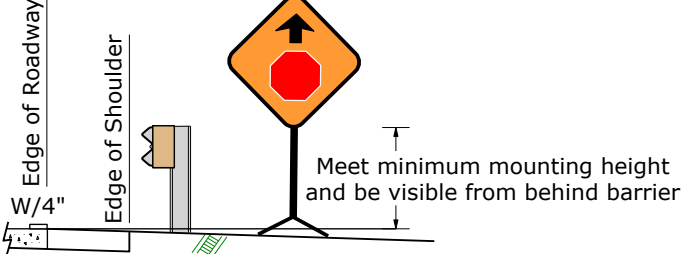
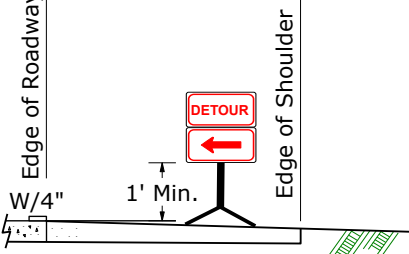
9. Lights attached to signs shall be mounted at or above the midpoint of the sign face without obscuring any part of the sign face. Attach lights on the side that is nearest to traffic.

10. The width of Type III barricade rails shall be 48" minimum or equal to the widest horizontal dimension of the widest sign installed on the barricade, whichever is greater.

11. Portable Sign Posts shall not hold a single sign larger than 36"x36". These sign posts may be used to support multiple smaller signs if the total sign area is 9 square feet or less. See PennDOT Publication 111, TC-8717.

12. TTC sign supports shall not straddle barrier (guiderail, concrete, etc.) unless the device has been successfully tested while straddling barrier in accordance with the 2015 or newer edition of the Manual for Assessing Safety Hardware (MASH).

General Application 10 TTC Sign Installation Rural Conventional Highways

Portable Sign Support Lateral Offset	
	
Figure 10-1 Not Adjacent to Barrier	Figure 10-2 Adjacent to Barrier
	
Figure 10-3 Adjacent to Barrier	Figure 10-4 Adjacent to Barrier
Portable Sign Support Mounting Height	
	
Figure 10-5 Non-Regulatory Signs	Figure 10-6 Regulatory Signs
	
Figure 10-7 Non-Regulatory and Regulatory Signs	Figure 10-8 Non-Regulatory Signs

General Application 10 TTC Sign Installation Rural Conventional Highways

Portable Sign Post Lateral Offset

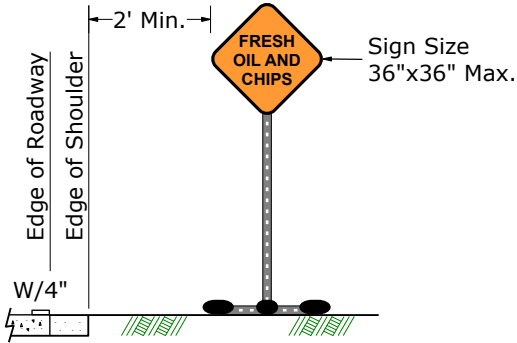


Figure 10-9
Not Adjacent to Barrier

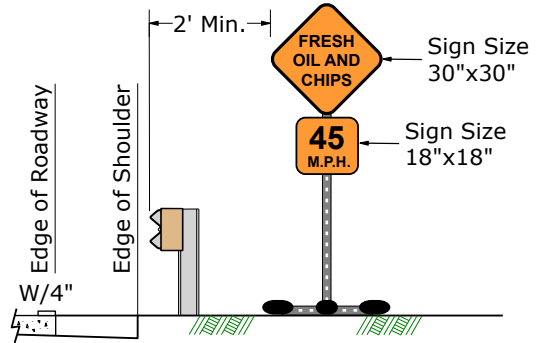


Figure 10-10
Adjacent to Barrier

Portable Sign Post Mounting Height

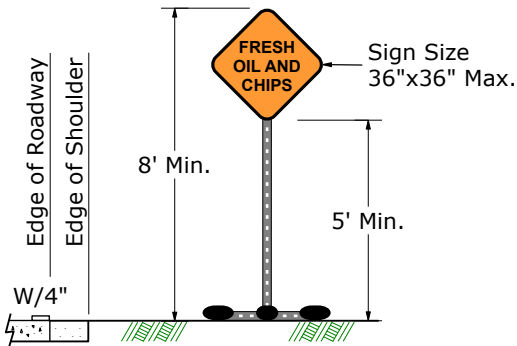


Figure 10-11
Non-Regulatory Signs

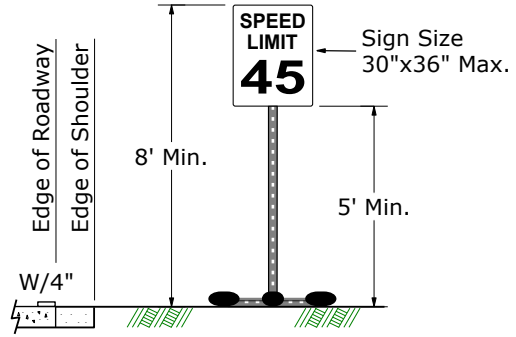


Figure 10-12
Regulatory Signs

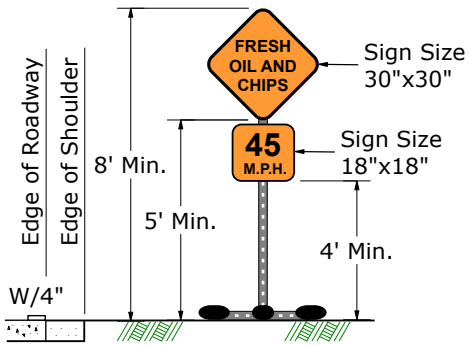


Figure 10-13
Non-Regulatory Signs

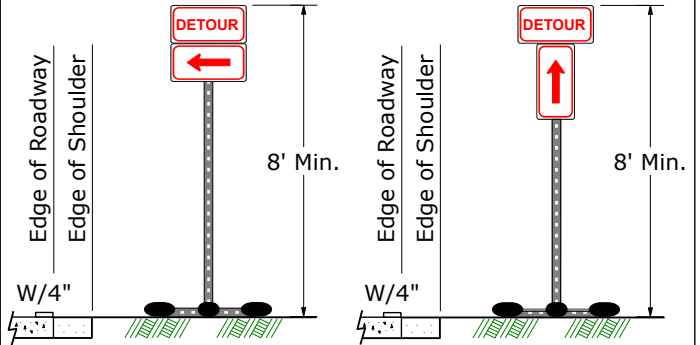


Figure 10-14
Non-Regulatory Signs

General Application 10 TTC Sign Installation Rural Conventional Highways

Type III Barricade Lateral Offset

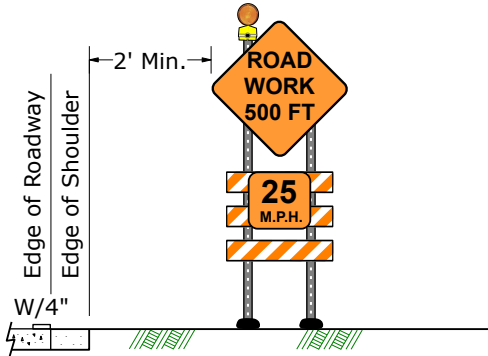


Figure 10-15
Not Adjacent to Barrier

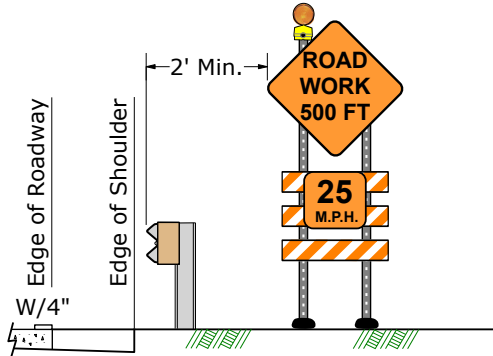


Figure 10-16
Adjacent to Barrier

Type III Barricade Mounting Height

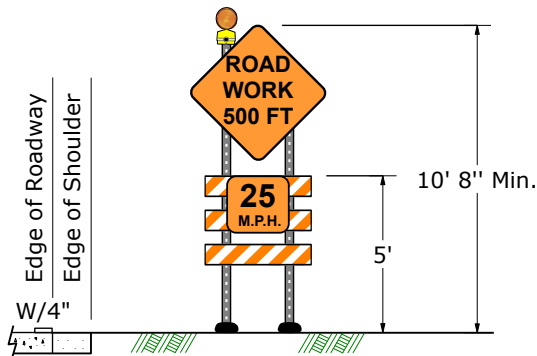


Figure 10-17
Non-Regulatory Signs

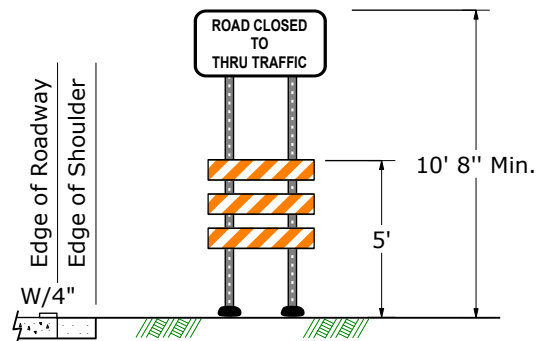


Figure 10-18
Regulatory Signs

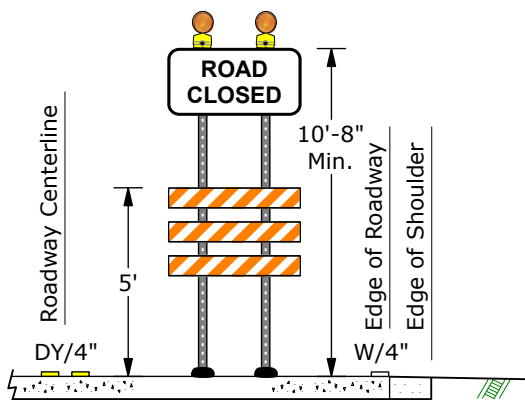


Figure 10-19
Regulatory Signs

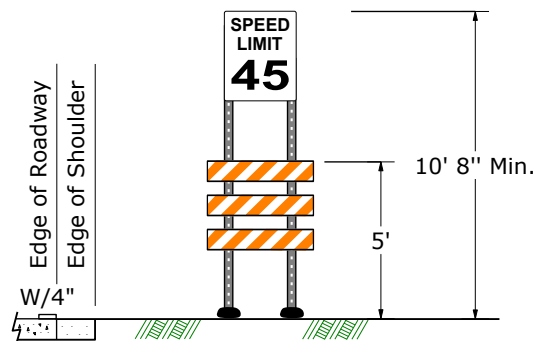


Figure 10-20
Regulatory Signs

General Application 10 TTC Sign Installation Rural Conventional Highways

Post Mounted Lateral Offset

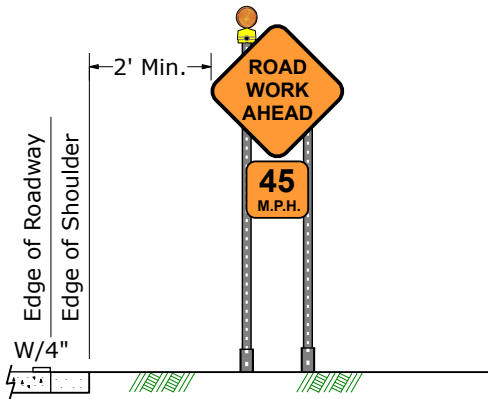


Figure 10-21
Not Adjacent to Barrier

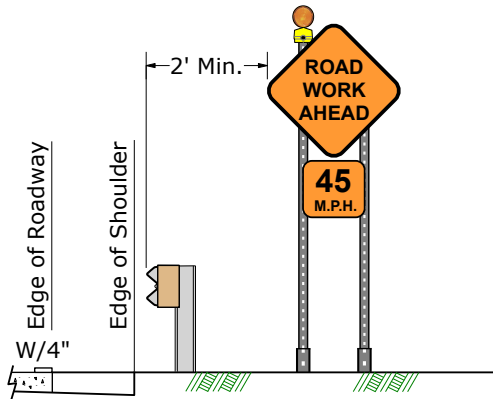


Figure 10-22
Adjacent to Barrier

Post Mounted Mounting Height

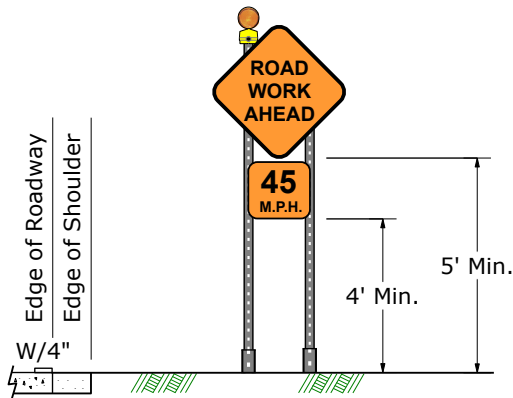


Figure 10-23
Non-Regulatory Signs

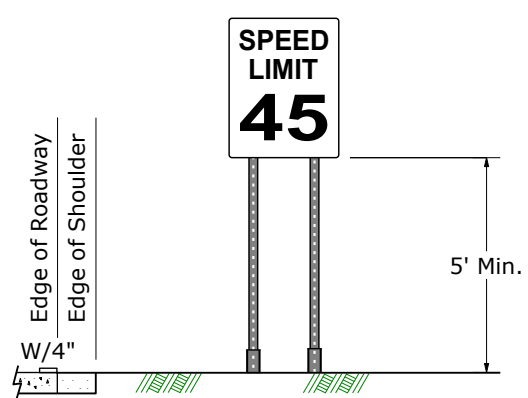
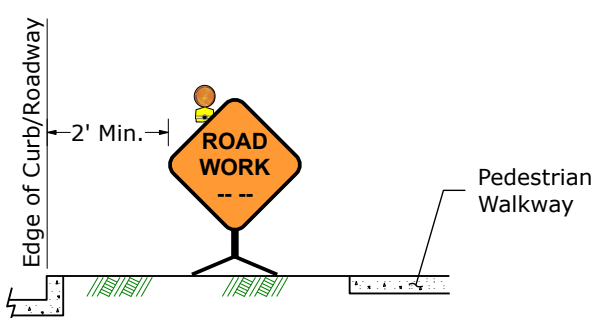
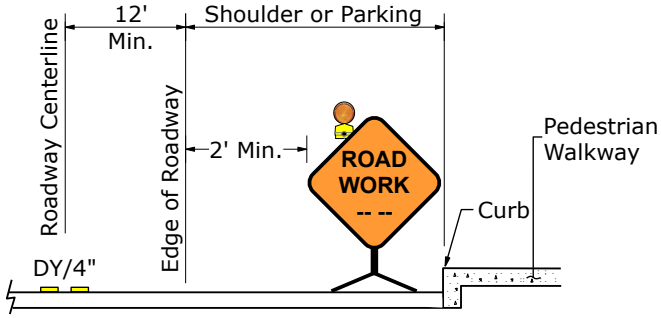
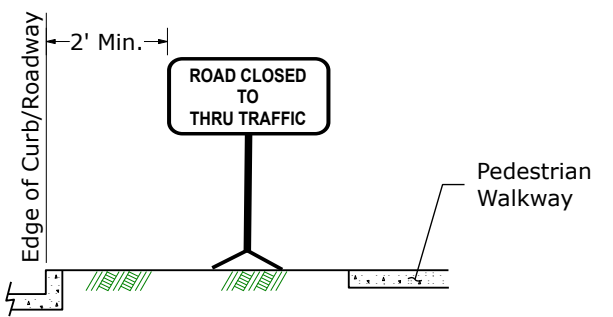
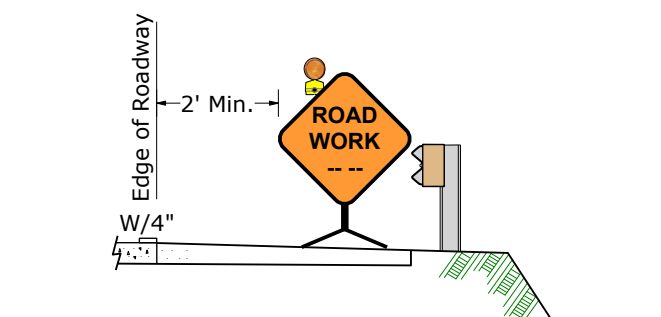
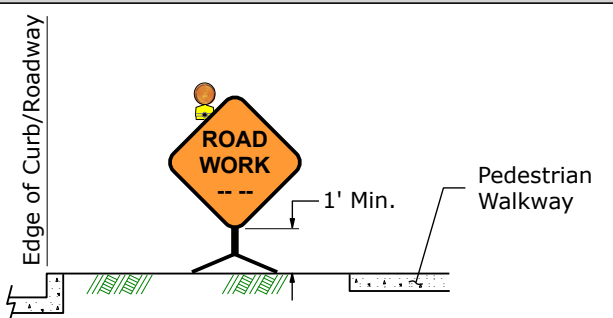
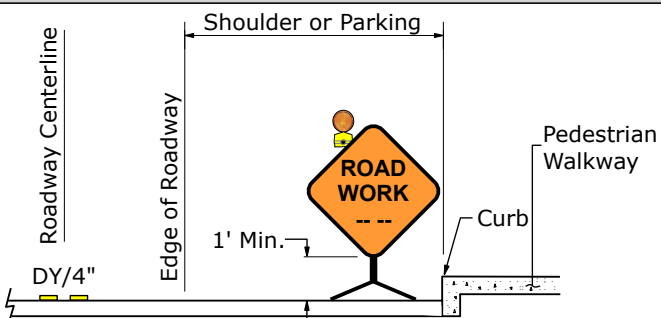
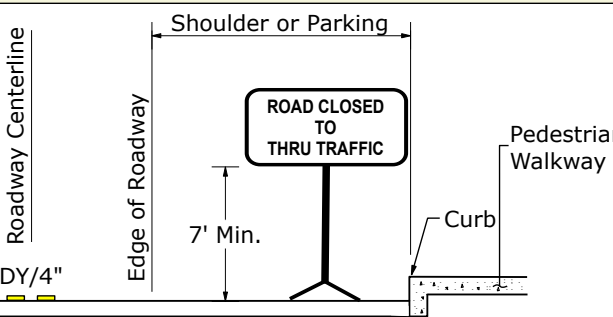
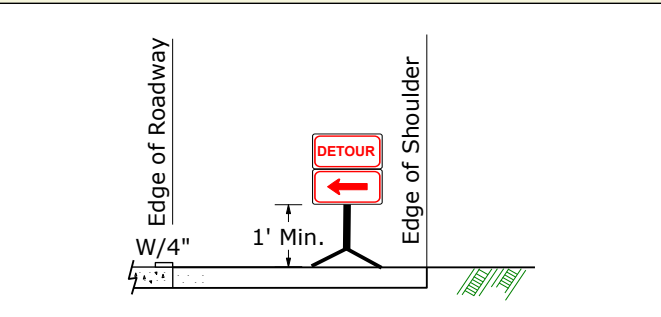


Figure 10-24
Regulatory Signs

General Application 10 TTC Sign Installation Urban Conventional Highways

Portable Sign Support Lateral Offset	
 <p style="text-align: center;">Figure 10-25 Not Adjacent to Barrier</p>	 <p style="text-align: center;">Figure 10-26 Not Adjacent to Barrier</p>
Figure 10-25 Not Adjacent to Barrier	Figure 10-26 Not Adjacent to Barrier
 <p style="text-align: center;">Figure 10-27 Not Adjacent to Barrier</p>	 <p style="text-align: center;">Figure 10-28 Adjacent to Barrier</p>
Figure 10-27 Not Adjacent to Barrier	Figure 10-28 Adjacent to Barrier
Portable Sign Support Mounting Height	
 <p style="text-align: center;">Figure 10-29 Non-Regulatory Signs</p>	 <p style="text-align: center;">Figure 10-30 Non-Regulatory Signs</p>
Figure 10-29 Non-Regulatory Signs	Figure 10-30 Non-Regulatory Signs
 <p style="text-align: center;">Figure 10-31 Regulatory Signs</p>	 <p style="text-align: center;">Figure 10-32 Non-Regulatory Signs</p>
Figure 10-31 Regulatory Signs	Figure 10-32 Non-Regulatory Signs

General Application 10 TTC Sign Installation Urban Conventional Highways

Portable Sign Post Lateral Offset

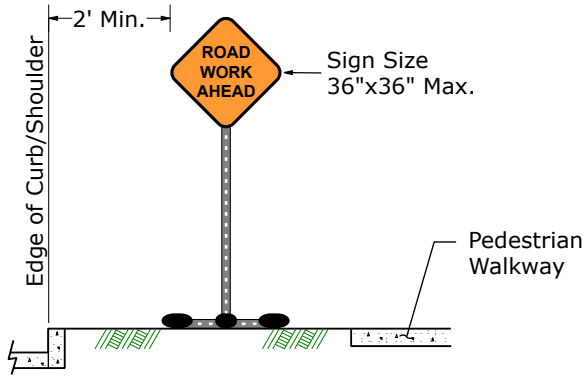


Figure 10-33
Not Adjacent to Barrier

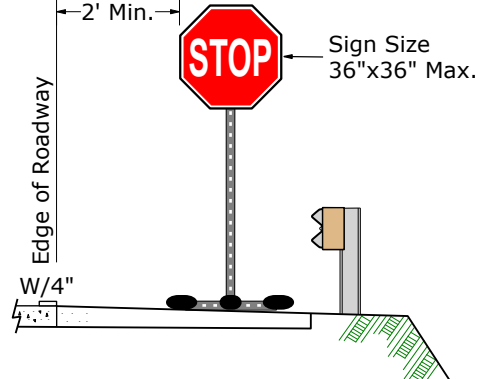


Figure 10-34
Adjacent to Barrier

Portable Sign Post Mounting Height

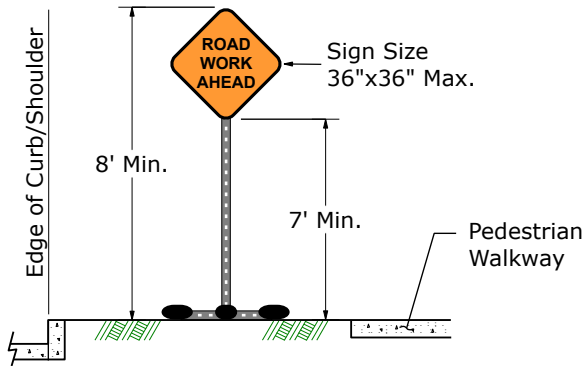


Figure 10-35
Non-Regulatory Signs

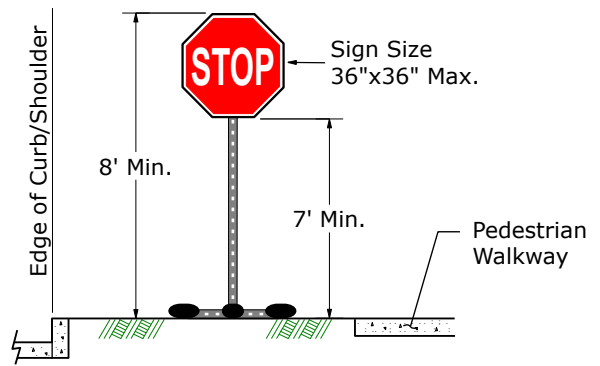


Figure 10-36
Regulatory Signs

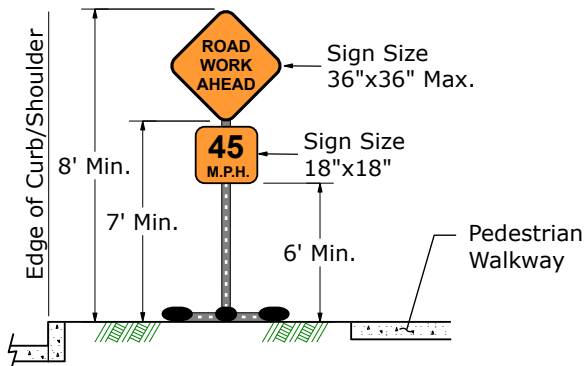


Figure 10-37
Non-Regulatory Signs

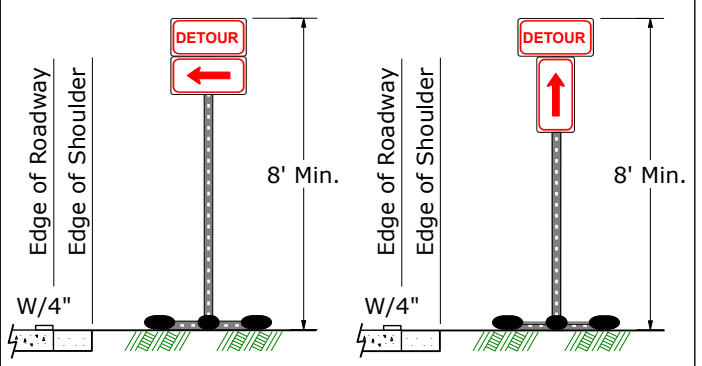


Figure 10-38
Non-Regulatory Signs

General Application 10 TTC Sign Installation Urban Conventional Highways

Type III Barricade Lateral Offset

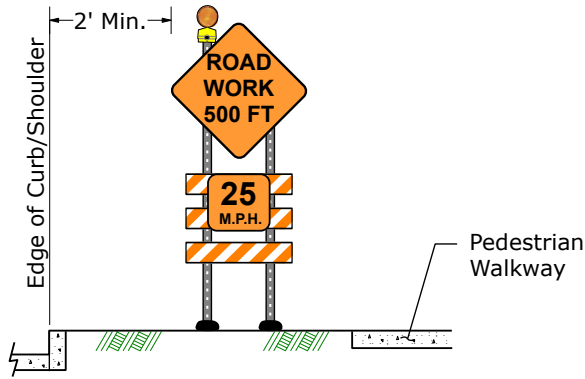


Figure 10-39
Not Adjacent to Barrier

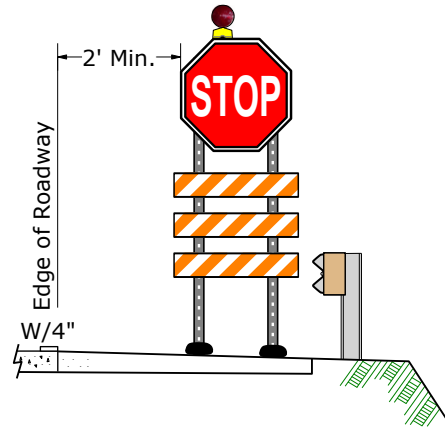


Figure 10-40
Adjacent to Barrier

Type III Barricade Mounting Height

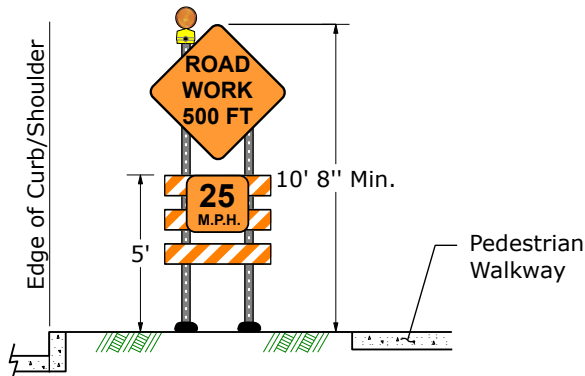


Figure 10-41
Non-Regulatory Signs

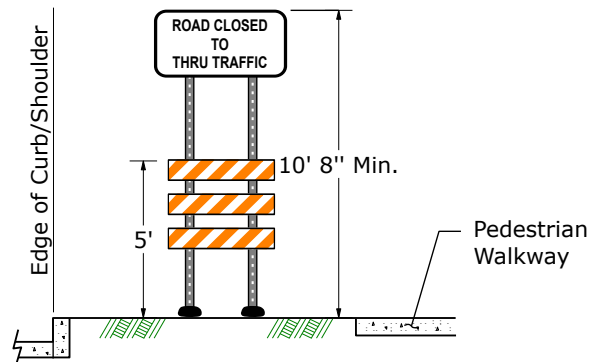


Figure 10-42
Regulatory Signs

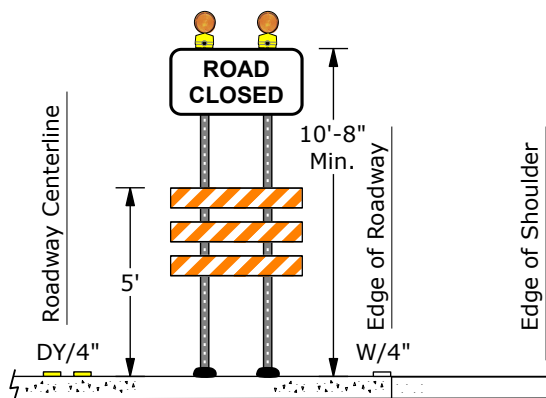


Figure 10-43
Regulatory Signs

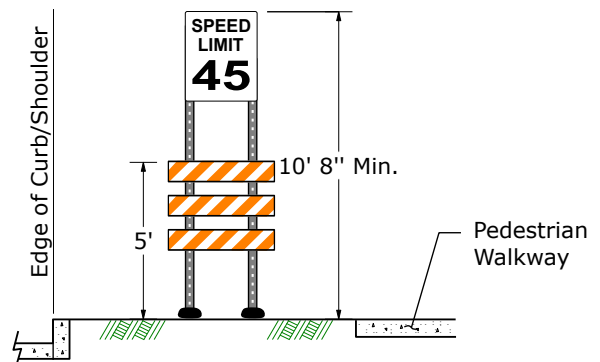


Figure 10-44
Regulatory Signs

General Application 10 TTC Sign Installation Urban Conventional Highways

Post Mounted Lateral Offset

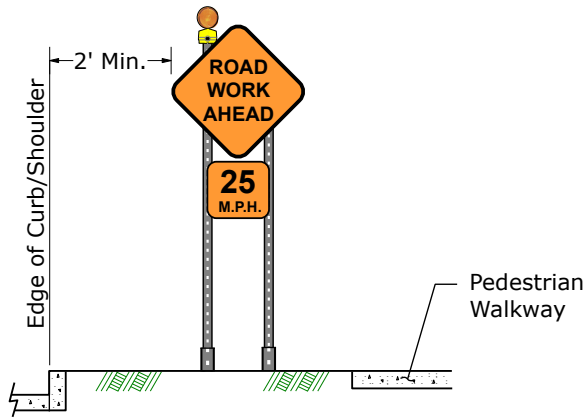


Figure 10-45
Not Adjacent to Barrier

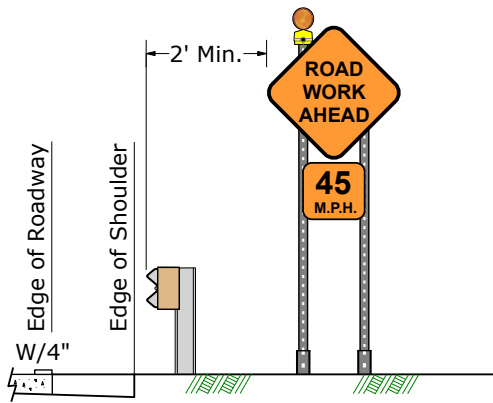


Figure 10-46
Adjacent to Barrier

Post Mounted Mounting Height

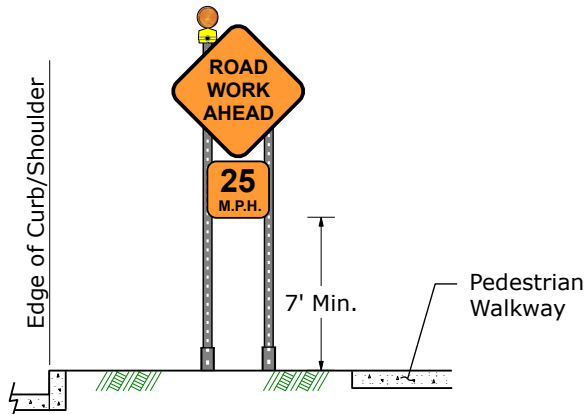


Figure 10-47
Non-Regulatory Signs

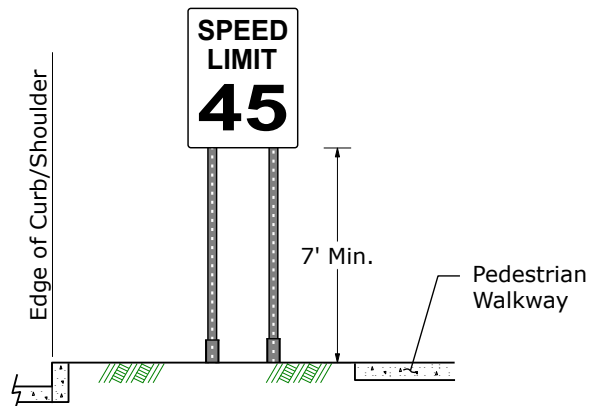


Figure 10-48
Regulatory Signs

General Application 10 TTC Sign Installation Freeways & Expressways

Portable Sign Support Lateral Offset

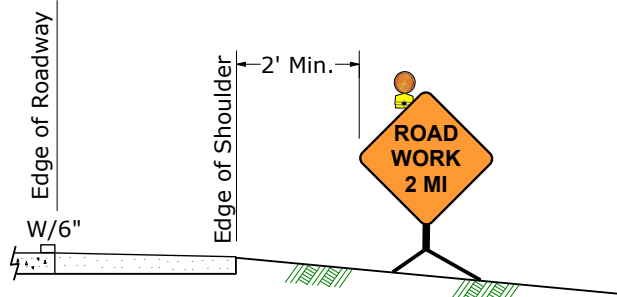


Figure 10-49
Not Adjacent to Barrier

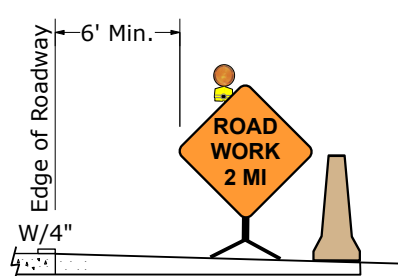


Figure 10-50
Adjacent to Barrier

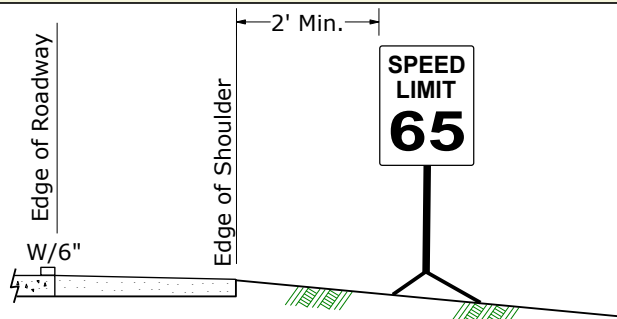


Figure 10-51
Not Adjacent to Barrier

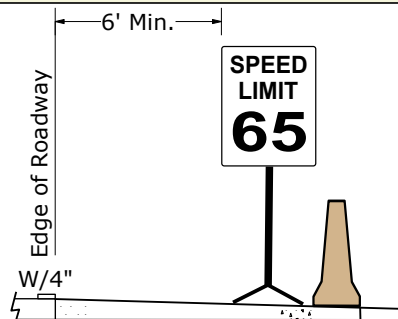


Figure 10-52
Adjacent to Barrier

Portable Sign Support Mounting Height

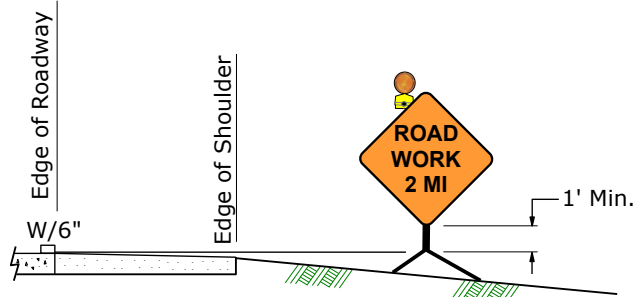


Figure 10-53
Non-Regulatory Signs

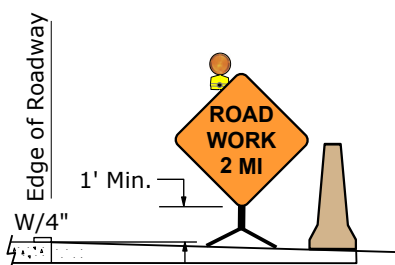


Figure 10-54
Non-Regulatory Signs

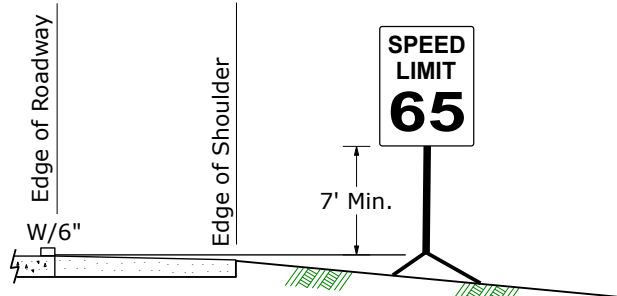


Figure 10-55
Regulatory Signs

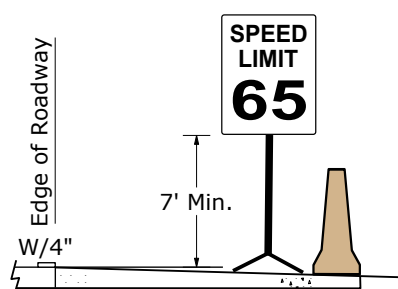


Figure 10-56
Regulatory Signs

General Application 10 TTC Sign Installation Freeways & Expressways

Type III Barricade Lateral Offset

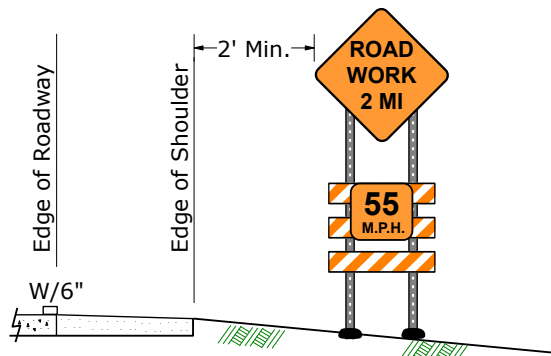


Figure 10-57
Not Adjacent to Barrier

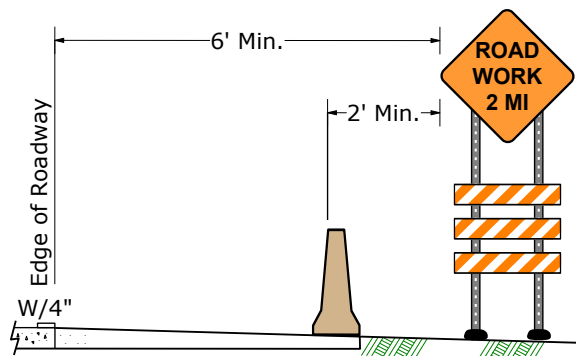


Figure 10-58
Adjacent to Barrier

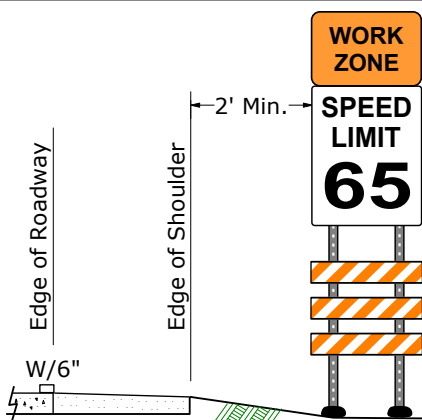


Figure 10-59
Not Adjacent to Barrier

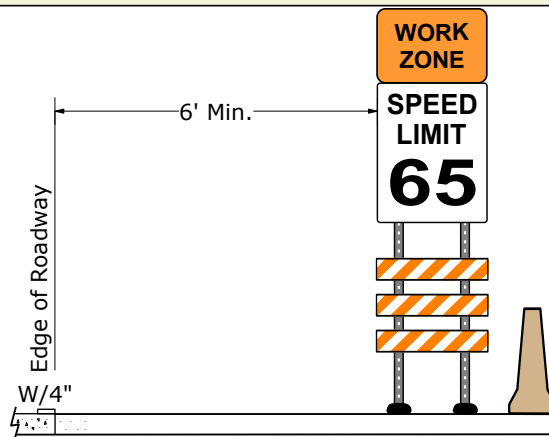


Figure 10-60
Adjacent to Barrier

Type III Barricade Mounting Height

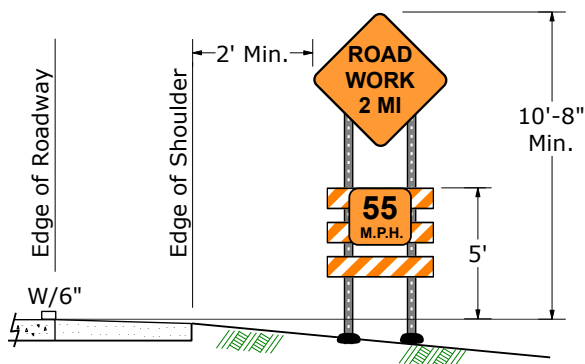


Figure 10-61
Non-Regulatory Signs

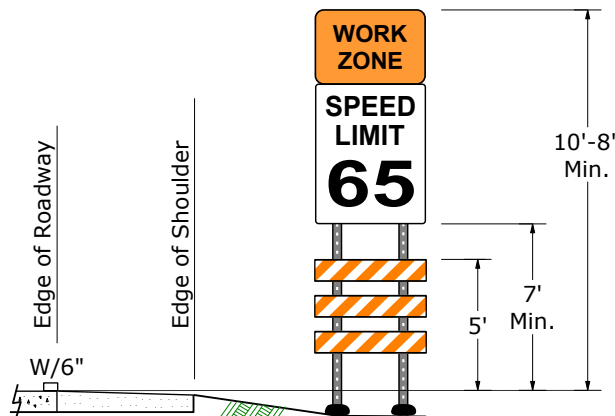


Figure 10-62
Regulatory Signs

General Application 10 TTC Sign Installation Freeways & Expressways

Median Bracket Lateral Offset

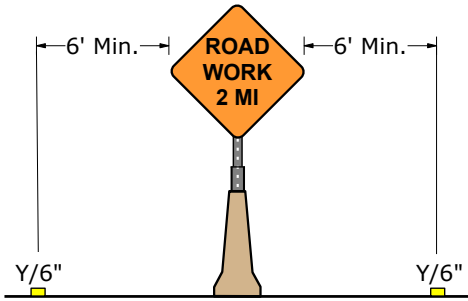


Figure 10-63
Not Adjacent to Barrier

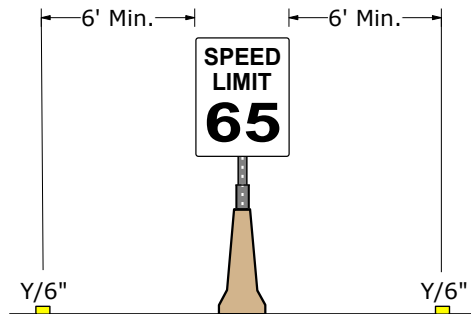


Figure 10-64
Adjacent to Barrier

Median Bracket Mounting Height

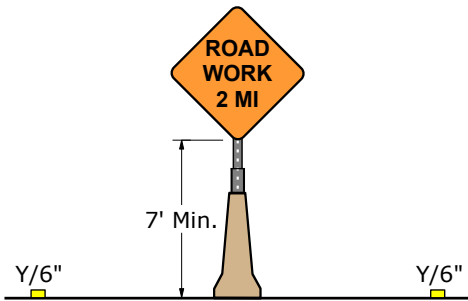


Figure 10-65
Non-Regulatory Signs

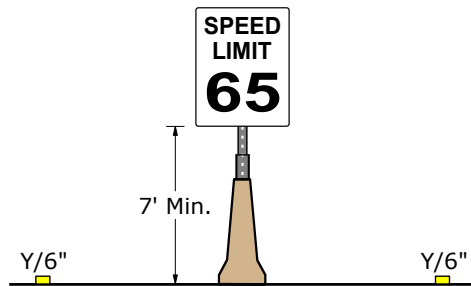


Figure 10-66
Regulatory Signs

General Application 10 TTC Sign Installation Freeways & Expressways

Post Mounted Lateral Offset

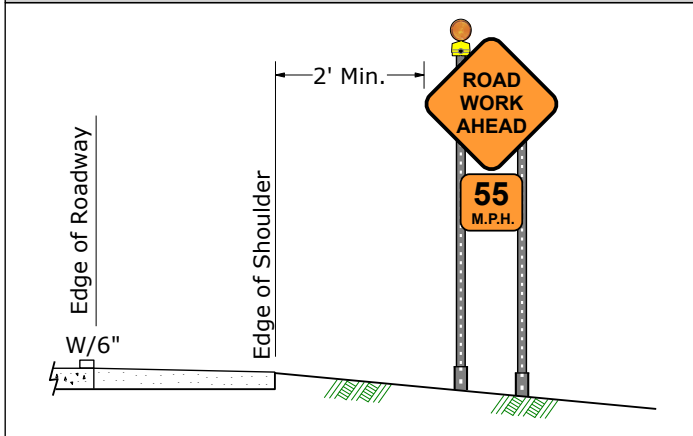


Figure 10-67
Not Adjacent to Barrier

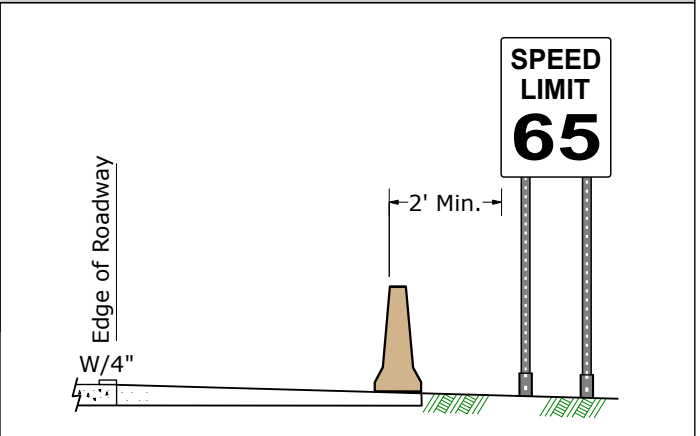


Figure 10-68
Adjacent to Barrier

Post Mounted Mounting Height

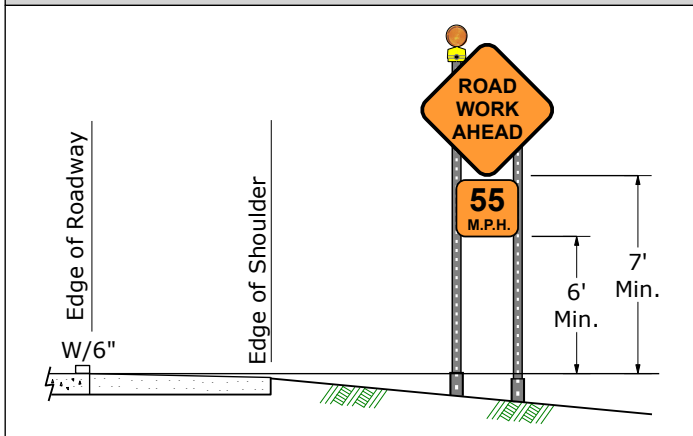


Figure 10-69
Non-Regulatory Signs

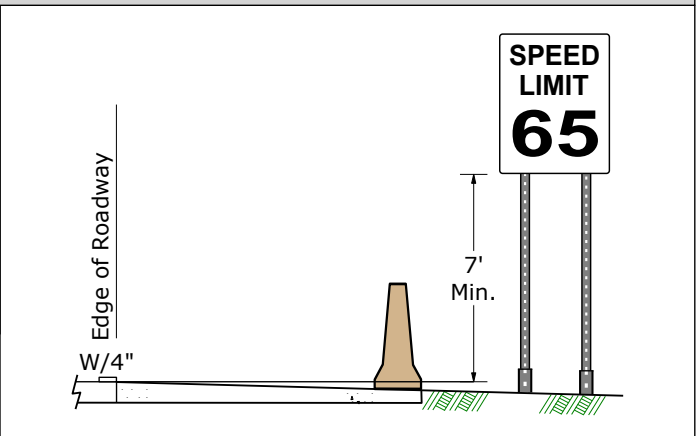
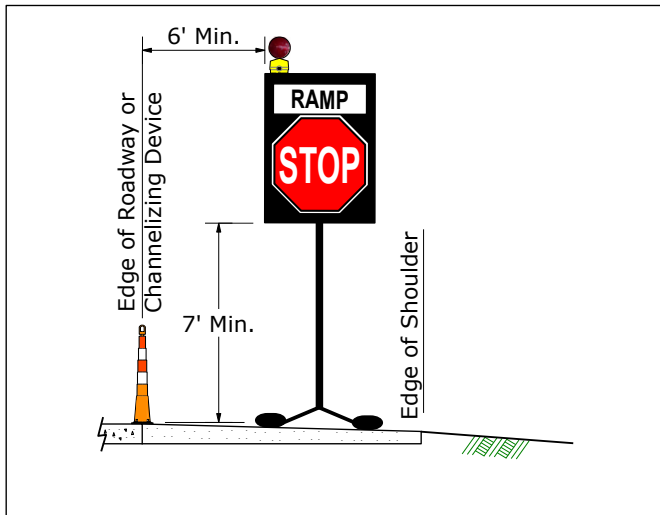
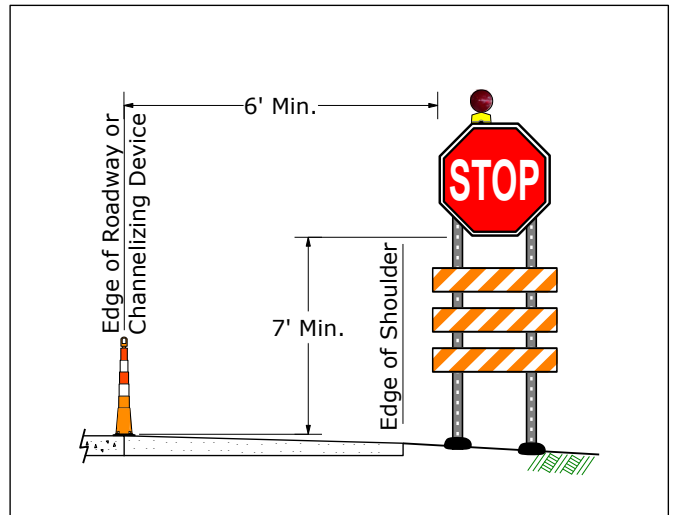


Figure 10-70
Regulatory Signs

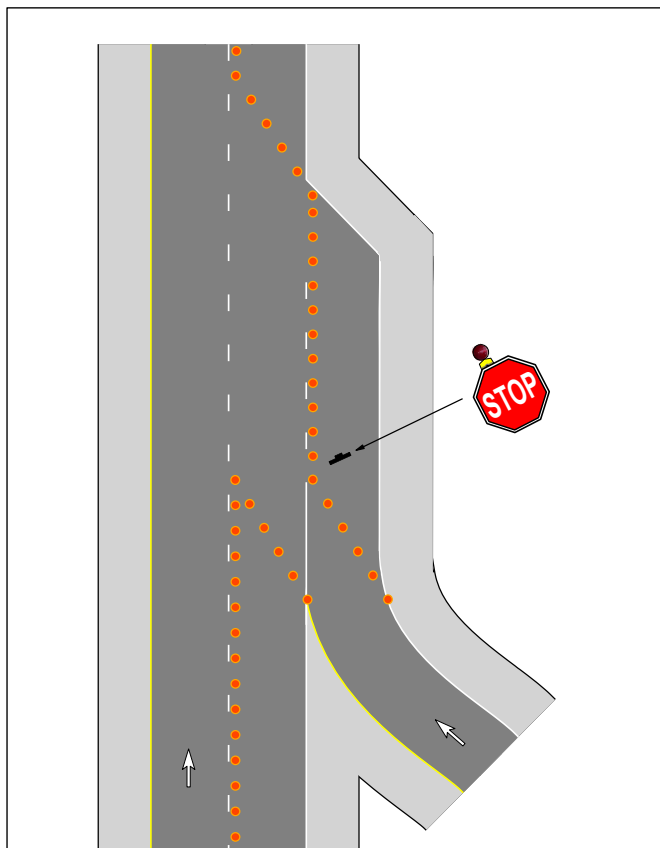
General Application 10 TTC Sign Installation Ramps to Freeways & Expressways



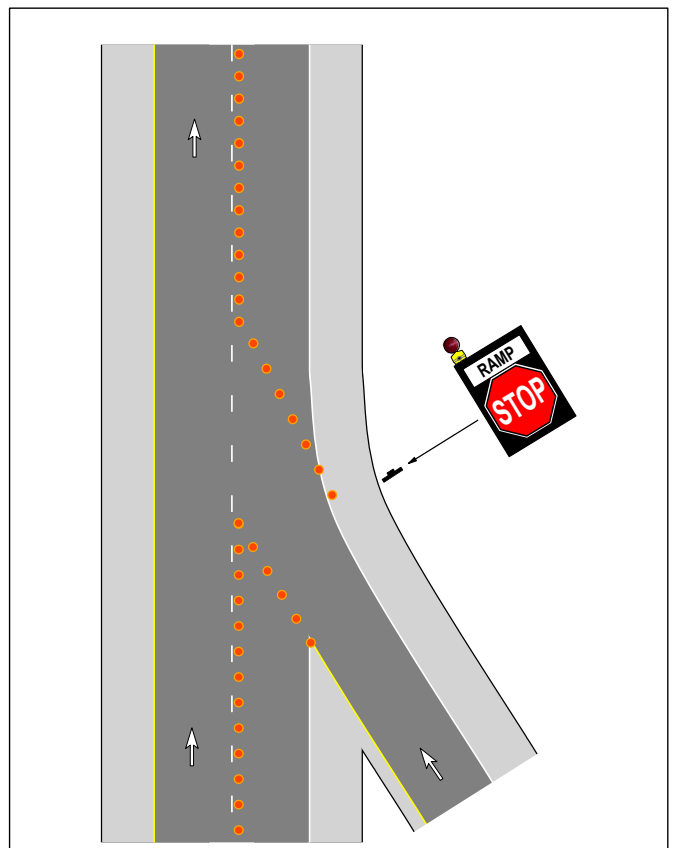
**Figure 10-71
Portable Sign Support**



**Figure 10-72
Type III Barricade**



**Figure 10-73
Stop Sign on Ramp with an Acceleration Lane**



**Figure 10-74
Stop Sign on Ramp without an Acceleration Lane**

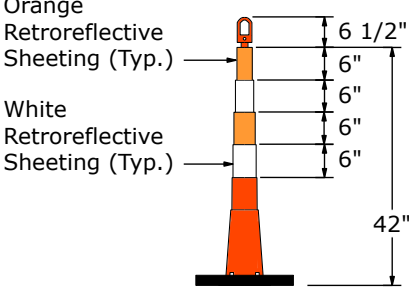
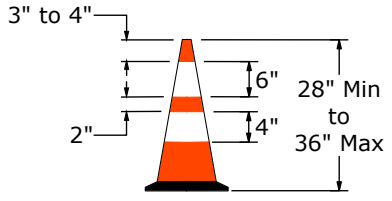
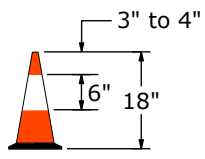
General Application 11-A Channelizing Device Details

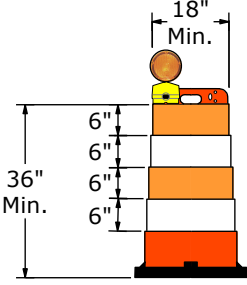
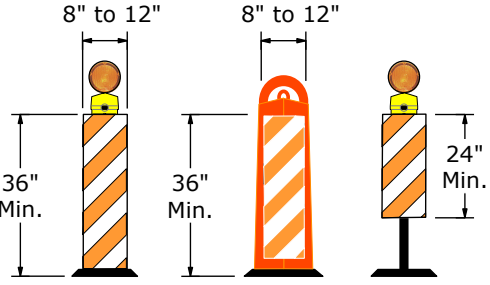
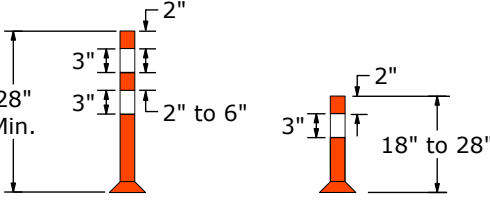
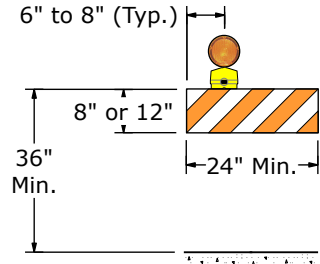
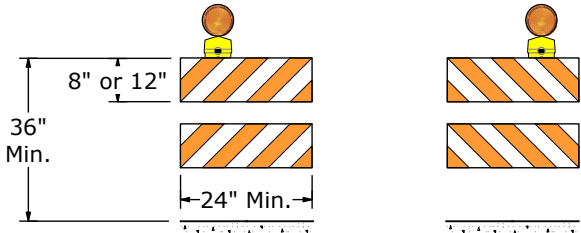
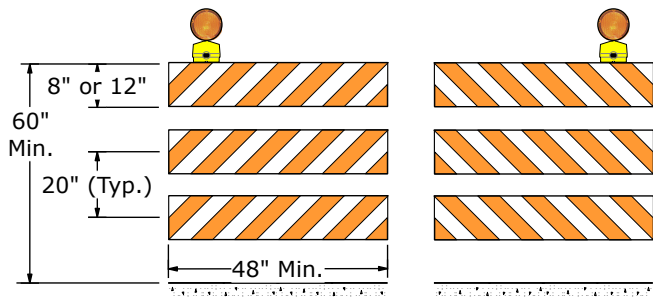
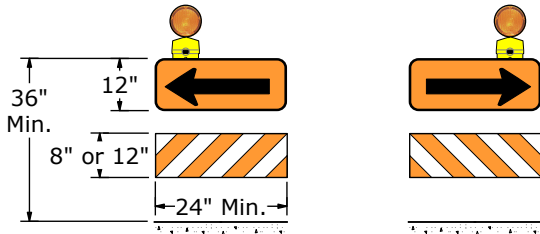
1. General Application 11-A provides channelizing device details.
2. Channelizing devices are divided into two categories; short-term and long-term:
 - For operations up to 72 hours, short-term or long-term devices may be used.
 - For operations greater than 72 hours, long-term devices shall be used.
3. Cones may only be used as a channelizing device for operations where work is in active progress. If the work is in active progress for greater than 72 hours, a long-term device shall be used.
4. Cones must comply with the following height and weight requirements:

Type of Cone	Height Requirement	Weight Requirement (Minimum)
Tall Cone	42"	Cone - 2.50 pounds Base - 15 pounds
Standard Cone	28"-36"	10 pounds
Incident Management Cone	28"-36"	3 pounds
Pavement Marking Protection Cone	18"	3 pounds

5. Incident Management Cones may only be used during an emergency road user occurrence, a natural disaster, or other unplanned event that affects or impedes the normal flow of traffic.
6. Pavement Marking Protection Cones may only be used to protect fresh paint or other pavement marking material while the material is in the process of curing or drying.
7. Direction Indicator Barricades may be used for all tapers approaching a TTC zone. Utilization is recommended on tapers approaching work zones on freeways and expressways.
8. Tubular markers shall be a minimum of 28" in height anytime they are used on freeways/expressways and conventional highways during nighttime hours. Tubular markers have less visible area than other devices and should be used only where space restrictions do not allow for placement of other more visible devices.
9. Stripes on barricade rails shall be alternating orange and white retroreflective stripes sloping downward at an angle of 45 degrees. Rail stripes shall be 6 inches wide, however when rail lengths are less than 36 inches, 4-inch wide stripes may be used.
10. Warning lights are shown for purpose of displaying proper mounting positions. Lights are optional on these devices, however consistency in application should be observed (e.g. if lights will be used in a taper, then all channelizing devices in the taper should be mounted with lights).

General Application 11-A Channelizing Device Details

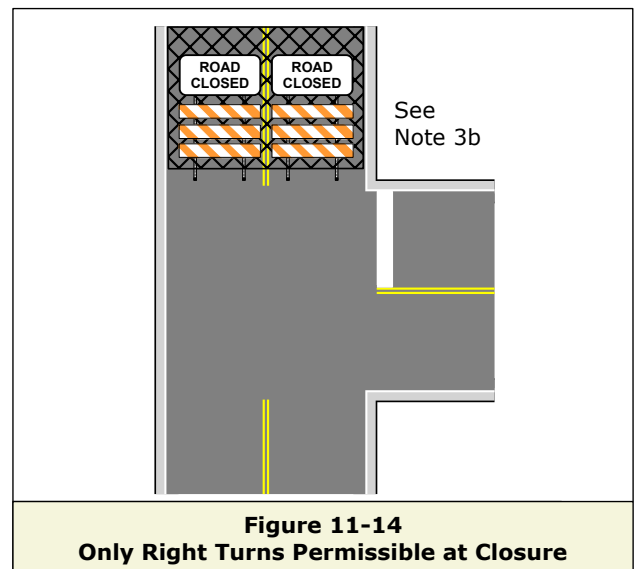
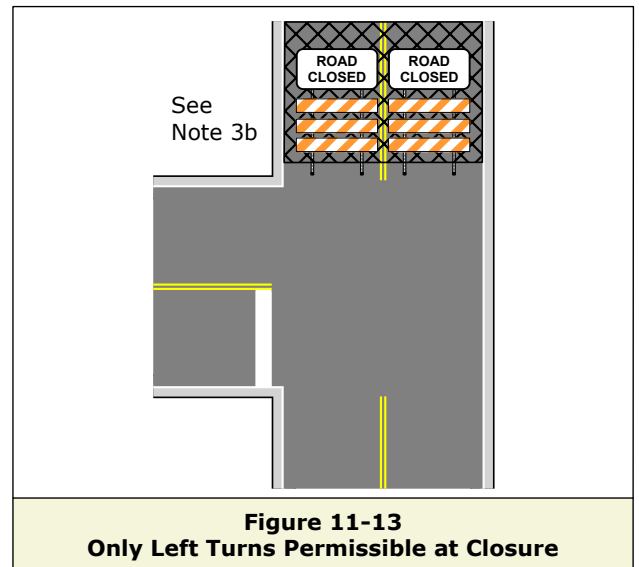
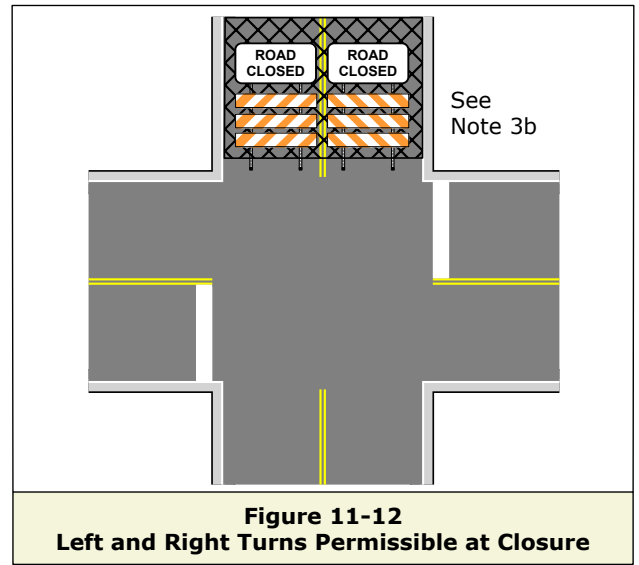
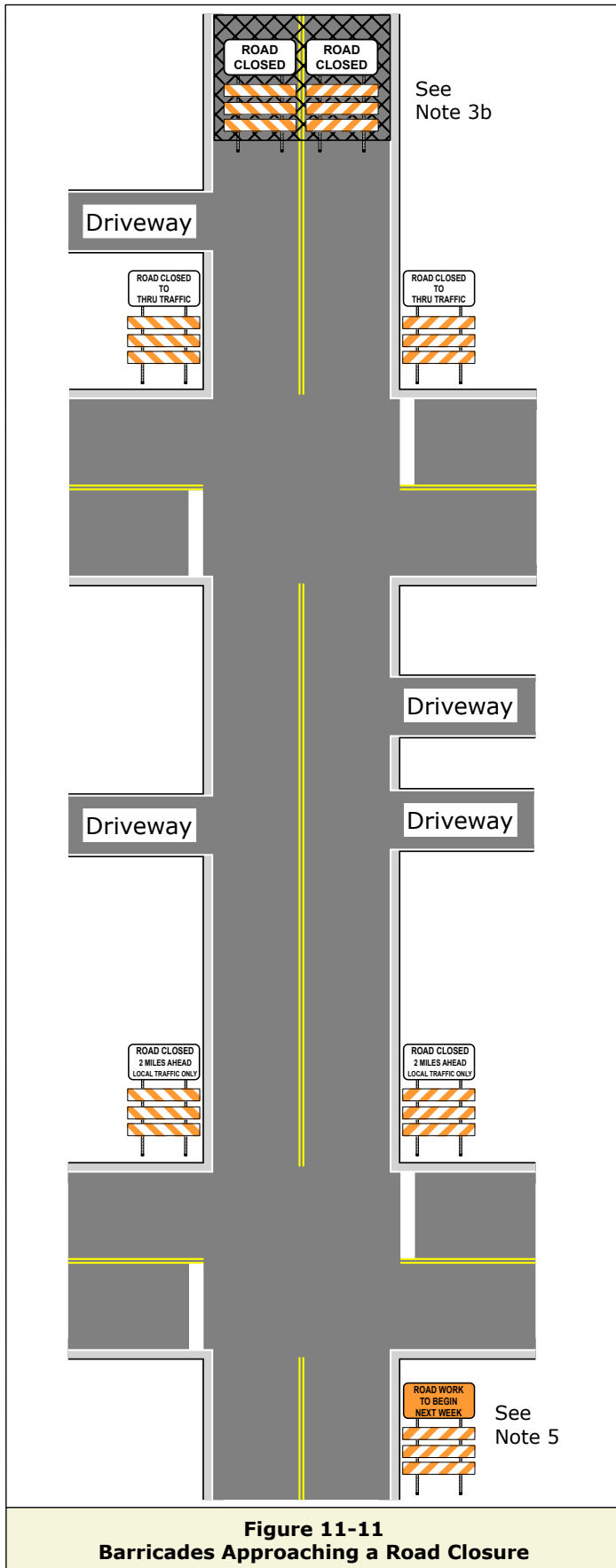
Short-Term Devices Cones		
 <p>Orange Retroreflective Sheeting (Typ.)</p> <p>White Retroreflective Sheeting (Typ.)</p> <p style="text-align: right;">42"</p>	 <p>3" to 4"</p> <p>2"</p> <p>6"</p> <p>4"</p> <p>28" Min to 36" Max</p>	 <p>3" to 4"</p> <p>6"</p> <p>18"</p>
Figure 11-1 Tall Cone	Figure 11-2 Standard/Incident Management Cone	Figure 11-3 Pavement Marking Protection Cone

Long-Term Devices Drums, Vertical Panels, Tubular Markers, and Barricades		
 <p>18" Min.</p> <p>6"</p> <p>6"</p> <p>6"</p> <p>6"</p> <p>36" Min.</p>	 <p>8" to 12"</p> <p>8" to 12"</p> <p>36" Min.</p> <p>36" Min.</p> <p>24" Min.</p>	 <p>2"</p> <p>3"</p> <p>3"</p> <p>2" to 6"</p> <p>28" Min.</p> <p>2"</p> <p>3"</p> <p>18" to 28"</p>
Figure 11-4 Drum	Figure 11-5 Vertical Panel	Figure 11-6 Tubular Marker
 <p>6" to 8" (Typ.)</p> <p>8" or 12"</p> <p>36" Min.</p> <p>24" Min.</p>	 <p>8" or 12"</p> <p>36" Min.</p> <p>24" Min.</p>	
Figure 11-7 Type I Barricade	Figure 11-8 Type II Barricade	
 <p>8" or 12"</p> <p>60" Min.</p> <p>20" (Typ.)</p> <p>48" Min.</p>	 <p>12"</p> <p>36" Min.</p> <p>8" or 12"</p> <p>24" Min.</p>	
Figure 11-9 Type III Barricade	Figure 11-10 Direction Indicator Barricade	

General Application 11-B Road Closure Signs and Barricade Rail Striping Direction

1. General Application 11-B provides guidance on the installation of road closure signs and barricade rail striping direction.
2. Stripes on barricade rails shall be alternating orange and white retroreflective stripes sloping downward at an angle of 45 degrees in the direction road users are to pass. For example, if a driver sees a Type III barricade placed along the right side of the road then the rails shall slope downward to the left, pointing towards the roadway.
3. The ROAD CLOSED (R11-2) sign shall be placed at the point where the road is closed to all traffic, except authorized vehicles. The sign should be installed on a Type III Barricade.
 - a) Where a single ROAD CLOSED (R11-2) sign on a Type III Barricade is used to close a road, it should be placed in the middle of the approach lane or in the middle of the roadway on the center line. Stripes may slope downward left or right because traffic is prohibited from passing this sign, however if a single turning movement either left or right is permissible, then the stripes should slope downward in that direction.
 - b) Where two or more Type III Barricades are used to close a road, they should be placed on each side of the roadway centerline. Barricade rail stripes shall slope downward according to permissible turning movements:
 - Slope downward to the right where only right turns are provided.
 - Slope downward to the left where only left turns are provided.
 - Slope downward in both directions from the center of the roadway where left and right turns are provided.
 - Slope downward in both directions toward the center of the roadway where no turns are provided.
4. ROAD CLOSED TO THROUGH TRAFFIC (R11-4) signs should be installed in advance of a closure where traffic is permitted to pass these signs to access intersections and driveways. A similar sign should be placed at the last intersection prior to the closure. Identical signs may be placed on the left side of the roadway if the TTC device do not reduce the available corner sight distance from a side road or driveway.
5. Advance notice of pending work should be provided by using a PCMS or ROAD WORK TO BEGIN NEXT WEEK (G20-1-2) signs during the week before scheduled work. A THIS BRIDGE TO BE CLOSED FOR MAINTENANCE (W23-101) sign should be used on structures. Sign messages may be varied as necessary in order to meet the particular needs (e.g. Bridge Closed may be substituted for Road Closed). Refer to PennDOT Publication 46, Section 6.6.

General Application 11-B Road Closure Signs and Barricade Rail Striping Direction



General Application 12 Arrow Boards

1. General Application 12 Figures 12-1 and 12-2 show arrow board operating modes, specifications and displays. Figures 12-3 through 12-20 show proper arrow board displays when used in various positions. These figures are not meant to indicate that an arrow board is required for each example. Arrow boards (with arrows or chevrons) shall only be used to indicate a lane closure. Arrow boards shall not be used to indicate a lane shift.
2. Arrow boards have two operating modes:
 - Merge Mode - Shall be used only for stationary or moving lane closures on multi-lane highways. Arrow boards operating in merge mode may display a flashing arrow, flashing double arrow, or chevron.
 - Caution Mode - May be used for shoulder work, blocking the shoulder, for roadside work near the shoulder, or for temporarily closing one lane of a two-lane, two-way roadway. Arrow boards operating in caution mode may display a flashing four-corners pattern, alternating diamonds, or a flashing bar.
3. The color presented by the illuminated elements shall be yellow. Other colors, including white, shall not be used in conjunction with flashing patterns on arrow boards.
4. The minimum element on-time shall be 50 percent for the flashing mode, with equal intervals of 25 percent for each sequential phase. The flashing rate shall be not less than 25 or more than 40 flashes per minute.
5. Full matrix message boards may operate as flashing arrows if minimum size and legibility requirements are satisfied.
6. Type D arrow boards may only be used on vehicles during daytime operations on conventional highways.
7. Arrows shall only be displayed to indicate a lane closure. Do not display an arrow to indicate a lane shift. See the MUTCD, Section 6F.61 and PennDOT Publication 46, Section 6.10, for additional information.
8. PCMS boards may be used to display images shown in Figure 12-1. The height and width of arrow images should be equal to the PCMS board height and width.
9. For stationary lane closures, the arrow board should be located on the shoulder near the beginning of the merging taper. Where the shoulder is too narrow for the trailer, it may be placed downstream within in the closed lane (See Figure 12-5).

General Application 12 Arrow Boards Operating Modes and Specifications







Figure 12-1 Arrow Board Operating Modes			
Merge Mode		Caution Mode	
Flashing Arrow 	Flashing Corners 		
Sequential Chevron 	Flashing Bar 		
Flashing Double Arrow 	Alternating Diamond 		

Figure 12-2 Arrow Board Specifications					
Arrow Board Type	Minimum Size (inches)	Minimum Number of Elements	Type of Operation	Highway Type Approved for Use	Max. Speed Limit MPH
A	48 x 24	12	Stationary	Conventional	30
B	60 x 30	13	Stationary	Conventional	40
			Mobile	Conventional	55
C	96 x 48	15	Any	Conventional	45
				Freeway & Espressway	70
D	None*	12	Stationary	Conventional (Daylight Only)	30

*Length of arrow equals 48 inches and the width of arrowhead equals 24 inches.

General Application 12 Arrow Boards Displays - Common Stationary Operations

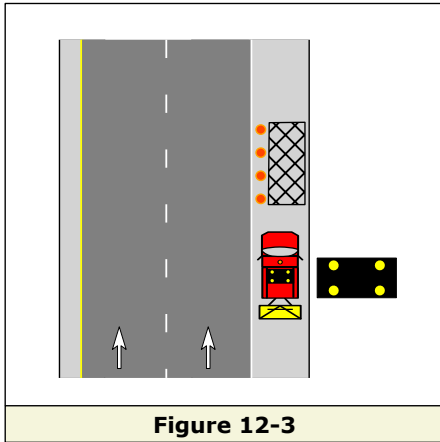


Figure 12-3

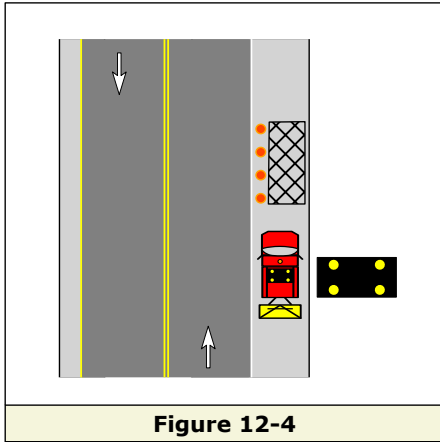


Figure 12-4

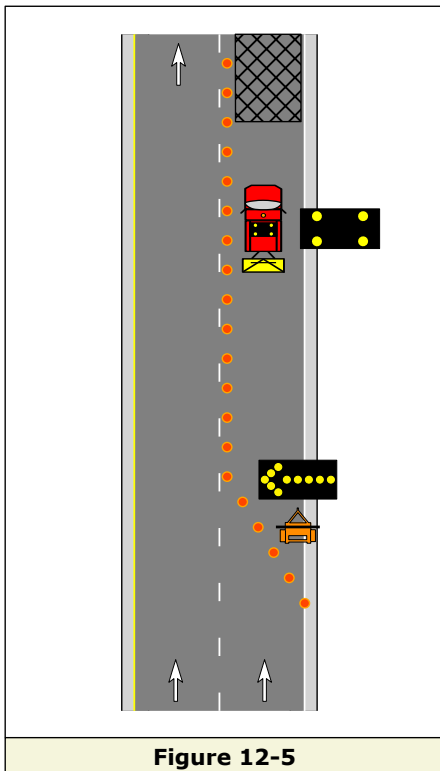


Figure 12-5

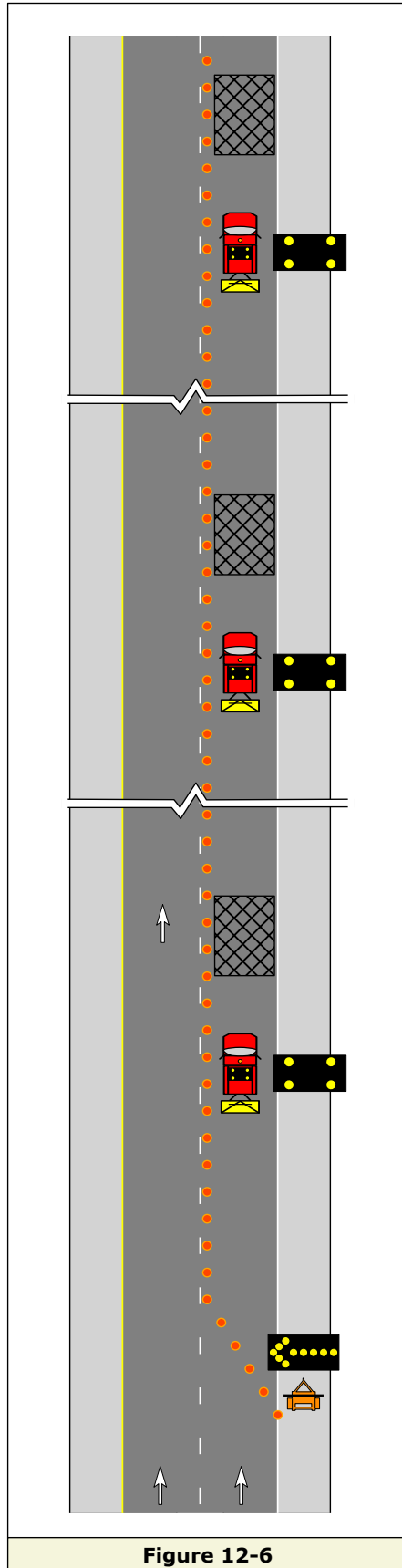


Figure 12-6

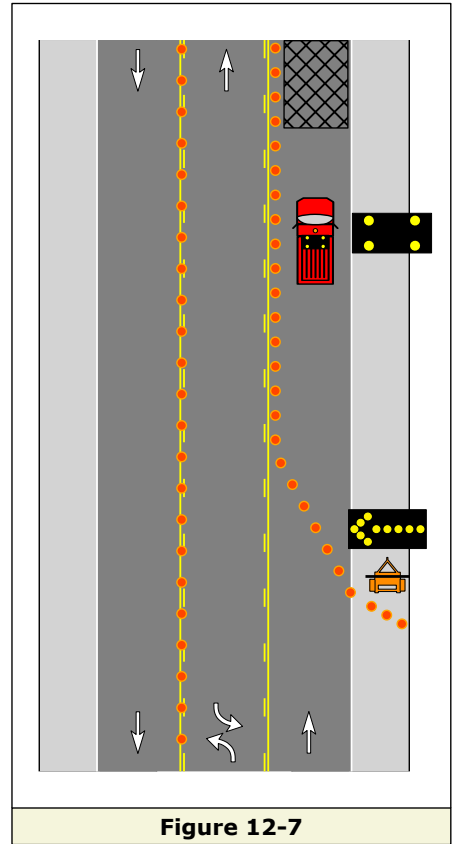


Figure 12-7

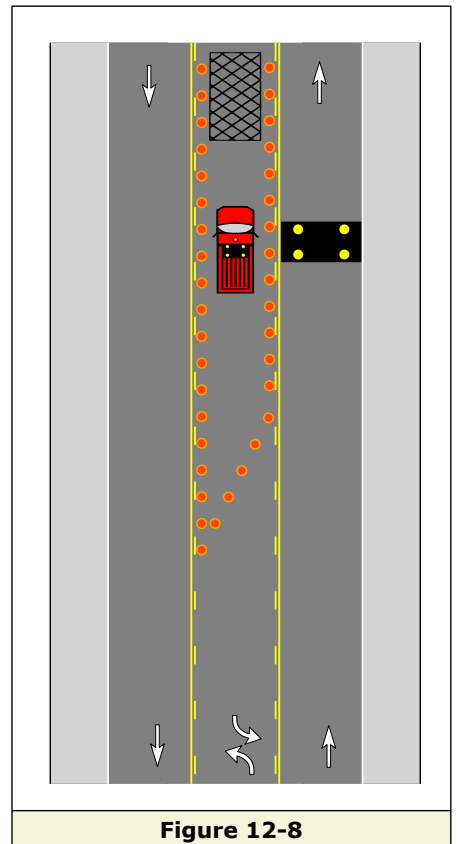


Figure 12-8

General Application 12

Arrow Boards

Displays - Common Mobile Operations

Single-Lane Approach

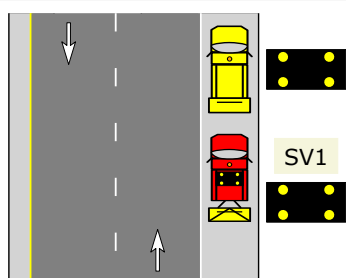


Figure 12-9

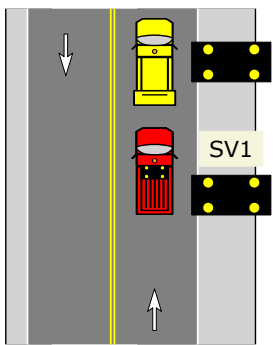


Figure 12-10

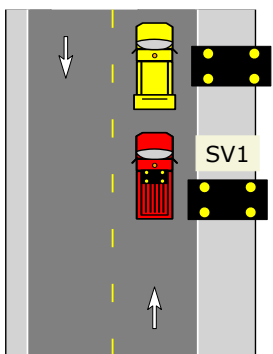


Figure 12-11

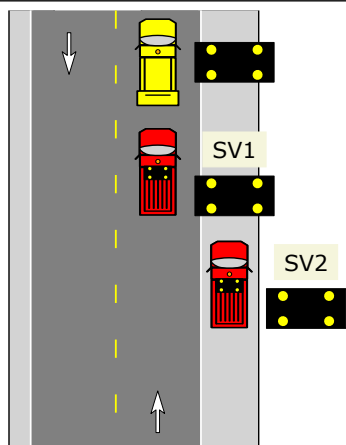


Figure 12-12

Multi-Lane Approach

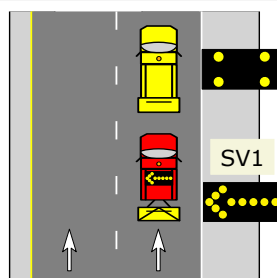


Figure 12-13

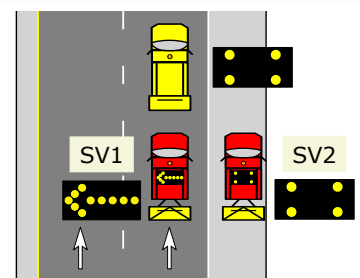


Figure 12-17

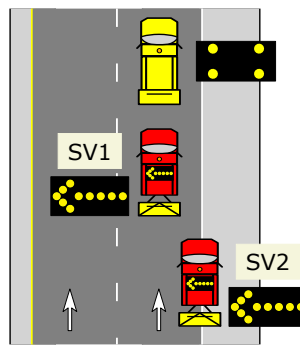


Figure 12-14

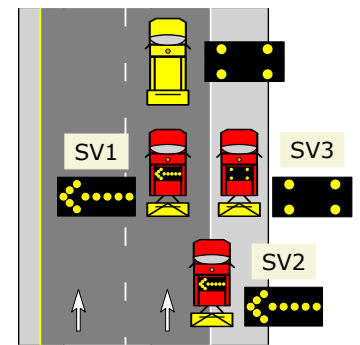


Figure 12-18

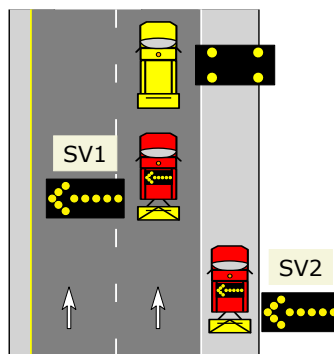


Figure 12-15

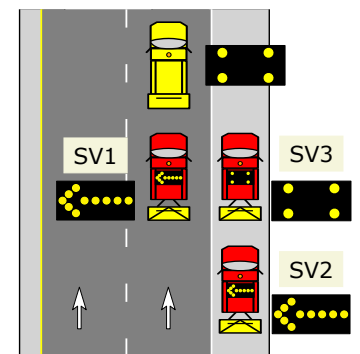


Figure 12-19

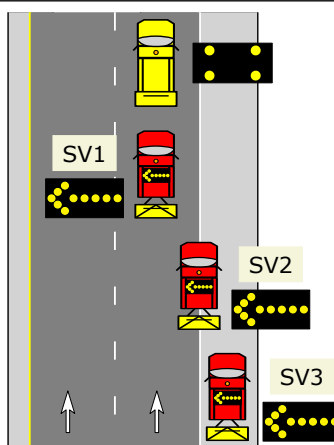


Figure 12-16

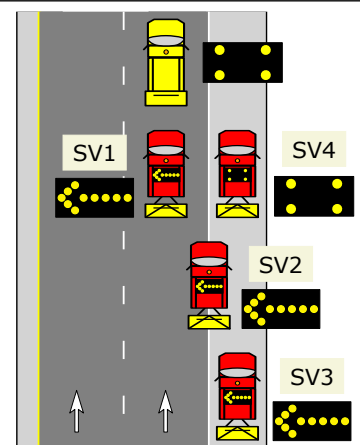


Figure 12-20

General Application 13

TTC Sign Adjustments Due to Roadside Obstruction

1. General Application 13 provides guidance on adjusting TTC sign placement within the advance warning area where an obstruction limits sign legibility distance (Refer to General Note A-2 for sign legibility requirements). The obstruction is represented on the plan by a red circle. A variable value of XX' refers to the minimum distance necessary to clear the obstruction. This value is determined on site.
2. The plan displays two alternative sign placement options in order to provide the sign legibility distance:
 - a) Primary Solution - Lengthen the buffer space by XX' and maintain the sign spacing required by the PATA. This achieves the goal of presenting a consistent appearance of TTC signs within the advance warning area.
 - b) Secondary Solution - Only extend spacing for the affected sign. Maintain other sign spacing required by the PATA. This achieves the goal of using minimal length for the activity area.

General Application 13 TTC Sign Adjustments Due to Roadside Obstruction

Problem Example	Solution Example	Solution Example
<p>Driver's view of a warning sign (One Lane Road Ahead) is limited by a roadside obstruction (Red Oval) when TTC devices are installed exactly as shown on the PATA.</p>	<p>Increase the buffer space (Distance E) by the amount needed (shown as XX') to address the obstruction. Maintain original sign spacing (Distance A) between all TTC signs within the advance warning area.</p>	<p>Increase the distance between the obstructed sign and next downstream sign (Distance A) by the amount needed (shown as XX') to address the obstruction. Maintain original sign spacing between other TTC signs within the advance warning area.</p>

Figure 13-1

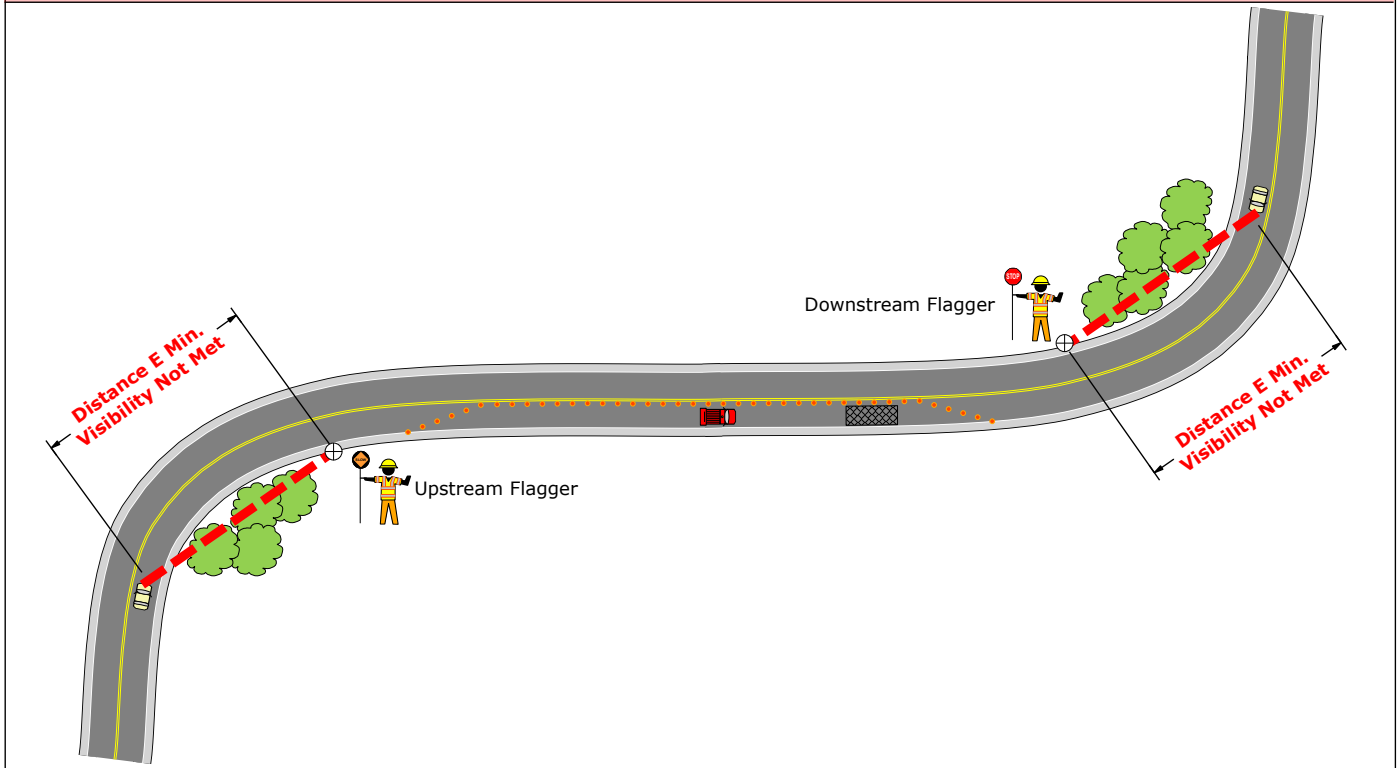
General Application 14-A Flagger Visibility on Horizontal Curves

1. General Application 14-A provides guidance on adjusting flagger station locations where sight distance is restricted by horizontal curves.

General Application 14-A Flagger Visibility on Horizontal Curves

Problem Example

Flaggers do not have minimum required visibility due to horizontal curves in the roadway.



Solution Example

Locate flagger stations around curves and lengthen line of channelizing devices on center line.

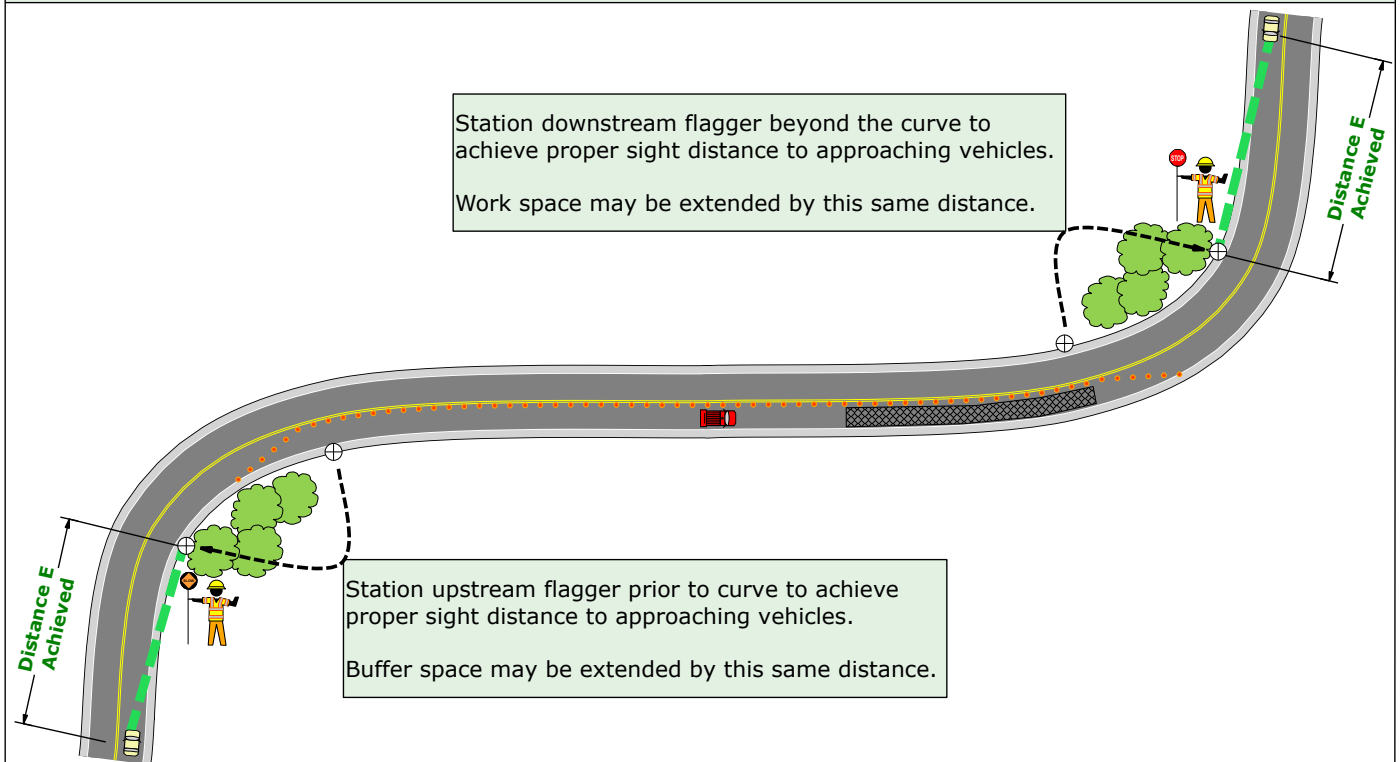


Figure 14-1

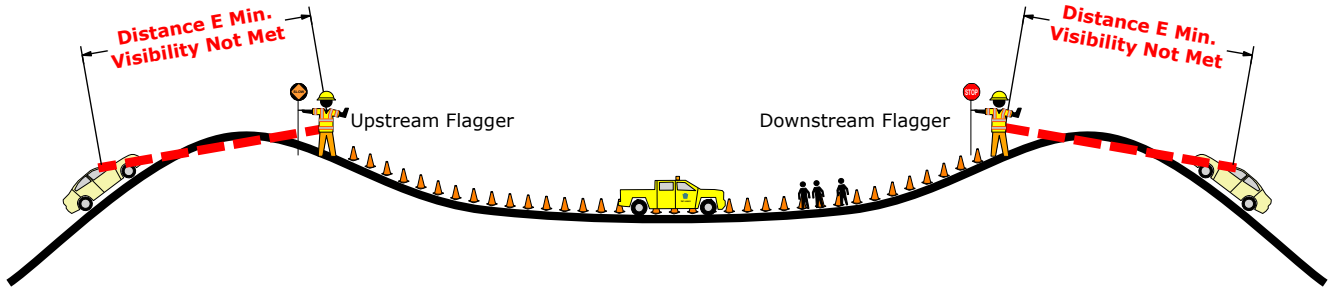
General Application 14-B Flagger Visibility on Vertical Curves

1. General Application 14-B provides guidance on adjusting flagger station locations where sight distance is restricted by vertical curves.

General Application 14-B Flagger Visibility on Vertical Curves

Problem Example

Flaggers do not have minimum required visibility due to vertical curves in the roadway.



Solution Example

Create flagger stations near vertical crests achieve proper visibility.

Station upstream flagger near vertical crest to achieve proper sight distance to approaching vehicles.

Buffer space may be extended by this same distance.

Station downstream flagger near vertical crest to achieve proper sight distance to approaching vehicles

Work space may be extended by this same distance.

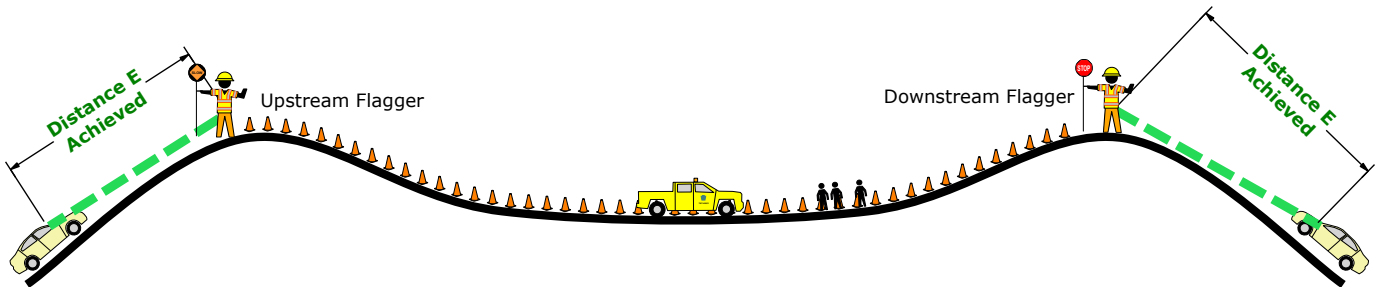


Figure 14-2

General Application 15-A Seal Coat Operations (Condition 1) No Pavement Markings Existing or Proposed

1. General Application 15-A may be used exclusively on roadways that have no pavement markings and it has been determined that pavement markings will not be installed upon conclusion of Oil & Chip and Skin Patching Operations.
2. FRESH OIL AND CHIPS signs are supplemental to TTC signs required by the PATA being utilized to perform the surface treatment operation. These signs must be installed prior to beginning surface treatment.
3. Install FRESH OIL AND CHIPS signs as follows:
 - a) Place one sign at each end of the treatment area:
 - Within 250' of the intersection where treatment begins, if work begins at an intersection.
 - Within 250' in advance of the treatment area, if work does not begin at an intersection.
 - b) Place one sign along each side road that intersects the treatment area:
 - Locate the sign within a reasonable distance prior to the intersection.
4. FRESH OIL AND CHIPS signs may remain in place for approximately one week after the surface treatment operation and shall only be removed after an inspection for excess aggregate is completed by a manager or supervisor.



**General Application 15-A
Seal Coat Operations (Condition 1)
No Pavement Markings Existing or Proposed**

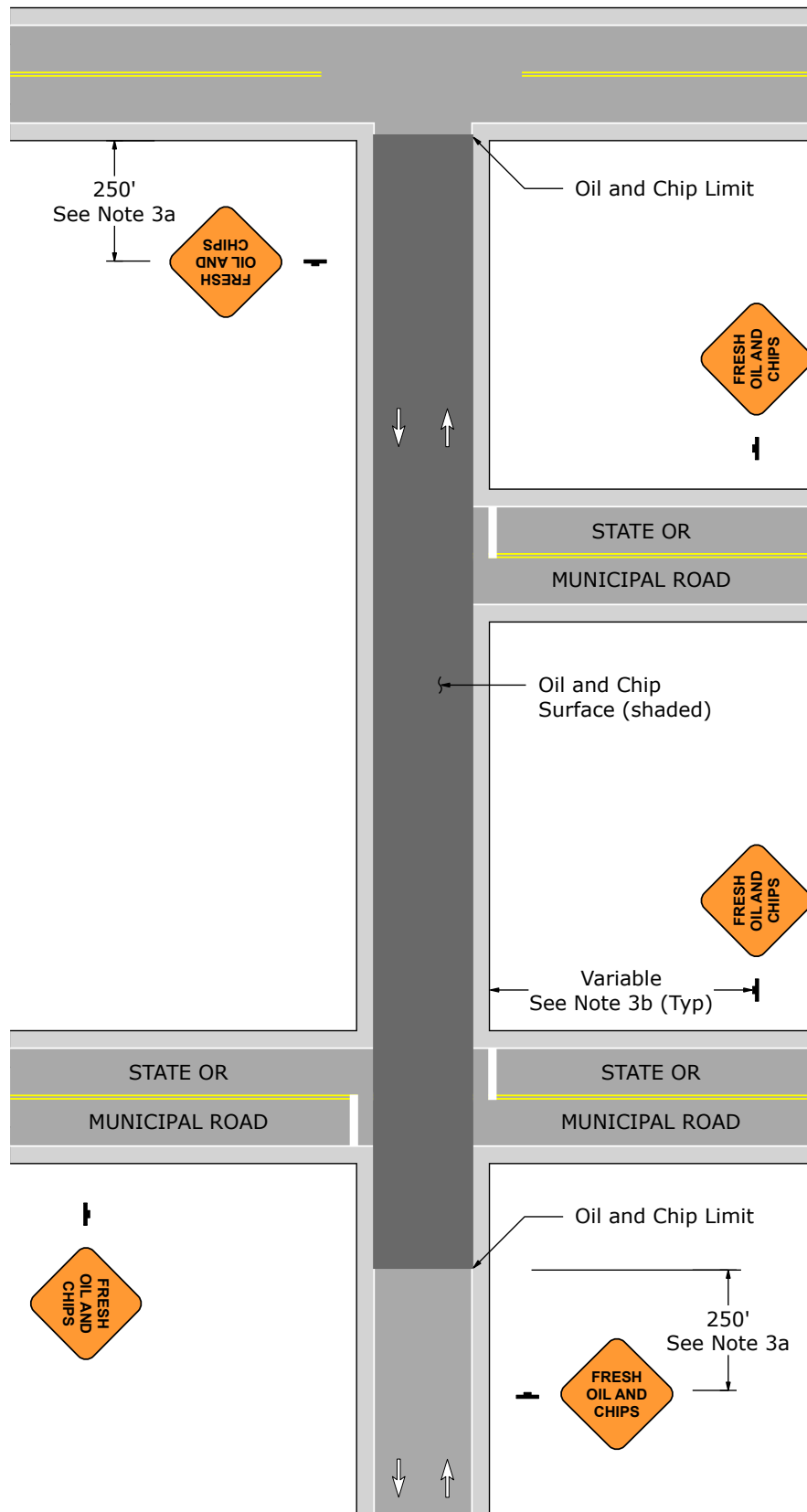




Figure 15-1

General Application 15-B Seal Coat Operations (Condition 2) Roadway has Pavement Markings & ADT is Less than 1000

1. General Application 15-B may be used on roadways approved by the the DTE after the DTU has documented analysis of crash history (review the Year End Cluster List Report for the following crash types at a minimum: Hit Tree, Hit Pole, Head On or Side Swipe, and Single Vehicle Run Off Road). Roadways must have existing pavement markings and an ADT of less than 1000 vehicles per day. In the event this plan is not approved by the DTE for the desired roadway, utilize General Application 15-C (Condition 3).
2. FRESH OIL AND CHIPS signs shown on this plan are supplemental to TTC signs required by the PATA being utilized to perform the surface treatment operation. These signs must be installed prior to beginning surface treatment.
3. Install FRESH OIL AND CHIPS signs as follows:
 - a) Place one sign at each end of the treatment area:
 - Within 250' of the intersection where treatment begins, if work begins at an intersection.
 - Within 500' in advance of the treatment area, if work does not begin at an intersection.
 - b) Place one sign along each side road that intersects the treatment area:
 - Locate the sign within a reasonable distance prior to the intersection.
4. Install two NO PAVEMENT MARKINGS signs along the roadway being treated. Place one sign in each direction approximately 250' downstream of the first FRESH OIL AND CHIPS sign. The DTU may waive the requirement for NO PAVEMENT MARKINGS signs based upon District Analysis of crash history for the treated roadway.
5. If used, all NO PAVEMENT MARKINGS signs must remain in place until the pavement markings have been replaced.
6. Installation of Temporary Non-plowable Raised Pavement Markers (chip seal markers) is optional. If used, place the first chip seal marker 40' after the beginning of the affected area. Spacing at 40' intervals throughout the project length is recommended. Remove all chip seal markers when permanent markings are reinstalled.
7. FRESH OIL AND CHIPS signs may remain in place for approximately one week after the surface treatment operation and shall only be removed after an inspection for excess aggregate is completed by a manager or supervisor.
8. In not less than 7 days or more than 14 days after completion of the operation, remove NO PAVEMENT MARKINGS signs and replace all lane lines and centerlines covered or destroyed during the operation with the applicable pavement marking pattern shown in standard PennDOT Publication 111, TC-8600 and the MUTCD.

Signs	
	
W21-16	W21-5-1

**General Application 15-B
Seal Coat Operations (Condition 2)
Roadway has Pavement Markings & ADT is Less than 1000**

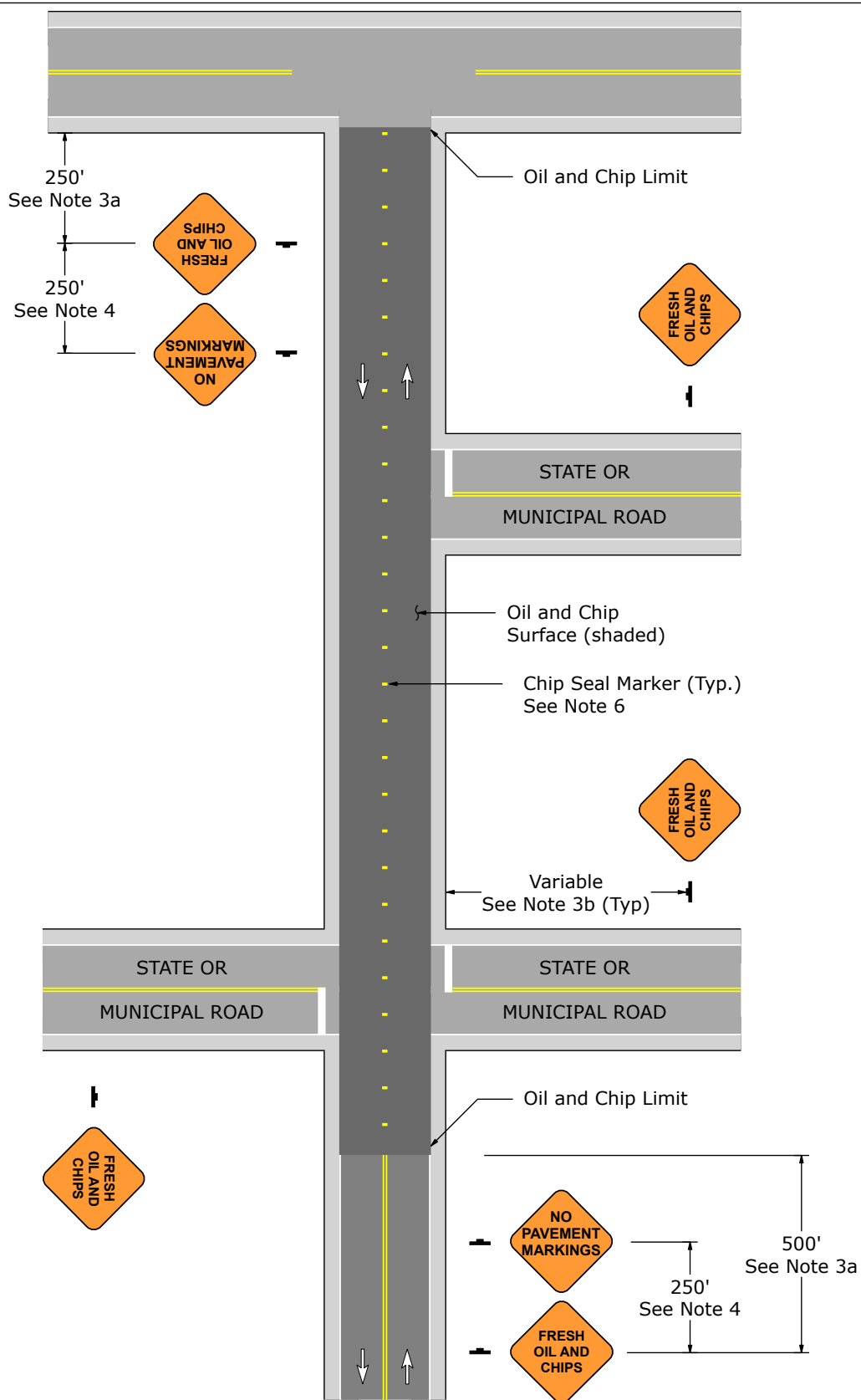




Figure 15-2

General Application 15-C Seal Coat Operations (Condition 3) Roadway has Pavement Markings & ADT between 1000 & 5000

1. General Application 15-C may be used on roadways with existing pavement markings and an ADT between 1000 and 5000 vehicles per day or those denied the General Application 15-B (Condition 2) plan.
2. FRESH OIL AND CHIPS signs shown on this plan are supplemental to TTC signs required by the PATA being utilized to perform the surface treatment operation. These signs must be installed prior to beginning surface treatment.
3. Install FRESH OIL AND CHIPS signs as follows:
 - a) Place one sign at each end of the treatment area:
 - Within 250' of the intersection where treatment begins, if work begins at an intersection.
 - Within 500' in advance of the treatment area, if work does not begin at an intersection.
 - b) Place one sign along each side road that intersects the treatment area:
 - Locate the sign within a reasonable distance prior to the intersection.
4. Install NO PAVEMENT MARKINGS signs along the treated road as follows:
 - a) Place one sign in each direction along the treated road 250' downstream of the first FRESH OIL AND CHIPS sign.
 - b) Place one sign within 500' downstream of every intersection with a State Road.
 - c) Consider installing additional signs at significant intersections with municipal roads and lengthy stretches of roadway where there are no side roads.
5. All NO PAVEMENT MARKINGS signs must remain in place until the pavement markings have been replaced.
6. Installation of Temporary Non-plowable Raised Pavement Markers (chip seal markers) is optional. If used, place the first chip seal marker 40' after the beginning of the affected area. Spacing at 40' intervals throughout the project length is recommended. Remove all chip seal markers when permanent markings are reinstalled.
7. FRESH OIL AND CHIPS signs may remain in place for approximately one week after the surface treatment operation and shall only be removed after an inspection for excess aggregate is completed by a manager or supervisor.
8. In not less than 7 days or more than 14 days after completion of the operation, remove NO PAVEMENT MARKINGS signs and replace all lane lines and centerlines covered or destroyed during the operation with the applicable pavement marking pattern shown in standard PennDOT Publication 111, TC-8600 and the MUTCD.

Signs	
	
W21-16	W21-5-1

**General Application 15-C
Seal Coat Operations (Condition 3)
Roadway has Pavement Markings & ADT between 1000 & 5000**

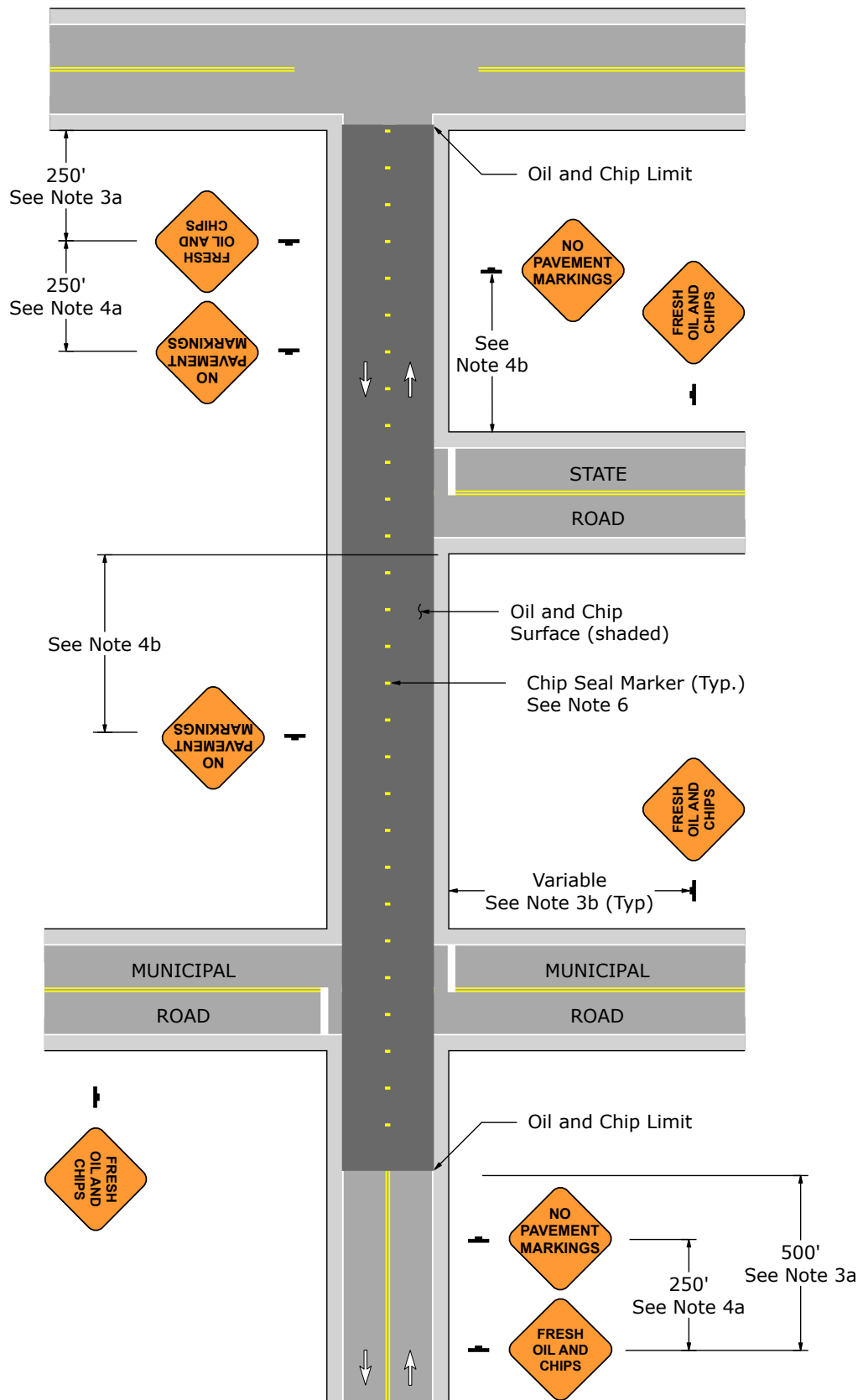




Figure 15-3

General Application 15-D Seal Coat Operations (Condition 4) Roadway has Pavement Markings & ADT is Greater than 5000

1. General Application 15-D may be used on roadways with existing pavement markings and an ADT greater than 5000 vehicles per day
2. FRESH OIL AND CHIPS signs shown on this plan are supplemental to TTC signs required by the PATA being utilized to perform the surface treatment operation. These signs must be installed prior to beginning surface treatment.
3. Install FRESH OIL AND CHIPS signs as follows:
 - a) Place one sign at each end of the treatment area along the treated road:
 - Within 250' of the intersection where treatment begins, if work begins at an intersection.
 - Within 500' in advance of the treatment area, if work does not begin at an intersection.
 - b) Place one sign along each side road that intersects the treatment area:
 - Locate the sign 250' upstream of the NO PAVEMENT MARKINGS sign.
4. Install NO PAVEMENT MARKINGS (W21-16) signs as follows:
 - a) Place one sign in each direction along the treated road 250' downstream of the first FRESH OIL AND CHIPS sign.
 - b) Place one sign along each side road that intersects the treatment area within a reasonable distance prior to the intersection.
 - c) Place signs at intervals of less than 1/2 mile through the affected area in both directions.
5. All NO PAVEMENT MARKINGS signs must remain in place until the pavement markings have been replaced.
6. Installation of Temporary Non-plowable Raised Pavement Markers (chip seal markers) is optional. If used, place the first chip seal marker 40' after the beginning of the affected area. Spacing at 40' intervals throughout the project length is recommended. Remove all chip seal markers when permanent markings are reinstalled.
7. FRESH OIL AND CHIPS signs may remain in place for approximately one week after the surface treatment operation and shall only be removed after an inspection for excess aggregate is completed by a manager or supervisor.
8. In not less than 7 days or more than 14 days after completion of the operation, remove NO PAVEMENT MARKINGS signs and replace all lane lines and centerlines covered or destroyed during the operation with the applicable pavement marking pattern shown in standard PennDOT Publication 111, TC-8600 and the MUTCD.

Signs	
	
W21-16	W21-5-1

**General Application 15-D
Seal Coat Operations (Condition 4)
Roadway has Pavement Markings & ADT is Greater than 5000**

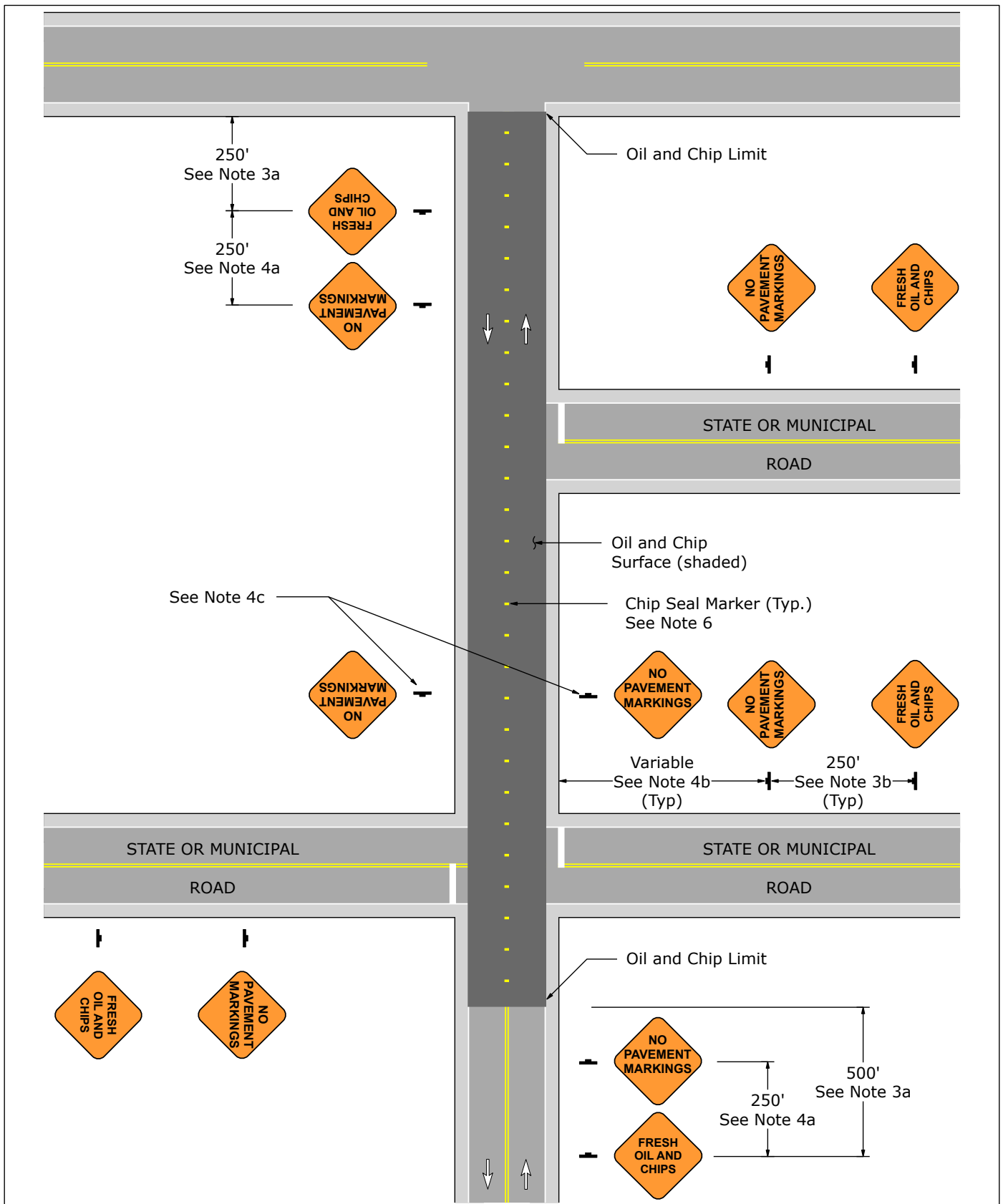










Figure 15-4

General Application 16 Merge-Then-Shift Pattern Approaching a Lane Closure

1. General Application 16 shows an alternative way to implement a lane closure on a multi-lane approach. It is a traffic calming technique that moves traffic merging movements upstream and away from the activity area.
2. TTC devices are shown where the work space is in the left lane. An opposite pattern may be established by reversing TTC signs and channelizing devices. TTC device spacing and dimensions should match those of the primary TTC plan.
3. Long-term operations require temporary pavement markings and eradication of conflicting pavement markings.
4. This may be used on freeways/expressways and conventional highways with a multi-lane approach.

Signs							
							
W20-1	W4-2L	W4-2R	W5-5	W1-4R	W1-4L	W20-5R	W20-5L

General Application 16 Merge-Then-Shift Pattern Approaching a Lane Closure

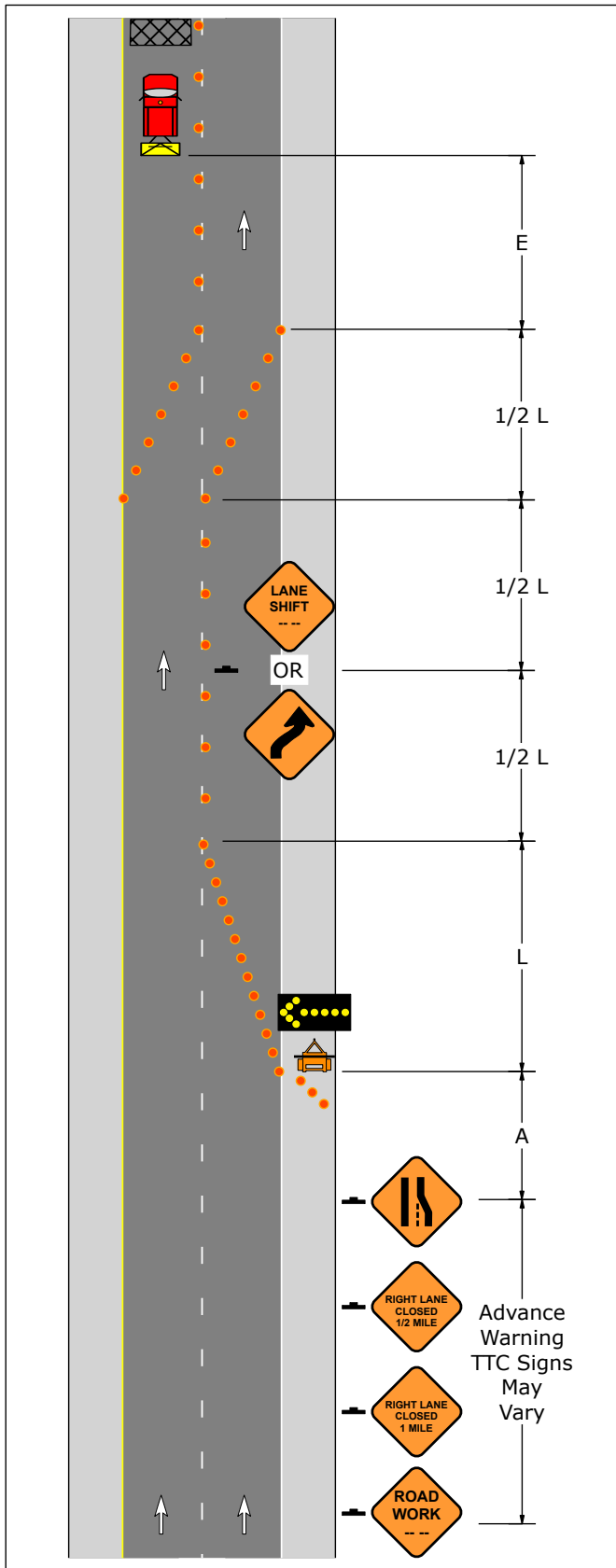


Figure 16-1
Work Space in the Left Lane

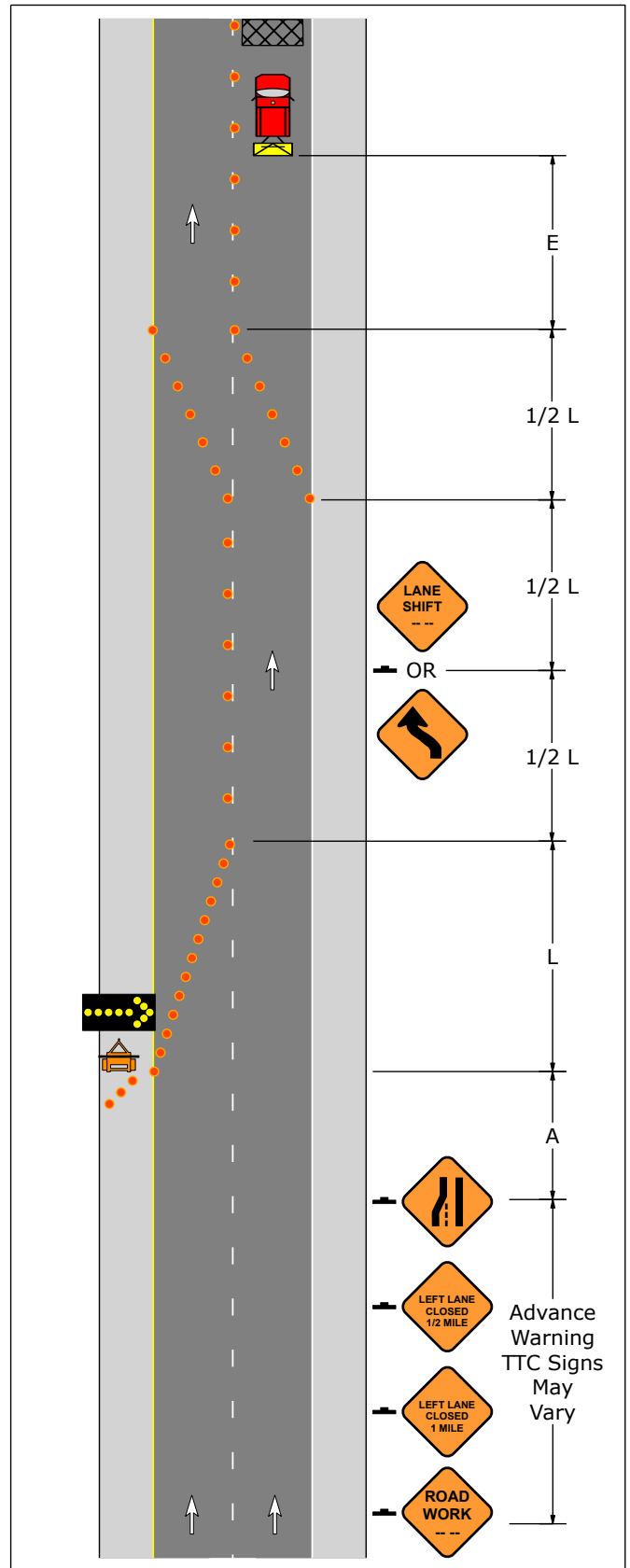


Figure 16-2
Work Space in the Right Lane

General Application 17 Advisory Speed Posting Guide

Figure 17-1

Regulatory Speed Limit	Work Zone Speed Limit	Advisory Speed ** In Advance of the Activity Area			
		4th Sign (Furthest From WZ)	3rd Sign	2nd Sign	1st Sign (Closest To WZ)
MPH	MPH				
70	60	-	60	60	60
70	55*	60	60	55	55
70	50*	60	55	50	50
65	55	-	55	55	55
65	50*	55	55	50	50
65	45*	55	50	45	45
55	45	50	50	45	45
55	40*	50	45	40	40
55	35*	50	45	40	35
50	40	45	45	40	40
50	35*	50	40	35	35
50	30*	45	40	35	30
45	35	45	35	35	35
45	30*	45	35	35	30
45	25*	-	35	30	25
40	30	-	-	30	30
40	25*	-	-	30	25
35	30	-	-	30	30
35	25	-	-	25	25
30	25	-	-	-	25

* A regulatory speed limit up to 10 MPH below the normal speed limit may be established without an engineering and traffic study, provided the reduced regulatory speed limit is at least 25 MPH. Regulatory speed limits less than 25 MPH or more than 10 MPH below the normal speed limit require an engineering and traffic study and the prior approval of the District Traffic Engineer for state designated highways and approval of a Traffic Engineer as determined by local authorities for local highways. To qualify for an additional speed limit reduction, the engineering and traffic study must indicate that traffic queues, erratic maneuvers, high vehicle crash rates, or undesirable working conditions exist on the project or have existed on similar projects.

** Use of advisory speed plaques is optional.

Pennsylvania Typical Applications

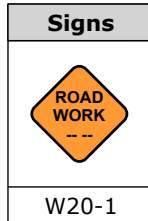
Blank Page

Conventional Highways

Short-Term Stationary Operations
(PATA 100 Series)

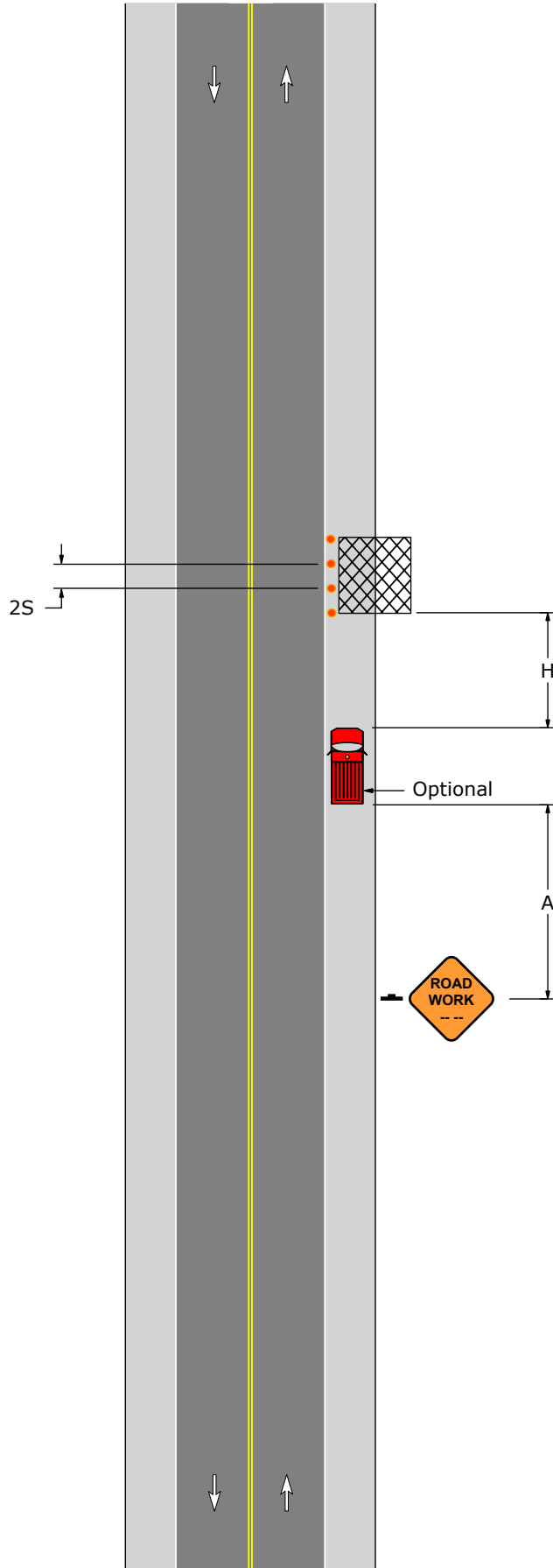
PATA 101-A

1. The shadow vehicle and TTC devices are not required if the work space is outside the highway right-of-way, behind barrier, more than 2' behind curb, or 15' or more from the edge of the roadway.
2. For operations of 60 minutes or less, all TTC devices may be eliminated if a shadow vehicle is present and the operation does not proceed against normal traffic flow.
3. When a shadow vehicle is not used, distance A is measured from the ROAD WORK sign.



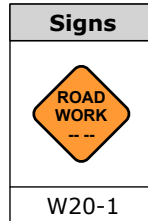
Sign Spacing, Channelizing Device Spacing, and Roll Ahead Space				
Speed	Channelizing Devices Spacing	Sign Spacing		Roll Ahead Space
		Urban	Rural	
S (MPH)	2S (Feet)	A (Feet)	A (Feet)	H (Feet)
25	50	100 - 200	500 - 800	150
30	60	100 - 200	500 - 800	150
35	70	100 - 200	500 - 800	150
40	80	350 - 500	500 - 800	150
45	90	350 - 500	500 - 800	150
50	100	350 - 500	500 - 800	250
55	110	350 - 500	500 - 800	250

PATA 101-A



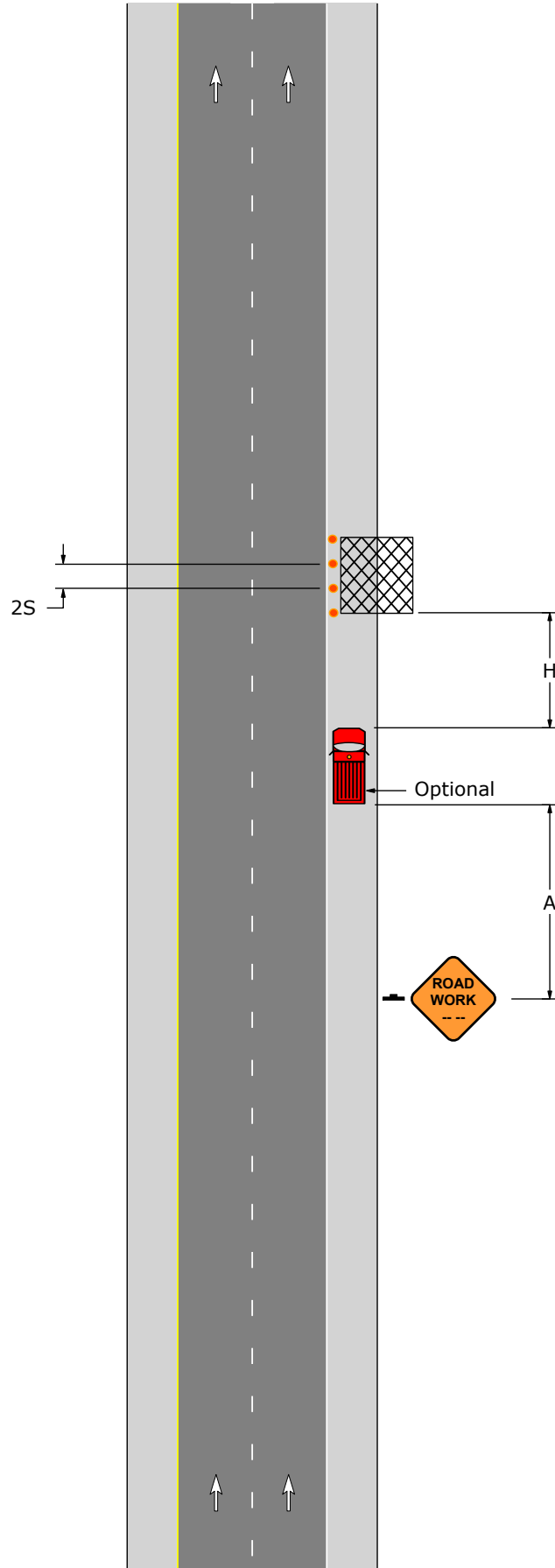
PATA 101-B

1. The shadow vehicle and TTC devices are not required if the work space is outside the highway right-of-way, behind barrier, more than 2' behind curb, or 15' or more from the edge of the roadway.
2. For operations of 60 minutes or less, all TTC devices may be eliminated if a shadow vehicle is present and the operation does not proceed against normal traffic flow.
3. When a shadow vehicle is not used, distance A is measured from the ROAD WORK sign.



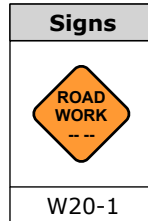
Sign Spacing, Channelizing Device Spacing, and Roll Ahead Space				
Speed	Channelizing Devices Spacing	Sign Spacing		Roll Ahead Space
		Urban	Rural	
S (MPH)	2S (Feet)	A (Feet)	A (Feet)	H (Feet)
25	50	100 - 200	500 - 800	150
30	60	100 - 200	500 - 800	150
35	70	100 - 200	500 - 800	150
40	80	350 - 500	500 - 800	150
45	90	350 - 500	500 - 800	150
50	100	350 - 500	500 - 800	250
55	110	350 - 500	500 - 800	250

PATA 101-B



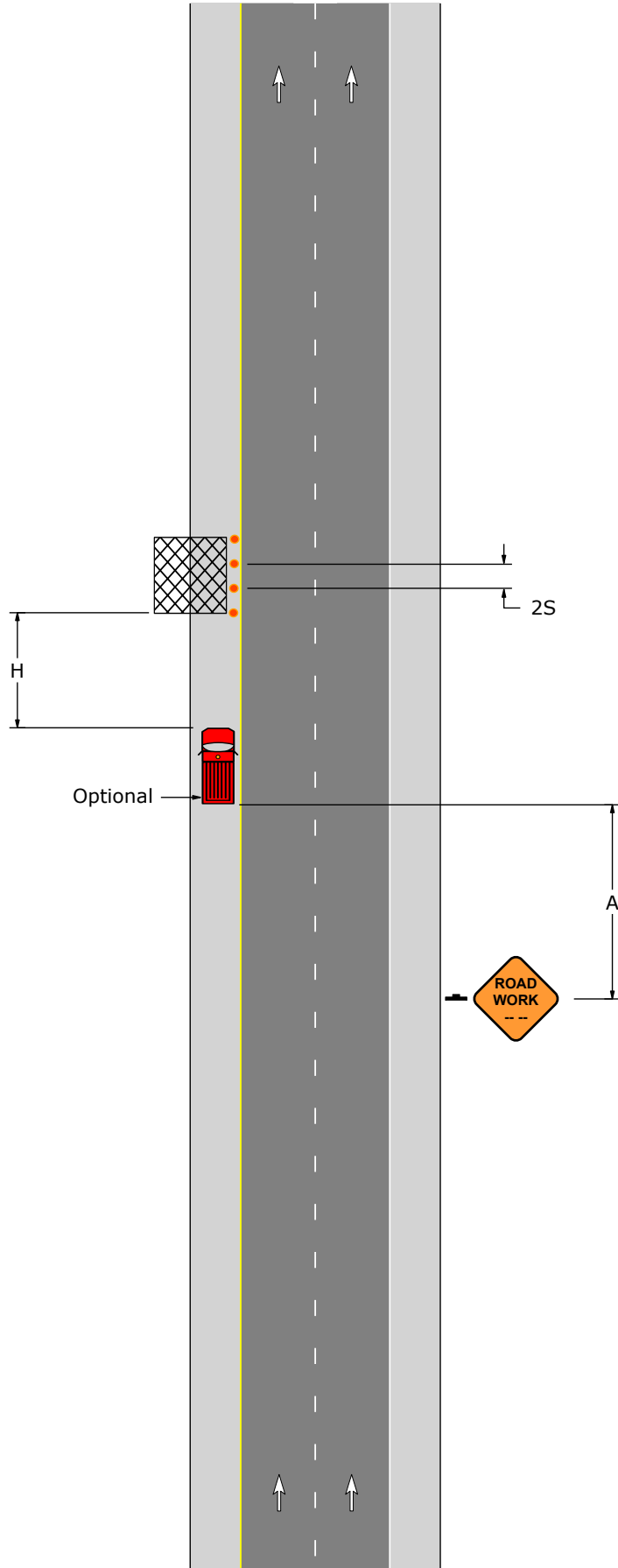
PATA 101-C

1. The shadow vehicle and TTC devices are not required if the work space is outside the highway right-of-way, behind barrier, more than 2' behind curb, or 15' or more from the edge of the roadway.
2. For operations of 60 minutes or less, all TTC devices may be eliminated if a shadow vehicle is present and the operation does not proceed against normal traffic flow.
3. When a shadow vehicle is not used, distance A is measured from the ROAD WORK sign.



Sign Spacing, Channelizing Device Spacing, and Roll Ahead Space				
Speed	Channelizing Devices Spacing	Sign Spacing		Roll Ahead Space
		Urban	Rural	
S (MPH)	2S (Feet)	A (Feet)	A (Feet)	H (Feet)
25	50	100 - 200	500 - 800	150
30	60	100 - 200	500 - 800	150
35	70	100 - 200	500 - 800	150
40	80	350 - 500	500 - 800	150
45	90	350 - 500	500 - 800	150
50	100	350 - 500	500 - 800	250
55	110	350 - 500	500 - 800	250

PATA 101-C



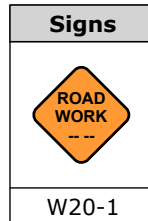
PATA 102

1. For operations of 15 minutes or less:

a) The ROAD WORK sign is not required.

b) All channelizing devices may be eliminated if a shadow vehicle is present and the operation does not proceed against normal traffic flow.

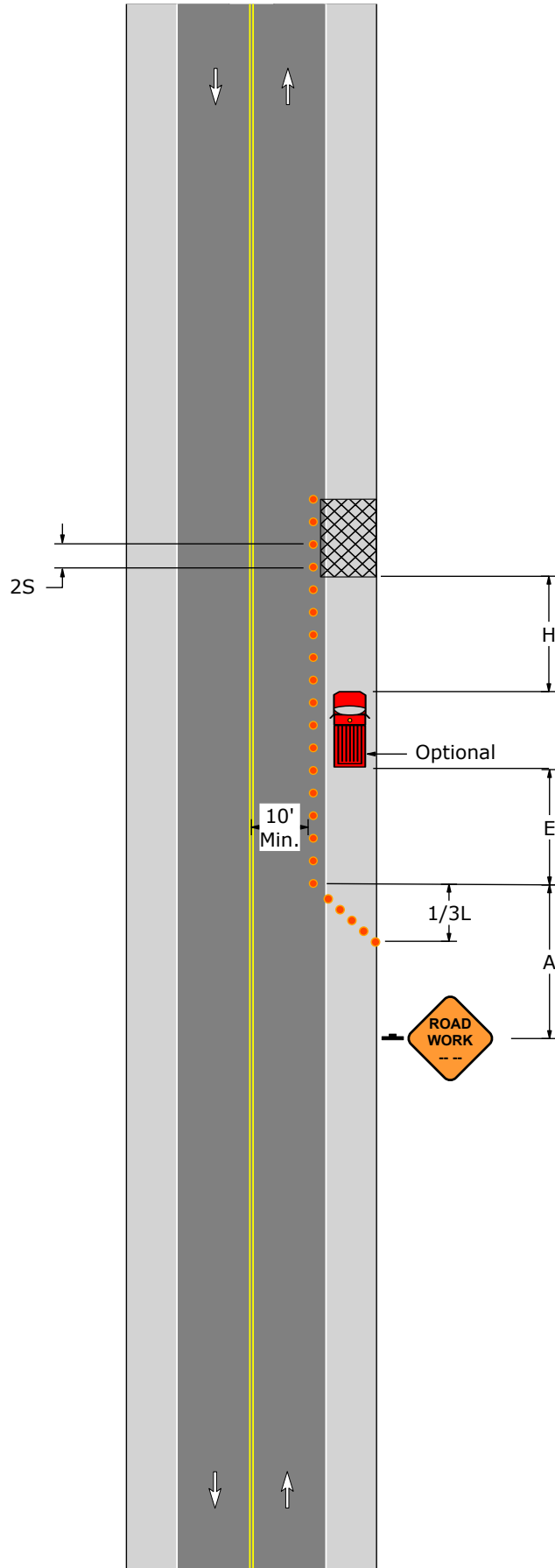
2. When a shadow vehicle is not used, distance E is measured from the end of the taper to the beginning of the work space.



Sign Spacing, Channelizing Device Spacing, Buffer Space, and Roll Ahead Space					
Speed	Channelizing Devices Spacing	Sign Spacing		Buffer Space	Roll Ahead Space
		Urban	Rural		
S (MPH)	2S (Feet)	A (Feet)	A (Feet)	E (Feet)	H (Feet)
25	50	100 - 200	500 - 800	155	150
30	60	100 - 200	500 - 800	200	150
35	70	100 - 200	500 - 800	250	150
40	80	350 - 500	500 - 800	305	150
45	90	350 - 500	500 - 800	360	150
50	100	350 - 500	500 - 800	425	250
55	110	350 - 500	500 - 800	495	250



Taper Lengths and Minimum Number of Channelizing Devices		
Speed	Shoulder Taper: 1/3L	
S (MPH)	Length (Feet)	Minimum Number Of Devices
25	45	6
30	60	6
35	85	6
40	110	6
45	180	6
50	200	6
55	220	6

PATA 102



PATA 103

1. The RIGHT REVERSE CURVE sign shall only be used when lane shifts onto shoulder.
2. When a shadow vehicle is not used, distance E is measured from the end of the taper to the beginning of the work space.




Signs	
	
W20-1	W5-5

Sign Spacing, Channelizing Device Spacing, Buffer Space, and Roll Ahead Space					
Speed	Channelizing Devices Spacing	Sign Spacing		Buffer Space	Roll Ahead Space
		Urban	Rural		
S (MPH)	2S (Feet)	A (Feet)	A (Feet)	E (Feet)	H (Feet)
25	50	100 - 200	500 - 800	155	150
30	60	100 - 200	500 - 800	200	150
35	70	100 - 200	500 - 800	250	150
40	80	350 - 500	500 - 800	305	150
45	90	350 - 500	500 - 800	360	150
50	100	350 - 500	500 - 800	425	250
55	110	350 - 500	500 - 800	495	250

Taper Lengths and Minimum Number Of Channelizing Devices						
Speed	Shifting Taper: 1/2L		Shoulder Taper: 1/3L		50' Per Lane Taper	
S (MPH)	Length (Feet)	Minimum Number Of Devices	Length (Feet)	Minimum Number Of Devices	Length (Feet)	Minimum Number Of Devices
25	65	6	45	6	50	6
30	90	6	60	6	50	6
35	125	6	85	6	50	6
40	160	6	110	6	50	6
45	270	7	180	6	50	6
50	300	7	200	6	50	6
55	330	7	220	6	50	6

PATA 104

1. The RIGHT REVERSE CURVE sign shall only be used when lane shifts onto shoulder.
2. When a shadow vehicle is not used, distance E is measured from the end of the taper to the beginning of the work space.

Signs		
		
W20-1	W5-5	R4-7

Sign Spacing, Channelizing Device Spacing, Buffer Space, and Roll Ahead Space					
Speed	Channelizing Devices Spacing	Sign Spacing		Buffer Space	Roll Ahead Space
		Urban	Rural		
S (MPH)	2S (Feet)	A (Feet)	A (Feet)	E (Feet)	H (Feet)
25	50	100 - 200	500 - 800	155	150
30	60	100 - 200	500 - 800	200	150
35	70	100 - 200	500 - 800	250	150
40	80	350 - 500	500 - 800	305	150
45	90	350 - 500	500 - 800	360	150
50	100	350 - 500	500 - 800	425	250
55	110	350 - 500	500 - 800	495	250

Taper Lengths and Minimum Number Of Channelizing Devices		
Speed	Shifting Taper: 1/2L	
S (MPH)	Length (Feet)	Minimum Number Of Devices
25	65	6
30	90	6
35	125	6
40	160	6
45	270	7
50	300	7
55	330	7





PATA 105

1. Left turns may be prohibited as required by geometric conditions.

a) On undivided streets, one NO LEFT TURN sign should be placed at the near right-hand corner and one at the far left-hand corner.

b) On divided streets, one NO LEFT TURN sign should be placed on the near side end of the median and one at the far side end of the median.

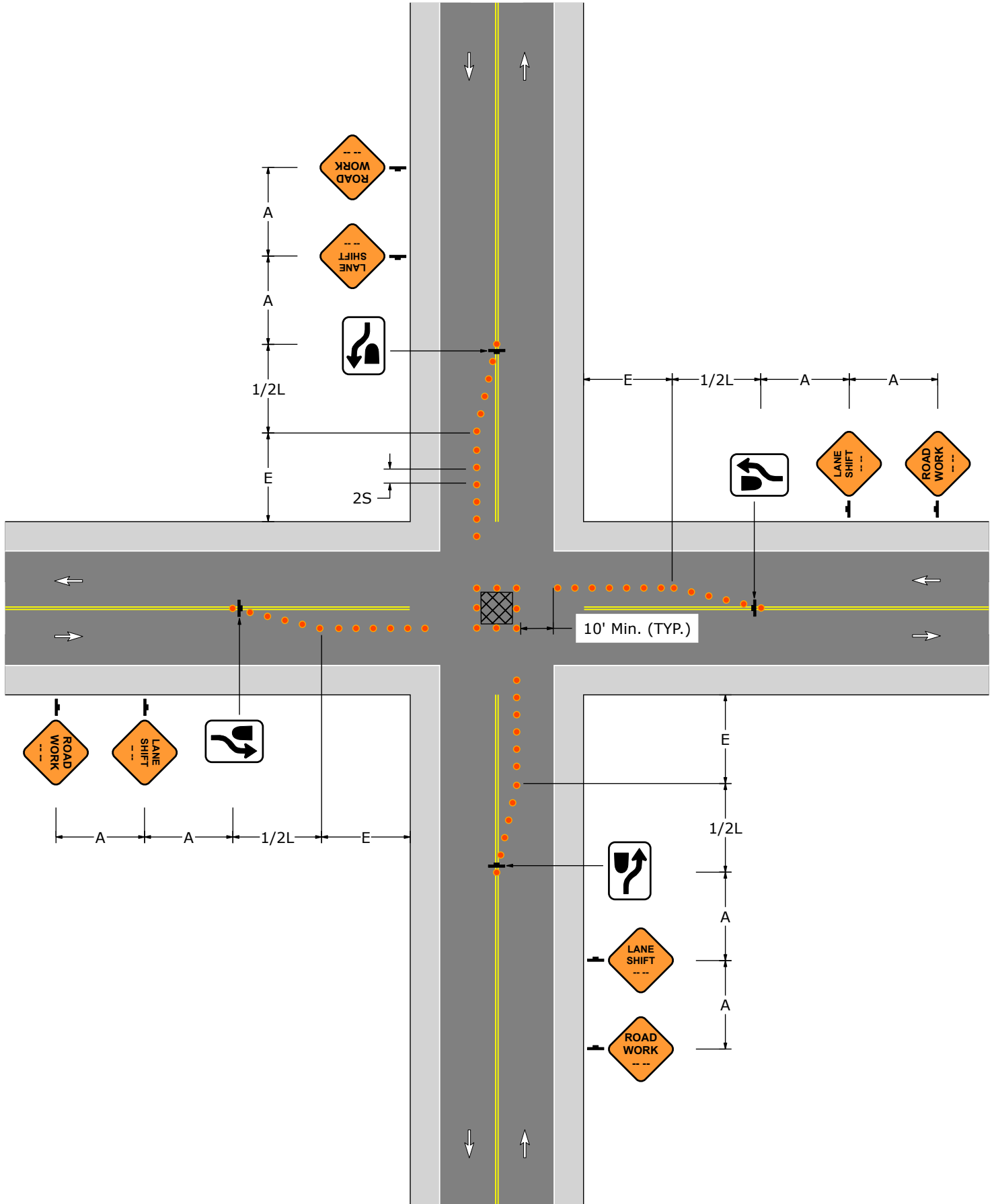
2. The RIGHT REVERSE CURVE sign shall only be used when lane shifts onto shoulder.

Signs			
			
W20-1	W5-5	R4-7	R3-2

Sign Spacing, Channelizing Device Spacing, and Buffer Space				
Speed	Channelizing Devices Spacing	Sign Spacing		Buffer Space
		Urban	Rural	
S (MPH)	2S (Feet)	A (Feet)	A (Feet)	E (Feet)
25	50	100 - 200	500 - 800	155
30	60	100 - 200	500 - 800	200
35	70	100 - 200	500 - 800	250
40	80	350 - 500	500 - 800	305
45	90	350 - 500	500 - 800	360
50	100	350 - 500	500 - 800	425
55	110	350 - 500	500 - 800	495




Taper Lengths and Minimum Number Of Channelizing Devices		
Speed	Shifting Taper: 1/2L	
S (MPH)	Length (Feet)	Minimum Number Of Devices
25	65	6
30	90	6
35	125	6
40	160	6
45	270	7
50	300	7
55	330	7

PATA 105



PATA 106

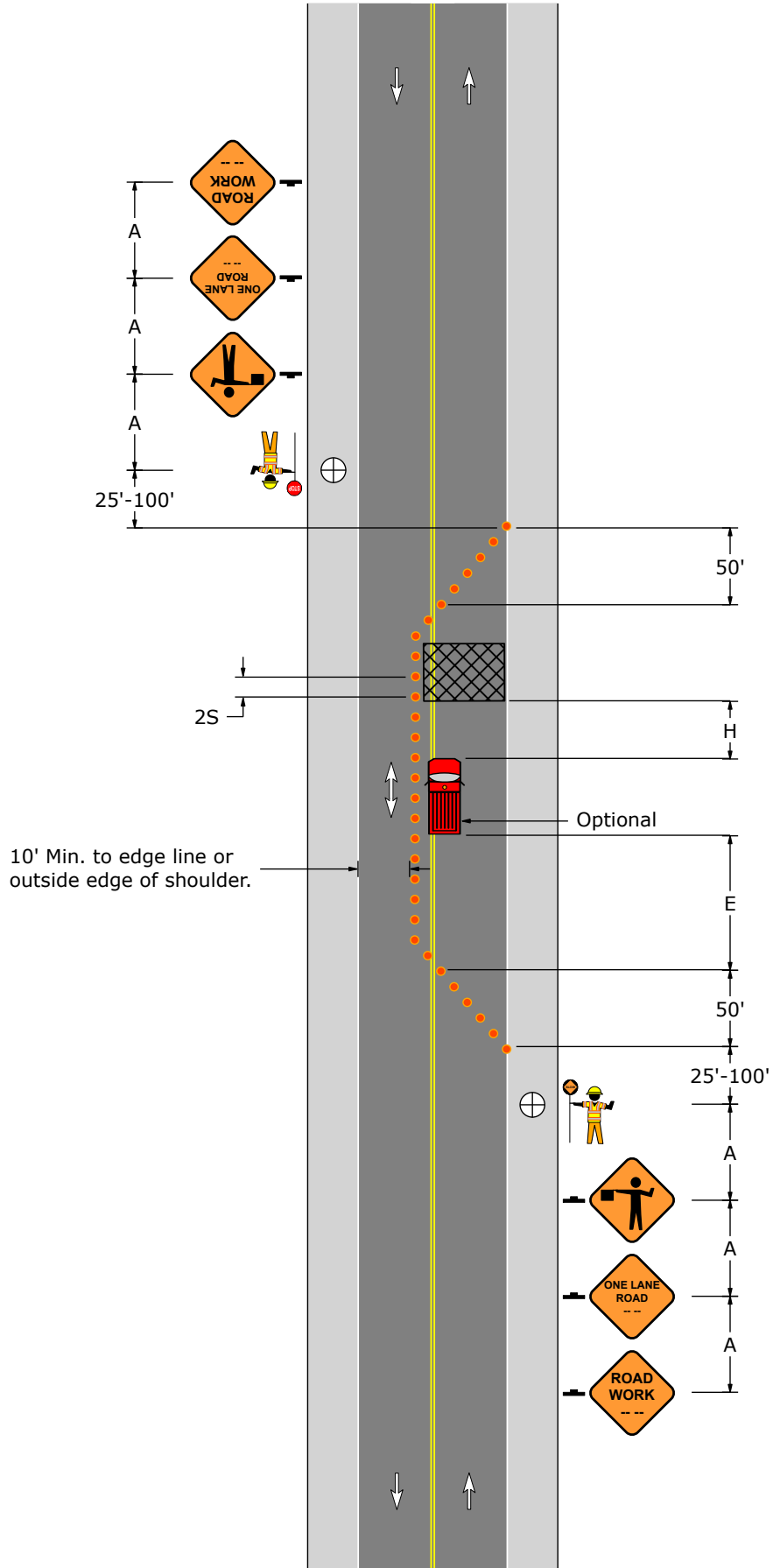
1. Place 50' taper in closed lane as shown. Continue taper angle and spacing as needed on the opposite side of the roadway center line while maintaining a 10' minimum lane width.
2. Flaggers shall be clearly visible to traffic for a minimum distance of E.
3. When a shadow vehicle is not used, distance E is measured from the end of the taper to the beginning of the work space.

Signs		
		
W20-1	W20-4	W20-7

Sign Spacing, Channelizing Device Spacing, Buffer Space, and Roll Ahead Space					
Speed	Channelizing Devices Spacing	Sign Spacing		Buffer Space	Roll Ahead Space
		Urban	Rural		
S (MPH)	2S (Feet)	A (Feet)	A (Feet)	E (Feet)	H (Feet)
25	50	100 - 200	500 - 800	155	150
30	60	100 - 200	500 - 800	200	150
35	70	100 - 200	500 - 800	250	150
40	80	350 - 500	500 - 800	305	150
45	90	350 - 500	500 - 800	360	150
50	100	350 - 500	500 - 800	425	250
55	110	350 - 500	500 - 800	495	250




Taper Lengths and Minimum Number Of Channelizing Devices		
Speed	50' Per Lane Taper	
S (MPH)	Length (Feet)	Minimum Number Of Devices
25	50	6
30	50	6
35	50	6
40	50	6
45	50	6
50	50	6
55	50	6

PATA 106



PATA 107

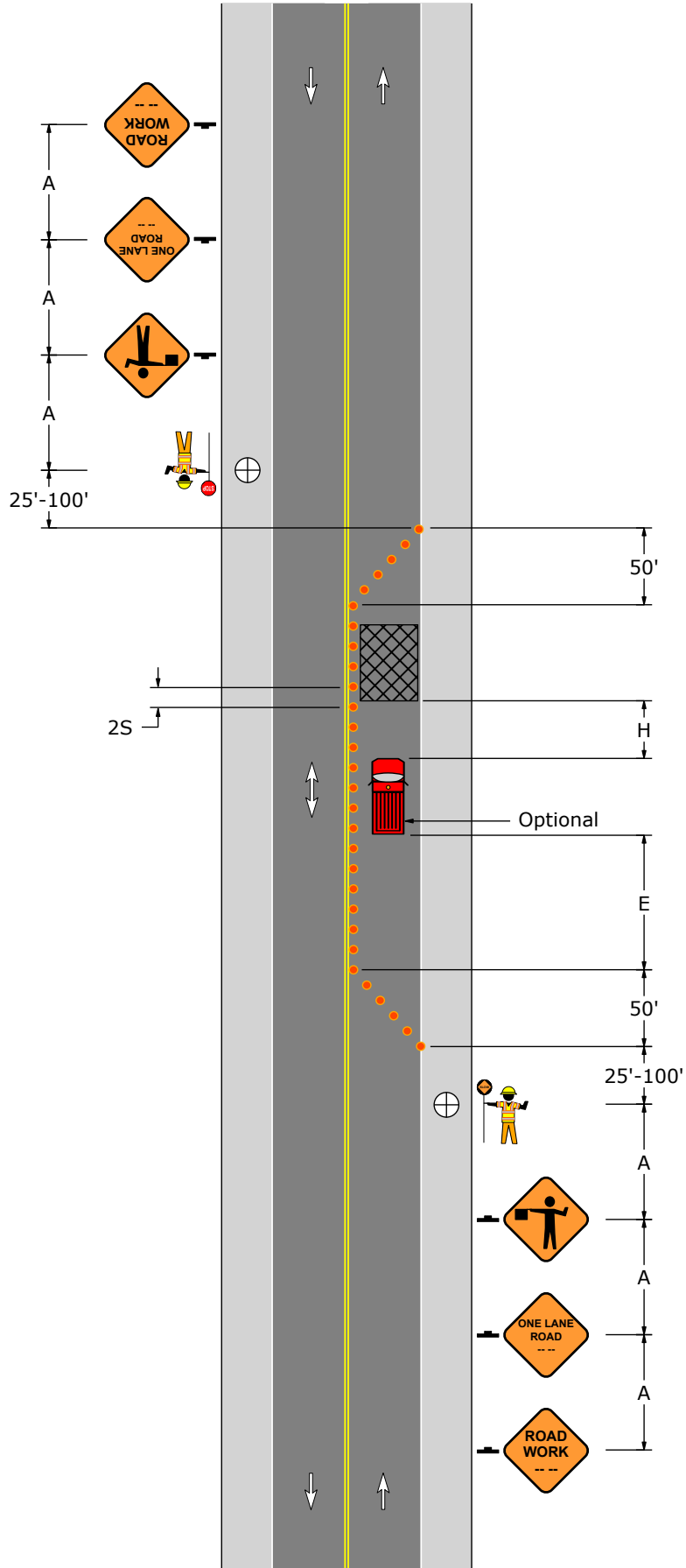
1. Flaggers shall be clearly visible to traffic for a minimum distance of E.
2. For operations of 15 minutes or less:
 - a) The ROAD WORK, ONE LANE ROAD, and FLAGGER SYMBOL signs are not required.
 - b) All channelizing devices may be eliminated if a shadow vehicle is present and the operation does not proceed against normal traffic flow.
3. When a shadow vehicle is not used, distance E is measured from the end of the taper to the beginning of the work space.

Signs		
		
W20-1	W20-4	W20-7

Sign Spacing, Channelizing Device Spacing, Buffer Space, and Roll Ahead Space					
Speed	Channelizing Devices Spacing	Sign Spacing		Buffer Space	Roll Ahead Space
		Urban	Rural		
S (MPH)	2S (Feet)	A (Feet)	A (Feet)	E (Feet)	H (Feet)
25	50	100 - 200	500 - 800	155	150
30	60	100 - 200	500 - 800	200	150
35	70	100 - 200	500 - 800	250	150
40	80	350 - 500	500 - 800	305	150
45	90	350 - 500	500 - 800	360	150
50	100	350 - 500	500 - 800	425	250
55	110	350 - 500	500 - 800	495	250

Taper Lengths and Minimum Number Of Channelizing Devices		
Speed	50' Per Lane Taper	
S (MPH)	Length (Feet)	Minimum Number Of Devices
25	50	6
30	50	6
35	50	6
40	50	6
45	50	6
50	50	6
55	50	6

PATA 107



PATA 108

1. This drawing applies when all of the following conditions are satisfied:




- a) Roadway is two-lane, two-way.
- b) Sight distance between the flagger and any vehicle between Points X and Y will be unobstructed.
- c) The ADT is not greater than approximately 1500.

2. The flagger shall be clearly visible to traffic for a minimum distance of E.

3. For operations of 15 minutes or less:

- a) ROAD WORK, ONE LANE ROAD, and FLAGGER SYMBOL signs are not required.
- b) All channelizing devices may be eliminated if a shadow vehicle is present and the operation does not proceed against normal traffic flow.

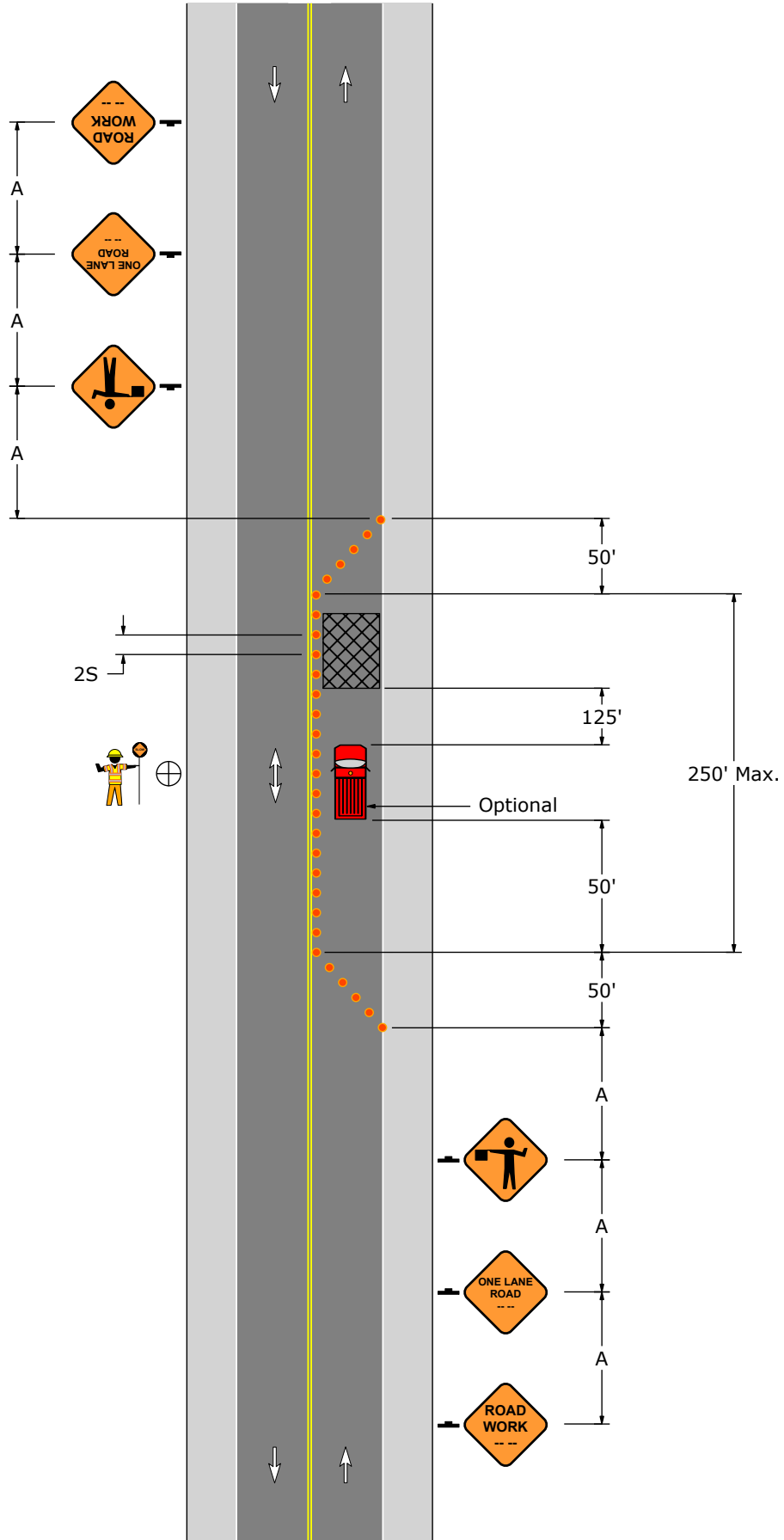
4. When a shadow vehicle is not used, 50' is measured from the end of the taper to the beginning of the work space.

Signs		
		
W20-1	W20-4	W20-7

Sign and Channelizing Device Spacing				
Speed	Channelizing Devices Spacing	Sign Spacing		Buffer Space
		Urban	Rural	
S (MPH)	2S (Feet)	A (Feet)	A (Feet)	E (Feet)
25	50	100 - 200	500 - 800	155
30	60	100 - 200	500 - 800	200
35	70	100 - 200	500 - 800	250
40	80	350 - 500	500 - 800	305
45	90	350 - 500	500 - 800	360
50	100	350 - 500	500 - 800	425
55	110	350 - 500	500 - 800	495

Taper Lengths and Minimum Number Of Channelizing Devices		
Speed	50' Per Lane Taper	
S (MPH)	Length (Feet)	Minimum Number Of Devices
25	50	6
30	50	6
35	50	6
40	50	6
45	50	6
50	50	6
55	50	6

PATA 108



PATA 109 (A Through L)

1. PATA 109 drawings show work spaces on roads that approach and depart T-intersections with through-roads. Single-flagger or multi-flagger intersection control is illustrated for intersections with three types of permanent control:




- a) One-Way Stop
- b) All-Way Stop
- c) Traffic Signal

2. Flaggers shall be clearly visible to traffic for a minimum distance of E.

3. For operations of 15 minutes or less:

- a) The ROAD WORK, ONE LANE ROAD, and FLAGGER SYMBOL signs are not required.
- b) All channelizing devices may be eliminated if a shadow vehicle is present and the operation does not proceed against normal traffic flow.

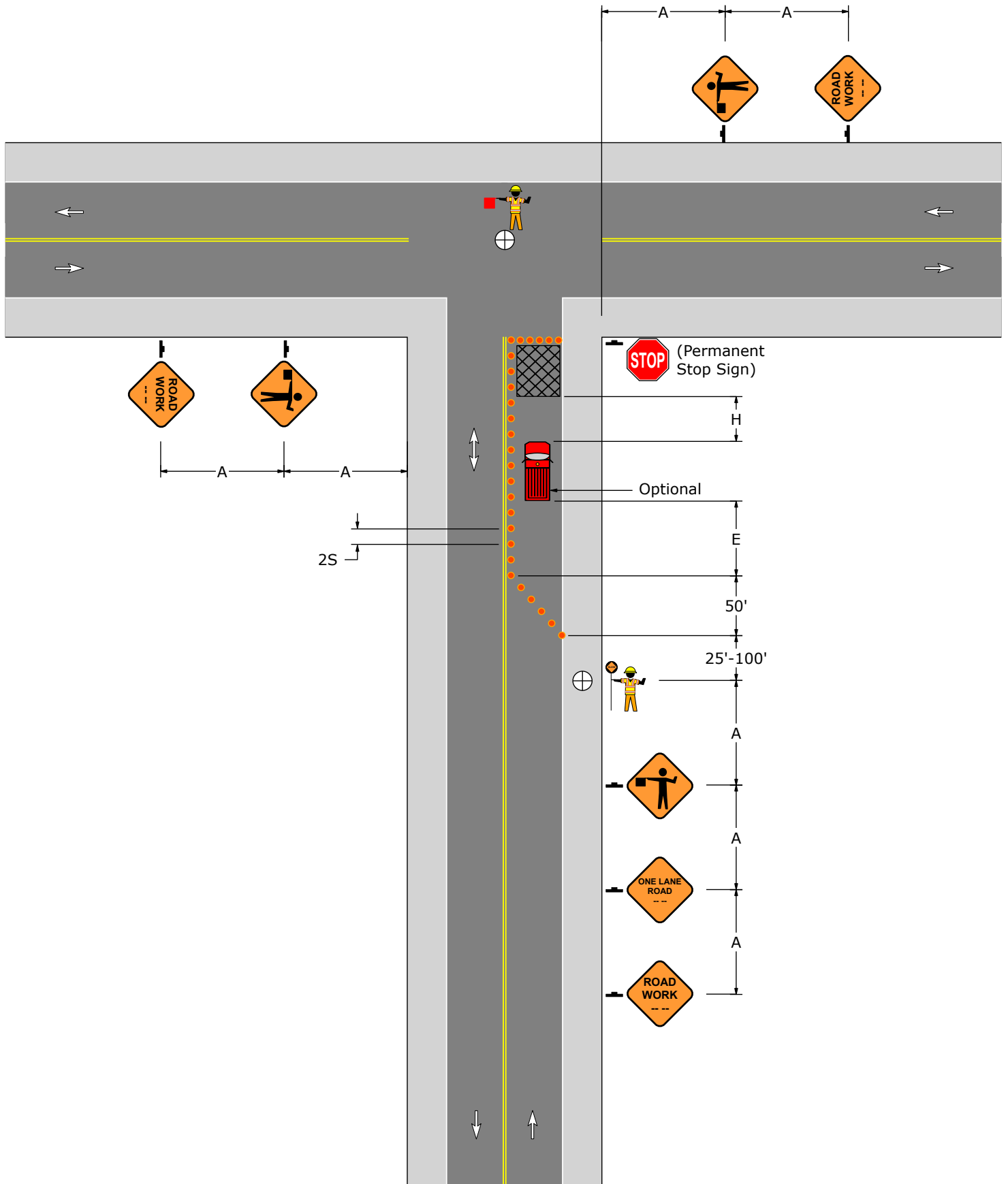
4. When a shadow vehicle is not used, distance E is measured from the end of the taper to the beginning of the work space.

Signs		
		
W20-1	W20-4	W20-7

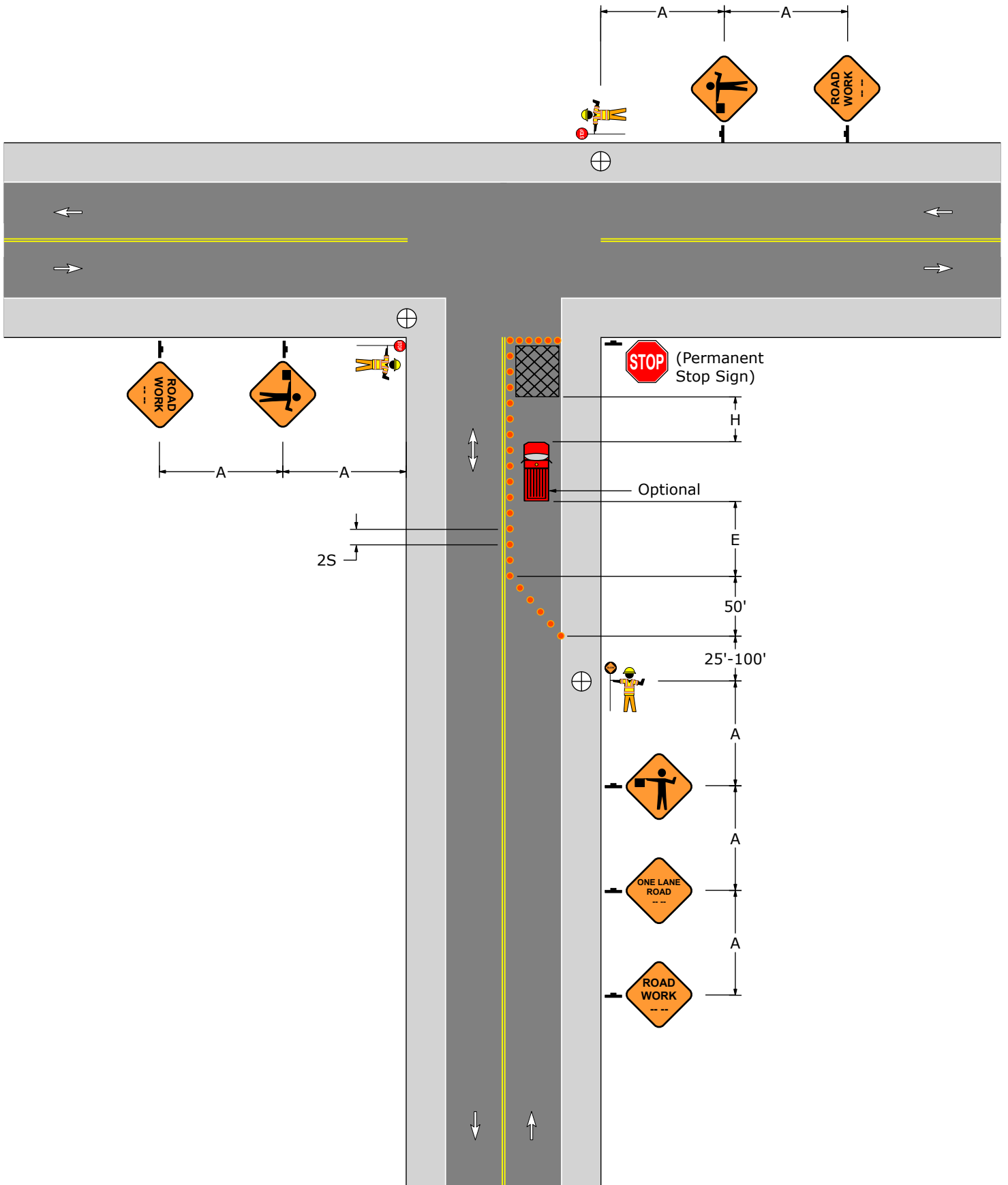
Sign Spacing, Channelizing Device Spacing, Buffer Space, and Roll Ahead Space					
Speed	Channelizing Devices Spacing	Sign Spacing		Buffer Space	Roll Ahead Space
		Urban	Rural		
S (MPH)	2S (Feet)	A (Feet)	A (Feet)	E (Feet)	H (Feet)
25	50	100 - 200	500 - 800	155	150
30	60	100 - 200	500 - 800	200	150
35	70	100 - 200	500 - 800	250	150
40	80	350 - 500	500 - 800	305	150
45	90	350 - 500	500 - 800	360	150
50	100	350 - 500	500 - 800	425	250
55	110	350 - 500	500 - 800	495	250

Taper Lengths and Minimum Number Of Channelizing Devices		
Speed	50' Per Lane Taper	
S (MPH)	Length (Feet)	Minimum Number Of Devices
25	50	6
30	50	6
35	50	6
40	50	6
45	50	6
50	50	6
55	50	6

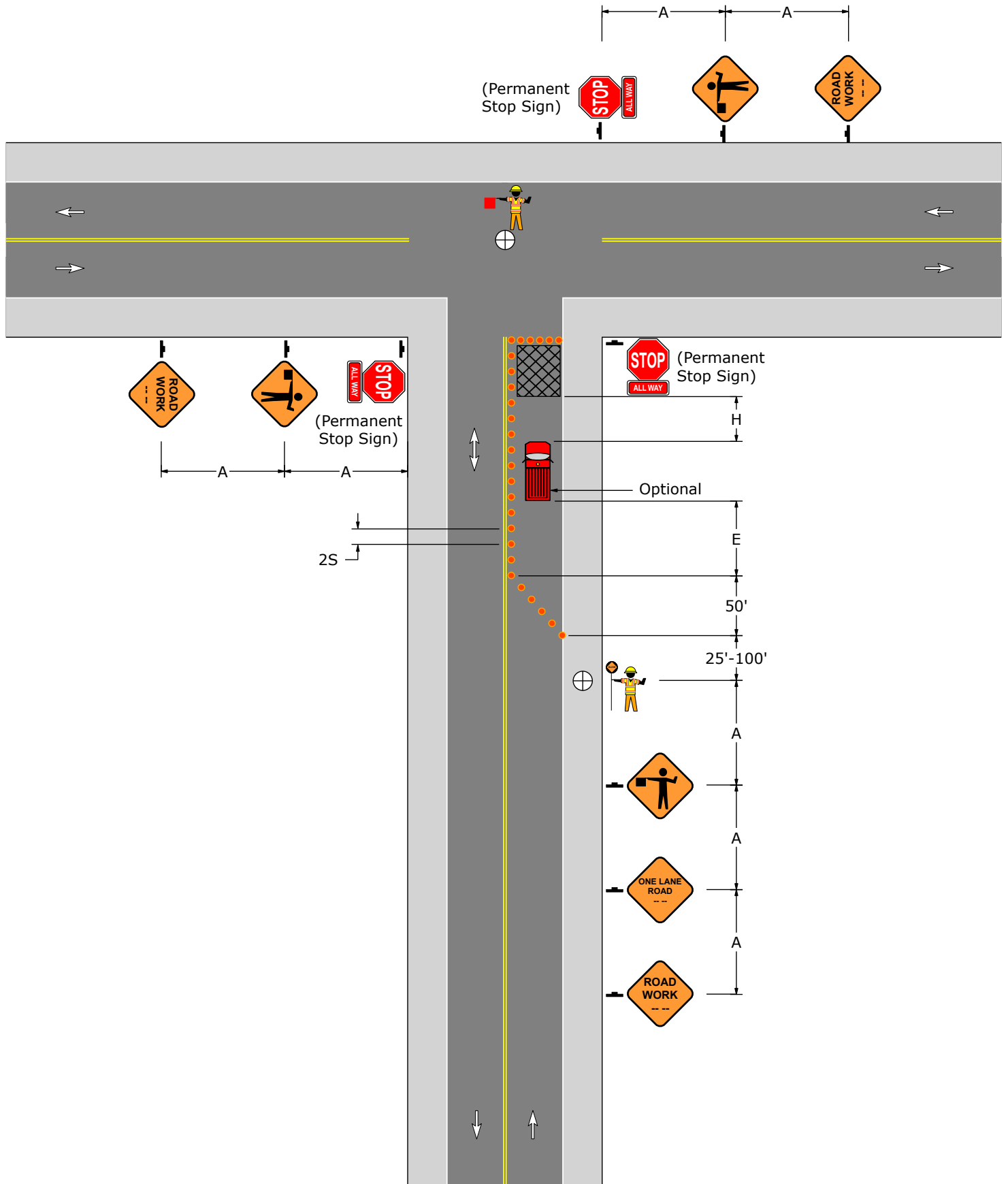
PATA 109-A



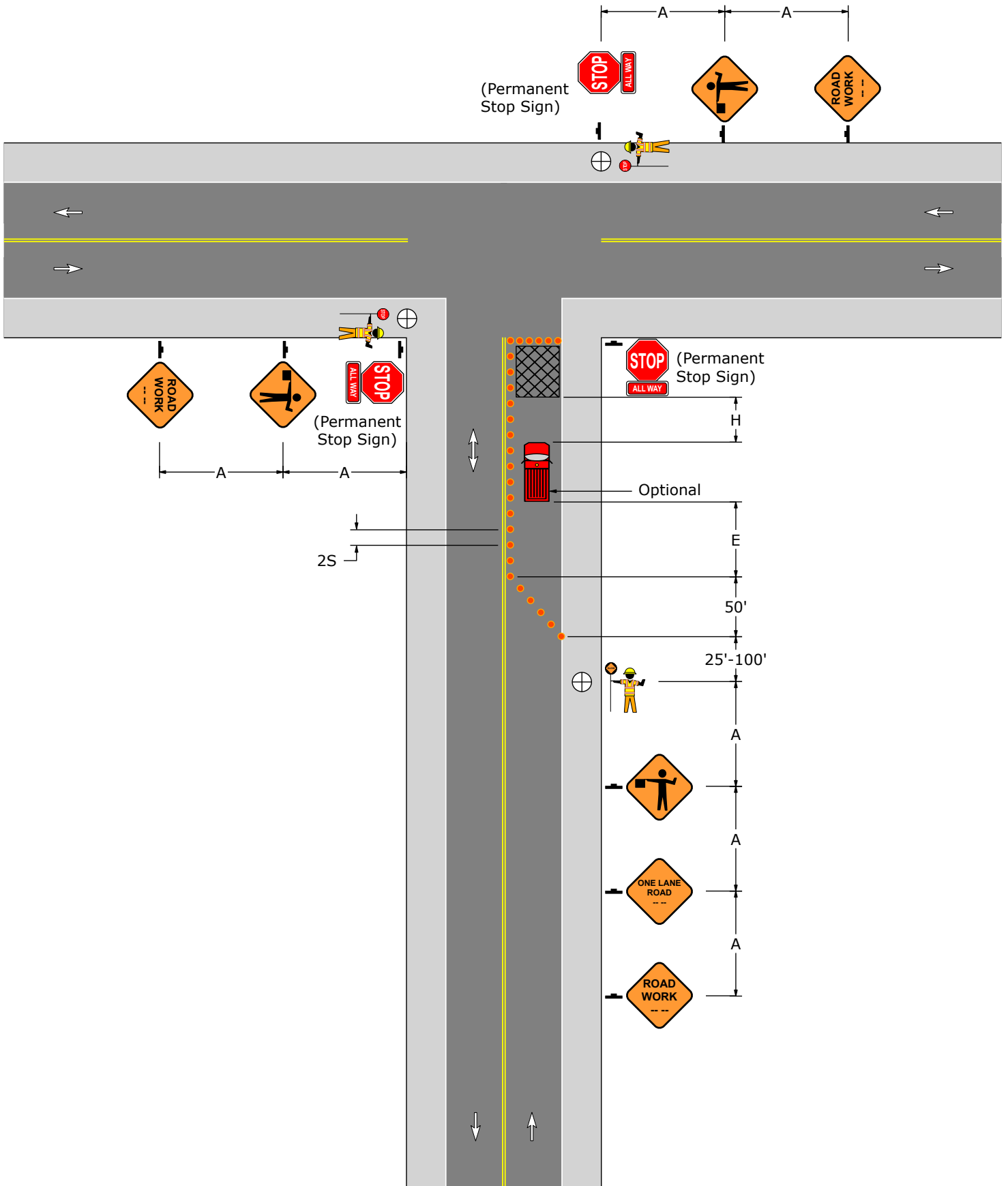
PATA 109-B



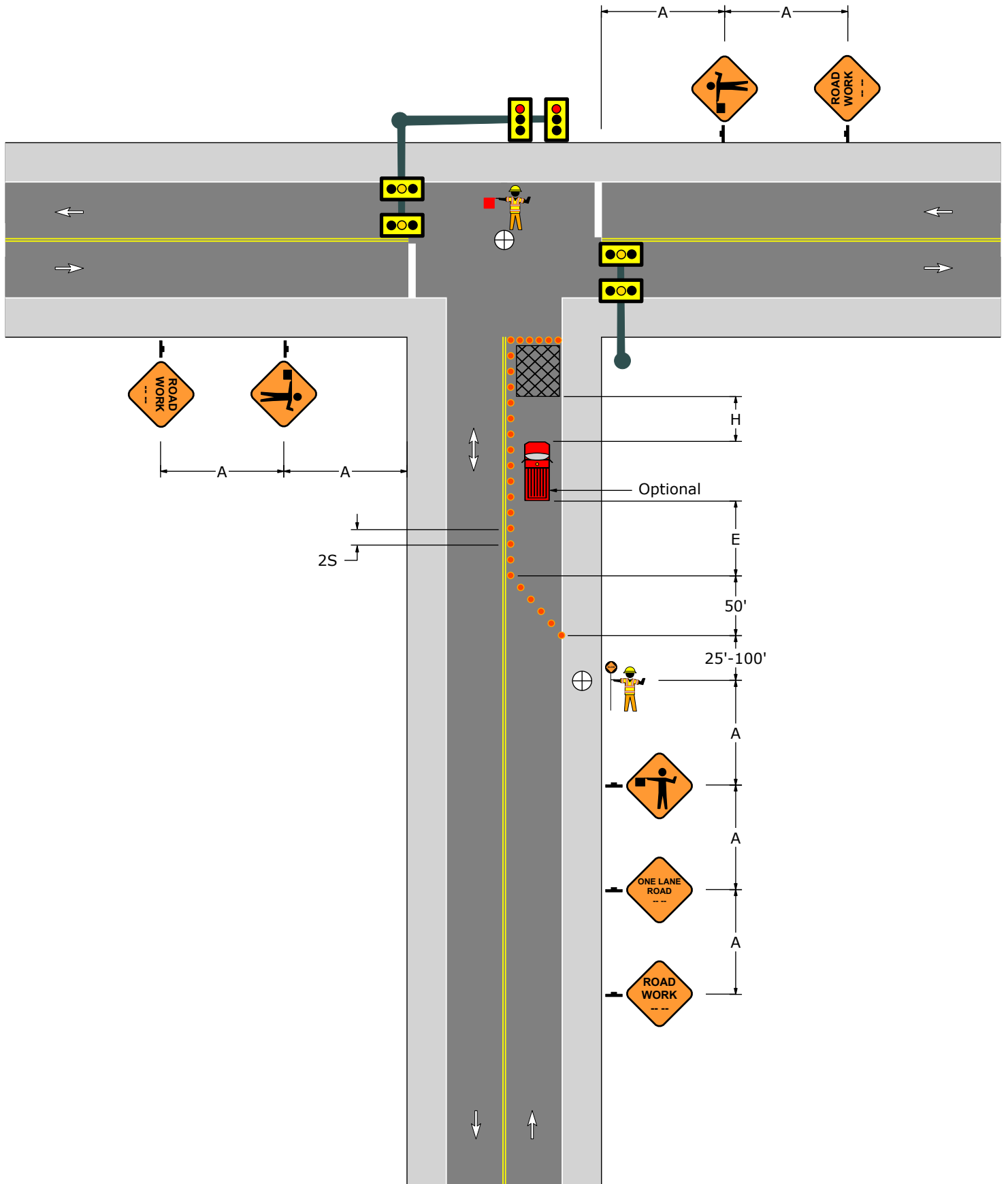
PATA 109-C



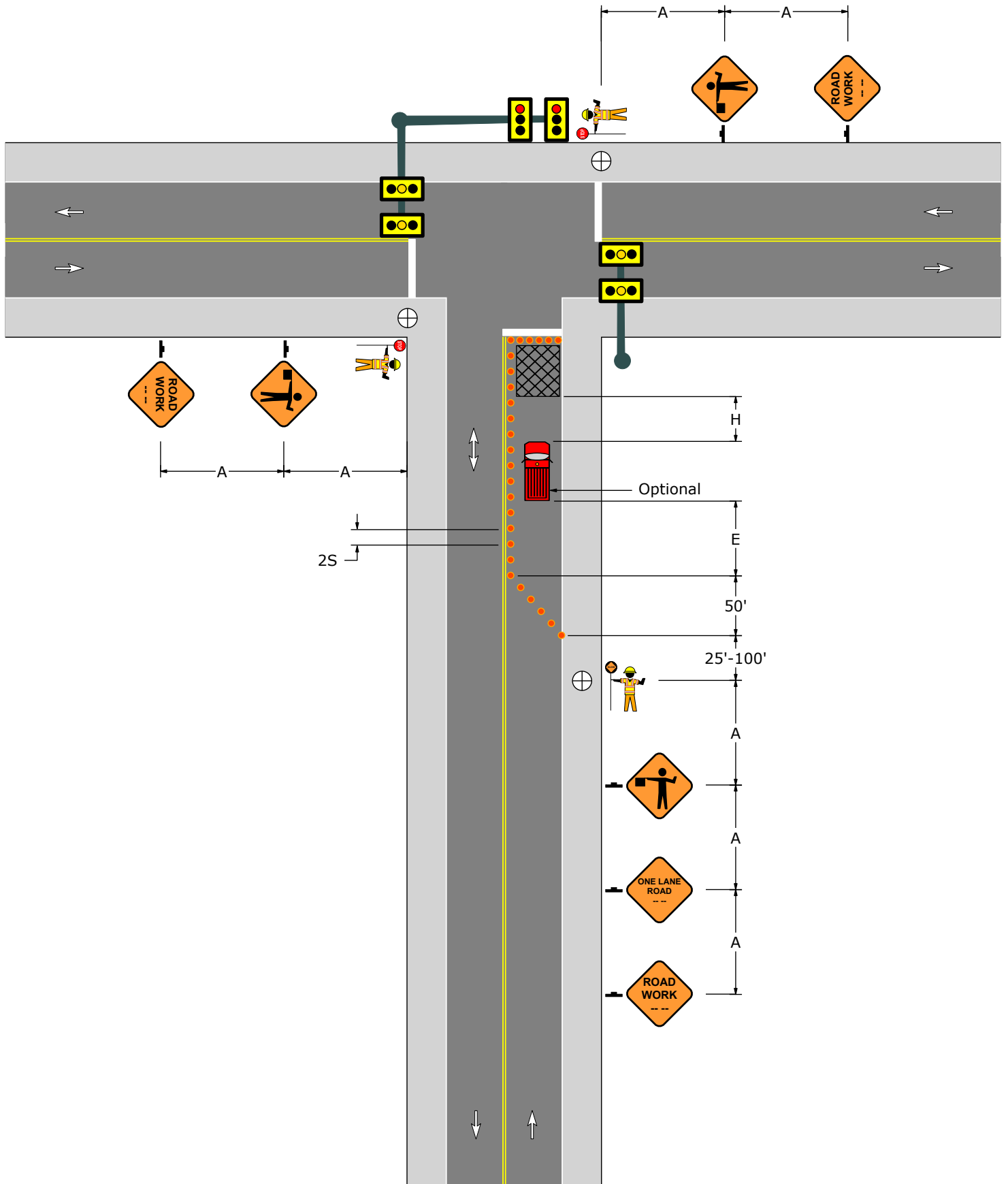
PATA 109-D



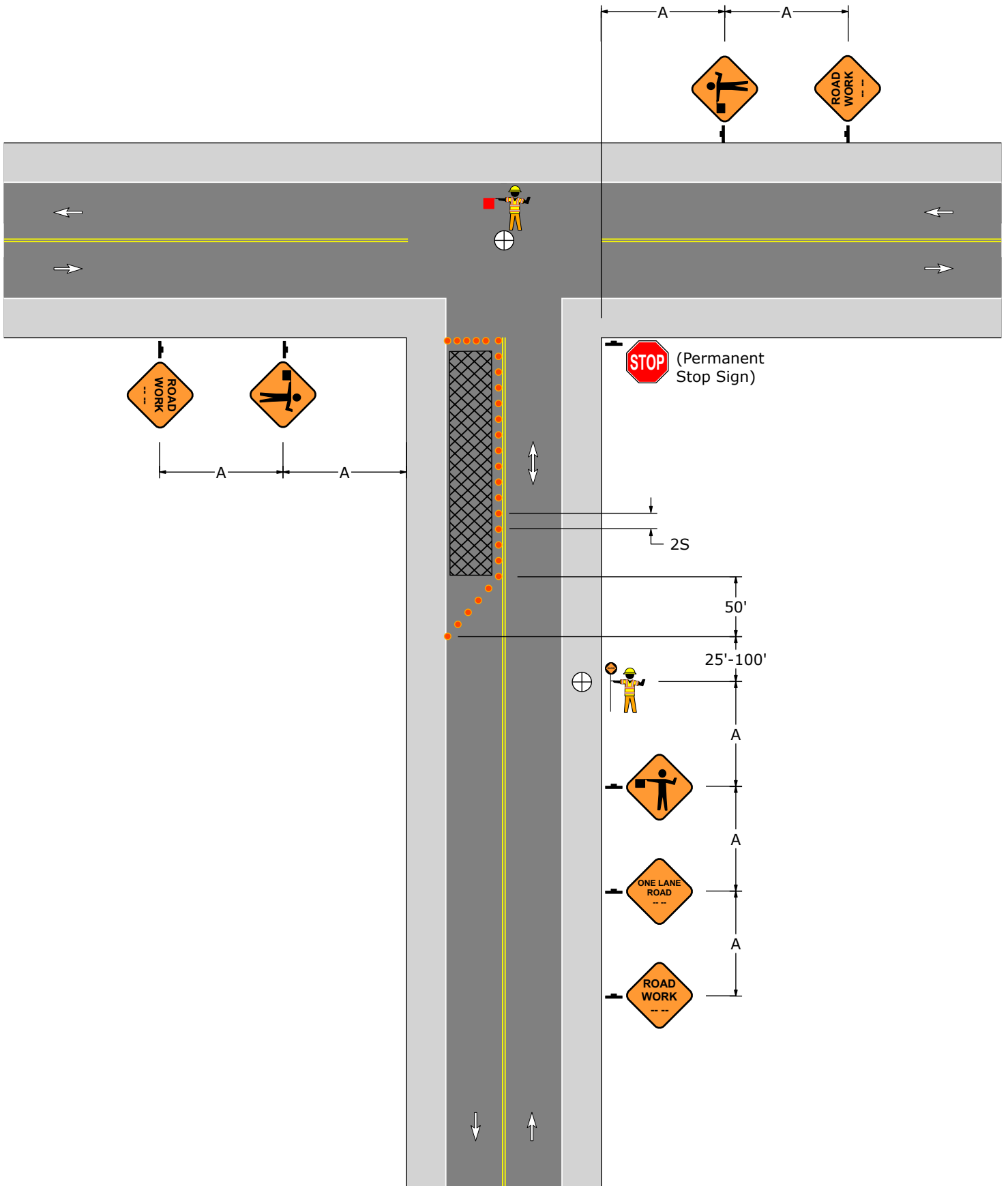
PATA 109-E



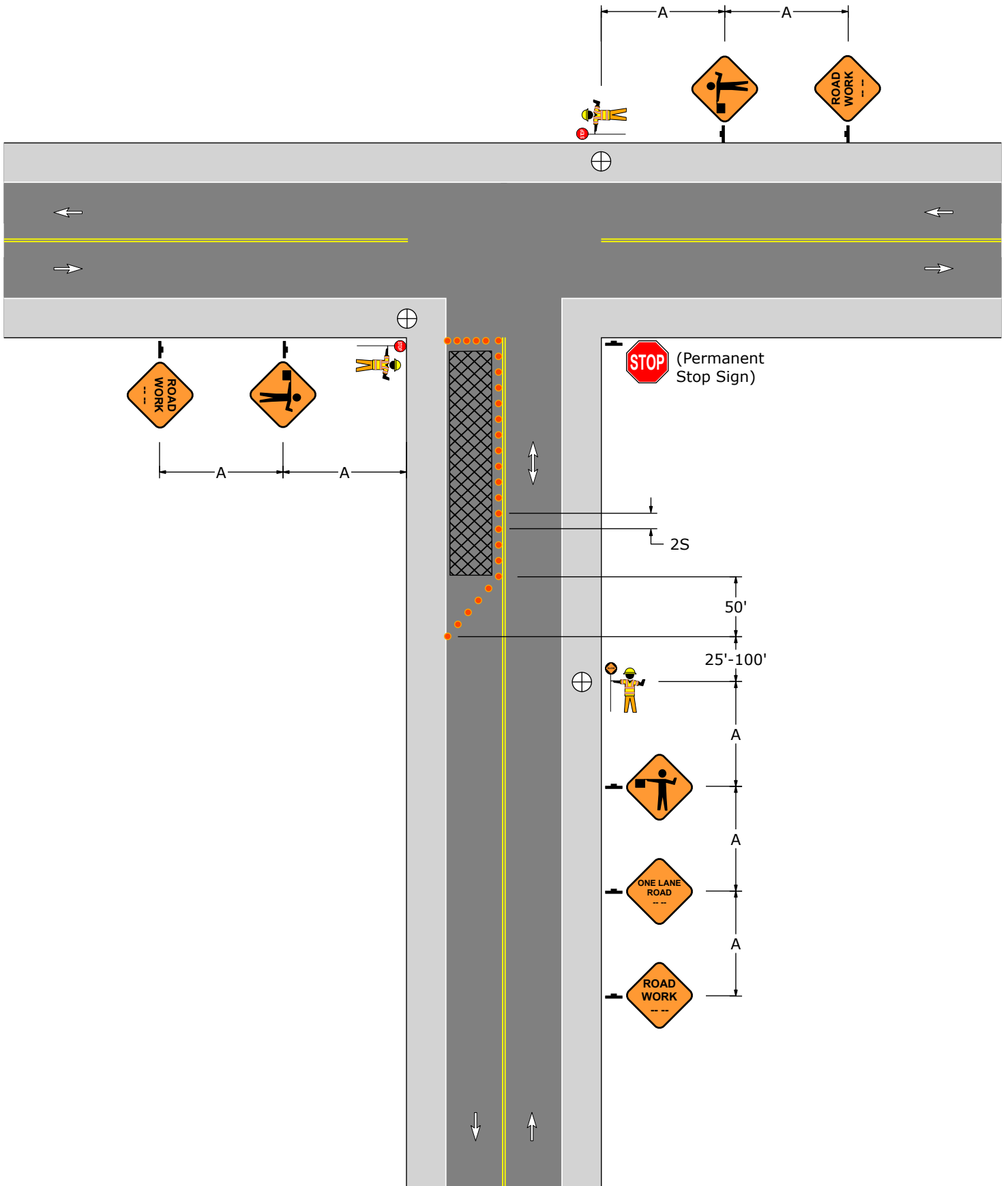
PATA 109-F



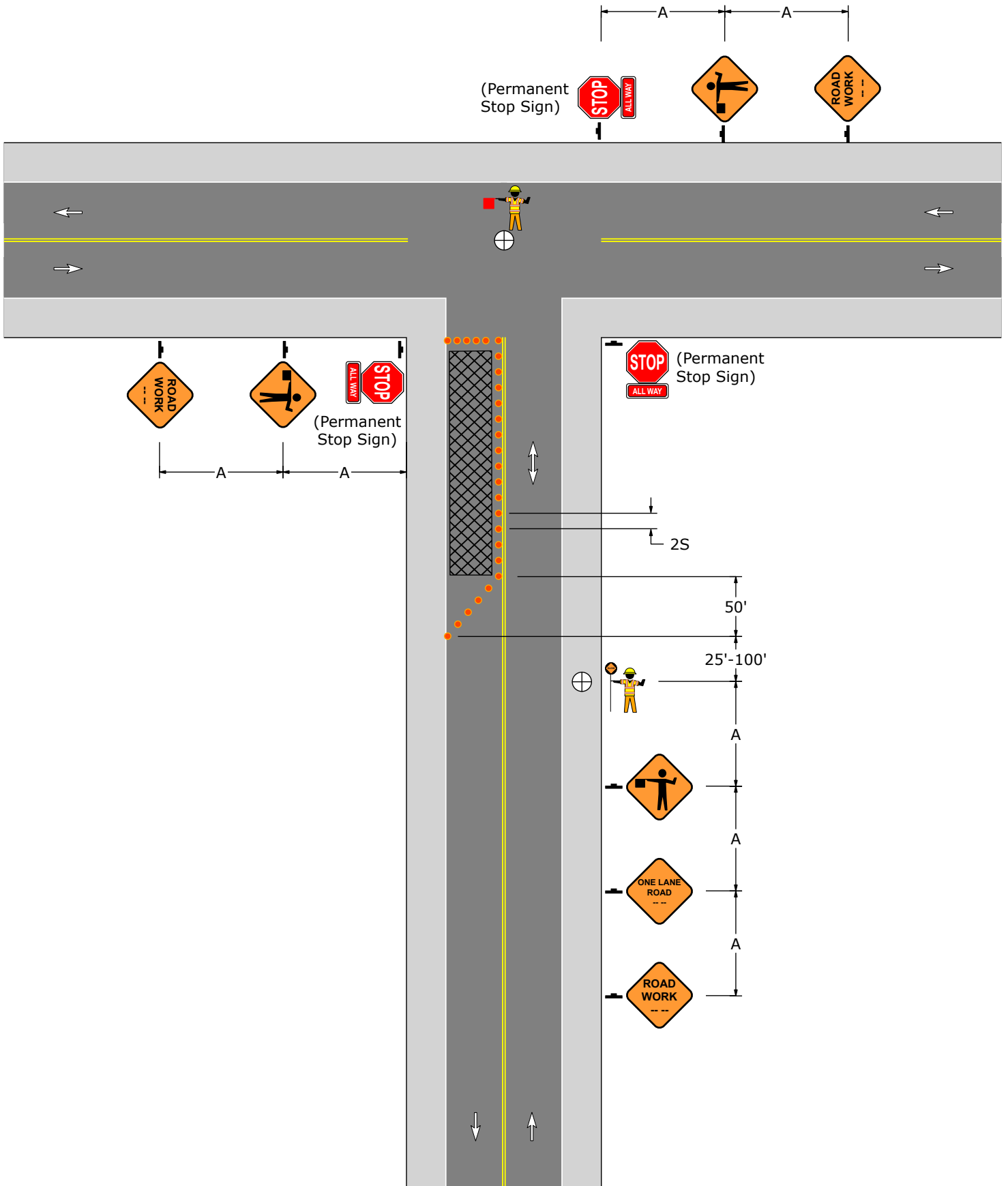
PATA 109-G



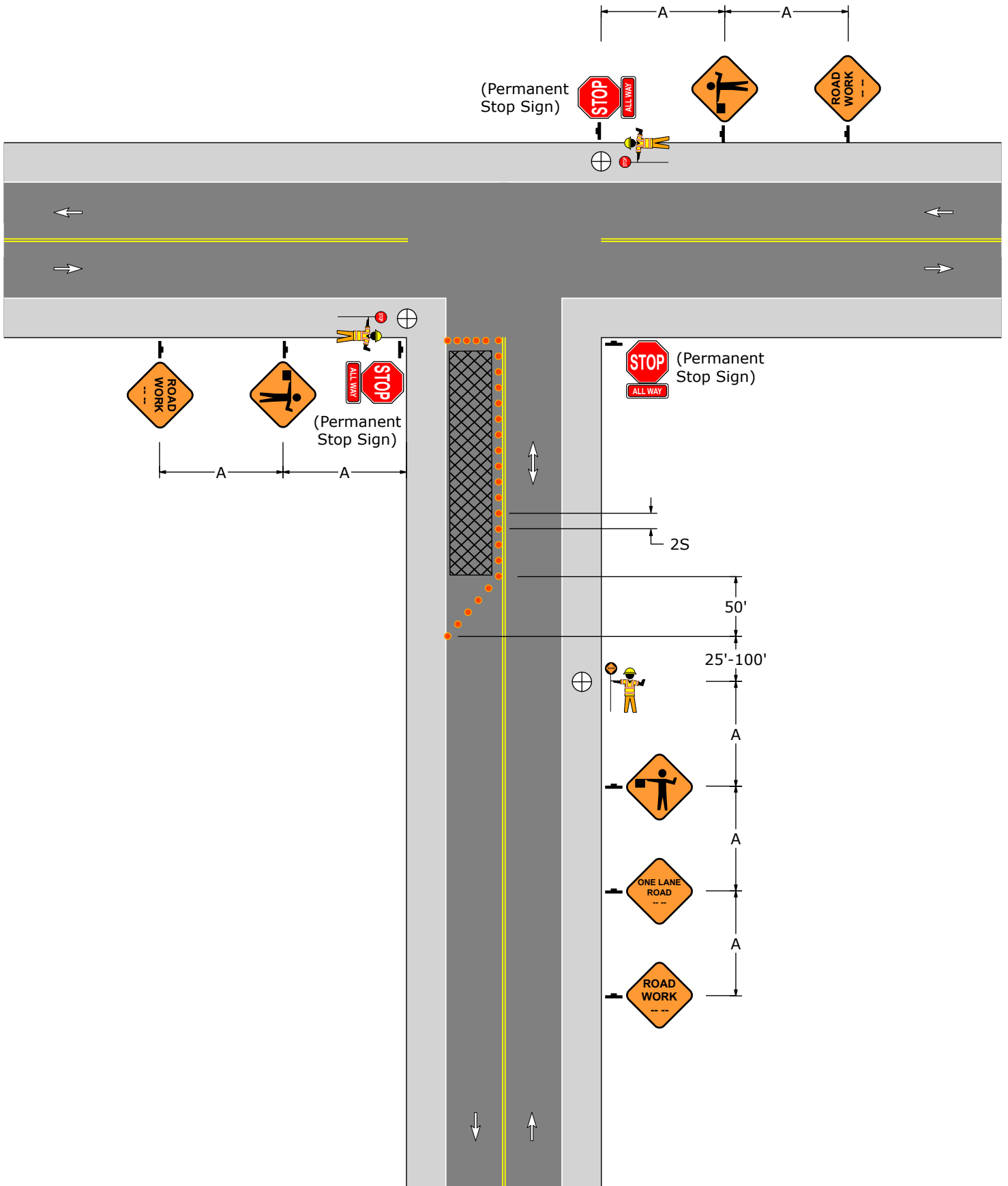
PATA 109-H



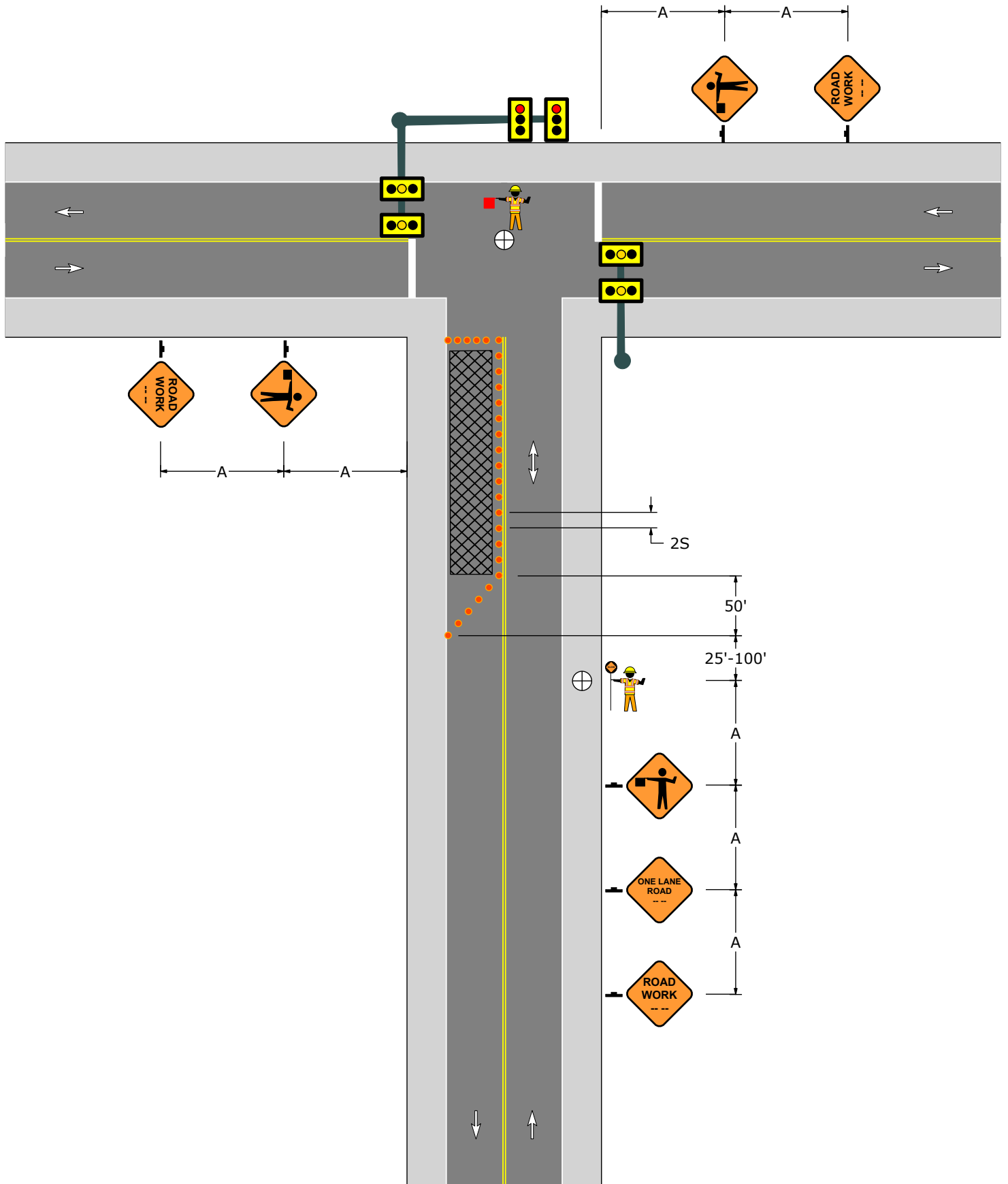
PATA 109-I



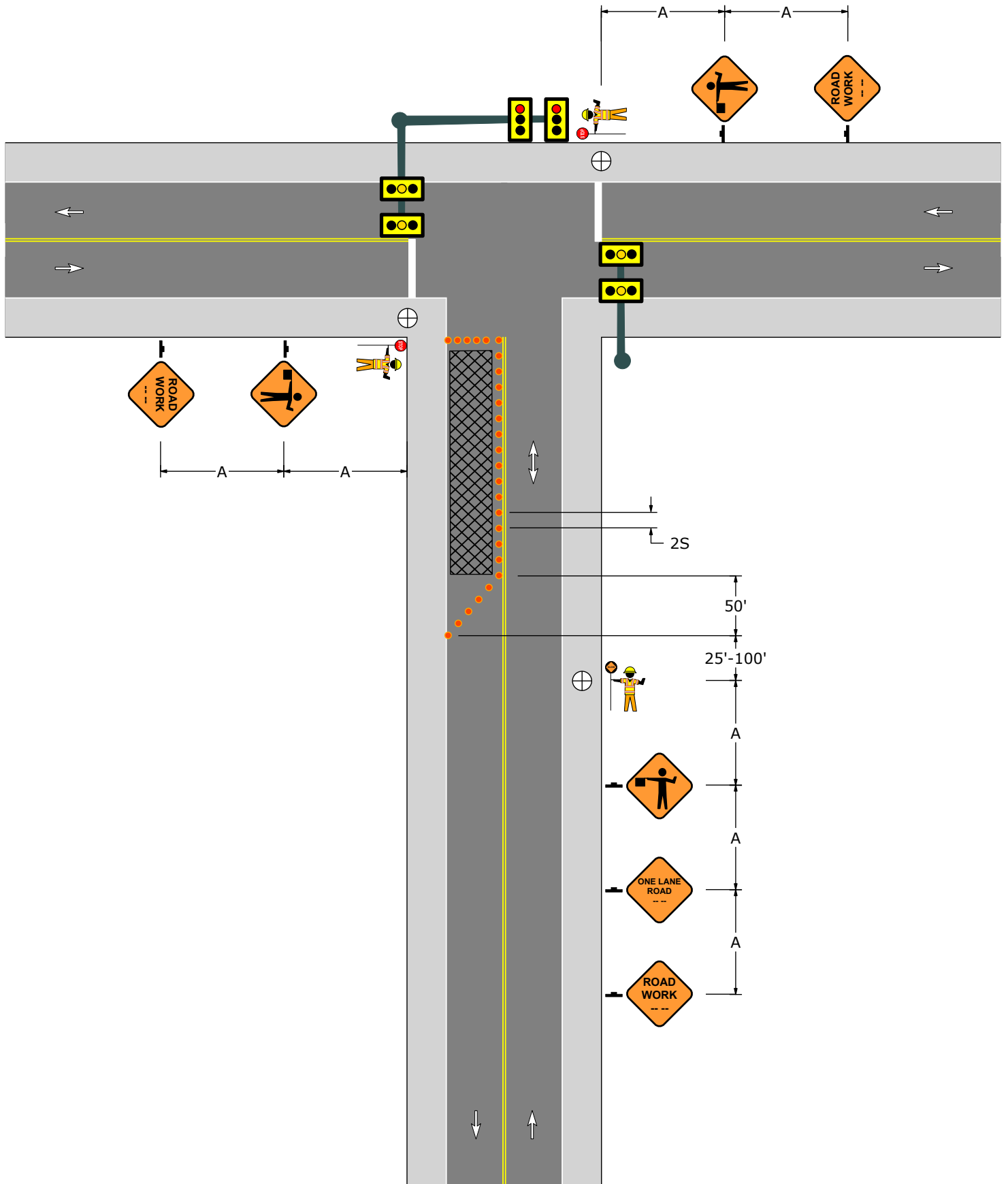
PATA 109-J



PATA 109-K



PATA 109-L



PATA 110 (A Through T)

1. PATA 110 drawings show work spaces on roads that approach and depart 4-Way intersections. Single-flagger or multi-flagger intersection control is illustrated for intersections with three types of permanent control:




- a) One-Way Stop
- b) All-Way Stop
- c) Traffic Signal

2. Flaggers shall be clearly visible to traffic for a minimum distance of E.

3. For operations of 15 minutes or less:

- a) The ROAD WORK, ONE LANE ROAD, and FLAGGER SYMBOL signs are not required.
- b) All channelizing devices may be eliminated if a shadow vehicle is present and the operation does not proceed against normal traffic flow.

4. When a shadow vehicle is not used, distance E is measured from the end of the taper to the beginning of the work space.

Signs		
		
W20-1	W20-4	W20-7

Sign Spacing, Channelizing Device Spacing, Buffer Space, and Roll Ahead Space					
Speed	Channelizing Devices Spacing	Sign Spacing		Buffer Space	Roll Ahead Space
		Urban	Rural		
S (MPH)	2S (Feet)	A (Feet)	A (Feet)	E (Feet)	H (Feet)
25	50	100 - 200	500 - 800	155	150
30	60	100 - 200	500 - 800	200	150
35	70	100 - 200	500 - 800	250	150
40	80	350 - 500	500 - 800	305	150
45	90	350 - 500	500 - 800	360	150
50	100	350 - 500	500 - 800	425	250
55	110	350 - 500	500 - 800	495	250

Taper Lengths and Minimum Number Of Channelizing Devices		
Speed	50' Per Lane Taper	
S (MPH)	Length (Feet)	Minimum Number Of Devices
25	50	6
30	50	6
35	50	6
40	50	6
45	50	6
50	50	6
55	50	6

PATA 110 (A Through T)

Intersection Flagging Options

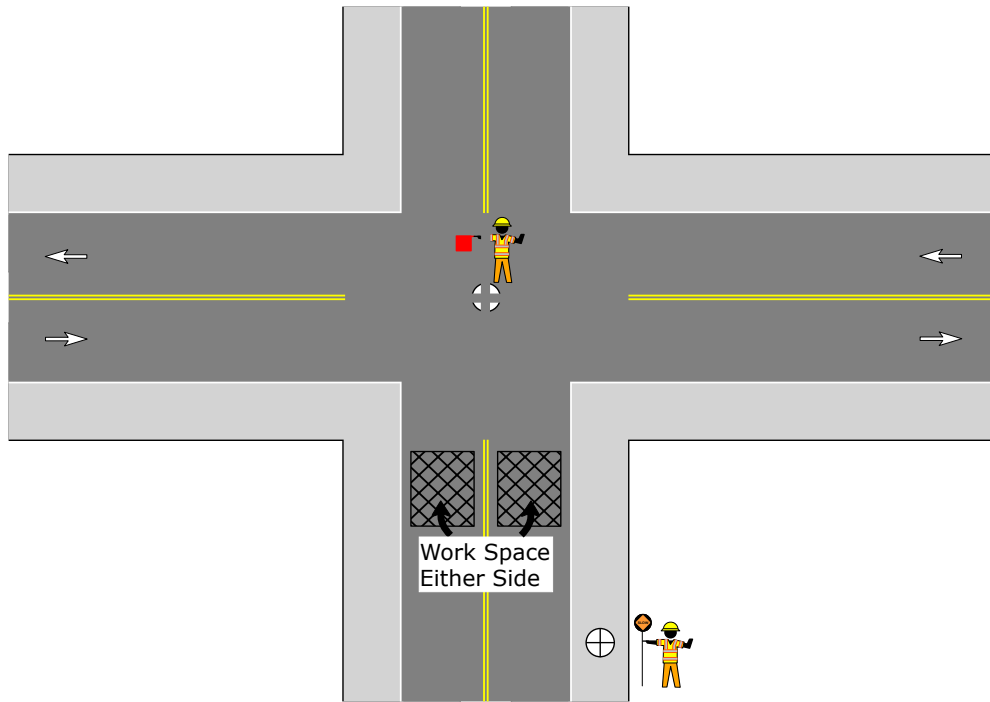


Figure 110-1
One Flagger Within Intersection

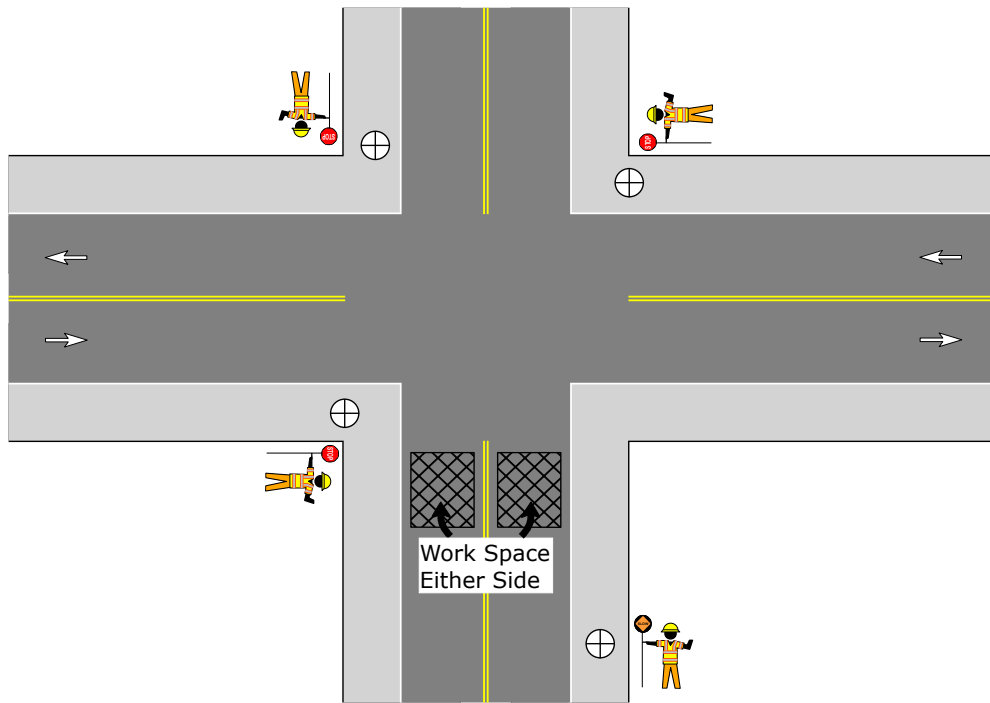
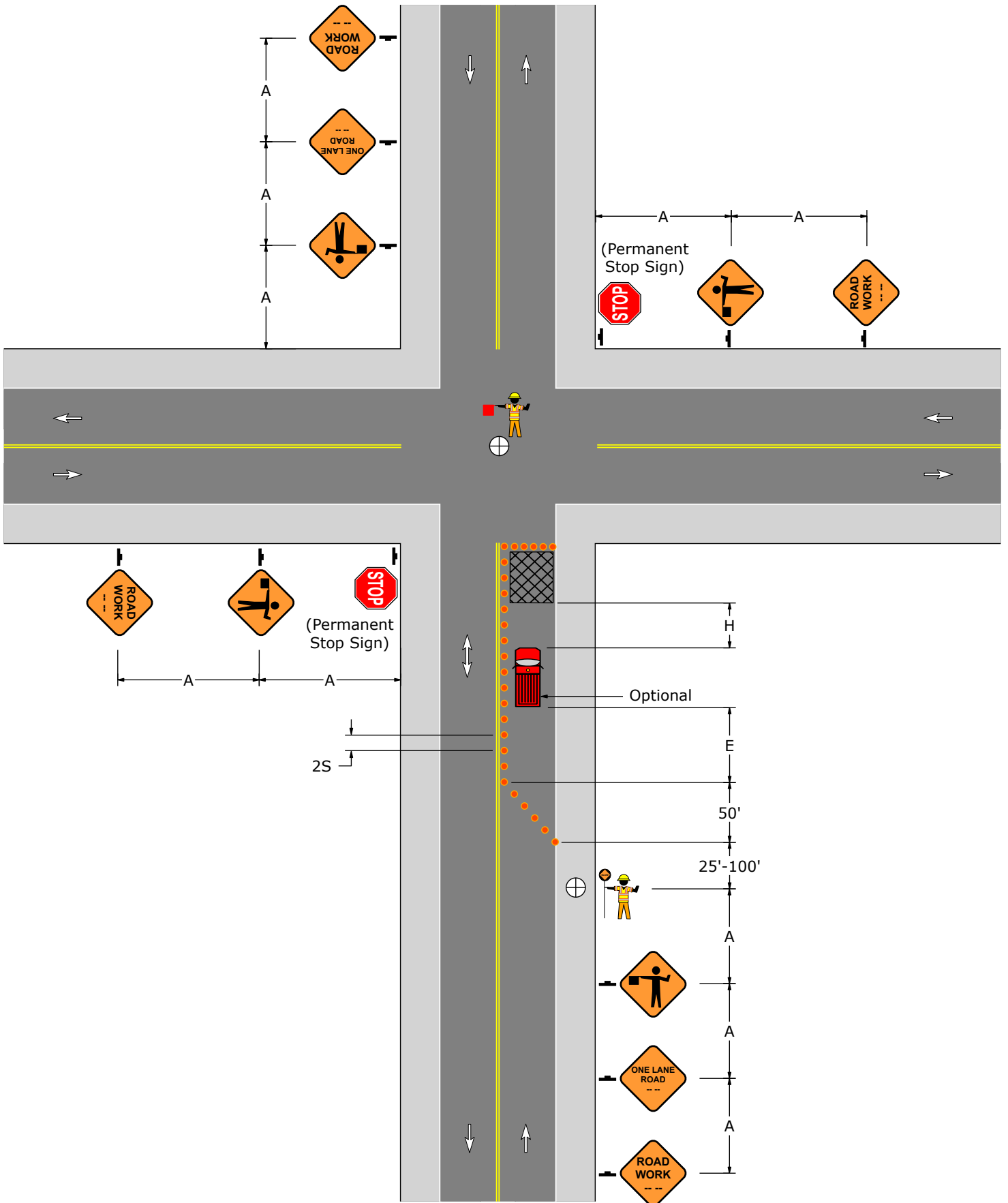
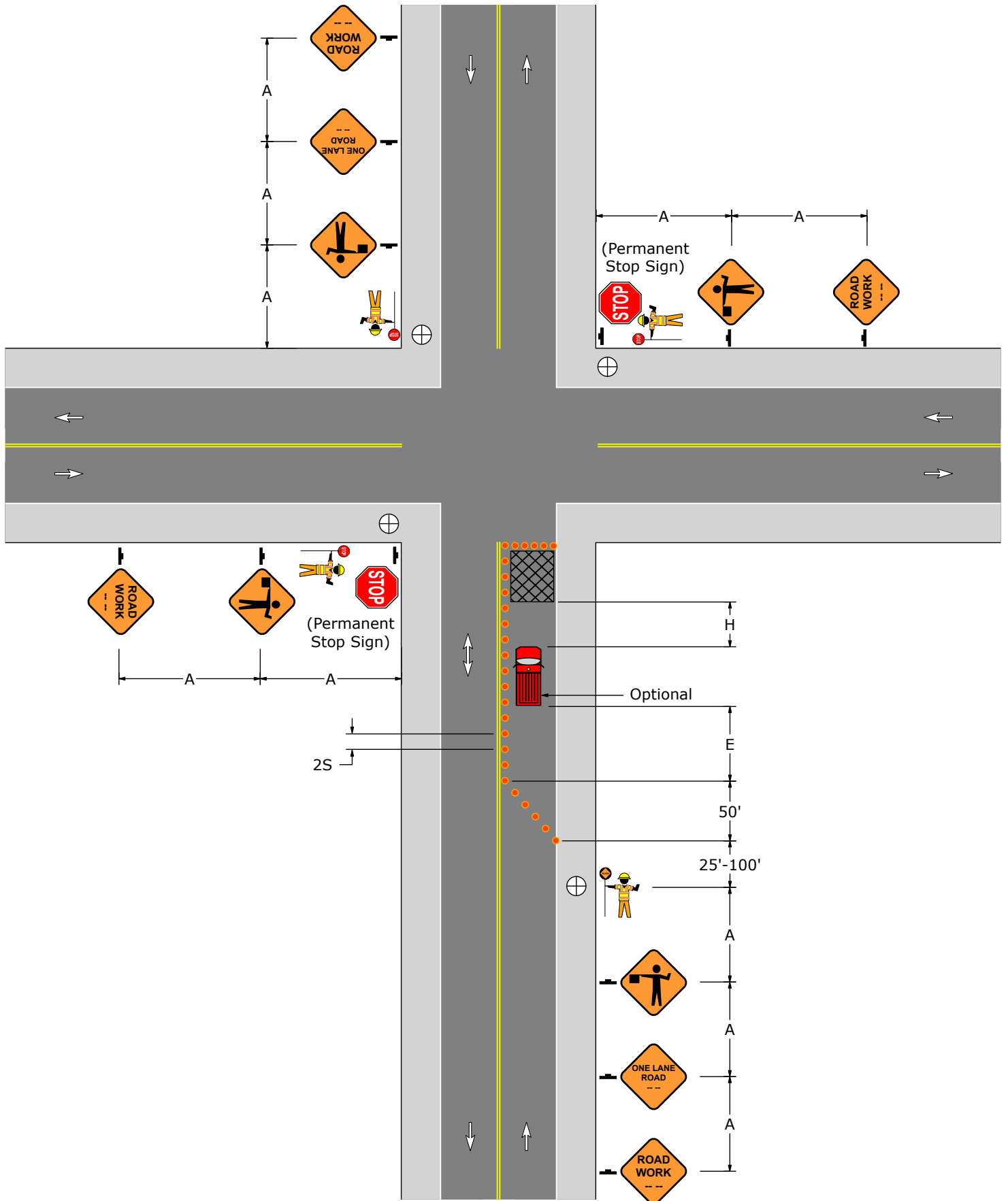


Figure 110-2
Three Flaggers at Intersection

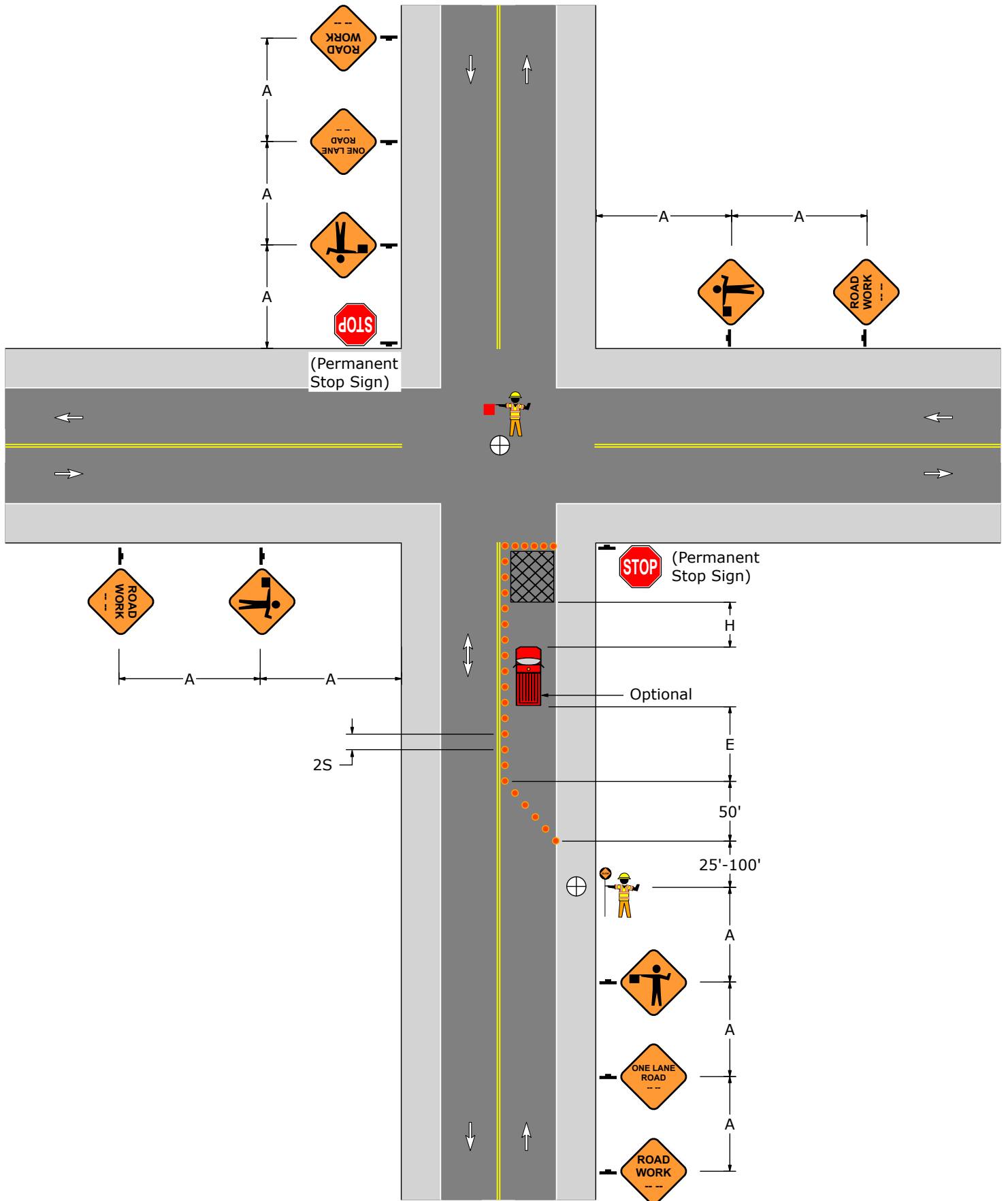
PATA 110-A



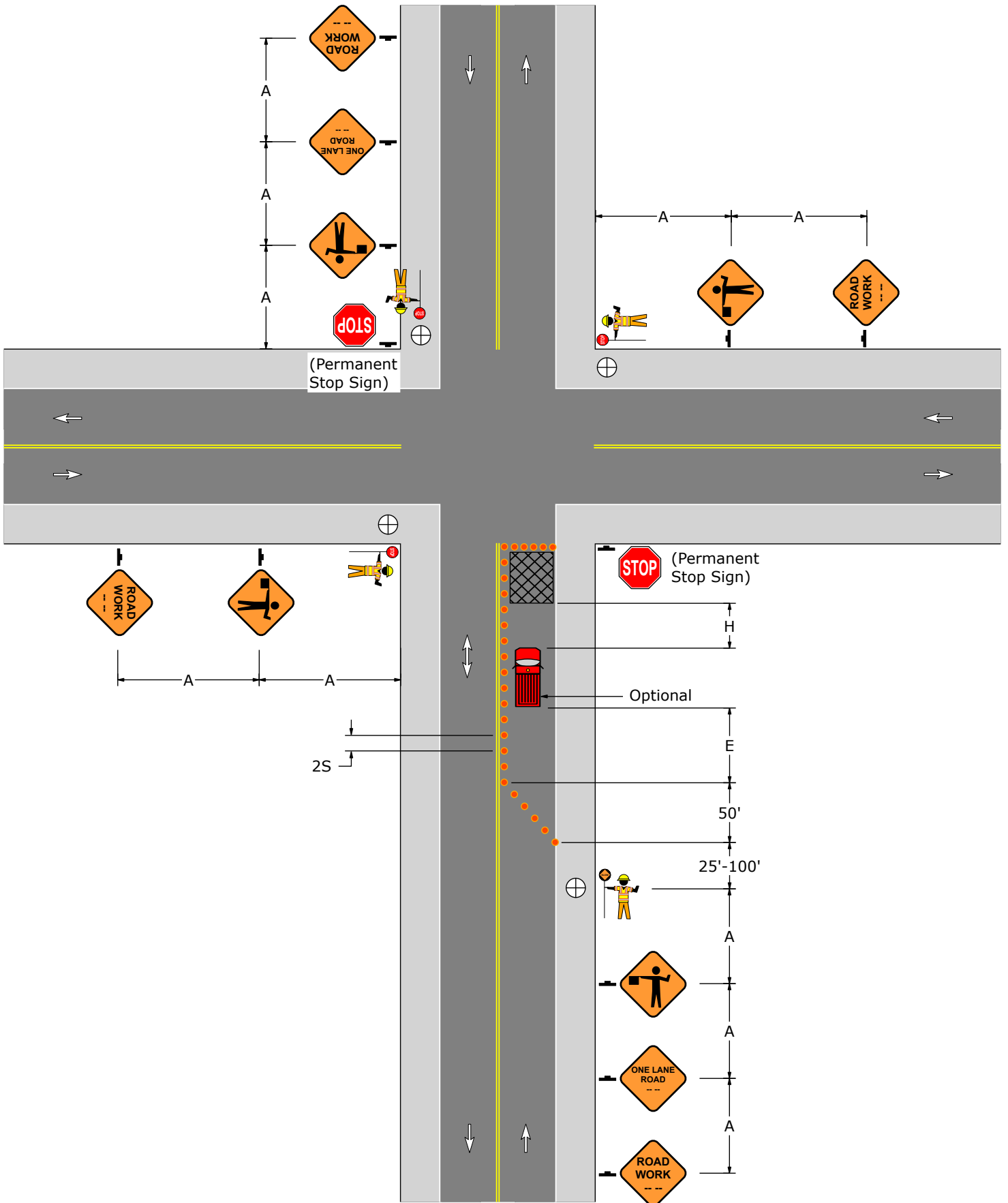
PATA 110-B



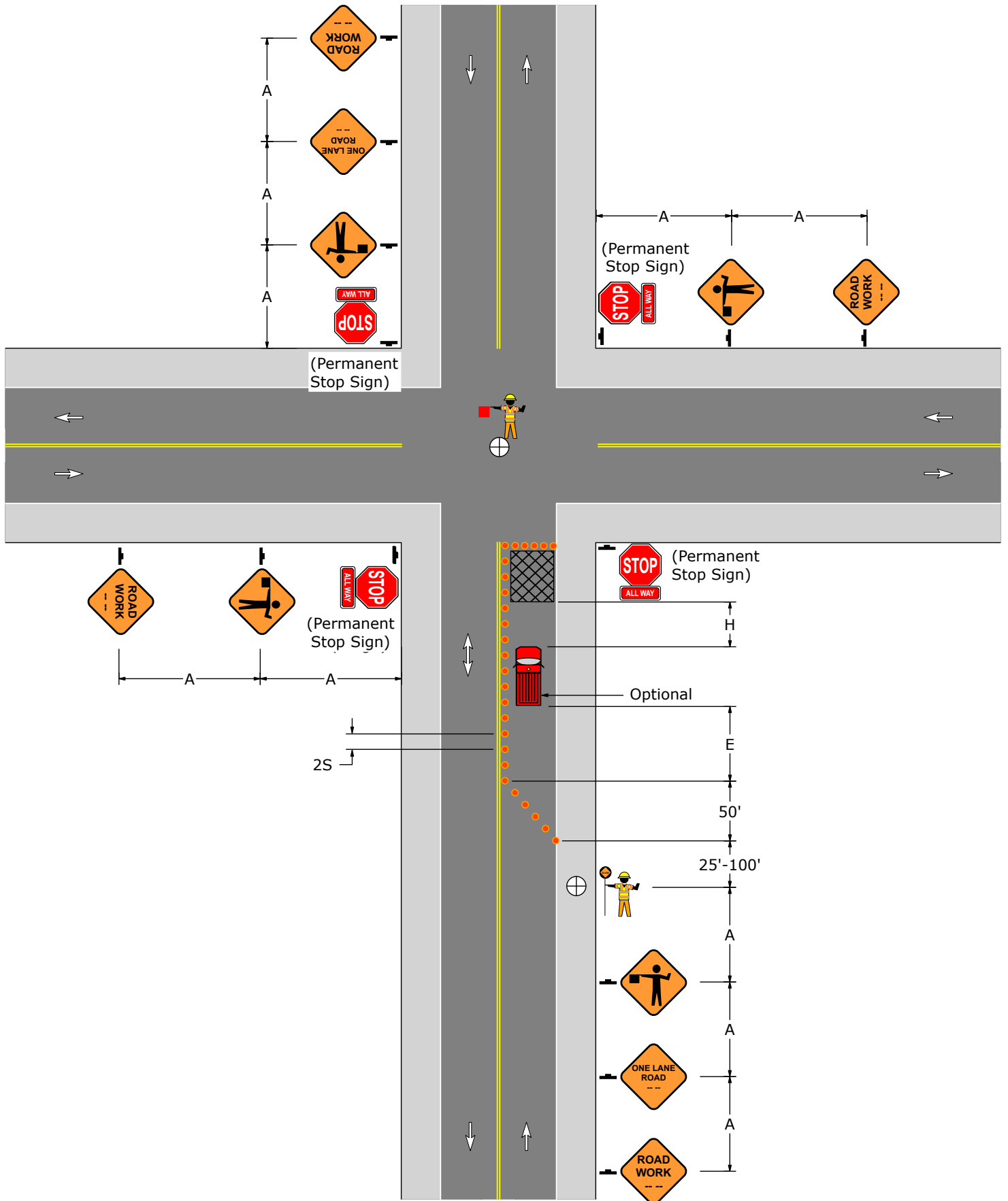
PATA 110-C



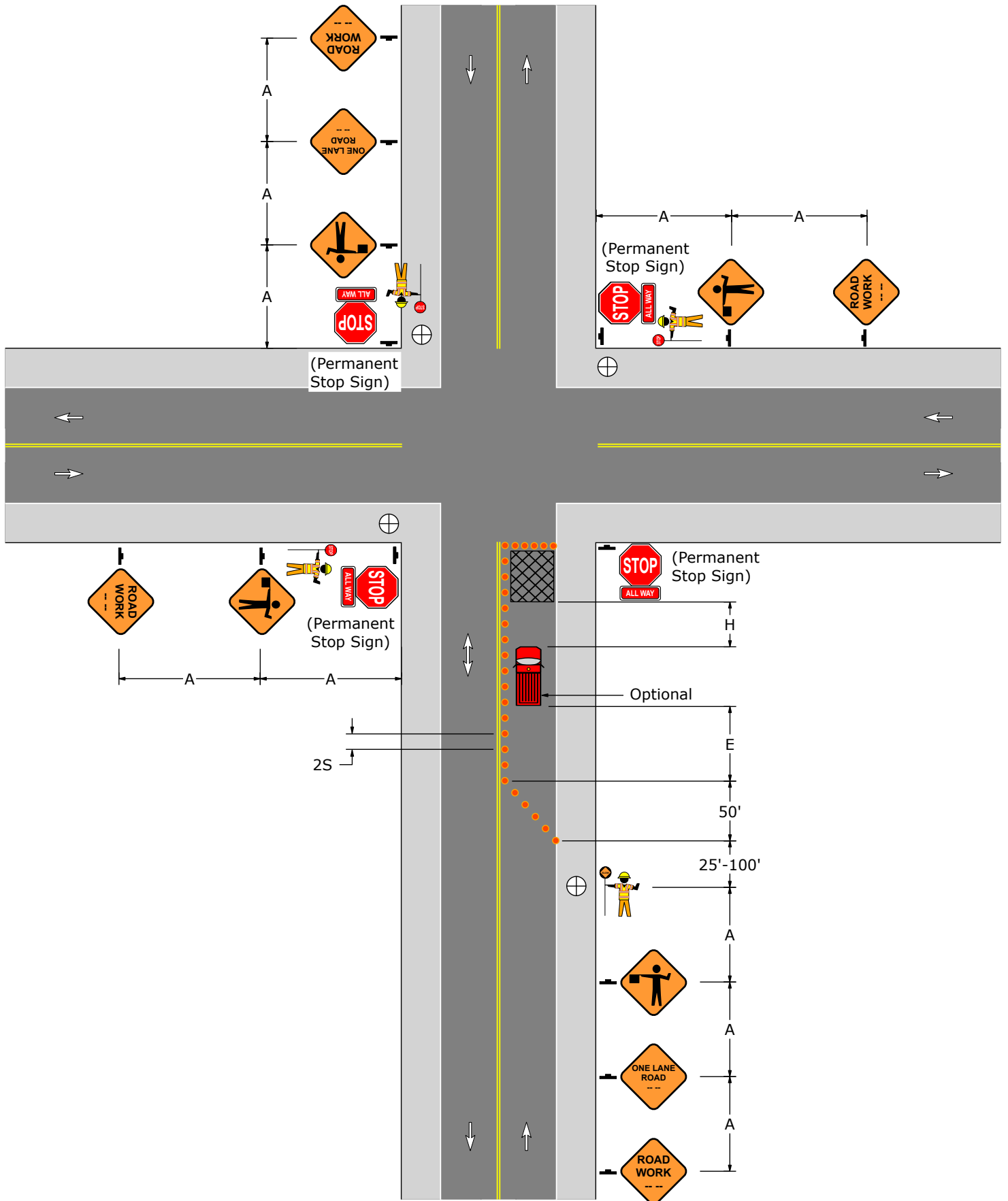
PATA 110-D



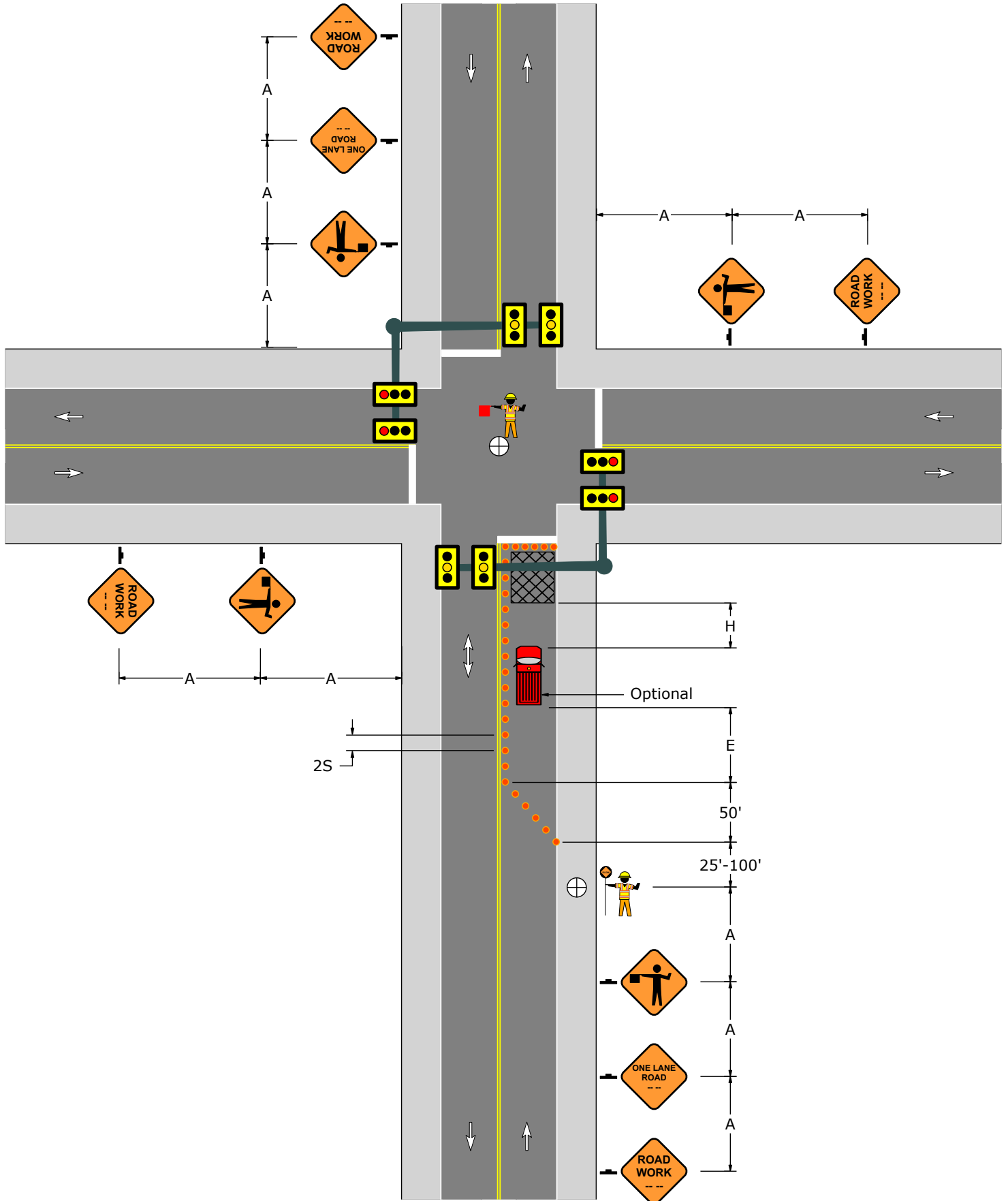
PATA 110-E



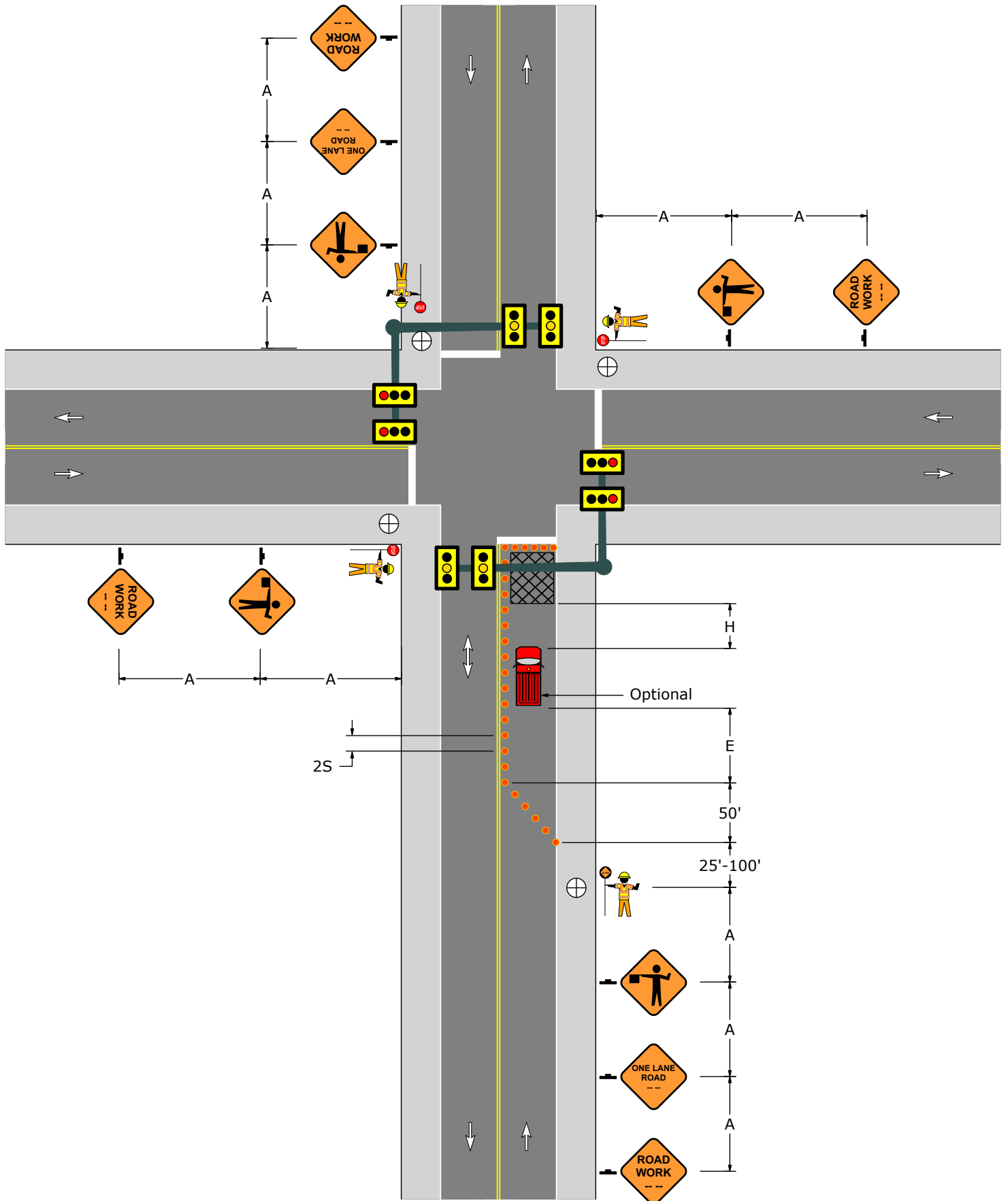
PATA 110-F



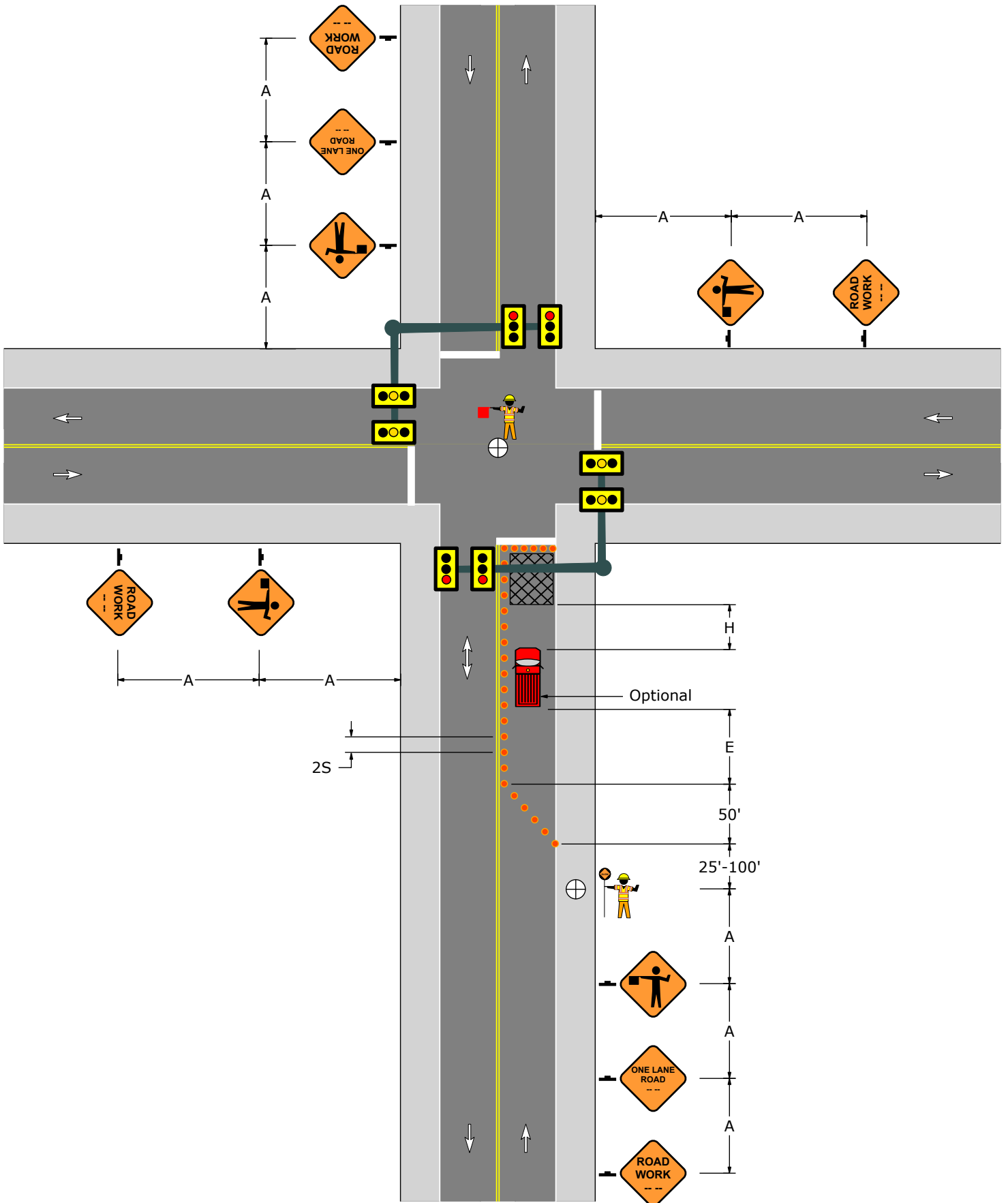
PATA 110-G



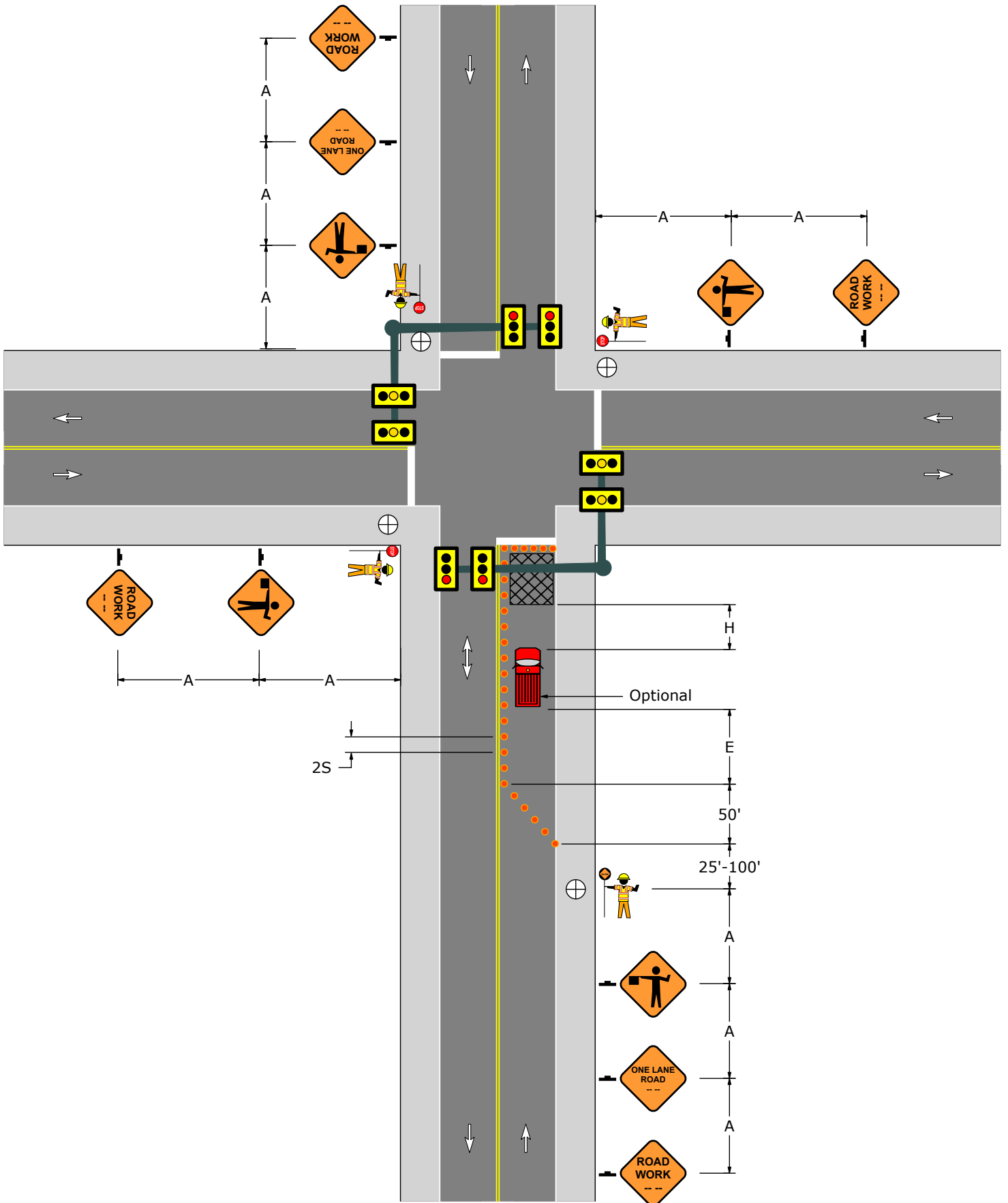
PATA 110-H



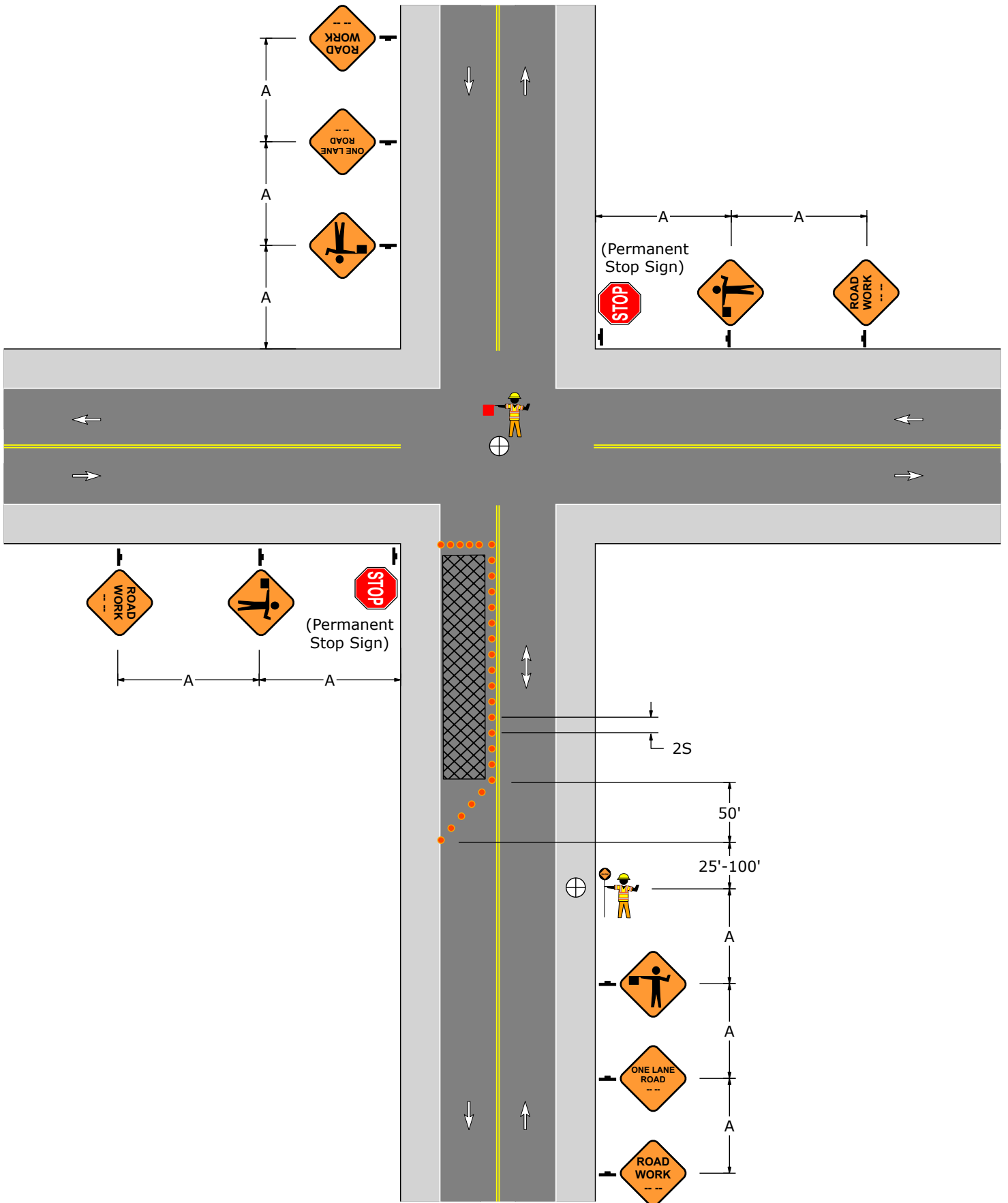
PATA 110-I



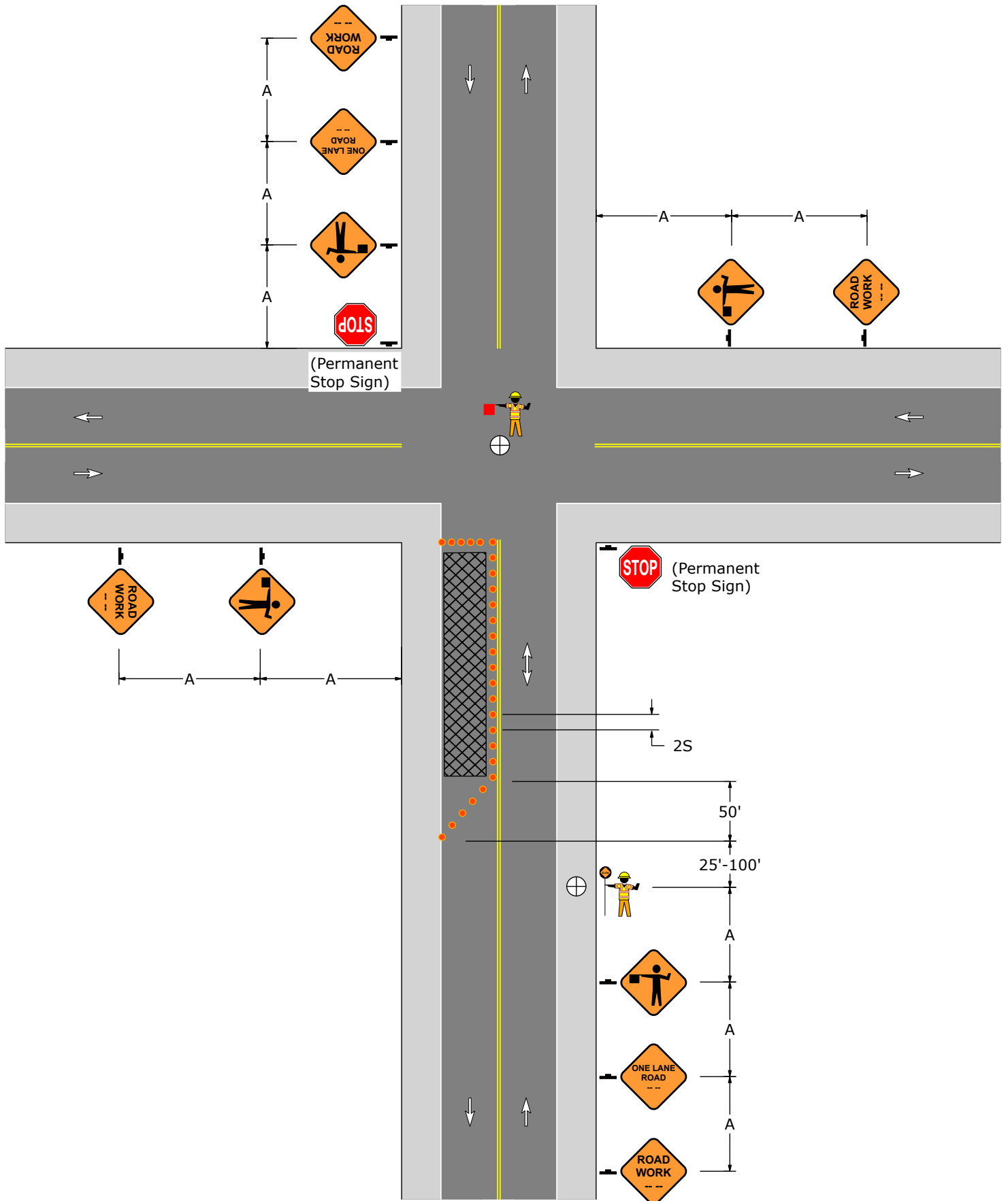
PATA 110-J



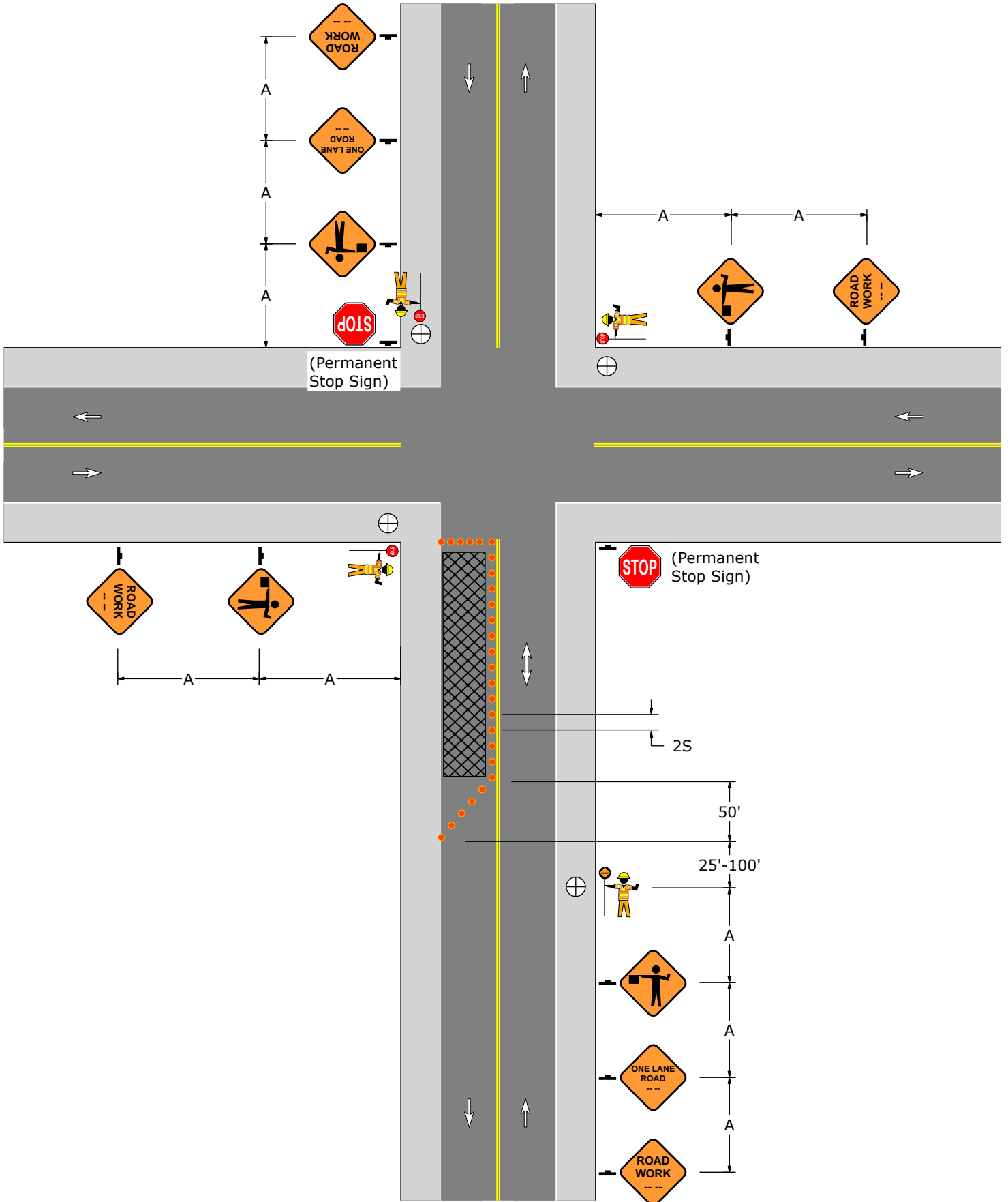
PATA 110-K



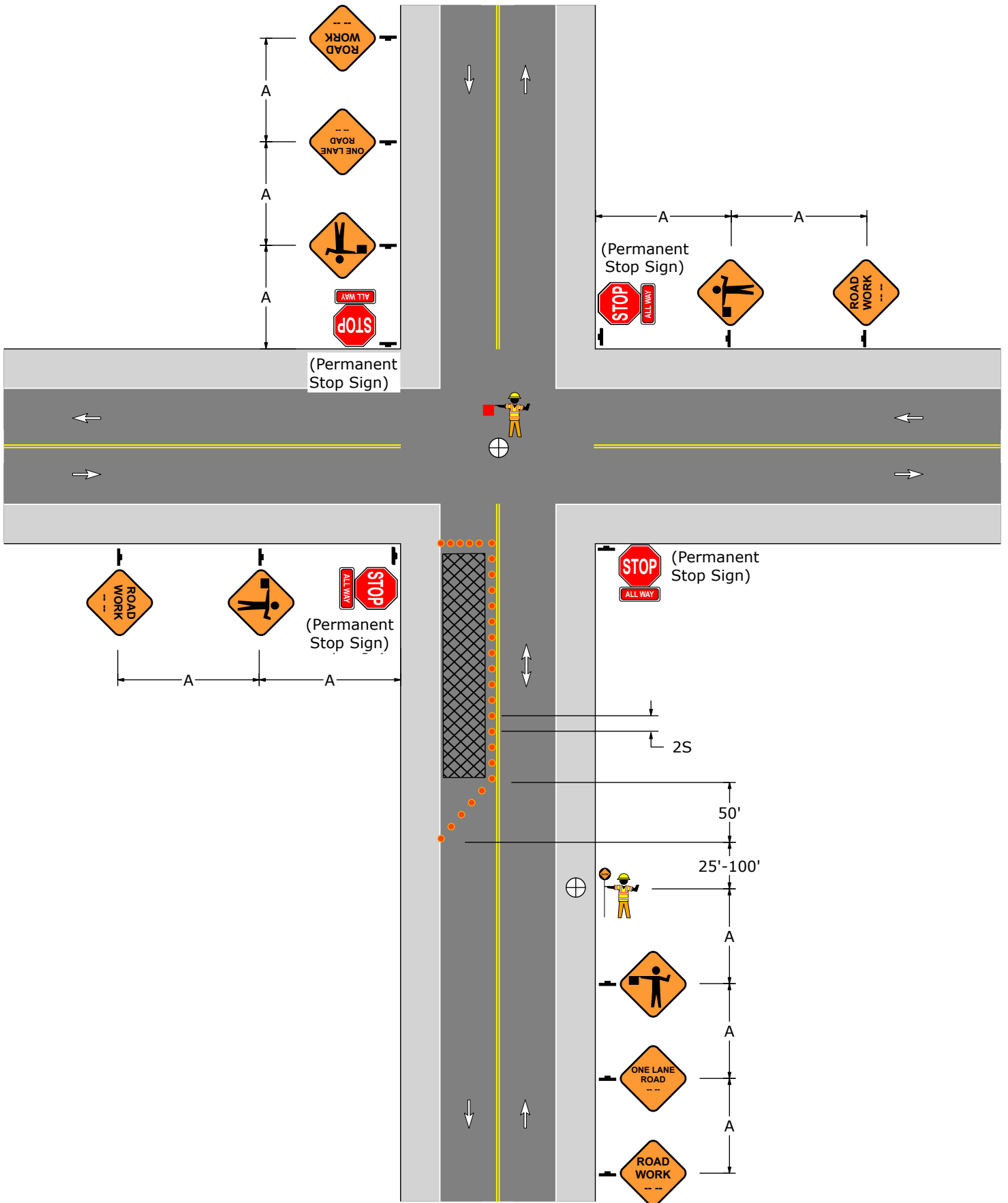
PATA 110-M



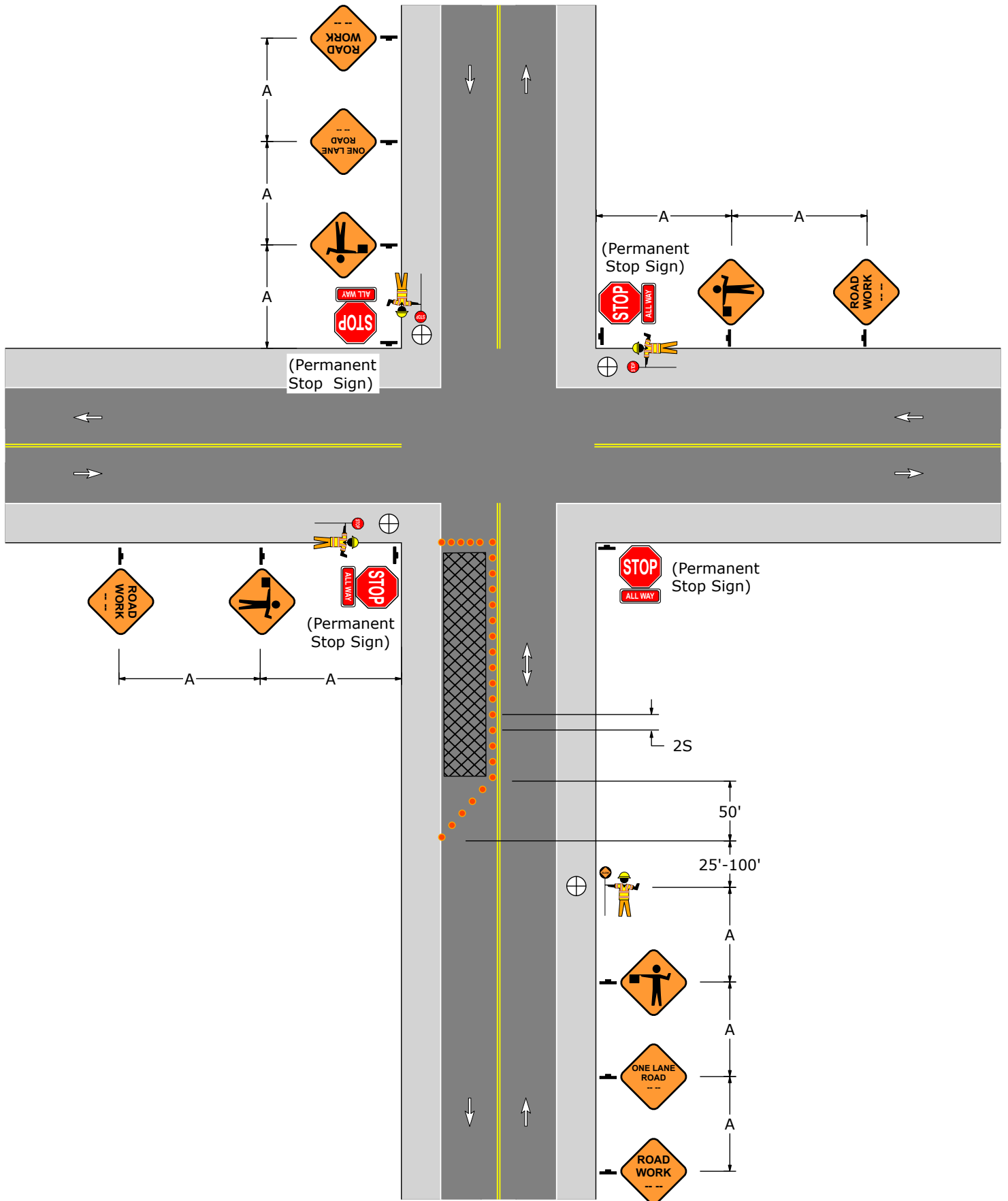
PATA 110-N



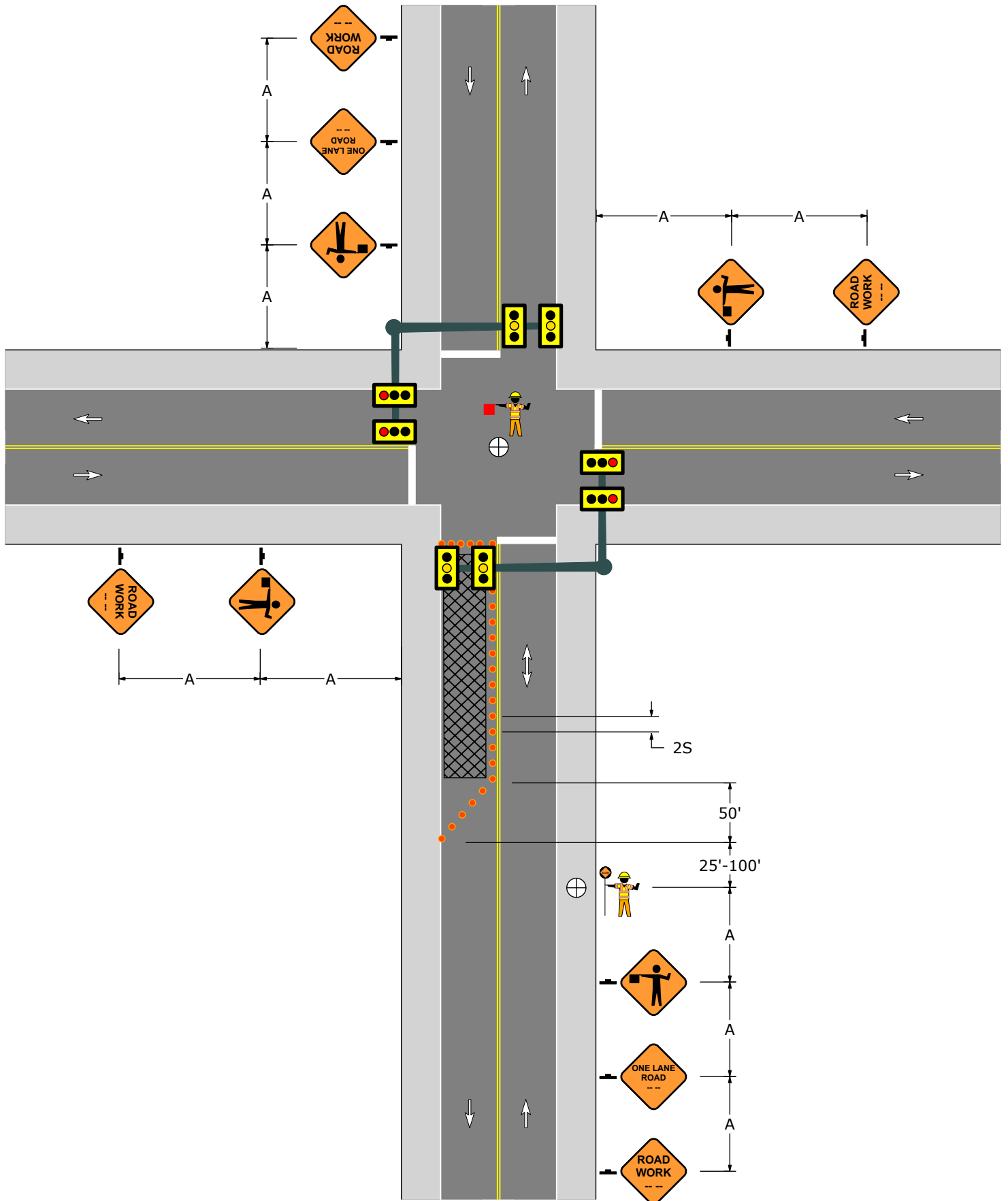
PATA 110-O



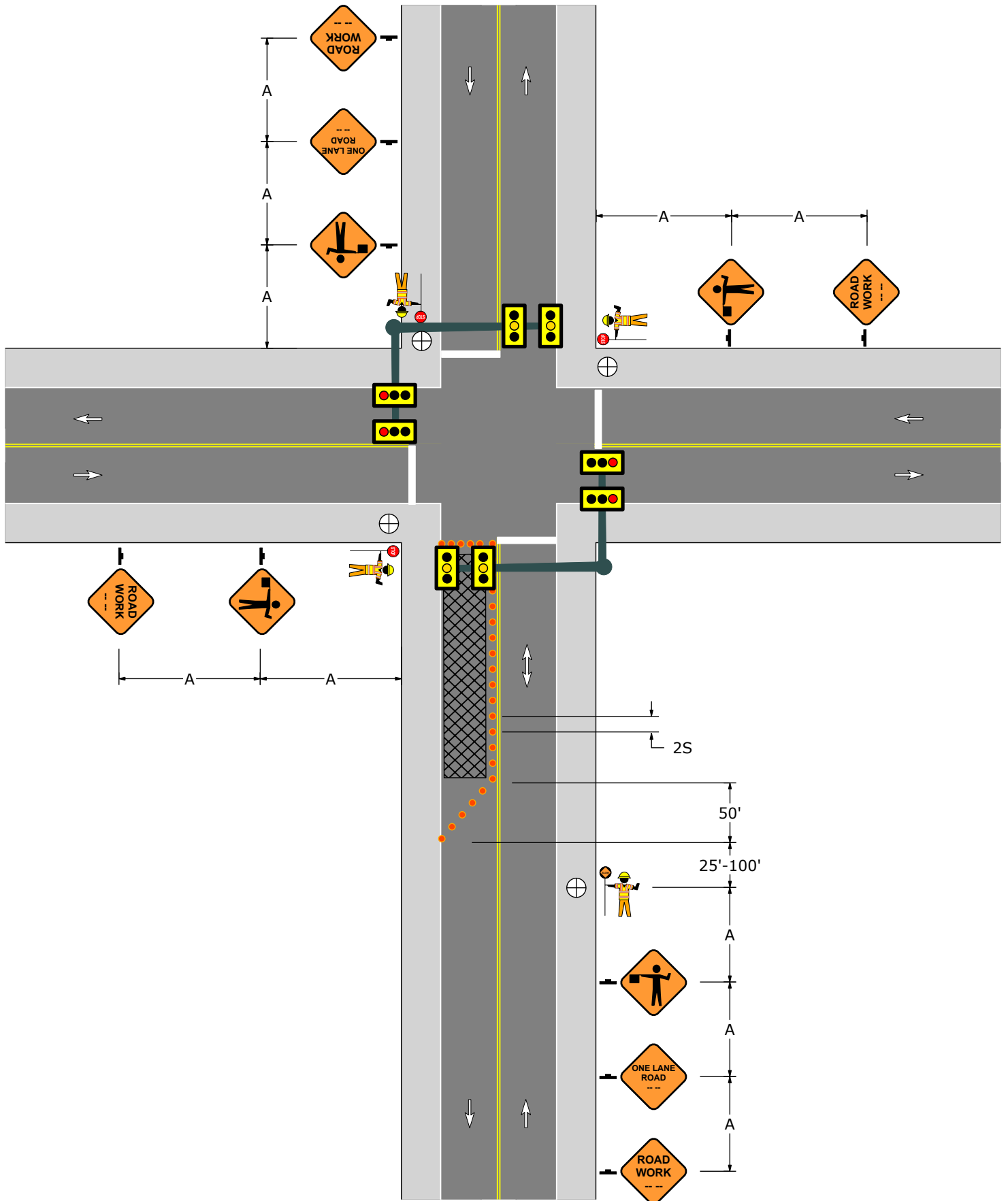
PATA 110-P



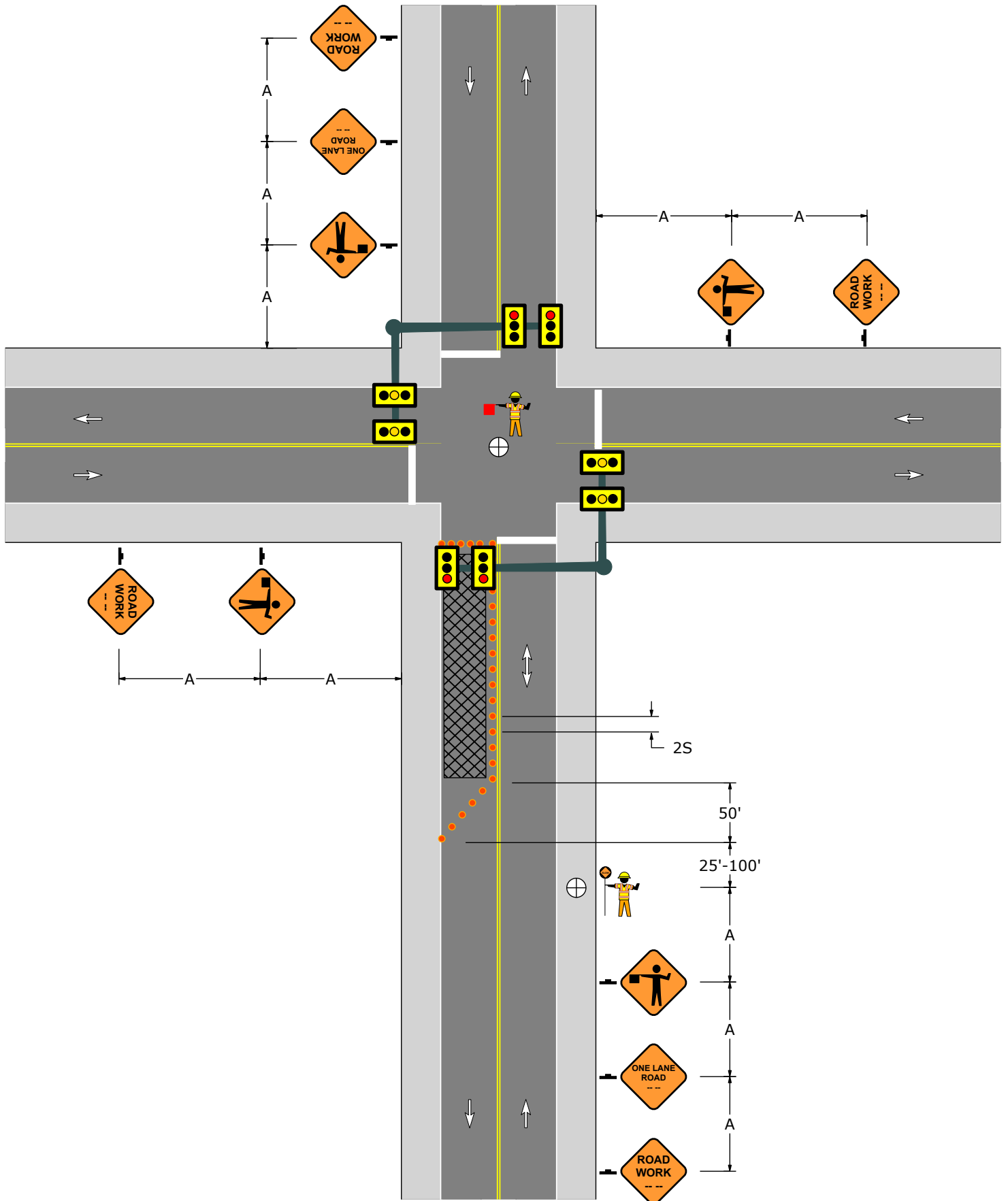
PATA 110-Q



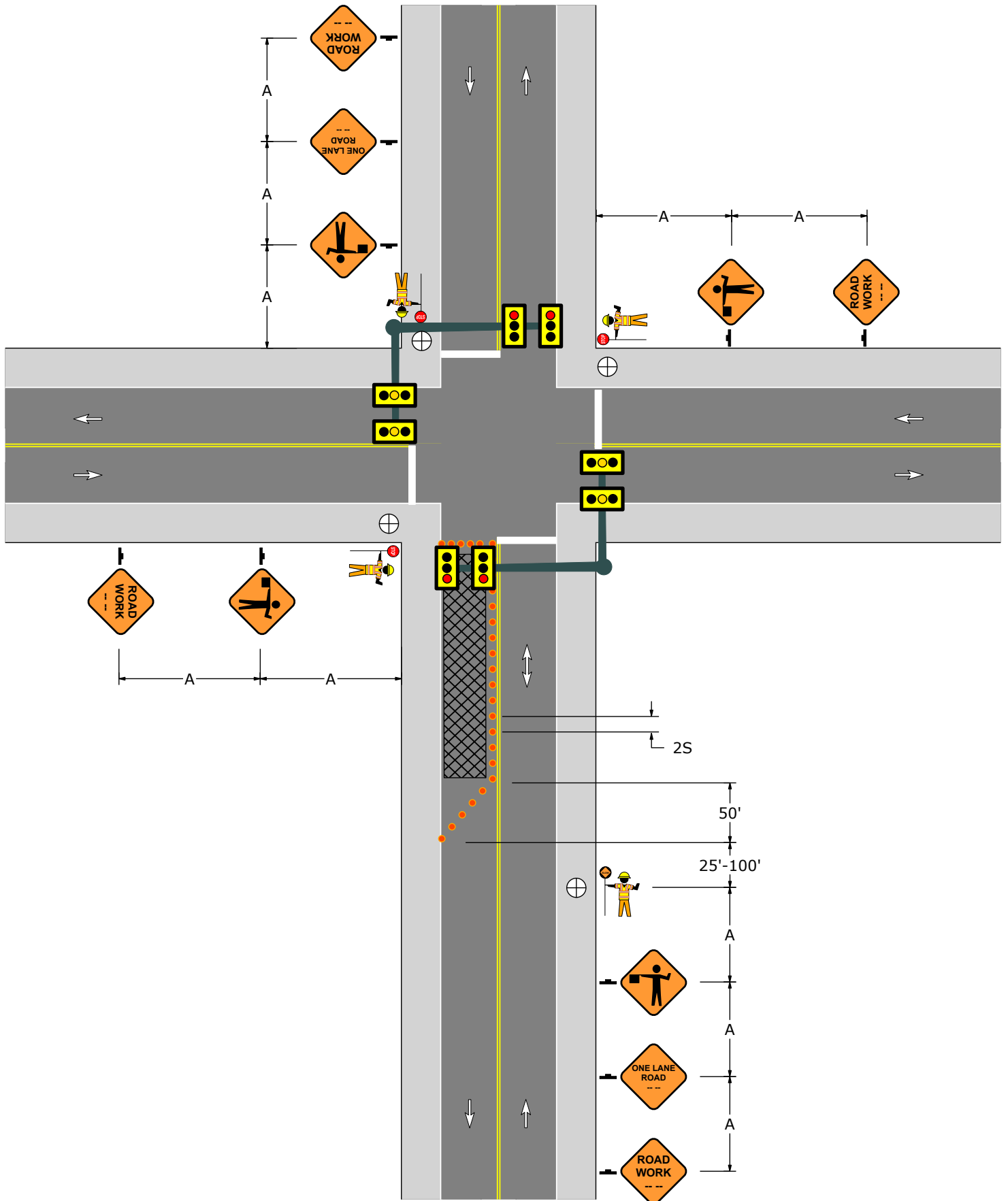
PATA 110-R



PATA 110-S



PATA 110-T








PATA 111

1. This figure applies when all of the following conditions are satisfied:

- a) Sight distance between the STOP signs is unobstructed.
- b) The ADT is not greater than approximately 1500.

2. Attach Type B flashing red lights to STOP signs as shown.

3. When a shadow vehicle is not used, the 50' buffer space is measured from the end of the taper to the beginning of the work space.







Signs				
				
W20-1	W20-4	W1-4R	W3-1	R1-1

Sign and Channelizing Device Spacing			
Speed	Channelizing Devices Spacing	Sign Spacing	
		Urban	Rural
S (MPH)	2S (Feet)	A (Feet)	A (Feet)
25	50	100 - 200	500 - 800
30	60	100 - 200	500 - 800
35	70	100 - 200	500 - 800
40	80	350 - 500	500 - 800
45	90	350 - 500	500 - 800
50	100	350 - 500	500 - 800
55	110	350 - 500	500 - 800

Taper Lengths and Minimum Number Of Channelizing Devices		
Speed	50' Per Lane Taper	
S (MPH)	Length (Feet)	Minimum Number Of Devices
25	50	6
30	50	6
35	50	6
40	50	6
45	50	6
50	50	6
55	50	6

PATA 112

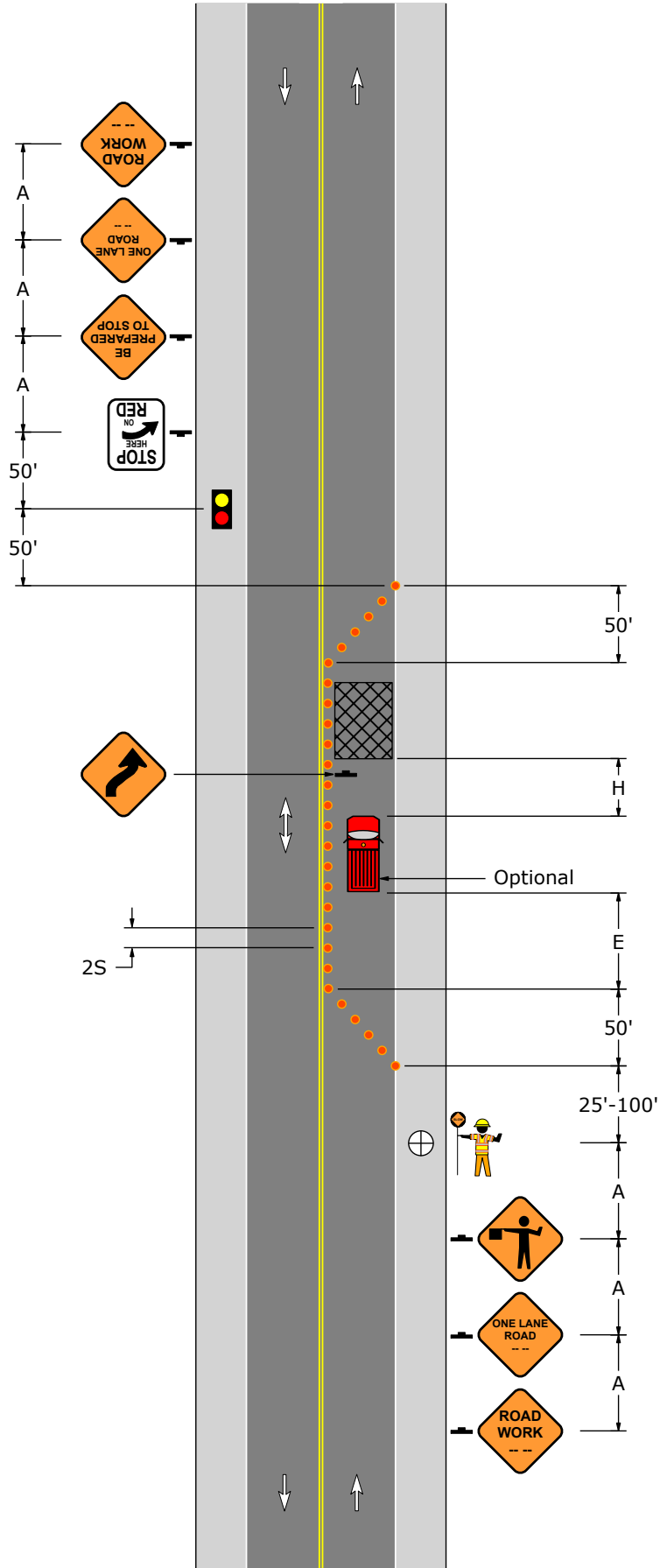
1. The flagger and AFAD shall be clearly visible to traffic for a minimum distance of E. The flagger must be able to see the AFAD and approaching traffic.
2. When a shadow vehicle is not used, distance E is measured from the end of the taper to the beginning of the work space.

Signs					
					
W20-1	W20-4	W20-7	W1-4R	W3-4	R10-6AL

Sign Spacing, Channelizing Device Spacing, Buffer Space, and Roll Ahead Space					
Speed	Channelizing Devices Spacing	Sign Spacing		Buffer Space	Roll Ahead Space
		Urban	Rural		
S (MPH)	2S (Feet)	A (Feet)	A (Feet)	E (Feet)	H (Feet)
25	50	100 - 200	500 - 800	155	150
30	60	100 - 200	500 - 800	200	150
35	70	100 - 200	500 - 800	250	150
40	80	350 - 500	500 - 800	305	150
45	90	350 - 500	500 - 800	360	150
50	100	350 - 500	500 - 800	425	250
55	110	350 - 500	500 - 800	495	250






Taper Lengths and Minimum Number Of Channelizing Devices		
Speed	50' Per Lane Taper	
S (MPH)	Length (Feet)	Minimum Number Of Devices
25	50	6
30	50	6
35	50	6
40	50	6
45	50	6
50	50	6
55	50	6

PATA 112



PATA 113

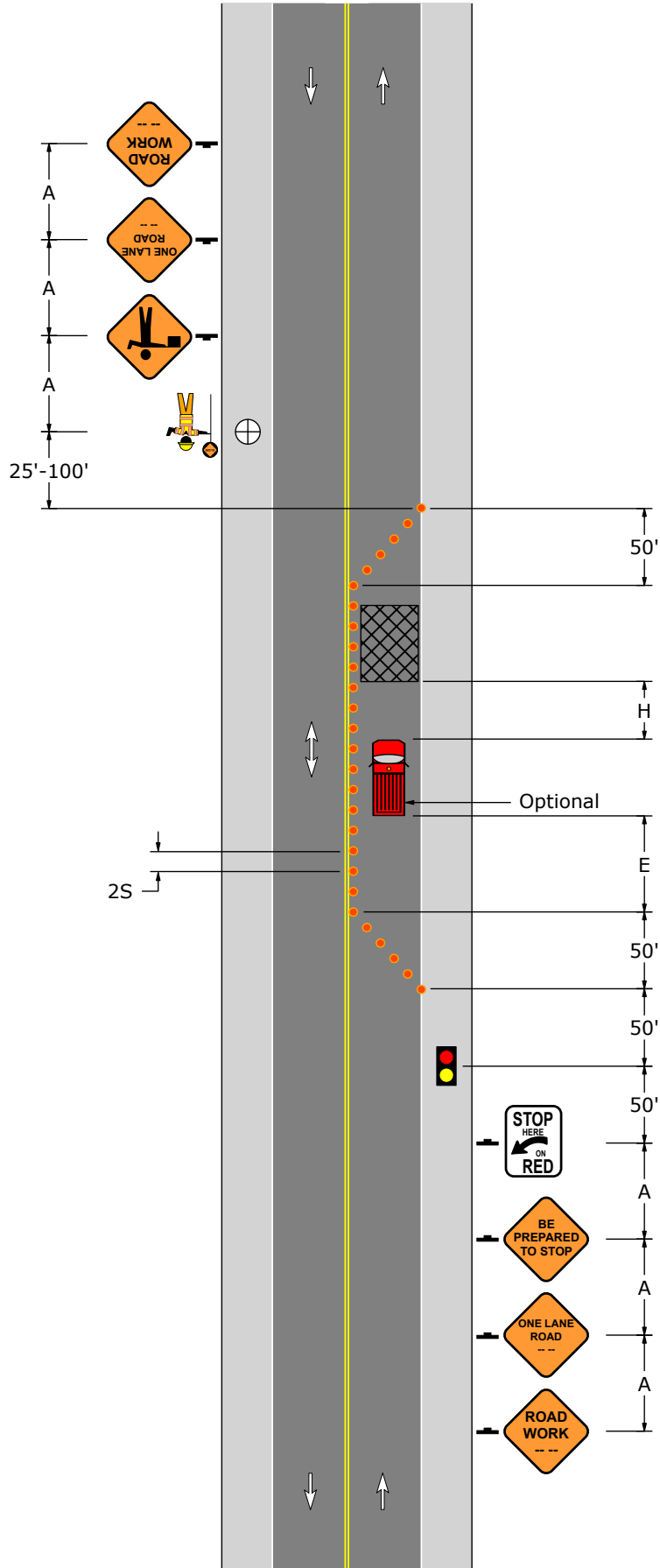
1. The flagger and AFAD shall be clearly visible to traffic for a minimum distance of E. The flagger must be able to see the AFAD and approaching traffic.
2. When a shadow vehicle is not used, distance E is measured from the end of the taper to the beginning of the work space.

Signs				
				
W20-1	W20-4	W20-7	W3-4	R10-6AL

Sign Spacing, Channelizing Device Spacing, Buffer Space, and Roll Ahead Space					
Speed	Channelizing Devices Spacing	Sign Spacing		Buffer Space	Roll Ahead Space
		Urban	Rural		
S (MPH)	2S (Feet)	A (Feet)	A (Feet)	E (Feet)	H (Feet)
25	50	100 - 200	500 - 800	155	150
30	60	100 - 200	500 - 800	200	150
35	70	100 - 200	500 - 800	250	150
40	80	350 - 500	500 - 800	305	150
45	90	350 - 500	500 - 800	360	150
50	100	350 - 500	500 - 800	425	250
55	110	350 - 500	500 - 800	495	250






Taper Lengths and Minimum Number Of Channelizing Devices		
Speed	50' Per Lane Taper	
S (MPH)	Length (Feet)	Minimum Number Of Devices
25	50	6
30	50	6
35	50	6
40	50	6
45	50	6
50	50	6
55	50	6

PATA 113



PATA 114

1. Each AFAD shall be clearly visible to traffic for a minimum distance of E. The flagger must be able to see the AFAD and approaching traffic.
2. While operating the AFAD, a flagger should position themselves beside the AFAD and away from traffic so an escape route is not blocked.
3. When a shadow vehicle is not used, distance E is measured from the end of the taper to the beginning of the work space.






Signs				
				
W20-1	W20-4	W1-4R	W3-4	R10-6AL

Sign Spacing, Channelizing Device Spacing, Buffer Space, and Roll Ahead Space					
Speed	Channelizing Devices Spacing	Sign Spacing		Buffer Space	Roll Ahead Space
		Urban	Rural		
S (MPH)	2S (Feet)	A (Feet)	A (Feet)	E (Feet)	H (Feet)
25	50	100 - 200	500 - 800	155	150
30	60	100 - 200	500 - 800	200	150
35	70	100 - 200	500 - 800	250	150
40	80	350 - 500	500 - 800	305	150
45	90	350 - 500	500 - 800	360	150
50	100	350 - 500	500 - 800	425	250
55	110	350 - 500	500 - 800	495	250

Taper Lengths and Minimum Number Of Channelizing Devices		
Speed	50' Per Lane Taper	
S (MPH)	Length (Feet)	Minimum Number Of Devices
25	50	6
30	50	6
35	50	6
40	50	6
45	50	6
50	50	6
55	50	6

PATA 115

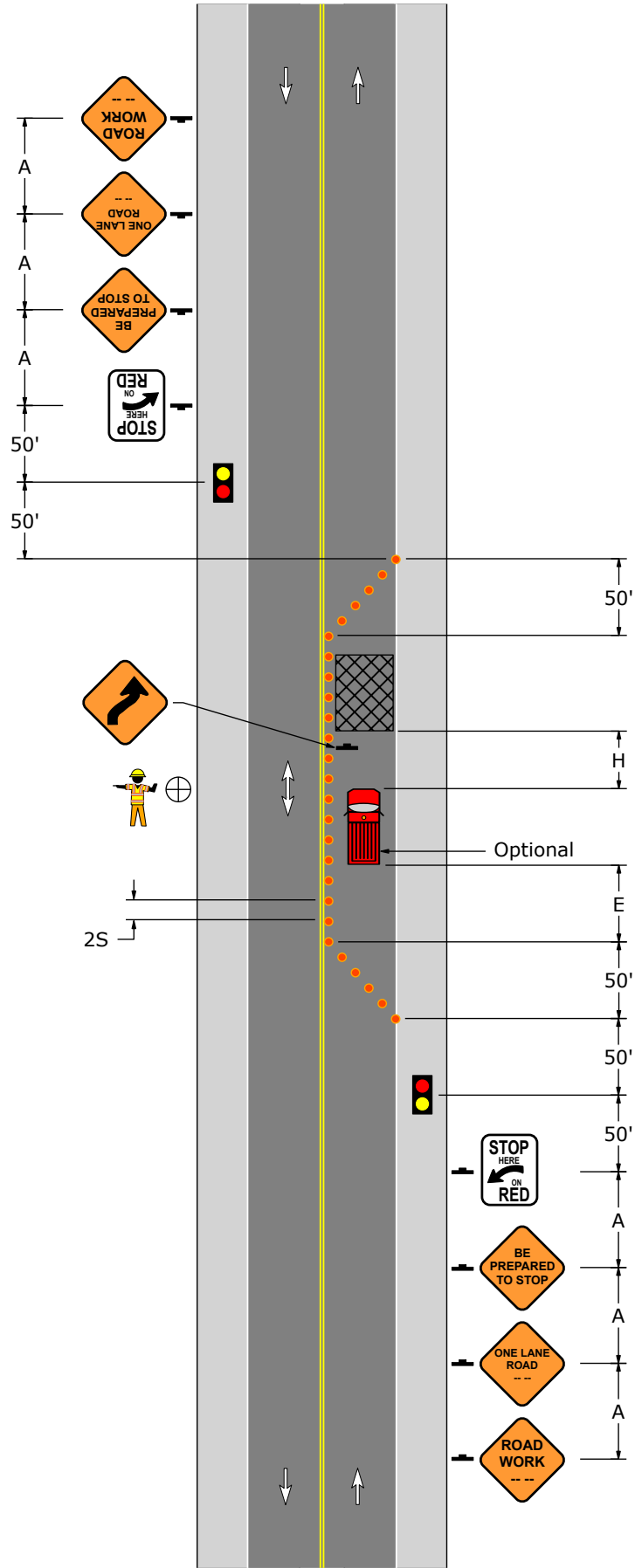
1. Each AFAD shall be clearly visible to traffic for a minimum distance of E. The flagger must be able to see both AFAD and approaching traffic.
2. When a shadow vehicle is not used, distance E is measured from the end of the taper to the beginning of the work space.

Signs				
				
W20-1	W20-4	W1-4R	W3-4	R10-6AL

Sign Spacing, Channelizing Device Spacing, Buffer Space, and Roll Ahead Space					
Speed	Channelizing Devices Spacing	Sign Spacing		Buffer Space	Roll Ahead Space
		Urban	Rural		
S (MPH)	2S (Feet)	A (Feet)	A (Feet)	E (Feet)	H (Feet)
25	50	100 - 200	500 - 800	155	150
30	60	100 - 200	500 - 800	200	150
35	70	100 - 200	500 - 800	250	150
40	80	350 - 500	500 - 800	305	150
45	90	350 - 500	500 - 800	360	150
50	100	350 - 500	500 - 800	425	250
55	110	350 - 500	500 - 800	495	250












Taper Lengths and Minimum Number Of Channelizing Devices		
Speed	50' Per Lane Taper	
S (MPH)	Length (Feet)	Minimum Number Of Devices
25	50	6
30	50	6
35	50	6
40	50	6
45	50	6
50	50	6
55	50	6

PATA 115



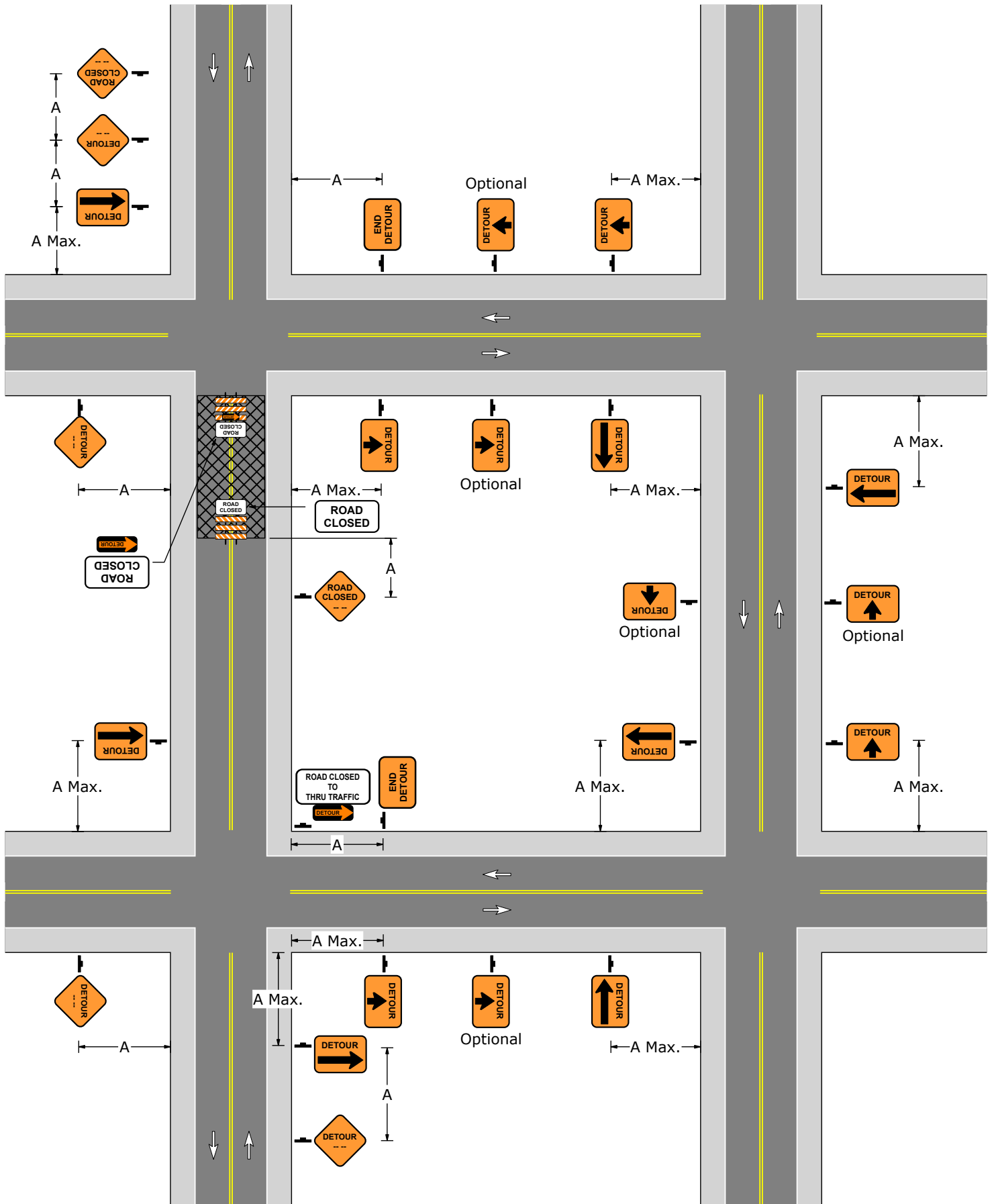
PATA 116-A

1. This figure applies to stationary operations where it is not feasible to maintain alternate one direction traffic flow.
2. At locations where there are overlapping detours or several detours within the same area, street names may be added to the DETOUR M4-9 series signs, or signs with different color arrows may be used to designate different detour routes. The design and application of signs displaying color arrows shall comply with PennDOT Publication 236.
3. THIS STREET TO BE CLOSED FOR MAINTENANCE NEXT WEEK signs should be installed one week in advance of scheduled work. Install the signs at most appropriate locations. PCMS may be used in lieu of static signs.
4. Placement of confirmation DETOUR Straight (M4-9S) signs along the detour is optional. If used, signs should be placed approximately every mile or after major intersections.
5. DETOUR Left and DETOUR Right (M4-9L and M4-9R) signs shall be posted prior to every turn along the detour route. These signs must be located within distance A of each intersection.
6. TTC signs shall not be attached to permanent sign posts or utility poles without the utility pole owner's permission.
7. TTC signs shown with Type III Barricades should be placed on Type III Barricades whenever feasible, however it is permissible to use other approved devices at these locations.

Signs								
								
W20-2	W20-3	M4-9S	M4-9L	M4-9R	M4-8A	M4-10L	M4-10R	R11-2
								
R11-4	W23-101							










Sign Spacing		
Speed	Sign Spacing	
	Urban	Rural
S (MPH)	A (Feet)	A (Feet)
25	100 - 200	500 - 800
30	100 - 200	500 - 800
35	100 - 200	500 - 800
40	350 - 500	500 - 800
45	350 - 500	500 - 800
50	350 - 500	500 - 800
55	350 - 500	500 - 800

PATA 116-A



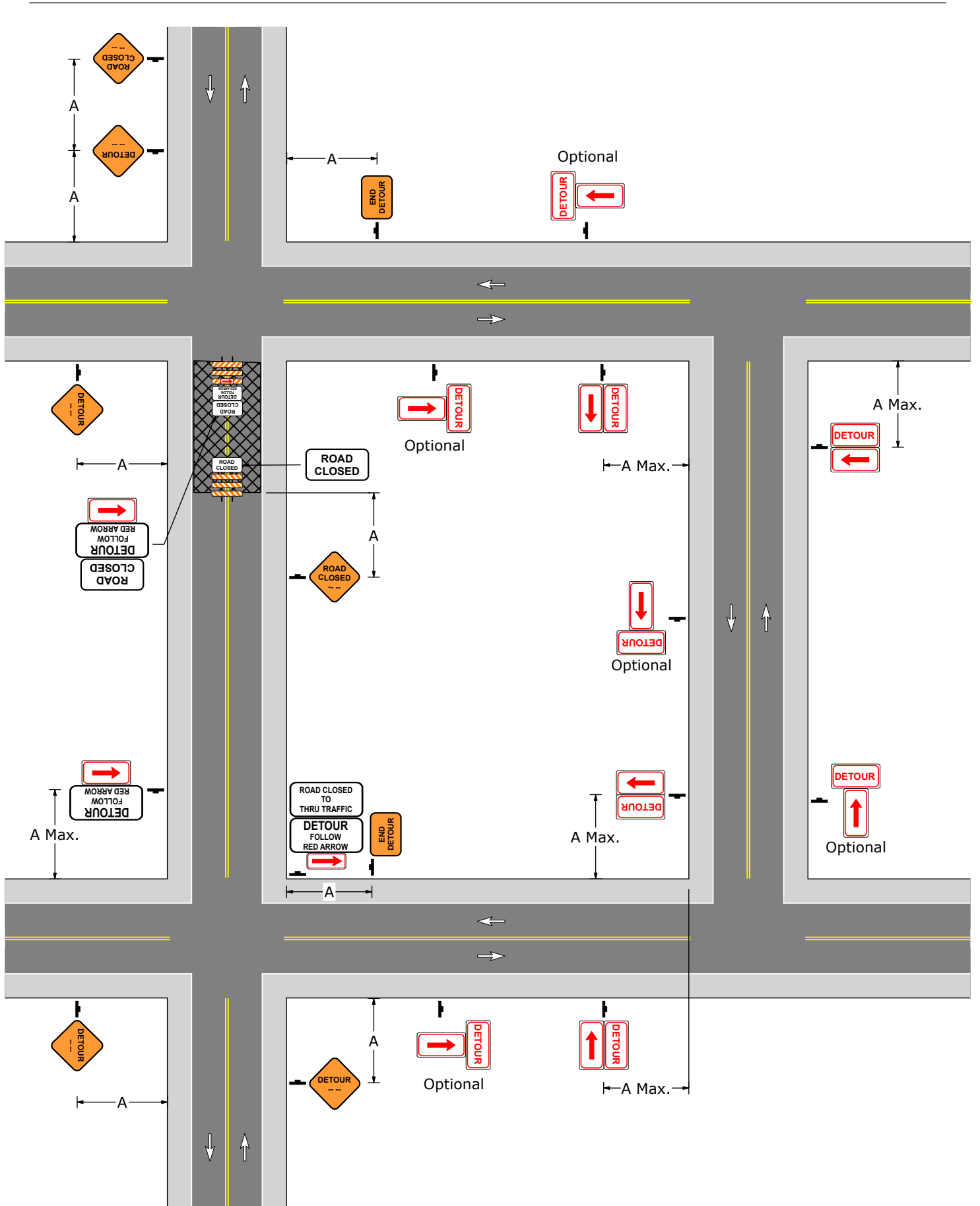
PATA 116-B

1. This PATA applies to stationary operations where it is not feasible to maintain alternate one direction traffic flow. If used, it shall only be used during daylight hours and only on roadways with an ADT of 1500 or less.
2. Advance warning signs are shown for two conditions; one when the 'road is closed' and the other when the 'road is closed to through traffic'. Install the most appropriate TTC signs based upon field conditions.
3. At locations where there are overlapping detours or several detours within the same area, street names may be added below the RED ARROW (G20-6-1) signs, or signs with different color arrows may be used to designate different detour routes. The design and application of signs displaying color arrows shall comply with PennDOT Publication 236.
4. THIS STREET TO BE CLOSED FOR MAINTENANCE NEXT WEEK signs should be installed one week in advance of scheduled work. Install the signs at most appropriate locations. PCMS may be used in lieu of static signs.
5. DETOUR (G20-6-2) and RED ARROW (G20-6-1) signs shall be posted in advance of each intersection where a turn is required to remain on the detour route. RED ARROW signs are to be mounted below the DETOUR signs and shall point in the direction of the required turning movement.
6. DETOUR (G20-6-2) and RED ARROW (G20-6-1) signs pointing straight ahead are optional.
7. TTC signs shall not be attached to permanent sign posts or utility poles without the utility pole owner's permission.
8. The DETOUR FOLLOW RED ARROW (G20-6) and RED ARROW (G20-6-1) signs should be mounted below or next to the ROAD CLOSED or ROAD CLOSED TO THRU TRAFFIC sign on Type III Barricades.
9. TTC signs shown with Type III Barricades should be placed on Type III Barricades whenever feasible, however it is permissible to use other appropriate sign installation methods

Signs								
								
W20-2	W20-3	M4-8A	R11-2	R11-4	G20-6	G20-6-1	G20-6-2	W23-101





Sign Spacing		
Speed	Sign Spacing	
	Urban	Rural
S (MPH)	A (Feet)	A (Feet)
25	100 - 200	500 - 800
30	100 - 200	500 - 800
35	100 - 200	500 - 800
40	350 - 500	500 - 800
45	350 - 500	500 - 800
50	350 - 500	500 - 800
55	350 - 500	500 - 800

PATA 116-B



PATA 117

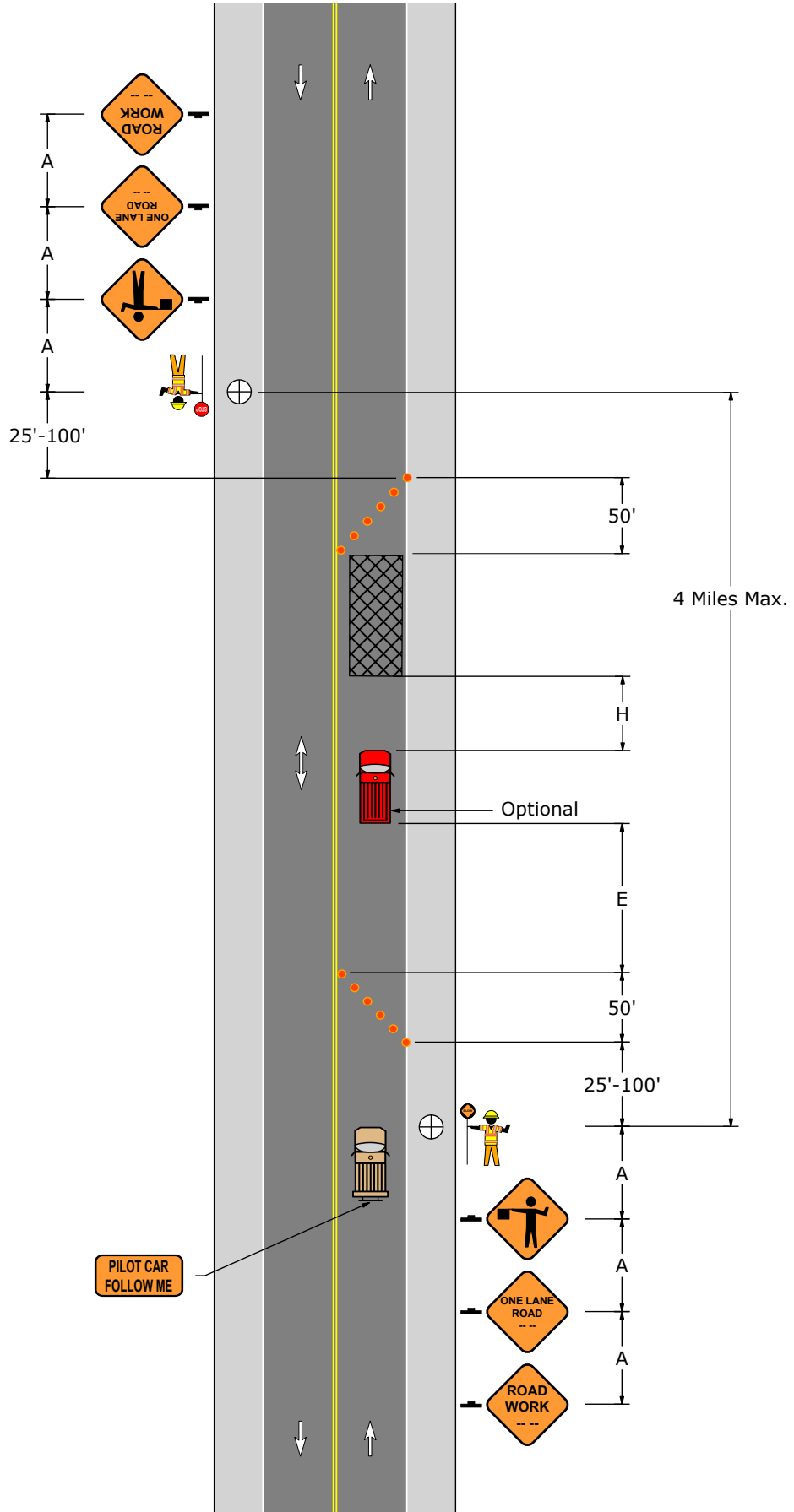
1. Flaggers shall be clearly visible to traffic for a minimum distance of E.
2. This PATA applies to roads with an ADT of 5000 or less.
3. When a shadow vehicle is not used, distance E is measured from the downstream end of taper to the beginning of the work space.

Signs			
			
W20-1	W20-4	W20-7	G20-4

Sign Spacing, Buffer Space, and Roll Ahead Space				
Speed	Sign Spacing		Buffer Space	Roll Ahead Space
	Urban	Rural		
S (MPH)	A (Feet)	A (Feet)	E (Feet)	H (Feet)
25	100 - 200	500 - 800	155	150
30	100 - 200	500 - 800	200	150
35	100 - 200	500 - 800	250	150
40	350 - 500	500 - 800	305	150
45	350 - 500	500 - 800	360	150
50	350 - 500	500 - 800	425	250
55	350 - 500	500 - 800	495	250






Taper Lengths and Minimum Number Of Channelizing Devices		
Speed	50' Per Lane Taper	
S (MPH)	Length (Feet)	Minimum Number Of Devices
25	50	6
30	50	6
35	50	6
40	50	6
45	50	6
50	50	6
55	50	6

PATA 117



PATA 118

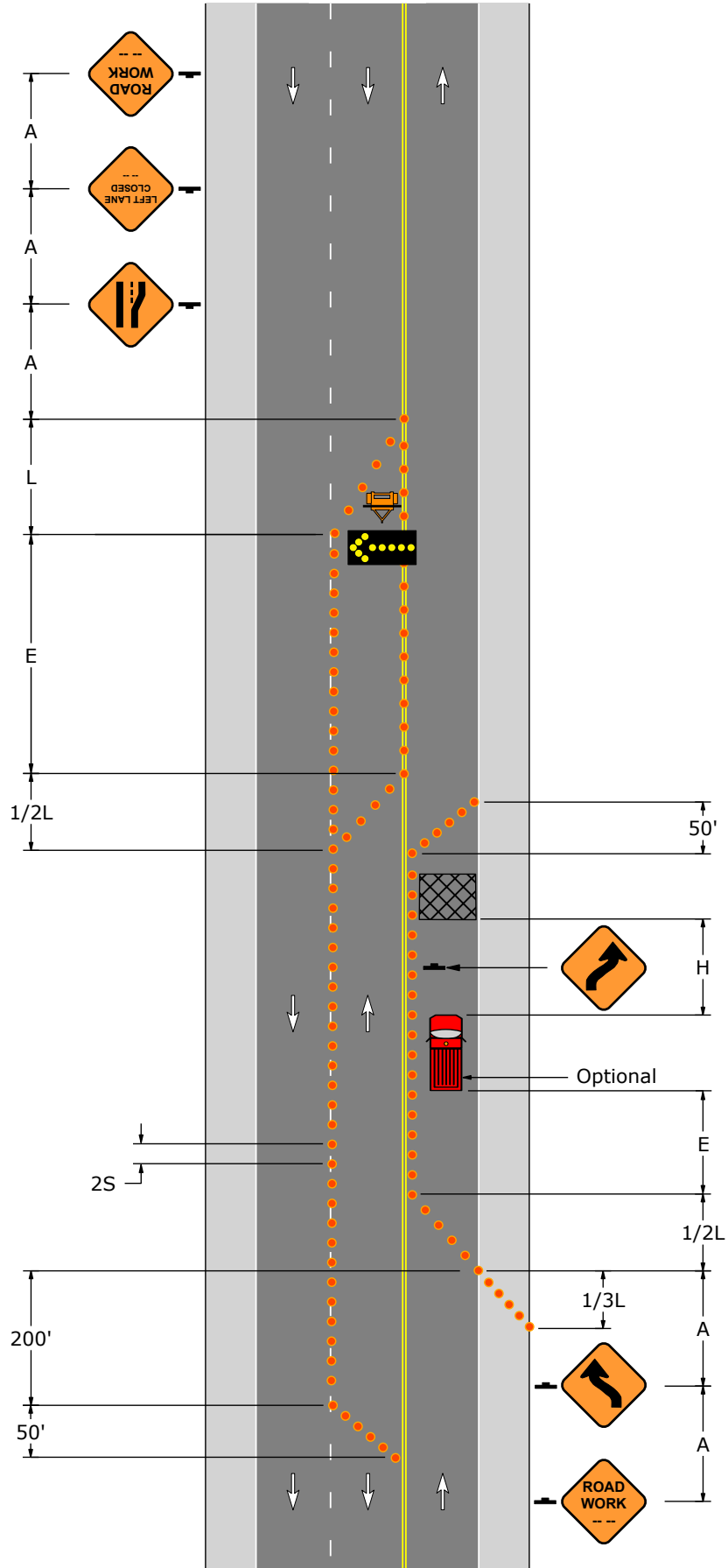
1. When a shadow vehicle is not used, distance E is measured from the end of the taper to the beginning of the work space.

Signs				
				
W20-1	W20-5L	W1-4L	W1-4R	W4-2L

Sign Spacing, Channelizing Device Spacing, Buffer Space, and Roll Ahead Space					
Speed	Channelizing Devices Spacing	Sign Spacing		Buffer Space	Roll Ahead Space
		Urban	Rural		
S (MPH)	2S (Feet)	A (Feet)	A (Feet)	E (Feet)	H (Feet)
25	50	100 - 200	500 - 800	155	150
30	60	100 - 200	500 - 800	200	150
35	70	100 - 200	500 - 800	250	150
40	80	350 - 500	500 - 800	305	150
45	90	350 - 500	500 - 800	360	150
50	100	350 - 500	500 - 800	425	250
55	110	350 - 500	500 - 800	495	250







Taper Lengths and Minimum Number of Channelizing Devices								
Speed	Merging Taper: L		Shifting Taper: 1/2L		Shoulder Taper: 1/3L		50' Per Lane Taper	
S (MPH)	Length (Feet)	Minimum Number Of Devices	Length (Feet)	Minimum Number Of Devices	Length (Feet)	Minimum Number Of Devices	Length (Feet)	Minimum Number Of Devices
25	125	6	65	6	45	6	50	6
30	180	7	90	6	60	6	50	6
35	245	8	125	6	85	6	50	6
40	320	9	160	6	110	6	50	6
45	540	13	270	7	180	6	50	6
50	600	13	300	7	200	6	50	6
55	660	13	330	7	220	6	50	6

PATA 118



PATA 119

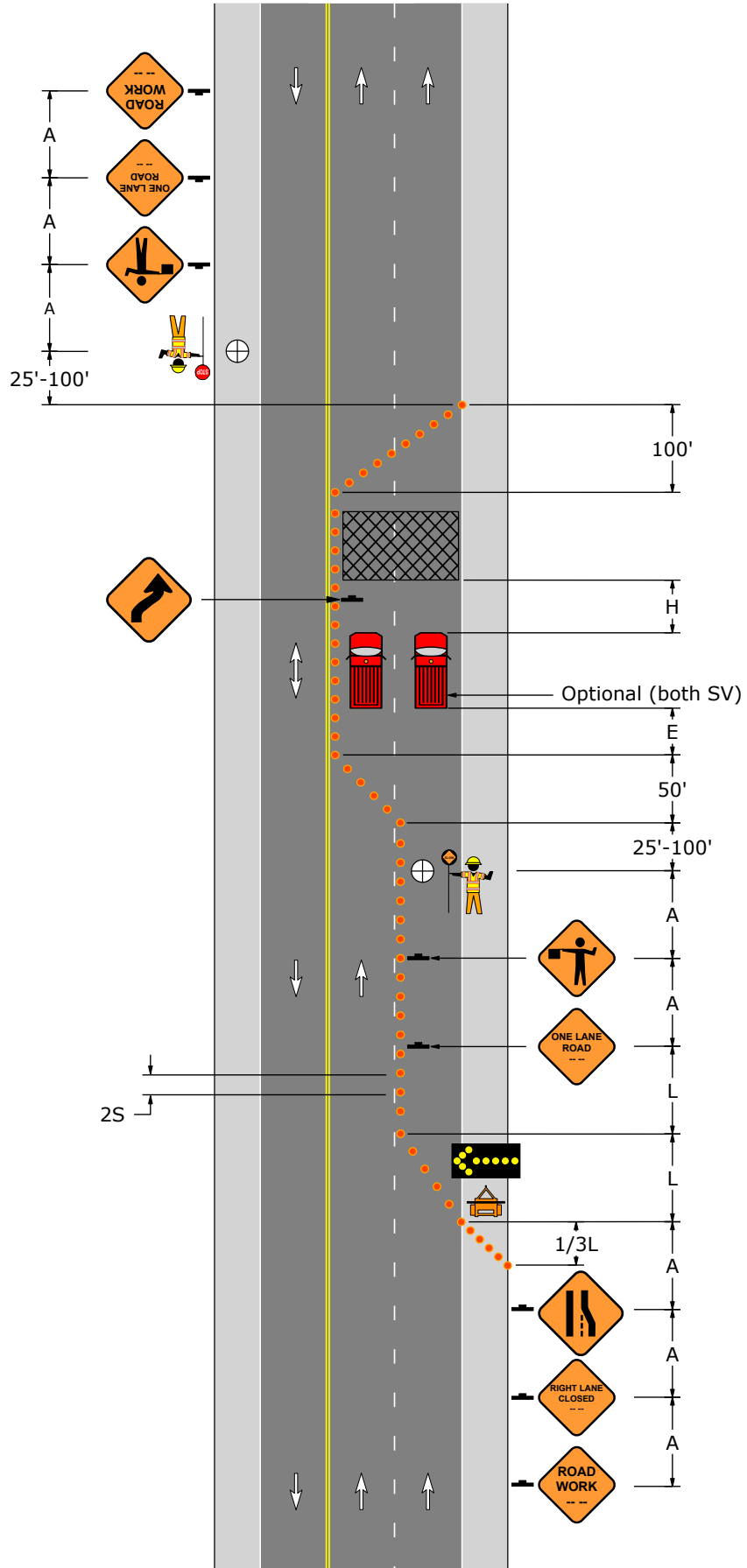
1. Flaggers shall be clearly visible to traffic for a minimum distance of E.
2. When a shadow vehicle is not used, distance E is measured from the end of the taper to the beginning of the work space.
3. If two shadow vehicles are used, they should be placed side-by-side as shown on the PATA drawing.

Signs					
					
W20-1	W20-4	W20-7	W4-2R	W20-5R	W1-4R

Sign Spacing, Channelizing Device Spacing, Buffer Space, and Roll Ahead Space					
Speed	Channelizing Devices Spacing	Sign Spacing		Buffer Space	Roll Ahead Space
		Urban	Rural		
S (MPH)	2S (Feet)	A (Feet)	A (Feet)	E (Feet)	H (Feet)
25	50	100 - 200	500 - 800	155	150
30	60	100 - 200	500 - 800	200	150
35	70	100 - 200	500 - 800	250	150
40	80	350 - 500	500 - 800	305	150
45	90	350 - 500	500 - 800	360	150
50	100	350 - 500	500 - 800	425	250
55	110	350 - 500	500 - 800	495	250







Taper Lengths and Minimum Number of Channelizing Devices						
Speed	Merging Taper: L		Shoulder Taper: 1/3L		50' Per Lane Taper	
S (MPH)	Length (Feet)	Minimum Number Of Devices	Length (Feet)	Minimum Number Of Devices	Length (Feet)	Minimum Number Of Devices
25	125	6	45	6	50	6
30	180	7	60	6	50	6
35	245	8	85	6	50	6
40	320	9	110	6	50	6
45	540	13	180	6	50	6
50	600	13	200	6	50	6
55	660	13	220	7	50	6

PATA 119



PATA 120

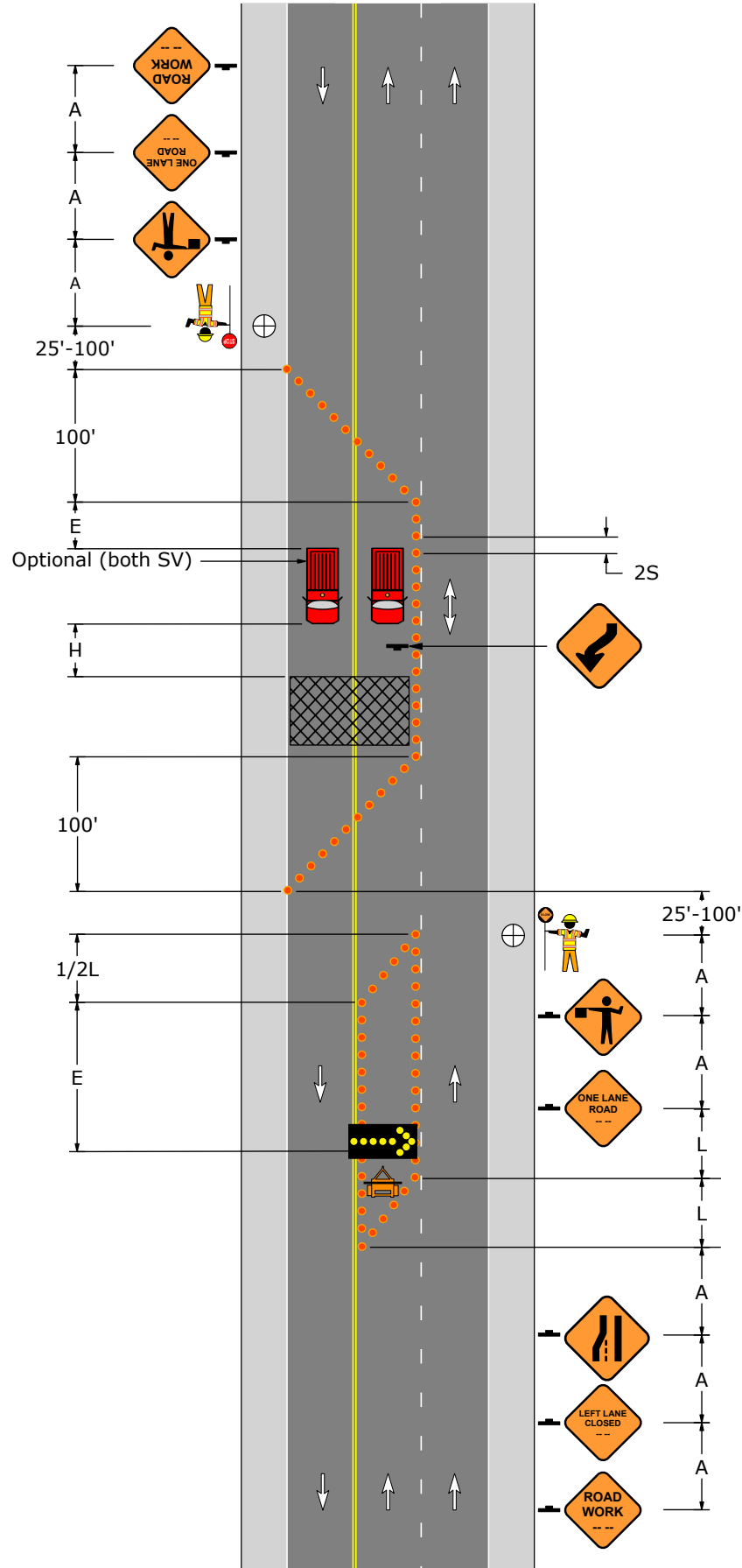
1. Flaggers shall be clearly visible to traffic for a minimum distance of E.
2. When a shadow vehicle is not used, distance E is measured from end of taper to beginning of work space.
3. If two shadow vehicles are used, they should be placed side-by-side as shown on the PATA drawing.

Signs					
					
W20-1	W20-4	W20-7	W20-5L	W4-2L	W1-4R

Sign Spacing, Channelizing Device Spacing, Buffer Space, and Roll Ahead Space					
Speed	Channelizing Devices Spacing	Sign Spacing		Buffer Space	Roll Ahead Space
		Urban	Rural		
S (MPH)	2S (Feet)	A (Feet)	A (Feet)	E (Feet)	H (Feet)
25	50	100 - 200	500 - 800	155	150
30	60	100 - 200	500 - 800	200	150
35	70	100 - 200	500 - 800	250	150
40	80	350 - 500	500 - 800	305	150
45	90	350 - 500	500 - 800	360	150
50	100	350 - 500	500 - 800	425	250
55	110	350 - 500	500 - 800	495	250





Taper Lengths and Minimum Number of Channelizing Devices						
Speed	Merging Taper: L		Shifting Taper: 1/2L		50' Per Lane Taper	
S (MPH)	Length (Feet)	Minimum Number Of Devices	Length (Feet)	Minimum Number Of Devices	Length (Feet)	Minimum Number Of Devices
25	125	6	65	6	50	6
30	180	7	90	6	50	6
35	245	8	125	6	50	6
40	320	9	160	6	50	6
45	540	13	270	7	50	6
50	600	13	300	7	50	6
55	660	13	330	7	50	6

PATA 120



PATA 121

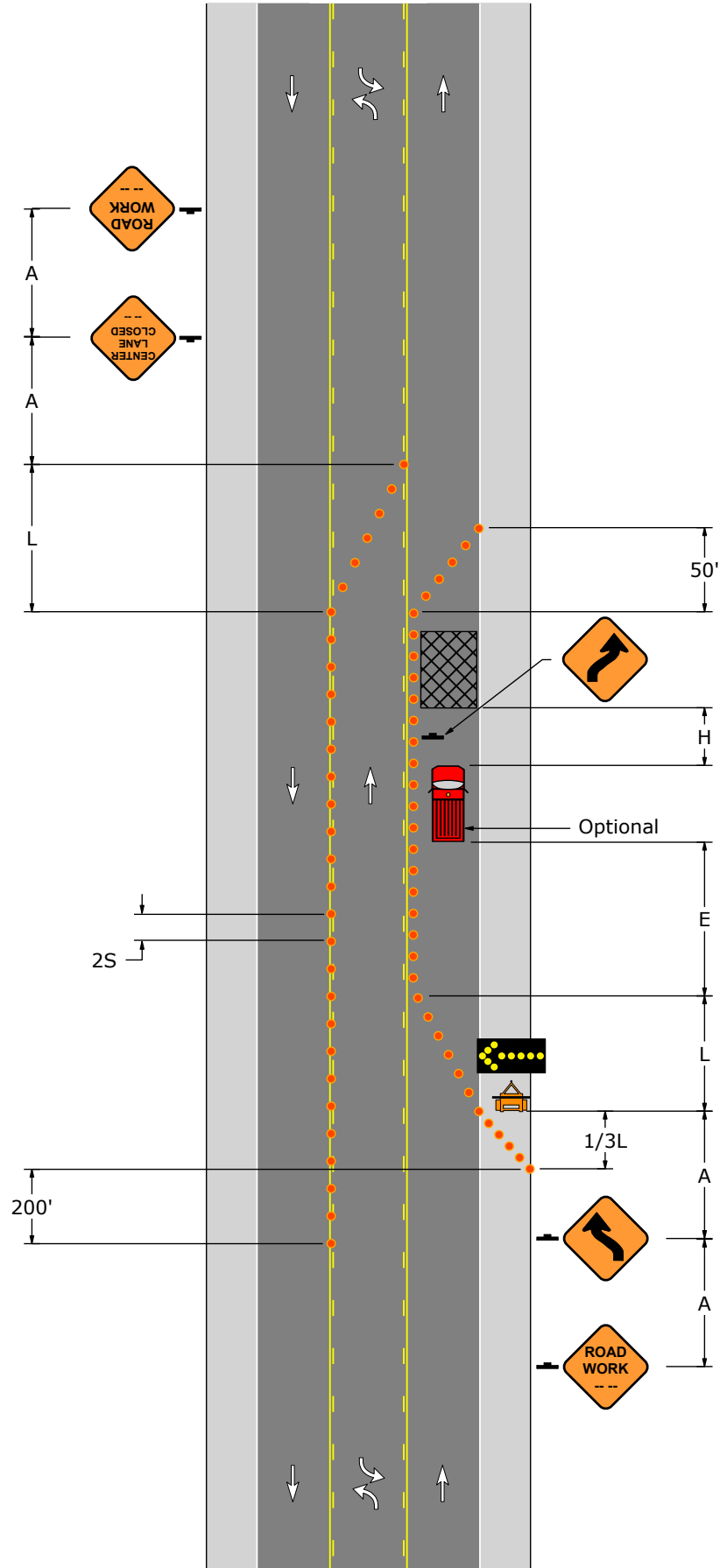
1. When a shadow vehicle is not used, distance E is measured from the end of the taper to the beginning of the work space.

Signs			
			
W20-1	W1-4L	W1-4R	W9-3

Sign Spacing, Channelizing Device Spacing, Buffer Space, and Roll Ahead Space					
Speed	Channelizing Devices Spacing	Sign Spacing		Buffer Space	Roll Ahead Space
		Urban	Rural		
S (MPH)	2S (Feet)	A (Feet)	A (Feet)	E (Feet)	H (Feet)
25	50	100 - 200	500 - 800	155	150
30	60	100 - 200	500 - 800	200	150
35	70	100 - 200	500 - 800	250	150
40	80	350 - 500	500 - 800	305	150
45	90	350 - 500	500 - 800	360	150
50	100	350 - 500	500 - 800	425	250
55	110	350 - 500	500 - 800	495	250

Taper Lengths and Minimum Number of Channelizing Devices						
Speed	Merging Taper: L		Shoulder Taper: 1/3L		50' Per Lane Taper	
S (MPH)	Length (Feet)	Minimum Number Of Devices	Length (Feet)	Minimum Number Of Devices	Length (Feet)	Minimum Number Of Devices
25	125	6	45	6	50	6
30	180	7	60	6	50	6
35	245	8	85	6	50	6
40	320	9	110	6	50	6
45	540	13	180	6	50	6
50	600	13	200	6	50	6
55	660	13	220	7	50	6

PATA 121





PATA 122

1. For operations of 15 minutes or less:

- a) The ROAD WORK and CENTER LANE CLOSED signs are not required.
- b) All channelizing devices may be eliminated if a shadow vehicle is present and the operation does not move.

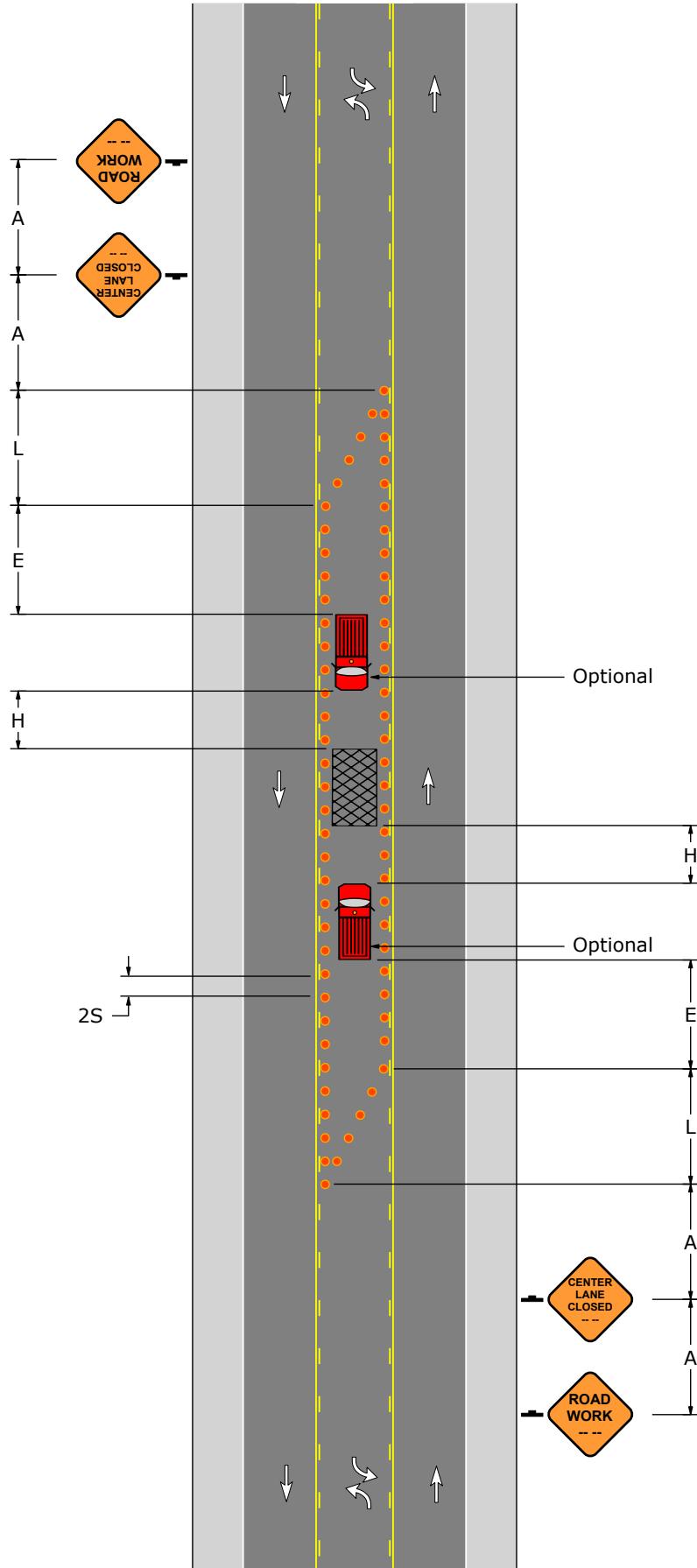
2. When a shadow vehicle is not used, distance E is measured from the end of the taper to the beginning of the work space.

Signs	
	
W20-1	W9-3

Sign Spacing, Channelizing Device Spacing, Buffer Space, and Roll Ahead Space					
Speed	Channelizing Devices Spacing	Sign Spacing		Buffer Space	Roll Ahead Space
		Urban	Rural		
S (MPH)	2S (Feet)	A (Feet)	A (Feet)	E (Feet)	H (Feet)
25	50	100 - 200	500 - 800	155	150
30	60	100 - 200	500 - 800	200	150
35	70	100 - 200	500 - 800	250	150
40	80	350 - 500	500 - 800	305	150
45	90	350 - 500	500 - 800	360	150
50	100	350 - 500	500 - 800	425	250
55	110	350 - 500	500 - 800	495	250

Taper Lengths and Minimum Number of Channelizing Devices		
Speed	Merging Taper: L	
S (MPH)	Length (Feet)	Minimum Number Of Devices
25	125	6
30	180	7
35	245	8
40	320	9
45	540	13
50	600	13
55	660	13

PATA 122






PATA 123-A

1. For operations of 15 minutes or less:

- a) The ROAD WORK, RIGHT LANE CLOSED, and RIGHT LANE ENDS signs are not required.
- b) All channelizing devices may be eliminated if a shadow vehicle is present and the operation does not move.

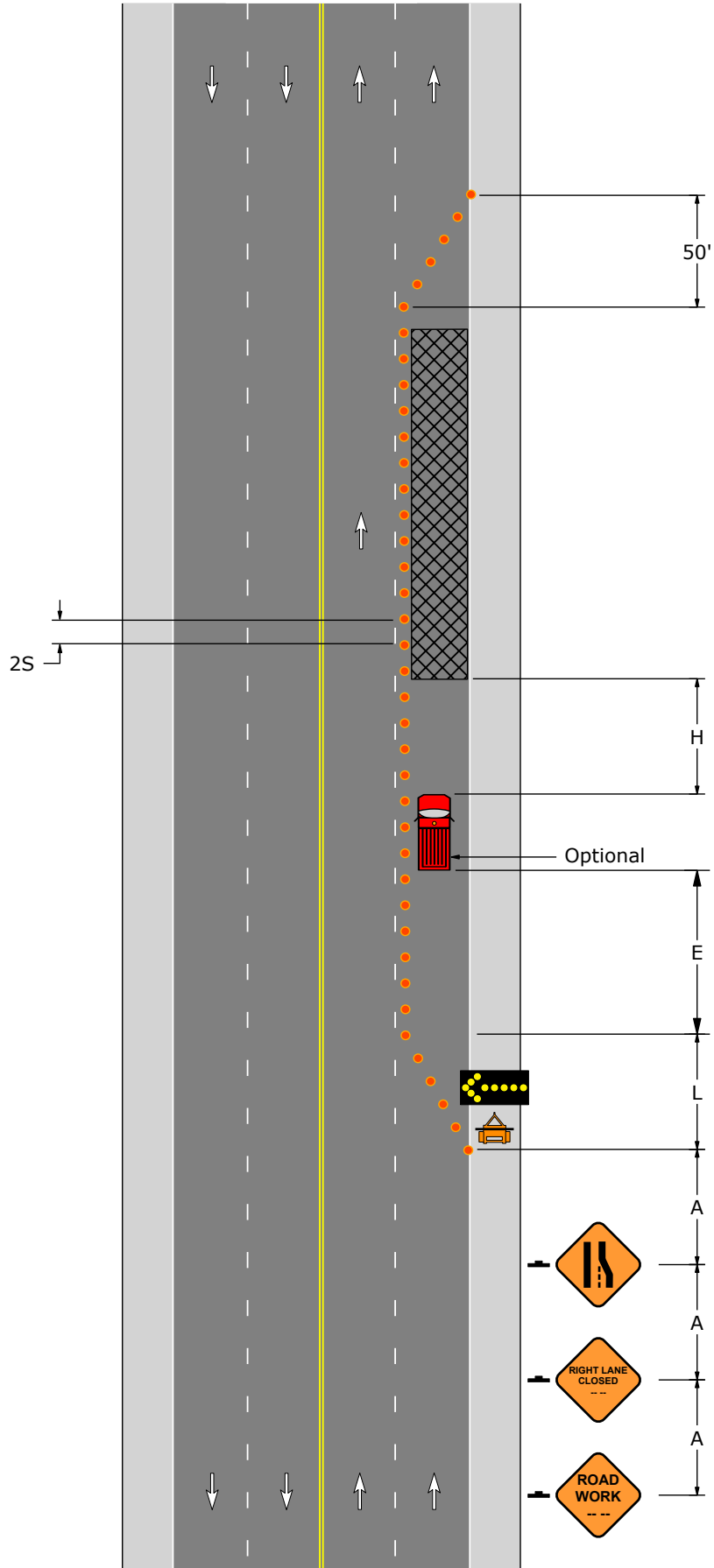
2. When a shadow vehicle is not used, distance E is measured from the end of the taper to the beginning of the work space.

Signs		
		
W20-1	W20-5R	W4-2R

Sign Spacing, Channelizing Device Spacing, Buffer Space, and Roll Ahead Space					
Speed	Channelizing Devices Spacing	Sign Spacing		Buffer Space	Roll Ahead Space
		Urban	Rural		
S (MPH)	2S (Feet)	A (Feet)	A (Feet)	E (Feet)	H (Feet)
25	50	100 - 200	500 - 800	155	150
30	60	100 - 200	500 - 800	200	150
35	70	100 - 200	500 - 800	250	150
40	80	350 - 500	500 - 800	305	150
45	90	350 - 500	500 - 800	360	150
50	100	350 - 500	500 - 800	425	250
55	110	350 - 500	500 - 800	495	250

Taper Lengths and Minimum Number of Channelizing Devices				
Speed	Merging Taper: L		50' Per Lane Taper	
S (MPH)	Length (Feet)	Minimum Number Of Devices	Length (Feet)	Minimum Number Of Devices
25	125	6	50	6
30	180	7	50	6
35	245	8	50	6
40	320	9	50	6
45	540	13	50	6
50	600	13	50	6
55	660	13	50	6

PATA 123-A






PATA 123-B

1. For operations of 15 minutes or less:

- a) The ROAD WORK, LANE CLOSED, and LEFT LANE ENDS signs are not required.
- b) All channelizing devices may be eliminated if a shadow vehicle is present and the operation does not move.

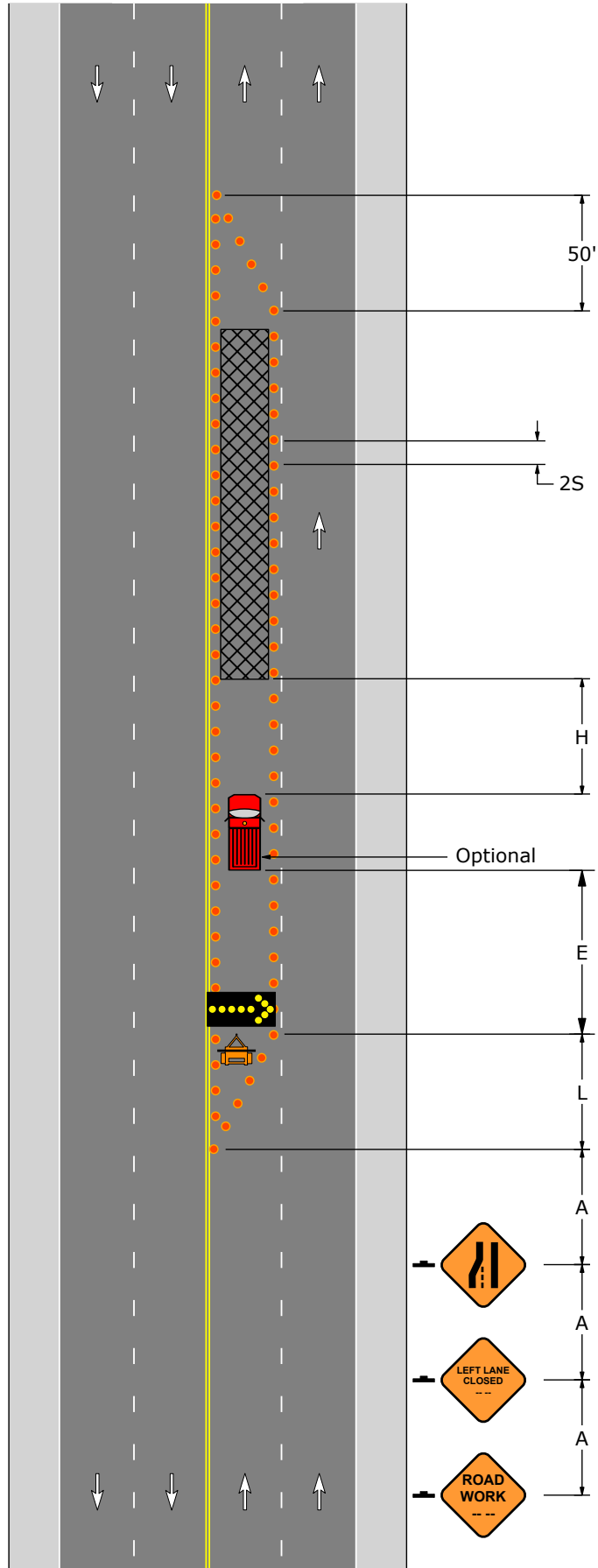
2. When a shadow vehicle is not used, distance E is measured from the end of the taper to the beginning of the work space.

Signs		
		
W20-1	W20-5L	W4-2L

Sign Spacing, Channelizing Device Spacing, Buffer Space, and Roll Ahead Space					
Speed	Channelizing Devices Spacing	Sign Spacing		Buffer Space	Roll Ahead Space
		Urban	Rural		
S (MPH)	2S (Feet)	A (Feet)	A (Feet)	E (Feet)	H (Feet)
25	50	100 - 200	500 - 800	155	150
30	60	100 - 200	500 - 800	200	150
35	70	100 - 200	500 - 800	250	150
40	80	350 - 500	500 - 800	305	150
45	90	350 - 500	500 - 800	360	150
50	100	350 - 500	500 - 800	425	250
55	110	350 - 500	500 - 800	495	250








Taper Lengths and Minimum Number of Channelizing Devices				
Speed	Merging Taper: L		50' Per Lane Taper	
S (MPH)	Length (Feet)	Minimum Number Of Devices	Length (Feet)	Minimum Number Of Devices
25	125	6	50	6
30	180	7	50	6
35	245	8	50	6
40	320	9	50	6
45	540	13	50	6
50	600	13	50	6
55	660	13	50	6

PATA 123-B



PATA 124

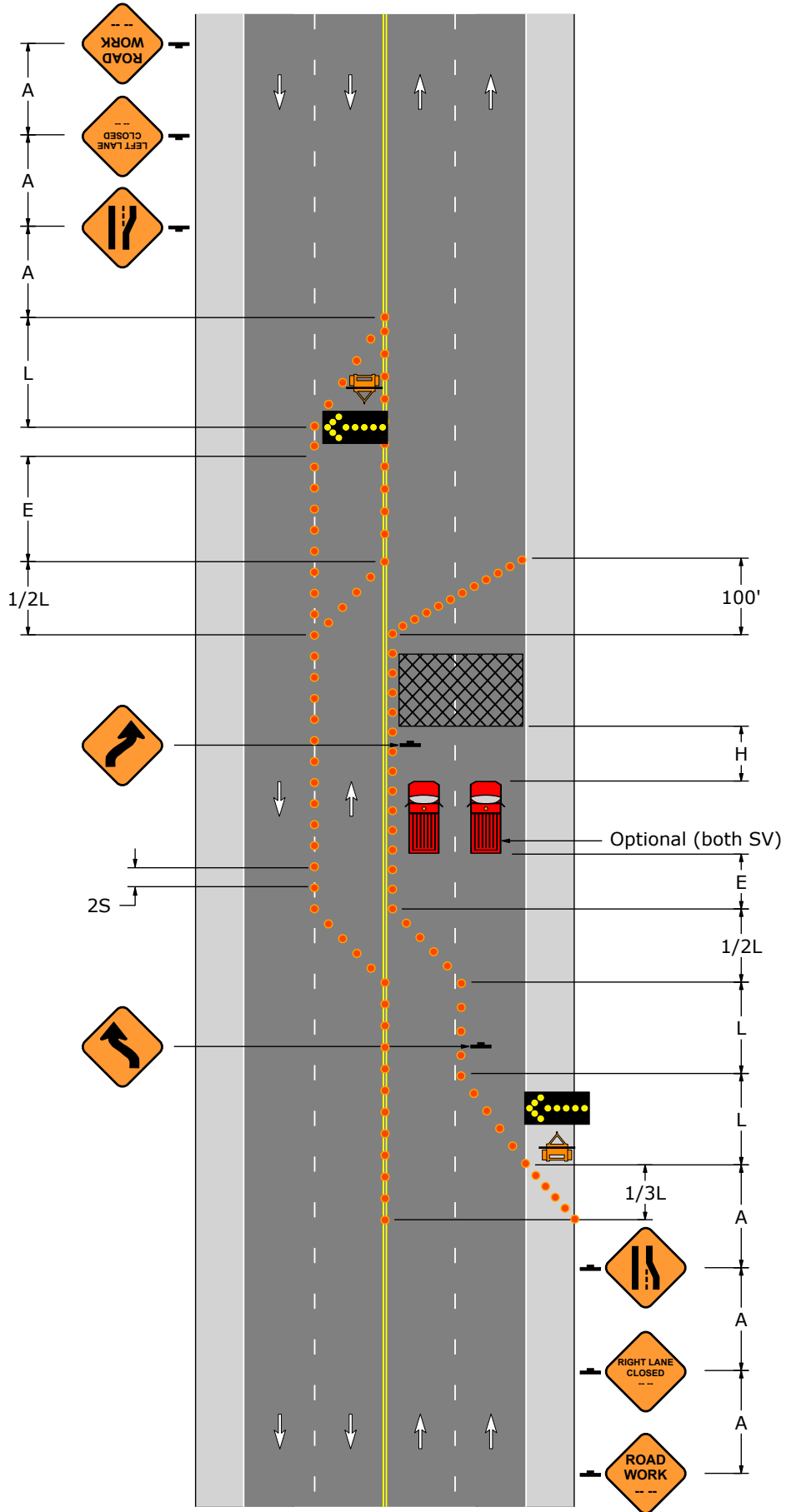
1. When a shadow vehicle is not used, distance E is measured from the end of the taper to the beginning of the work space.
2. If shadow vehicles are used, use two side-by-side as shown on the PATA drawing.

Signs						
						
W20-1	W4-2L	W4-2R	W20-5L	W20-5R	W1-4L	W1-4R

Sign Spacing, Channelizing Device Spacing, Buffer Space, and Roll Ahead Space					
Speed	Channelizing Devices Spacing	Sign Spacing		Buffer Space	Roll Ahead Space
		Urban	Rural		
S (MPH)	2S (Feet)	A (Feet)	A (Feet)	E (Feet)	H (Feet)
25	50	100 - 200	500 - 800	155	150
30	60	100 - 200	500 - 800	200	150
35	70	100 - 200	500 - 800	250	150
40	80	350 - 500	500 - 800	305	150
45	90	350 - 500	500 - 800	360	150
50	100	350 - 500	500 - 800	425	250
55	110	350 - 500	500 - 800	495	250




Taper Lengths and Minimum Number of Channelizing Devices								
Speed	Merging Taper: L		Shifting Taper: 1/2L		Shoulder Taper: 1/3L		50' Per Lane Taper	
S (MPH)	Length (Feet)	Minimum Number Of Devices	Length (Feet)	Minimum Number Of Devices	Length (Feet)	Minimum Number Of Devices	Length (Feet)	Minimum Number Of Devices
25	125	6	65	6	45	6	50	6
30	180	7	90	6	60	6	50	6
35	245	8	125	6	85	6	50	6
40	320	9	160	6	110	6	50	6
45	540	13	270	7	180	6	50	6
50	600	13	300	7	200	6	50	6
55	660	13	330	7	220	6	50	6

PATA 124



PATA 125-A

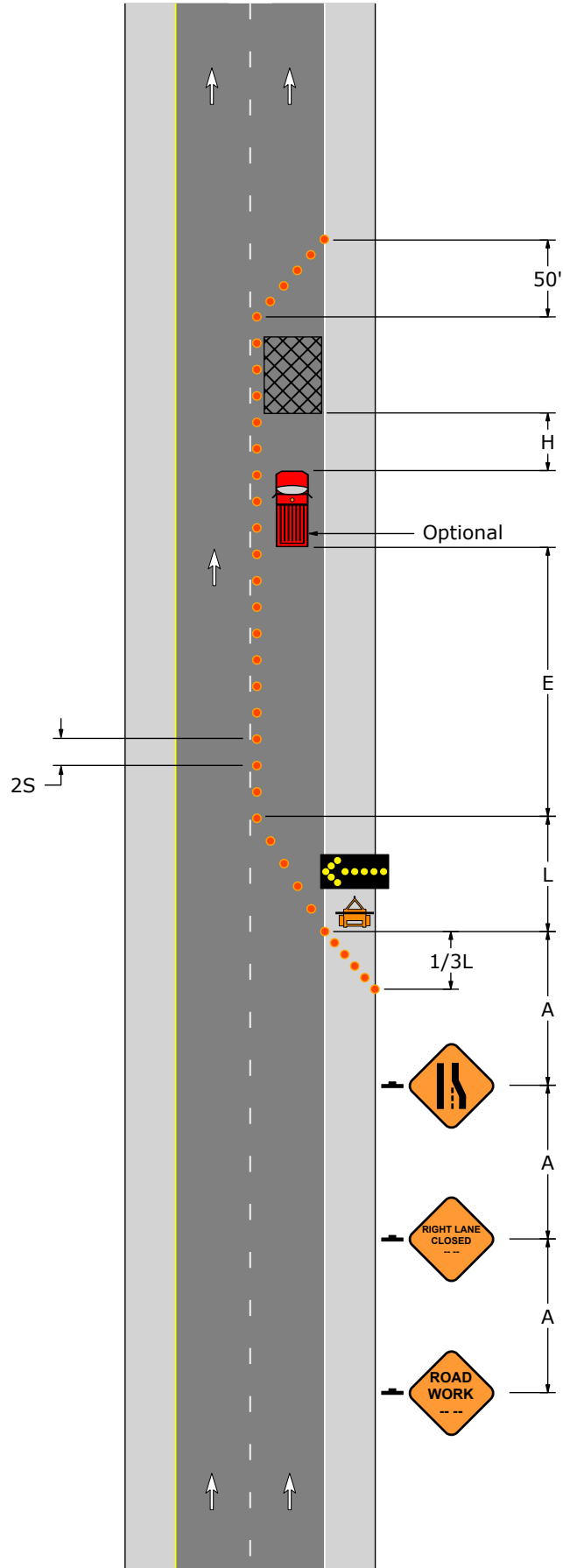
1. When a shadow vehicle is not used, distance E is measured from the end of the taper to the beginning of the work space.

Signs		
		
W20-1	W20-5R	W4-2R

Sign Spacing, Channelizing Device Spacing, Buffer Space, and Roll Ahead Space					
Speed	Channelizing Devices Spacing	Sign Spacing		Buffer Space	Roll Ahead Space
		Urban	Rural		
S (MPH)	2S (Feet)	A (Feet)	A (Feet)	E (Feet)	H (Feet)
25	50	100 - 200	500 - 800	155	150
30	60	100 - 200	500 - 800	200	150
35	70	100 - 200	500 - 800	250	150
40	80	350 - 500	500 - 800	305	150
45	90	350 - 500	500 - 800	360	150
50	100	350 - 500	500 - 800	425	250
55	110	350 - 500	500 - 800	495	250




Taper Lengths and Minimum Number of Channelizing Devices						
Speed	Merging Taper: L		Shoulder Taper: 1/3L		50' Per Lane Taper	
S (MPH)	Length (Feet)	Minimum Number Of Devices	Length (Feet)	Minimum Number Of Devices	Length (Feet)	Minimum Number Of Devices
25	125	6	45	6	50	6
30	180	7	60	6	50	6
35	245	8	85	6	50	6
40	320	9	110	6	50	6
45	540	13	180	6	50	6
50	600	13	200	6	50	6
55	660	13	220	7	50	6

PATA 125-A



PATA 125-B

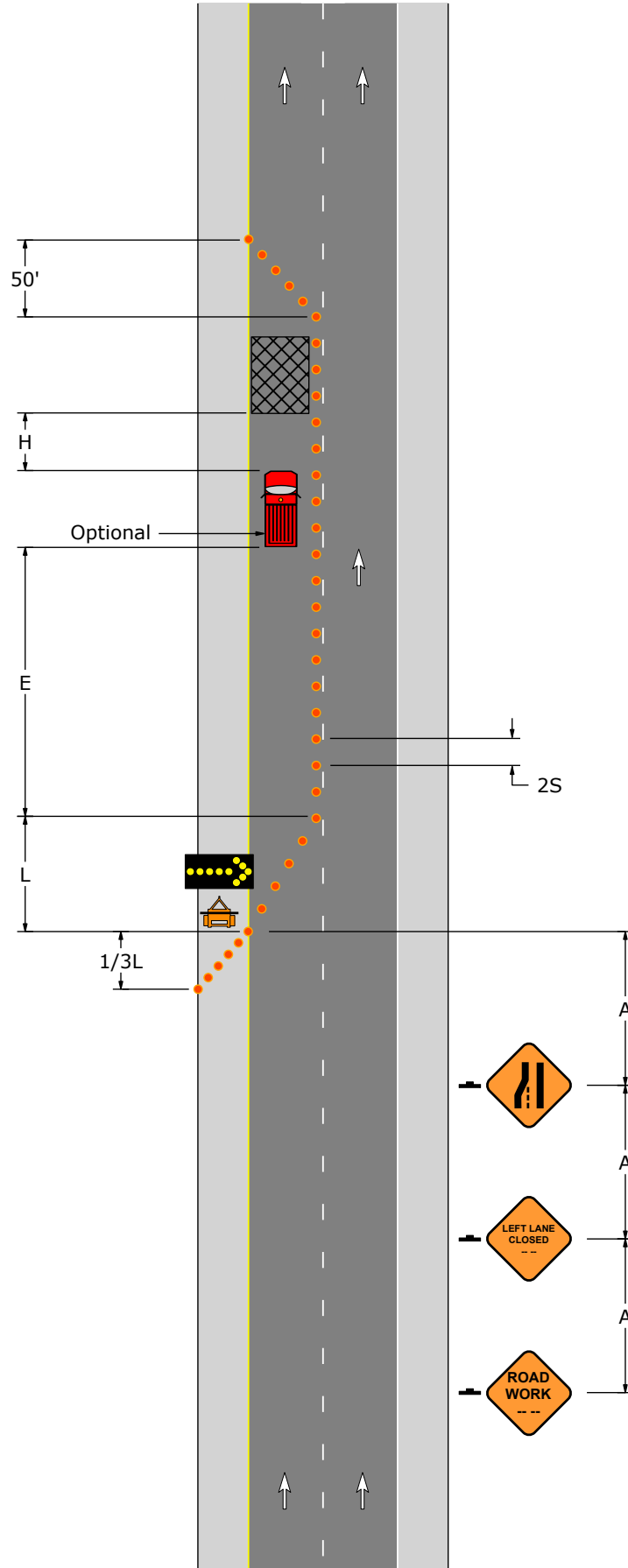
1. When a shadow vehicle is not used, distance E is measured from the end of the taper to the beginning of the work space.

Signs		
		
W20-1	W20-5L	W4-2L

Sign Spacing, Channelizing Device Spacing, Buffer Space, and Roll Ahead Space					
Speed	Channelizing Devices Spacing	Sign Spacing		Buffer Space	Roll Ahead Space
		Urban	Rural		
S (MPH)	2S (Feet)	A (Feet)	A (Feet)	E (Feet)	H (Feet)
25	50	100 - 200	500 - 800	155	150
30	60	100 - 200	500 - 800	200	150
35	70	100 - 200	500 - 800	250	150
40	80	350 - 500	500 - 800	305	150
45	90	350 - 500	500 - 800	360	150
50	100	350 - 500	500 - 800	425	250
55	110	350 - 500	500 - 800	495	250





Taper Lengths and Minimum Number of Channelizing Devices						
Speed	Merging Taper: L		Shoulder Taper: 1/3L		50' Per Lane Taper	
S (MPH)	Length (Feet)	Minimum Number Of Devices	Length (Feet)	Minimum Number Of Devices	Length (Feet)	Minimum Number Of Devices
25	125	6	45	6	50	6
30	180	7	60	6	50	6
35	245	8	85	6	50	6
40	320	9	110	6	50	6
45	540	13	180	6	50	6
50	600	13	200	6	50	6
55	660	13	220	7	50	6

PATA 125-B



PATA 126-A

1. Calculate taper lengths by using the regulatory speed limit (S) and appropriate offset width (W) in formulas shown below.
2. Provide a 10' minimum lane width for traffic, which may include the shoulder if the shoulder is paved, in good condition and free from road debris.
3. Downstream taper length is 50' per lane plus the length required until the longitudinal devices are met.
4. When a shadow vehicle is not used, distance E is measured from the end of the taper to the beginning of the work space.

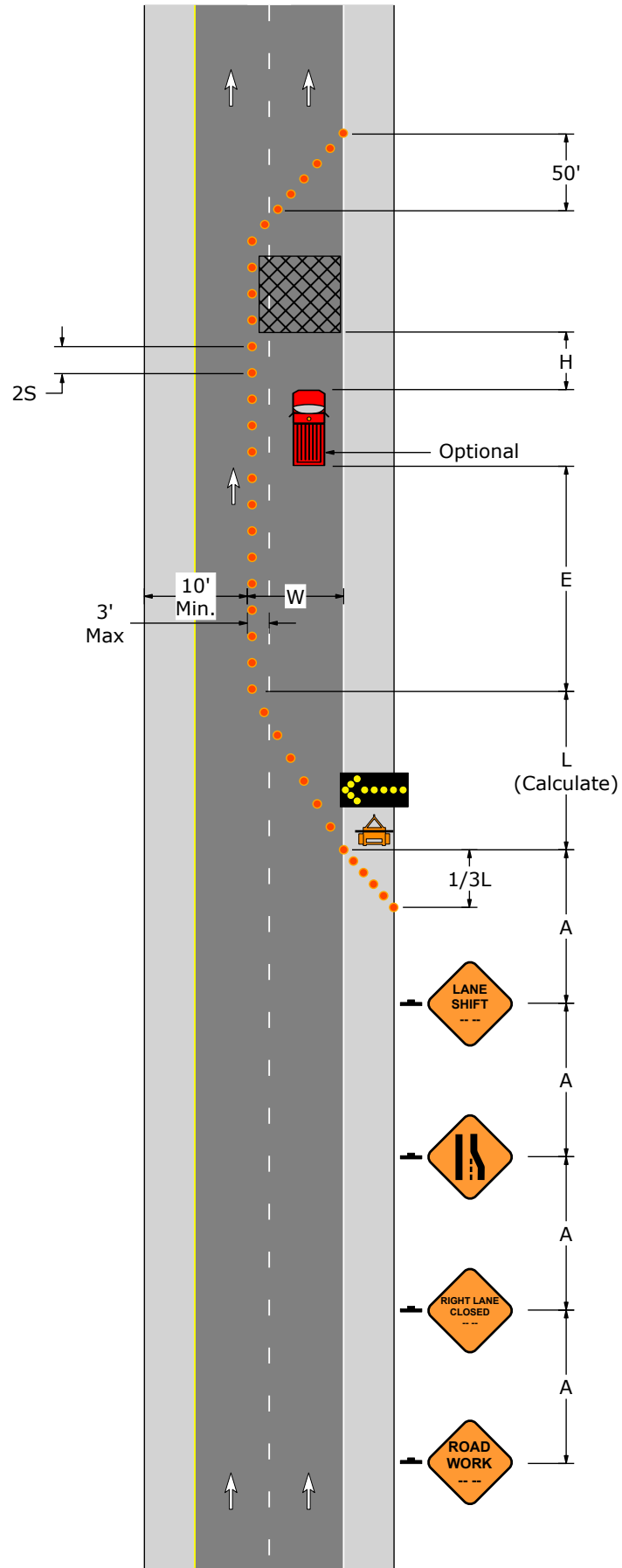
Signs			
			
W20-1	W20-5R	W4-2R	W5-5

Sign Spacing, Channelizing Device Spacing, Buffer Space, and Roll Ahead Space					
Speed	Channelizing Devices Spacing	Sign Spacing		Buffer Space	Roll Ahead Space
		Urban	Rural		
S (MPH)	2S (Feet)	A (Feet)	A (Feet)	E (Feet)	H (Feet)
25	50	100 - 200	500 - 800	155	150
30	60	100 - 200	500 - 800	200	150
35	70	100 - 200	500 - 800	250	150
40	80	350 - 500	500 - 800	305	150
45	90	350 - 500	500 - 800	360	150
50	100	350 - 500	500 - 800	425	250
55	110	350 - 500	500 - 800	495	250

Taper Lengths and Minimum Number of Channelizing Devices						
Speed	Merging Taper: L		Shoulder Taper: 1/3L		50' Per Lane Taper	
S (MPH)	Length (Feet)	Minimum Number Of Devices	Length (Feet)	Minimum Number Of Devices	Length (Feet)	Minimum Number Of Devices
25	Calculate	6	45	6	50	6
30	Calculate	7	60	6	50	6
35	Calculate	8	85	6	50	6
40	Calculate	9	110	6	50	6
45	Calculate	13	180	6	50	6
50	Calculate	13	200	6	50	6
55	Calculate	13	220	7	50	6





* Taper Length Formulas	
If the speed limit is 40 MPH or less $L = \frac{WS^2}{60}$	If the speed limit is 45 MPH or more $L = WS$
S = Regulatory Speed Limit (MPH) W = Width of Offset (feet) L = Length of Taper (feet)	

PATA 126-A



PATA 126-B

1. Calculate taper lengths by using the regulatory speed limit (S) and appropriate offset width (W) in formulas shown below.
2. Provide a 10' minimum lane width for traffic, which may include the shoulder if the shoulder is paved, in good condition and free from road debris.
3. Downstream taper length is 50' per lane plus the length required until the longitudinal devices are met.
4. When a shadow vehicle is not used, distance E is measured from the end of the taper to the beginning of the work space.

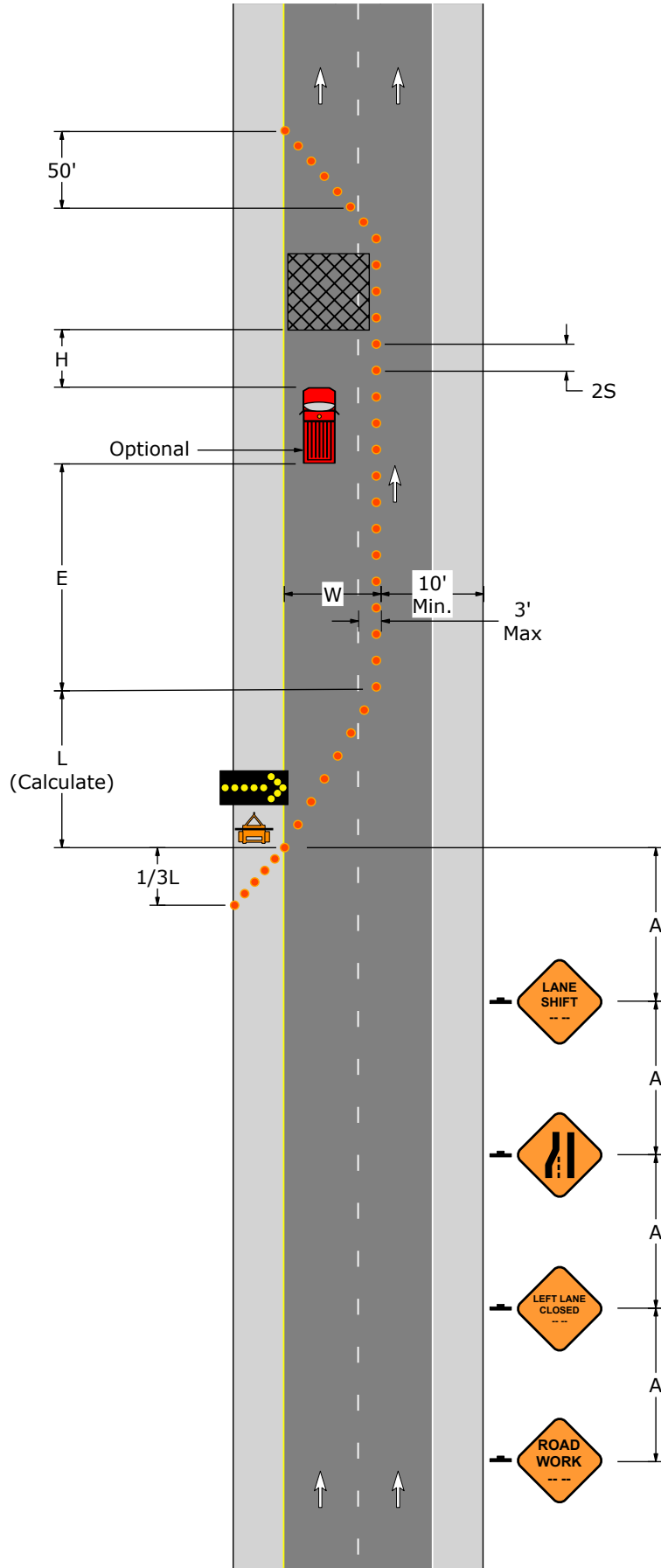
Signs			
			
W20-1	W20-5L	W4-2L	W5-5

Sign Spacing, Channelizing Device Spacing, Buffer Space, and Roll Ahead Space					
Speed	Channelizing Devices Spacing	Sign Spacing		Buffer Space	Roll Ahead Space
		Urban	Rural		
S (MPH)	2S (Feet)	A (Feet)	A (Feet)	E (Feet)	H (Feet)
25	50	100 - 200	500 - 800	155	150
30	60	100 - 200	500 - 800	200	150
35	70	100 - 200	500 - 800	250	150
40	80	350 - 500	500 - 800	305	150
45	90	350 - 500	500 - 800	360	150
50	100	350 - 500	500 - 800	425	250
55	110	350 - 500	500 - 800	495	250

Taper Lengths and Minimum Number of Channelizing Devices						
Speed	Merging Taper: L		Shoulder Taper: 1/3L		50' Per Lane Taper	
S (MPH)	Length (Feet)	Minimum Number Of Devices	Length (Feet)	Minimum Number Of Devices	Length (Feet)	Minimum Number Of Devices
25	Calculate	6	45	6	50	6
30	Calculate	7	60	6	50	6
35	Calculate	8	85	6	50	6
40	Calculate	9	110	6	50	6
45	Calculate	13	180	6	50	6
50	Calculate	13	200	6	50	6
55	Calculate	13	220	7	50	6




* Taper Length Formulas	
If the speed limit is 40 MPH or less $L = \frac{WS^2}{60}$	If the speed limit is 45 MPH or more $L = WS$
S = Regulatory Speed Limit (MPH) W = Width of Offset (feet) L = Length of Taper (feet)	

PATA 126-B



PATA 127-A

1. When a shadow vehicle is not used, distance E is measured from the end of the taper to the beginning of the work space.
2. If shadow vehicles are used, use two side-by-side as shown on the PATA drawing.




Signs		
		
W20-1	W20-5AR	W4-2R

Sign Spacing, Channelizing Device Spacing, Buffer Space, and Roll Ahead Space					
Speed	Channelizing Devices Spacing	Sign Spacing		Buffer Space	Roll Ahead Space
		Urban	Rural		
S (MPH)	2S (Feet)	A (Feet)	A (Feet)	E (Feet)	H (Feet)
25	50	100 - 200	500 - 800	155	150
30	60	100 - 200	500 - 800	200	150
35	70	100 - 200	500 - 800	250	150
40	80	350 - 500	500 - 800	305	150
45	90	350 - 500	500 - 800	360	150
50	100	350 - 500	500 - 800	425	250
55	110	350 - 500	500 - 800	495	250

Taper Lengths and Minimum Number of Channelizing Devices						
Speed	Merging Taper: L		Shoulder Taper: 1/3L		50' Per Lane Taper	
S (MPH)	Length (Feet)	Minimum Number Of Devices	Length (Feet)	Minimum Number Of Devices	Length (Feet)	Minimum Number Of Devices
25	125	6	45	6	50	6
30	180	7	60	6	50	6
35	245	8	85	6	50	6
40	320	9	110	6	50	6
45	540	13	180	6	50	6
50	600	13	200	6	50	6
55	660	13	220	7	50	6

PATA 127-B

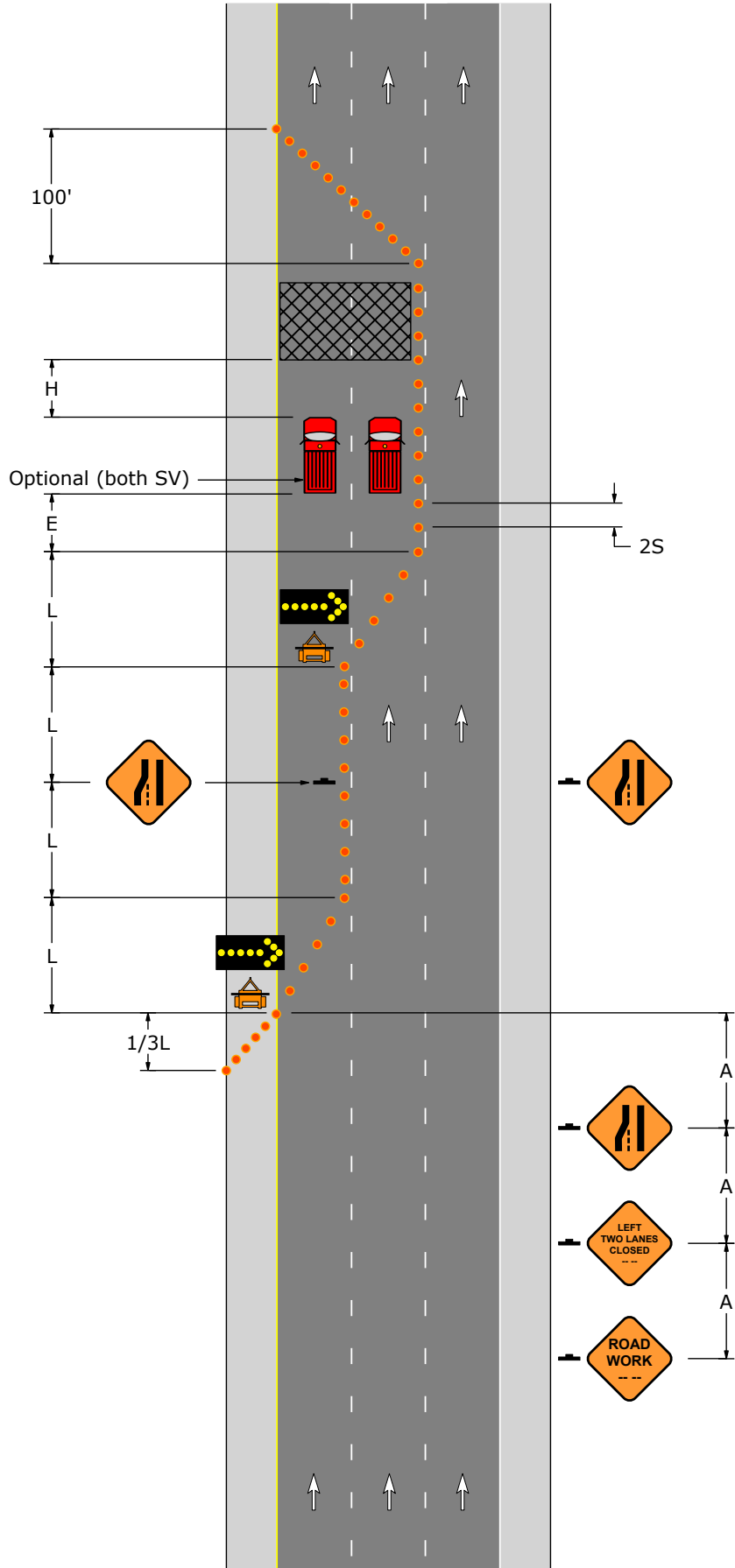
1. When a shadow vehicle is not used, distance E is measured from the end of the taper to the beginning of the work space.
2. If shadow vehicles are used, use two side-by-side as shown on the PATA drawing.

Signs		
		
W20-1	W20-5AL	W4-2L

Sign Spacing, Channelizing Device Spacing, Buffer Space, and Roll Ahead Space					
Speed	Channelizing Devices Spacing	Sign Spacing		Buffer Space	Roll Ahead Space
		Urban	Rural		
S (MPH)	2S (Feet)	A (Feet)	A (Feet)	E (Feet)	H (Feet)
25	50	100 - 200	500 - 800	155	150
30	60	100 - 200	500 - 800	200	150
35	70	100 - 200	500 - 800	250	150
40	80	350 - 500	500 - 800	305	150
45	90	350 - 500	500 - 800	360	150
50	100	350 - 500	500 - 800	425	250
55	110	350 - 500	500 - 800	495	250




Taper Lengths and Minimum Number of Channelizing Devices						
Speed	Merging Taper: L		Shoulder Taper: 1/3L		50' Per Lane Taper	
S (MPH)	Length (Feet)	Minimum Number Of Devices	Length (Feet)	Minimum Number Of Devices	Length (Feet)	Minimum Number Of Devices
25	125	6	45	6	50	6
30	180	7	60	6	50	6
35	245	8	85	6	50	6
40	320	9	110	6	50	6
45	540	13	180	6	50	6
50	600	13	200	6	50	6
55	660	13	220	7	50	6

PATA 127-B

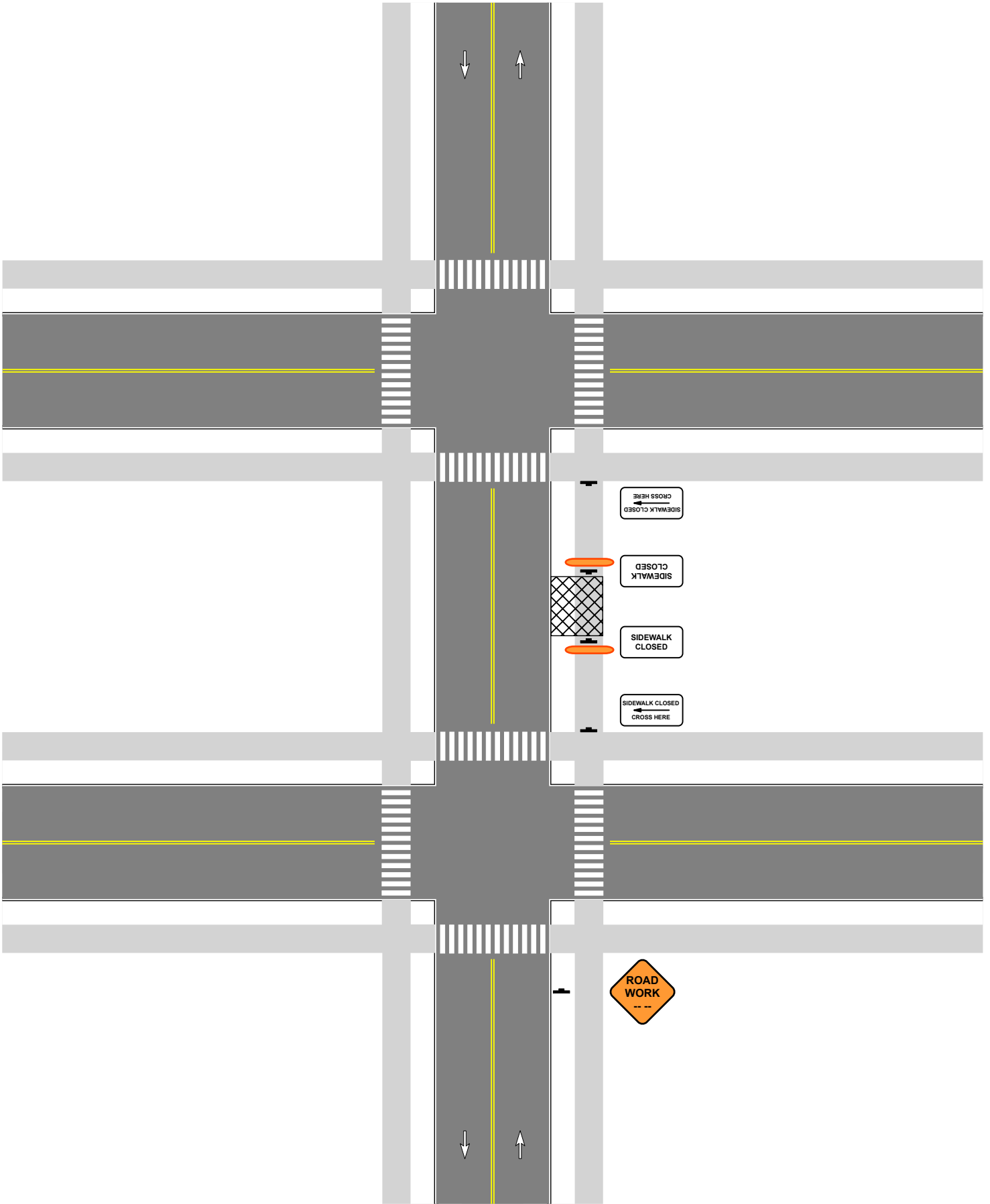


PATA 128

1. When crosswalks or other pedestrian facilities are closed or relocated, temporary facilities shall be detectable and shall include accessibility features consistent with the features present in the existing pedestrian facility.
2. Approved pedestrian barricades or channelizing devices must be placed at each closure to protect pedestrians from construction activities, drop-offs, and vehicular traffic. The pedestrian barriers or channelizing devices must be continuous, stable and non-flexible and consist of a wall, fence, or enclosures specified in the MUTCD, Sections 6F.63, 6F.68 and 6F.71 with detectable, continuous bottom edge 6 inches maximum height above the walkway surface. Support members may not protrude into the useable sidewalk. Sidewalk barriers shall be detectable by blind pedestrians or those who have low vision. Plastic tape, movable cones, and print signs at a sidewalk excavation will not generally provide adequate notice or protection.

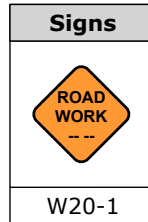
Signs		
		
W20-1	R9-9	R9-11a

PATA 128



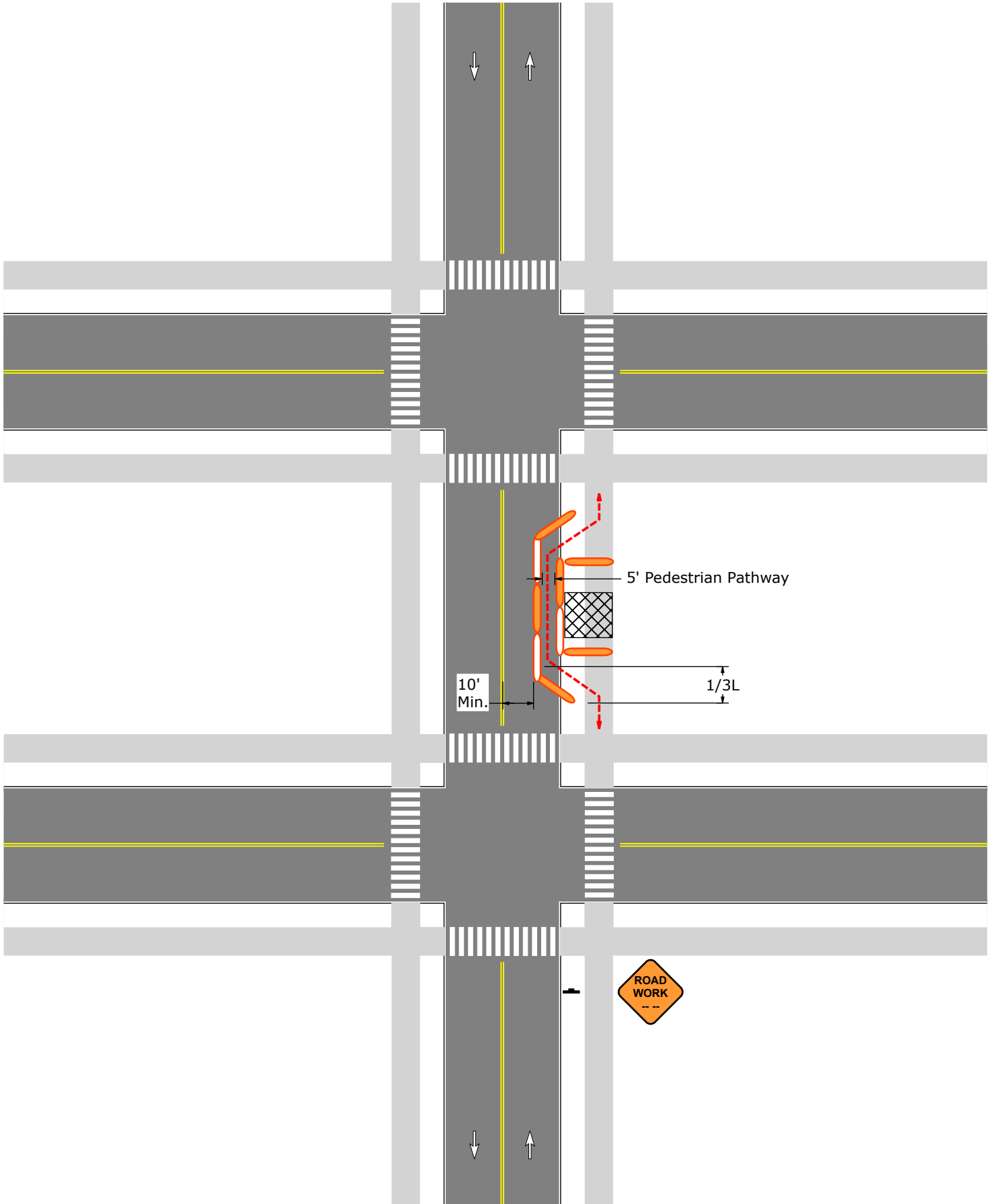
PATA 129

1. When crosswalks or other pedestrian facilities are closed or relocated, temporary facilities shall be detectable and shall include accessibility features consistent with the features present in the existing pedestrian facility.
2. Use channelizing devices to separate and maintain temporary pedestrian walkway while sidewalk is closed. Where high speeds are anticipated, a temporary traffic barrier with appropriate end treatments should be used to separate the temporary walkways from vehicular traffic.
3. Other devices, such as lane closure signing or ROAD NARROWS signs, may be used to control vehicular traffic.
4. When it is not possible to maintain a minimum width of 60" throughout the entire length of the pedestrian pathway, a 60"x60" passing space should be provided at least every 200' to allow individuals in wheelchairs to pass. A minimum 48" wide accessible path shall be maintained for the length of sidewalk diversion. Temporary curb ramp access is required if pedestrian curb ramps exist at the nearest intersection.
5. Approved pedestrian barricades or channelizing devices must be placed at each closure to protect pedestrians from construction activities, drop-offs, and vehicular traffic. The pedestrian barriers or channelizing devices must be continuous, stable and non-flexible and consist of a wall, fence, or enclosures specified in MUTCD Sections 6F.63, 6F.68 and 6F.71 with detectable, continuous bottom edge 6 inches maximum height above the walkway surface. Support members may not protrude into the useable sidewalk. Sidewalk barriers shall be detectable by blind pedestrians or those who have low vision. Plastic tape, movable cones, and print signs at a sidewalk excavation will not generally provide adequate notice or protection.










Taper Lengths and Minimum Number of Channelizing Devices		
Speed	1/3L Taper	
S (MPH)	Length (Feet)	Minimum Number Of Devices
25	45	6
30	60	6
35	85	6
40	110	6
45	180	6
50	200	6
55	220	6

PATA 129







PATA 130

1. When crosswalks or other pedestrian facilities are closed or relocated and there is not an alternate marked crossing within 300', an engineering and traffic study is required to determine the appropriate location of a temporary pedestrian crossing. PennDOT approval shall be obtained prior to installing a midblock crosswalk. Pedestrian crossings shall be detectable and include accessibility features (curb ramps, landing areas, etc.) consistent with the features present in the existing pedestrian facility.
2. Parking is not permitted within 75' of a midblock crosswalk, unless a 6' to 8' curb extension is in place to improve pedestrian visibility.
3. Pedestrian traffic signal displays controlling closed crosswalks shall be covered and deactivated.
4. The width of the existing pedestrian facility should be provided for the temporary facility if practical. TTC devices and other construction materials and features should not intrude into the usable width of the sidewalk, temporary pathway or other pedestrian facility. When it is not possible to maintain a minimum width of 60" throughout the entire length of the pedestrian pathway, a 60"x60" passing space should be provided at least every 200' to allow individuals in wheelchairs to pass.
5. Approved pedestrian barricades or channelizing devices must be placed at each closure to protect pedestrians from construction activities, drop-offs, and vehicular traffic. The pedestrian barriers or channelizing devices must be continuous, stable and non-flexible and consist of a wall, fence, or enclosures specified in the MUTCD, Sections 6F.63, 6F.68 and 6F.71 with detectable, continuous bottom edge 6 inches maximum height above the walkway surface. Support members may not protrude into the useable sidewalk. Sidewalk barriers shall be detectable by blind pedestrians or those who have low vision. Plastic tape, movable cones, and print signs at a sidewalk excavation will not generally provide adequate notice or protection.

Signs						
						
W20-1	W11-2	W16-7P	W16-9P	R9-9	R9-10	R9-11a

PATA 131

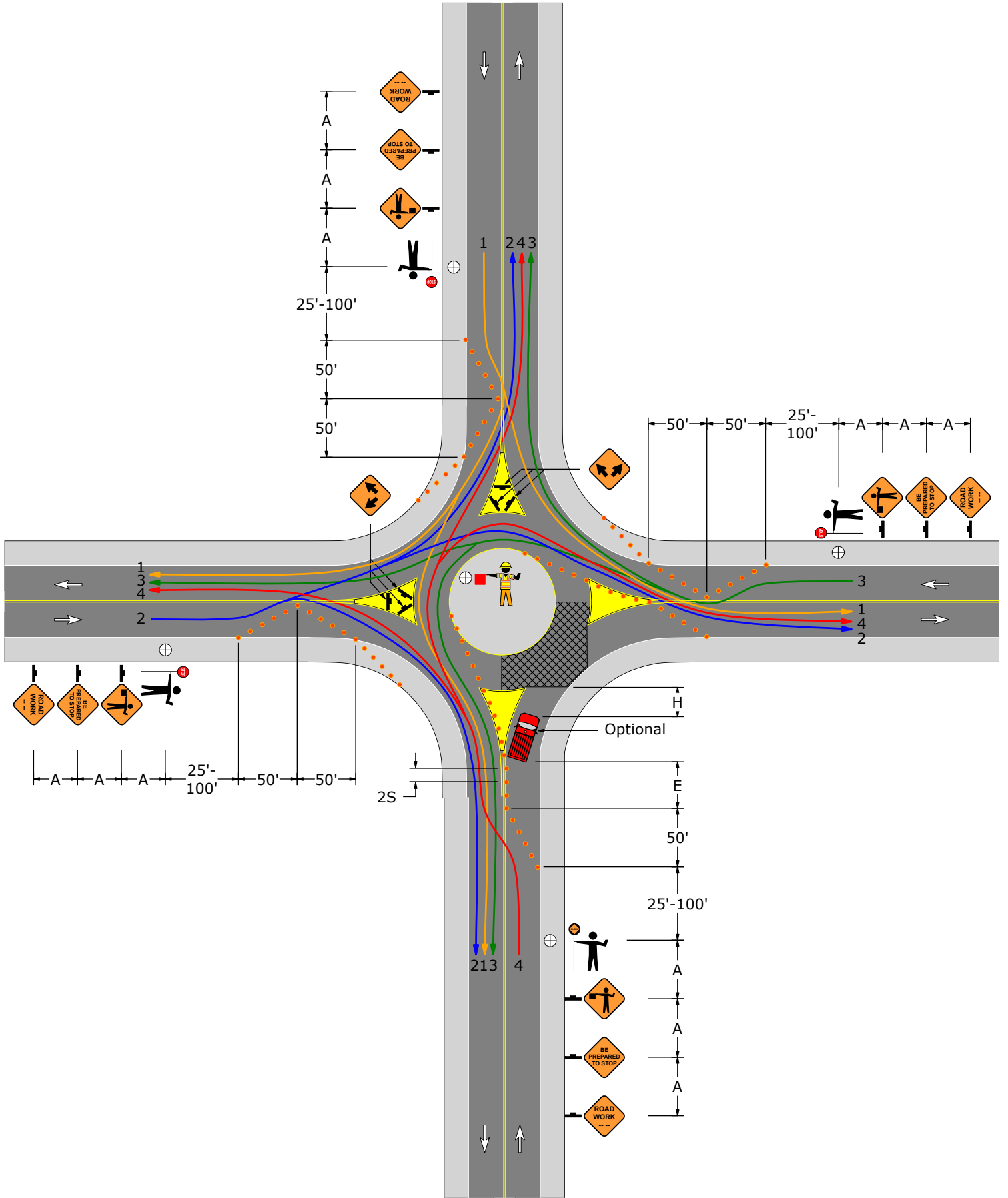
1. This PATA shall be used when the work space prohibits traffic from making a complete circle in a roundabout or traffic circle. It is applicable to every roundabout or traffic circle regardless of the number of roadways entering or exiting the roundabout or traffic circle.
2. Flaggers shall be clearly visible to traffic for a minimum distance of E.
3. Flaggers must control traffic flow so that vehicles from only one approach are permitted to utilize the roundabout or traffic circle at a time. Traffic from all other approaches must be held until traffic is cleared from the TTC zone. The desired traffic flow is depicted on the PATA with a distinct color line for each approach. Flaggers on site must work as a team to create the most safe and efficient traffic flow.
4. When a shadow vehicle is not used, distance E is measured from the end of the taper to the beginning of the work space.
5. The flagger stationed within the roundabout or traffic circle shall move to the most appropriate position to assist whichever flagger is showing the SLOW side of the paddle to approaching traffic.

Signs			
			
W20-1	W3-4	W20-7	W12-1

Sign Spacing, Channelizing Device Spacing, Buffer Space, and Roll Ahead Space					
Speed	Channelizing Devices Spacing	Sign Spacing		Buffer Space	Roll Ahead Space
		Urban	Rural		
S (MPH)	2S (Feet)	A (Feet)	A (Feet)	E (Feet)	H (Feet)
25	50	100 - 200	500 - 800	155	150
30	60	100 - 200	500 - 800	200	150
35	70	100 - 200	500 - 800	250	150
40	80	350 - 500	500 - 800	305	150
45	90	350 - 500	500 - 800	360	150
50	100	350 - 500	500 - 800	425	250
55	110	350 - 500	500 - 800	495	250






Taper Lengths and Minimum Number Of Channelizing Devices		
Speed	50' Per Lane Taper	
S (MPH)	Length (Feet)	Minimum Number Of Devices
25	50	6
30	50	6
35	50	6
40	50	6
45	50	6
50	50	6
55	50	6

PATA 131



PATA 132

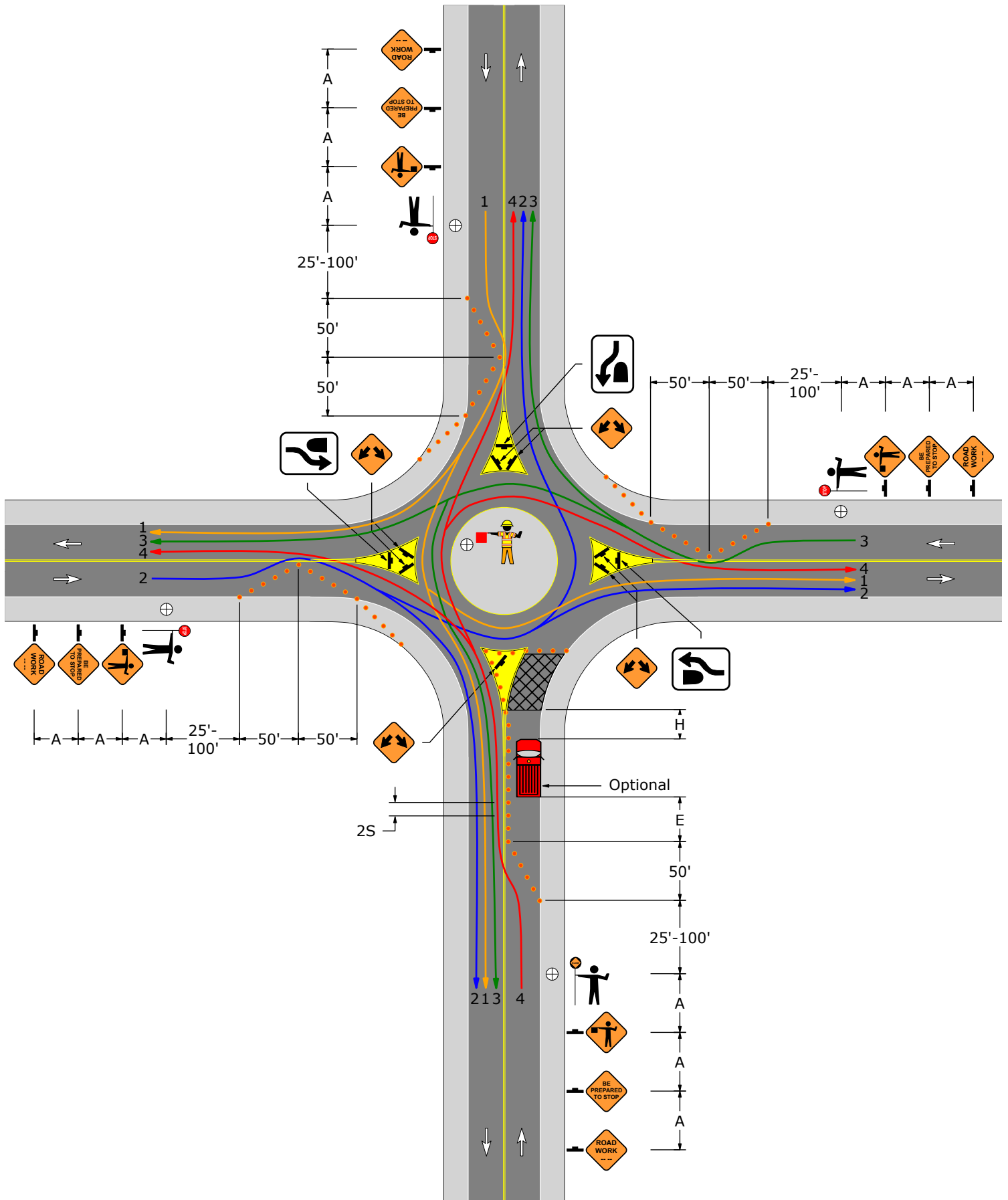
1. This PATA shall be used when the work space prohibits traffic from making a complete circle in a roundabout or traffic circle. It is applicable to every roundabout or traffic circle regardless of the number of roadways entering or exiting the roundabout or traffic circle.
2. Flaggers shall be clearly visible to traffic for a minimum distance of E.
3. Flaggers must control traffic flow so that vehicles from only one approach are permitted to utilize the roundabout or traffic circle at a time. Traffic from all other approaches must be held until traffic is cleared from the TTC zone. The desired traffic flow is depicted on the PATA with a distinct color line for each approach. Flaggers on site must work as a team to create the most safe and efficient traffic flow.
4. When a shadow vehicle is not used, distance E is measured from the end of the taper to the beginning of the work space.
5. The flagger stationed within the roundabout or traffic circle shall move to the most appropriate position to assist whichever flagger is showing the SLOW side of the paddle to approaching traffic.

Signs				
				
W20-1	W3-4	W20-7	W12-1	R4-7

Sign Spacing, Channelizing Device Spacing, Buffer Space, and Roll Ahead Space					
Speed	Channelizing Devices Spacing	Sign Spacing		Buffer Space	Roll Ahead Space
		Urban	Rural		
S (MPH)	2S (Feet)	A (Feet)	A (Feet)	E (Feet)	H (Feet)
25	50	100 - 200	500 - 800	155	150
30	60	100 - 200	500 - 800	200	150
35	70	100 - 200	500 - 800	250	150
40	80	350 - 500	500 - 800	305	150
45	90	350 - 500	500 - 800	360	150
50	100	350 - 500	500 - 800	425	250
55	110	350 - 500	500 - 800	495	250






Taper Lengths and Minimum Number Of Channelizing Devices		
Speed	50' Per Lane Taper	
S (MPH)	Length (Feet)	Minimum Number Of Devices
25	50	6
30	50	6
35	50	6
40	50	6
45	50	6
50	50	6
55	50	6

PATA 132



PATA 133

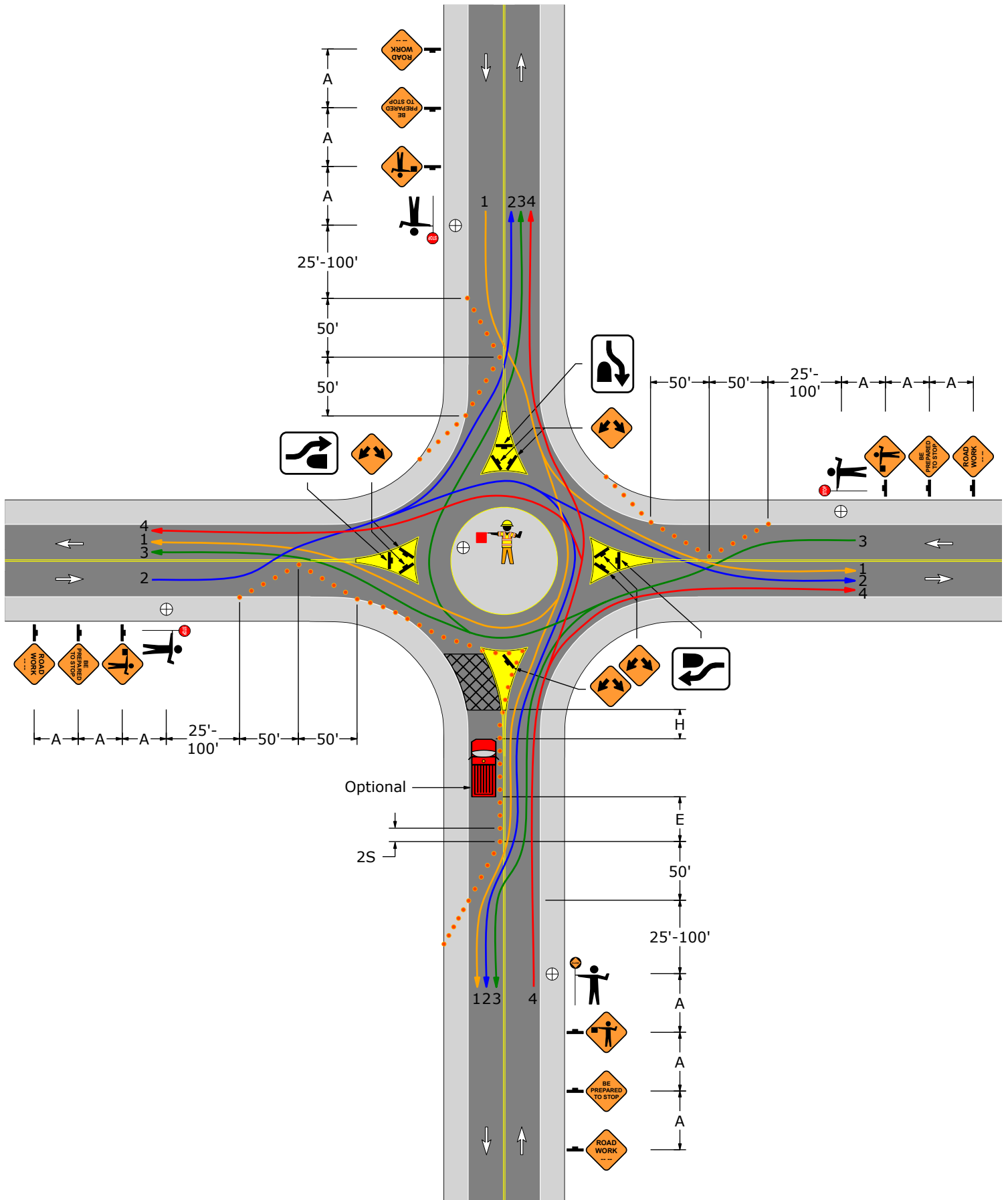
1. This PATA shall be used when the work space prohibits traffic from making a complete circle in a roundabout or traffic circle. It is applicable to every roundabout or traffic circle regardless of the number of roadways entering or exiting the roundabout or traffic circle.
2. Flaggers shall be clearly visible to traffic for a minimum distance of E.
4. Flaggers must control traffic flow so that vehicles from only one approach are permitted to utilize the roundabout or traffic circle at a time. Traffic from all other approaches must be held until traffic is cleared from the TTC zone. The desired traffic flow is depicted on the PATA with a distinct color line for each approach. Flaggers on site must work as a team to create the most safe and efficient traffic flow.
5. When a shadow vehicle is not used, distance E is measured from the end of the taper to the beginning of the work space.
6. The flagger stationed within the roundabout or traffic circle shall move to the most appropriate position to assist whichever flagger is showing the SLOW side of the paddle to approaching traffic.

Signs				
				
W20-1	W3-4	W20-7	W12-1	R4-7

Sign Spacing, Channelizing Device Spacing, Buffer Space, and Roll Ahead Space					
Speed	Channelizing Devices Spacing	Sign Spacing		Buffer Space	Roll Ahead Space
		Urban	Rural		
S (MPH)	2S (Feet)	A (Feet)	A (Feet)	E (Feet)	H (Feet)
25	50	100 - 200	500 - 800	155	150
30	60	100 - 200	500 - 800	200	150
35	70	100 - 200	500 - 800	250	150
40	80	350 - 500	500 - 800	305	150
45	90	350 - 500	500 - 800	360	150
50	100	350 - 500	500 - 800	425	250
55	110	350 - 500	500 - 800	495	250

Taper Lengths and Minimum Number Of Channelizing Devices		
Speed	50' Per Lane Taper	
S (MPH)	Length (Feet)	Minimum Number Of Devices
25	50	6
30	50	6
35	50	6
40	50	6
45	50	6
50	50	6
55	50	6

PATA 133





Blank Page

Conventional Highways

Long-Term Stationary Operations
(PATA 200 Series)

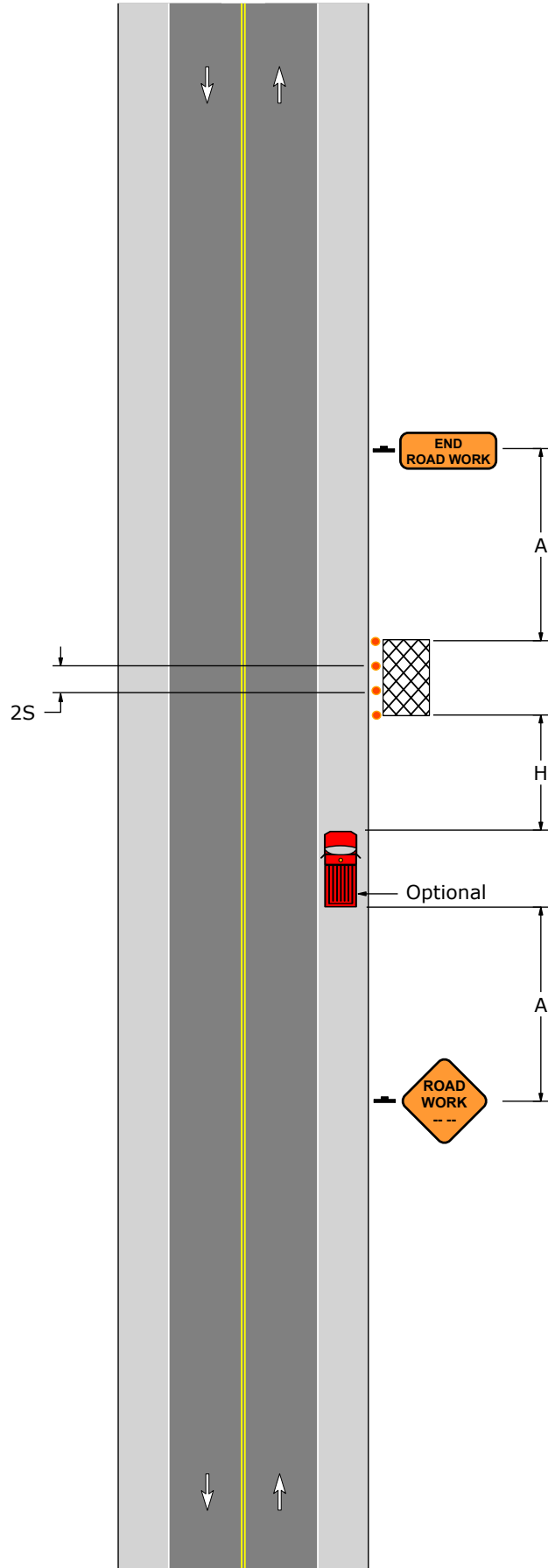
PATA 201-A

1. TTC devices are not required if the work space is outside the highway right-of-way, behind barrier, more than 2' behind curb, or 15' or more from the edge of the roadway.
2. When a shadow vehicle is not used, distance A is measured from the ROAD WORK sign location to beginning of the work space.

Signs	
	
W20-1	G20-2



Sign Spacing, Channelizing Device Spacing, and Roll Ahead Space				
Speed	Channelizing Devices Spacing	Sign Spacing		Roll Ahead Space
		Urban	Rural	
S (MPH)	2S (Feet)	A (Feet)	A (Feet)	H (Feet)
25	50	100 - 200	500 - 800	150
30	60	100 - 200	500 - 800	150
35	70	100 - 200	500 - 800	150
40	80	350 - 500	500 - 800	150
45	90	350 - 500	500 - 800	150
50	100	350 - 500	500 - 800	250
55	110	350 - 500	500 - 800	250

PATA 201-A



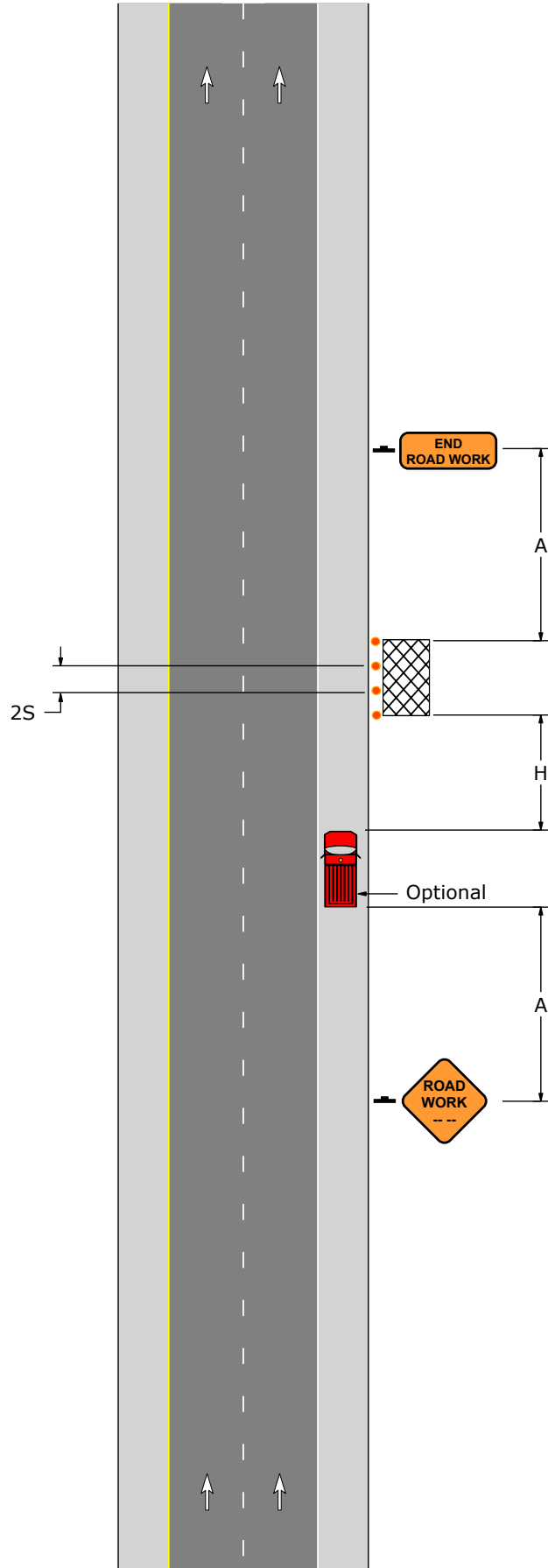
PATA 201-B

1. TTC devices are not required if the work space is outside the highway right-of-way, behind barrier, more than 2' behind curb, or 15' or more from the edge of the roadway.
2. When a shadow vehicle is not used, distance A is measured from the ROAD WORK sign location to beginning of the work space.

Signs	
	
W20-1	G20-2


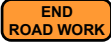
Sign Spacing, Channelizing Device Spacing, and Roll Ahead Space				
Speed	Channelizing Devices Spacing	Sign Spacing		Roll Ahead Space
		Urban	Rural	
S (MPH)	2S (Feet)	A (Feet)	A (Feet)	H (Feet)
25	50	100 - 200	500 - 800	150
30	60	100 - 200	500 - 800	150
35	70	100 - 200	500 - 800	150
40	80	350 - 500	500 - 800	150
45	90	350 - 500	500 - 800	150
50	100	350 - 500	500 - 800	250
55	110	350 - 500	500 - 800	250

PATA 201-B



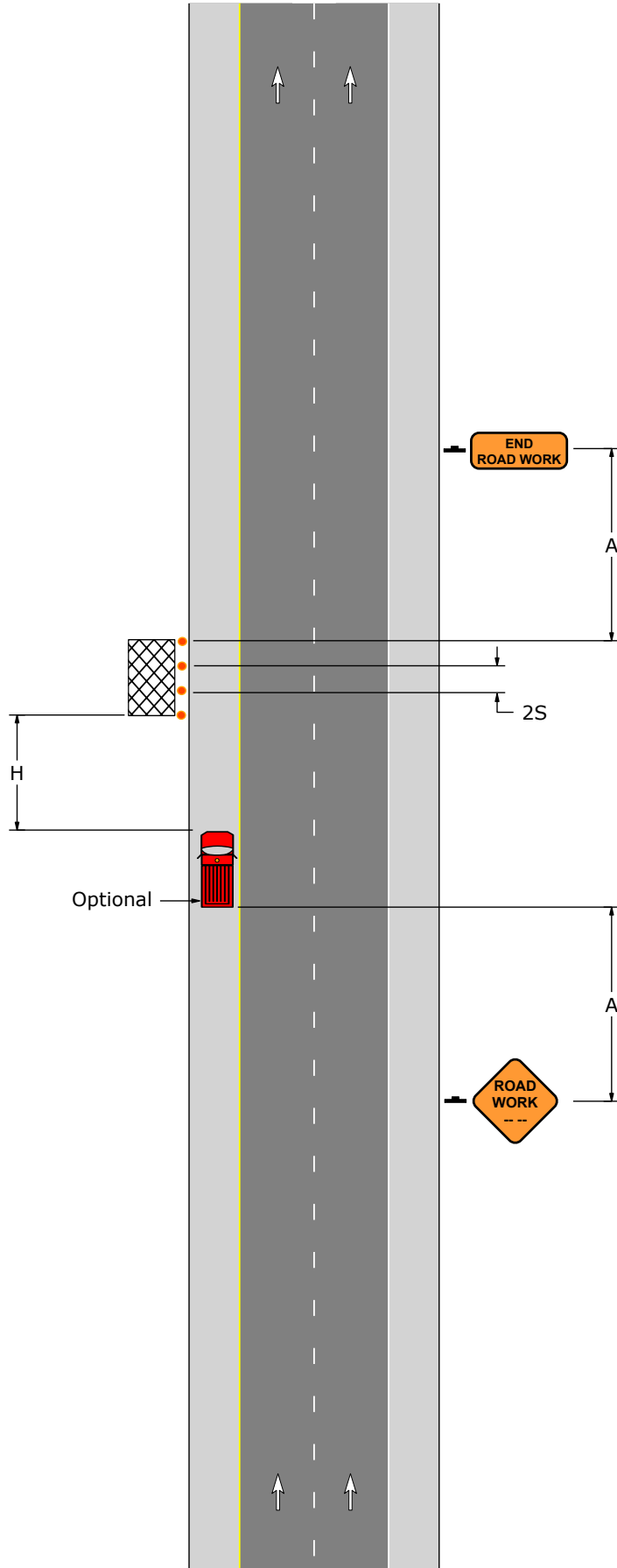
PATA 201-C

1. TTC devices are not required if the work space is outside the highway right-of-way, behind barrier, more than 2' behind curb, or 15' or more from the edge of the roadway.
2. When a shadow vehicle is not used, distance A is measured from the ROAD WORK sign location to beginning of the work space.

Signs	
	
W20-1	G20-2





Sign Spacing, Channelizing Device Spacing, and Roll Ahead Space				
Speed	Channelizing Devices Spacing	Sign Spacing		Roll Ahead Space
		Urban	Rural	
S (MPH)	2S (Feet)	A (Feet)	A (Feet)	H (Feet)
25	50	100 - 200	500 - 800	150
30	60	100 - 200	500 - 800	150
35	70	100 - 200	500 - 800	150
40	80	350 - 500	500 - 800	150
45	90	350 - 500	500 - 800	150
50	100	350 - 500	500 - 800	250
55	110	350 - 500	500 - 800	250

PATA 201-C



PATA 202-A

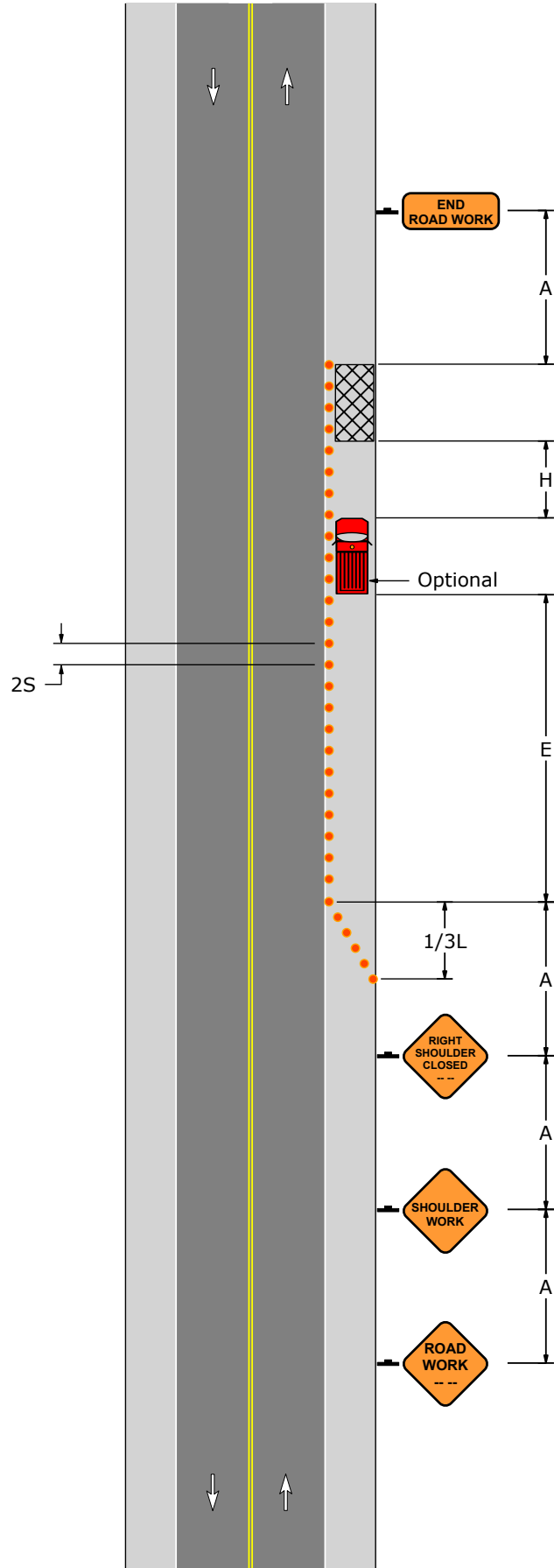
1. TTC devices are not required if the work space is outside the highway right-of-way, behind barrier, more than 2' behind curb, or 15' or more from the edge of the roadway.
2. When a shadow vehicle is not used, distance E is measured from the end of the taper to the beginning of the work space.

Signs			
			
W20-1	W21-5	W21-5BR	G20-2

Sign Spacing, Channelizing Device Spacing, Buffer Space, and Roll Ahead Space					
Speed	Channelizing Devices Spacing	Sign Spacing		Buffer Space	Roll Ahead Space
		Urban	Rural		
S (MPH)	2S (Feet)	A (Feet)	A (Feet)	E (Feet)	H (Feet)
25	50	100 - 200	500 - 800	155	150
30	60	100 - 200	500 - 800	200	150
35	70	100 - 200	500 - 800	250	150
40	80	350 - 500	500 - 800	305	150
45	90	350 - 500	500 - 800	360	150
50	100	350 - 500	500 - 800	425	250
55	110	350 - 500	500 - 800	495	250





Taper Lengths and Minimum Number of Channelizing Devices		
Speed	Shoulder Taper: 1/3L	
S (MPH)	Length (Feet)	Minimum Number Of Devices
25	45	6
30	60	6
35	85	6
40	110	6
45	180	6
50	200	6
55	220	6

PATA 202-A



PATA 202-B

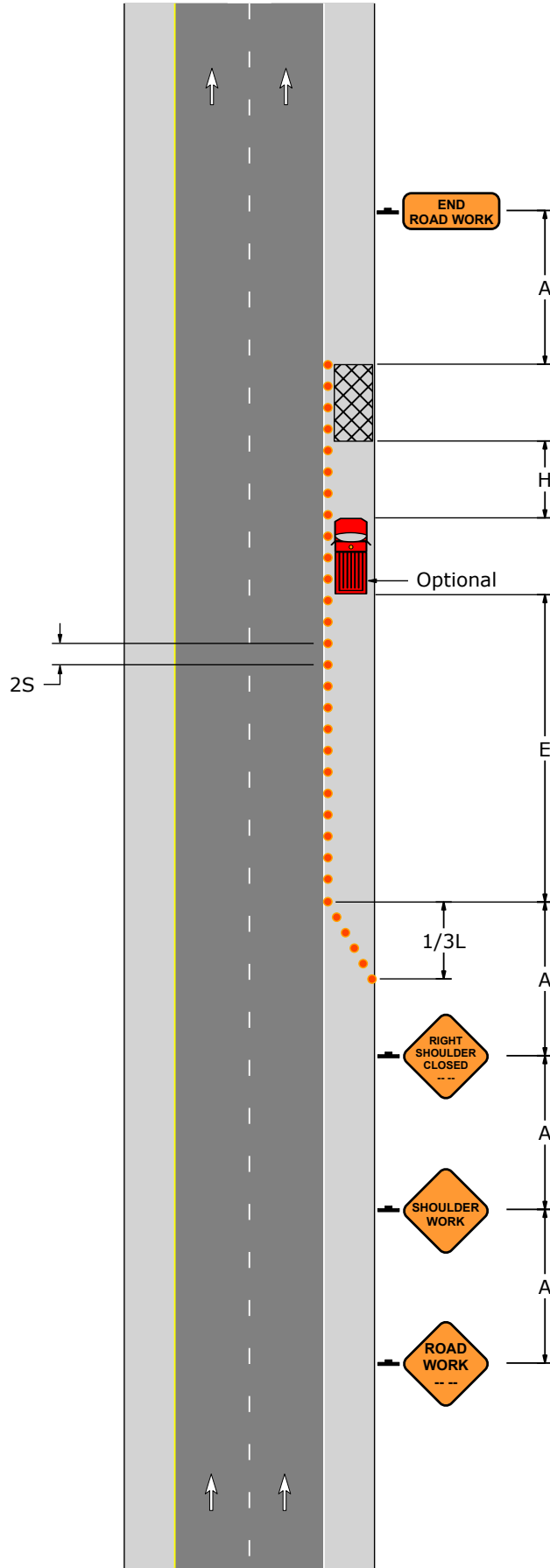
1. TTC devices are not required if the work space is outside the highway right-of-way, behind barrier, more than 2' behind curb, or 15' or more from the edge of the roadway.
2. When a shadow vehicle is not used, distance E is measured from the end of the taper to the beginning of the work space.

Signs			
			
W20-1	W21-5	W21-5BR	G20-2

Sign Spacing, Channelizing Device Spacing, Buffer Space, and Roll Ahead Space					
Speed	Channelizing Devices Spacing	Sign Spacing		Buffer Space	Roll Ahead Space
		Urban	Rural		
S (MPH)	2S (Feet)	A (Feet)	A (Feet)	E (Feet)	H (Feet)
25	50	100 - 200	500 - 800	155	150
30	60	100 - 200	500 - 800	200	150
35	70	100 - 200	500 - 800	250	150
40	80	350 - 500	500 - 800	305	150
45	90	350 - 500	500 - 800	360	150
50	100	350 - 500	500 - 800	425	250
55	110	350 - 500	500 - 800	495	250





Taper Lengths and Minimum Number of Channelizing Devices		
Speed	Shoulder Taper: 1/3L	
S (MPH)	Length (Feet)	Minimum Number Of Devices
25	45	6
30	60	6
35	85	6
40	110	6
45	180	6
50	200	6
55	220	6

PATA 202-B



PATA 202-C

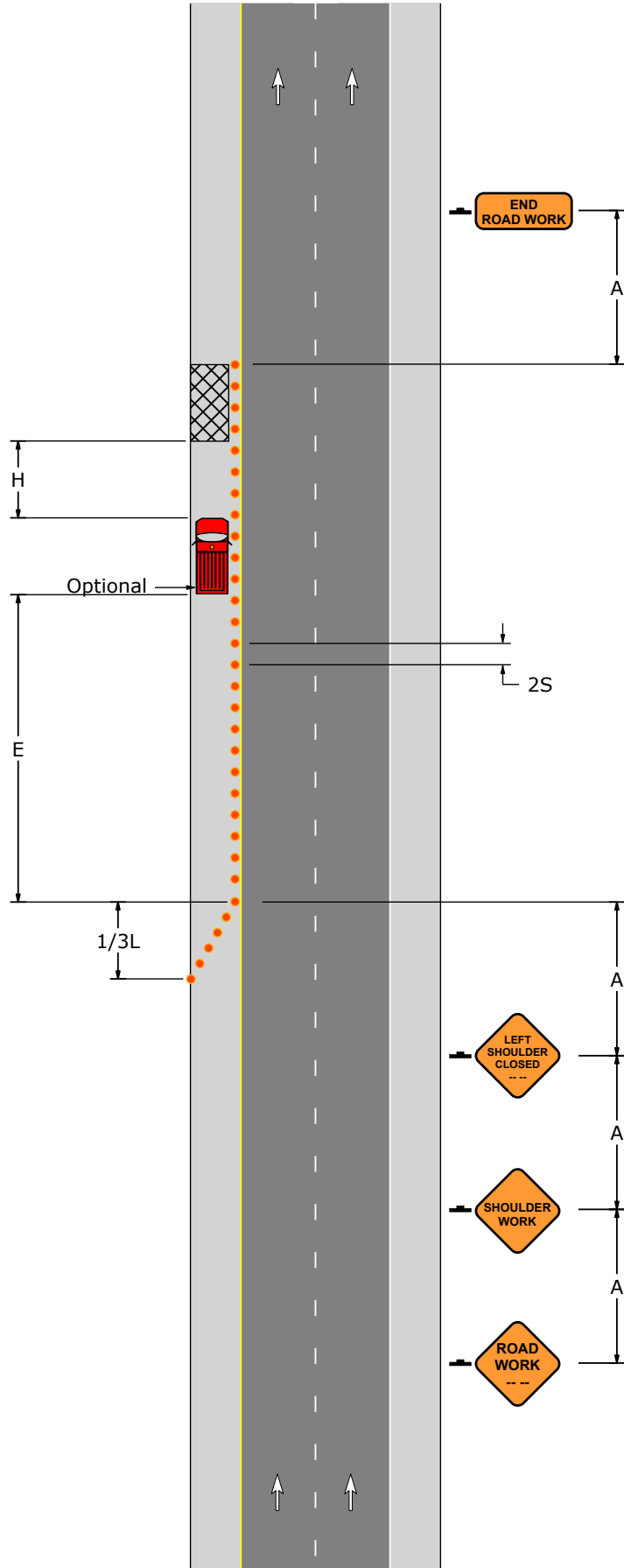
1. TTC devices are not required if the work space is outside the highway right-of-way, behind barrier, more than 2' behind curb, or 15' or more from the edge of the roadway.
2. When a shadow vehicle is not used, distance E is measured from the end of the taper to the beginning of the work space.

Signs			
			
W20-1	W21-5	W21-5BL	G20-2

Sign Spacing, Channelizing Device Spacing, Buffer Space, and Roll Ahead Space					
Speed	Channelizing Devices Spacing	Sign Spacing		Buffer Space	Roll Ahead Space
		Urban	Rural		
S (MPH)	2S (Feet)	A (Feet)	A (Feet)	E (Feet)	H (Feet)
25	50	100 - 200	500 - 800	155	150
30	60	100 - 200	500 - 800	200	150
35	70	100 - 200	500 - 800	250	150
40	80	350 - 500	500 - 800	305	150
45	90	350 - 500	500 - 800	360	150
50	100	350 - 500	500 - 800	425	250
55	110	350 - 500	500 - 800	495	250





Taper Lengths and Minimum Number of Channelizing Devices		
Speed	Shoulder Taper: 1/3L	
S (MPH)	Length (Feet)	Minimum Number Of Devices
25	45	6
30	60	6
35	85	6
40	110	6
45	180	6
50	200	6
55	220	6

PATA 202-C



PATA 203

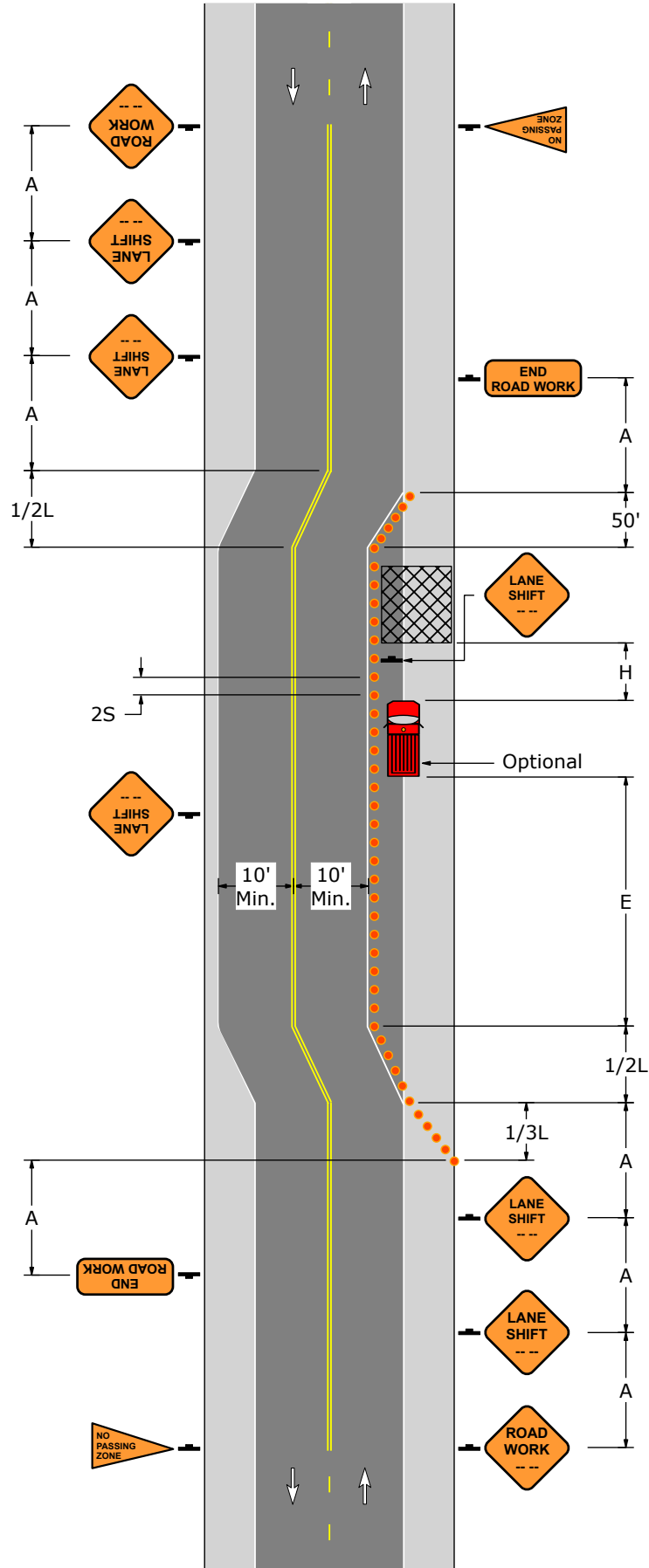
1. Where traffic is required to use a shoulder, it must be a paved shoulder that is in good condition both during the period it is being used by traffic and also after the work is complete.
2. When a shadow vehicle is not used, distance E is measured from the end of the taper to the beginning of the work space.
3. A no passing zone shall be established when an existing passing zone is present. A temporary double yellow pavement marking line shall be installed throughout the entire length of the work zone. Place a NO PASSING ZONE sign at the start of the temporary double yellow pavement marking line (Across from the ROAD WORK sign).

Signs			
			
W20-1	W5-5	W14-3	G20-2

Sign Spacing, Channelizing Device Spacing, Buffer Space, and Roll Ahead Space					
Speed	Channelizing Devices Spacing	Sign Spacing		Buffer Space	Roll Ahead Space
		Urban	Rural		
S (MPH)	2S (Feet)	A (Feet)	A (Feet)	E (Feet)	H (Feet)
25	50	100 - 200	500 - 800	155	150
30	60	100 - 200	500 - 800	200	150
35	70	100 - 200	500 - 800	250	150
40	80	350 - 500	500 - 800	305	150
45	90	350 - 500	500 - 800	360	150
50	100	350 - 500	500 - 800	425	250
55	110	350 - 500	500 - 800	495	250






Taper Lengths and Minimum Number of Channelizing Devices						
Speed	Shifting Taper: 1/2L		Shoulder Taper: 1/3L		50' Per Lane Taper	
S (MPH)	Length (Feet)	Minimum Number Of Devices	Length (Feet)	Minimum Number Of Devices	Length (Feet)	Minimum Number Of Devices
25	65	6	45	6	50	6
30	90	6	60	6	50	6
35	125	6	85	6	50	6
40	160	6	110	6	50	6
45	270	7	180	6	50	6
50	300	7	200	6	50	6
55	330	7	220	6	50	6

PATA 203



PATA 204

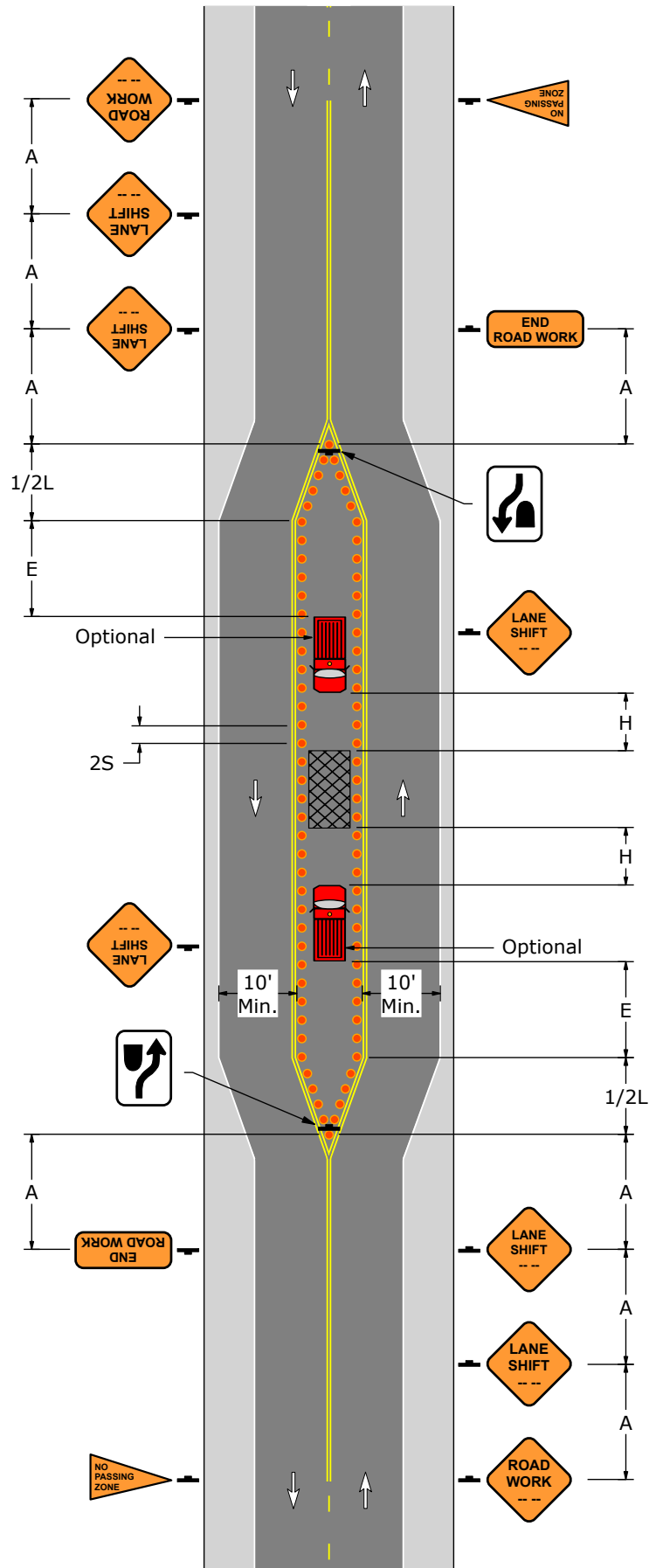
1. Where traffic is required to use a shoulder, it must be a paved shoulder that is in good condition both during the period it is being used by traffic and also after the work is complete.
2. When a shadow vehicle is not used, distance E is measured from the end of the taper to the beginning of the work space.
3. A no passing zone shall be established when an existing passing zone is present. A temporary double yellow pavement marking line shall be installed throughout the entire length of the TTC zone. Place a NO PASSING ZONE sign at the start of the temporary double yellow pavement marking line.

Signs				
				
W20-1	W5-5	W14-3	G20-2	R4-7

Sign Spacing, Channelizing Device Spacing, Buffer Space, and Roll Ahead Space					
Speed	Channelizing Devices Spacing	Sign Spacing		Buffer Space	Roll Ahead Space
		Urban	Rural		
S (MPH)	2S (Feet)	A (Feet)	A (Feet)	E (Feet)	H (Feet)
25	50	100 - 200	500 - 800	155	150
30	60	100 - 200	500 - 800	200	150
35	70	100 - 200	500 - 800	250	150
40	80	350 - 500	500 - 800	305	150
45	90	350 - 500	500 - 800	360	150
50	100	350 - 500	500 - 800	425	250
55	110	350 - 500	500 - 800	495	250

Taper Lengths and Minimum Number of Channelizing Devices		
Speed	Shifting Taper: 1/2L	
S (MPH)	Length (Feet)	Minimum Number Of Devices
25	65	6
30	90	6
35	125	6
40	160	6
45	270	7
50	300	7
55	330	7

PATA 204



PATA 205

1. This figure applies when all of the following conditions are satisfied:






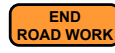

- a) Sight distance between the STOP signs is unobstructed.
- b) The ADT is not greater than approximately 1500.

2. The STOP sign shall be clearly visible to traffic for a minimum distance of E.

3. Attach Type B flashing red lights to temporary STOP signs.

4. When a shadow vehicle is not used, 50' is measured from the end of the taper to the beginning of the work space.

5. A no passing zone shall be established when an existing passing zone is present. A temporary double yellow pavement marking line shall be installed throughout the entire length of the TTC zone. Place a NO PASSING ZONE sign at the start of the temporary double yellow pavement marking line.








Signs						
						
W20-1	W20-4	W1-4R	W3-1	W14-3	G20-2	R1-1

Sign Spacing, Channelizing Device Spacing, and Roll Ahead Space				
Speed	Channelizing Devices Spacing	Sign Spacing		Visibility Distance
		Urban	Rural	
S (MPH)	2S (Feet)	A (Feet)	A (Feet)	E (Feet)
25	50	100 - 200	500 - 800	155
30	60	100 - 200	500 - 800	200
35	70	100 - 200	500 - 800	250
40	80	350 - 500	500 - 800	305
45	90	350 - 500	500 - 800	360
50	100	350 - 500	500 - 800	425
55	110	350 - 500	500 - 800	495

Taper Lengths and Minimum Number Of Channelizing Devices		
Speed	50' Per Lane Taper	
S (MPH)	Length (Feet)	Minimum Number Of Devices
25	50	6
30	50	6
35	50	6
40	50	6
45	50	6
50	50	6
55	50	6

PATA 206

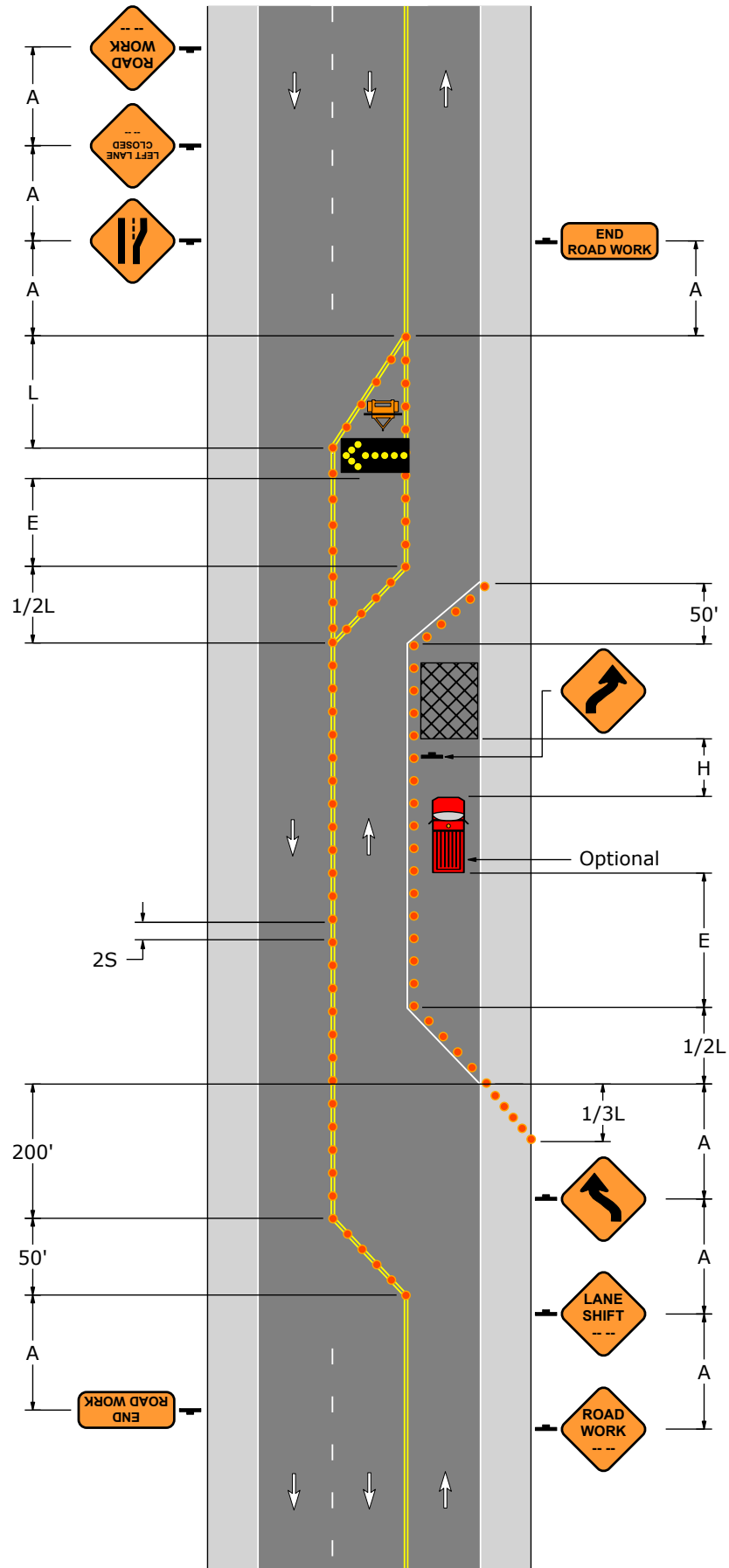
1. When a shadow vehicle is not used, distance E is measured from the end of the taper to the beginning of the work space.

Signs						
						
W20-1	W5-5	W1-4R	W1-4L	W20-5L	W4-2L	G20-2

Sign Spacing, Channelizing Device Spacing, Buffer Space, and Roll Ahead Space					
Speed	Channelizing Devices Spacing	Sign Spacing		Buffer Space	Roll Ahead Space
		Urban	Rural		
S (MPH)	2S (Feet)	A (Feet)	A (Feet)	E (Feet)	H (Feet)
25	50	100 - 200	500 - 800	155	150
30	60	100 - 200	500 - 800	200	150
35	70	100 - 200	500 - 800	250	150
40	80	350 - 500	500 - 800	305	150
45	90	350 - 500	500 - 800	360	150
50	100	350 - 500	500 - 800	425	250
55	110	350 - 500	500 - 800	495	250









Taper Lengths and Minimum Number of Channelizing Devices								
Speed	Merging Taper: L		Shifting Taper: 1/2L		Shoulder Taper: 1/3L		50' Per Lane Taper	
S (MPH)	Length (Feet)	Minimum Number Of Devices	Length (Feet)	Minimum Number Of Devices	Length (Feet)	Minimum Number Of Devices	Length (Feet)	Minimum Number Of Devices
25	125	6	65	6	45	6	50	6
30	180	7	90	6	60	6	50	6
35	245	8	125	6	85	6	50	6
40	320	9	160	6	110	6	50	6
45	540	13	270	7	180	6	50	6
50	600	13	300	7	200	6	50	6
55	660	13	330	7	220	6	50	6

PATA 206



PATA 207

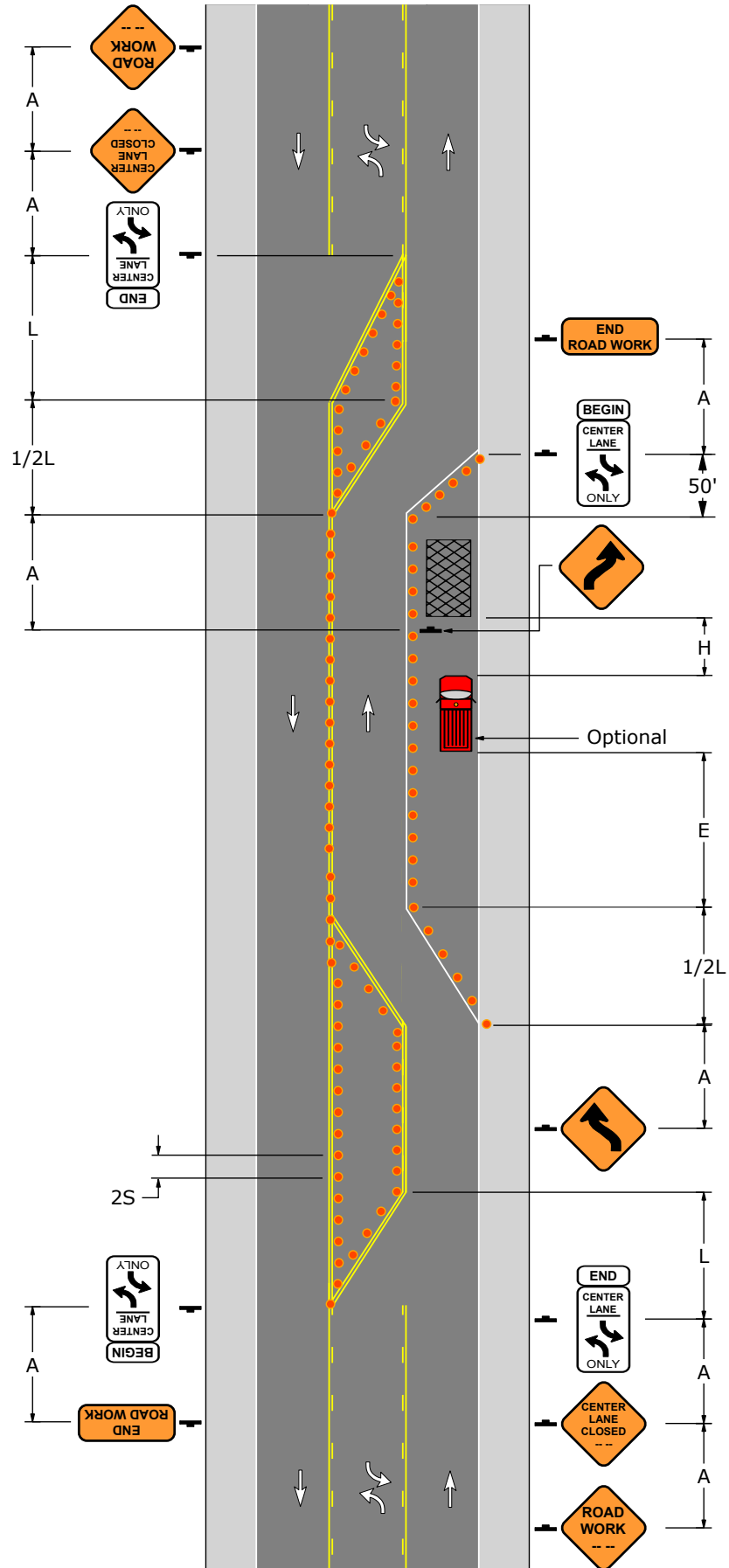
1. When a shadow vehicle is not used, distance E is measured from the end of the taper to the beginning of the work space.

Signs							
							
W20-1	W9-3	W1-4L	W1-4R	G20-2	R3-9CP	M4-6	R3-9B

Sign Spacing, Channelizing Device Spacing, Buffer Space, and Roll Ahead Space					
Speed	Channelizing Devices Spacing	Sign Spacing		Buffer Space	Roll Ahead Space
		Urban	Rural		
S (MPH)	2S (Feet)	A (Feet)	A (Feet)	E (Feet)	H (Feet)
25	50	100 - 200	500 - 800	155	150
30	60	100 - 200	500 - 800	200	150
35	70	100 - 200	500 - 800	250	150
40	80	350 - 500	500 - 800	305	150
45	90	350 - 500	500 - 800	360	150
50	100	350 - 500	500 - 800	425	250
55	110	350 - 500	500 - 800	495	250







Taper Lengths and Minimum Number of Channelizing Devices						
Speed	Merging Taper: L		Shifting Taper: 1/2L		50' Per Lane Taper	
S (MPH)	Length (Feet)	Minimum Number Of Devices	Length (Feet)	Minimum Number Of Devices	Length (Feet)	Minimum Number Of Devices
25	125	6	65	6	50	6
30	180	7	90	6	50	6
35	245	8	125	6	50	6
40	320	9	160	6	50	6
45	540	13	270	7	50	6
50	600	13	300	7	50	6
55	660	13	330	7	50	6

PATA 207



PATA 208

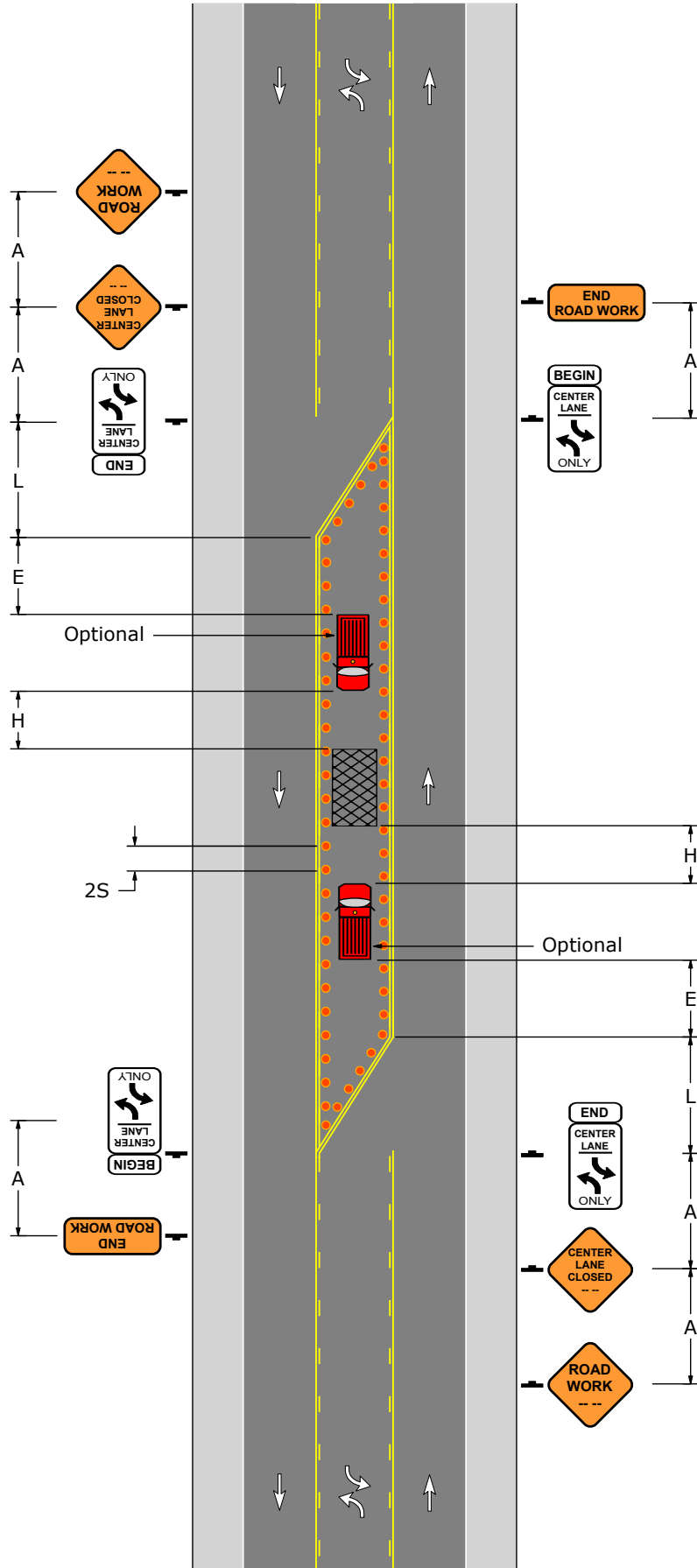
1. When a shadow vehicle is not used, distance E is measured from end of taper to beginning of work space.

Signs					
					
W20-1	W9-3	G20-2	R3-9CP	R3-9DP	R3-9B

Sign Spacing, Channelizing Device Spacing, Buffer Space, and Roll Ahead Space					
Speed	Channelizing Devices Spacing	Sign Spacing		Buffer Space	Roll Ahead Space
		Urban	Rural		
S (MPH)	2S (Feet)	A (Feet)	A (Feet)	E (Feet)	H (Feet)
25	50	100 - 200	500 - 800	155	150
30	60	100 - 200	500 - 800	200	150
35	70	100 - 200	500 - 800	250	150
40	80	350 - 500	500 - 800	305	150
45	90	350 - 500	500 - 800	360	150
50	100	350 - 500	500 - 800	425	250
55	110	350 - 500	500 - 800	495	250





Taper Lengths and Minimum Number of Channelizing Devices		
Speed	Merging Taper: L	
S (MPH)	Length (Feet)	Minimum Number Of Devices
25	125	6
30	180	7
35	245	8
40	320	9
45	540	13
50	600	13
55	660	13

PATA 208



PATA 209-A

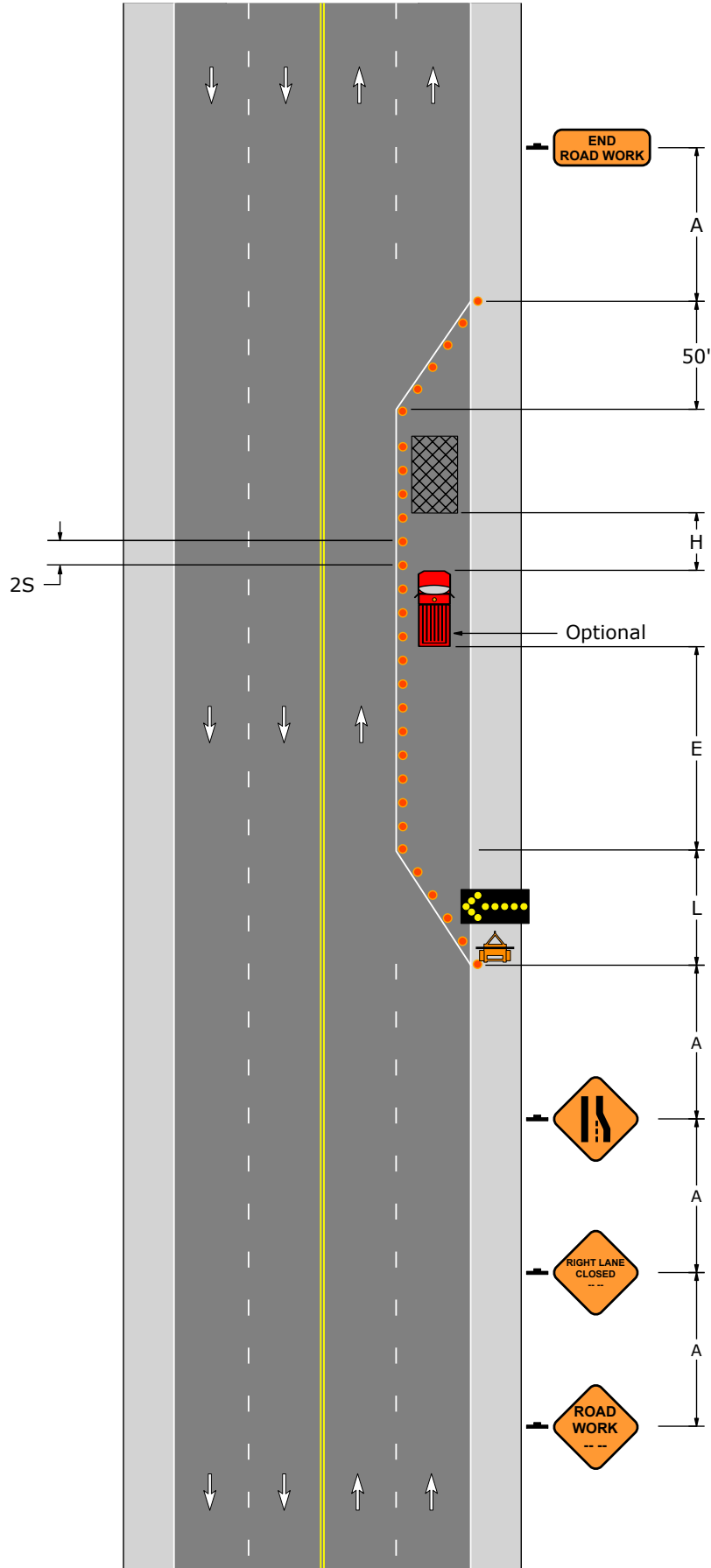
1. When a shadow vehicle is not used, distance E is measured from end of taper to beginning of work space.

Signs			
			
W20-1	W20-5R	W4-2R	G20-2

Sign Spacing, Channelizing Device Spacing, Buffer Space, and Roll Ahead Space					
Speed	Channelizing Devices Spacing	Sign Spacing		Buffer Space	Roll Ahead Space
		Urban	Rural		
S (MPH)	2S (Feet)	A (Feet)	A (Feet)	E (Feet)	H (Feet)
25	50	100 - 200	500 - 800	155	150
30	60	100 - 200	500 - 800	200	150
35	70	100 - 200	500 - 800	250	150
40	80	350 - 500	500 - 800	305	150
45	90	350 - 500	500 - 800	360	150
50	100	350 - 500	500 - 800	425	250
55	110	350 - 500	500 - 800	495	250




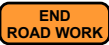
Taper Lengths and Minimum Number of Channelizing Devices				
Speed	Merging Taper: L		50' Per Lane Taper	
S (MPH)	Length (Feet)	Minimum Number Of Devices	Length (Feet)	Minimum Number Of Devices
25	125	6	50	6
30	180	7	50	6
35	245	8	50	6
40	320	9	50	6
45	540	13	50	6
50	600	13	50	6
55	660	13	50	6

PATA 209-A



PATA 209-B

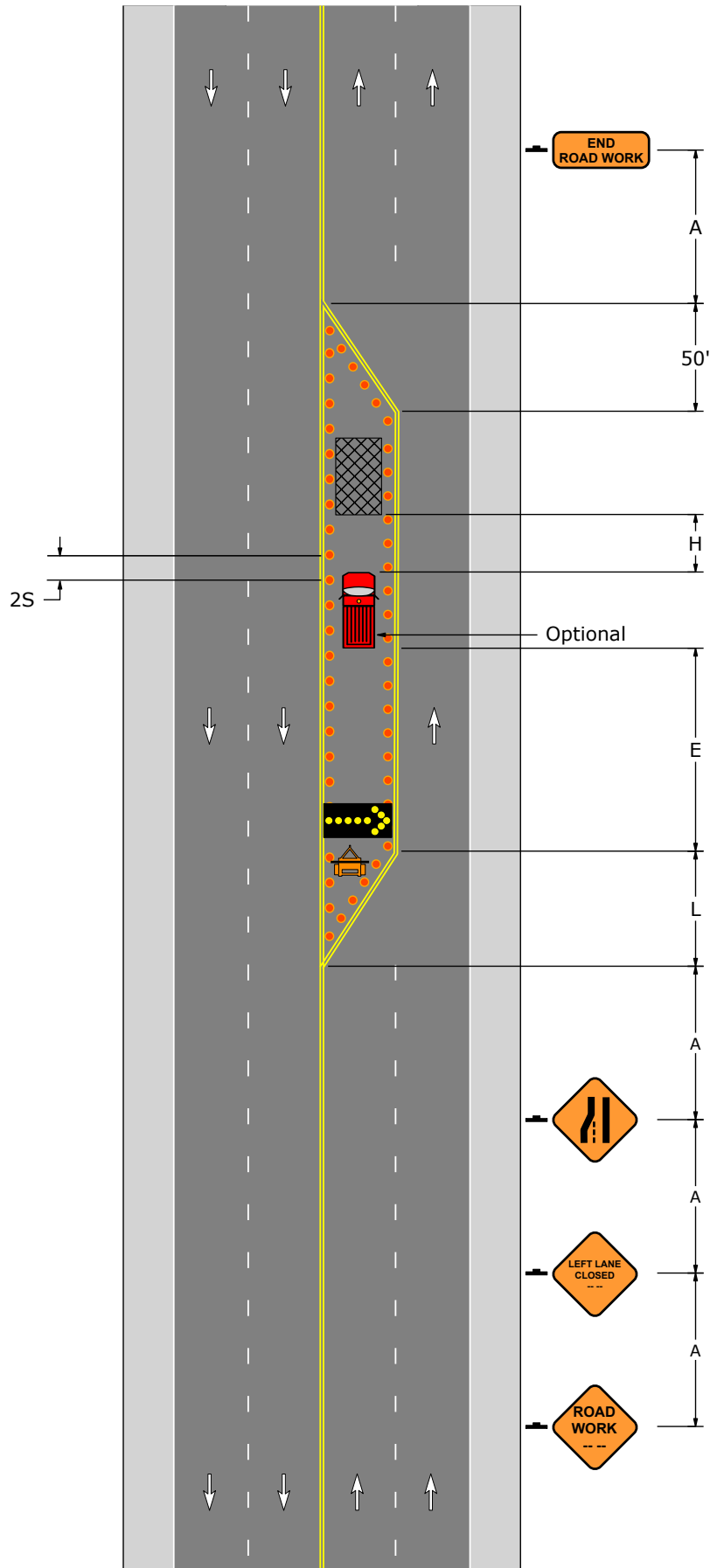
1. When a shadow vehicle is not used, distance E is measured from end of taper to beginning of work space.

Signs			
			
W20-1	W20-5L	W4-2L	G20-2

Sign Spacing, Channelizing Device Spacing, Buffer Space, and Roll Ahead Space					
Speed	Channelizing Devices Spacing	Sign Spacing		Buffer Space	Roll Ahead Space
		Urban	Rural		
S (MPH)	2S (Feet)	A (Feet)	A (Feet)	E (Feet)	H (Feet)
25	50	100 - 200	500 - 800	155	150
30	60	100 - 200	500 - 800	200	150
35	70	100 - 200	500 - 800	250	150
40	80	350 - 500	500 - 800	305	150
45	90	350 - 500	500 - 800	360	150
50	100	350 - 500	500 - 800	425	250
55	110	350 - 500	500 - 800	495	250









Taper Lengths and Minimum Number of Channelizing Devices				
Speed	Merging Taper: L		50' Per Lane Taper	
S (MPH)	Length (Feet)	Minimum Number Of Devices	Length (Feet)	Minimum Number Of Devices
25	125	6	50	6
30	180	7	50	6
35	245	8	50	6
40	320	9	50	6
45	540	13	50	6
50	600	13	50	6
55	660	13	50	6

PATA 209-B



PATA 210

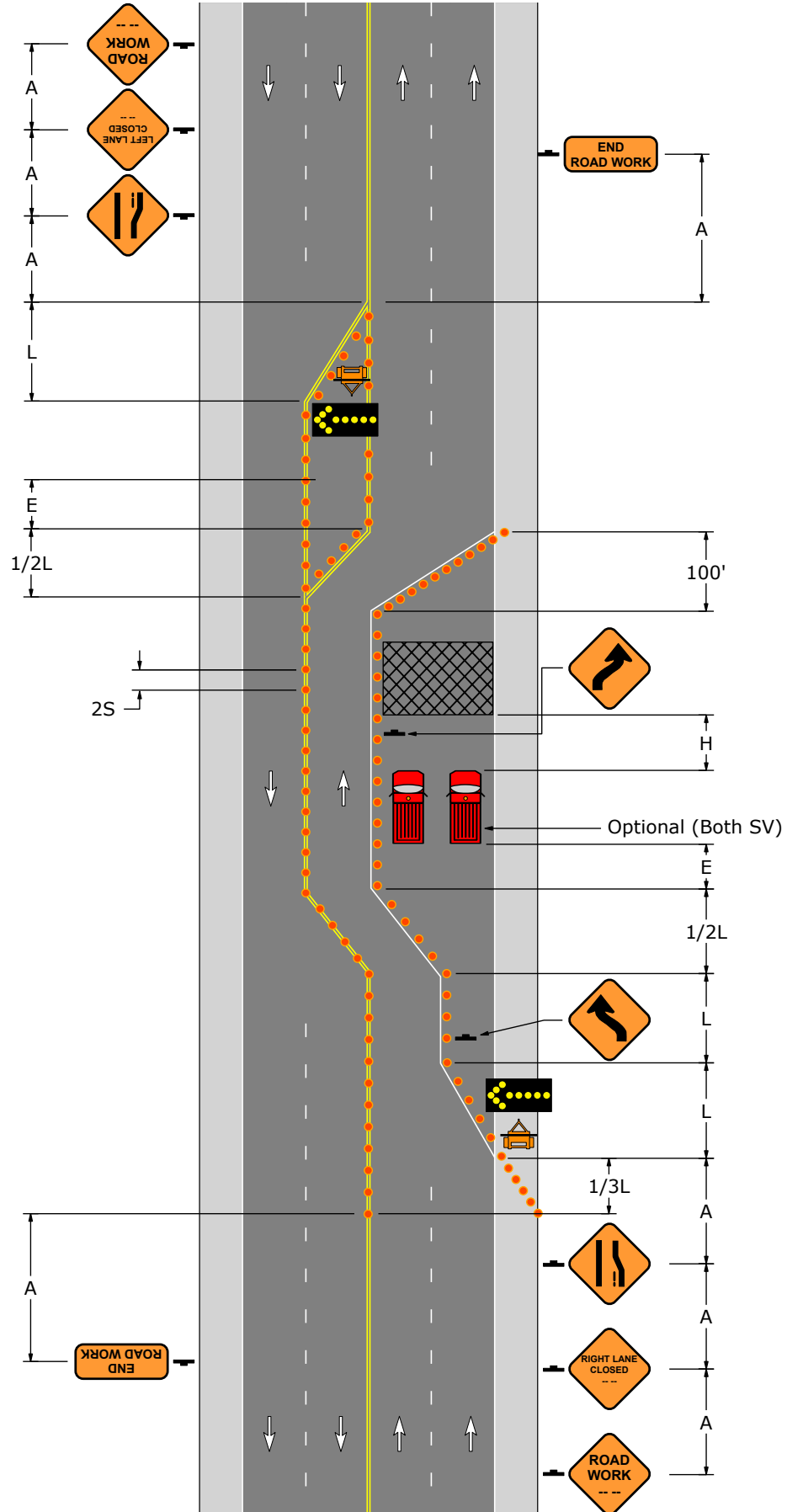
1. If two shadow vehicles are used, they should be placed side-by-side as shown on the PATA drawing.
2. When a shadow vehicle is not used, distance E is measured from end of taper to beginning of work space.

Signs							
							
W20-1	W20-5L	W20-5R	W4-2L	W4-2R	W1-4L	W1-4R	G20-2

Sign Spacing, Channelizing Device Spacing, Buffer Space, and Roll Ahead Space					
Speed	Channelizing Devices Spacing	Sign Spacing		Buffer Space	Roll Ahead Space
		Urban	Rural		
S (MPH)	2S (Feet)	A (Feet)	A (Feet)	E (Feet)	H (Feet)
25	50	100 - 200	500 - 800	155	150
30	60	100 - 200	500 - 800	200	150
35	70	100 - 200	500 - 800	250	150
40	80	350 - 500	500 - 800	305	150
45	90	350 - 500	500 - 800	360	150
50	100	350 - 500	500 - 800	425	250
55	110	350 - 500	500 - 800	495	250





Taper Lengths and Minimum Number of Channelizing Devices								
Speed	Merging Taper: L		Shifting Taper: 1/2L		Shoulder Taper: 1/3L		50' Per Lane Taper	
	Length (Feet)	Minimum Number Of Devices	Length (Feet)	Minimum Number Of Devices	Length (Feet)	Minimum Number Of Devices	Length (Feet)	Minimum Number Of Devices
25	125	6	65	6	45	6	50	6
30	180	7	90	6	60	6	50	6
35	245	8	125	6	85	6	50	6
40	320	9	160	6	110	6	50	6
45	540	13	270	7	180	6	50	6
50	600	13	300	7	200	6	50	6
55	660	13	330	7	220	6	50	6

PATA 210



PATA 211-A

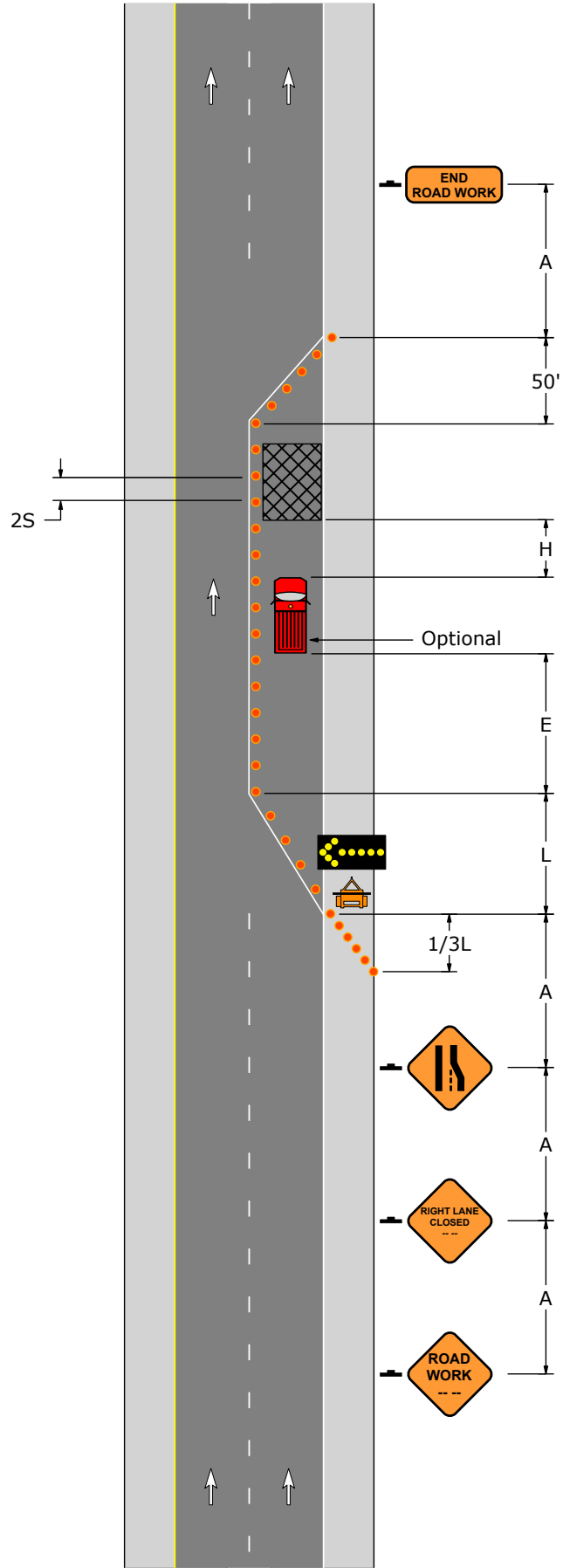
1. When a shadow vehicle is not used, distance E is measured from end of taper to beginning of work space.

Signs			
			
W20-1	W20-5R	W4-2R	G20-2

Sign Spacing, Channelizing Device Spacing, Buffer Space, and Roll Ahead Space					
Speed	Channelizing Devices Spacing	Sign Spacing		Buffer Space	Roll Ahead Space
		Urban	Rural		
S (MPH)	2S (Feet)	A (Feet)	A (Feet)	E (Feet)	H (Feet)
25	50	100 - 200	500 - 800	155	150
30	60	100 - 200	500 - 800	200	150
35	70	100 - 200	500 - 800	250	150
40	80	350 - 500	500 - 800	305	150
45	90	350 - 500	500 - 800	360	150
50	100	350 - 500	500 - 800	425	250
55	110	350 - 500	500 - 800	495	250




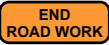
Taper Lengths and Minimum Number of Channelizing Devices						
Speed	Merging Taper: L		Shoulder Taper: 1/3L		50' Per Lane Taper	
S (MPH)	Length (Feet)	Minimum Number Of Devices	Length (Feet)	Minimum Number Of Devices	Length (Feet)	Minimum Number Of Devices
25	125	6	45	6	50	6
30	180	7	60	6	50	6
35	245	8	85	6	50	6
40	320	9	110	6	50	6
45	540	13	180	6	50	6
50	600	13	200	6	50	6
55	660	13	220	6	50	6

PATA 211-A



PATA 211-B

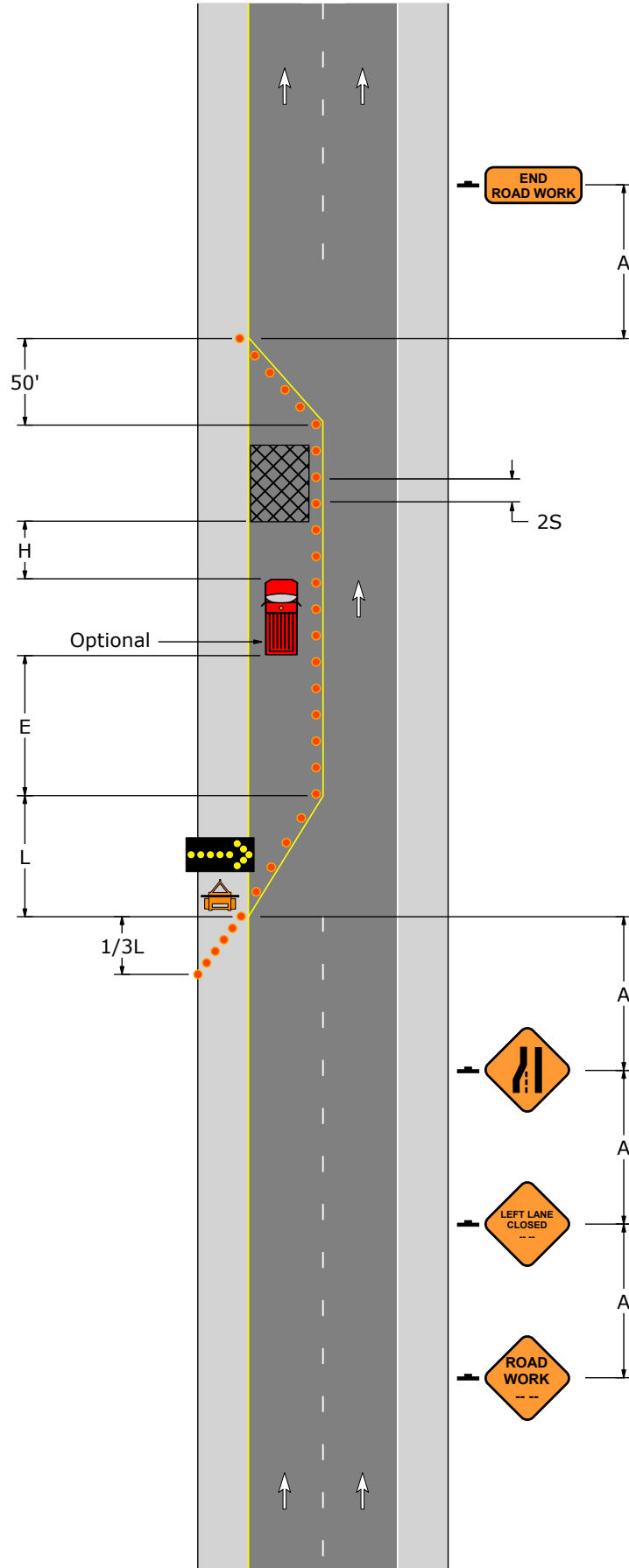
1. When a shadow vehicle is not used, distance E is measured from end of taper to beginning of work space.

Signs			
			
W20-1	W20-5L	W4-2L	G20-2

Sign Spacing, Channelizing Device Spacing, Buffer Space, and Roll Ahead Space					
Speed	Channelizing Devices Spacing	Sign Spacing		Buffer Space	Roll Ahead Space
		Urban	Rural		
S (MPH)	2S (Feet)	A (Feet)	A (Feet)	E (Feet)	H (Feet)
25	50	100 - 200	500 - 800	155	150
30	60	100 - 200	500 - 800	200	150
35	70	100 - 200	500 - 800	250	150
40	80	350 - 500	500 - 800	305	150
45	90	350 - 500	500 - 800	360	150
50	100	350 - 500	500 - 800	425	250
55	110	350 - 500	500 - 800	495	250






Taper Lengths and Minimum Number of Channelizing Devices						
Speed	Merging Taper: L		Shoulder Taper: 1/3L		50' Per Lane Taper	
	Length (Feet)	Minimum Number Of Devices	Length (Feet)	Minimum Number Of Devices	Length (Feet)	Minimum Number Of Devices
25	125	6	45	6	50	6
30	180	7	60	6	50	6
35	245	8	85	6	50	6
40	320	9	110	6	50	6
45	540	13	180	6	50	6
50	600	13	200	6	50	6
55	660	13	220	6	50	6

PATA 211-B



PATA 212-A

1. Calculate taper lengths by using the regulatory speed limit (S) and appropriate offset width (W) in formulas shown below.
2. Provide a 10' minimum lane width for traffic, which may include the shoulder if the shoulder is paved, in good condition and free from road debris.
3. Edge line pavement markings within the merging taper shall be parallel.
4. Downstream taper length is 50' per lane plus the length required until the longitudinal devices are met.
5. When a shadow vehicle is not used, distance E is measured from the end of the taper to the beginning of the work space.

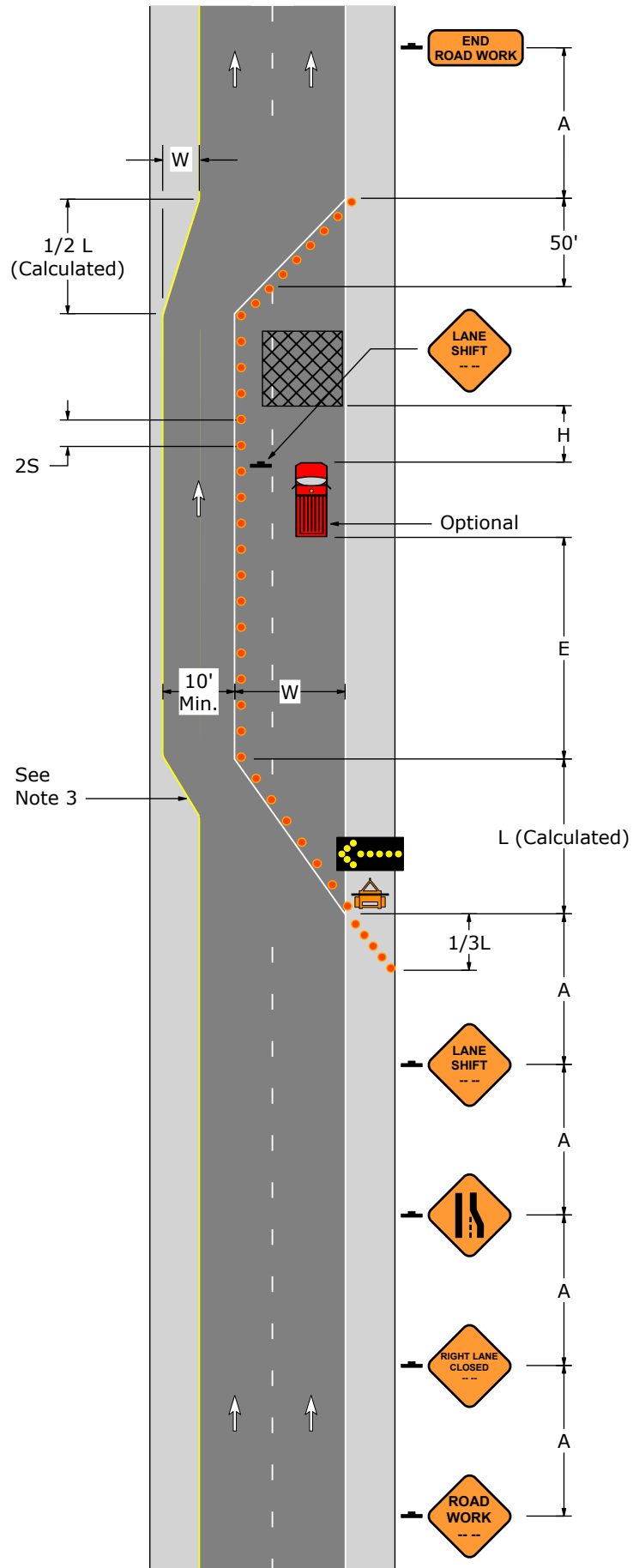
Signs				
				
W20-1	W20-5L	W4-2L	W5-5	G20-2

Sign Spacing, Channelizing Device Spacing, Buffer Space, and Roll Ahead Space					
Speed	Channelizing Devices Spacing	Sign Spacing		Buffer Space	Roll Ahead Space
		Urban	Rural		
S (MPH)	2S (Feet)	A (Feet)	A (Feet)	E (Feet)	H (Feet)
25	50	100 - 200	500 - 800	155	150
30	60	100 - 200	500 - 800	200	150
35	70	100 - 200	500 - 800	250	150
40	80	350 - 500	500 - 800	305	150
45	90	350 - 500	500 - 800	360	150
50	100	350 - 500	500 - 800	425	250
55	110	350 - 500	500 - 800	495	250

Taper Lengths and Minimum Number of Channelizing Devices								
Speed	Merging Taper: L		Shifting Taper: 1/2L		Shoulder Taper: 1/3L		50' Per Lane Taper	
S (MPH)	Length (Feet)	Minimum Number Of Devices	Length (Feet)	Minimum Number Of Devices	Length (Feet)	Minimum Number Of Devices	Length (Feet)	Minimum Number Of Devices
25	125	6	65	6	45	6	50	6
30	180	7	90	6	60	6	50	6
35	245	8	125	6	85	6	50	6
40	320	9	160	6	110	6	50	6
45	540	13	270	7	180	6	50	6
50	600	13	300	7	200	6	50	6
55	660	13	330	7	220	6	50	6






* Taper Length Formulas	
If the speed limit is 40 MPH or less $L = \frac{WS^2}{60}$	If the speed limit is 45 MPH or more $L = WS$
S = Regulatory Speed Limit (MPH) W = Width of Offset (feet) L = Length of Taper (feet)	

PATA 212-A



PATA 212-B

1. Calculate taper lengths by using the regulatory speed limit (S) and appropriate offset width (W) in formulas shown below.
2. Provide a 10' minimum lane width for traffic, which may include the shoulder if the shoulder is paved, in good condition and free from road debris.
3. Edge line pavement markings within the merging taper shall be parallel.
4. Downstream taper length is 50' per lane plus the length required until the longitudinal devices are met.
5. When a shadow vehicle is not used, distance E is measured from the end of the taper to the beginning of the work space.

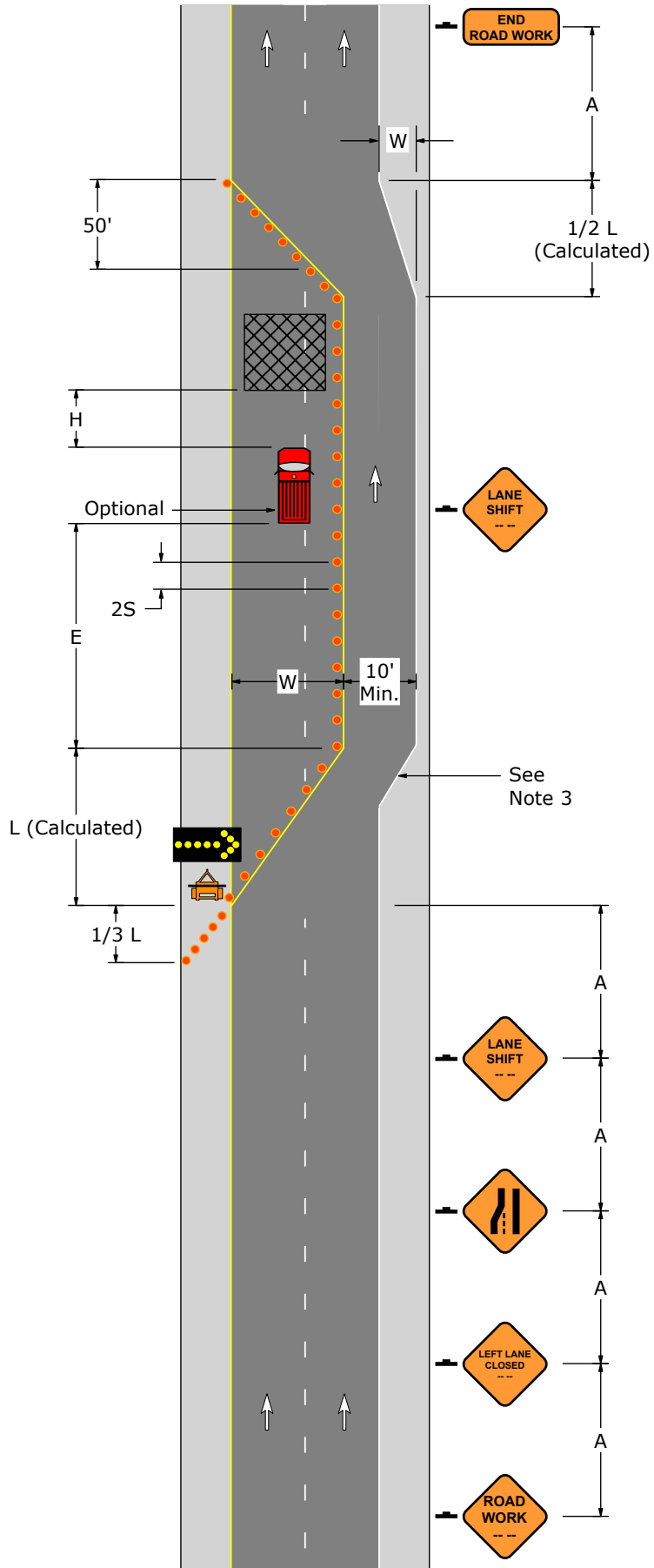
Signs				
				
W20-1	W20-5L	W4-2L	W5-5	G20-2

Sign Spacing, Channelizing Device Spacing, Buffer Space, and Roll Ahead Space					
Speed	Channelizing Devices Spacing	Sign Spacing		Buffer Space	Roll Ahead Space
		Urban	Rural		
S (MPH)	2S (Feet)	A (Feet)	A (Feet)	E (Feet)	H (Feet)
25	50	100 - 200	500 - 800	155	150
30	60	100 - 200	500 - 800	200	150
35	70	100 - 200	500 - 800	250	150
40	80	350 - 500	500 - 800	305	150
45	90	350 - 500	500 - 800	360	150
50	100	350 - 500	500 - 800	425	250
55	110	350 - 500	500 - 800	495	250

Taper Lengths and Minimum Number of Channelizing Devices								
Speed	Merging Taper: L		Shifting Taper: 1/2L		Shoulder Taper: 1/3L		50' Per Lane Taper	
S (MPH)	Length (Feet)	Minimum Number Of Devices	Length (Feet)	Minimum Number Of Devices	Length (Feet)	Minimum Number Of Devices	Length (Feet)	Minimum Number Of Devices
25	125	6	65	6	45	6	50	6
30	180	7	90	6	60	6	50	6
35	245	8	125	6	85	6	50	6
40	320	9	160	6	110	6	50	6
45	540	13	270	7	180	6	50	6
50	600	13	300	7	200	6	50	6
55	660	13	330	7	220	6	50	6




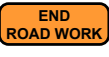
* Taper Length Formulas	
If the speed limit is 40 MPH or less $L = \frac{WS^2}{60}$	If the speed limit is 45 MPH or more $L = WS$
S = Regulatory Speed Limit (MPH) W = Width of Offset (feet) L = Length of Taper (feet)	

PATA 212-B



PATA 213-A

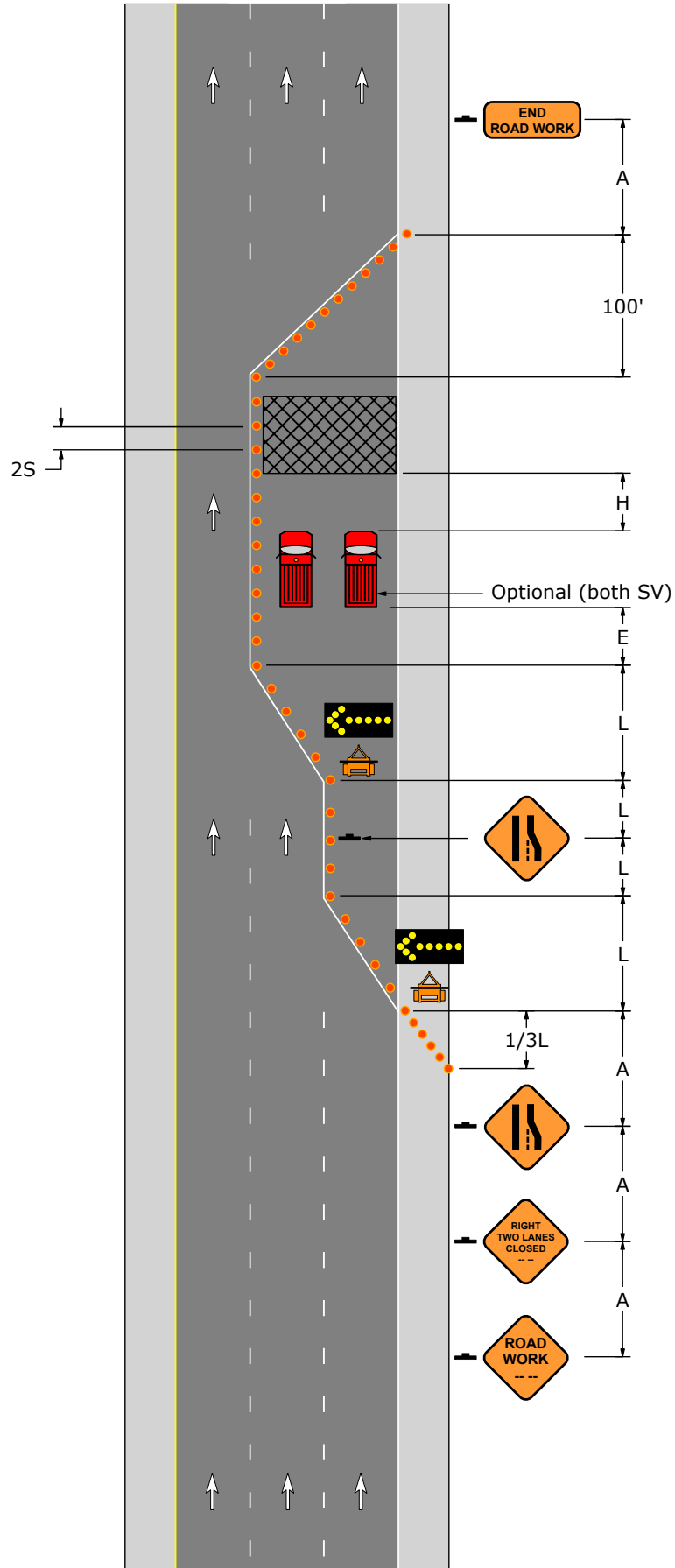
1. If two shadow vehicles are used, they should be placed side-by-side as shown on the PATA drawing.
2. When a shadow vehicle is not used, distance E is measured from end of taper to beginning of work space.

Signs			
			
W20-1	W20-5AR	W4-2R	G20-2

Sign Spacing, Channelizing Device Spacing, Buffer Space, and Roll Ahead Space					
Speed	Channelizing Devices Spacing	Sign Spacing		Buffer Space	Roll Ahead Space
		Urban	Rural		
S (MPH)	2S (Feet)	A (Feet)	A (Feet)	E (Feet)	H (Feet)
25	50	100 - 200	500 - 800	155	150
30	60	100 - 200	500 - 800	200	150
35	70	100 - 200	500 - 800	250	150
40	80	350 - 500	500 - 800	305	150
45	90	350 - 500	500 - 800	360	150
50	100	350 - 500	500 - 800	425	250
55	110	350 - 500	500 - 800	495	250




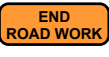
Taper Lengths and Minimum Number of Channelizing Devices						
Speed	Merging Taper: L		Shoulder Taper: 1/3L		50' Per Lane Taper	
S (MPH)	Length (Feet)	Minimum Number Of Devices	Length (Feet)	Minimum Number Of Devices	Length (Feet)	Minimum Number Of Devices
25	125	6	45	6	50	6
30	180	7	60	6	50	6
35	245	8	85	6	50	6
40	320	9	110	6	50	6
45	540	13	180	6	50	6
50	600	13	200	6	50	6
55	660	13	220	6	50	6

PATA 213-A



PATA 213-B

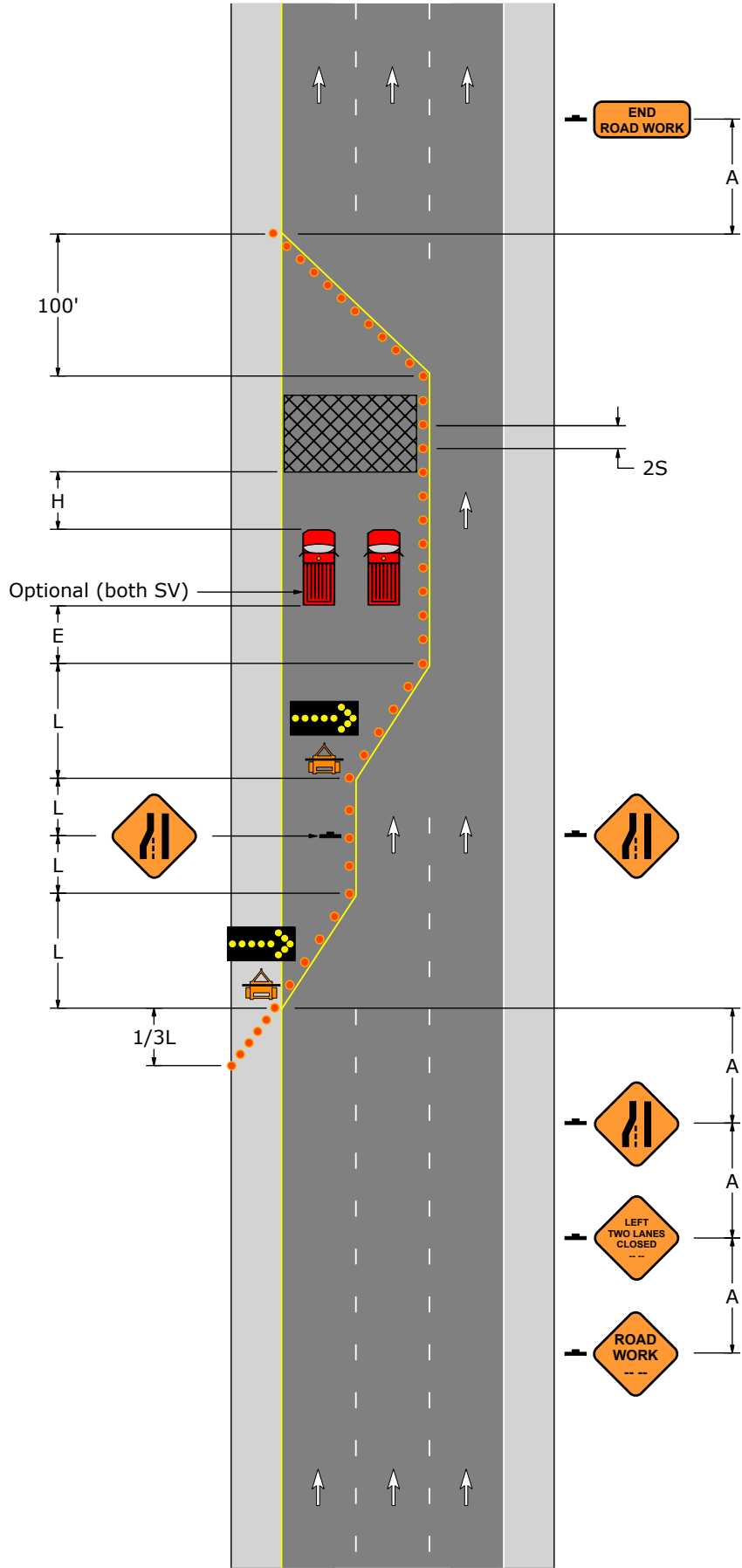
1. If two shadow vehicles are used, they should be placed side-by-side as shown on the PATA drawing.
2. When a shadow vehicle is not used, distance E is measured from end of taper to beginning of work space.

Signs			
			
W20-1	W20-5AL	W4-2L	G20-2

Sign Spacing, Channelizing Device Spacing, Buffer Space, and Roll Ahead Space					
Speed	Channelizing Devices Spacing	Sign Spacing		Buffer Space	Roll Ahead Space
		Urban	Rural		
S (MPH)	2S (Feet)	A (Feet)	A (Feet)	E (Feet)	H (Feet)
25	50	100 - 200	500 - 800	155	150
30	60	100 - 200	500 - 800	200	150
35	70	100 - 200	500 - 800	250	150
40	80	350 - 500	500 - 800	305	150
45	90	350 - 500	500 - 800	360	150
50	100	350 - 500	500 - 800	425	250
55	110	350 - 500	500 - 800	495	250









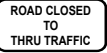










Taper Lengths and Minimum Number of Channelizing Devices						
Speed	Merging Taper: L		Shoulder Taper: 1/3L		50' Per Lane Taper	
S (MPH)	Length (Feet)	Minimum Number Of Devices	Length (Feet)	Minimum Number Of Devices	Length (Feet)	Minimum Number Of Devices
25	125	6	45	6	50	6
30	180	7	60	6	50	6
35	245	8	85	6	50	6
40	320	9	110	6	50	6
45	540	13	180	6	50	6
50	600	13	200	6	50	6
55	660	13	220	6	50	6

PATA 213-B



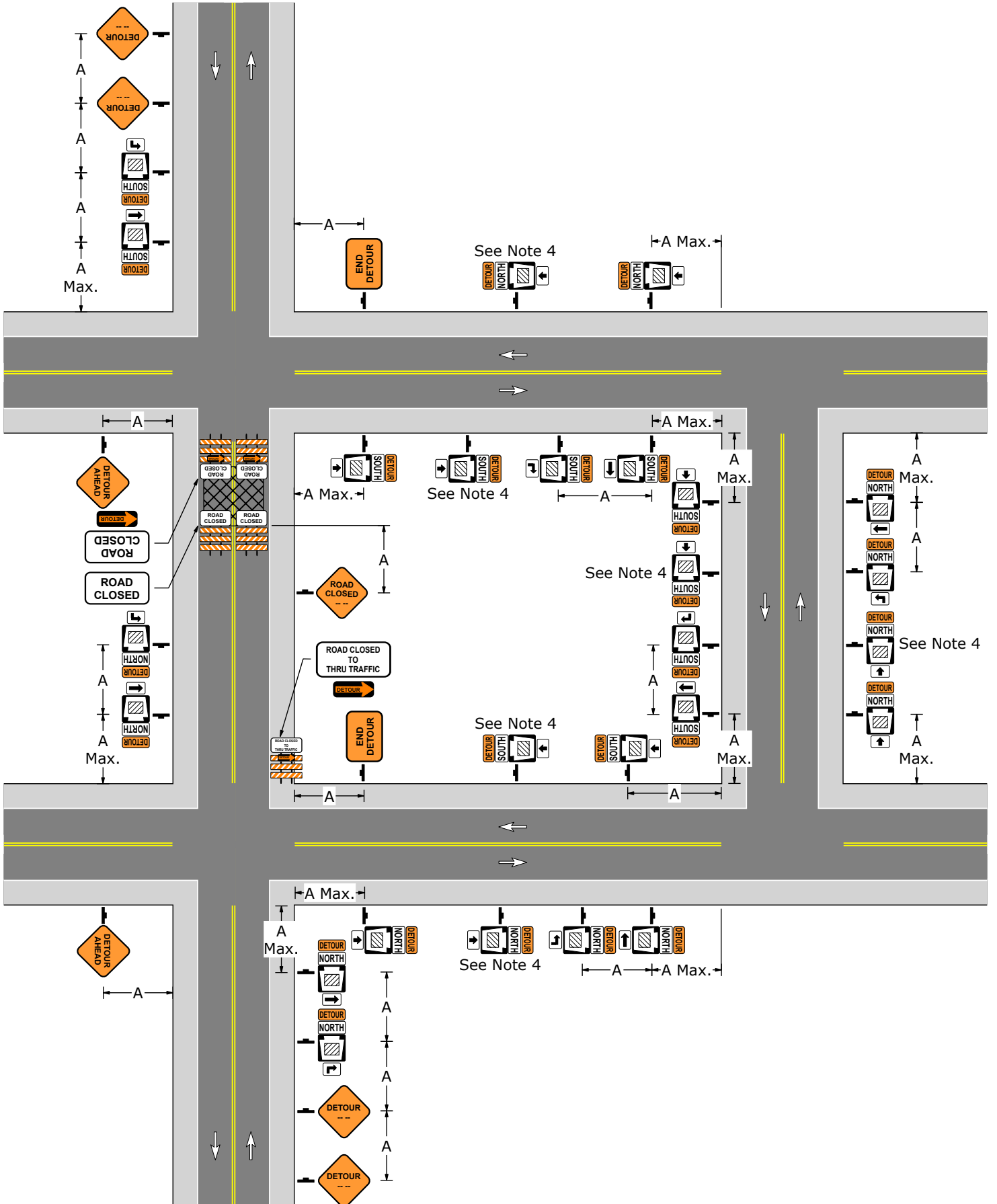
PATA 214

1. This PATA is to be used where a numbered traffic route is closed. However, if the detour will remain in place for 7 consecutive days or less, PATA 215 may be used.
2. THIS STREET TO BE CLOSED FOR MAINTENANCE NEXT WEEK signs should be installed for scheduled work. Install the signs at the most appropriate locations. PCMS may be used in lieu of static signs.
3. TTC signs shall not be attached to permanent sign posts or utility poles without the utility pole owner's permission.
4. Install confirmation ROUTE MARKER and STRAIGHT THRU ARROW signs at one-mile intervals or after major intersections.

Signs									
									
W20-2	W20-3	W23-101		M4-10L	M4-10R	M4-8	M4-8A	R11-2	R11-4
									
M1-4	M1-5	M3-1	M3-2	M3-3	M3-4	M6-1	M5-1L	M5-1R	M6-3














Sign Spacing		
Speed	Sign Spacing	
	Urban	Rural
S (MPH)	A (Feet)	A (Feet)
25	100 - 200	500 - 800
30	100 - 200	500 - 800
35	100 - 200	500 - 800
40	350 - 500	500 - 800
45	350 - 500	500 - 800
50	350 - 500	500 - 800
55	350 - 500	500 - 800

PATA 214



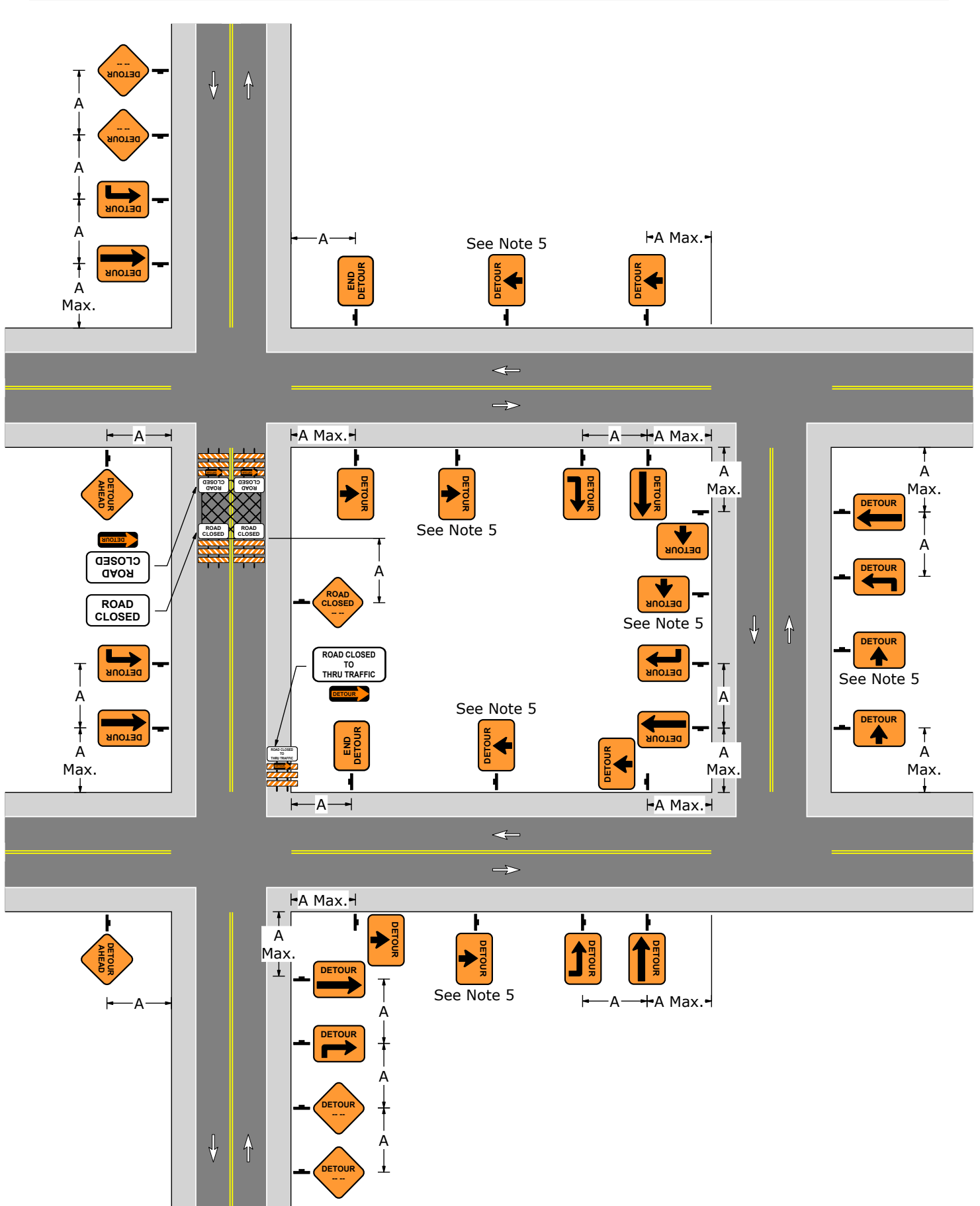
PATA 215

1. At locations where there are overlapping detours or several detours within the same area, street names may be added to the DETOUR ARROW signs, or signs with different colored arrows may be used to designate different detour routes. The design and application of signs displaying color arrows shall comply with PennDOT Publication 236.
2. THIS STREET TO BE CLOSED FOR MAINTENANCE NEXT WEEK signs should be installed for scheduled work. Install the signs at most appropriate locations. PCMS may be used to post approved messages in lieu of static signs.
3. LEFT ADVANCE ARROW and RIGHT ADVANCE ARROW signs are required where the detour route has multiple lanes approaching intersections where turning movements are required. These signs are shown on each approach to display placement guidance.
4. TTC signs shall not be attached to permanent sign posts or utility poles without the utility pole owner's permission.
5. Install confirmation STRAIGHT THRU ARROW signs at one-mile intervals or after major intersections.

Signs									
									
W20-2	W20-3	W23-101		M4-9S	M4-9L	M4-9R	M4-9SL	M4-9SR	M4-8A
									
M4-10L	M4-10R	R11-2	R11-4						





Sign Spacing		
Speed	Sign Spacing	
	Urban	Rural
S (MPH)	A (Feet)	A (Feet)
25	100 - 200	500 - 800
30	100 - 200	500 - 800
35	100 - 200	500 - 800
40	350 - 500	500 - 800
45	350 - 500	500 - 800
50	350 - 500	500 - 800
55	350 - 500	500 - 800

PATA 215





PATA 216

1. When crosswalks or other pedestrian facilities are closed or relocated, temporary facilities shall be detectable and shall include accessibility features consistent with the features present in the existing pedestrian facility.
2. Approved pedestrian barricades or channelizing devices must be placed at each closure to protect pedestrians from construction activities, drop-offs, and vehicular traffic. The pedestrian barriers or channelizing devices must be continuous, stable and non-flexible and consist of a wall, fence, or enclosures specified in MUTCD Sections 6F.63, 6F.68, and 6F.71 with detectable, continuous bottom edge 6 inches maximum height above the walkway surface. Support members may not protrude into the useable sidewalk. Sidewalk barriers shall be detectable by blind pedestrians or those who have low vision. Plastic tape, movable cones, and print signs at a sidewalk excavation will not generally provide adequate notice or protection.

Signs			
			
W20-1	G20-2	R9-9	R9-11a

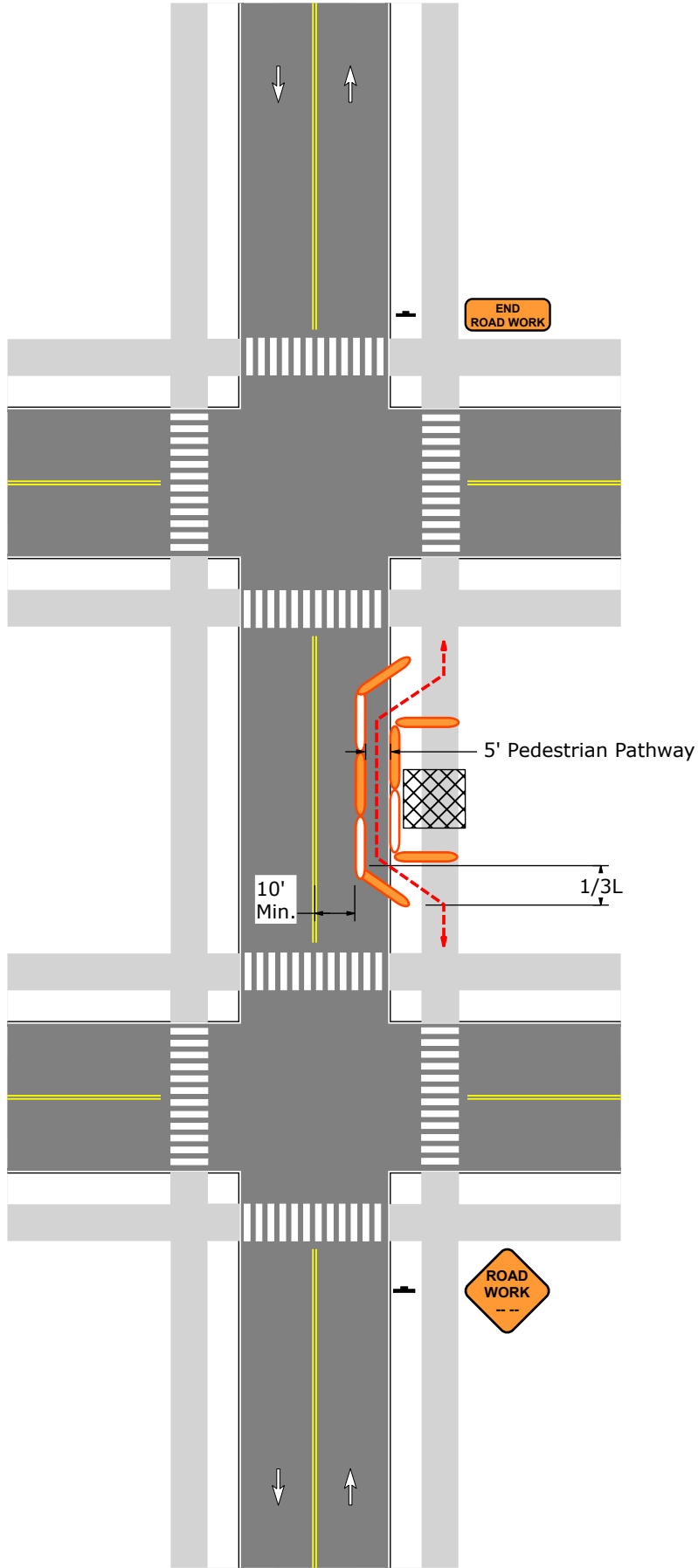
PATA 217

1. When crosswalks or other pedestrian facilities are closed or relocated, temporary facilities shall be detectable and shall include accessibility features consistent with the features present in the existing pedestrian facility.
2. Use channelizing devices to separate and maintain temporary pedestrian walkway while sidewalk is closed. Where high speeds are anticipated, a temporary traffic barrier with appropriate end treatments should be used to separate the temporary walkways from vehicular traffic.
3. Only the temporary traffic control devices related to pedestrians are shown. Other devices may be used to control vehicular traffic.
4. When it is not possible to maintain a minimum width of 60" throughout the entire length of the pedestrian pathway, a 60"x60" passing space should be provided at least every 200' to allow individuals in wheelchairs to pass. A minimum 48" wide accessible path shall be maintained for the length of sidewalk diversion. Temporary curb ramp access is required if pedestrian curb ramps exist at the nearest intersection.
5. Approved pedestrian barricades or channelizing devices must be placed at each closure to protect pedestrians from construction activities, drop-offs, and vehicular traffic. The pedestrian barriers or channelizing devices must be continuous, stable and non-flexible and consist of a wall, fence, or enclosures specified in MUTCD Sections 6F.63, 6F.68, and 6F.71 with detectable, continuous bottom edge 6 inches maximum height above the walkway surface. Support members may not protrude into the useable sidewalk. Sidewalk barriers shall be detectable by blind pedestrians or those who have low vision. Plastic tape, movable cones, and print signs at a sidewalk excavation will not generally provide adequate notice or protection.

Signs	
	
W20-1	G20-2









Taper Lengths and Minimum Number of Channelizing Devices		
Speed	Merging Taper: 1/3L	
S (MPH)	Length (Feet)	Minimum Number Of Devices
25	45	6
30	60	6
35	85	6
40	110	6
45	180	6
50	200	6
55	220	6

PATA 217

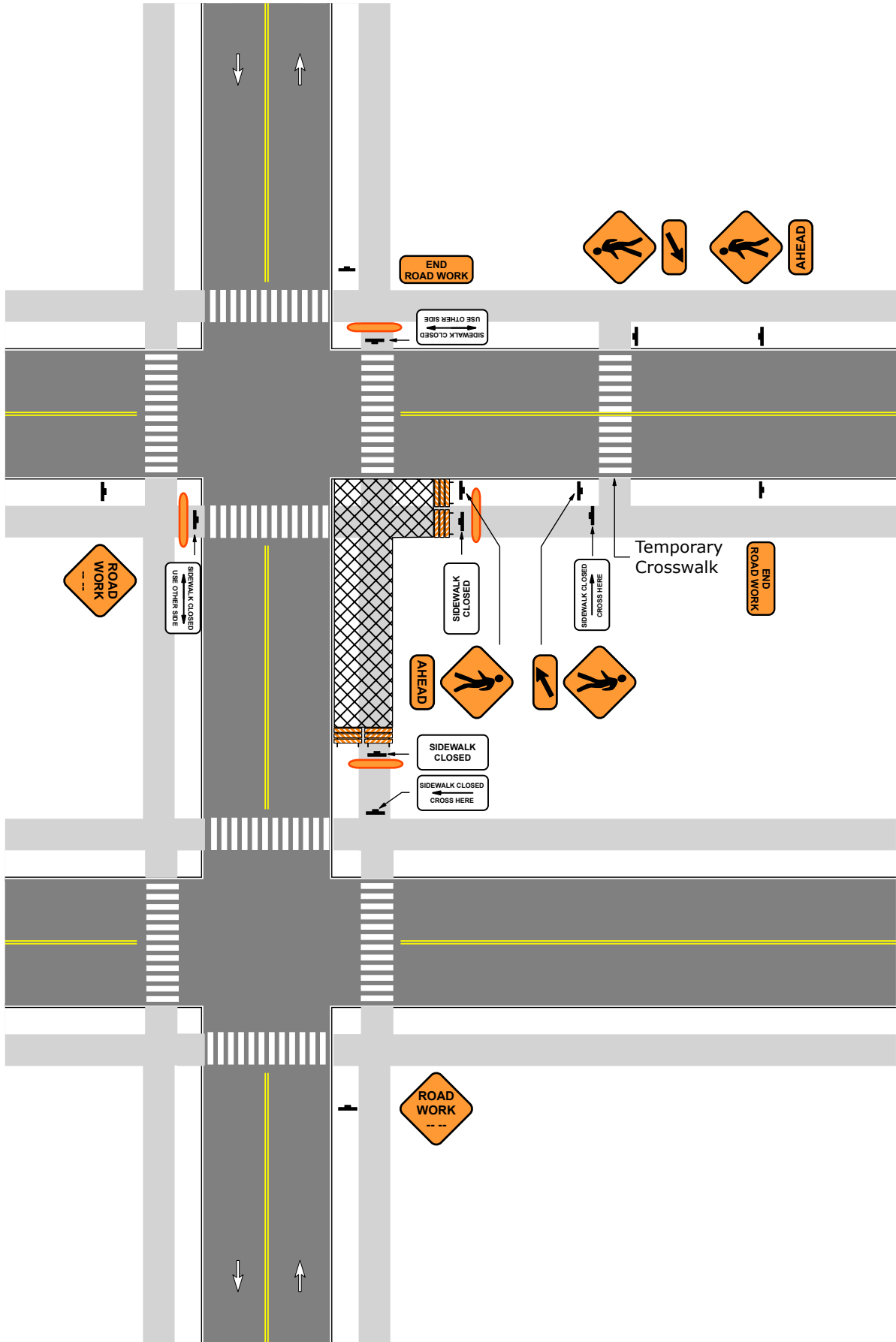


PATA 218

1. When crosswalks or other pedestrian facilities are closed or relocated and there is not an alternate marked crossing within 300', an engineering and traffic study is required to determine the appropriate location of a temporary pedestrian crossing. PennDOT approval shall be obtained prior to installing a midblock crosswalk. Pedestrian crossings shall be detectable and include accessibility features (curb ramps, landing areas, etc.) consistent with the features present in the existing pedestrian facility.
2. Parking is not permitted within 75' of a midblock crosswalk, unless a 6' to 8' curb extension is in place to improve pedestrian visibility.
3. Pedestrian traffic signal displays controlling closed crosswalks shall be covered and deactivated.
4. The width of the existing pedestrian facility should be provided for the temporary facility if practical. TTC devices and other construction materials and features should not intrude onto the usable width of the sidewalk, temporary pathway, or other pedestrian facility. When it is not possible to maintain a minimum width of 60" throughout the entire length of the pedestrian pathway, a 60"x60" passing space should be provided at least every 200' to allow individuals in wheelchairs to pass.
5. Approved pedestrian barricades or channelizing devices must be placed at each closure to protect pedestrians from construction activities, drop-offs, and vehicular traffic. The pedestrian barriers or channelizing devices must be continuous, stable and non-flexible and consist of a wall, fence, or enclosures specified in MUTCD Sections 6F.63, 6F.68, and 6F.71 with detectable, continuous bottom edge 6 inches maximum height above the walkway surface. Support members may not protrude into the useable sidewalk. Sidewalk barriers shall be detectable by blind pedestrians or those who have low vision. Plastic tape, movable cones, and print signs at a sidewalk excavation will not generally provide adequate notice or protection.




Signs							
							
W20-1	W11-2	W16-7P	W16-9P	G20-2	R9-9	R9-10	R9-11a

PATA 218



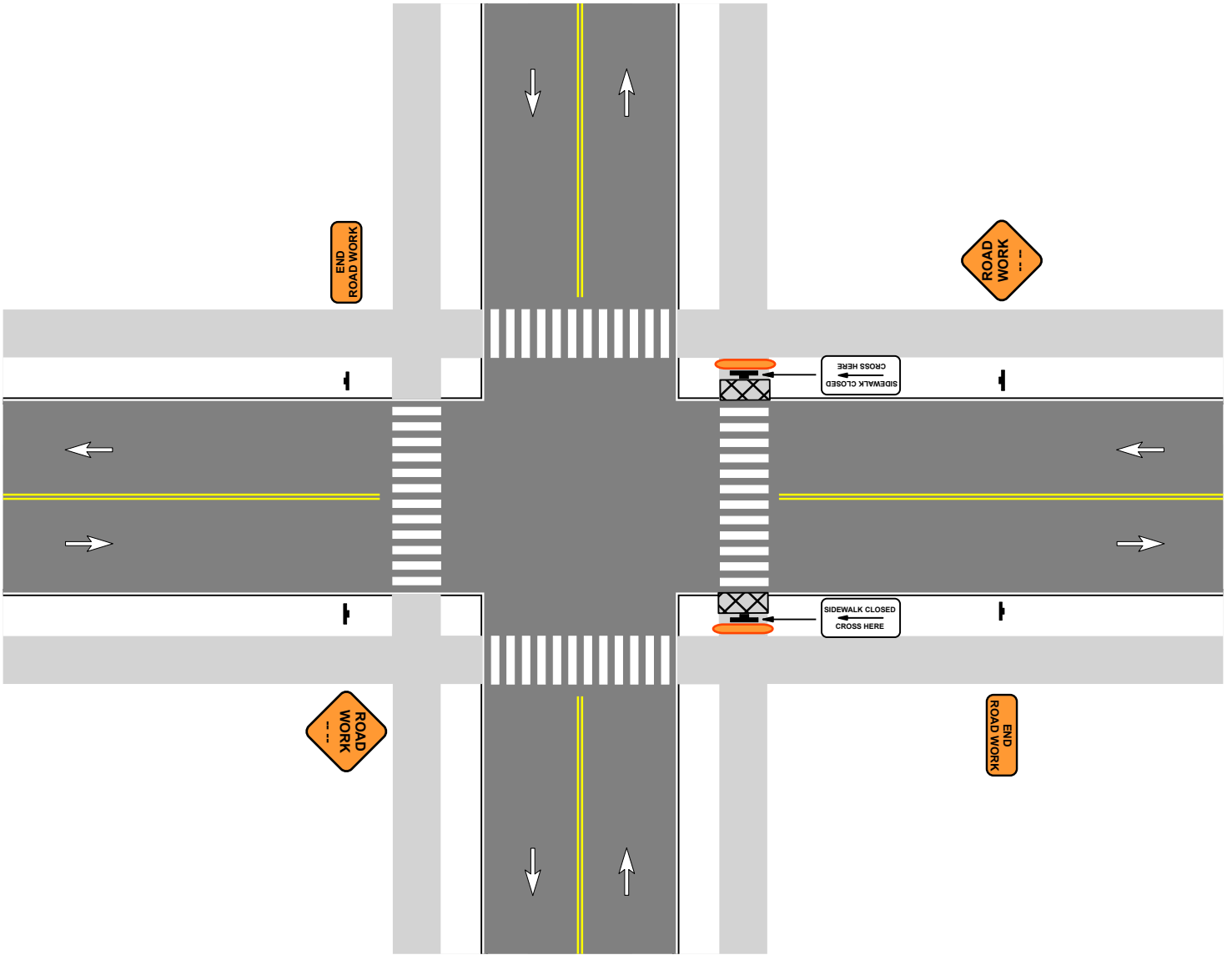
PATA 219

1. Construction or alterations affecting pedestrian crosswalks requires the provision of a safe, alternate and accessible pedestrian circulation path around the construction activities. Pedestrians must be able to utilize accessible crosswalks while navigating from a closure point to all other corners of the intersection during all phases of construction.
2. The alternate route must comply with all applicable design guidelines to the maximum extent feasible under existing conditions so that the usability of the accessible route is maintained.
3. The alternate route must be kept in place through the duration of the construction activity and must be clearly signed for pedestrian use.
4. Walking surfaces must be firm, stable, slip-resistant, at least 60 inches wide and be maintained free of rubble or debris that would adversely affect the movement of persons with mobility problems. The width may be reduced to 48 inches if passing areas 60 inches x 60 inches are provided every 200 feet.
5. Approved pedestrian barricades or channelizing devices must be placed at each closure to protect pedestrians from construction activities, drop-offs, and vehicular traffic. The pedestrian barriers or channelizing devices must be continuous, stable and non-flexible and consist of a wall, fence, or enclosures specified in MUTCD Sections 6F.63, 6F.68, and 6F.71 with detectable, continuous bottom edge 6 inches maximum height above the walkway surface. Support members may not protrude into the useable sidewalk. Sidewalk barriers shall be detectable by blind pedestrians or those who have low vision. Plastic tape, movable cones, and print signs at a sidewalk excavation will not generally provide adequate notice or protection.
6. Refer to PATA 218 when a mid-block crossing is necessary as part of a pedestrian detour.
7. Work at intersections that restrict pedestrian access to crosswalks shall be limited to one crossing at a time so pedestrians can fully navigate around the closure. Otherwise, a reasonable pedestrian detour must be established that utilizes crosswalks of adjacent intersections or temporary midblock crosswalks (refer to PATA 218). Work shall not be performed that results in closing pedestrian access without providing an accessible pedestrian detour.

Signs		
		
W20-1	G20-2	R9-11a

Sign Spacing		
Speed	Sign Spacing	
	Urban	Rural
S (MPH)	A (Feet)	A (Feet)
25	100 - 200	500 - 800
30	100 - 200	500 - 800
35	100 - 200	500 - 800
40	350 - 500	500 - 800
45	350 - 500	500 - 800
50	350 - 500	500 - 800
55	350 - 500	500 - 800

PATA 219



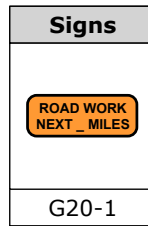
Blank Page

Conventional Highways

Mobile Operations
(PATA 300 Series)

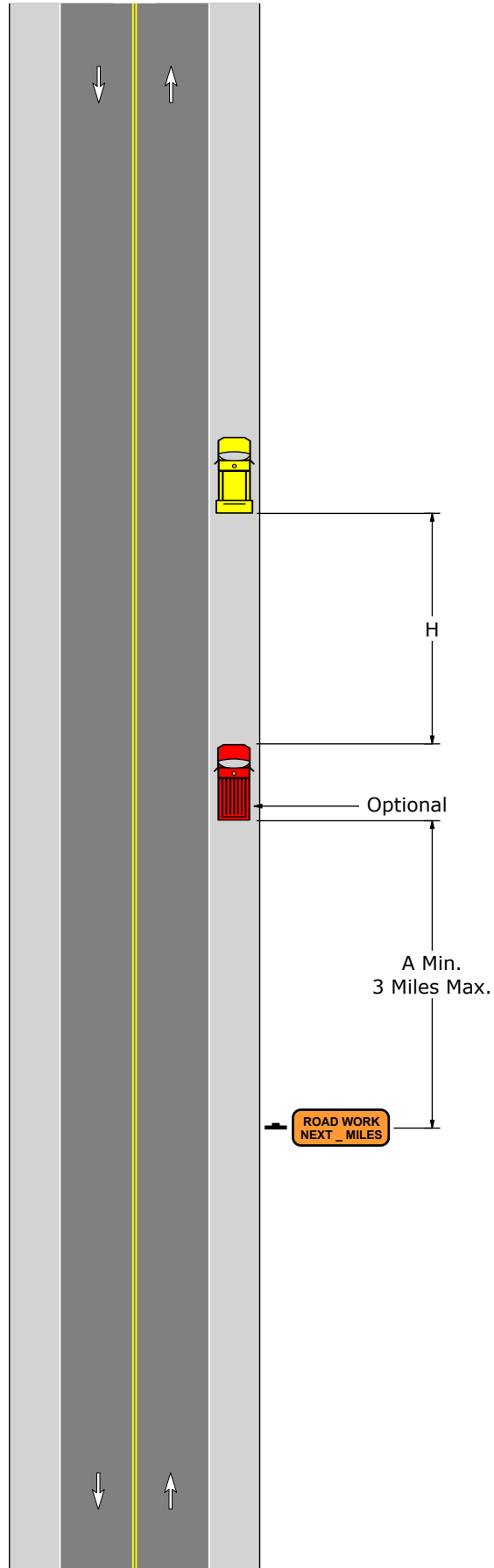
PATA 301-A

1. TTC devices are not required if the work space is outside the highway right-of-way, behind barrier, more than 2' behind curb, or 15' or more from the edge of any roadway.
2. For operations 60 minutes or less, the ROAD WORK NEXT _ MILES sign may be eliminated.
3. When a shadow vehicle is not used, distance A is measured from the ROAD WORK NEXT _ MILES sign to the work vehicle.
4. TTC warning signs may be mounted on the work vehicle, shadow vehicle, or trailer that moves with the operation in lieu of the roadside warning sign.



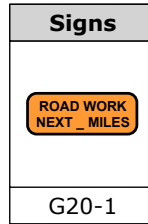
Sign Spacing and Roll Ahead Space			
Speed	Sign Spacing		Roll Ahead Space
	Urban	Rural	
S (MPH)	A (Feet)	A (Feet)	H (Feet)
25	100 - 200	500 - 800	150
30	100 - 200	500 - 800	150
35	100 - 200	500 - 800	150
40	350 - 500	500 - 800	150
45	350 - 500	500 - 800	150
50	350 - 500	500 - 800	250
55	350 - 500	500 - 800	250

PATA 301-A



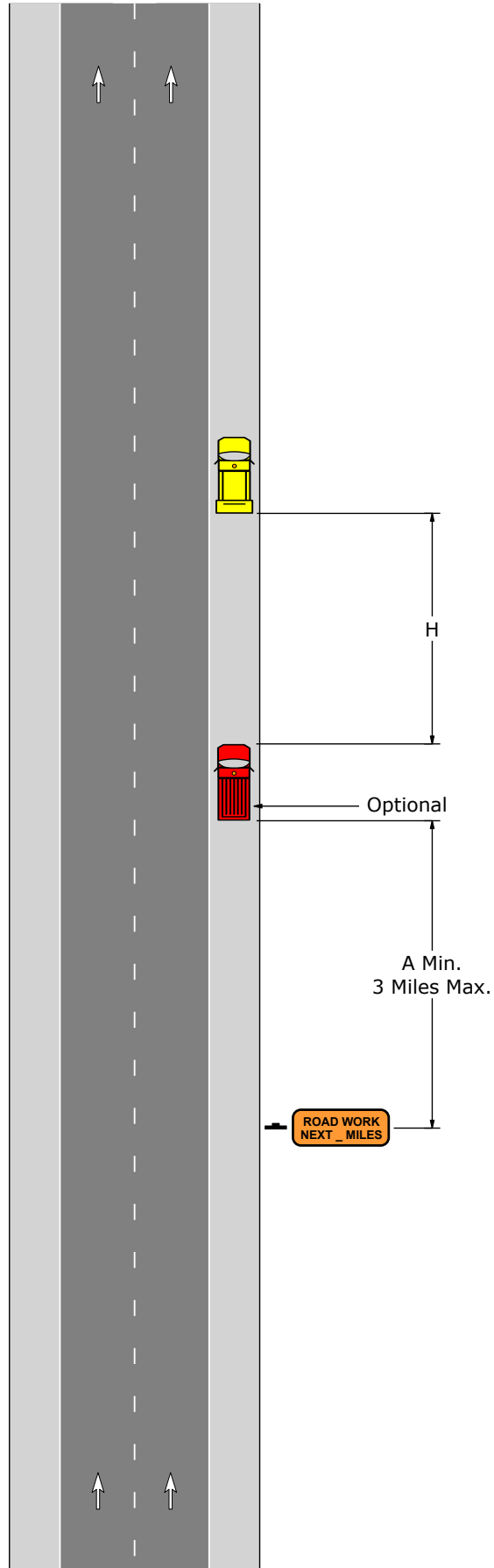
PATA 301-B

1. TTC devices are not required if the work space is outside the highway right-of-way, behind barrier, more than 2' behind curb, or 15' or more from the edge of any roadway.
2. For operations 60 minutes or less, the ROAD WORK NEXT _ MILES sign may be eliminated.
3. When a shadow vehicle is not used, distance A is measured from the ROAD WORK NEXT _ MILES sign to the work vehicle.
4. TTC warning signs may be mounted on the work vehicle, shadow vehicle, or trailer that moves with the operation in lieu of the roadside warning sign.



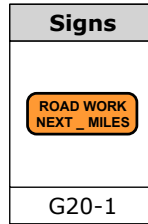
Sign Spacing and Roll Ahead Space			
Speed	Sign Spacing		Roll Ahead Space
	Urban	Rural	
S (MPH)	A (Feet)	A (Feet)	H (Feet)
25	100 - 200	500 - 800	150
30	100 - 200	500 - 800	150
35	100 - 200	500 - 800	150
40	350 - 500	500 - 800	150
45	350 - 500	500 - 800	150
50	350 - 500	500 - 800	250
55	350 - 500	500 - 800	250

PATA 301-B



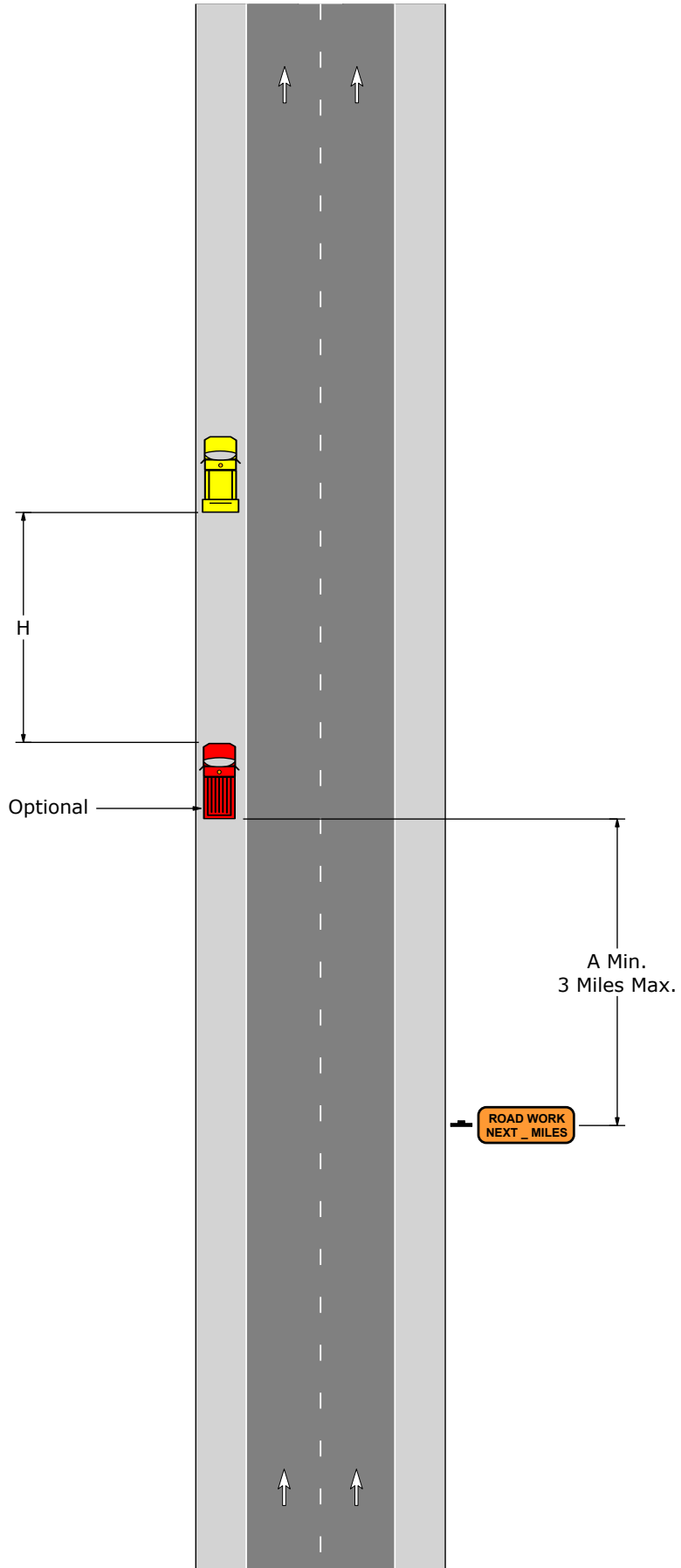
PATA 301-C

1. TTC devices are not required if the work space is outside the highway right-of-way, behind barrier, more than 2' behind curb, or 15' or more from the edge of any roadway.
2. For operations 60 minutes or less, the ROAD WORK NEXT _ MILES sign may be eliminated.
3. When a shadow vehicle is not used, distance A is measured from the ROAD WORK NEXT _ MILES sign to the work vehicle.
4. TTC warning signs may be mounted on the work vehicle, shadow vehicle, or trailer that moves with the operation in lieu of the roadside warning sign.



Sign Spacing and Roll Ahead Space			
Speed	Sign Spacing		Roll Ahead Space
	Urban	Rural	
S (MPH)	A (Feet)	A (Feet)	H (Feet)
25	100 - 200	500 - 800	150
30	100 - 200	500 - 800	150
35	100 - 200	500 - 800	150
40	350 - 500	500 - 800	150
45	350 - 500	500 - 800	150
50	350 - 500	500 - 800	250
55	350 - 500	500 - 800	250

PATA 301-C



PATA 302

1. Flaggers are permitted to relocate by walking with the operation if minimum visibility (Distance E) to approaching traffic and control of traffic is maintained.

2. Utilize the Flagger Relocation Methods (Figures 302-2 through 302-13) to relocate flaggers when minimum visibility (Distance E) to approaching traffic or control of traffic cannot be maintained. The three methods to relocate flaggers are:

- a) Walking
 - Downstream Flagger (Figures 302-2 & 302-3)
 - Upstream Flagger (Figures 302-4 & 302-5)
- b) Work Vehicle
 - Downstream Flagger (Figures 302-6 & 302-7)
 - Upstream Flagger (Figures 302-8 & 302-9)
- c) Pilot Vehicle
 - Downstream Flagger (Figures 302-10 & 302-11)
 - Upstream Flagger (Figures 302-12 & 302-13)

Note: Adjustments may be made to the flagger relocation methods (Figures 302-2 through 302-13) to accommodate the operation.

3. Flaggers are not permitted to relocate while holding stopped traffic.

4. Interim BE PREPARED TO STOP signs are required for any project over 1 mile in length and shall be spaced at intervals not exceeding one mile.






5. If a pilot vehicle is utilized:

- a) The highway ADT must be 5000 or less.
- b) Distance and time requirements (i.e. minimum of 100' every 15 minutes) for mobile operations are waived.
- c) The shadow vehicle is optional. When a shadow vehicle is not used, 100' minimum is required from the upstream flagger to the rear of the work vehicle or nearest worker, whichever is closer.

6. If a mobile operation moves too slowly to meet the distance and time requirements (i.e. minimum of 100' every 15 minutes), one of the following options shall be utilized:

- a) A pilot vehicle.
- b) Set up the Temporary Work Stoppage/Slowdown (Figure 302-1).
 - May be used for a maximum of 60 consecutive minutes. Utilize one of the other options if the temporary work stoppage/slowdown will exceed 60 minutes.
- c) Set up a short-term stationary PATA (100 Series).
- d) Remove workers and equipment from the roadway until the operation can resume.

PATA 302

Signs				
				
W20-1	W20-4	W20-7	W3-4	G20-4

Sign Spacing, Channelizing Device Spacing, Roll Ahead Space, and Flagger Visibility					
Speed	Channelizing Devices Spacing	Sign Spacing		Roll Ahead Space	Flagger Visibility
		Urban	Rural		
S (MPH)	2S (Feet)	A (Feet)	A (Feet)	H (Feet)	E (Feet)
25	50	100 - 200	500 - 800	150	155
30	60	100 - 200	500 - 800	150	200
35	70	100 - 200	500 - 800	150	250
40	80	350 - 500	500 - 800	150	305
45	90	350 - 500	500 - 800	150	360
50	100	350 - 500	500 - 800	250	425
55	110	350 - 500	500 - 800	250	495

Taper Lengths and Minimum Number of Channelizing Devices		
Speed	50' Per Lane Taper	
S (MPH)	Length (Feet)	Minimum Number of Devices
25	50	6
30	50	6
35	50	6
40	50	6
45	50	6
50	50	6
55	50	6

PATA 302

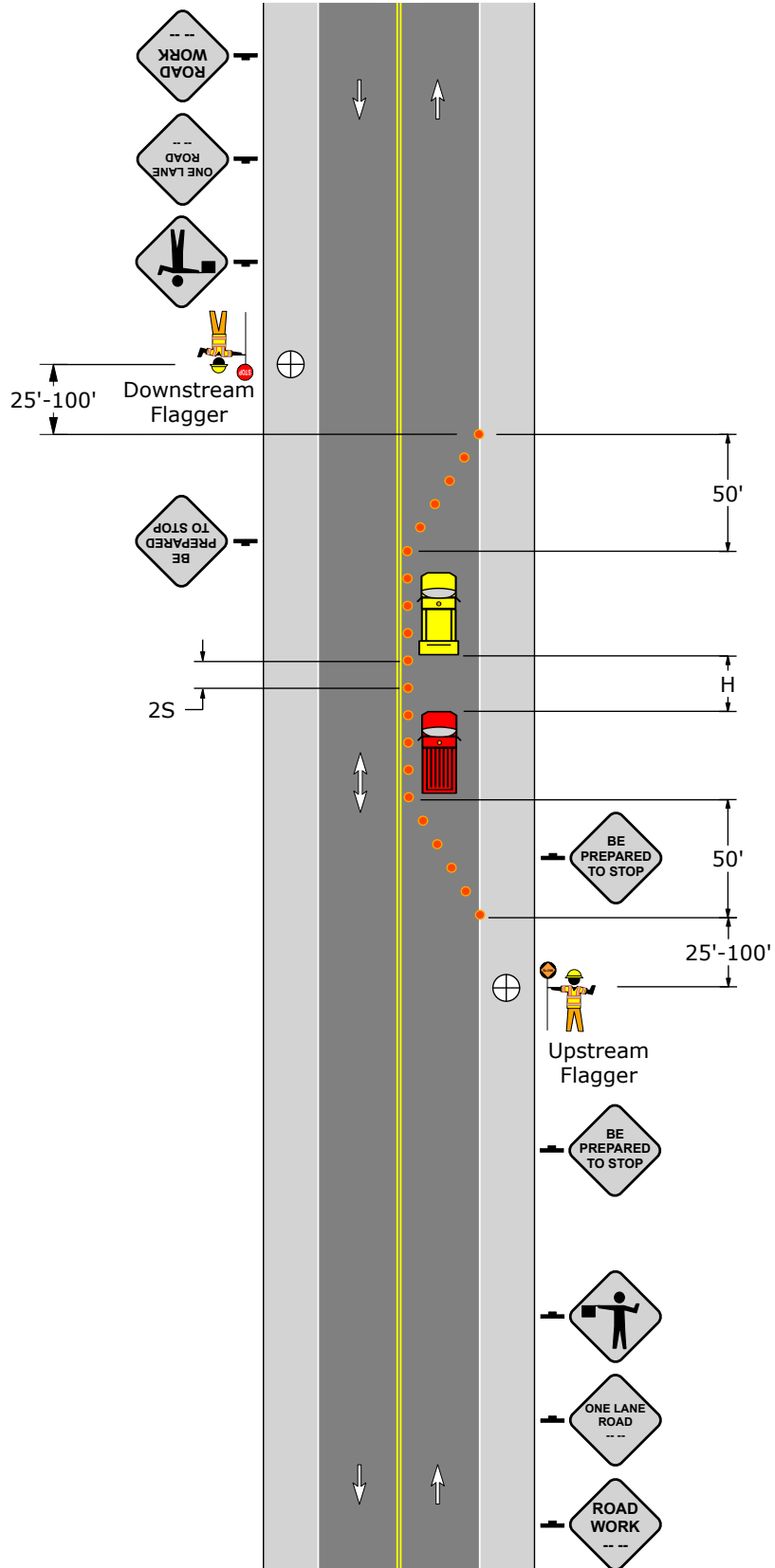
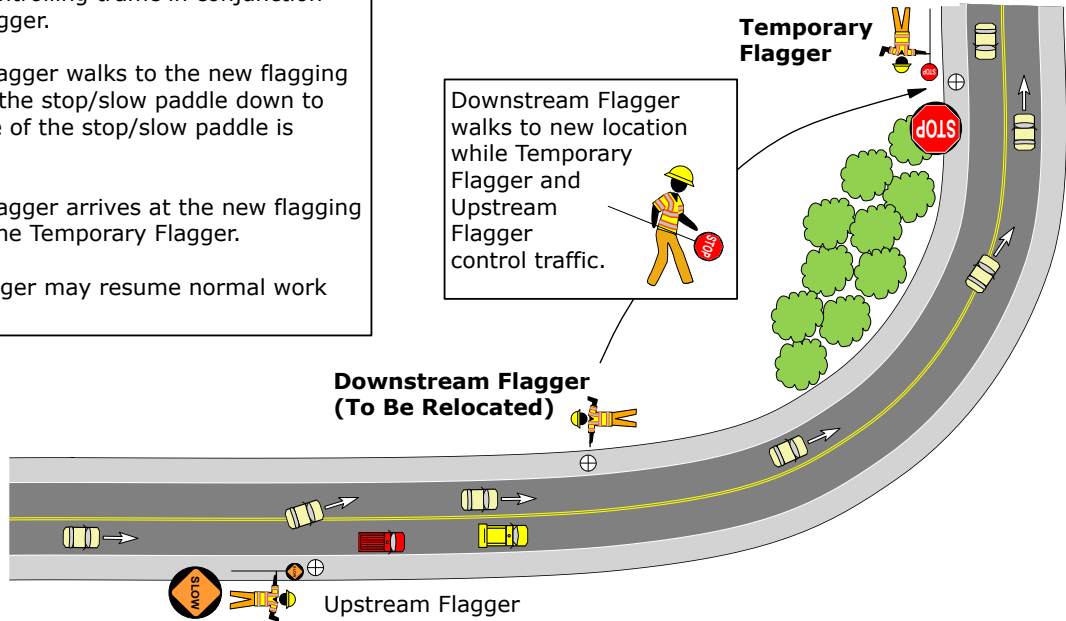


Figure 302-1
Temporary Work Stoppage/Slowdown

Walking Method: Downstream Flagger Relocation

PROCEDURE:

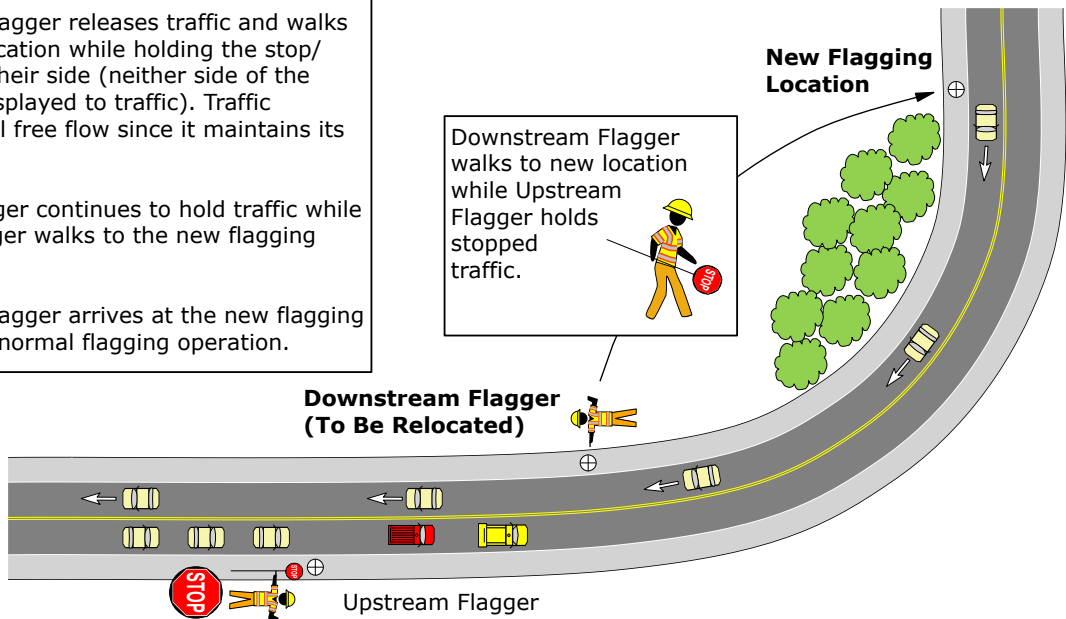
1. A Temporary Flagger is placed at a new downstream location and begins controlling traffic in conjunction with the Upstream Flagger.
2. The Downstream Flagger walks to the new flagging location while holding the stop/slow paddle down to their side (neither side of the stop/slow paddle is displayed to traffic).
3. The Downstream Flagger arrives at the new flagging location and relieves the Temporary Flagger.
4. The Temporary Flagger may resume normal work duties.



**Figure 302-2
Temporary Flagger Utilized**

PROCEDURE:

1. The Upstream Flagger stops and holds traffic.
2. The Downstream Flagger releases traffic and walks to the new flagging location while holding the stop/slow paddle down to their side (neither side of the stop/slow paddle is displayed to traffic). Traffic traveling upstream will free flow since it maintains its original travel lane.
3. The Upstream Flagger continues to hold traffic while the Downstream Flagger walks to the new flagging location.
4. The Downstream Flagger arrives at the new flagging location and resumes normal flagging operation.



**Figure 302-3
No Temporary Flagger Utilized**

Walking Method: Upstream Flagger Relocation

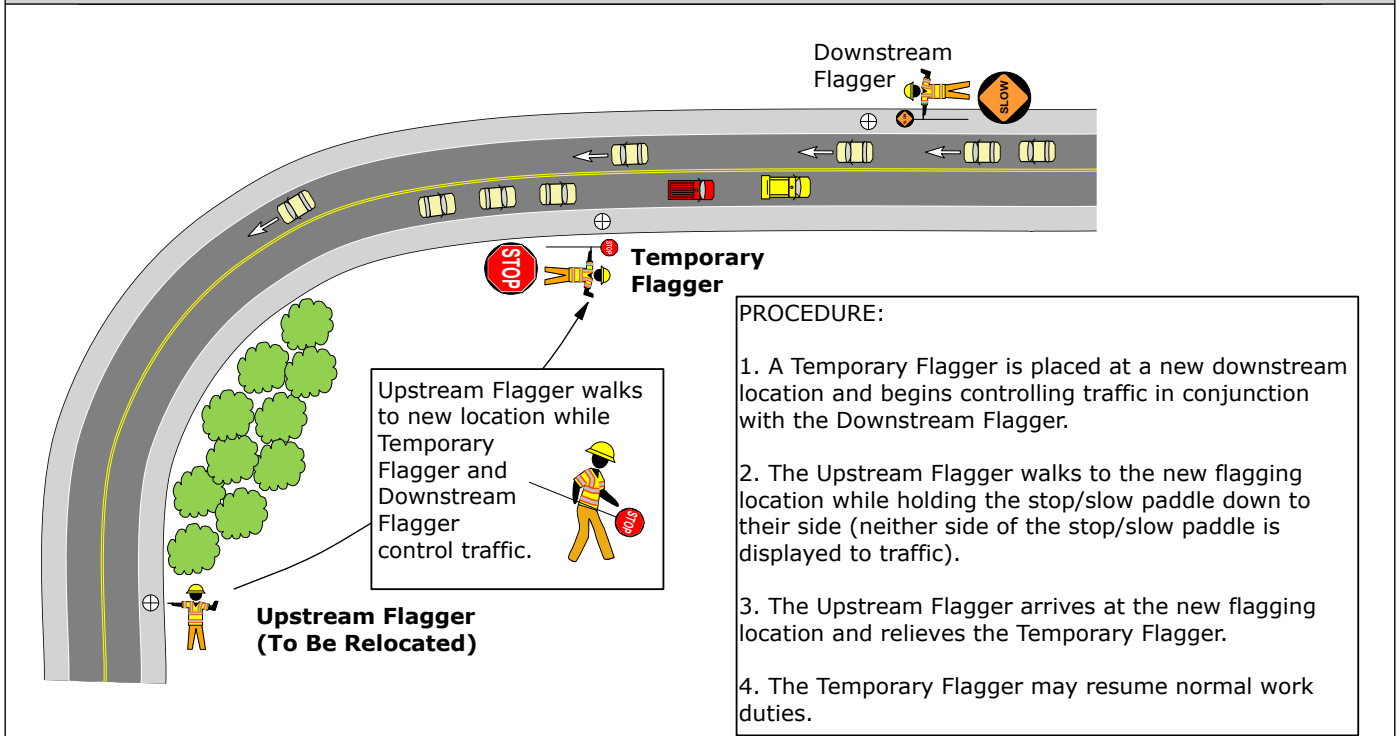


Figure 302-4
Temporary Flagger Utilized

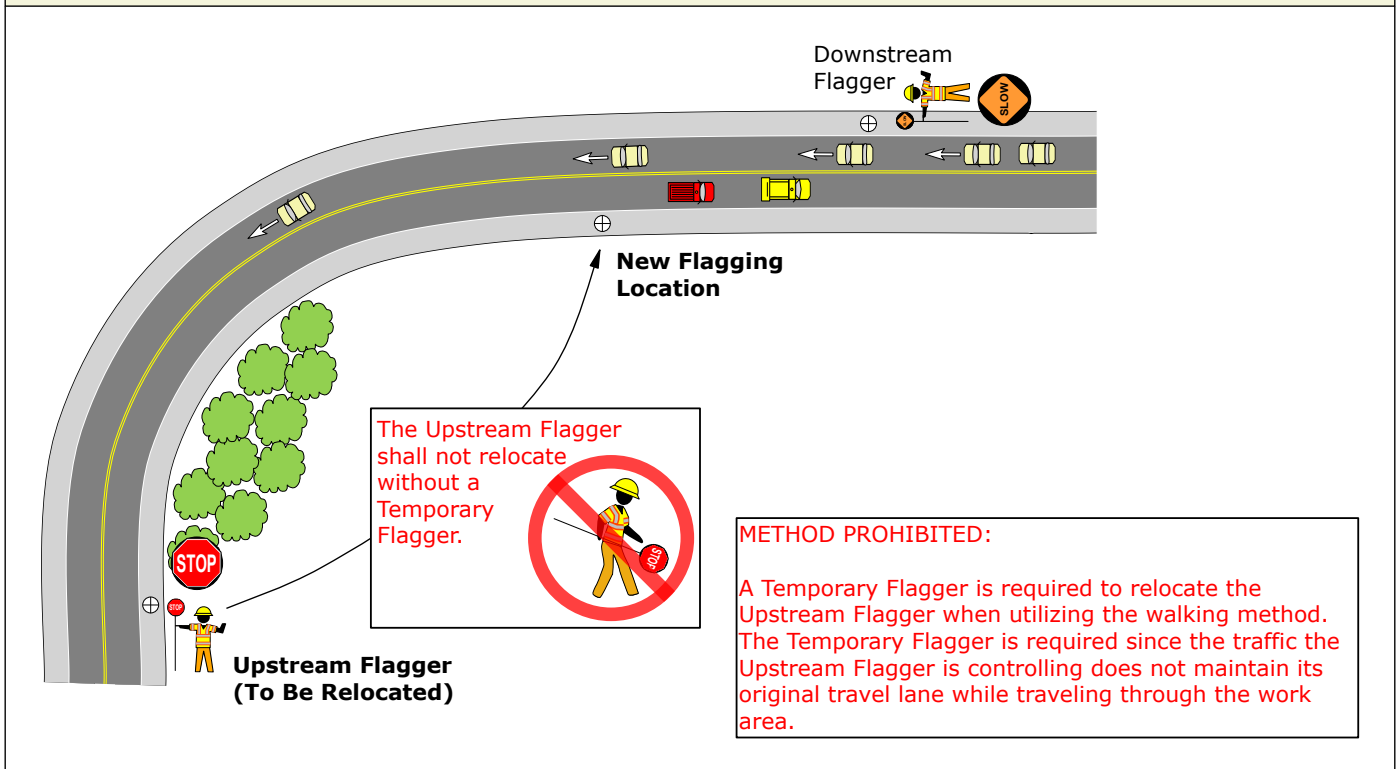
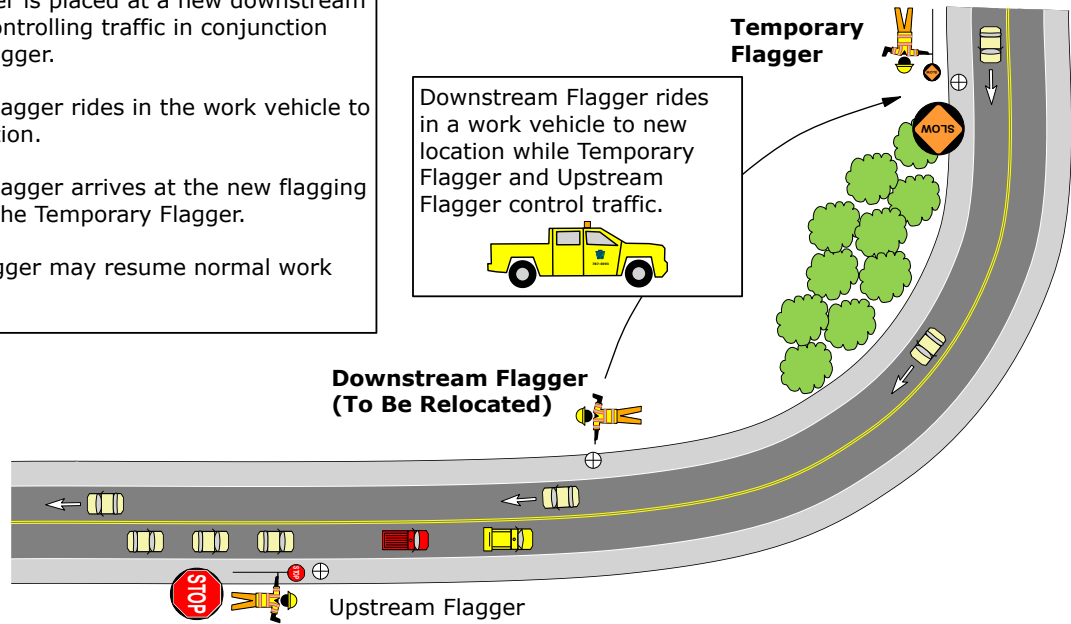


Figure 302-5
No Temporary Flagger Utilized

Work Vehicle Method: Downstream Flagger Relocation

PROCEDURE:

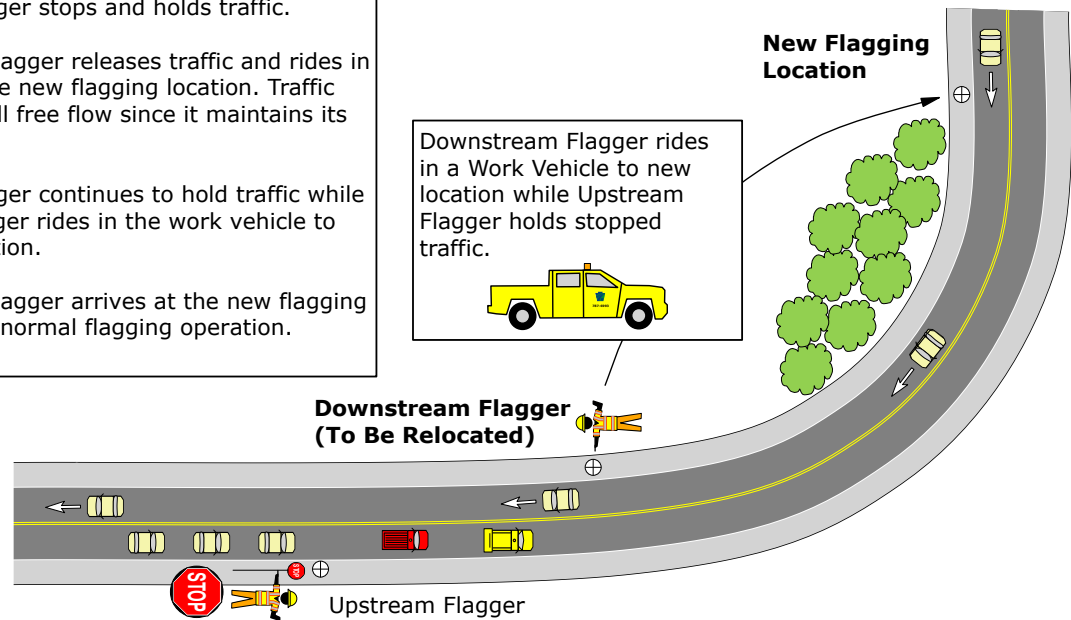
1. A Temporary Flagger is placed at a new downstream location and begins controlling traffic in conjunction with the Upstream Flagger.
2. The Downstream Flagger rides in the work vehicle to the new flagging location.
3. The Downstream Flagger arrives at the new flagging location and relieves the Temporary Flagger.
4. The Temporary Flagger may resume normal work duties.



**Figure 302-6
Temporary Flagger Utilized**

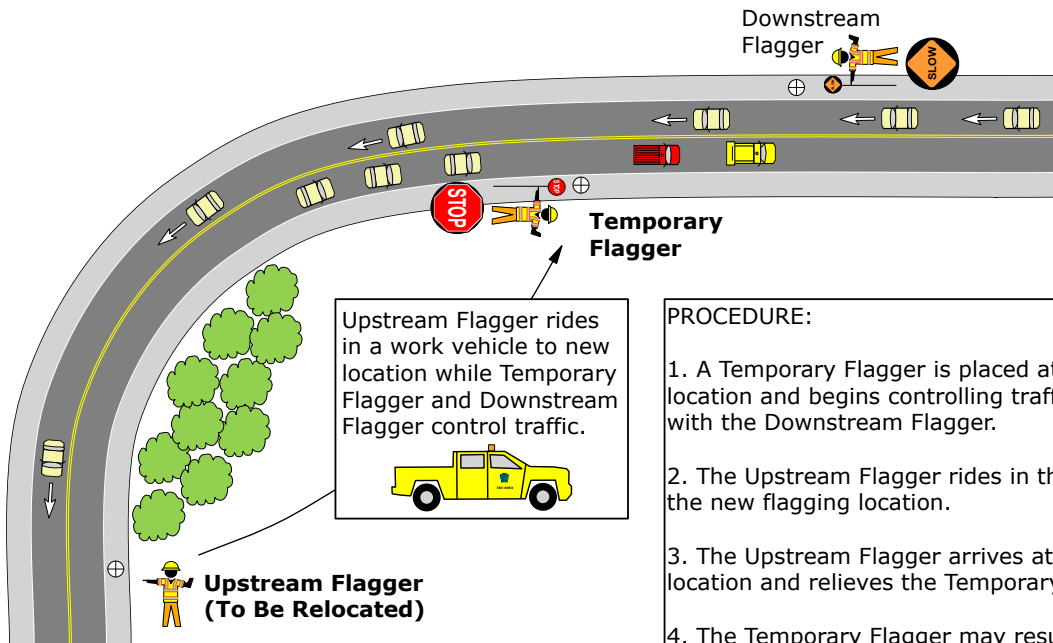
PROCEDURE:

1. The Upstream Flagger stops and holds traffic.
2. The Downstream Flagger releases traffic and rides in the work vehicle to the new flagging location. Traffic traveling upstream will free flow since it maintains its original travel lane.
3. The Upstream Flagger continues to hold traffic while the Downstream Flagger rides in the work vehicle to the new flagging location.
4. The Downstream Flagger arrives at the new flagging location and resumes normal flagging operation.



**Figure 302-7
No Temporary Flagger Utilized**

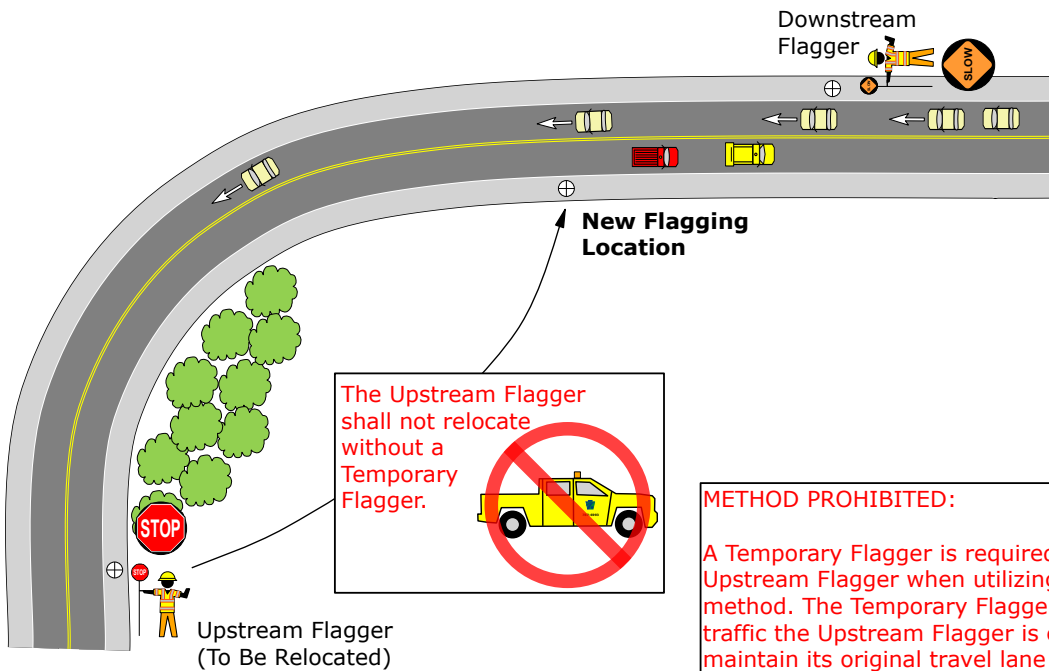
Work Vehicle Method: Upstream Flagger Relocation



PROCEDURE:

1. A Temporary Flagger is placed at a new downstream location and begins controlling traffic in conjunction with the Downstream Flagger.
2. The Upstream Flagger rides in the work vehicle to the new flagging location.
3. The Upstream Flagger arrives at the new flagging location and relieves the Temporary Flagger.
4. The Temporary Flagger may resume normal work duties.

**Figure 302-8
Temporary Flagger Utilized**



METHOD PROHIBITED:

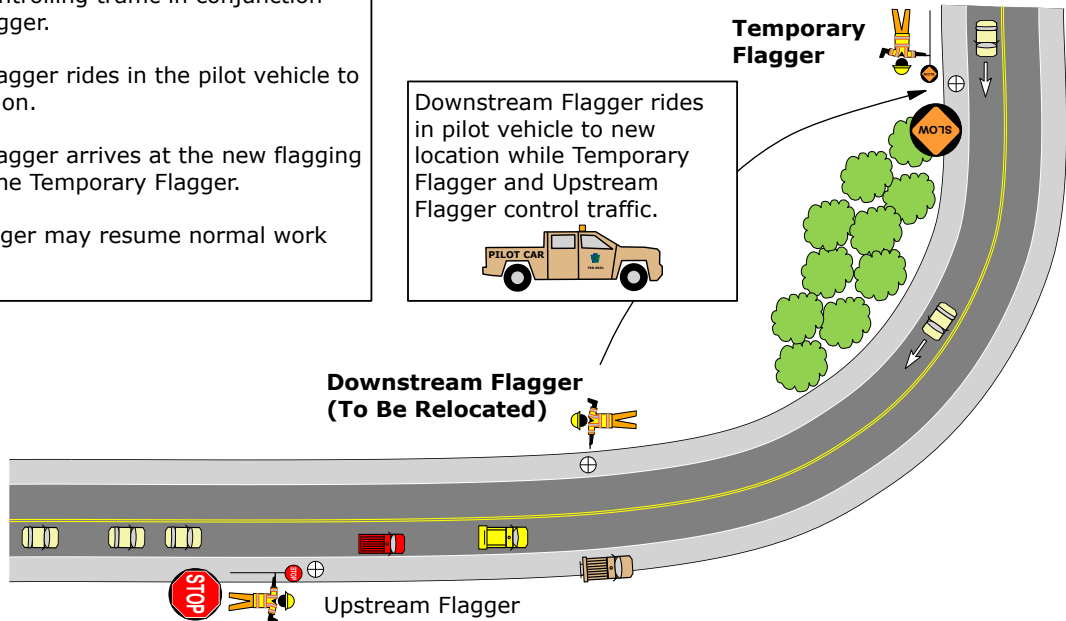
A Temporary Flagger is required to relocate the Upstream Flagger when utilizing the work vehicle method. The Temporary Flagger is required since the traffic the Upstream Flagger is controlling does not maintain its original travel lane while traveling through the work area.

**Figure 302-9
No Temporary Flagger Utilized**

Pilot Vehicle Method: Downstream Flagger Relocation

PROCEDURE:

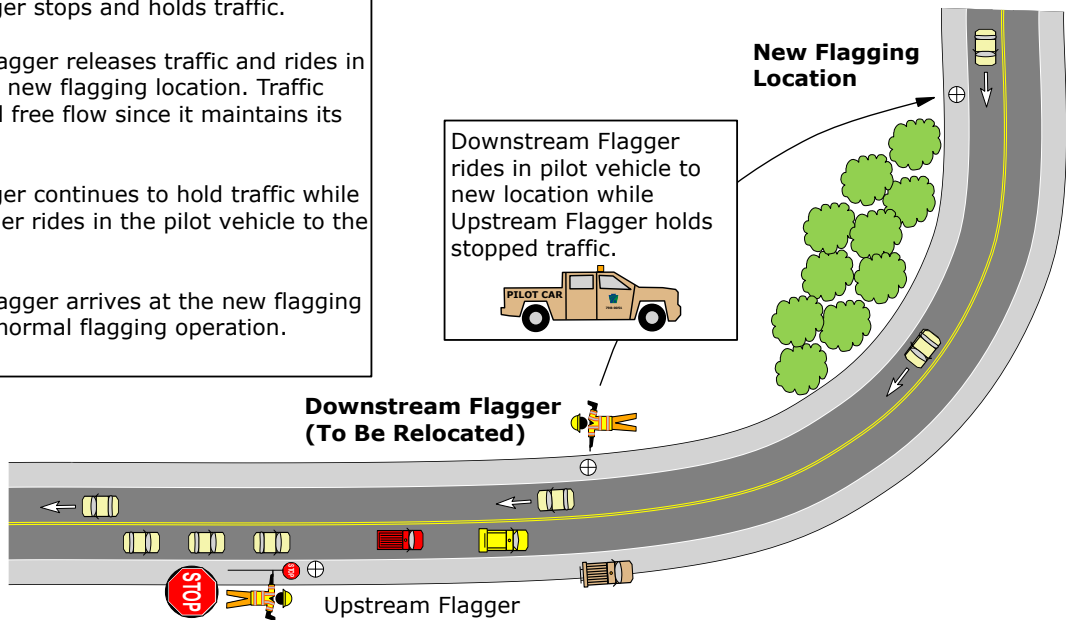
1. A Temporary Flagger is placed at a new downstream location and begins controlling traffic in conjunction with the Upstream Flagger.
2. The Downstream Flagger rides in the pilot vehicle to the new flagging location.
3. The Downstream Flagger arrives at the new flagging location and relieves the Temporary Flagger.
4. The Temporary Flagger may resume normal work duties.



**Figure 302-10
Temporary Flagger Utilized**

PROCEDURE:

1. The Upstream Flagger stops and holds traffic.
2. The Downstream Flagger releases traffic and rides in the pilot vehicle to the new flagging location. Traffic traveling upstream will free flow since it maintains its original travel lane.
3. The Upstream Flagger continues to hold traffic while the Downstream Flagger rides in the pilot vehicle to the new flagging location.
4. The Downstream Flagger arrives at the new flagging location and resumes normal flagging operation.



**Figure 302-11
No Temporary Flagger Utilized**

Pilot Vehicle Method: Upstream Flagger Relocation

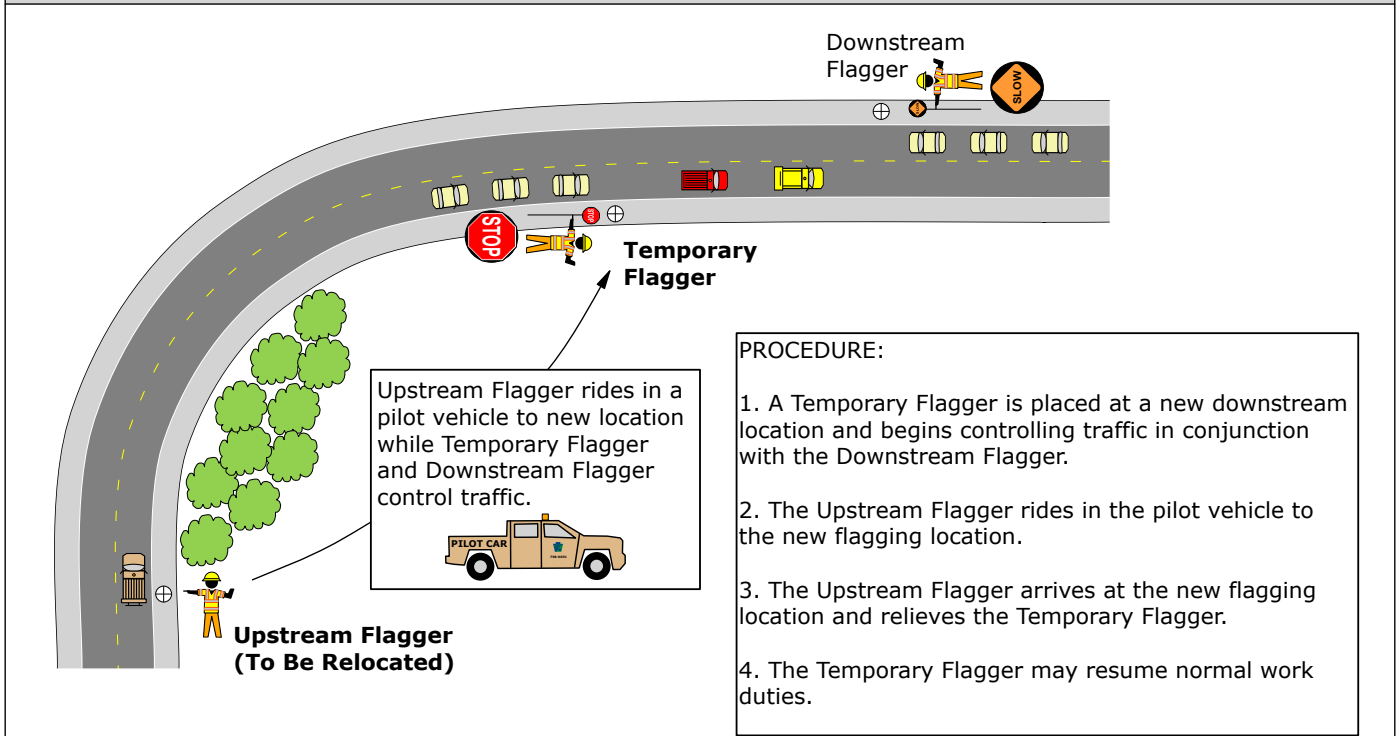


Figure 302-12
Temporary Flagger Utilized

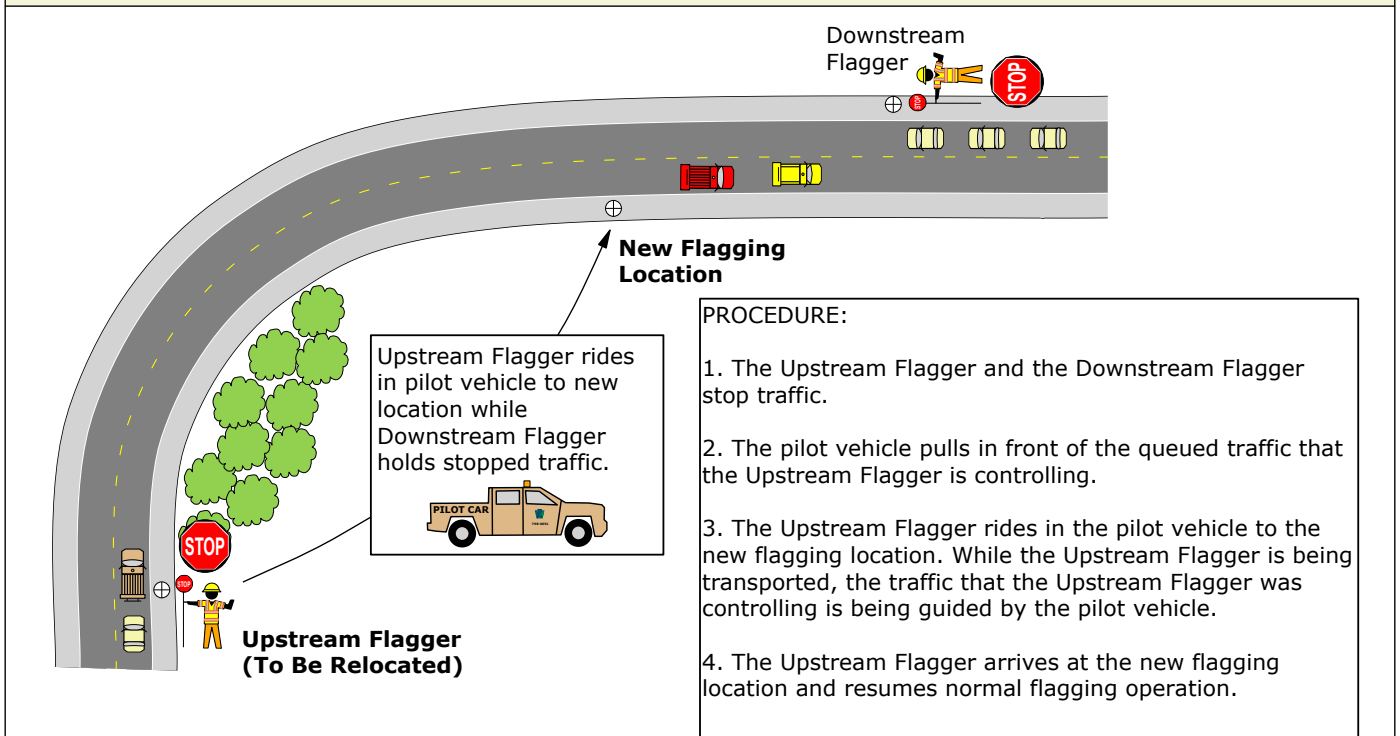
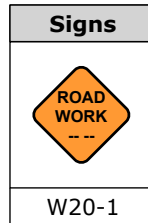


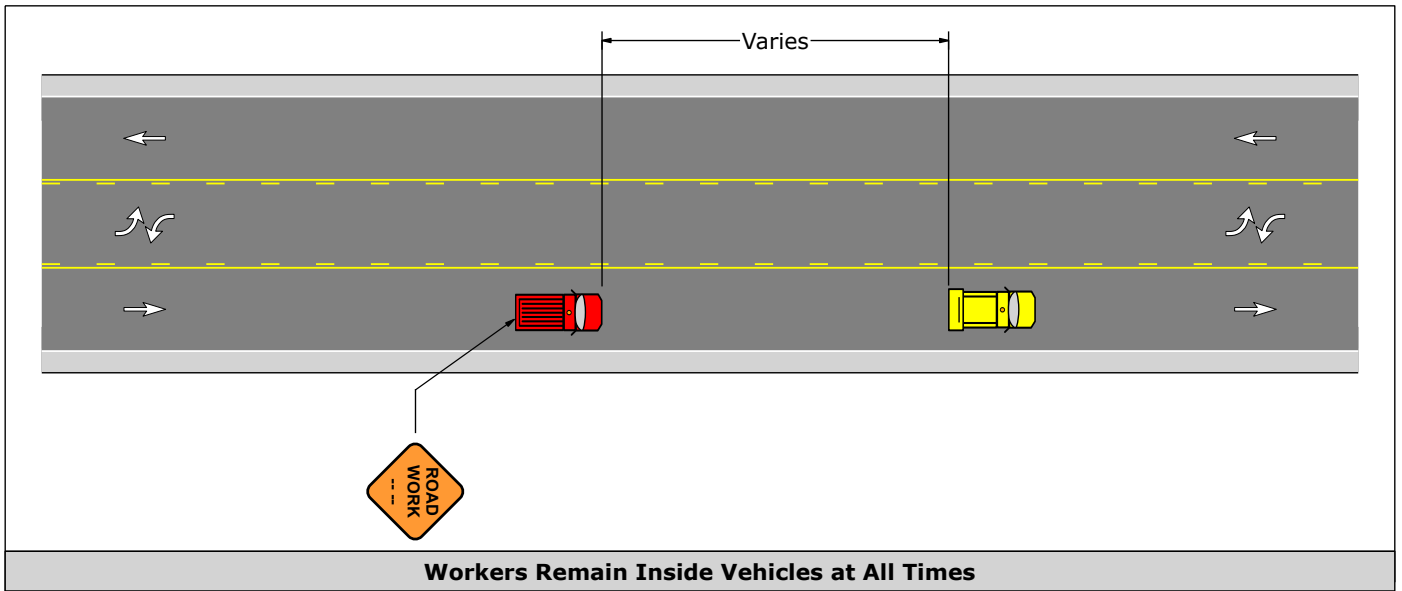
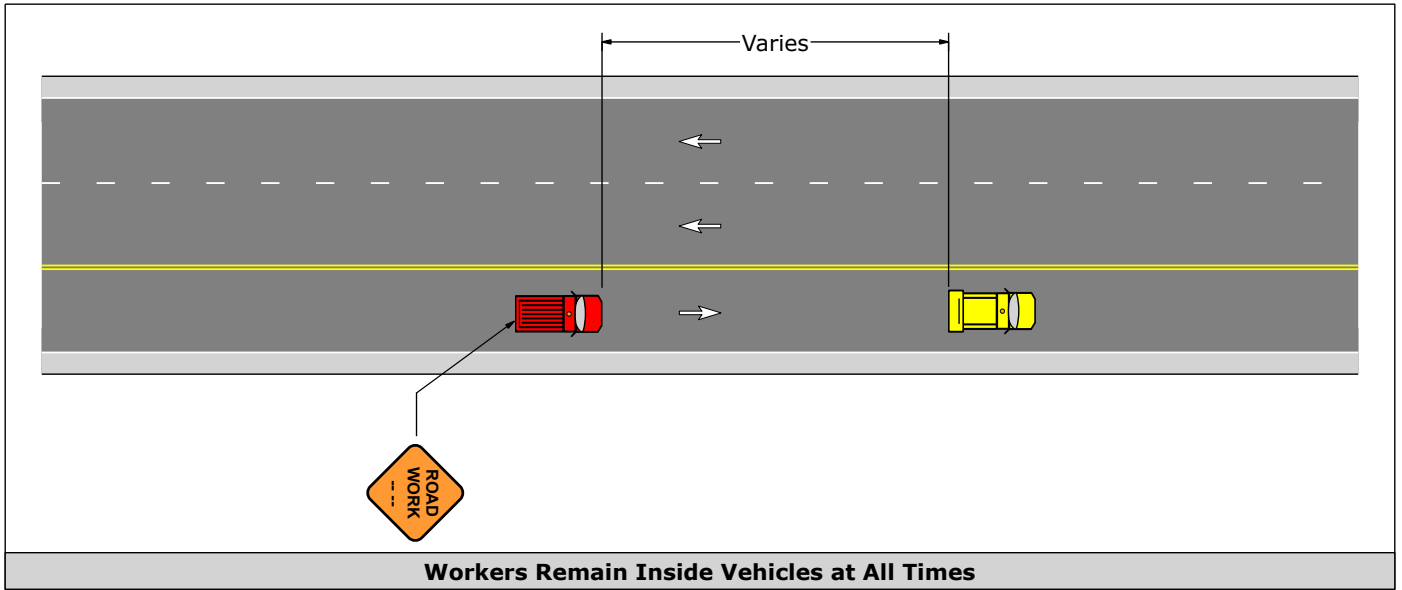
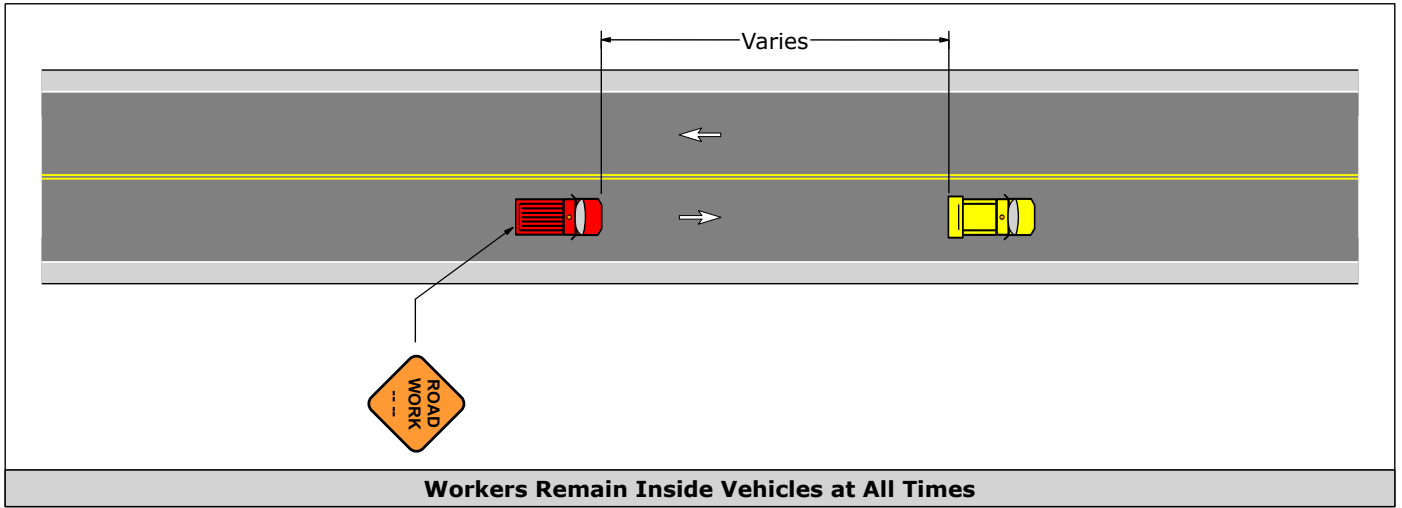
Figure 302-13
No Temporary Flagger Utilized

PATA 303

1. This PATA shall only be utilized when all workers remain inside vehicles for the entire length and duration of the operation.
2. Spacing between the shadow vehicle and work vehicle may vary to deter traffic from driving in between. The variation in distance between shadow vehicles is dependent on the speed, sight distance, and type of operation. Whenever adequate stopping sight distance exists to the rear, shadow vehicles should maintain a reasonable distance and proceed at the same speed as the work operation vehicle. The shadow vehicles should slow down in advance of vertical or horizontal curves that restrict sight distance.
3. Where passing is not permitted for extended lengths, the shadow and work vehicles should leave the roadway periodically in order to allow queued traffic to pass and resume normal speeds.



PATA 303

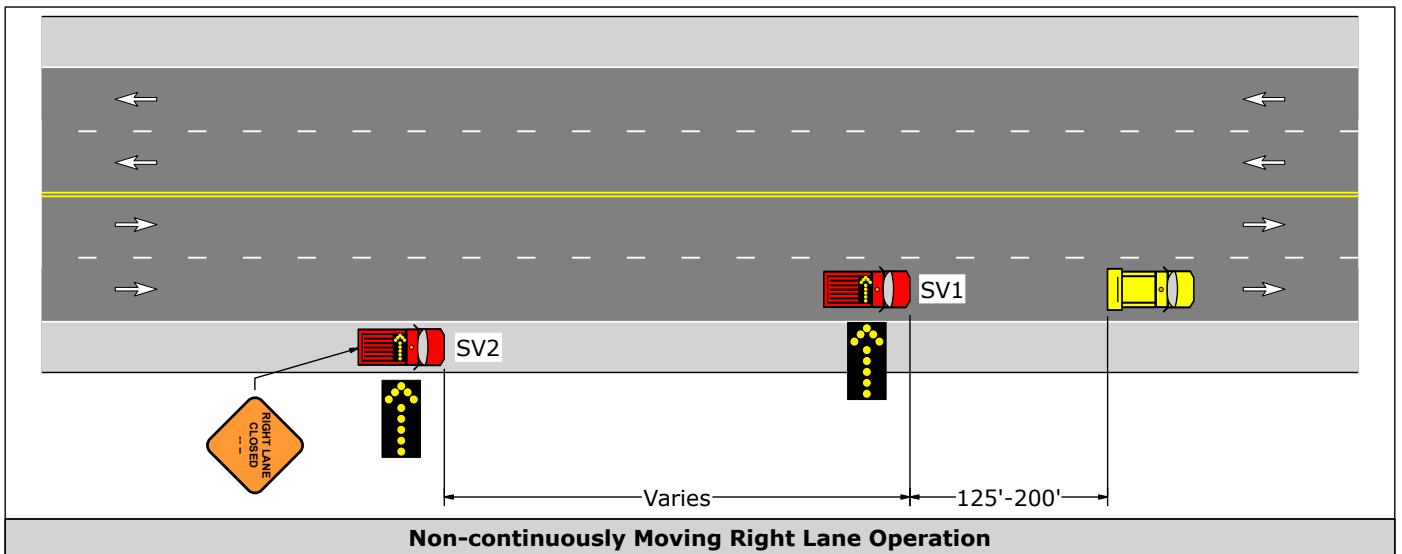
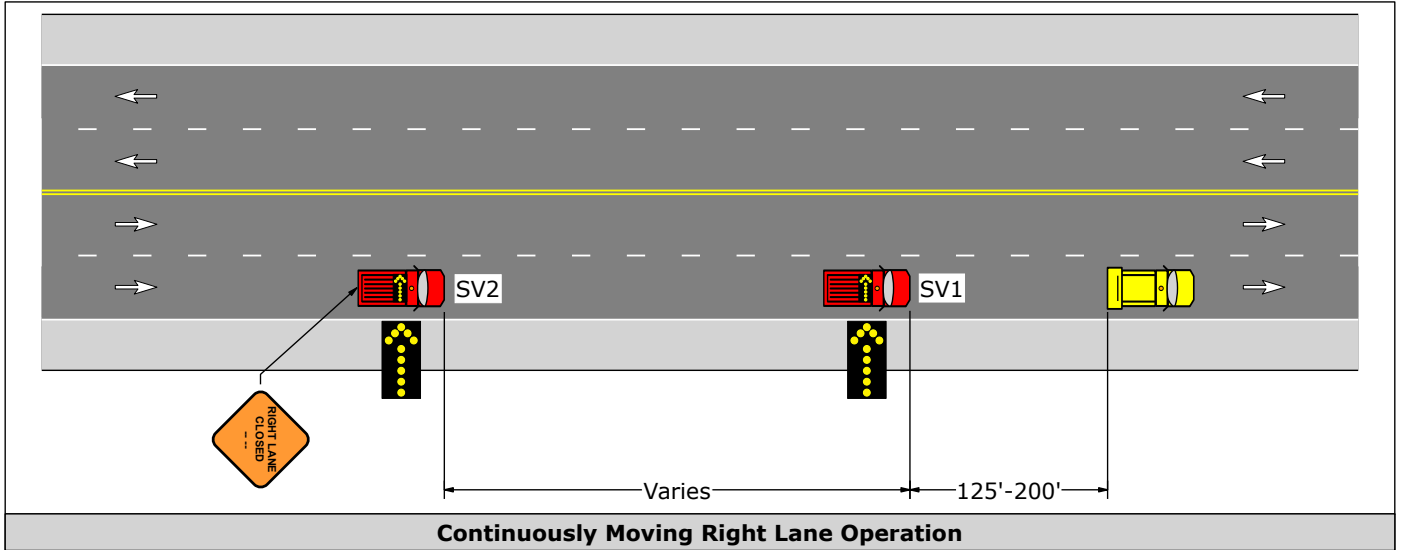


PATA 304-A

1. Spacing between shadow vehicles may vary to deter traffic from driving in between. The variation in distance between shadow vehicles is dependent on the speed, sight distance, and type of operation. Whenever adequate stopping sight distance exists to the rear, shadow vehicles should maintain a reasonable distance and proceed at the same speed as the work operation vehicle. The shadow vehicles should slow down in advance of vertical or horizontal curves that restrict sight distance.
2. If the shoulder width is insufficient for SV2 to be positioned entirely on the shoulder during non-continuously moving operations, SV2 shall be positioned as close as possible to the outside shoulder edge.
3. Supplemental shadow vehicles are permitted to straddle edge lines.



PATA 304-A

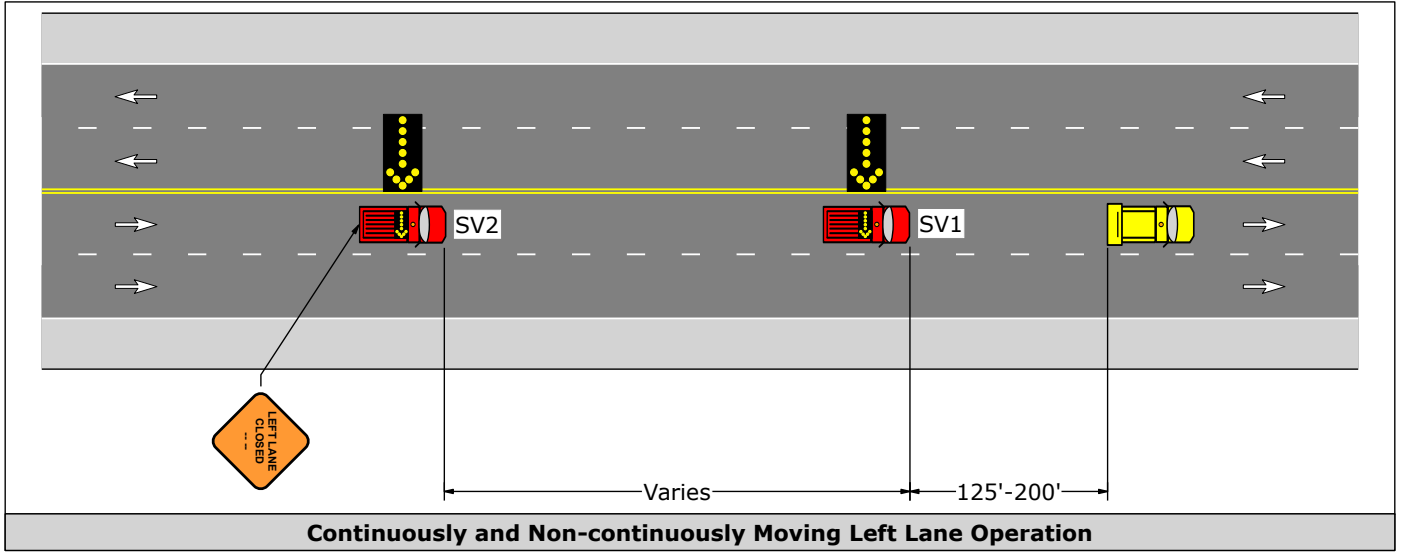


PATA 304-B

1. Spacing between shadow vehicles may vary to deter traffic from driving in between. The variation in distance between shadow vehicles is dependent on the speed, sight distance, and type of operation. Whenever adequate stopping sight distance exists to the rear, shadow vehicles should maintain a reasonable distance and proceed at the same speed as the work operation vehicle. The shadow vehicles should slow down in advance of vertical or horizontal curves that restrict sight distance.



PATA 304-B

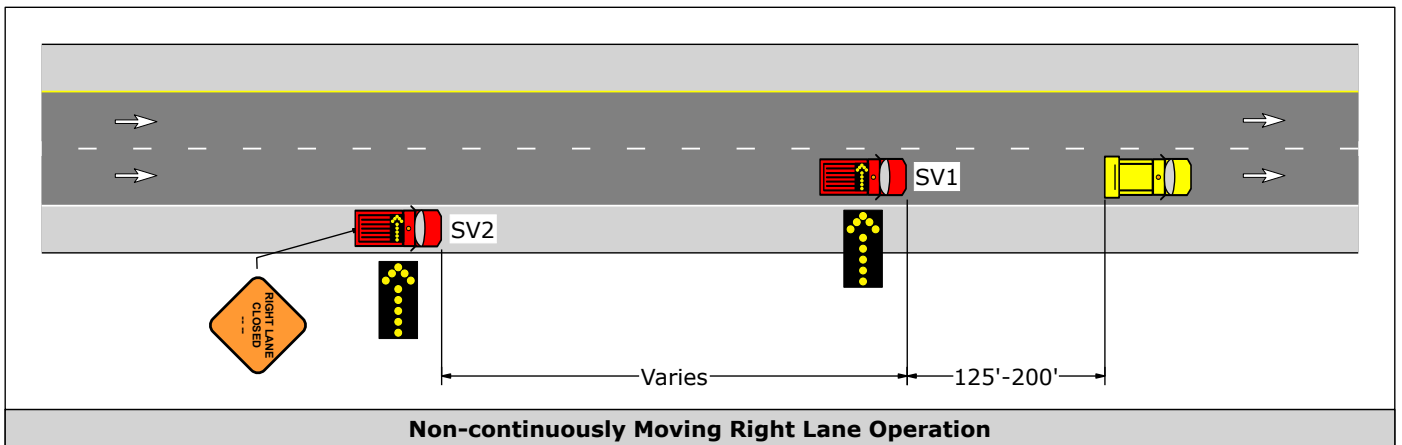
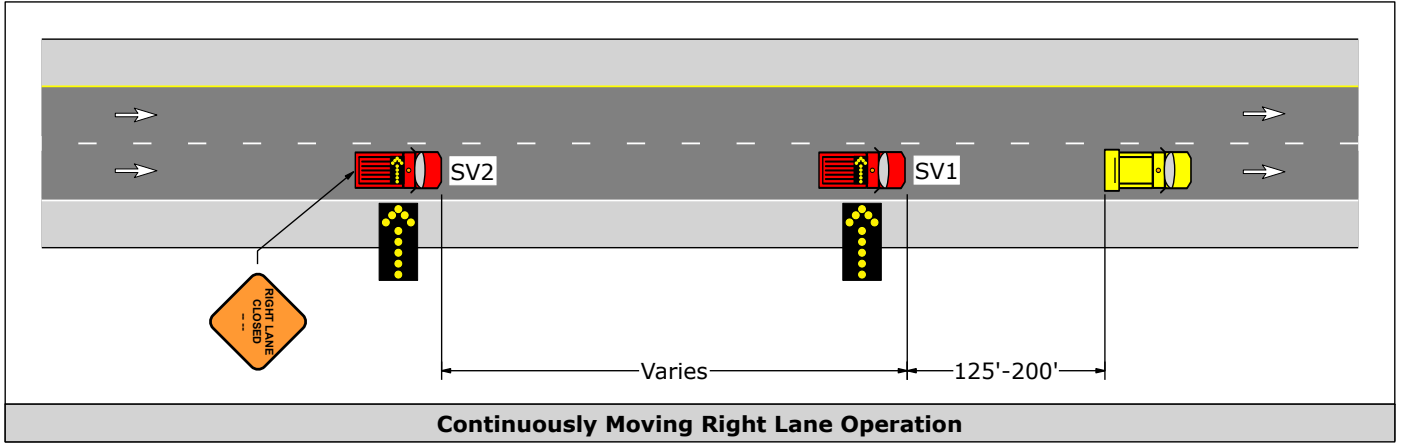


PATA 305-A

1. Spacing between shadow vehicles may vary to deter traffic from driving in between. The variation in distance between shadow vehicles is dependent on the speed, sight distance, and type of operation. Whenever adequate stopping sight distance exists to the rear, shadow vehicles should maintain a reasonable distance and proceed at the same speed as the work operation vehicle. The shadow vehicles should slow down in advance of vertical or horizontal curves that restrict sight distance.
2. If the shoulder width is insufficient for SV2 to be positioned entirely on the shoulder during non-continuously moving operations, SV2 shall be positioned as close as possible to the outside shoulder edge.
3. Supplemental shadow vehicles are permitted to straddle edge lines.



PATA 305-A

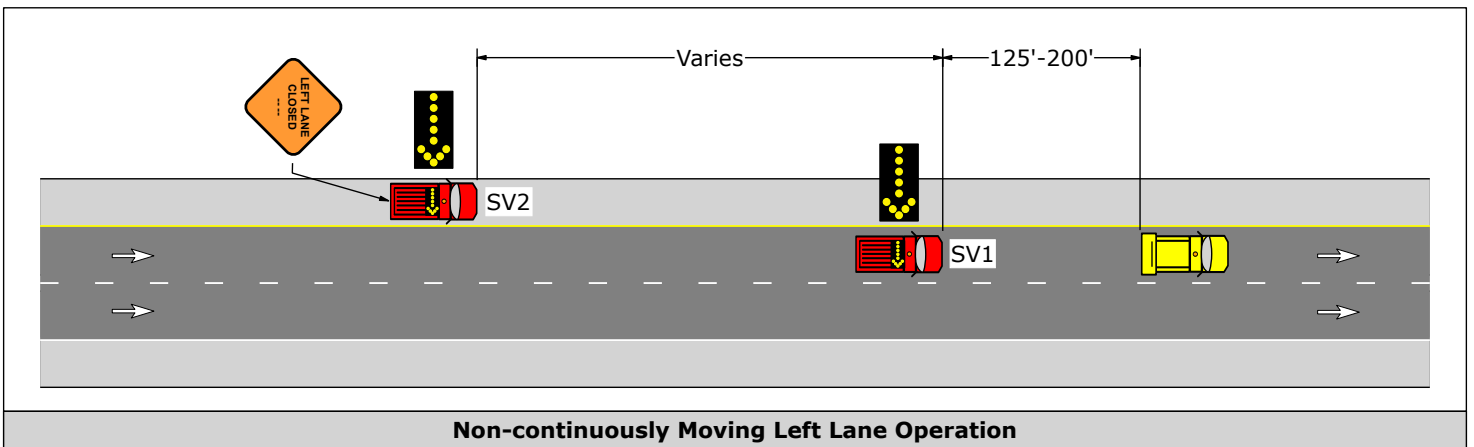
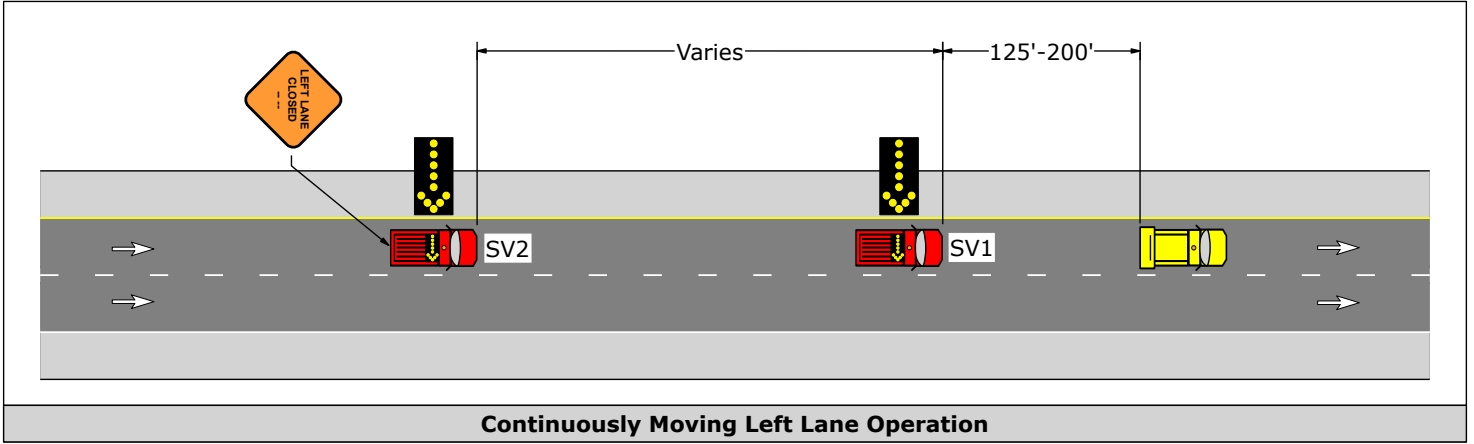


PATA 305-B

1. Spacing between shadow vehicles may vary to deter traffic from driving in between. The variation in distance between shadow vehicles is dependent on the speed, sight distance, and type of operation. Whenever adequate stopping sight distance exists to the rear, shadow vehicles should maintain a reasonable distance and proceed at the same speed as the work operation vehicle. The shadow vehicles should slow down in advance of vertical or horizontal curves that restrict sight distance.
2. If the shoulder width is insufficient for SV2 to be positioned entirely on the shoulder during non-continuously moving operations, SV2 shall be positioned as close as possible to the outside shoulder edge.
3. Supplemental shadow vehicles are permitted to straddle edge lines.



PATA 305-B

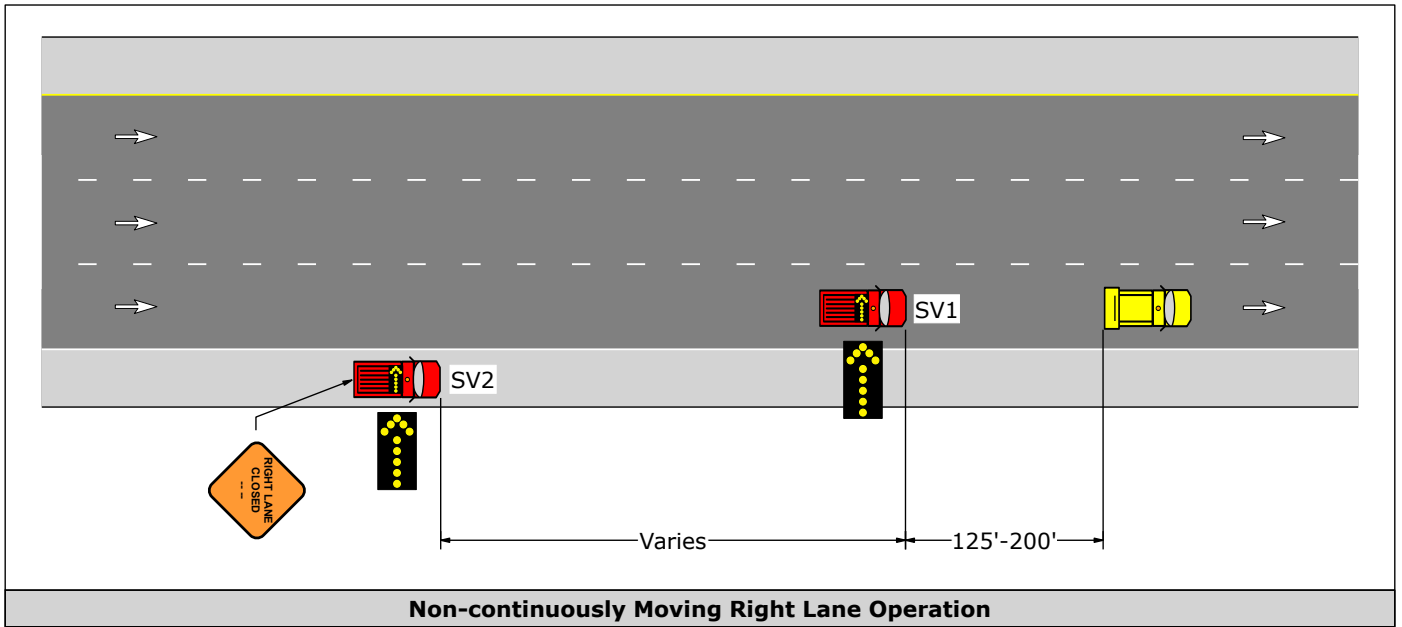
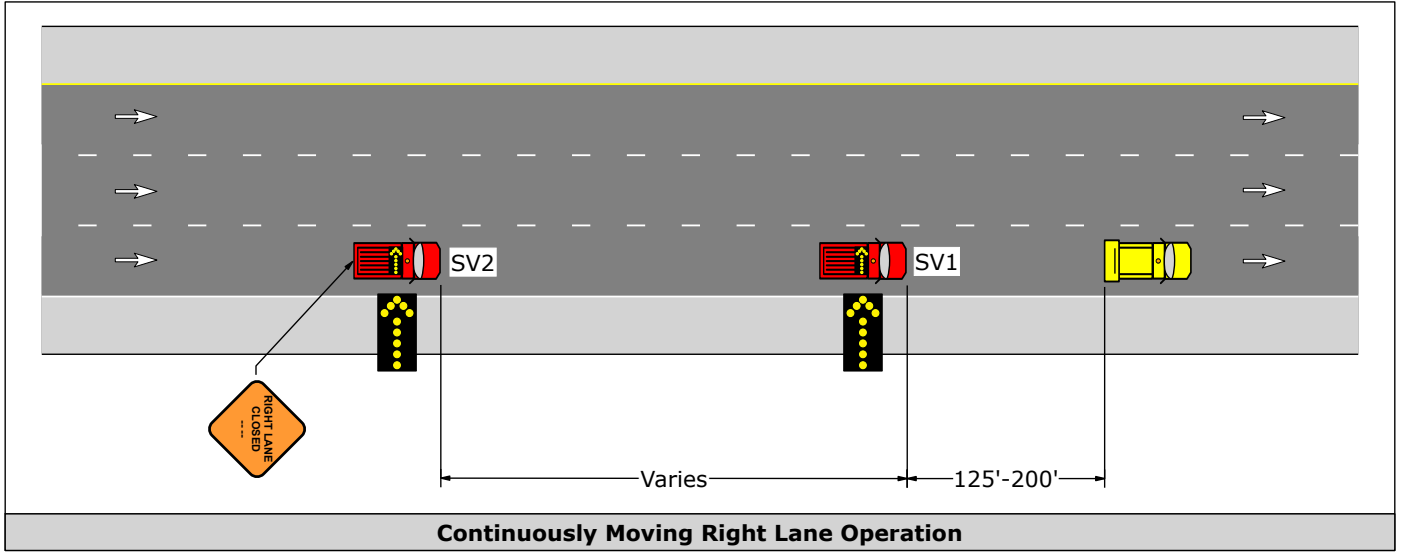


PATA 306-A

1. Spacing between shadow vehicles may vary to deter traffic from driving in between. The variation in distance between shadow vehicles is dependent on the speed, sight distance, and type of operation. Whenever adequate stopping sight distance exists to the rear, shadow vehicles should maintain a reasonable distance and proceed at the same speed as the work operation vehicle. The shadow vehicles should slow down in advance of vertical or horizontal curves that restrict sight distance.
2. If the shoulder width is insufficient for SV2 to be positioned entirely on the shoulder during non-continuously moving operations, SV2 shall be positioned as close as possible to the outside shoulder edge.
3. Supplemental shadow vehicles are permitted to straddle edge lines.



PATA 306-A

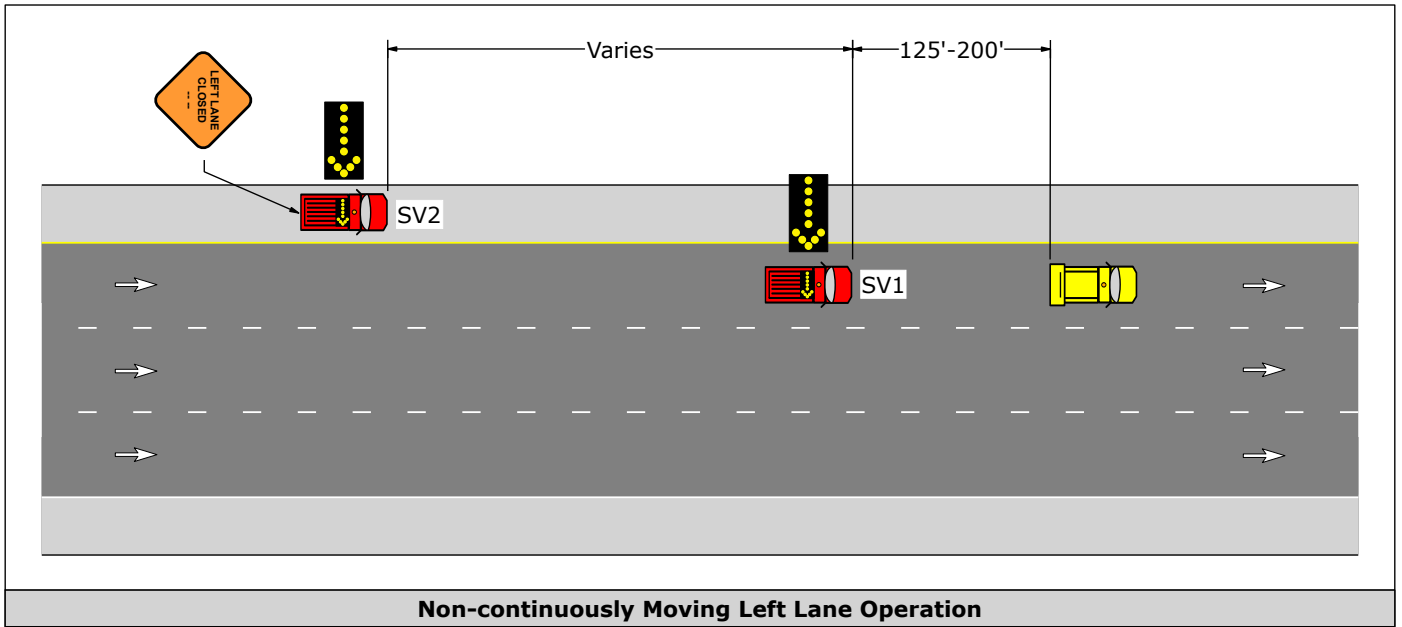
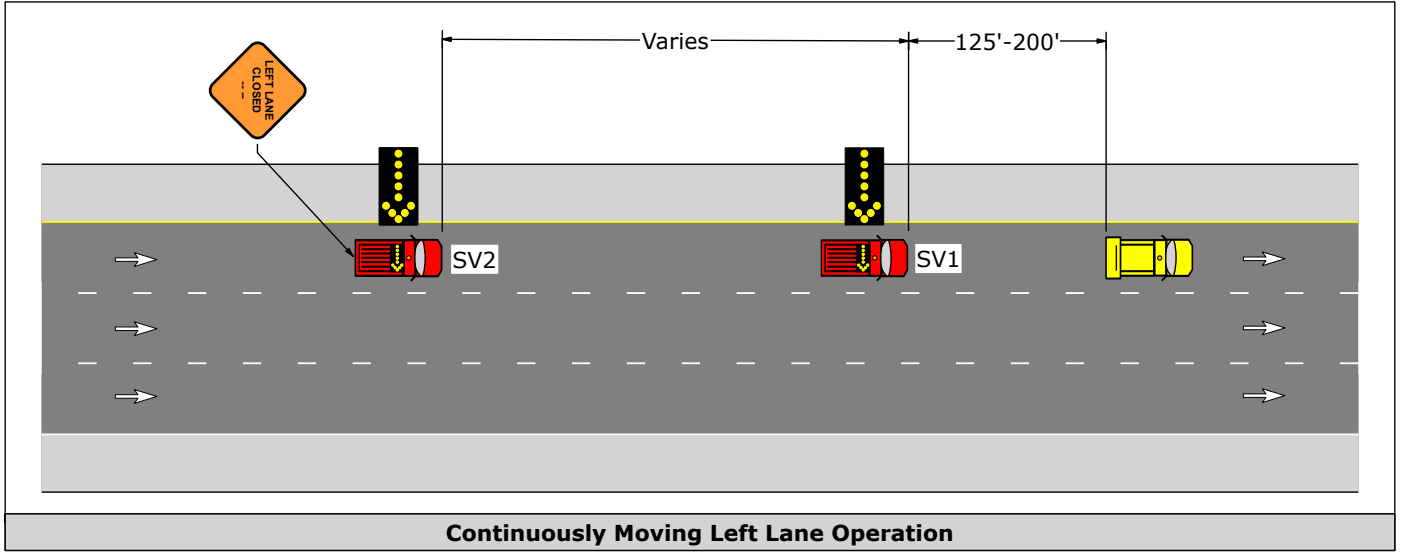


PATA 306-B

1. Spacing between shadow vehicles may vary to deter traffic from driving in between. The variation in distance between shadow vehicles is dependent on the speed, sight distance, and type of operation. Whenever adequate stopping sight distance exists to the rear, shadow vehicles should maintain a reasonable distance and proceed at the same speed as the work operation vehicle. The shadow vehicles should slow down in advance of vertical or horizontal curves that restrict sight distance.
2. If the shoulder width is insufficient for SV2 to be positioned entirely on the shoulder during continuously moving operations, SV2 shall be positioned as close as possible to the outside shoulder edge.
3. Supplemental shadow vehicles are permitted to straddle edge lines.

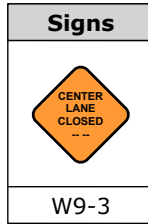


PATA 306-B

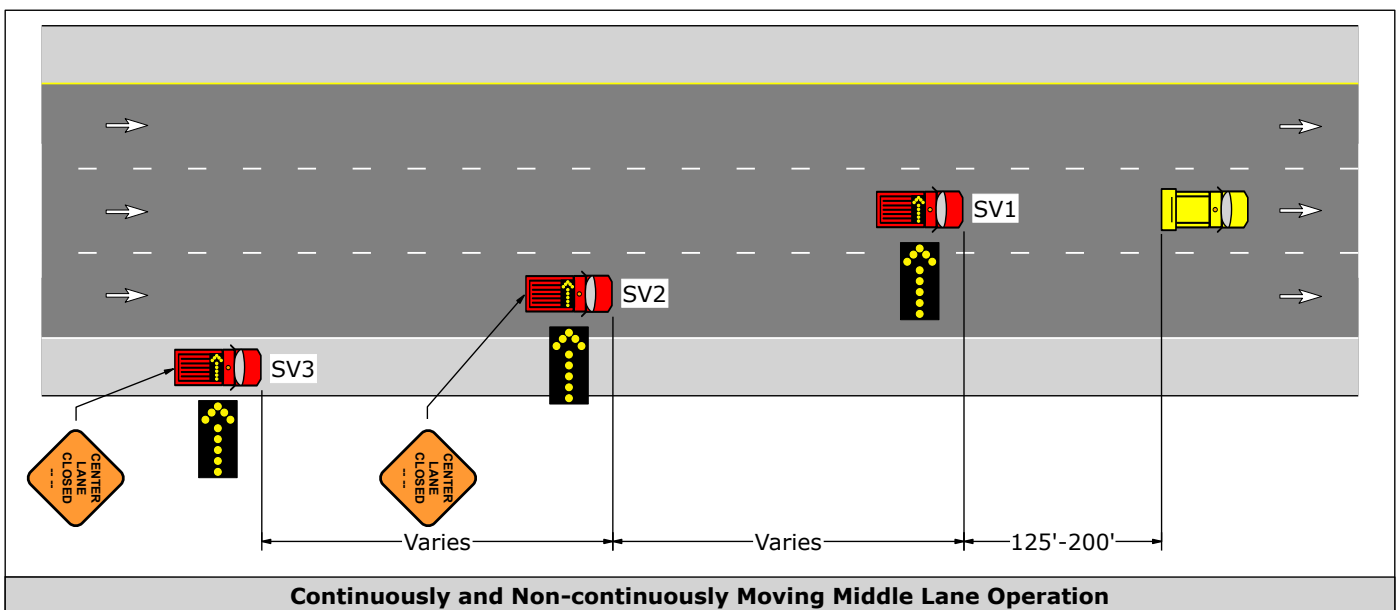
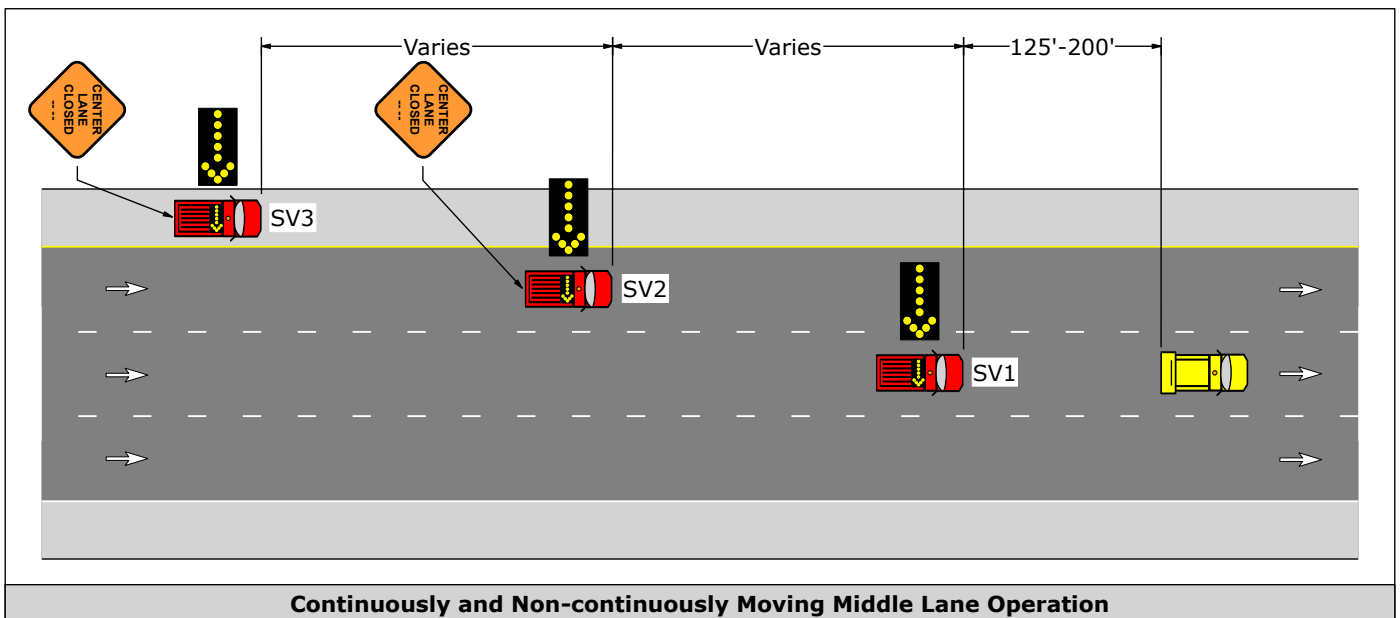
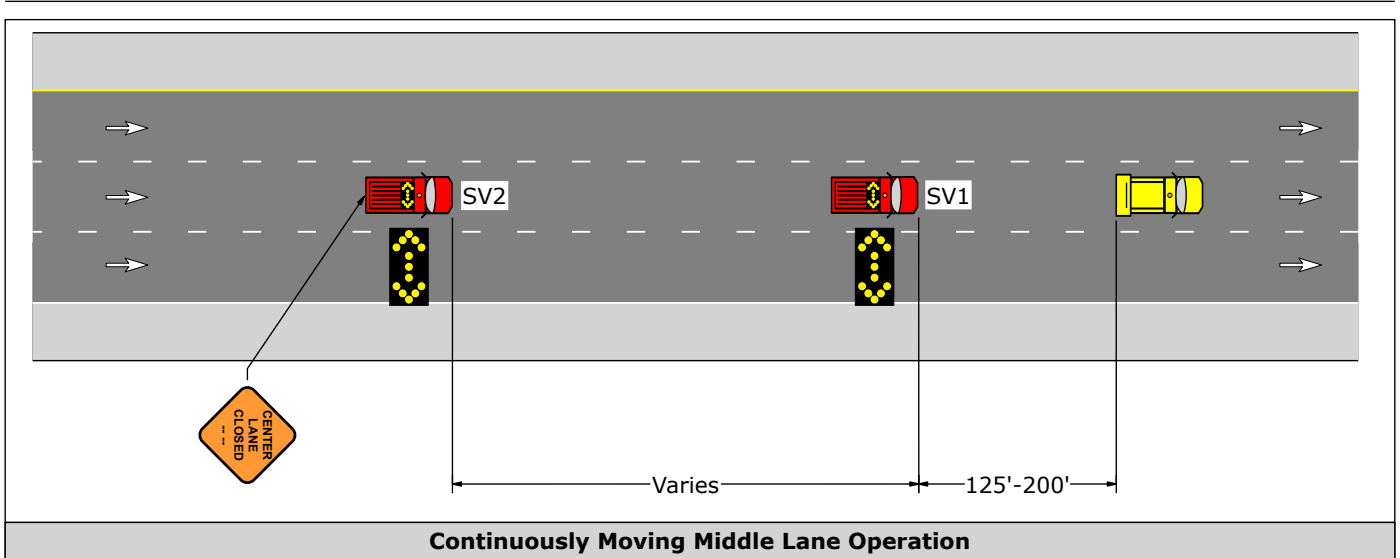


PATA 306-C

1. Spacing between shadow vehicles may vary to deter traffic from driving in between. The variation in distance between shadow vehicles is dependent on the speed, sight distance, and type of operation. Whenever adequate stopping sight distance exists to the rear, shadow vehicles should maintain a reasonable distance and proceed at the same speed as the work operation vehicle. The shadow vehicles should slow down in advance of vertical or horizontal curves that restrict sight distance.
2. If the shoulder width is insufficient for SV3 to be positioned entirely on the shoulder during non-continuously moving operations, SV3 shall be positioned as close as possible to the outside shoulder edge.
3. Supplemental shadow vehicles are permitted to straddle edge lines and lane lines.







PATA 306-C



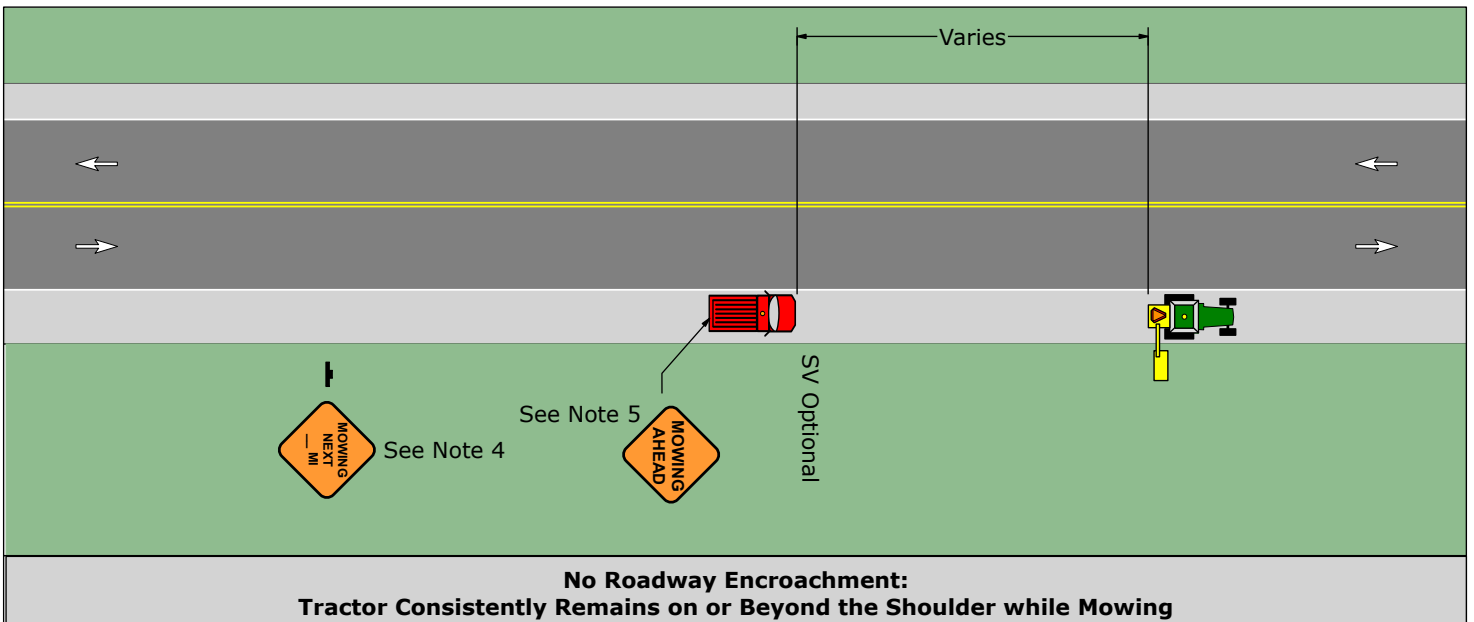
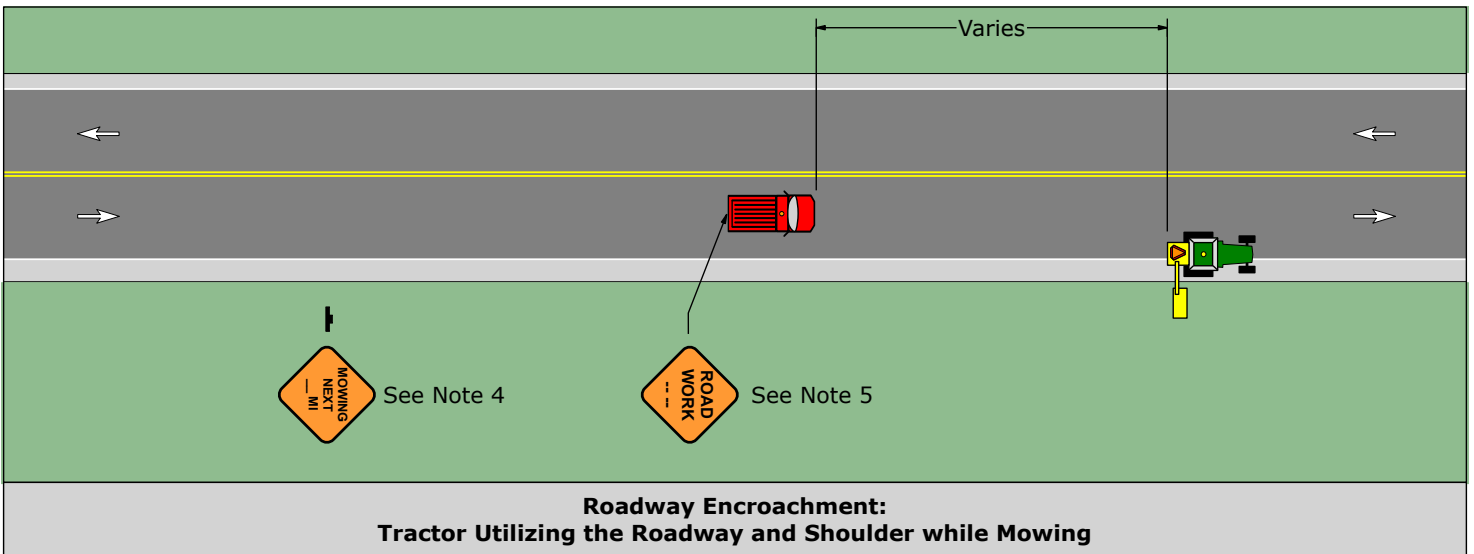
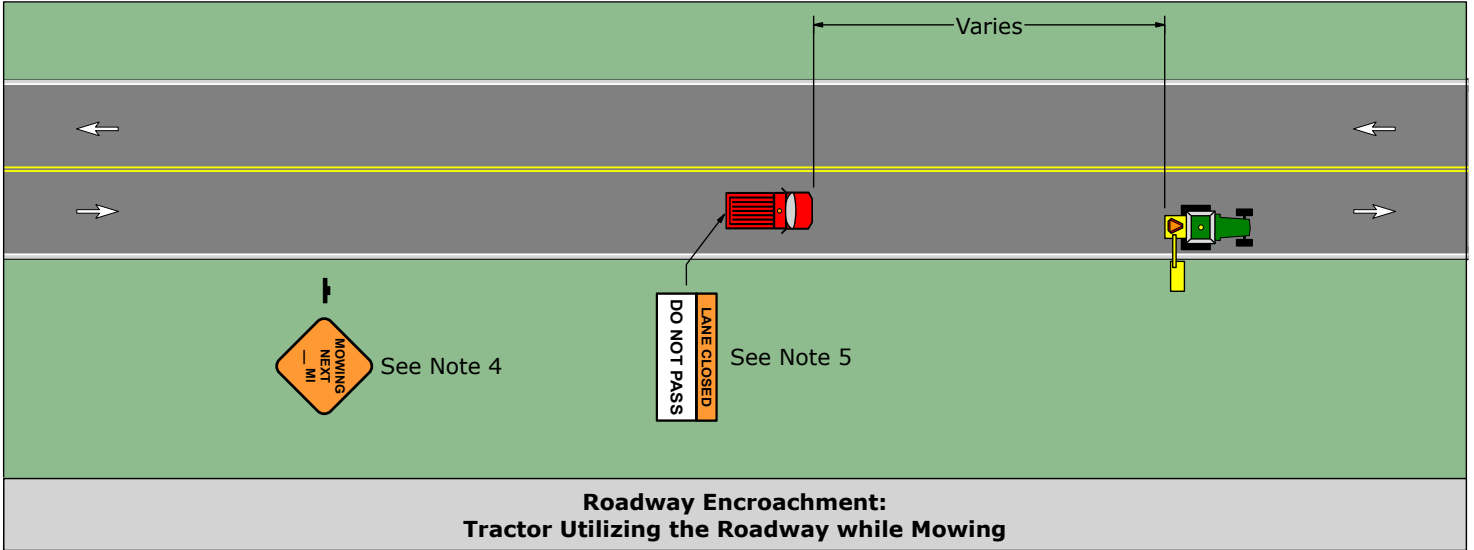
PATA 307

1. This PATA is for mowing operations. Mowing is to be performed without the tractor encroaching upon the roadway whenever possible. A shadow vehicle is required if the tractor will encroach upon any part of the roadway to perform the mowing operation.
2. If a shadow vehicle is utilized, the spacing between the mower and the shadow vehicle may vary. The variation in distance between the mower and shadow vehicle is dependent on the speed, sight distance, and type of operation. Whenever adequate stopping sight distance (Distance E) exists to the rear, the shadow vehicle should maintain a reasonable distance and proceed at the same speed as the mower. The shadow vehicle should slow down in advance of vertical or horizontal curves that restrict sight distance.
3. Where practical and when needed, the shadow vehicle and mower should pull over periodically to allow vehicular traffic to pass.
4. The MOWING NEXT _ MILES sign is optional when a shadow vehicle is utilized. Install the sign 500' prior to the area to be mowed. The mowing operation must remain downstream and within the distance posted on the sign (up to 5 miles maximum).
5. When a shadow vehicle is utilized, an appropriate TTC sign, such as a LANE CLOSED DO NOT PASS, MOWING AHEAD, or ROAD WORK AHEAD sign, shall be mounted on the rear of the shadow vehicle.
6. The shadow vehicle may be equipped with an arrow board.
7. Mowers may utilize the shoulder or roadway to navigate around roadside obstacles such as utility poles, traffic signs, etc. The operator shall yield the right of way to all traffic before entering the roadway in accordance with Pennsylvania Consolidated Statutes, Title 75 (Vehicle Code), Section 3324 and exit the roadway immediately after passing the obstruction.
8. The mower is required to have a SLOW MOVING VEHICLE EMBLEM (V1-6-1) sign mounted to the rear and positioned as near as practicable to the center of the vehicle. A flashing, oscillating, or revolving yellow light which is visible from any direction (360° visibility) must be active when mowing is in progress.

Signs			
			
W20-1	W21-14	G80-1	V1-6-1

Shadow Vehicle Visibility to Approaching Motorists	
Speed	Buffer Space
S (MPH)	E (Feet)
25	155
30	200
35	250
40	305
45	360
50	425
55	495

PATA 307



Blank Page

Freeways & Expressways

Short-Term Stationary Operations
(PATA 400 Series)

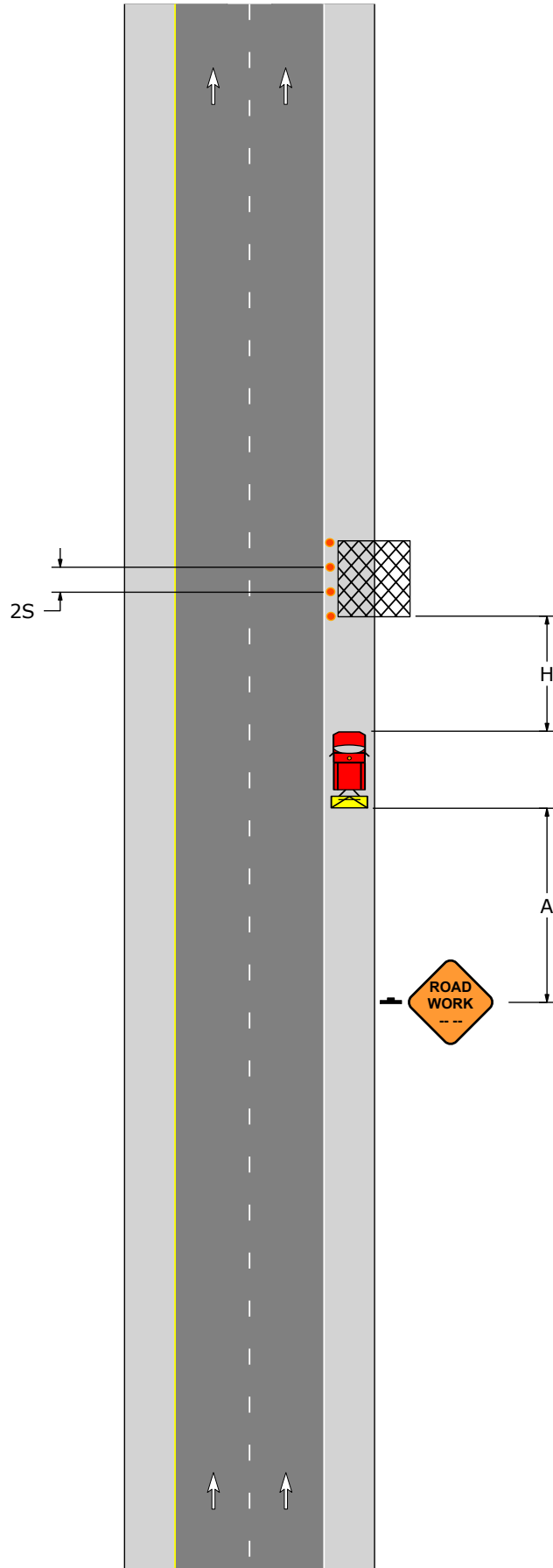
PATA 401-A

1. The shadow vehicle and traffic control devices are not required if the work space is outside the highway right-of-way, behind barrier, more than 2' behind curb, or 15' or more from the edge of any roadway.
2. For operations of 60 minutes or less:
 - a) The ROAD WORK sign is not required.
 - b) All channelizing devices may be eliminated if the operation does not proceed against normal traffic flow.



Sign Spacing, Channelizing Device Spacing, and Roll Ahead Space			
Speed	Channelizing Devices Spacing	Sign Spacing	Roll Ahead Space
S (MPH)	2S (Feet)	A (Feet)	H (Feet)
40	80	1000	150
45	90	1000	150
50	100	1000	250
55	110	1000	250
60	120	1000	250
65	130	1000	250
70	140	1000	250

PATA 401-A



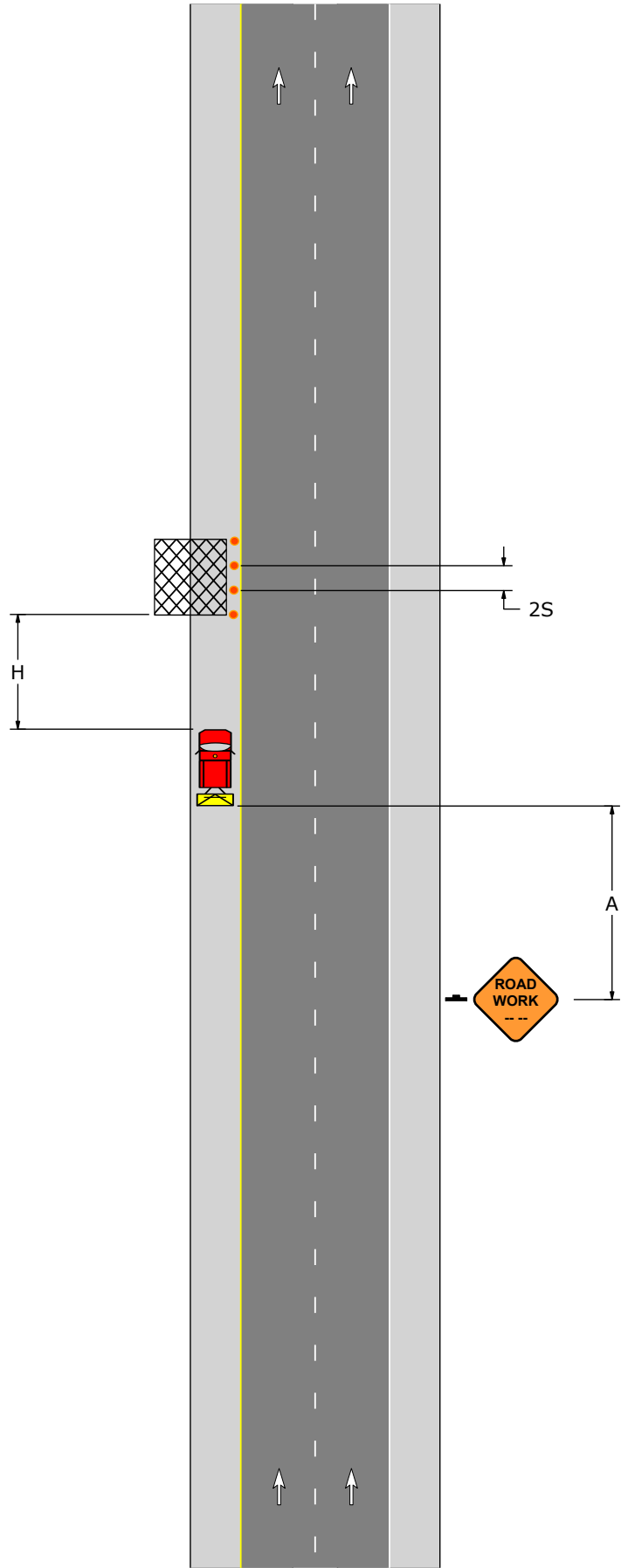
PATA 401-B

1. The shadow vehicle and traffic control devices are not required if the work space is outside the highway right-of-way, behind barrier, more than 2' behind curb, or 15' or more from the edge of any roadway.
2. For operations of 60 minutes or less:
 - a) The ROAD WORK sign is not required.
 - b) All channelizing devices may be eliminated if the operation does not proceed against normal traffic flow.






Sign Spacing, Channelizing Device Spacing, and Roll Ahead Space			
Speed	Channelizing Devices Spacing	Sign Spacing	Roll Ahead Space
S (MPH)	2S (Feet)	A (Feet)	H (Feet)
40	80	1000	150
45	90	1000	150
50	100	1000	250
55	110	1000	250
60	120	1000	250
65	130	1000	250
70	140	1000	250

PATA 401-B



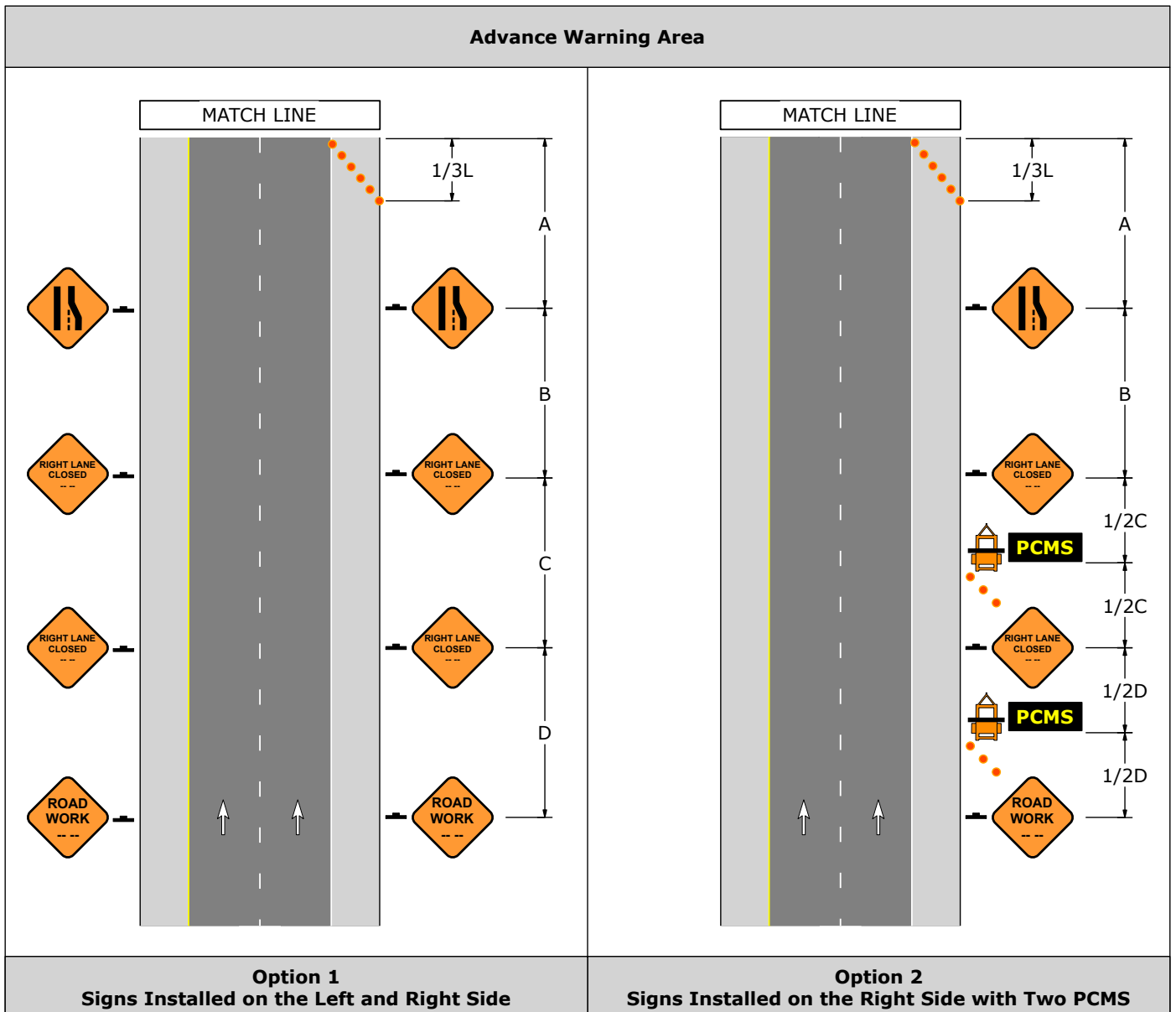
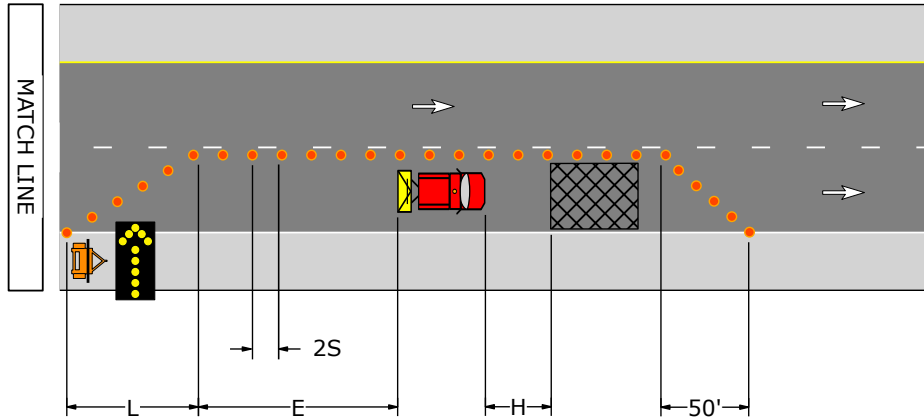
PATA 402-A

Signs		
		
W20-1	W20-5R	W4-2R




Sign Spacing, Channelizing Device Spacing, Buffer Space, and Roll Ahead Space							
Speed	Channelizing Devices Spacing	Sign Spacing				Buffer Space	Roll Ahead Space
S (MPH)	2S (Feet)	A (Feet)	B (Feet)	C (Feet)	D (Feet)	E (Feet)	H (Feet)
40	80	1000	1640	2640	5280	305	150
45	90	1000	1640	2640	5280	360	150
50	100	1000	1640	2640	5280	425	250
55	110	1000	1640	2640	5280	495	250
60	120	1000	1640	2640	5280	570	250
65	130	1000	1640	2640	5280	645	250
70	140	1000	1640	2640	5280	730	250

Taper Lengths and Minimum Number Of Channelizing Devices						
Speed	Merging Taper: L		Shoulder Taper: 1/3L		50' Per Lane Taper	
S (MPH)	Length (Feet)	Minimum Number Of Devices	Length (Feet)	Minimum Number Of Devices	Length (Feet)	Minimum Number Of Devices
40	320	9	110	6	50	6
45	540	13	180	6	50	6
50	600	13	200	6	50	6
55	660	13	220	6	50	6
60	720	13	240	6	50	6
65	780	13	260	6	50	6
70	840	13	280	6	50	6

PATA 402-A



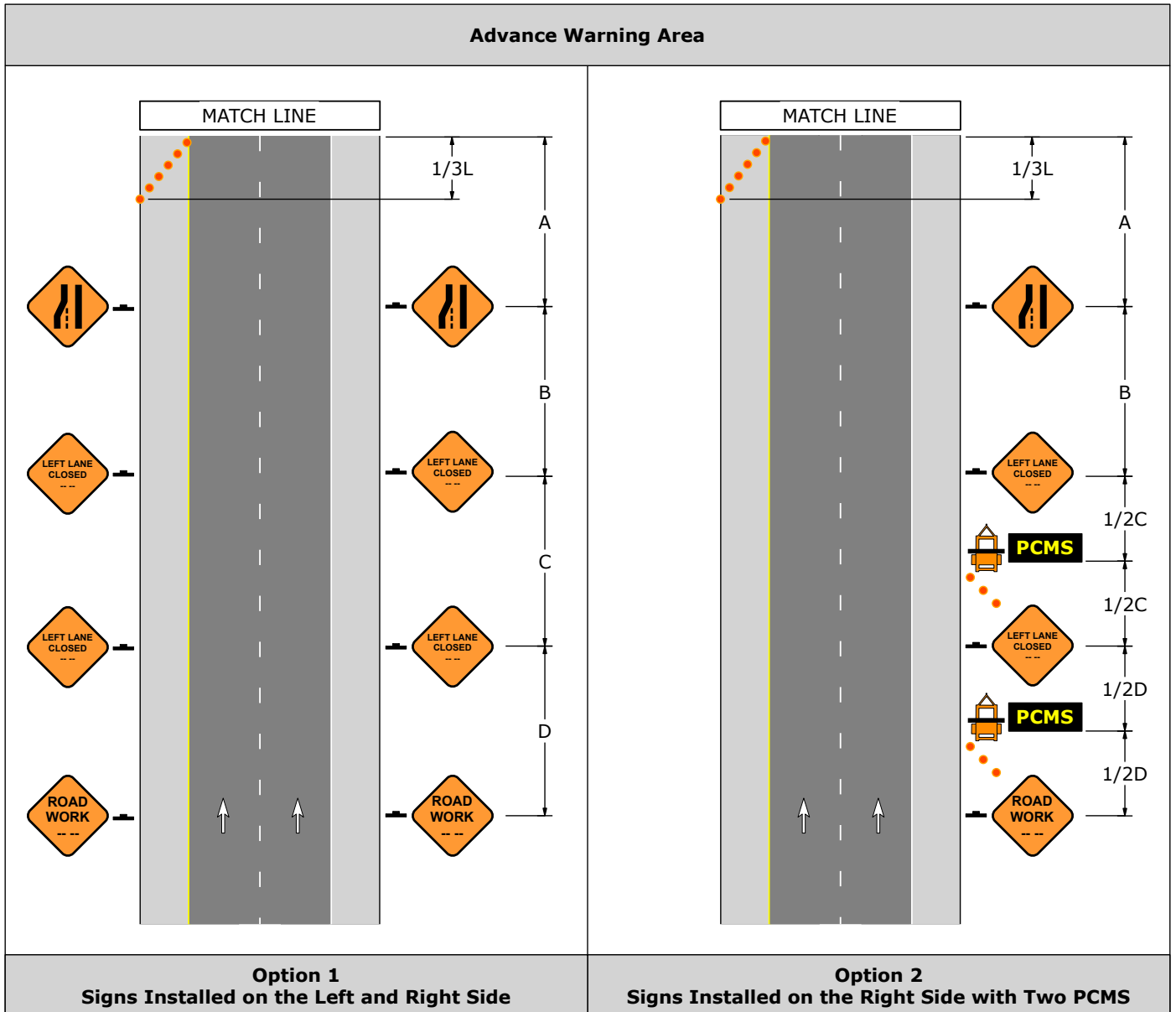
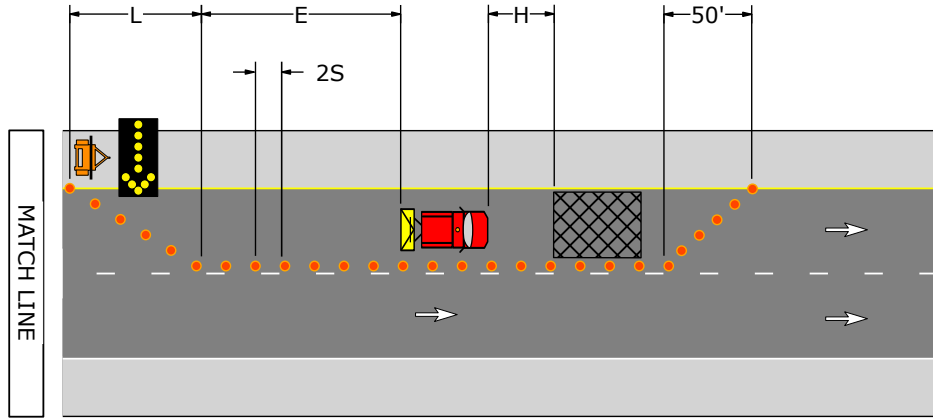
PATA 402-B

Signs		
		
W20-1	W20-5L	W4-2L




Sign Spacing, Channelizing Device Spacing, Buffer Space, and Roll Ahead Space							
Speed	Channelizing Devices Spacing	Sign Spacing				Buffer Space	Roll Ahead Space
S (MPH)	2S (Feet)	A (Feet)	B (Feet)	C (Feet)	D (Feet)	E (Feet)	H (Feet)
40	80	1000	1640	2640	5280	305	150
45	90	1000	1640	2640	5280	360	150
50	100	1000	1640	2640	5280	425	250
55	110	1000	1640	2640	5280	495	250
60	120	1000	1640	2640	5280	570	250
65	130	1000	1640	2640	5280	645	250
70	140	1000	1640	2640	5280	730	250

Taper Lengths and Minimum Number Of Channelizing Devices						
Speed	Merging Taper: L		Shoulder Taper: 1/3L		50' Per Lane Taper	
S (MPH)	Length (Feet)	Minimum Number Of Devices	Length (Feet)	Minimum Number Of Devices	Length (Feet)	Minimum Number Of Devices
40	320	9	110	6	50	6
45	540	13	180	6	50	6
50	600	13	200	6	50	6
55	660	13	220	6	50	6
60	720	13	240	6	50	6
65	780	13	260	6	50	6
70	840	13	280	6	50	6

PATA 402-B



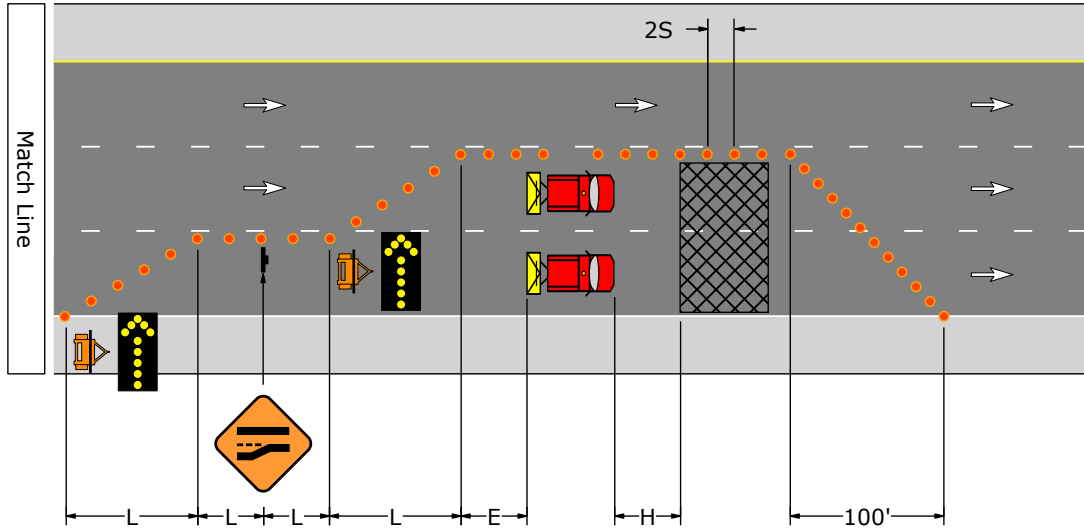
PATA 403-A

Signs		
		
W20-1	W20-5AR	W4-2R

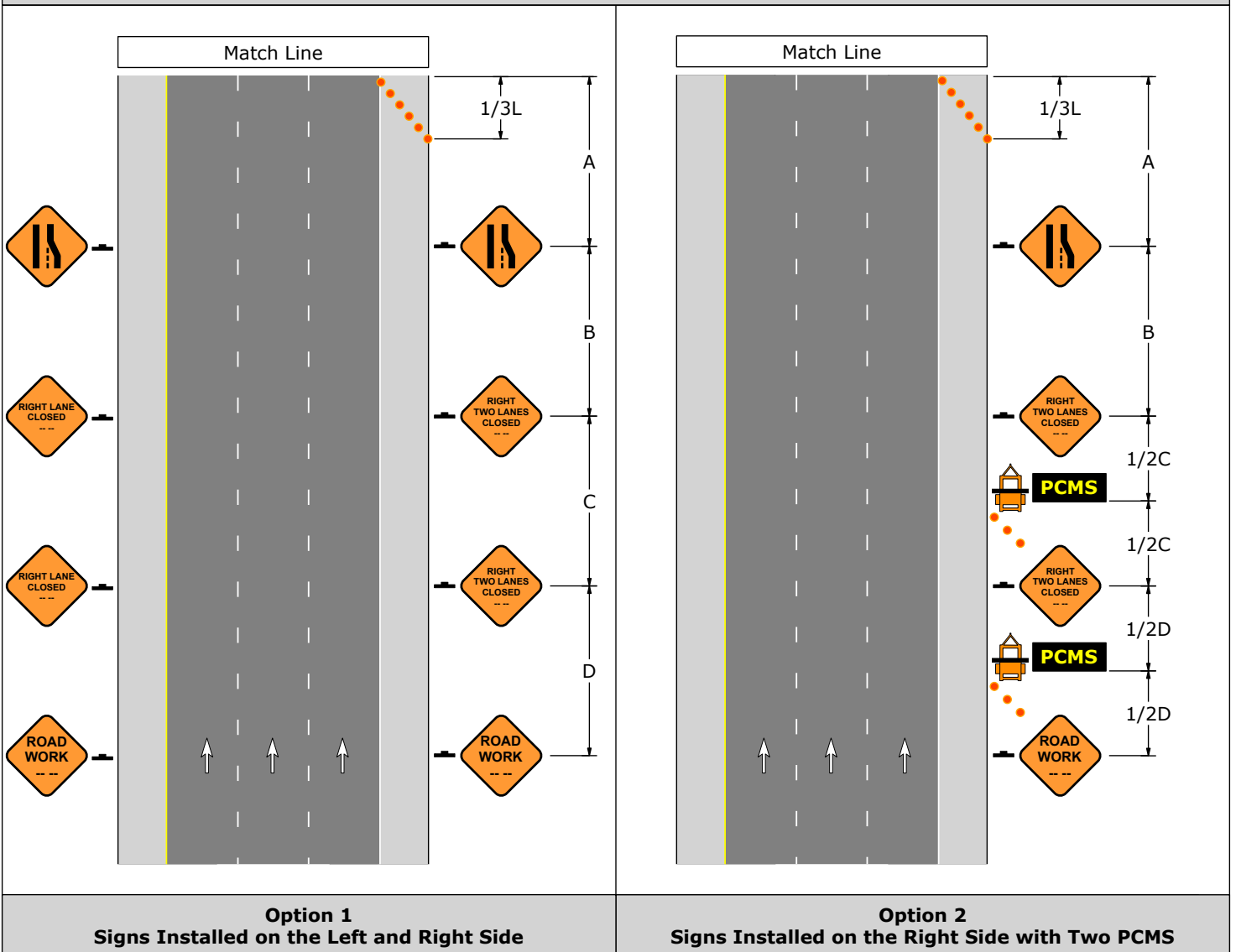
Sign Spacing, Channelizing Device Spacing, Buffer Space, and Roll Ahead Space							
Speed	Channelizing Devices Spacing	Sign Spacing				Buffer Space	Roll Ahead Space
S (MPH)	2S (Feet)	A (Feet)	B (Feet)	C (Feet)	D (Feet)	E (Feet)	H (Feet)
40	80	1000	1640	2640	5280	305	150
45	90	1000	1640	2640	5280	360	150
50	100	1000	1640	2640	5280	425	250
55	110	1000	1640	2640	5280	495	250
60	120	1000	1640	2640	5280	570	250
65	130	1000	1640	2640	5280	645	250
70	140	1000	1640	2640	5280	730	250

Taper Lengths and Minimum Number Of Channelizing Devices						
Speed	Merging Taper: L		Shoulder Taper: 1/3L		50' Per Lane Taper	
S (MPH)	Length (Feet)	Minimum Number Of Devices	Length (Feet)	Minimum Number Of Devices	Length (Feet)	Minimum Number Of Devices
40	320	9	110	6	100	12
45	540	13	180	6	100	12
50	600	13	200	6	100	12
55	660	13	220	6	100	12
60	720	13	240	6	100	12
65	780	13	260	6	100	12
70	840	13	280	6	100	12




PATA 403-A



Advance Warning Area



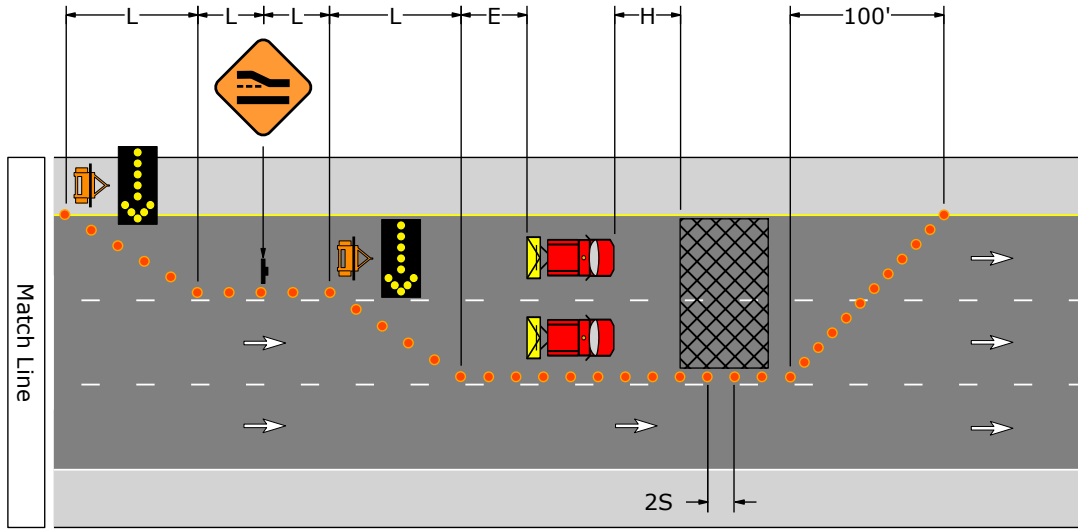
PATA 403-B

Signs		
		
W20-1	W20-5AL	W4-2L

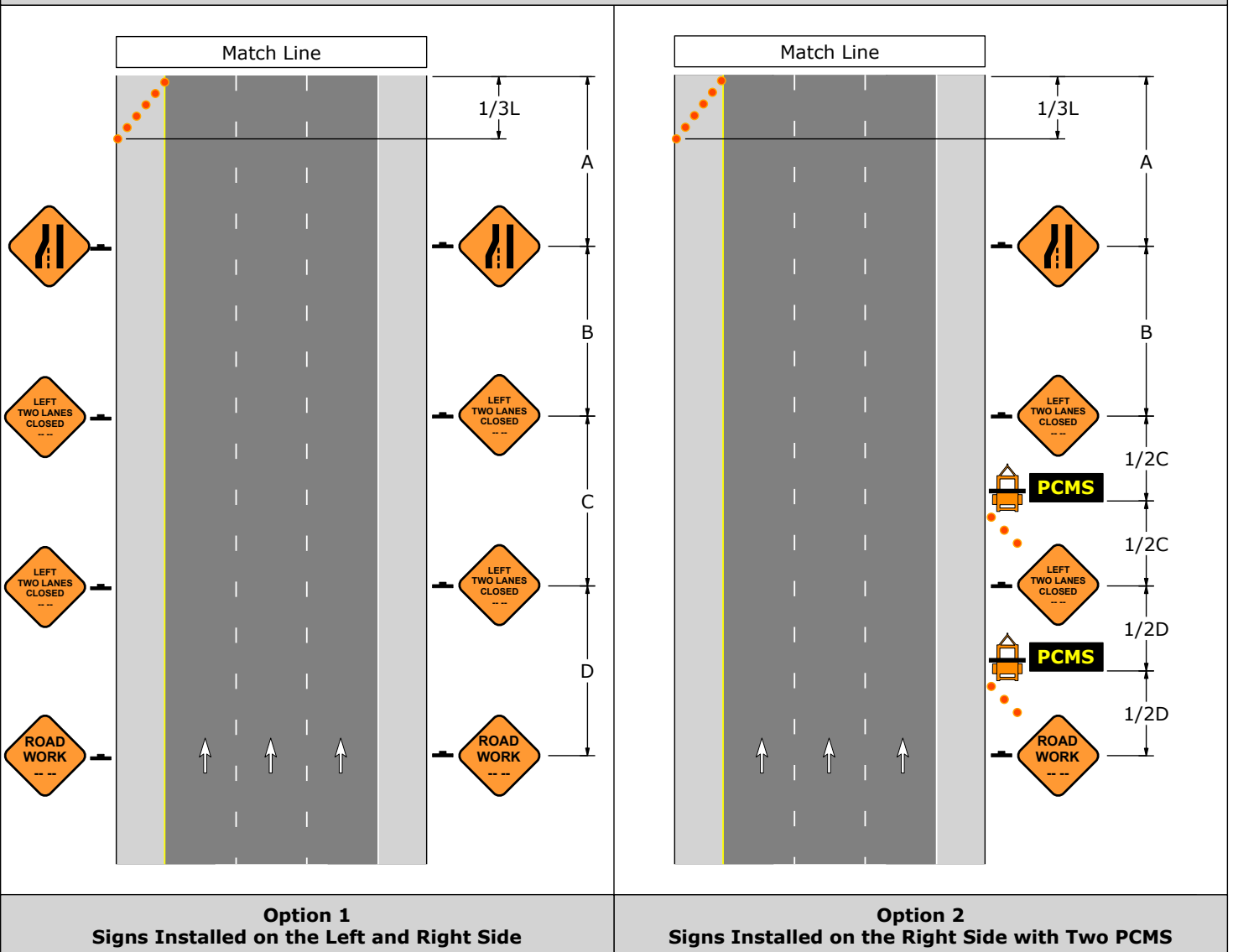
Sign Spacing, Channelizing Device Spacing, Buffer Space, and Roll Ahead Space							
Speed	Channelizing Devices Spacing	Sign Spacing				Buffer Space	Roll Ahead Space
S (MPH)	2S (Feet)	A (Feet)	B (Feet)	C (Feet)	D (Feet)	E (Feet)	H (Feet)
40	80	1000	1640	2640	5280	305	150
45	90	1000	1640	2640	5280	360	150
50	100	1000	1640	2640	5280	425	250
55	110	1000	1640	2640	5280	495	250
60	120	1000	1640	2640	5280	570	250
65	130	1000	1640	2640	5280	645	250
70	140	1000	1640	2640	5280	730	250

Taper Lengths and Minimum Number Of Channelizing Devices						
Speed	Merging Taper: L		Shoulder Taper: 1/3L		50' Per Lane Taper	
S (MPH)	Length (Feet)	Minimum Number Of Devices	Length (Feet)	Minimum Number Of Devices	Length (Feet)	Minimum Number Of Devices
40	320	9	110	6	100	12
45	540	13	180	6	100	12
50	600	13	200	6	100	12
55	660	13	220	6	100	12
60	720	13	240	6	100	12
65	780	13	260	6	100	12
70	840	13	280	6	100	12

PATA 403-B








Advance Warning Area



PATA 404-A

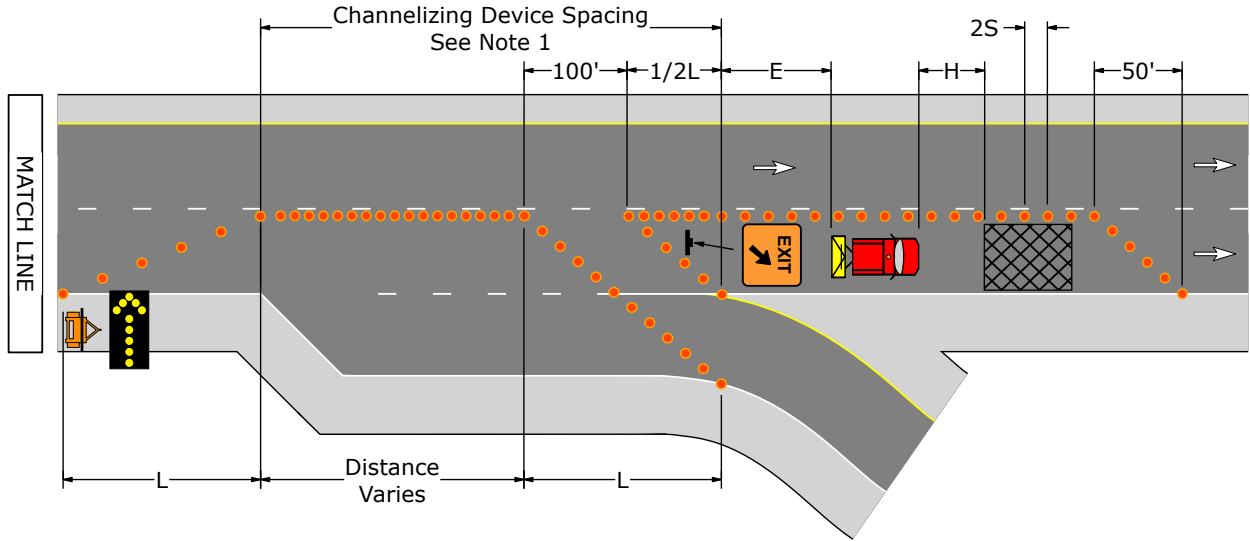
1. Longitudinal channelizing devices located from the beginning of the permanent ramp to the gore area shall be placed with a maximum interval spacing equal to the regulatory speed limit (in feet).
2. In locations with heavy ramp traffic, the channelizing devices in advance of the ramp may be eliminated if special advance signing is erected to indicate that the right lane is a mandatory exit only lane.
3. The temporary EXIT sign shall be located in the temporary gore. It shall be mounted at a minimum height of 7' from the pavement surface to the bottom of the sign. This sign may be either black on orange or white on green.

Signs				
				
W20-1	W20-5R	W4-2R	W25-4	W25-4

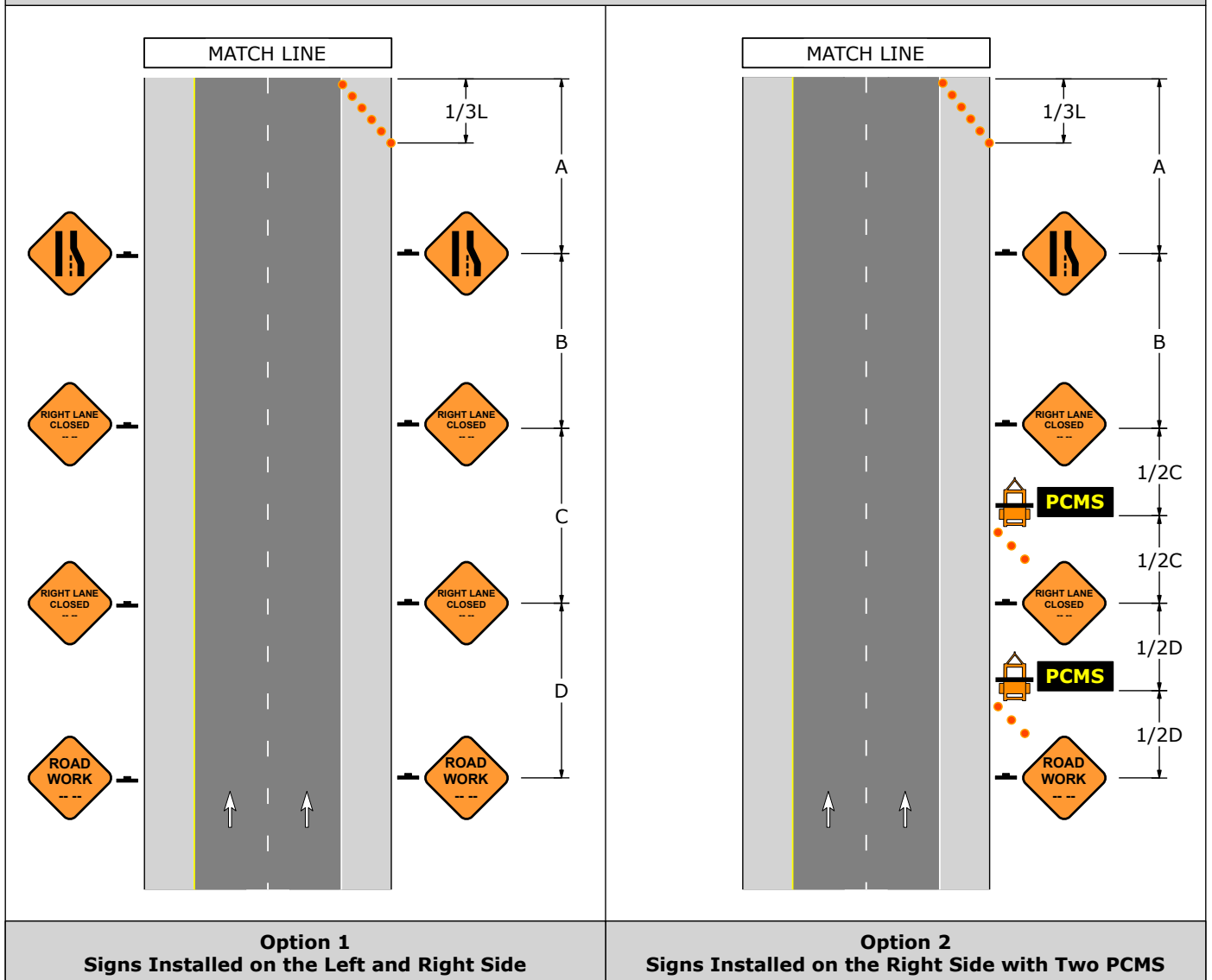
Sign Spacing, Channelizing Device Spacing, Buffer Space, and Roll Ahead Space							
Speed	Channelizing Devices Spacing	Sign Spacing				Buffer Space	Roll Ahead Space
S (MPH)	2S (Feet)	A (Feet)	B (Feet)	C (Feet)	D (Feet)	E (Feet)	H (Feet)
40	80	1000	1640	2640	5280	305	150
45	90	1000	1640	2640	5280	360	150
50	100	1000	1640	2640	5280	425	250
55	110	1000	1640	2640	5280	495	250
60	120	1000	1640	2640	5280	570	250
65	130	1000	1640	2640	5280	645	250
70	140	1000	1640	2640	5280	730	250

Taper Lengths and Minimum Number Of Channelizing Devices								
Speed	Merging Taper: L		Shifting Taper: 1/2L		Shoulder Taper: 1/3L		50' Per Lane Taper	
S (MPH)	Length (Feet)	Minimum Number Of Devices	Length (Feet)	Minimum Number Of Devices	Length (Feet)	Minimum Number Of Devices	Length (Feet)	Minimum Number Of Devices
40	320	9	160	6	110	6	50	6
45	540	13	270	7	180	6	50	6
50	600	13	300	7	200	6	50	6
55	660	13	330	7	220	6	50	6
60	720	13	360	7	240	6	50	6
65	780	13	390	7	260	6	50	6
70	840	13	420	7	280	6	50	6

PATA 404-A








Advance Warning Area



PATA 404-B

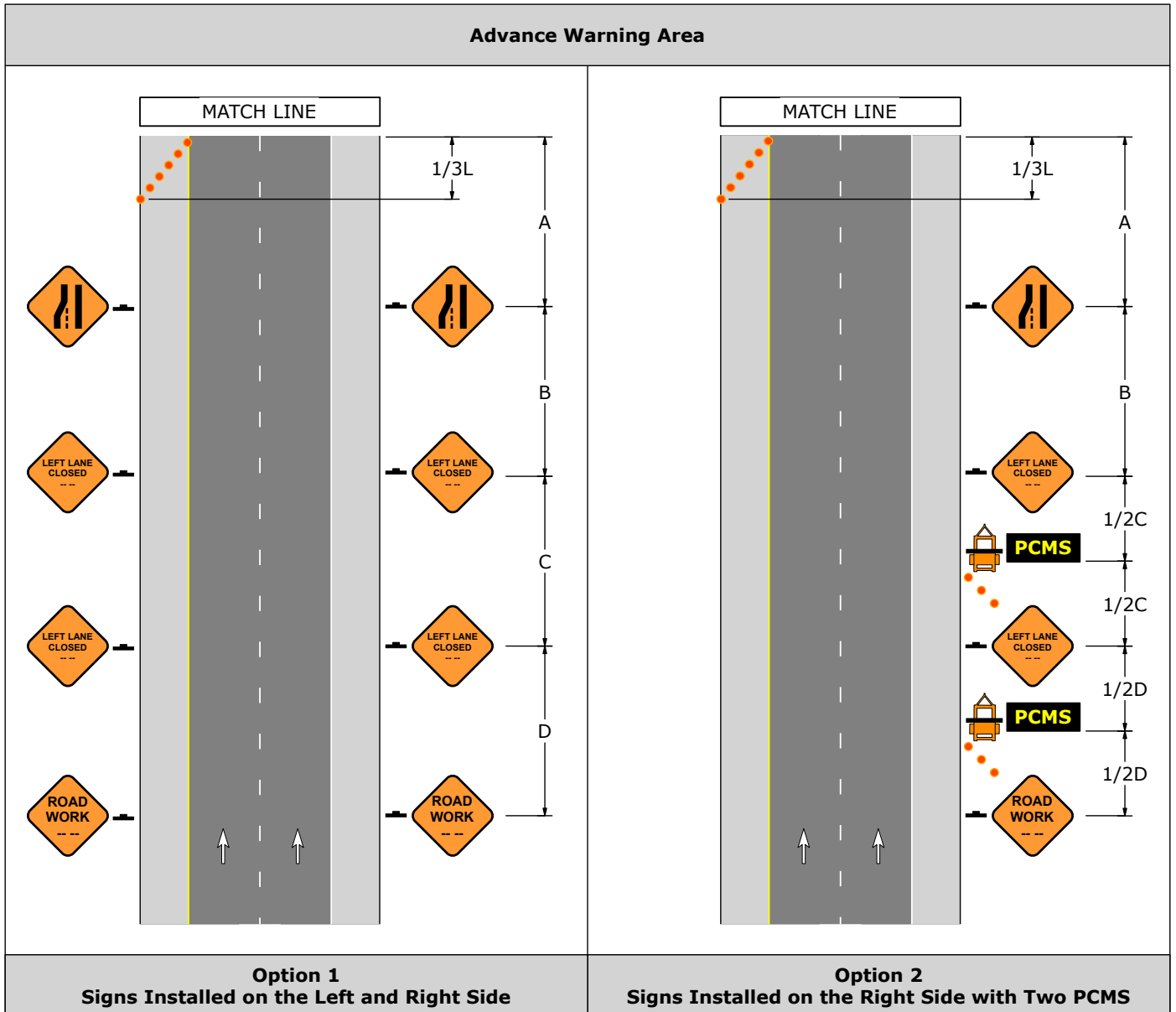
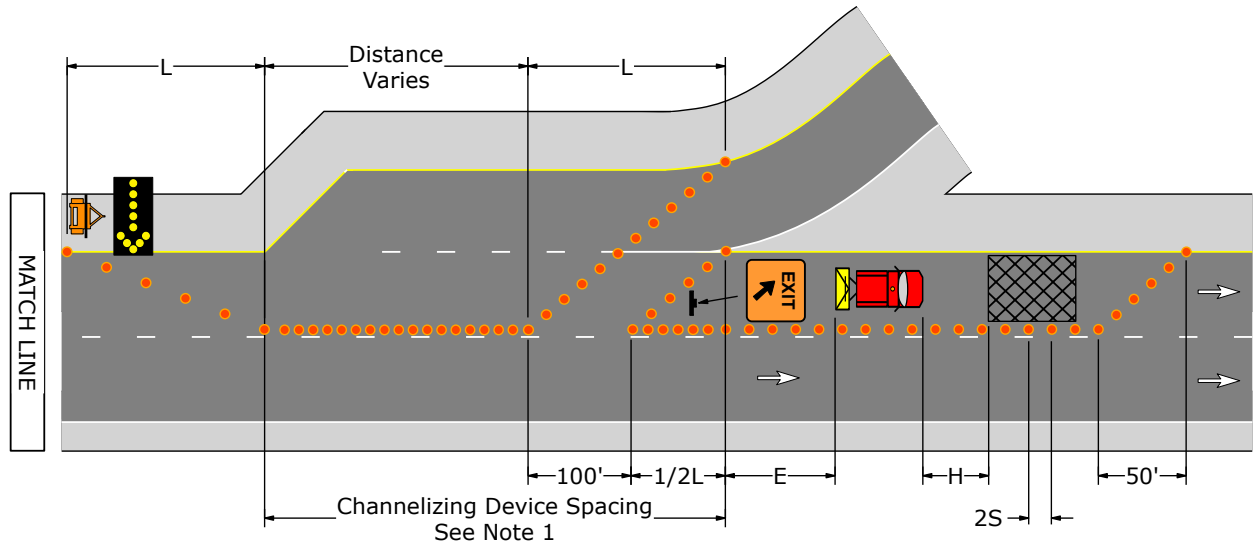
1. Longitudinal channelizing devices located from the beginning of the permanent ramp to the gore area shall be placed with a maximum interval spacing equal to the regulatory speed limit (in feet).
2. In locations with heavy ramp traffic, the channelizing devices in advance of the ramp may be eliminated if special advance signing is erected to indicate that the right lane is a mandatory exit only lane.
3. The temporary EXIT sign shall be located in the temporary gore. It shall be mounted at a minimum height of 7' from the pavement surface to the bottom of the sign. This sign may be either black on orange or white on green.

Signs				
				
W20-1	W20-5L	W4-2L	W25-4	W25-4

Sign Spacing, Channelizing Device Spacing, Buffer Space, and Roll Ahead Space							
Speed	Channelizing Devices Spacing	Sign Spacing				Buffer Space	Roll Ahead Space
S (MPH)	2S (Feet)	A (Feet)	B (Feet)	C (Feet)	D (Feet)	E (Feet)	H (Feet)
40	80	1000	1640	2640	5280	305	150
45	90	1000	1640	2640	5280	360	150
50	100	1000	1640	2640	5280	425	250
55	110	1000	1640	2640	5280	495	250
60	120	1000	1640	2640	5280	570	250
65	130	1000	1640	2640	5280	645	250
70	140	1000	1640	2640	5280	730	250








Taper Lengths and Minimum Number Of Channelizing Devices								
Speed	Merging Taper: L		Shifting Taper: 1/2L		Shoulder Taper: 1/3L		5-' Per Lane Taper	
S (MPH)	Length (Feet)	Minimum Number Of Devices	Length (Feet)	Minimum Number Of Devices	Length (Feet)	Minimum Number Of Devices	Length (Feet)	Minimum Number Of Devices
40	320	9	160	6	110	6	50	6
45	540	13	270	7	180	6	50	6
50	600	13	300	7	200	6	50	6
55	660	13	330	7	220	6	50	6
60	720	13	360	7	240	6	50	6
65	780	13	390	7	260	6	50	6
70	840	13	420	7	280	6	50	6

PATA 404-B



PATA 405-A

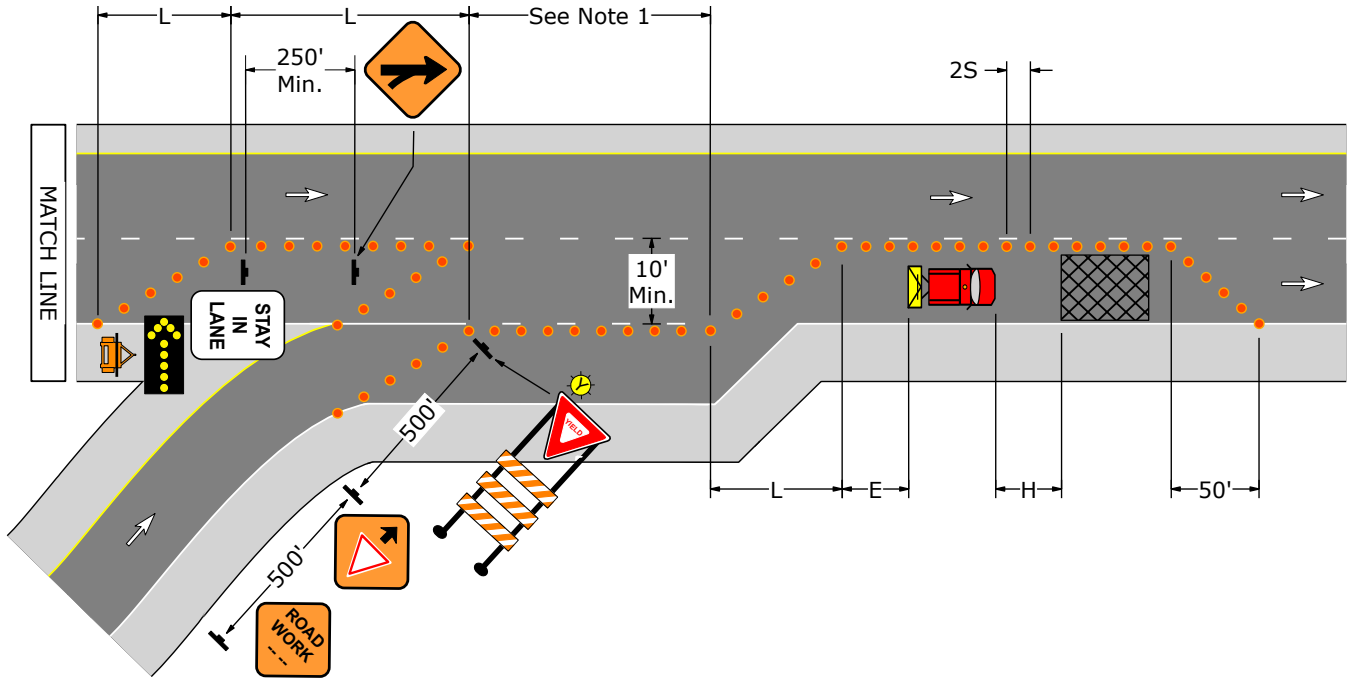
1. The acceleration lane should be maintained at the longest length that will accommodate adjacent tapers.
2. Placement of the temporary MERGE RIGHT sign is optional if the permanent MERGE RIGHT sign is clearly visible and is within 500' of the location shown on the drawing.

Signs						
						
W20-1	W20-5R	W4-2R	W4-1R	W3-2	R1-2	R4-9

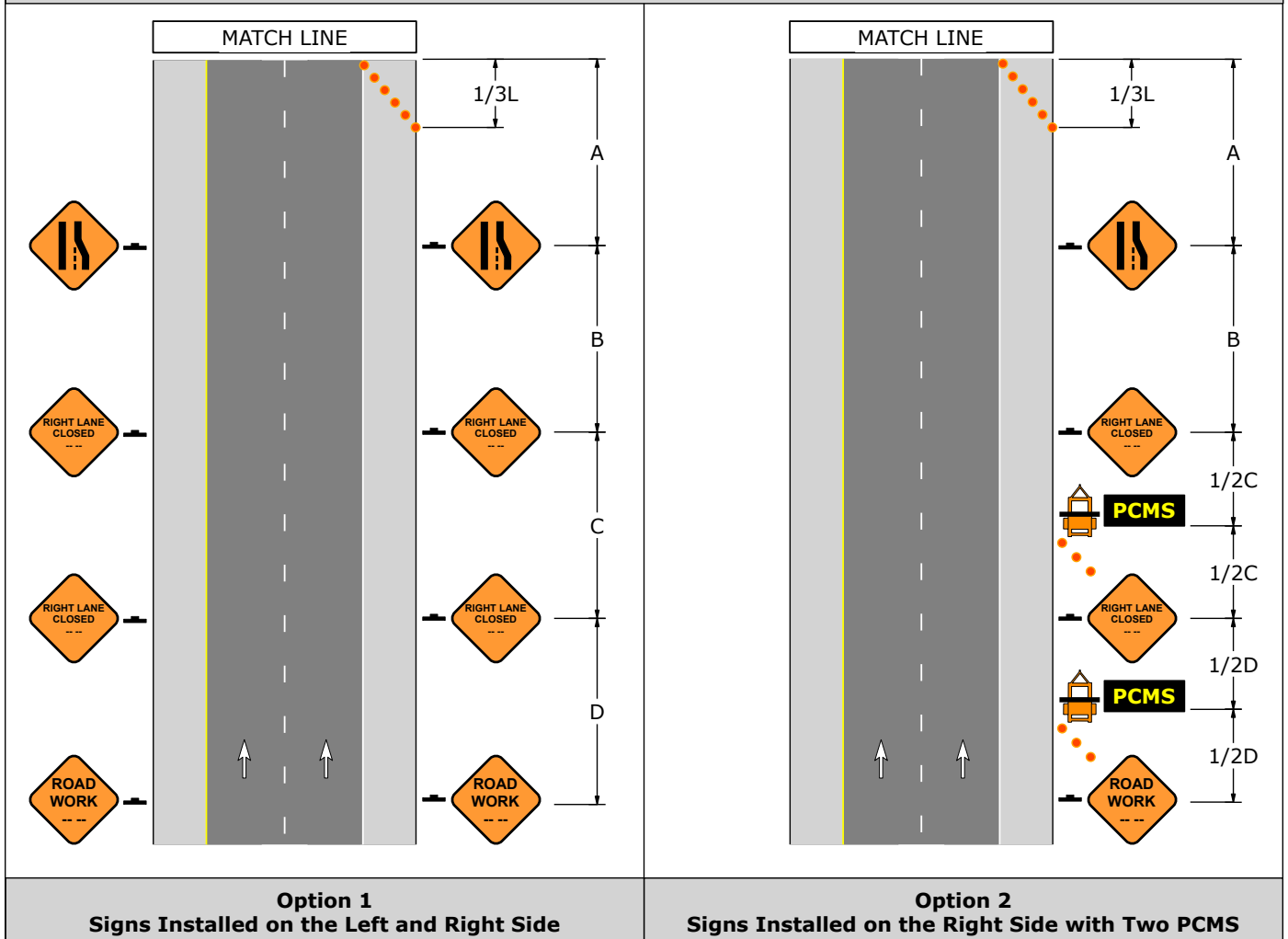
Sign Spacing, Channelizing Device Spacing, Buffer Space, and Roll Ahead Space							
Speed	Channelizing Devices Spacing	Sign Spacing				Buffer Space	Roll Ahead Space
S (MPH)	2S (Feet)	A (Feet)	B (Feet)	C (Feet)	D (Feet)	E (Feet)	H (Feet)
40	80	1000	1640	2640	5280	305	150
45	90	1000	1640	2640	5280	360	150
50	100	1000	1640	2640	5280	425	250
55	110	1000	1640	2640	5280	495	250
60	120	1000	1640	2640	5280	570	250
65	130	1000	1640	2640	5280	645	250
70	140	1000	1640	2640	5280	730	250

Taper Lengths and Minimum Number Of Channelizing Devices						
Speed	Merging Taper: L		Shoulder Taper: 1/3L		50' Per Lane Taper	
S (MPH)	Length (Feet)	Minimum Number Of Devices	Length (Feet)	Minimum Number Of Devices	Length (Feet)	Minimum Number Of Devices
40	320	9	110	6	50	6
45	540	13	180	6	50	6
50	600	13	200	6	50	6
55	660	13	220	6	50	6
60	720	13	240	6	50	6
65	780	13	260	6	50	6
70	840	13	280	6	50	6

PATA 405-A










Advance Warning Area



PATA 405-B

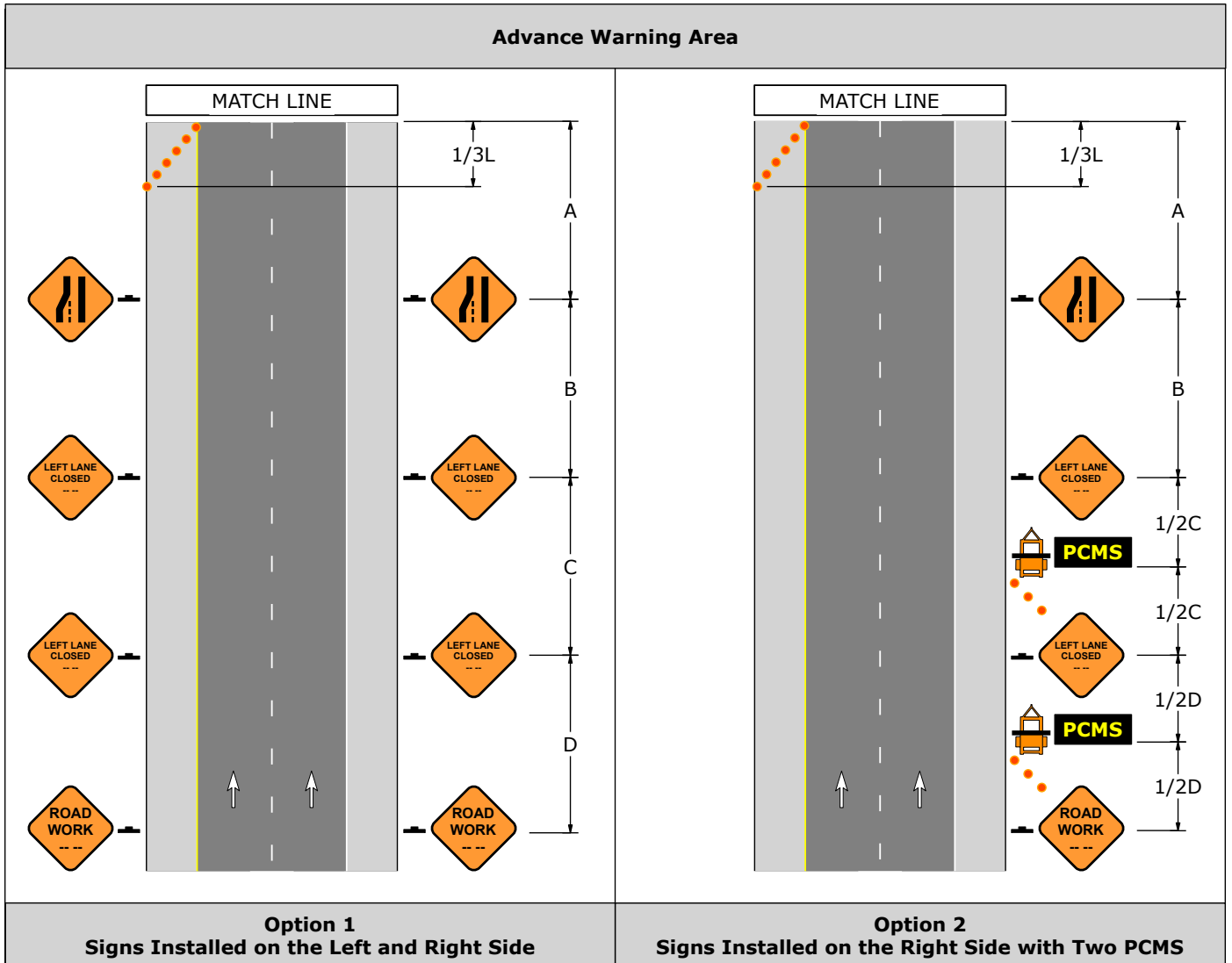
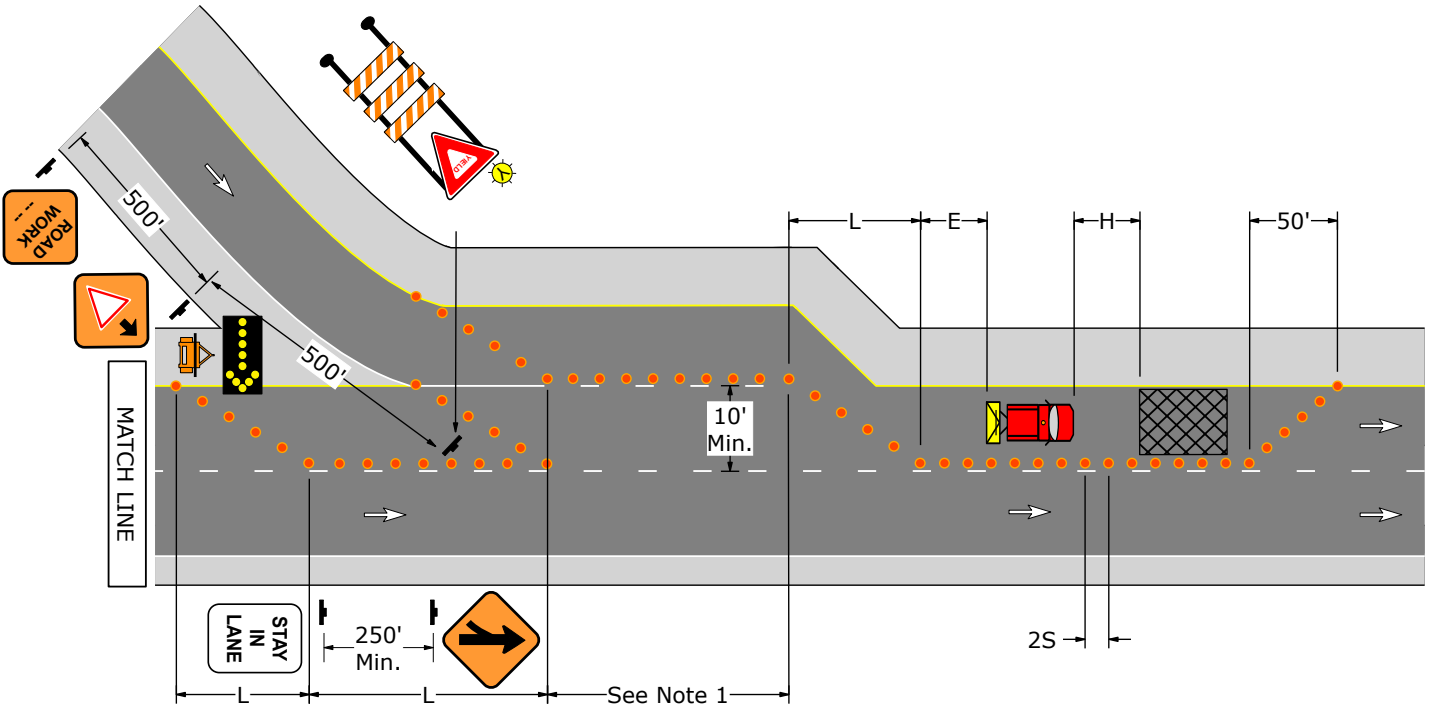
1. The acceleration lane should be maintained at the longest length that will accommodate adjacent tapers.
2. Placement of the temporary MERGE LEFT sign is optional if the permanent MERGE LEFT sign is clearly visible and is within 500' of the location shown on the drawing.

Signs						
						
W20-1	W20-5L	W4-2L	W4-1L	W3-2	R1-2	R4-9

Sign Spacing, Channelizing Device Spacing, Buffer Space, and Roll Ahead Space							
Speed	Channelizing Devices Spacing	Sign Spacing				Buffer Space	Roll Ahead Space
S (MPH)	2S (Feet)	A (Feet)	B (Feet)	C (Feet)	D (Feet)	E (Feet)	H (Feet)
40	80	1000	1640	2640	5280	305	150
45	90	1000	1640	2640	5280	360	150
50	100	1000	1640	2640	5280	425	250
55	110	1000	1640	2640	5280	495	250
60	120	1000	1640	2640	5280	570	250
65	130	1000	1640	2640	5280	645	250
70	140	1000	1640	2640	5280	730	250








Taper Lengths and Minimum Number Of Channelizing Devices						
Speed	Merging Taper: L		Shoulder Taper: 1/3L		50' Per Lane	
S (MPH)	Length (Feet)	Minimum Number Of Devices	Length (Feet)	Minimum Number Of Devices	Length (Feet)	Minimum Number Of Devices
40	320	9	110	6	50	6
45	540	13	180	6	50	6
50	600	13	200	6	50	6
55	660	13	220	6	50	6
60	720	13	240	6	50	6
65	780	13	260	6	50	6
70	840	13	280	6	50	6

PATA 405-B



PATA 406-A

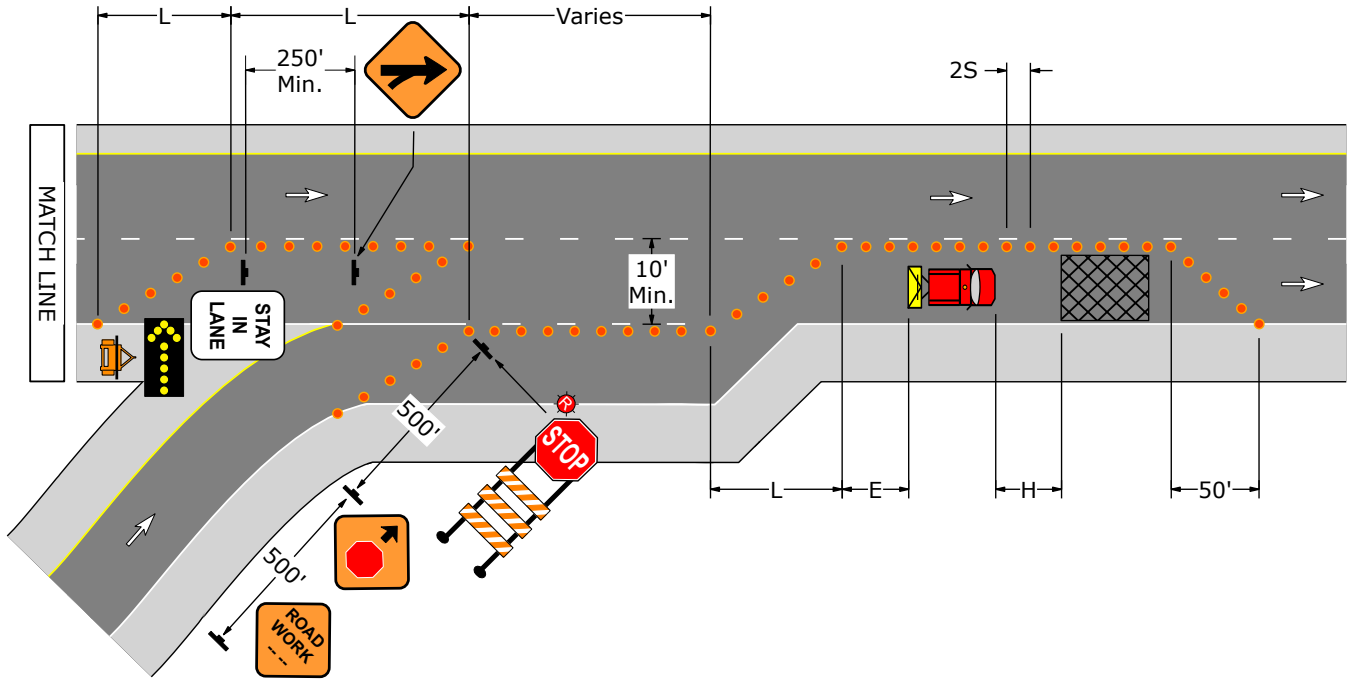
1. Placement of the temporary MERGE RIGHT sign is optional if the permanent MERGE RIGHT sign is clearly visible and is within 500' of the location shown on the drawing.

Signs						
						
W20-1	W20-5R	W4-2R	W4-1R	W3-1	R1-1	R4-9

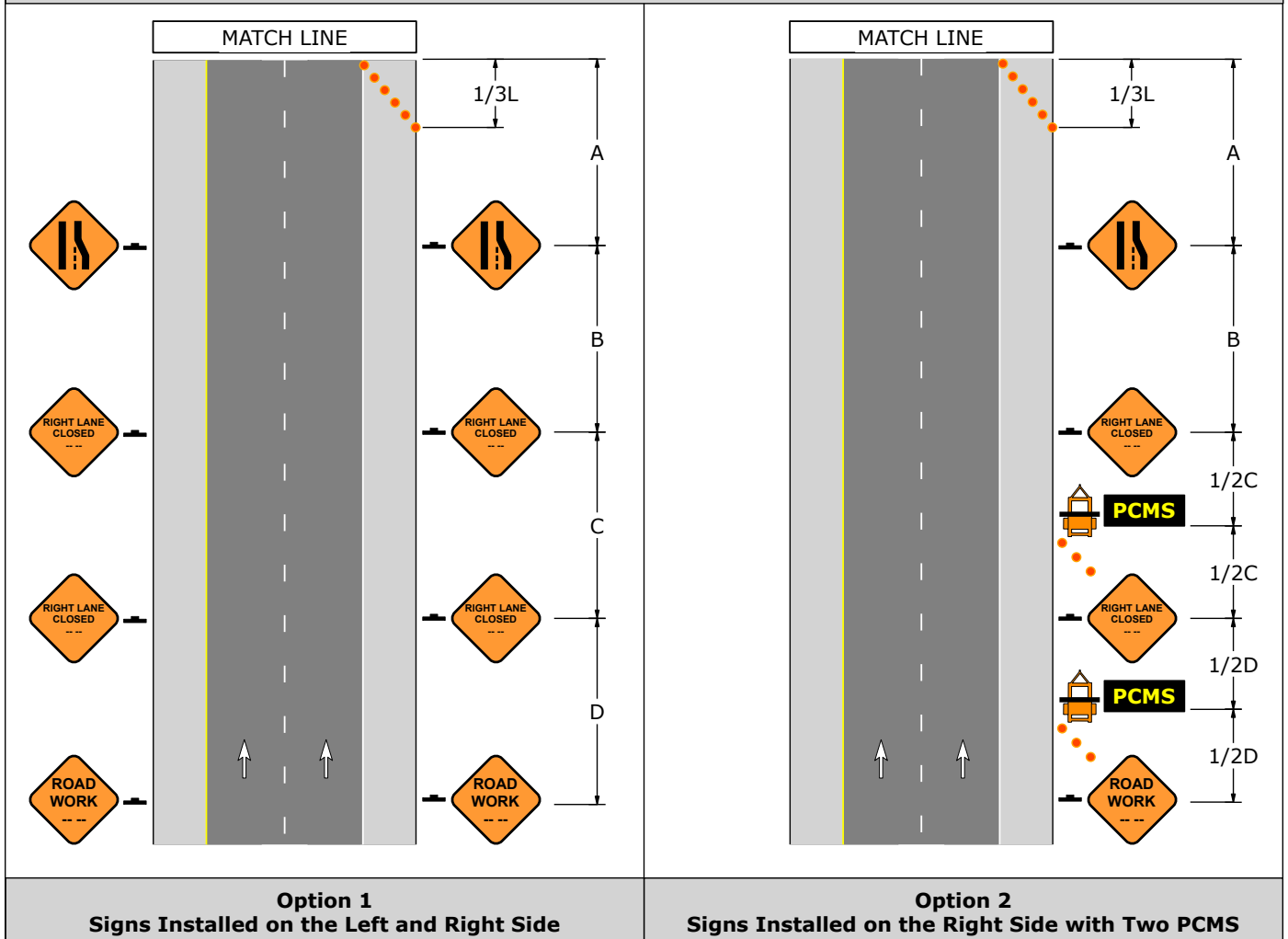
Sign Spacing, Channelizing Device Spacing, Buffer Space, and Roll Ahead Space							
Speed	Channelizing Devices Spacing	Sign Spacing				Buffer Space	Roll Ahead Space
S (MPH)	2S (Feet)	A (Feet)	B (Feet)	C (Feet)	D (Feet)	E (Feet)	H (Feet)
40	80	1000	1640	2640	5280	305	150
45	90	1000	1640	2640	5280	360	150
50	100	1000	1640	2640	5280	425	250
55	110	1000	1640	2640	5280	495	250
60	120	1000	1640	2640	5280	570	250
65	130	1000	1640	2640	5280	645	250
70	140	1000	1640	2640	5280	730	250

Taper Lengths and Minimum Number Of Channelizing Devices						
Speed	Merging Taper: L		Shoulder Taper: 1/3L		50' Per Lane Taper	
S (MPH)	Length (Feet)	Minimum Number Of Devices	Length (Feet)	Minimum Number Of Devices	Length (Feet)	Minimum Number Of Devices
40	320	9	110	6	50	6
45	540	13	180	6	50	6
50	600	13	200	6	50	6
55	660	13	220	6	50	6
60	720	13	240	6	50	6
65	780	13	260	6	50	6
70	840	13	280	6	50	6

PATA 406-A










Advance Warning Area



PATA 406-B

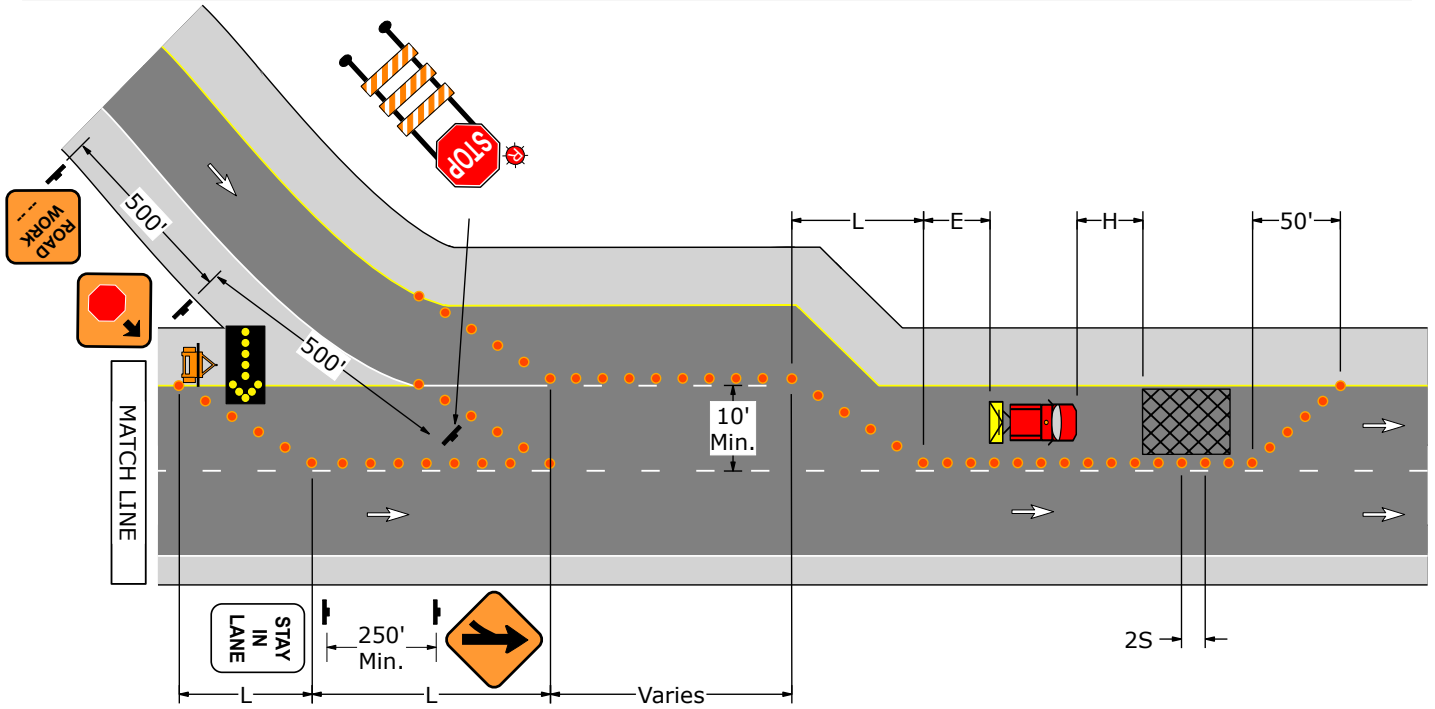
1. Placement of the temporary MERGE LEFT sign is optional if the permanent MERGE LEFT sign is clearly visible and is within 500' of the location shown in this PATA.

Signs						
						
W20-1	W20-5L	W4-2L	W4-1L	W3-1	R1-1	R4-9

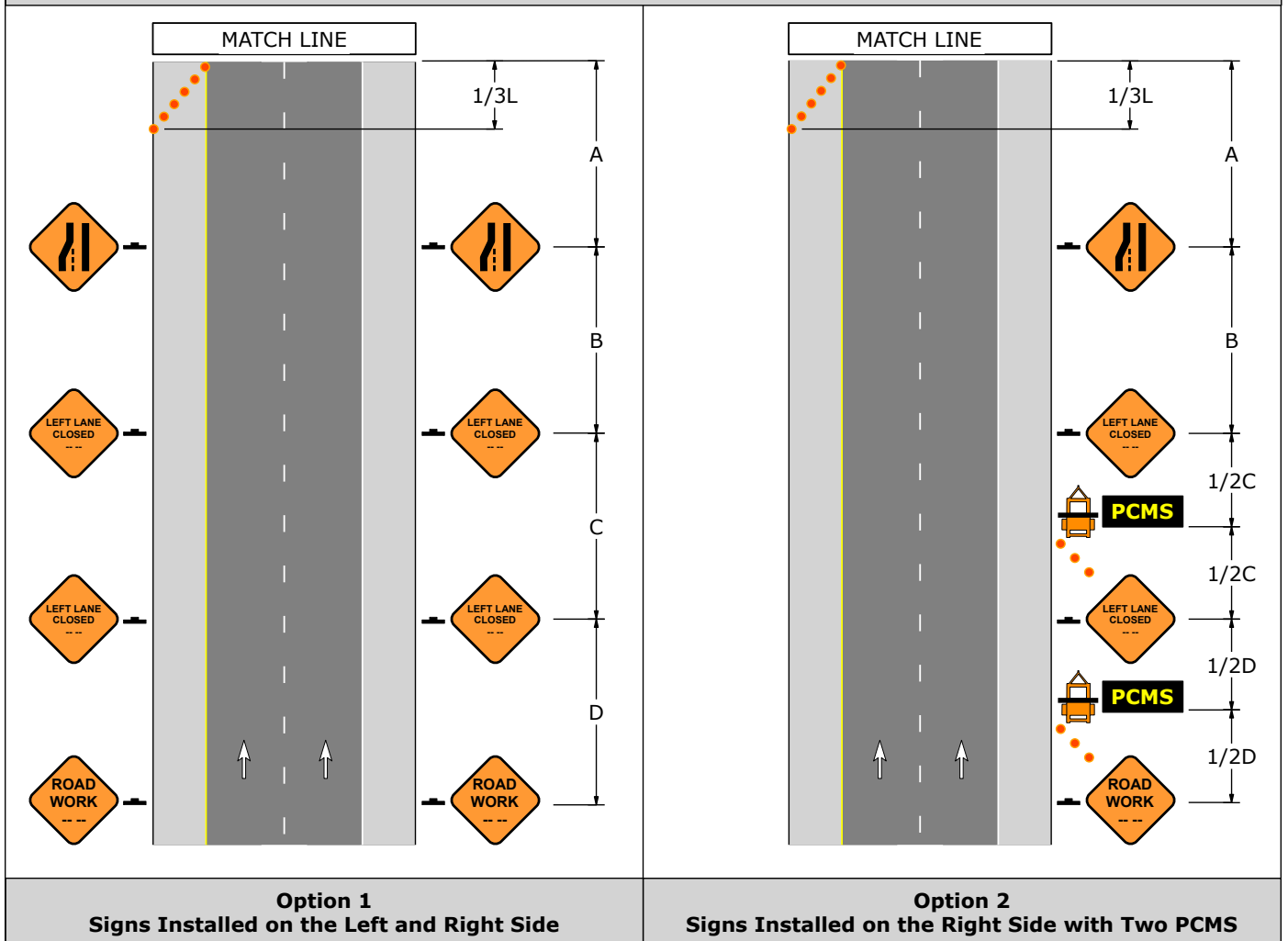
Sign Spacing, Channelizing Device Spacing, Buffer Space, and Roll Ahead Space							
Speed	Channelizing Devices Spacing	Sign Spacing				Buffer Space	Roll Ahead Space
S (MPH)	2S (Feet)	A (Feet)	B (Feet)	C (Feet)	D (Feet)	E (Feet)	H (Feet)
40	80	1000	1640	2640	5280	305	150
45	90	1000	1640	2640	5280	360	150
50	100	1000	1640	2640	5280	425	250
55	110	1000	1640	2640	5280	495	250
60	120	1000	1640	2640	5280	570	250
65	130	1000	1640	2640	5280	645	250
70	140	1000	1640	2640	5280	730	250

Taper Lengths and Minimum Number Of Channelizing Devices						
Speed	Merging Taper: L		Shoulder Taper: 1/3L		50' Per Lane Taper	
S (MPH)	Length (Feet)	Minimum Number Of Devices	Length (Feet)	Minimum Number Of Devices	Length (Feet)	Minimum Number Of Devices
40	320	9	110	6	50	6
45	540	13	180	6	50	6
50	600	13	200	6	50	6
55	660	13	220	6	50	6
60	720	13	240	6	50	6
65	780	13	260	6	50	6
70	840	13	280	6	50	6

PATA 406-B





Advance Warning Area



PATA 407

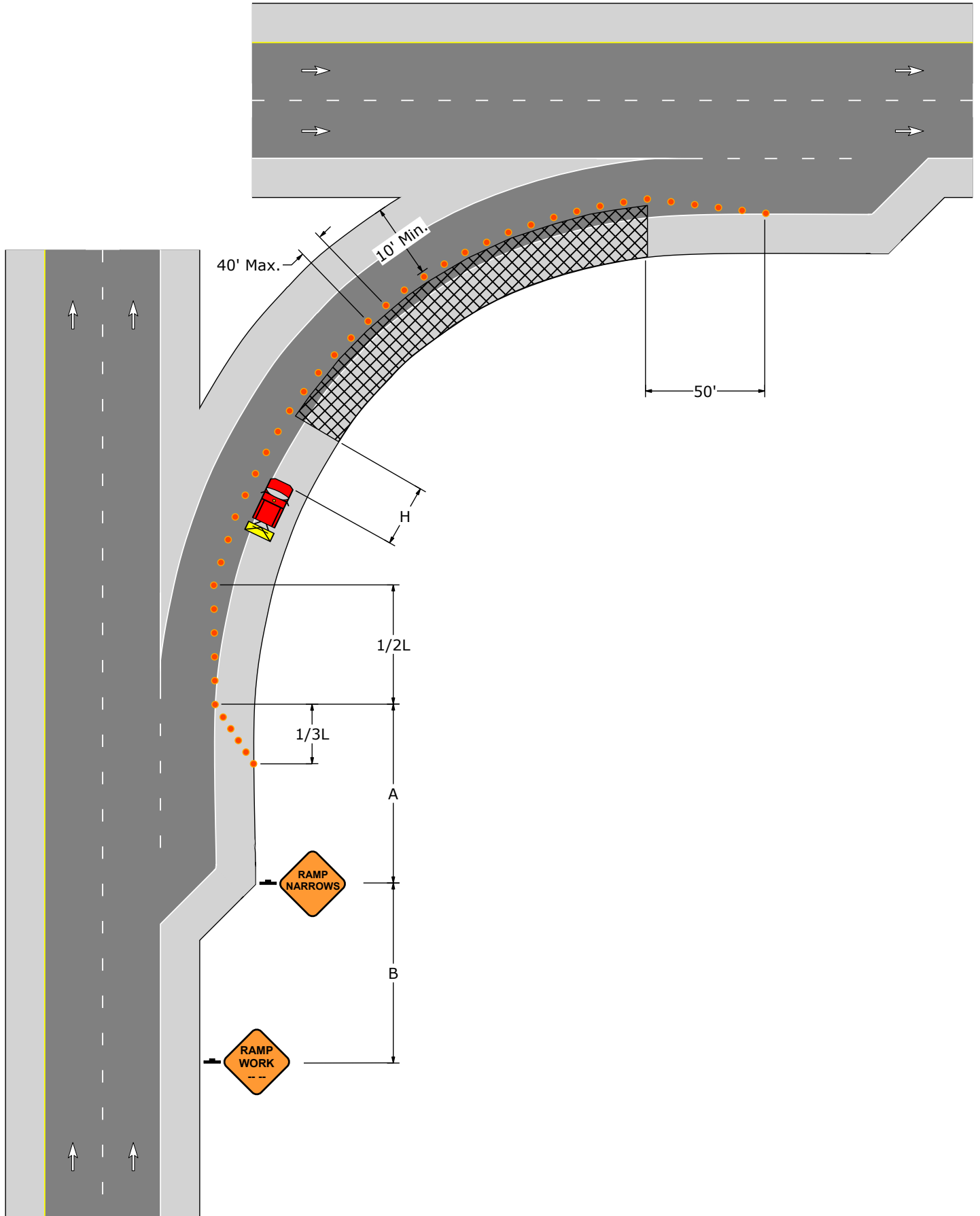
1. The shoulder must be in good condition prior to using it for traffic.

Signs	
	
W21-101	W5-4

Sign Spacing and Roll Ahead Space			
Speed	Sign Spacing		Roll Ahead Space
S (MPH)	A (Feet)	B (Feet)	H (Feet)
40	1000	1640	150
45	1000	1640	150
50	1000	1640	250
55	1000	1640	250
60	1000	1640	250
65	1000	1640	250
70	1000	1640	250




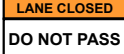
Taper Lengths and Minimum Number Of Channelizing Devices						
Speed	Shifting Taper: 1/2L		Shoulder Taper: 1/3L		50' Per Lane Taper	
S (MPH)	Length (Feet)	Minimum Number Of Devices	Length (Feet)	Minimum Number Of Devices	Length (Feet)	Minimum Number Of Devices
40	160	6	110	6	50	6
45	270	7	180	6	50	6
50	300	7	200	6	50	6
55	330	7	220	6	50	6
60	360	7	240	6	50	6
65	390	7	260	6	50	6
70	420	7	280	6	50	6

PATA 407

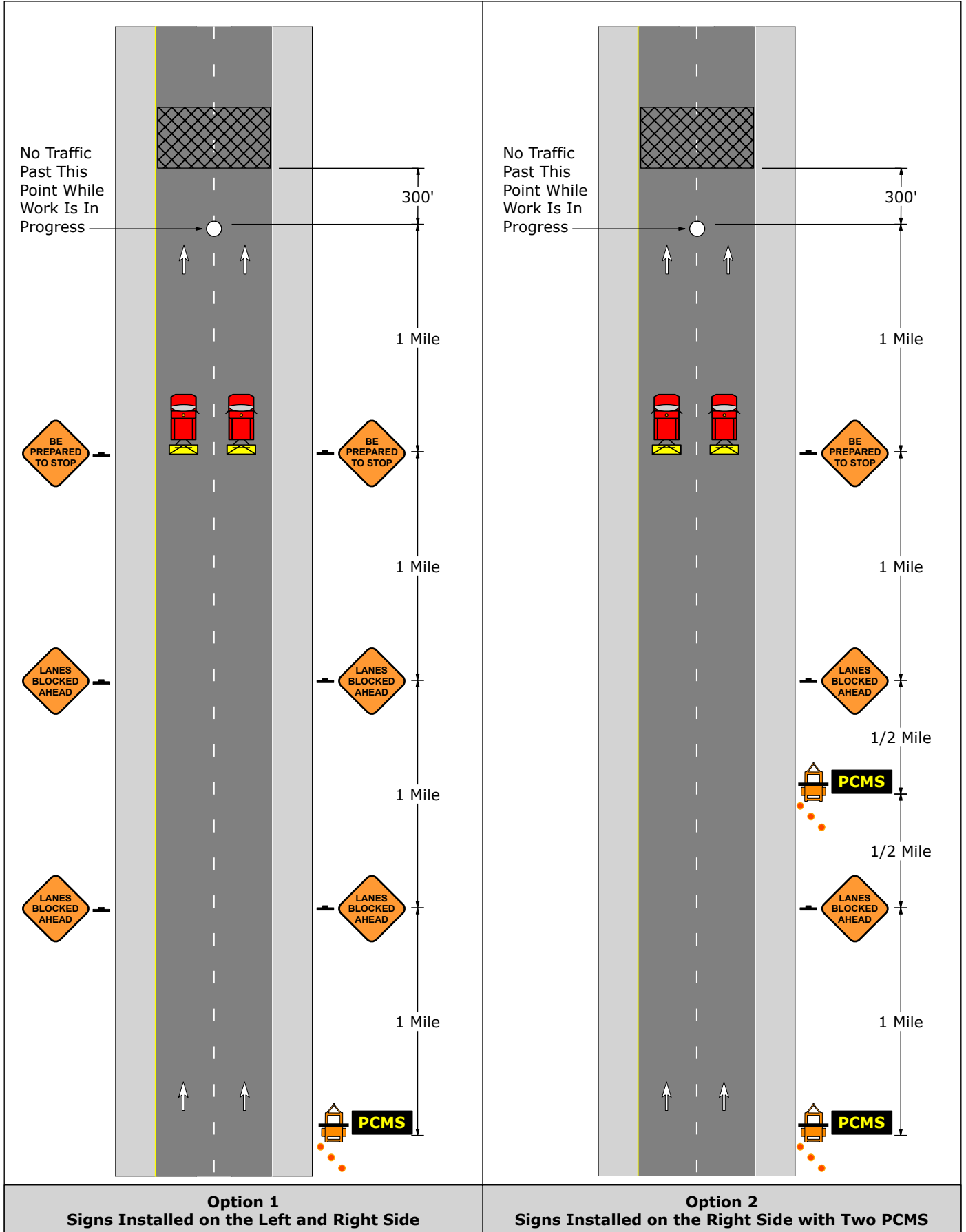


PATA 408

1. This PATA may be used for a rolling slow down or stoppage and the travel lanes shall not be occupied for more than 15 consecutive minutes. If work is not complete after the initial 15 minute period, all queued traffic must be cleared and allowed to return to normal speeds before beginning the next 15 minute operation.
2. Use one shadow vehicle per lane; each equipped with a TMA. These vehicles should start side by side at least one mile in advance of the point of stoppage and drive towards the work area to gradually slow traffic down. Once traffic is stopped one of the shadow vehicles shall block the roadway while the other is used in blocking the closed lane to discourage motorists from driving around. Drivers should be in communication with each other and one person at the work area.
3. Traffic utilizing the on-ramps must be stopped and held when the operation begins and must not be released until after the shadow vehicles have passed the on-ramps.
4. Contact the DTMC or RTMC two weeks in advance to provide information regarding this operation and to request guidance for PCMS message content and timing. Notify the same TMC one hour prior to beginning this operation in addition to notification requirements shown in General Note A-1.






Signs			
			
W3-4	W20-3	W20-101	G80-1

PATA 408



PATA 409-A

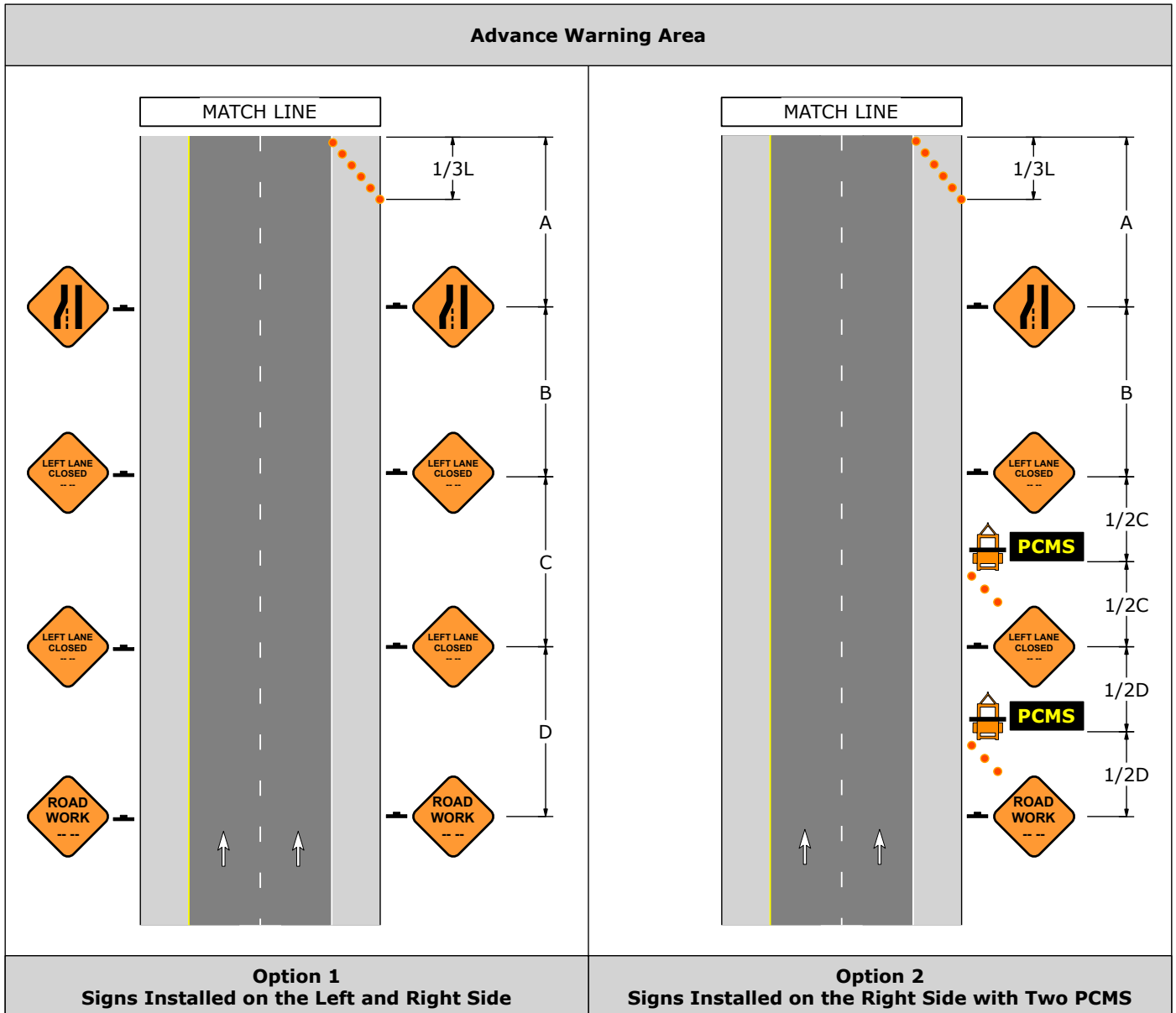
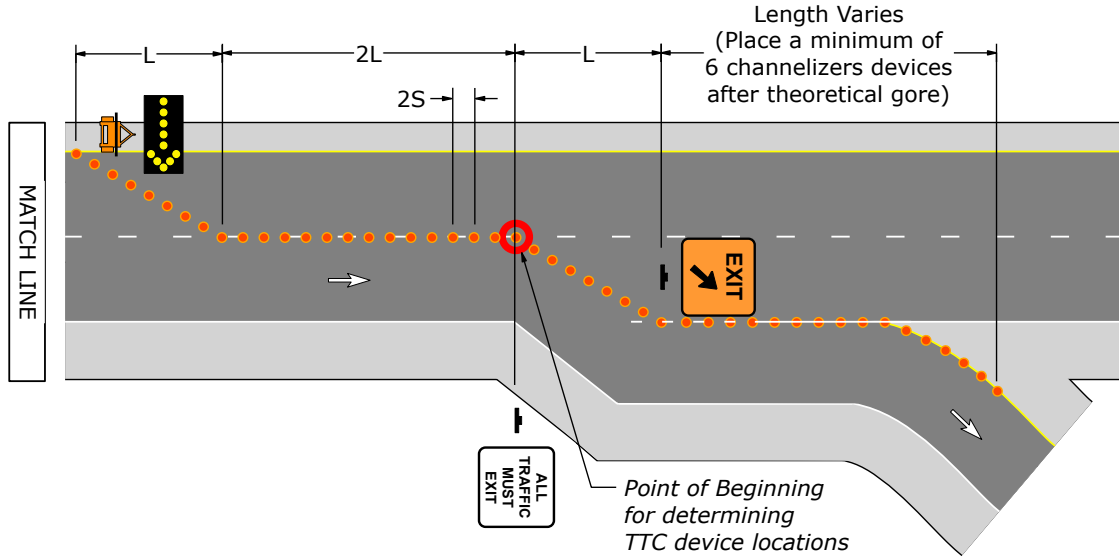
1. Use this PATA when a freeway/expressway is closed and all traffic must exit via a right-side ramp. If there are three or more lanes on the freeway/expressway, additional signs and devices are required as shown on PATA 403.
2. The Point of Beginning is used to determine TTC device locations as shown on the drawing.
3. Detoured traffic must be adequately controlled and efficiently guided towards the nearest available interchange to re-enter the highway.

Signs				
				
W20-1	W20-5L	W4-2L	W25-4	D14-103

Sign Spacing and Channelizing Device Spacing					
Speed	Channelizing Devices Spacing	Sign Spacing			
S (MPH)	2S (Feet)	A (Feet)	B (Feet)	C (Feet)	D (Feet)
40	80	1000	1640	2640	5280
45	90	1000	1640	2640	5280
50	100	1000	1640	2640	5280
55	110	1000	1640	2640	5280
60	120	1000	1640	2640	5280
65	130	1000	1640	2640	5280
70	140	1000	1640	2640	5280






Taper Lengths and Minimum Number Of Channelizing Devices				
Speed	Merging Taper: L		Shoulder Taper: 1/3L	
S (MPH)	Length (Feet)	Minimum Number Of Devices	Length (Feet)	Minimum Number Of Devices
40	320	9	110	6
45	540	13	180	6
50	600	13	200	6
55	660	13	220	6
60	720	13	240	6
65	780	13	260	6
70	840	13	280	6

PATA 409-A



PATA 409-B

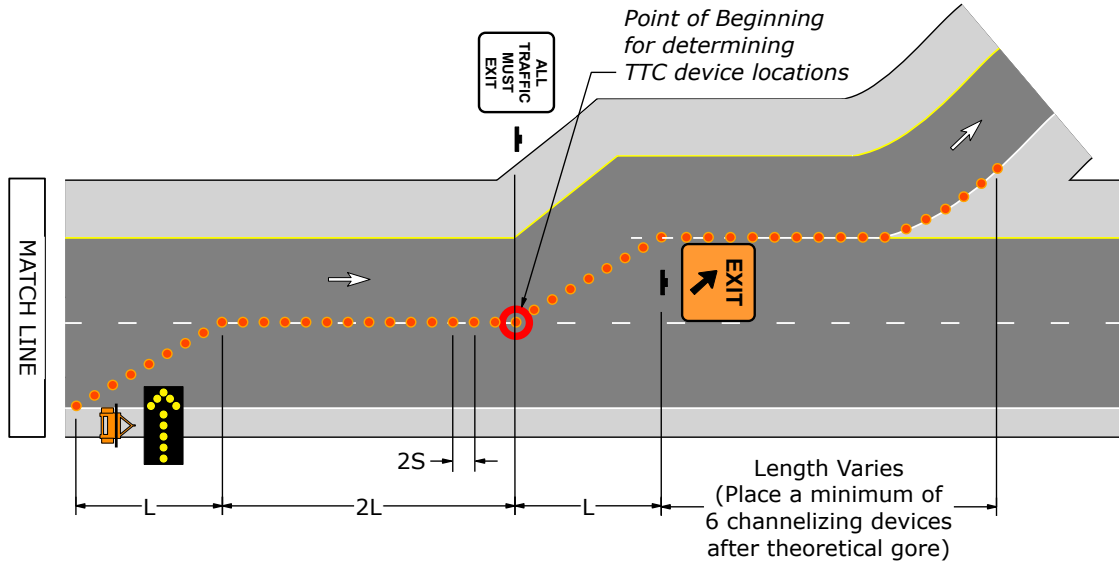
1. Use this PATA when a freeway/expressway is closed and all traffic must exit via a left-side ramp. If there are three or more lanes on the freeway/expressway, additional signs and devices are required as shown on PATA 403.
2. The Point of Beginning is used to determine TTC device locations as shown on the drawing.
3. Detoured traffic must be adequately controlled and efficiently guided towards the nearest available interchange to re-enter the highway.

Signs				
				
W20-1	W20-5R	W4-2R	W25-4	D14-103

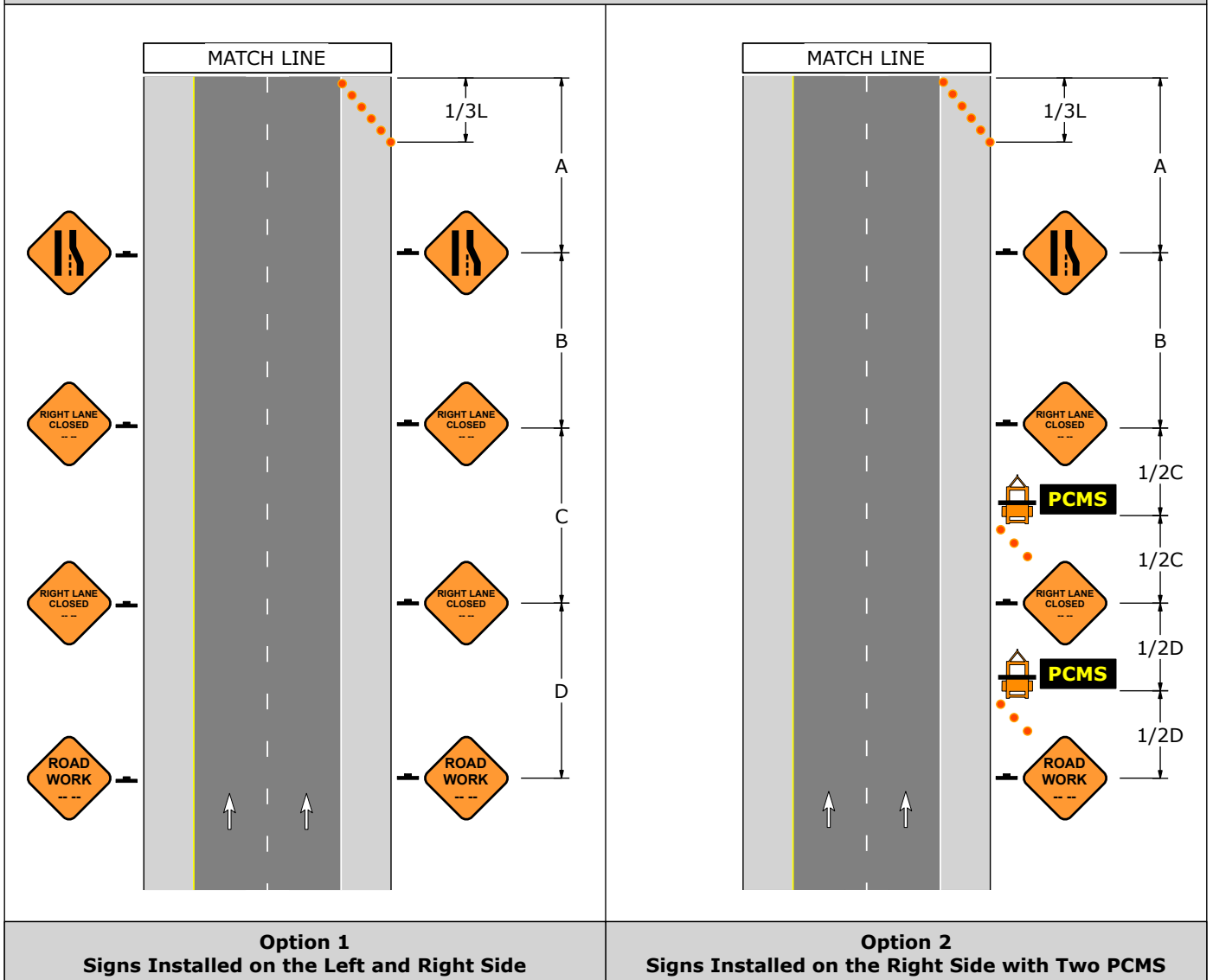
Sign Spacing and Channelizing Device Spacing					
Speed	Channelizing Devices Spacing	Sign Spacing			
S (MPH)	2S (Feet)	A (Feet)	B (Feet)	C (Feet)	D (Feet)
40	80	1000	1640	2640	5280
45	90	1000	1640	2640	5280
50	100	1000	1640	2640	5280
55	110	1000	1640	2640	5280
60	120	1000	1640	2640	5280
65	130	1000	1640	2640	5280
70	140	1000	1640	2640	5280

Taper Lengths and Minimum Number Of Channelizing Devices				
Speed	Merging Taper: L		Shoulder Taper: 1/3L	
S (MPH)	Length (Feet)	Minimum Number Of Devices	Length (Feet)	Minimum Number Of Devices
40	320	9	110	6
45	540	13	180	6
50	600	13	200	6
55	660	13	220	6
60	720	13	240	6
65	780	13	260	6
70	840	13	280	6

PATA 409-B



Advance Warning Area





Blank Page

Freeways & Expressways

Long-Term Stationary Operations
(PATA 500 Series)

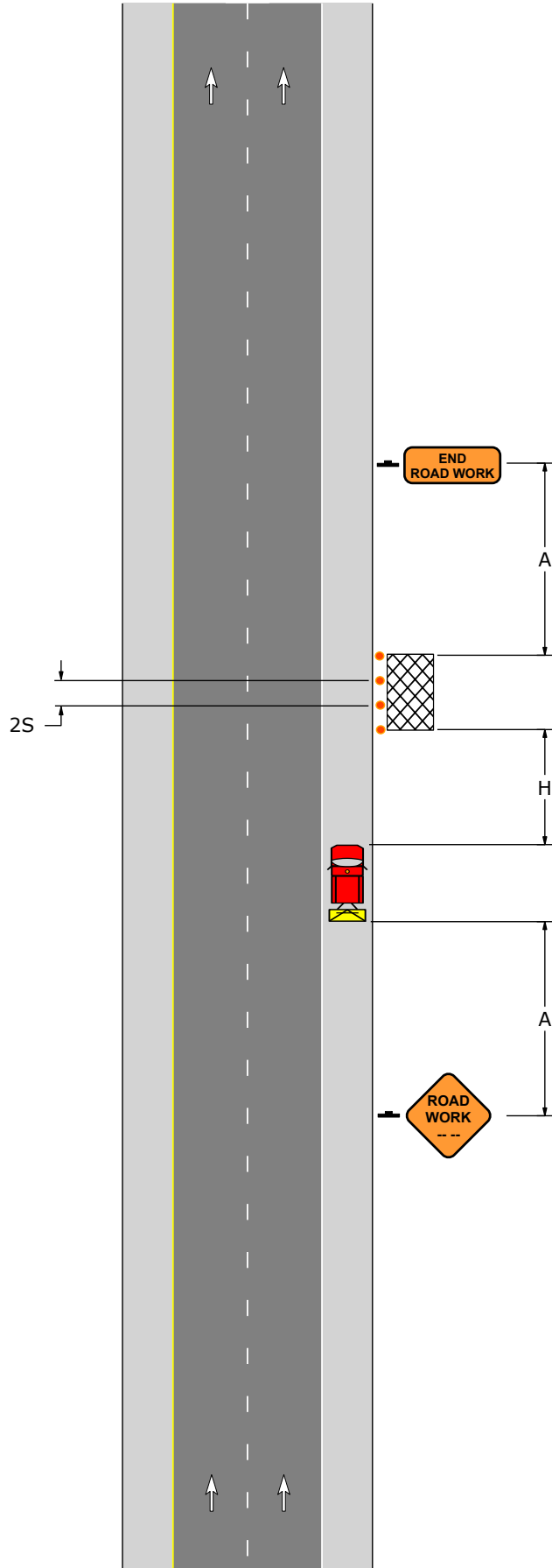
PATA 501-A

1. The shadow vehicle and traffic control devices are not required if the work space is outside the highway right-of-way, behind barrier, more than 2'-0" behind curb, or 15' or more from the edge of the roadway.

Signs	
	
W20-1	G20-2



Sign Spacing, Channelizing Device Spacing, and Roll Ahead Space			
Speed	Channelizing Devices Spacing	Sign Spacing	Roll Ahead Space
S (MPH)	2S (Feet)	A (Feet)	H (Feet)
40	80	1000	150
45	90	1000	150
50	100	1000	250
55	110	1000	250
60	120	1000	250
65	130	1000	250
70	140	1000	250

PATA 501-A



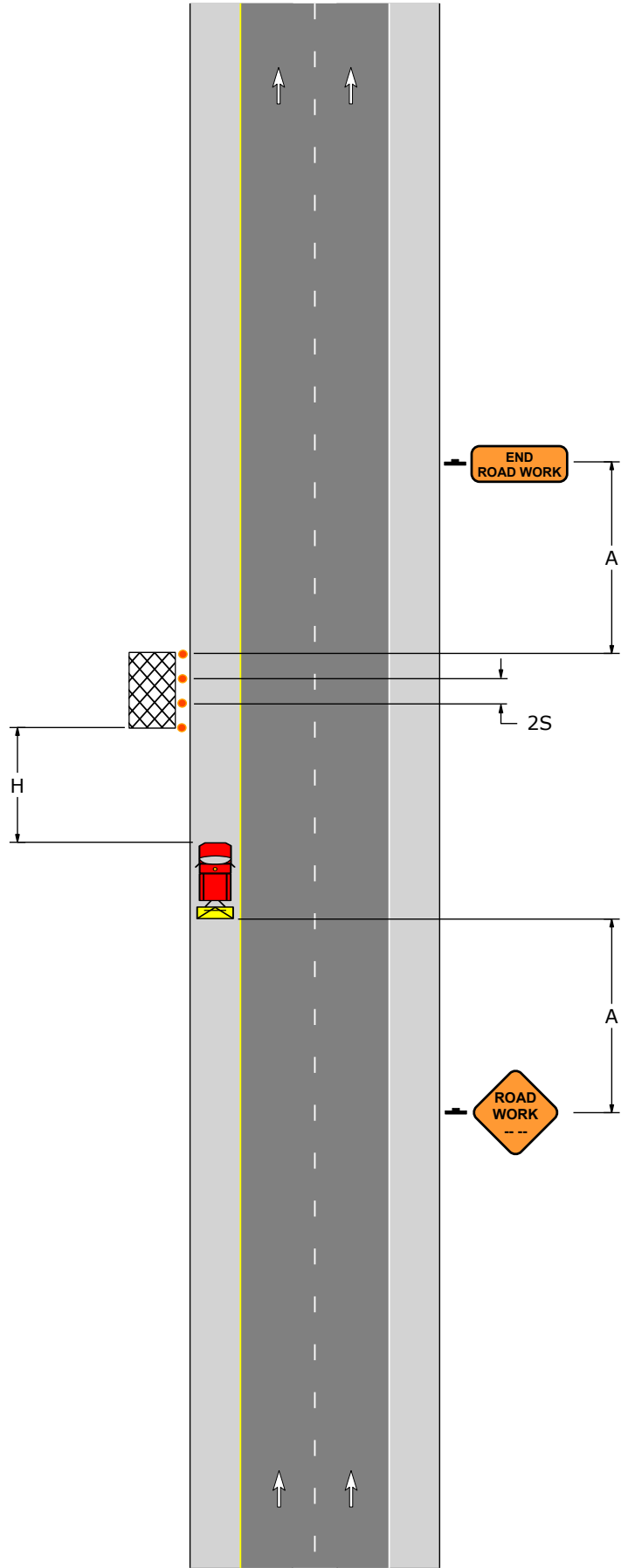
PATA 501-B

1. The shadow vehicle and traffic control devices are not required if the work space is outside the highway right-of-way, behind barrier, more than 2'-0" behind curb, or 15' or more from the edge of the roadway.





Signs	
	
W20-1	G20-2

Sign Spacing, Channelizing Device Spacing, and Roll Ahead Space			
Speed	Channelizing Devices Spacing	Sign Spacing	Roll Ahead Space
S (MPH)	2S (Feet)	A (Feet)	H (Feet)
40	80	1000	150
45	90	1000	150
50	100	1000	250
55	110	1000	250
60	120	1000	250
65	130	1000	250
70	140	1000	250

PATA 501-B



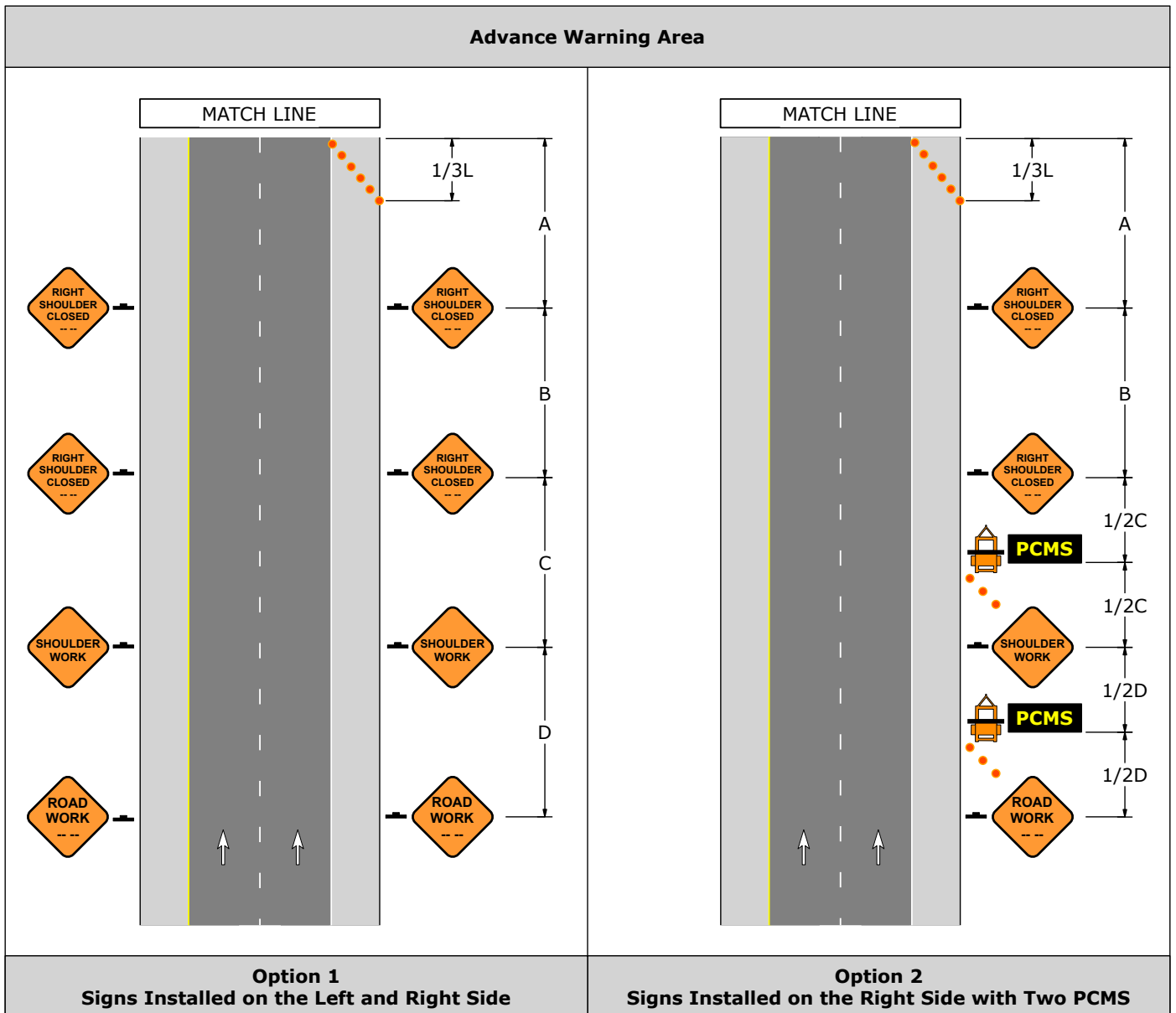
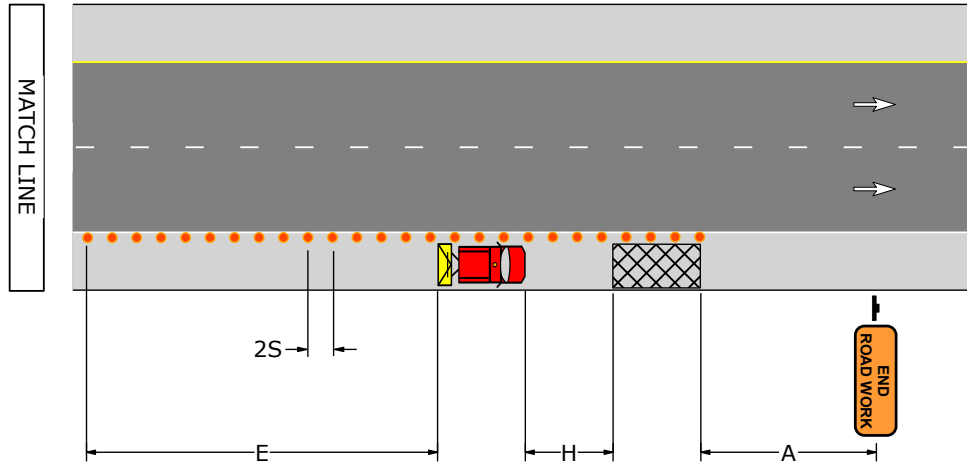
PATA 502-A

Signs			
			
W20-1	W21-5	W21-5BR	G20-2





Sign Spacing, Channelizing Device Spacing, Buffer Space, and Roll Ahead Space							
Speed	Channelizing Devices Spacing	Sign Spacing				Buffer Space	Roll Ahead Space
S (MPH)	2S (Feet)	A (Feet)	B (Feet)	C (Feet)	D (Feet)	E (Feet)	H (Feet)
40	80	1000	1640	2640	5280	305	150
45	90	1000	1640	2640	5280	360	150
50	100	1000	1640	2640	5280	425	250
55	110	1000	1640	2640	5280	495	250
60	120	1000	1640	2640	5280	570	250
65	130	1000	1640	2640	5280	645	250
70	140	1000	1640	2640	5280	730	250

Taper Lengths and Minimum Number of Channelizing Devices		
Speed	Shoulder Taper: 1/3L	
S (MPH)	Length (Feet)	Minimum Number Of Devices
40	110	6
45	180	6
50	200	6
55	220	6
60	240	6
65	260	6
70	280	6

PATA 502-A



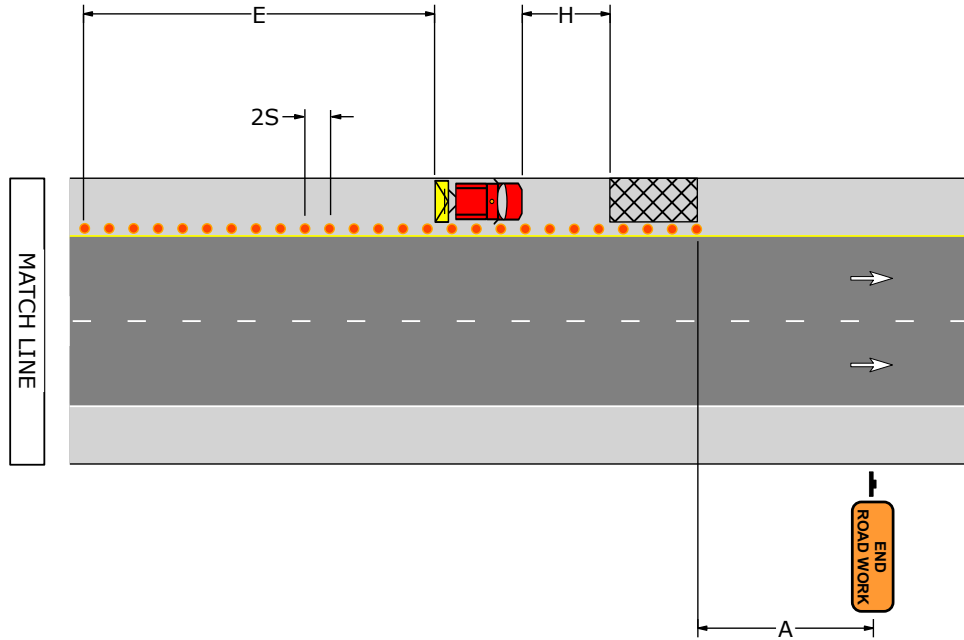
PATA 502-B

Signs			
			
W20-1	W21-5	W21-5BL	G20-2

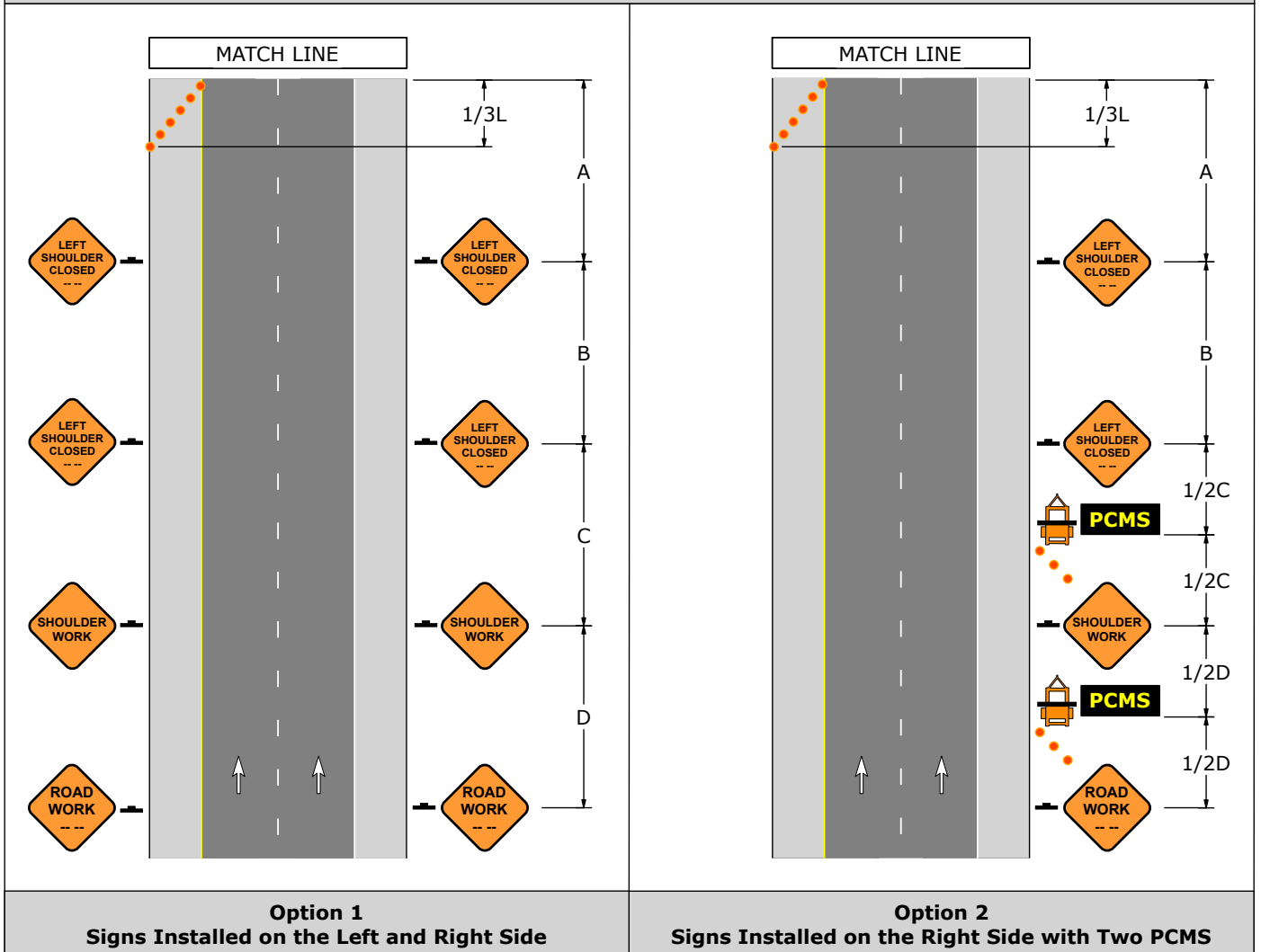
Sign Spacing, Channelizing Device Spacing, Buffer Space, and Roll Ahead Space							
Speed	Channelizing Devices Spacing	Sign Spacing				Buffer Space	Roll Ahead Space
S (MPH)	2S (Feet)	A (Feet)	B (Feet)	C (Feet)	D (Feet)	E (Feet)	H (Feet)
40	80	1000	1640	2640	5280	305	150
45	90	1000	1640	2640	5280	360	150
50	100	1000	1640	2640	5280	425	250
55	110	1000	1640	2640	5280	495	250
60	120	1000	1640	2640	5280	570	250
65	130	1000	1640	2640	5280	645	250
70	140	1000	1640	2640	5280	730	250

Taper Lengths and Minimum Number of Channelizing Devices		
Speed	Shoulder Taper: 1/3L	
S (MPH)	Length (Feet)	Minimum Number Of Devices
40	110	6
45	180	6
50	200	6
55	220	6
60	240	6
65	260	6
70	280	6

PATA 502-B







Advance Warning Area



PATA 503-A

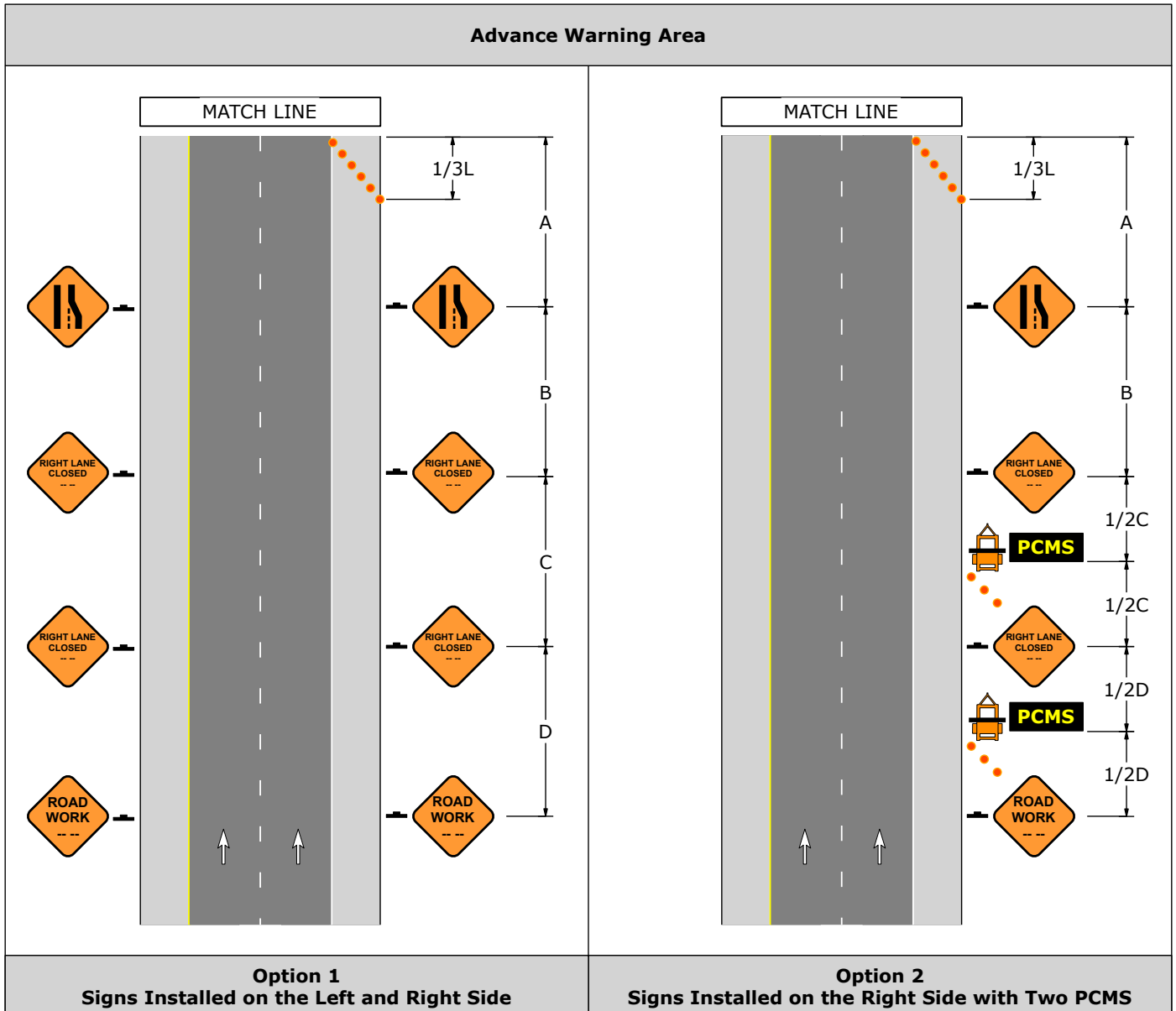
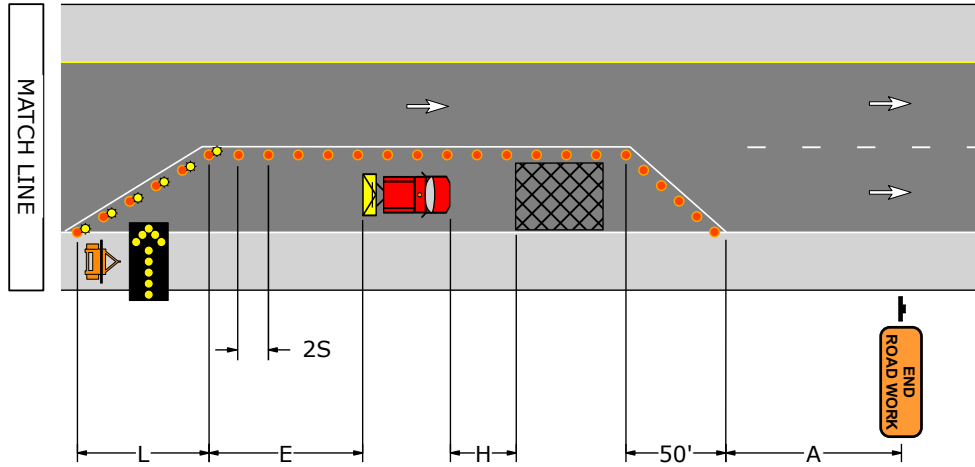
1. Sequential flashing warning lights are required on channelizing devices used to form the merging taper.

Signs			
			
W20-1	W20-5R	W4-2R	G20-2

Sign Spacing, Channelizing Device Spacing, Buffer Space, and Roll Ahead Space							
Speed	Channelizing Devices Spacing	Sign Spacing				Buffer Space	Roll Ahead Space
S (MPH)	2S (Feet)	A (Feet)	B (Feet)	C (Feet)	D (Feet)	E (Feet)	H (Feet)
40	80	1000	1640	2640	5280	305	150
45	90	1000	1640	2640	5280	360	150
50	100	1000	1640	2640	5280	425	250
55	110	1000	1640	2640	5280	495	250
60	120	1000	1640	2640	5280	570	250
65	130	1000	1640	2640	5280	645	250
70	140	1000	1640	2640	5280	730	250





Taper Lengths and Minimum Number Of Channelizing Devices						
Speed	Merging Taper: L		Shoulder Taper: 1/3L		50' Per Lane Taper	
S (MPH)	Length (Feet)	Minimum Number Of Devices	Length (Feet)	Minimum Number Of Devices	Length (Feet)	Minimum Number Of Devices
40	320	9	110	6	50	6
45	540	13	180	6	50	6
50	600	13	200	6	50	6
55	660	13	220	6	50	6
60	720	13	240	6	50	6
65	780	13	260	6	50	6
70	840	13	280	6	50	6

PATA 503-A



PATA 503-B

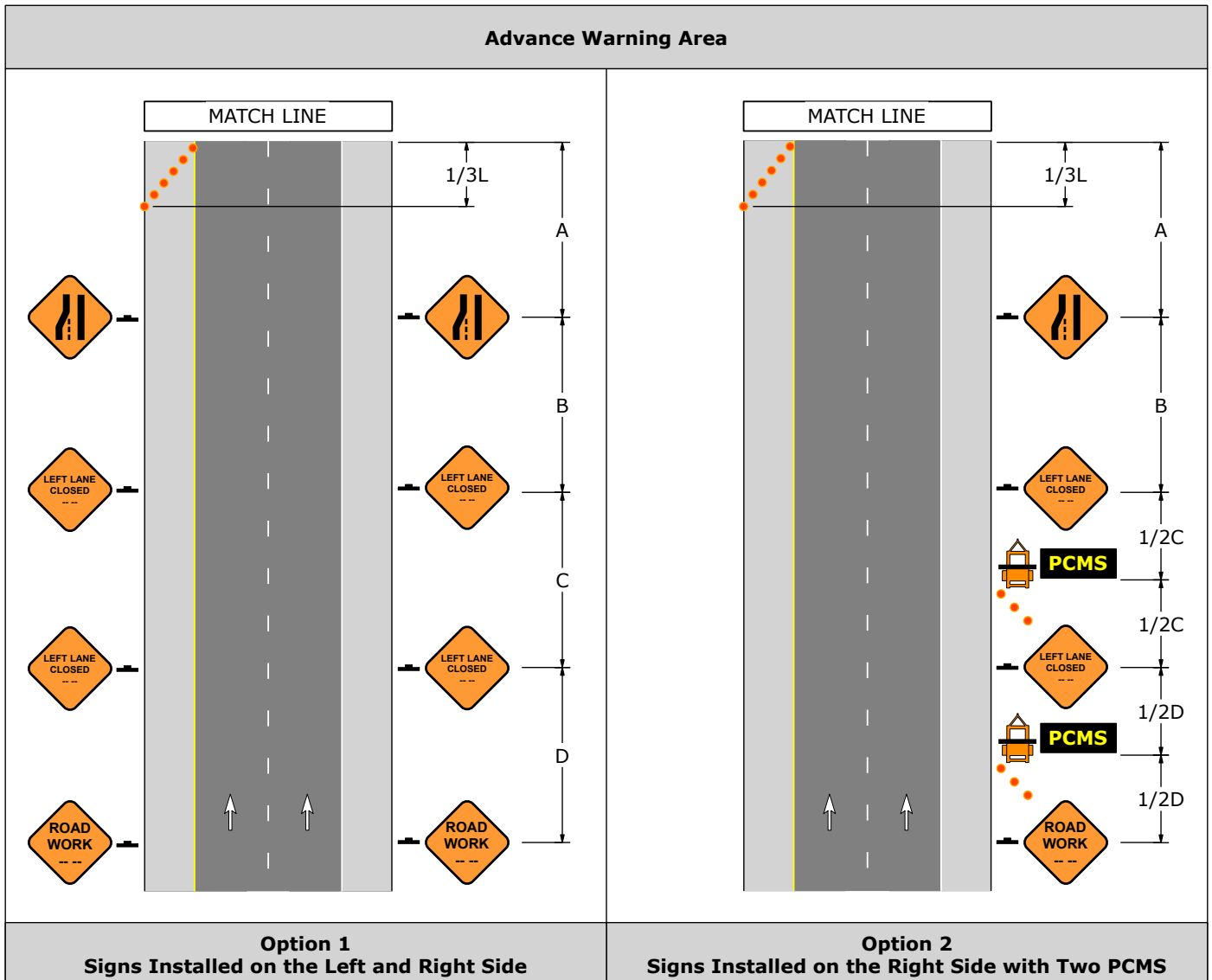
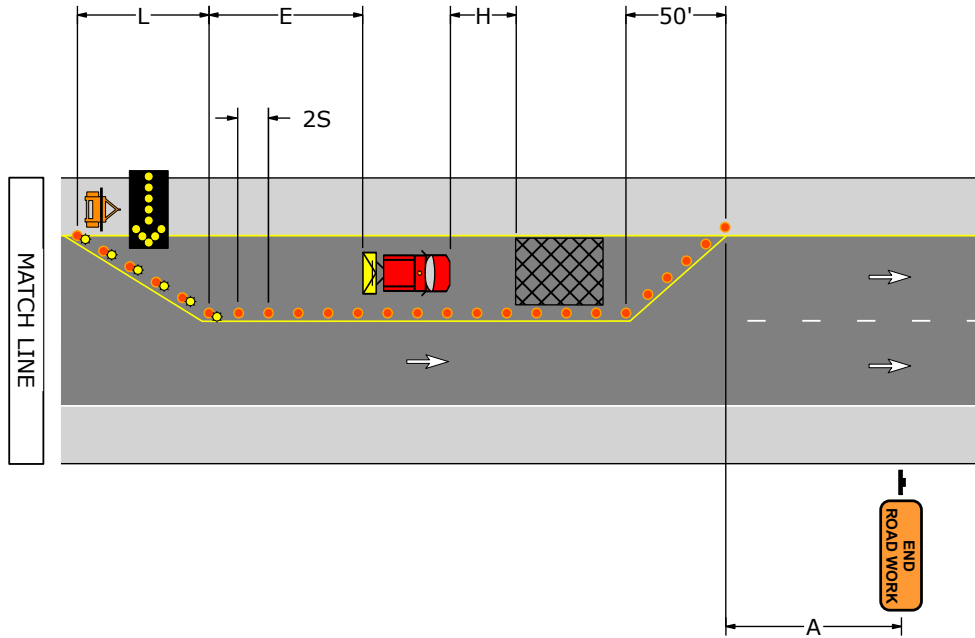
1. Sequential flashing warning lights are required on channelizing devices used to form the merging taper.

Signs			
			
W20-1	W20-5L	W4-2L	G20-2

Sign Spacing, Channelizing Device Spacing, Buffer Space, and Roll Ahead Space							
Speed	Channelizing Devices Spacing	Sign Spacing				Buffer Space	Roll Ahead Space
S (MPH)	2S (Feet)	A (Feet)	B (Feet)	C (Feet)	D (Feet)	E (Feet)	H (Feet)
40	80	1000	1640	2640	5280	305	150
45	90	1000	1640	2640	5280	360	150
50	100	1000	1640	2640	5280	425	250
55	110	1000	1640	2640	5280	495	250
60	120	1000	1640	2640	5280	570	250
65	130	1000	1640	2640	5280	645	250
70	140	1000	1640	2640	5280	730	250





Taper Lengths and Minimum Number Of Channelizing Devices						
Speed	Merging Taper: L		Shoulder Taper: 1/3L		50' Per Lane Taper	
S (MPH)	Length (Feet)	Minimum Number Of Devices	Length (Feet)	Minimum Number Of Devices	Length (Feet)	Minimum Number Of Devices
40	320	9	110	6	50	6
45	540	13	180	6	50	6
50	600	13	200	6	50	6
55	660	13	220	6	50	6
60	720	13	240	6	50	6
65	780	13	260	6	50	6
70	840	13	280	6	50	6

PATA 503-B



PATA 504-A

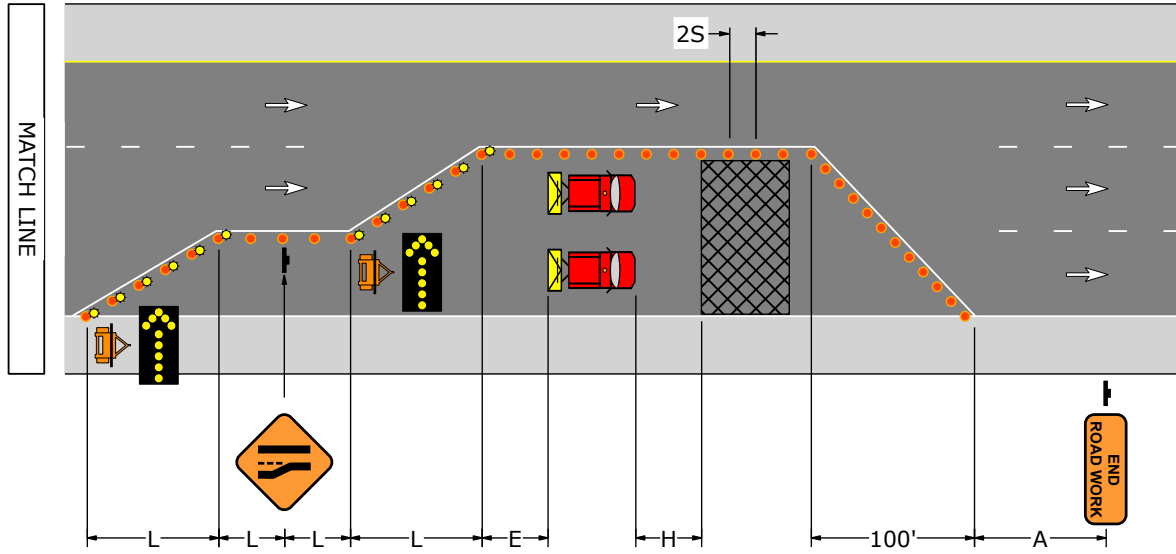
1. Sequential flashing warning lights are required on channelizing devices used to form the merging taper.

Signs			
			
W20-1	W20-5AR	W4-2R	G20-2

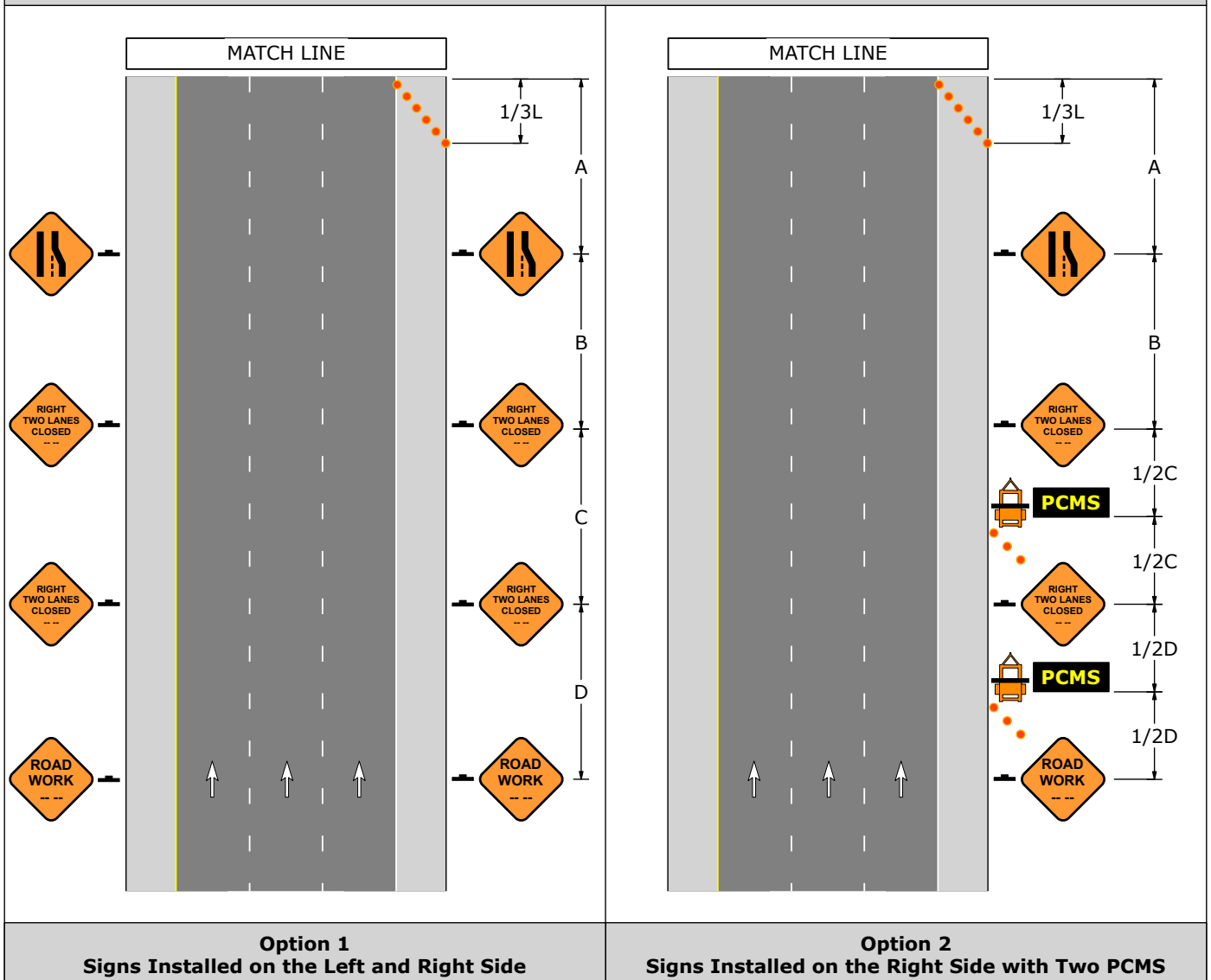
Sign Spacing, Channelizing Device Spacing, Buffer Space, and Roll Ahead Space							
Speed	Channelizing Devices Spacing	Sign Spacing				Buffer Space	Roll Ahead Space
S (MPH)	2S (Feet)	A (Feet)	B (Feet)	C (Feet)	D (Feet)	E (Feet)	H (Feet)
40	80	1000	1640	2640	5280	305	150
45	90	1000	1640	2640	5280	360	150
50	100	1000	1640	2640	5280	425	250
55	110	1000	1640	2640	5280	495	250
60	120	1000	1640	2640	5280	570	250
65	130	1000	1640	2640	5280	645	250
70	140	1000	1640	2640	5280	730	250

Taper Lengths and Minimum Number Of Channelizing Devices						
Speed	Merging Taper: L		Shoulder Taper: 1/3L		50' Per Lane Taper	
S (MPH)	Length (Feet)	Minimum Number Of Devices	Length (Feet)	Minimum Number Of Devices	Length (Feet)	Minimum Number Of Devices
40	320	9	110	6	100	6
45	540	13	180	6	100	6
50	600	13	200	6	100	6
55	660	13	220	6	100	6
60	720	13	240	6	100	6
65	780	13	260	6	100	6
70	840	13	280	6	100	6

PATA 504-A







Advance Warning Area



PATA 504-B

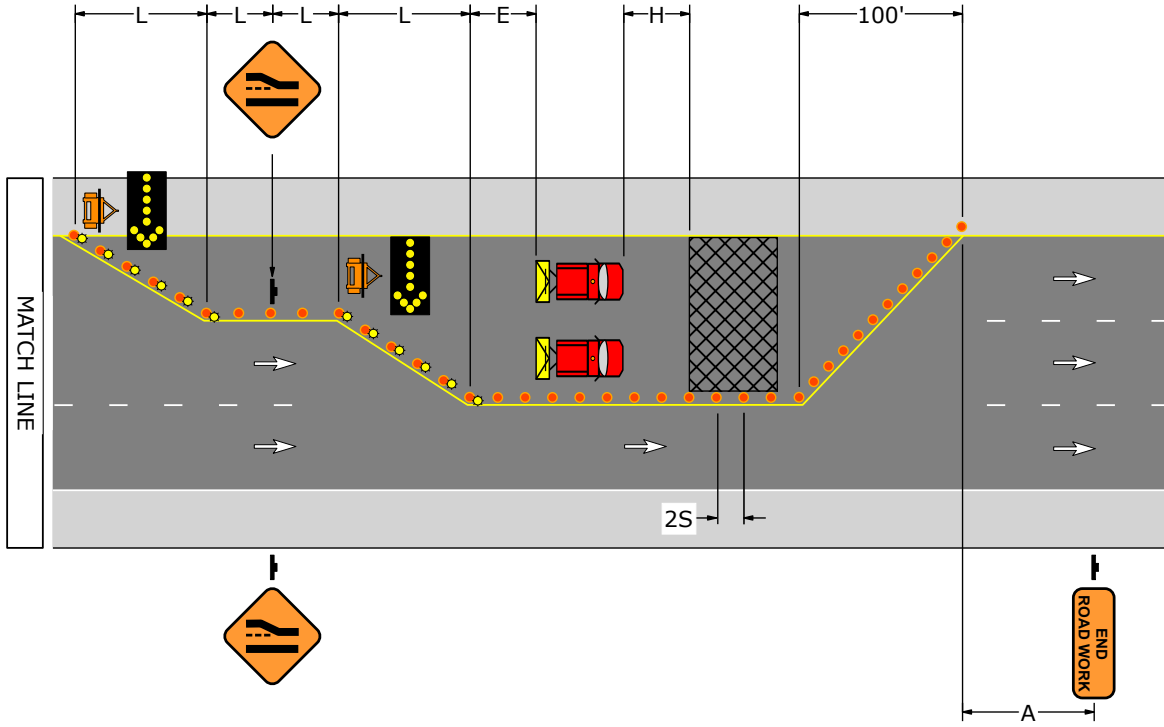
1. Sequential flashing warning lights are required on channelizing devices used to form the merging taper.

Signs			
			
W20-1	W20-5AL	W4-2L	G20-2

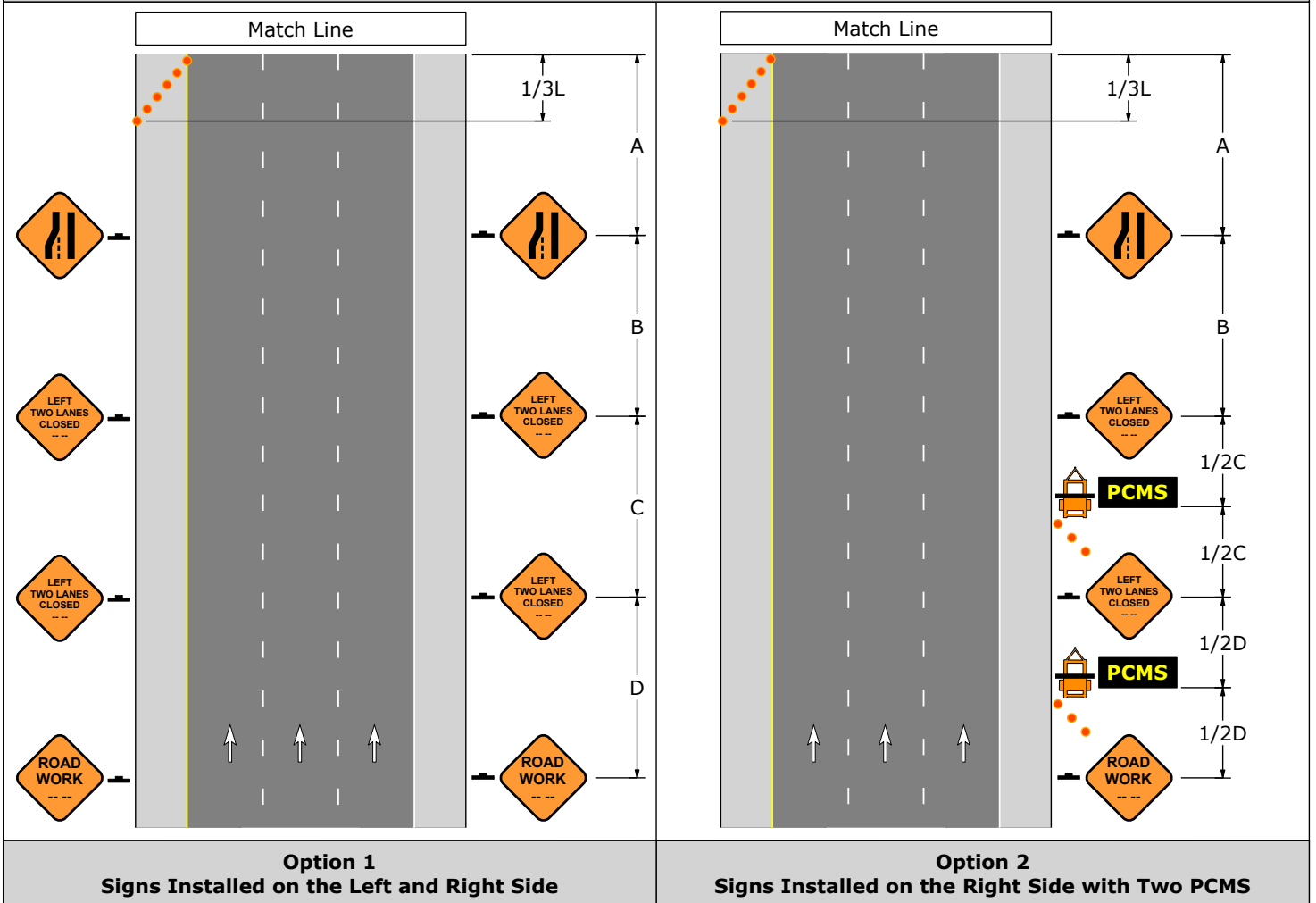
Sign Spacing, Channelizing Device Spacing, Buffer Space, and Roll Ahead Space							
Speed	Channelizing Devices Spacing	Sign Spacing				Buffer Space	Roll Ahead Space
S (MPH)	2S (Feet)	A (Feet)	B (Feet)	C (Feet)	D (Feet)	E (Feet)	H (Feet)
40	80	1000	1640	2640	5280	305	150
45	90	1000	1640	2640	5280	360	150
50	100	1000	1640	2640	5280	425	250
55	110	1000	1640	2640	5280	495	250
60	120	1000	1640	2640	5280	570	250
65	130	1000	1640	2640	5280	645	250
70	140	1000	1640	2640	5280	730	250

Taper Lengths and Minimum Number Of Channelizing Devices						
Speed	Merging Taper: L		Shoulder Taper: 1/3L		50' Per Lane Taper	
S (MPH)	Length (Feet)	Minimum Number Of Devices	Length (Feet)	Minimum Number Of Devices	Length (Feet)	Minimum Number Of Devices
40	320	9	110	6	100	6
45	540	13	180	6	100	6
50	600	13	200	6	100	6
55	660	13	220	6	100	6
60	720	13	240	6	100	6
65	780	13	260	6	100	6
70	840	13	280	6	100	6

PATA 504-B






Advance Warning Area



PATA 505-A

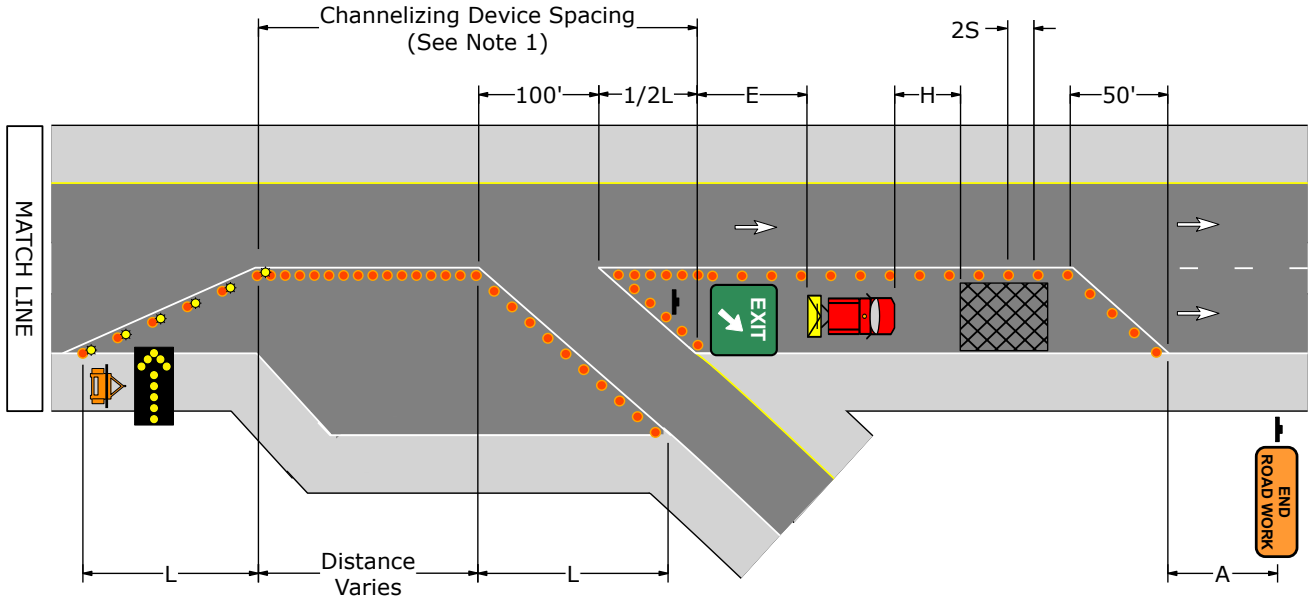
1. Longitudinal channelizing devices located from the beginning of the permanent ramp to the gore area shall be placed with a maximum interval spacing equal to the regulatory speed limit (in feet).
2. In locations with heavy ramp traffic, the channelizing devices in advance of the ramp may be eliminated if special advance signing is erected to indicate that the right lane is a mandatory exit only lane.
3. The temporary EXIT sign shall be located in the temporary gore. It shall be mounted at a minimum height of 7' from the pavement surface to the bottom of the sign. This sign may be either black on orange or white on green.
4. Sequential flashing warning lights are required on channelizing devices used to form the merging taper.

Signs					
					
W20-1	W20-5R	W4-2R	G20-2	W25-4	W25-4

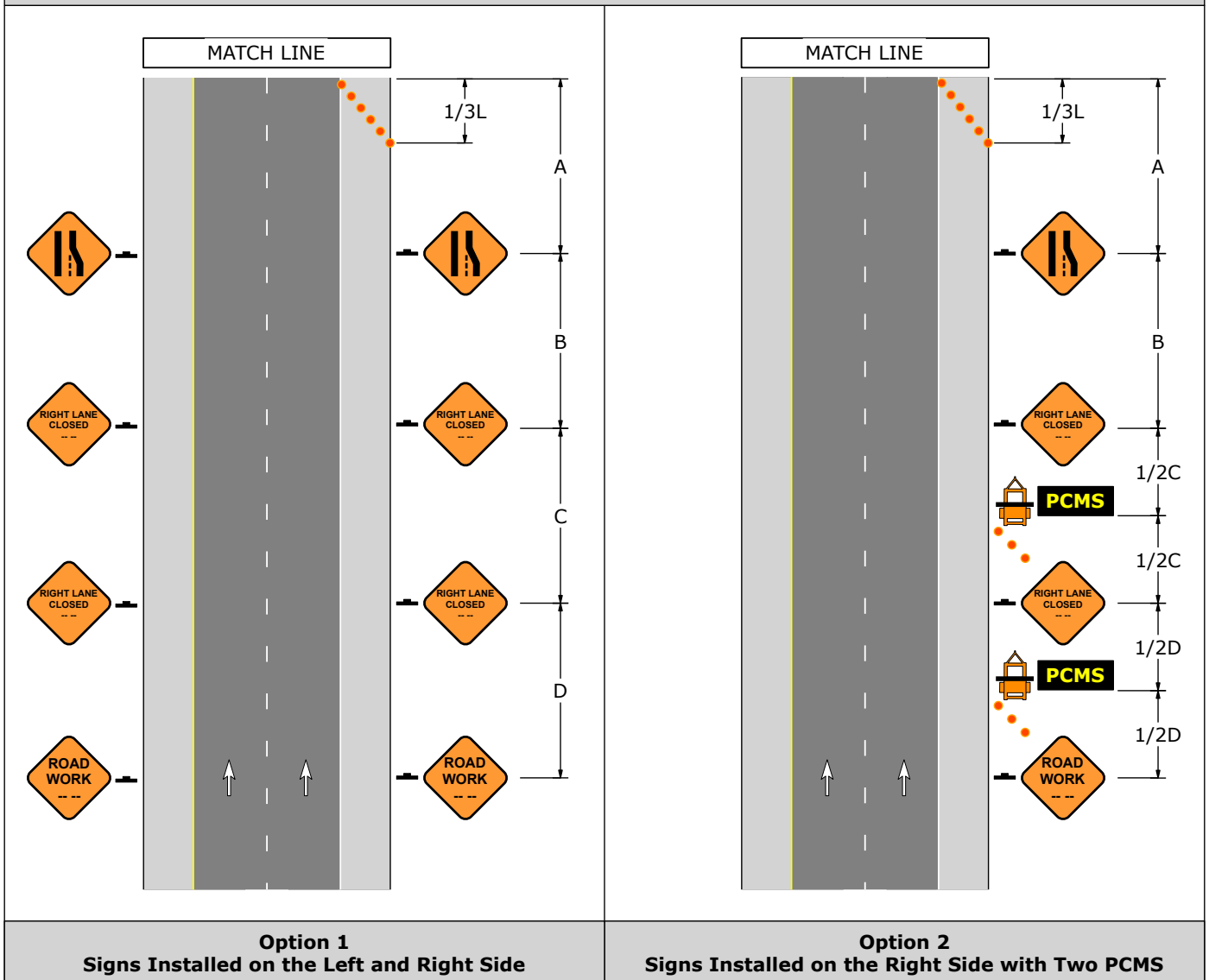
Sign Spacing, Channelizing Device Spacing, Buffer Space, and Roll Ahead Space							
Speed	Channelizing Devices Spacing	Sign Spacing				Buffer Space	Roll Ahead Space
S (MPH)	2S (Feet)	A (Feet)	B (Feet)	C (Feet)	D (Feet)	E (Feet)	H (Feet)
40	80	1000	1640	2640	5280	305	150
45	90	1000	1640	2640	5280	360	150
50	100	1000	1640	2640	5280	425	250
55	110	1000	1640	2640	5280	495	250
60	120	1000	1640	2640	5280	570	250
65	130	1000	1640	2640	5280	645	250
70	140	1000	1640	2640	5280	730	250

Taper Lengths and Minimum Number Of Channelizing Devices								
Speed	Merging Taper: L		Shifting Taper: 1/2L		Shoulder Taper: 1/3L		50' Per Lane Taper	
S (MPH)	Length (Feet)	Minimum Number Of Devices	Length (Feet)	Minimum Number Of Devices	Length (Feet)	Minimum Number Of Devices	Length (Feet)	Minimum Number Of Devices
40	320	9	160	6	110	6	50	6
45	540	13	270	7	180	6	50	6
50	600	13	300	7	200	6	50	6
55	660	13	330	7	220	6	50	6
60	720	13	360	7	240	6	50	6
65	780	13	390	7	260	6	50	6
70	840	13	420	7	280	6	50	6

PATA 505-A









Advance Warning Area



PATA 505-B

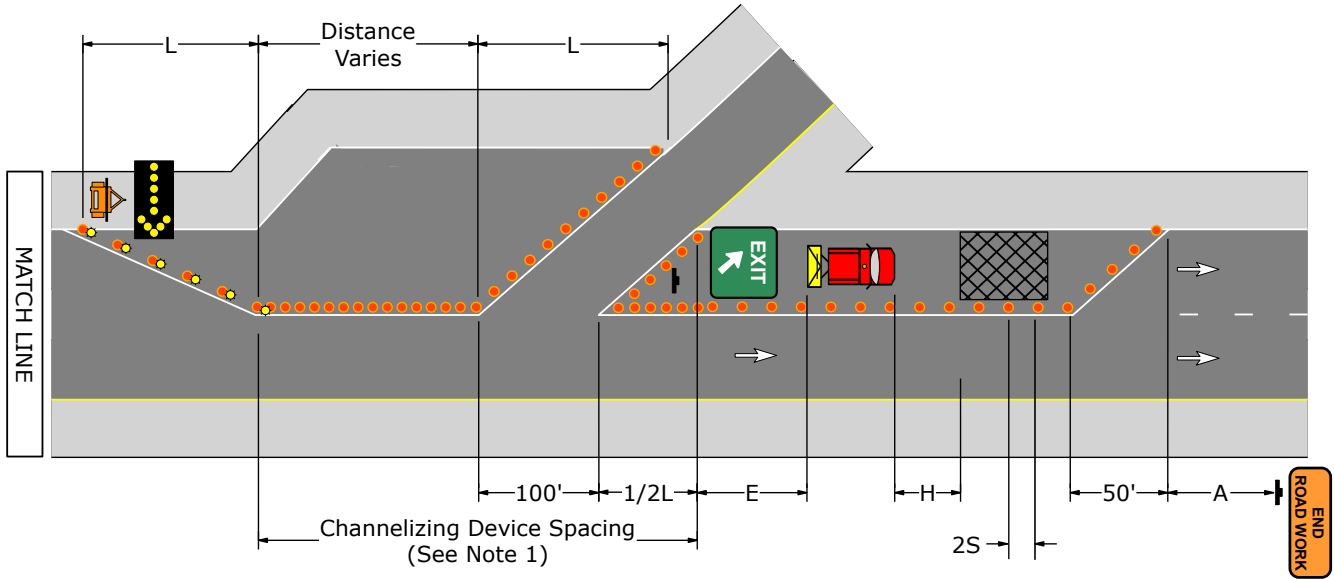
1. Longitudinal channelizing devices located from the beginning of the permanent ramp to the gore area shall be placed with a maximum interval spacing equal to the regulatory speed limit (in feet).
2. In locations with heavy ramp traffic, the channelizing devices in advance of the ramp may be eliminated if special advance signing is erected to indicate that the right lane is a mandatory exit only lane.
3. The temporary EXIT sign shall be located in the temporary gore. It shall be mounted at a minimum height of 7' from the pavement surface to the bottom of the sign. This sign may be either black on orange or white on green.
4. Sequential flashing warning lights are required on channelizing devices used to form the merging taper.

Signs					
					
W20-1	W20-5L	W4-2L	G20-2	W25-4	W25-4

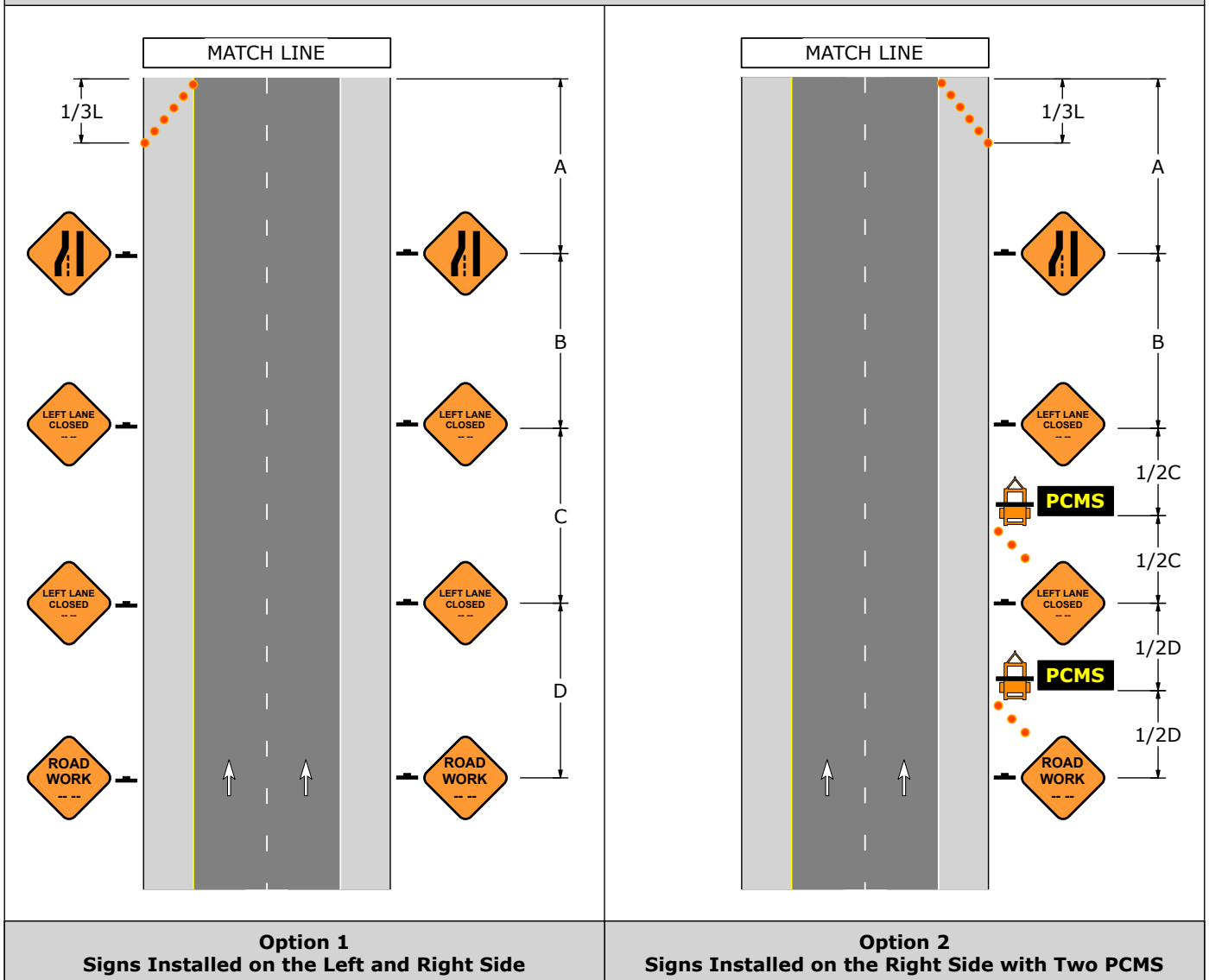
Sign Spacing, Channelizing Device Spacing, Buffer Space, and Roll Ahead Space							
Speed	Channelizing Devices Spacing	Sign Spacing				Buffer Space	Roll Ahead Space
S (MPH)	2S (Feet)	A (Feet)	B (Feet)	C (Feet)	D (Feet)	E (Feet)	H (Feet)
40	80	1000	1640	2640	5280	305	150
45	90	1000	1640	2640	5280	360	150
50	100	1000	1640	2640	5280	425	250
55	110	1000	1640	2640	5280	495	250
60	120	1000	1640	2640	5280	570	250
65	130	1000	1640	2640	5280	645	250
70	140	1000	1640	2640	5280	730	250

Taper Lengths and Minimum Number Of Channelizing Devices								
Speed	Merging Taper: L		Shifting Taper: 1/2L		Shoulder Taper: 1/3L		50' Per Lane Taper	
S (MPH)	Length (Feet)	Minimum Number Of Devices	Length (Feet)	Minimum Number Of Devices	Length (Feet)	Minimum Number Of Devices	Length (Feet)	Minimum Number Of Devices
40	320	9	160	6	110	6	50	6
45	540	13	270	7	180	6	50	6
50	600	13	300	7	200	6	50	6
55	660	13	330	7	220	6	50	6
60	720	13	360	7	240	6	50	6
65	780	13	390	7	260	6	50	6
70	840	13	420	7	280	6	50	6

PATA 505-B












Advance Warning Area



PATA 506-A

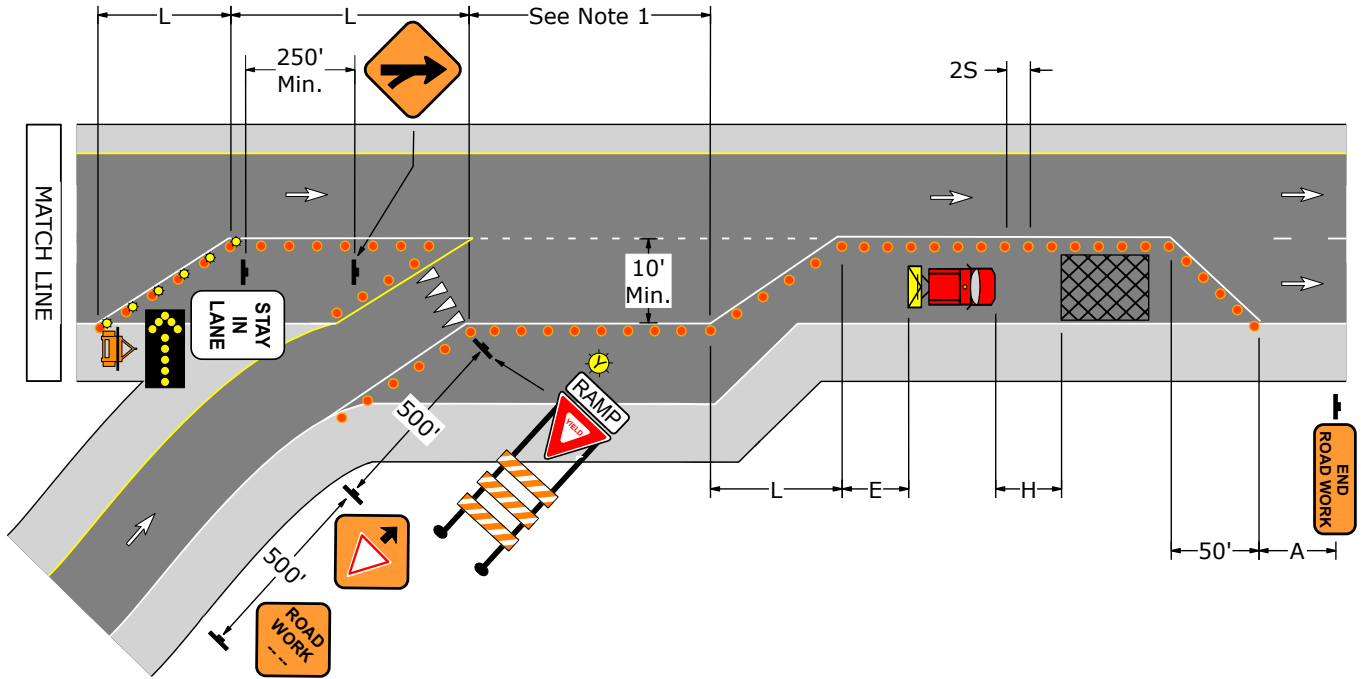
1. The acceleration lane should be maintained at the longest length that will accommodate adjacent tapers .
2. Sequential flashing warning lights are required on channelizing devices used to form the merging taper.

Signs								
								
W20-1	W20-5R	W4-2R	W4-1R	W3-2	G20-2	R1-2	R1-1-2	R4-9

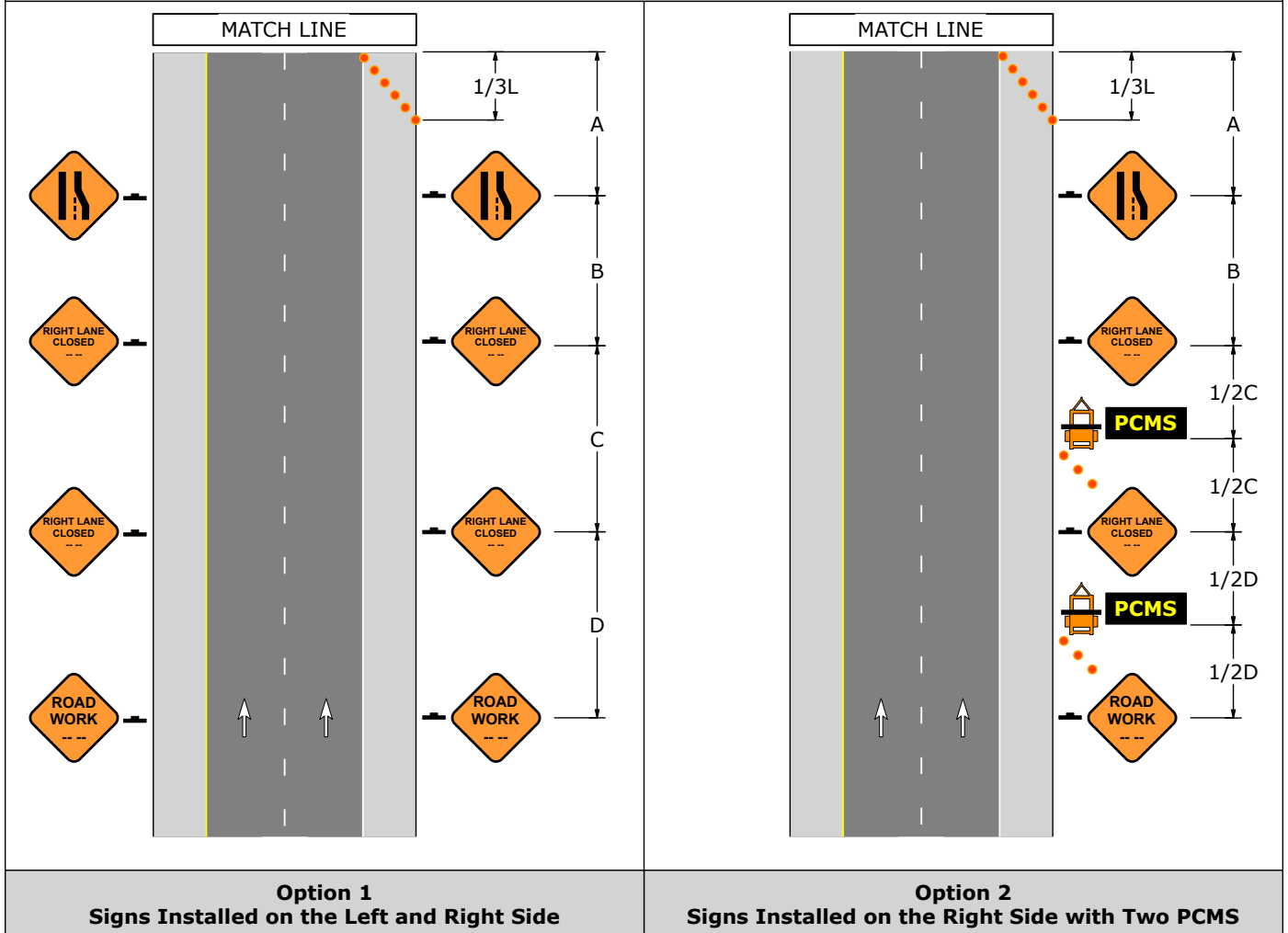
Sign Spacing, Channelizing Device Spacing, Buffer Space, and Roll Ahead Space							
Speed	Channelizing Devices Spacing	Sign Spacing				Buffer Space	Roll Ahead Space
S (MPH)	2S (Feet)	A (Feet)	B (Feet)	C (Feet)	D (Feet)	E (Feet)	H (Feet)
40	80	1000	1640	2640	5280	305	150
45	90	1000	1640	2640	5280	360	150
50	100	1000	1640	2640	5280	425	250
55	110	1000	1640	2640	5280	495	250
60	120	1000	1640	2640	5280	570	250
65	130	1000	1640	2640	5280	645	250
70	140	1000	1640	2640	5280	730	250

Taper Lengths and Minimum Number Of Channelizing Devices						
Speed	Merging Taper: L		Shoulder Taper: 1/3L		50' Per Lane Taper	
S (MPH)	Length (Feet)	Minimum Number Of Devices	Length (Feet)	Minimum Number Of Devices	Length (Feet)	Minimum Number Of Devices
40	320	9	110	6	50	6
45	540	13	180	6	50	6
50	600	13	200	6	50	6
55	660	13	220	6	50	6
60	720	13	240	6	50	6
65	780	13	260	6	50	6
70	840	13	280	6	50	6

PATA 506-A












Advance Warning Area



PATA 506-B

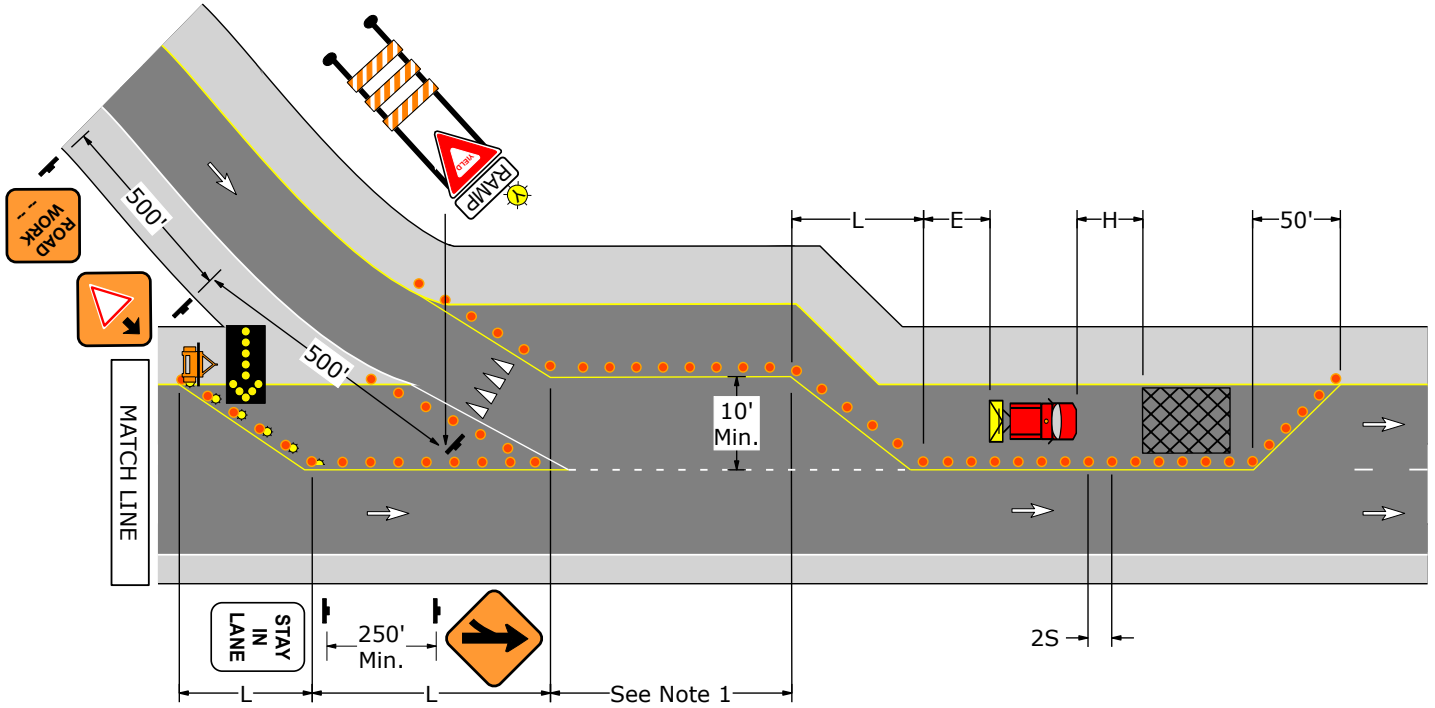
1. The acceleration lane should be maintained at the longest length that will accommodate adjacent tapers .
2. Sequential flashing warning lights are required on channelizing devices used to form the merging taper.

Signs								
								
W20-1	W20-5L	W4-2L	W4-1L	W3-2	G20-2	R1-2	R1-1-2	R4-9

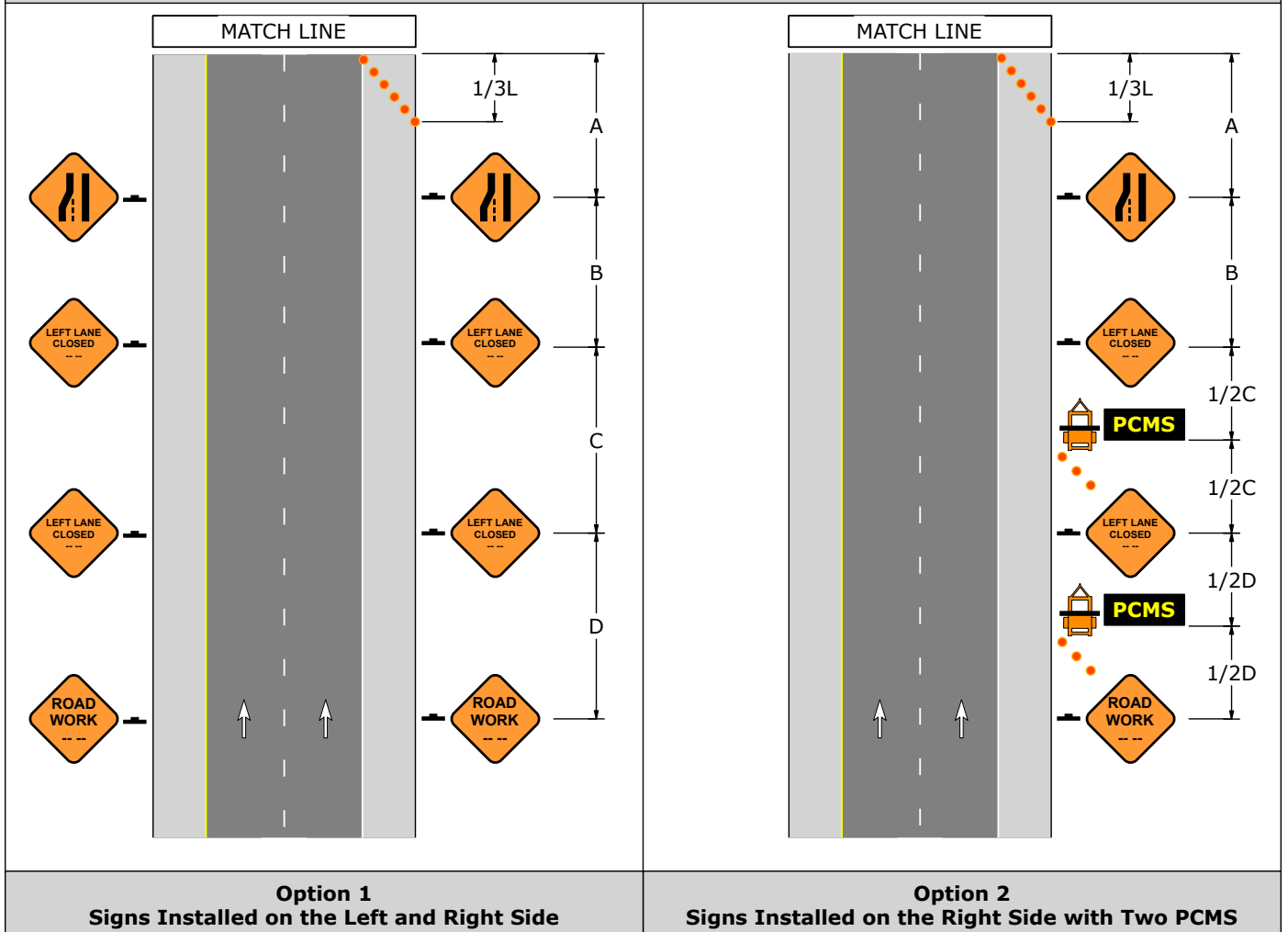
Sign Spacing, Channelizing Device Spacing, Buffer Space, and Roll Ahead Space							
Speed	Channelizing Devices Spacing	Sign Spacing				Buffer Space	Roll Ahead Space
S (MPH)	2S (Feet)	A (Feet)	B (Feet)	C (Feet)	D (Feet)	E (Feet)	H (Feet)
40	80	1000	1640	2640	5280	305	150
45	90	1000	1640	2640	5280	360	150
50	100	1000	1640	2640	5280	425	250
55	110	1000	1640	2640	5280	495	250
60	120	1000	1640	2640	5280	570	250
65	130	1000	1640	2640	5280	645	250
70	140	1000	1640	2640	5280	730	250

Taper Lengths and Minimum Number Of Channelizing Devices						
Speed	Merging Taper: L		Shoulder Taper: 1/3L		50' Per Lane Taper	
S (MPH)	Length (Feet)	Minimum Number Of Devices	Length (Feet)	Minimum Number Of Devices	Length (Feet)	Minimum Number Of Devices
40	320	9	110	6	50	6
45	540	13	180	6	50	6
50	600	13	200	6	50	6
55	660	13	220	6	50	6
60	720	13	240	6	50	6
65	780	13	260	6	50	6
70	840	13	280	6	50	6

PATA 506-B












Advance Warning Area



PATA 507-A

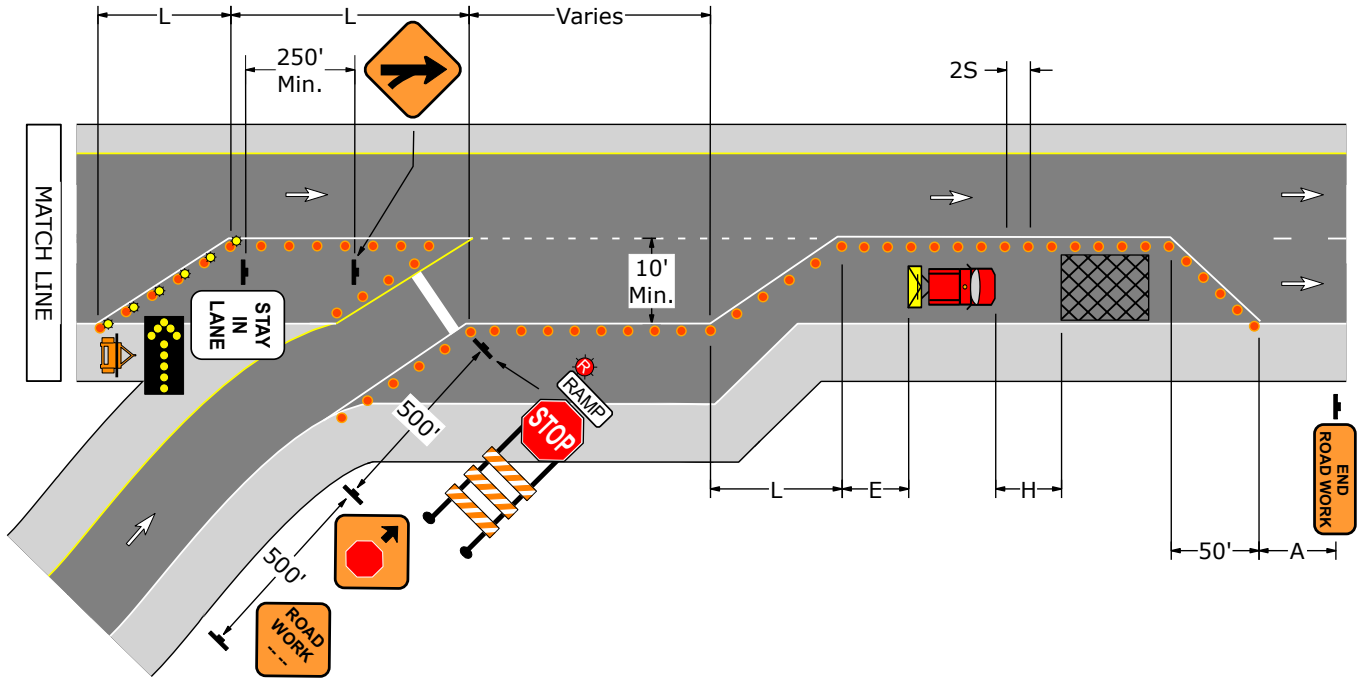
1. The stop line shall be a 24" white pavement marking that completely traverses the traffic lane. Place the stop line to ensure maximum sight distance to approaching vehicles, but no closer than 4' from the through road edge line.
2. Sequential flashing warning lights are required on channelizing devices used to form the merging taper.

Signs								
								
W20-1	W20-5R	W4-2R	W4-1R	W3-1	G20-2	R1-1	R1-1-2	R4-9

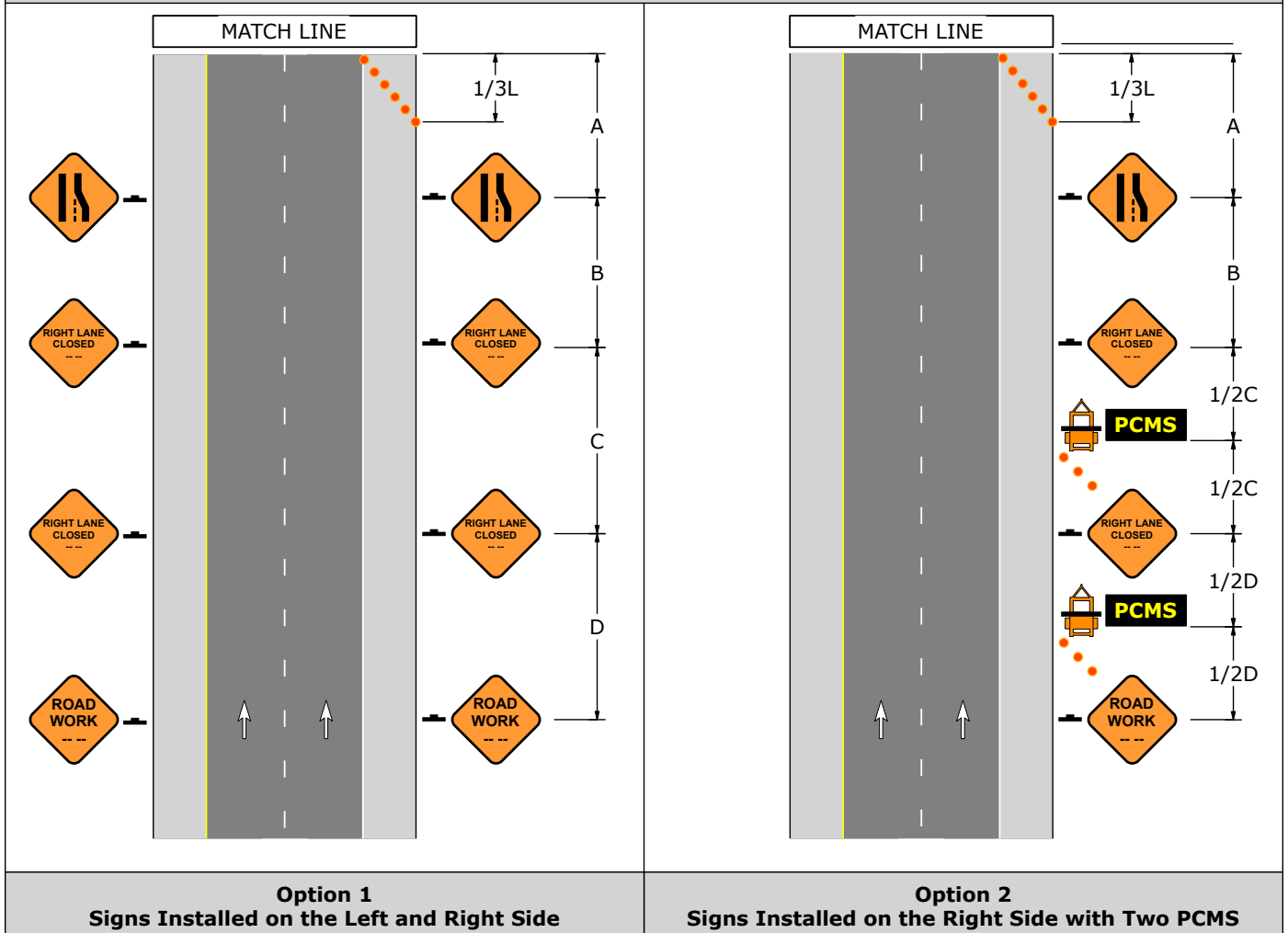
Sign Spacing, Channelizing Device Spacing, Buffer Space, and Roll Ahead Space							
Speed	Channelizing Devices Spacing	Sign Spacing				Buffer Space	Roll Ahead Space
S (MPH)	2S (Feet)	A (Feet)	B (Feet)	C (Feet)	D (Feet)	E (Feet)	H (Feet)
40	80	1000	1640	2640	5280	305	150
45	90	1000	1640	2640	5280	360	150
50	100	1000	1640	2640	5280	425	250
55	110	1000	1640	2640	5280	495	250
60	120	1000	1640	2640	5280	570	250
65	130	1000	1640	2640	5280	645	250
70	140	1000	1640	2640	5280	730	250

Taper Lengths and Minimum Number Of Channelizing Devices						
Speed	Merging Taper: L		Shoulder Taper: 1/3L		50' Per Lane Taper	
S (MPH)	Length (Feet)	Minimum Number Of Devices	Length (Feet)	Minimum Number Of Devices	Length (Feet)	Minimum Number Of Devices
40	320	9	110	6	50	6
45	540	13	180	6	50	6
50	600	13	200	6	50	6
55	660	13	220	6	50	6
60	720	13	240	6	50	6
65	780	13	260	6	50	6
70	840	13	280	6	50	6

PATA 507-A












Advance Warning Area



PATA 507-B

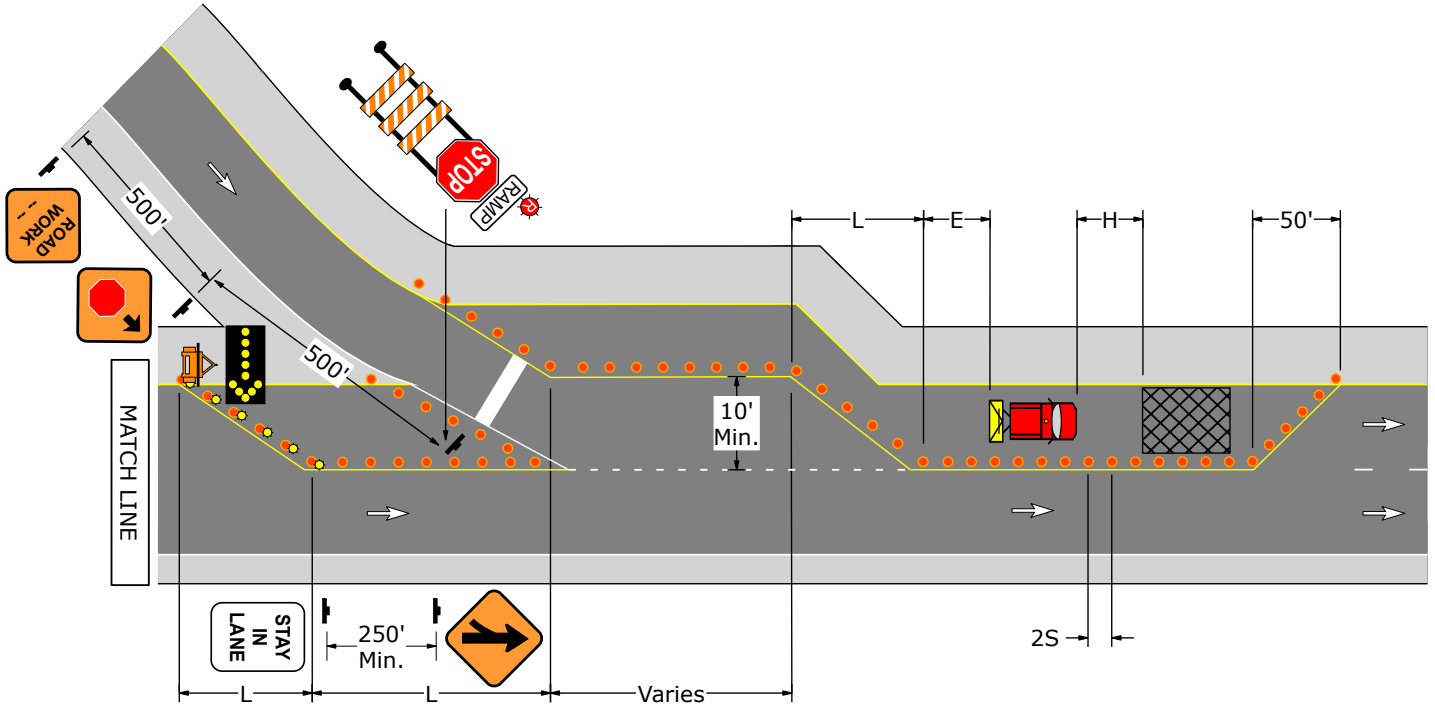
1. The stop line shall be a 24" white pavement marking that completely traverses the traffic lane. Place the stop line to ensure maximum sight distance to approaching vehicles, but no closer than 4' from the through road edge line.
2. Sequential flashing warning lights are required on channelizing devices used to form the merging taper.

Signs								
								
W20-1	W20-5L	W4-2L	W4-1L	W3-1	G20-2	R1-1	R1-1-2	R4-9

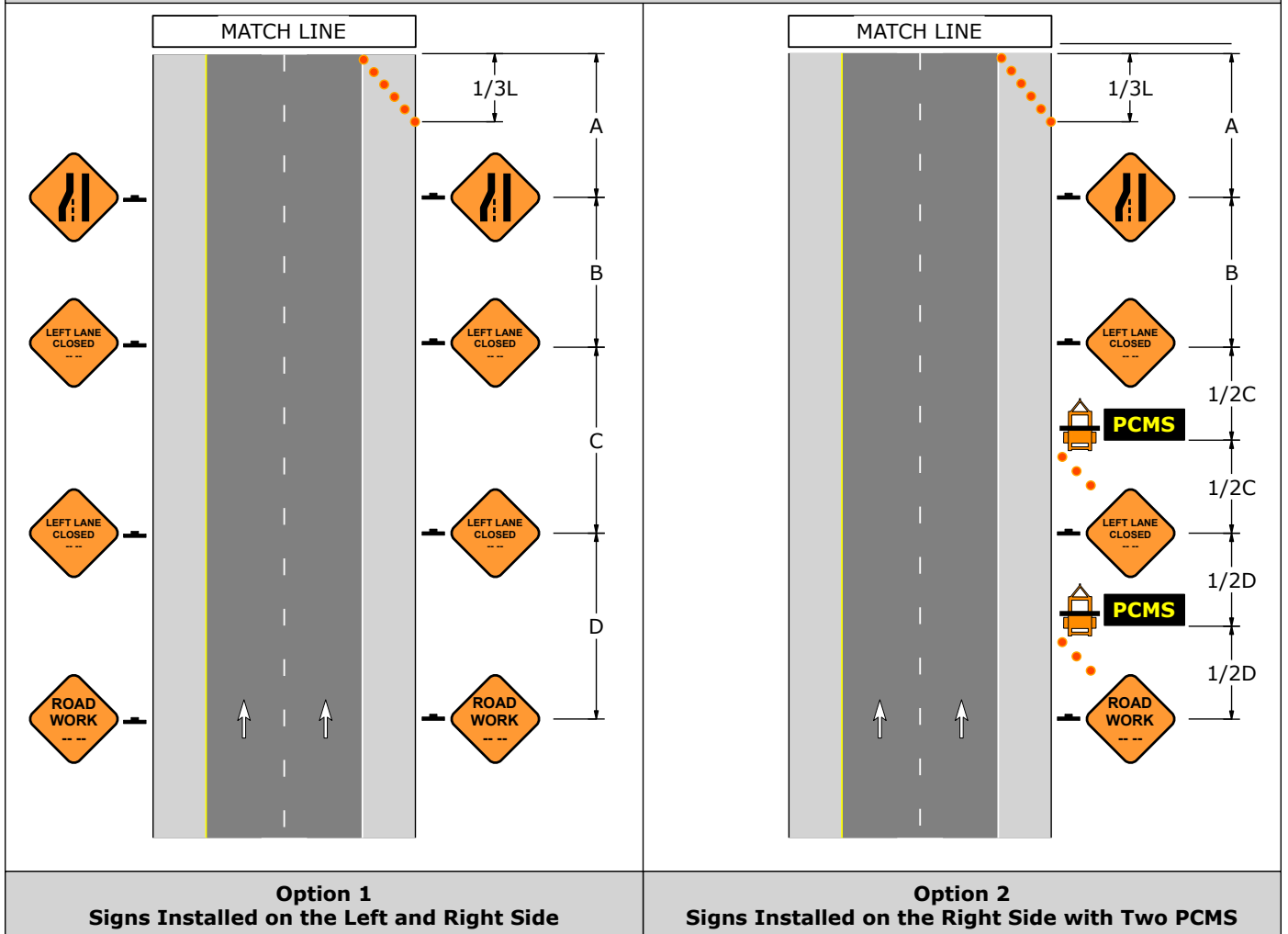
Sign Spacing, Channelizing Device Spacing, Buffer Space, and Roll Ahead Space							
Speed	Channelizing Devices Spacing	Sign Spacing				Buffer Space	Roll Ahead Space
S (MPH)	2S (Feet)	A (Feet)	B (Feet)	C (Feet)	D (Feet)	E (Feet)	H (Feet)
40	80	1000	1640	2640	5280	305	150
45	90	1000	1640	2640	5280	360	150
50	100	1000	1640	2640	5280	425	250
55	110	1000	1640	2640	5280	495	250
60	120	1000	1640	2640	5280	570	250
65	130	1000	1640	2640	5280	645	250
70	140	1000	1640	2640	5280	730	250

Taper Lengths and Minimum Number of Channelizing Devices						
Speed	Merging Taper: L		Shoulder Taper: 1/3L		50' Per Lane Taper	
S (MPH)	Length (Feet)	Minimum Number Of Devices	Length (Feet)	Minimum Number Of Devices	Length (Feet)	Minimum Number Of Devices
40	320	9	110	6	50	6
45	540	13	180	6	50	6
50	600	13	200	6	50	6
55	660	13	220	6	50	6
60	720	13	240	6	50	6
65	780	13	260	6	50	6
70	840	13	280	6	50	6

PATA 507-B








Advance Warning Area



PATA 508-A

1. Calculate taper lengths by using the regulatory speed limit (S) and appropriate offset width (W) in formulas shown below.
2. The minimum width of the shoulder lane shall be 10'. Shoulder must be in good condition and free from road debris.
3. Edge line and lane line pavement markings shall be parallel, except for the downstream edge line taper.

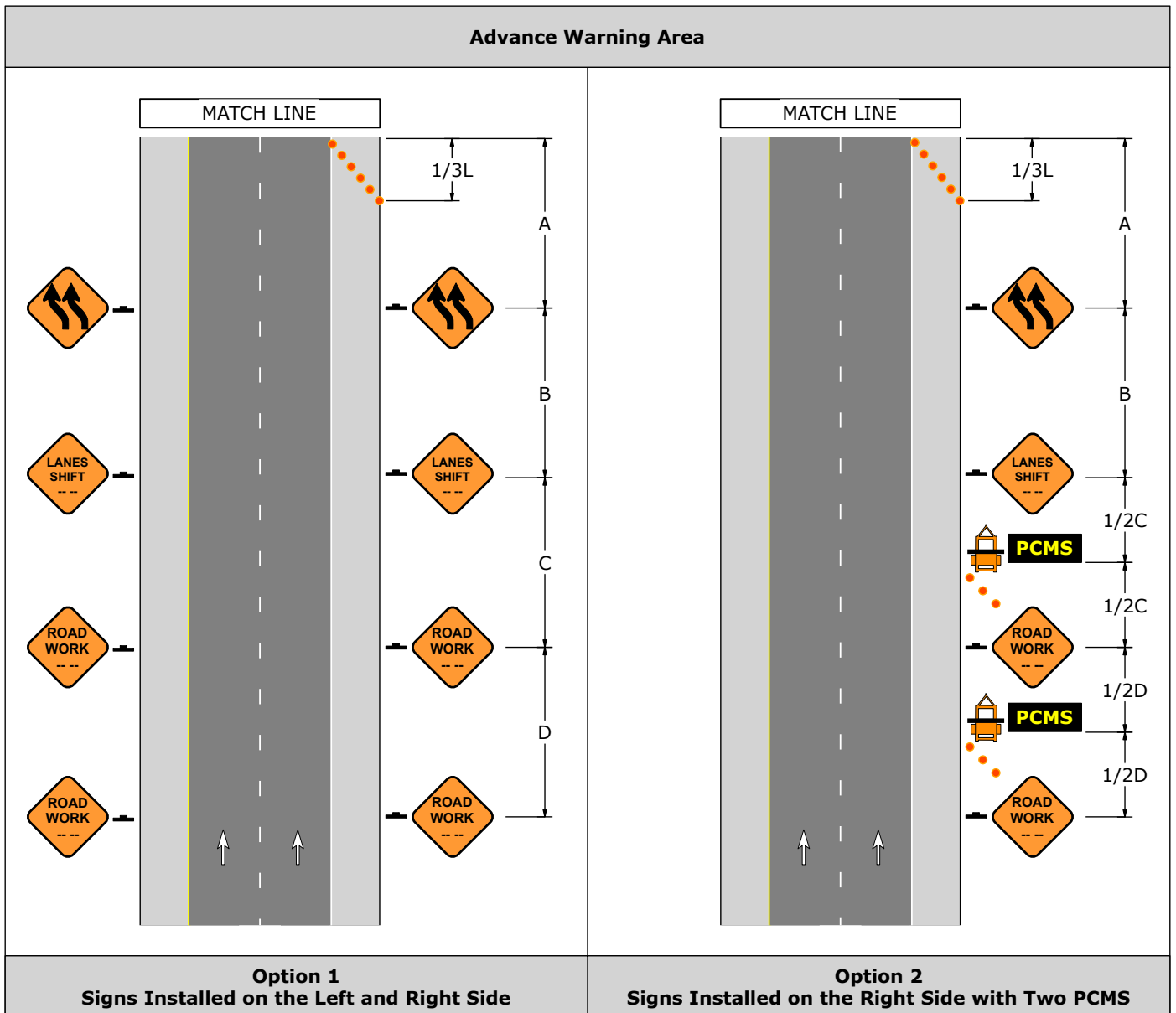
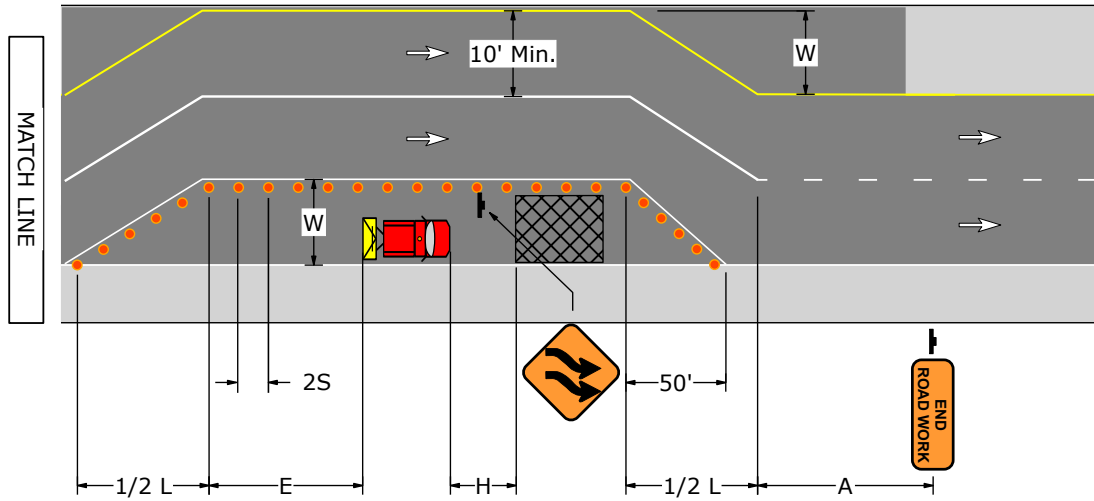
Signs				
				
W20-1	W5-5	W1-4BL	W1-4BR	G20-2

Sign Spacing, Channelizing Device Spacing, Buffer Space, and Roll Ahead Space							
Speed	Channelizing Devices Spacing	Sign Spacing				Buffer Space	Roll Ahead Space
S (MPH)	2S (Feet)	A (Feet)	B (Feet)	C (Feet)	D (Feet)	E (Feet)	H (Feet)
40	80	1000	1640	2640	5280	305	150
45	90	1000	1640	2640	5280	360	150
50	100	1000	1640	2640	5280	425	250
55	110	1000	1640	2640	5280	495	250
60	120	1000	1640	2640	5280	570	250
65	130	1000	1640	2640	5280	645	250
70	140	1000	1640	2640	5280	730	250

Taper Lengths and Minimum Number Of Channelizing Devices						
Speed	Shifting Taper: 1/2L		Shoulder Taper: 1/3L		50' Per Lane Taper	
S (MPH)	Length (Feet)	Minimum Number Of Devices	Length (Feet)	Minimum Number Of Devices	Length (Feet)	Minimum Number Of Devices
40	*	6	110	6	50	6
45	*	7	180	6	50	6
50	*	7	200	6	50	6
55	*	7	220	6	50	6
60	*	7	240	6	50	6
65	*	7	260	6	50	6
70	*	7	280	6	50	6






* Taper Length Formulas	
If the speed limit is 40 MPH or less $L = \frac{WS^2}{60}$	If the speed limit is 45 MPH or more $L = WS$
S = Regulatory Speed Limit (MPH) W = Width of Offset (feet) L = Length of Taper (feet)	

PATA 508-A



PATA 508-B

1. Calculate taper lengths by using the regulatory speed limit (S) and appropriate offset width (W) in formulas shown below.
2. The minimum width of the shoulder lane shall be 10'. Shoulder must be in good condition and free from road debris.
3. Edge line and lane line pavement markings shall be parallel, except for the downstream edge line taper.

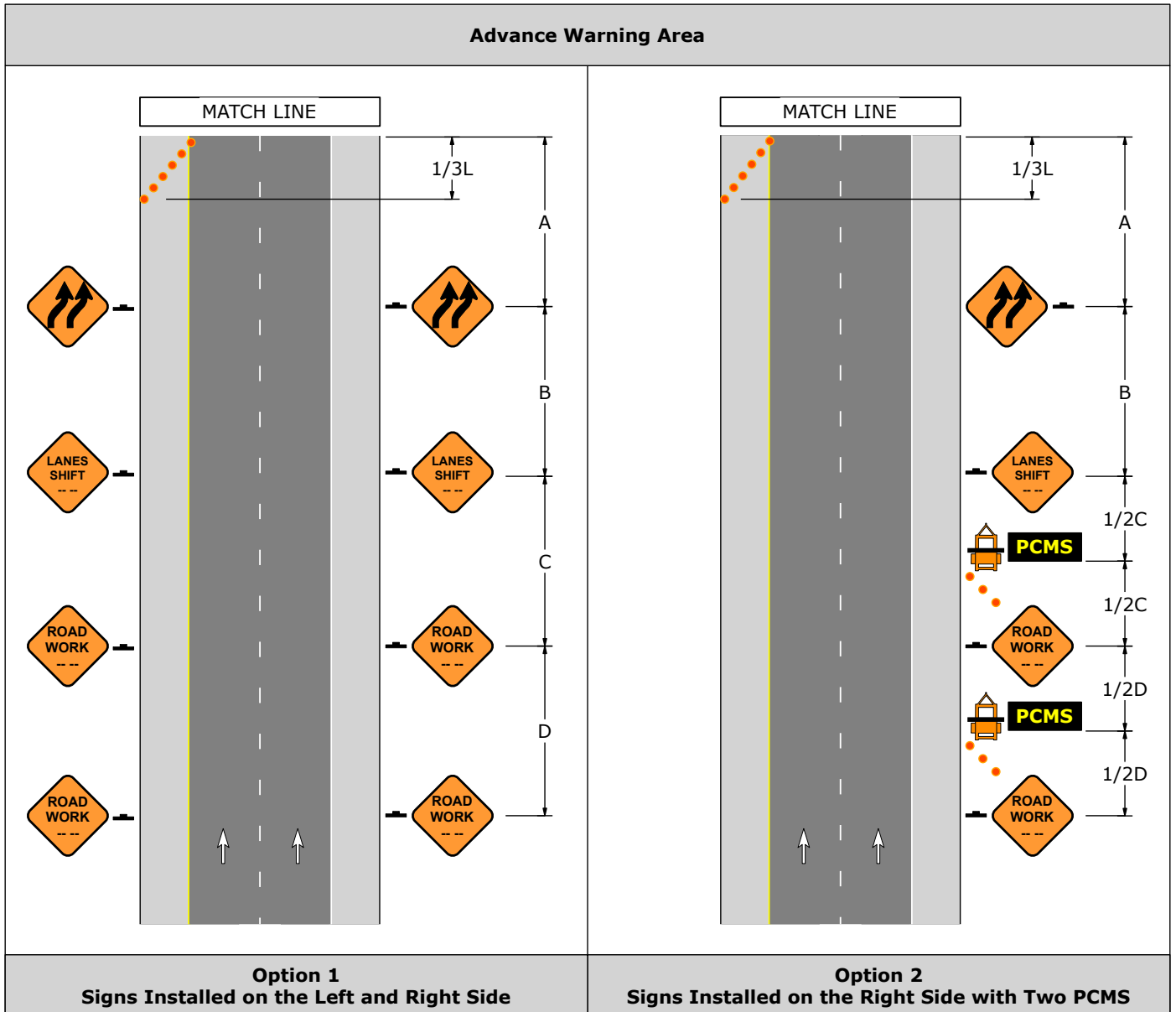
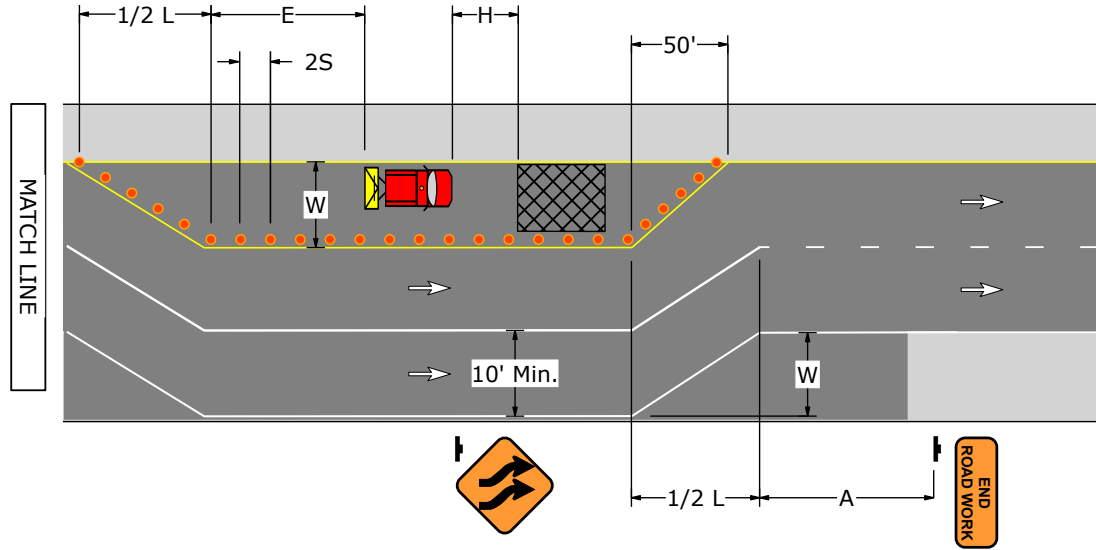
Signs				
				
W20-1	W5-5	W1-4BL	W1-4BR	G20-2

Sign Spacing, Channelizing Device Spacing, Buffer Space, and Roll Ahead Space							
Speed	Channelizing Devices Spacing	Sign Spacing				Buffer Space	Roll Ahead Space
S (MPH)	2S (Feet)	A (Feet)	B (Feet)	C (Feet)	D (Feet)	E (Feet)	H (Feet)
40	80	1000	1640	2640	5280	305	150
45	90	1000	1640	2640	5280	360	150
50	100	1000	1640	2640	5280	425	250
55	110	1000	1640	2640	5280	495	250
60	120	1000	1640	2640	5280	570	250
65	130	1000	1640	2640	5280	645	250
70	140	1000	1640	2640	5280	730	250

Taper Lengths and Minimum Number Of Channelizing Devices						
Speed	Shifting Taper: 1/2L		Shoulder Taper: 1/3L		50' Per Lane Taper	
S (MPH)	Length (Feet)	Minimum Number Of Devices	Length (Feet)	Minimum Number Of Devices	Length (Feet)	Minimum Number Of Devices
40	*	6	110	6	50	6
45	*	7	180	6	50	6
50	*	7	200	6	50	6
55	*	7	220	6	50	6
60	*	7	240	6	50	6
65	*	7	260	6	50	6
70	*	7	280	6	50	6

* Taper Length Formulas	
If the speed limit is 40 MPH or less $L = \frac{WS^2}{60}$	If the speed limit is 45 MPH or more $L = WS$
S = Regulatory Speed Limit (MPH) W = Width of Offset (feet) L = Length of Taper (feet)	

PATA 508-B



Blank Page

Freeways & Expressways

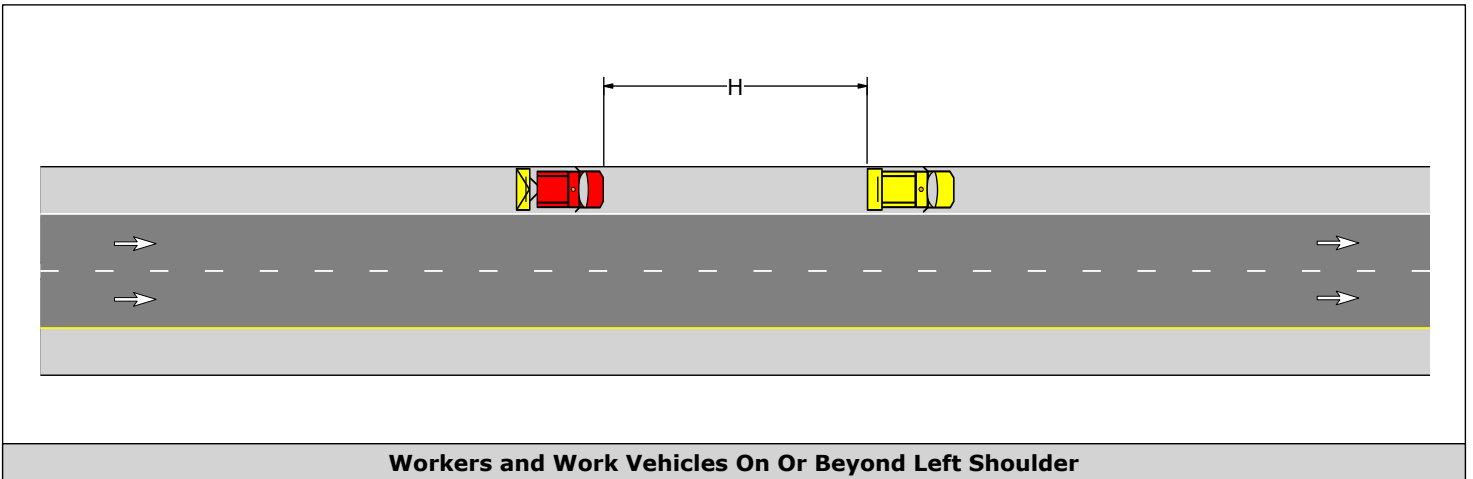
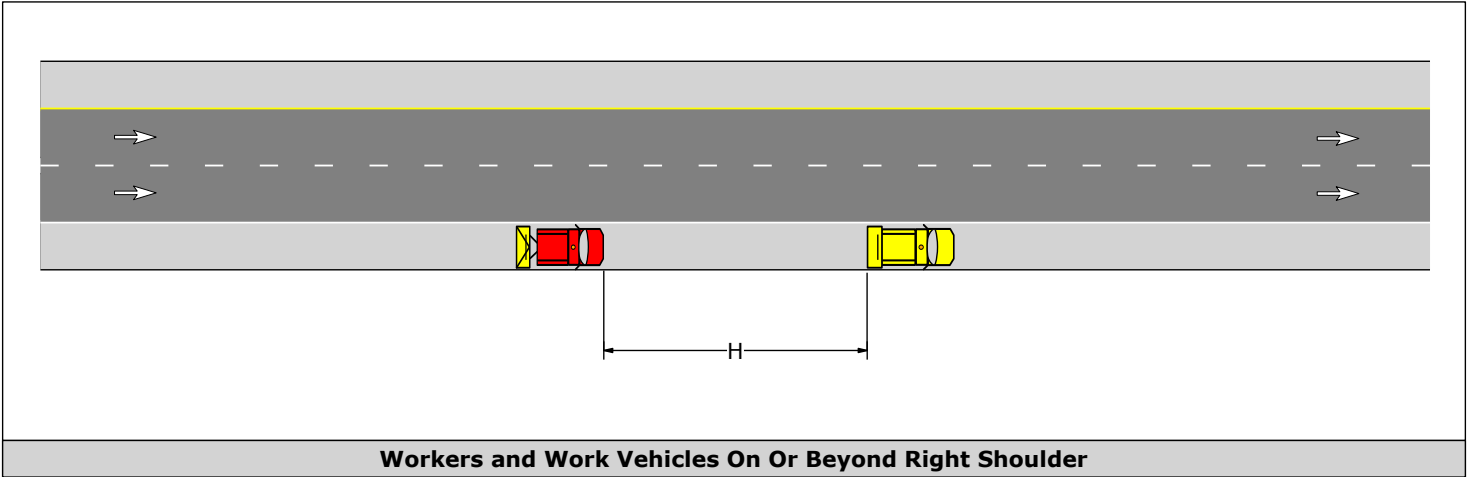
Mobile Operations
(PATA 600 Series)

PATA 601

1. The shadow vehicle and traffic control devices are not required if the work space is outside the highway right-of-way, behind barrier, more than 2' behind curb, or 15' or more from the edge of any roadway.

Roll Ahead Space	
Speed	Roll Ahead Space
S (MPH)	H (Feet)
40	150
45	150
50	250
55	250
60	250
65	250
70	250

PATA 601

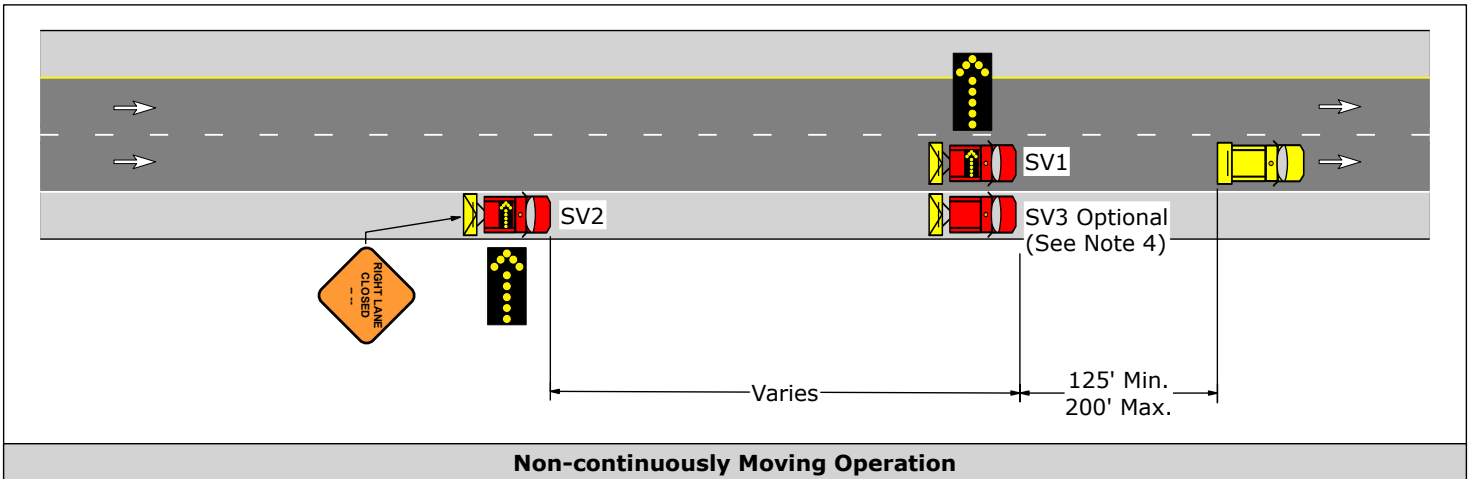
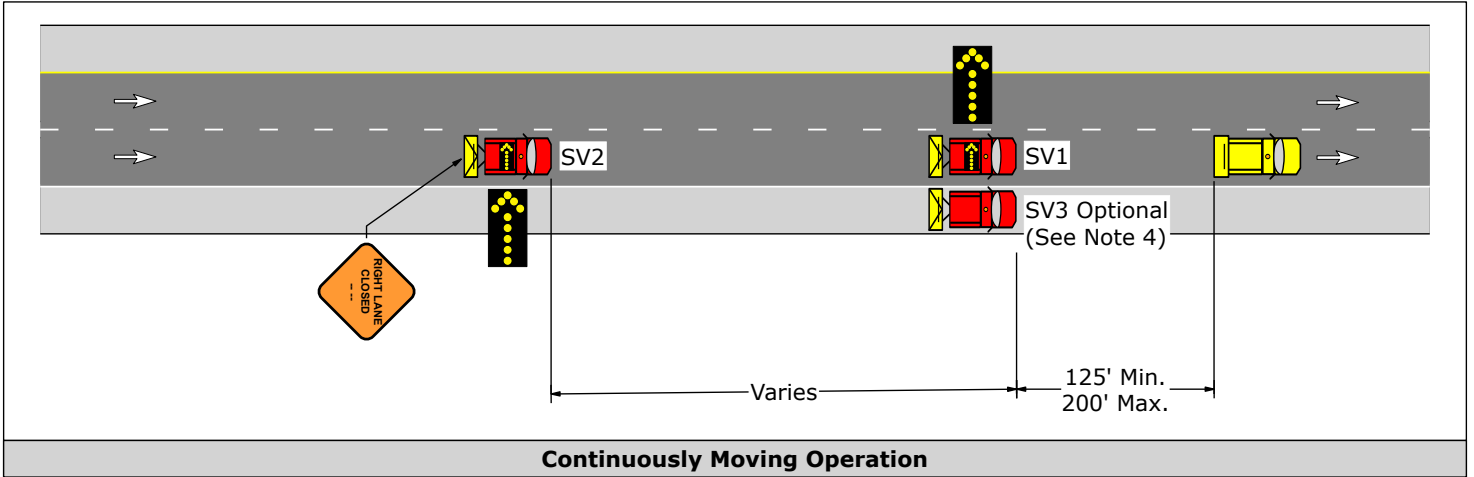


PATA 602-A

1. The traffic queue behind the operation should be constantly monitored. Remove all workers, work vehicles, and shadow vehicles from the roadway if it is determined that the operation is creating stopped traffic at the end of the queue. The operation may resume after queued traffic has cleared.
2. Spacing between shadow vehicles may vary to deter traffic from driving in between. Whenever adequate stopping sight distance exists to the rear, shadow vehicles should maintain a reasonable distance and proceed at the same speed as the work operation vehicle, but should slow down in advance of vertical or horizontal curves that restrict sight distance.
3. SV2 should be positioned as shown, however straddling the edge line is permitted.
4. SV3 is optional. It may be driven beside SV1 to provide additional protection to workers on foot. Where narrow shoulders are encountered, SV3 should fall behind SV1 and return to original position when possible.



PATA 602-A

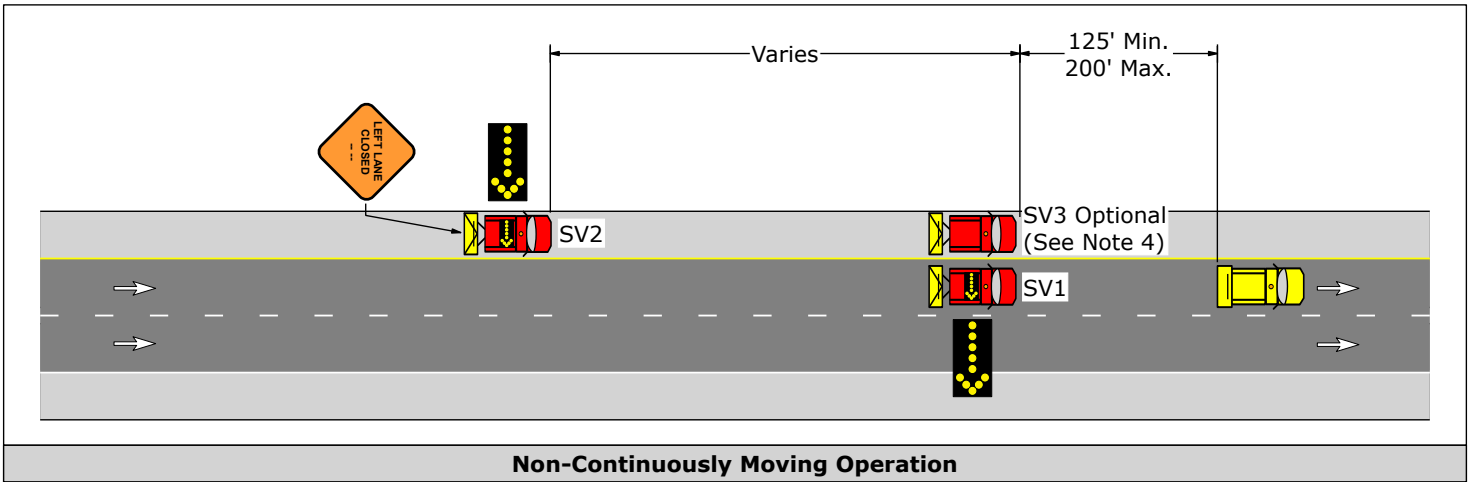
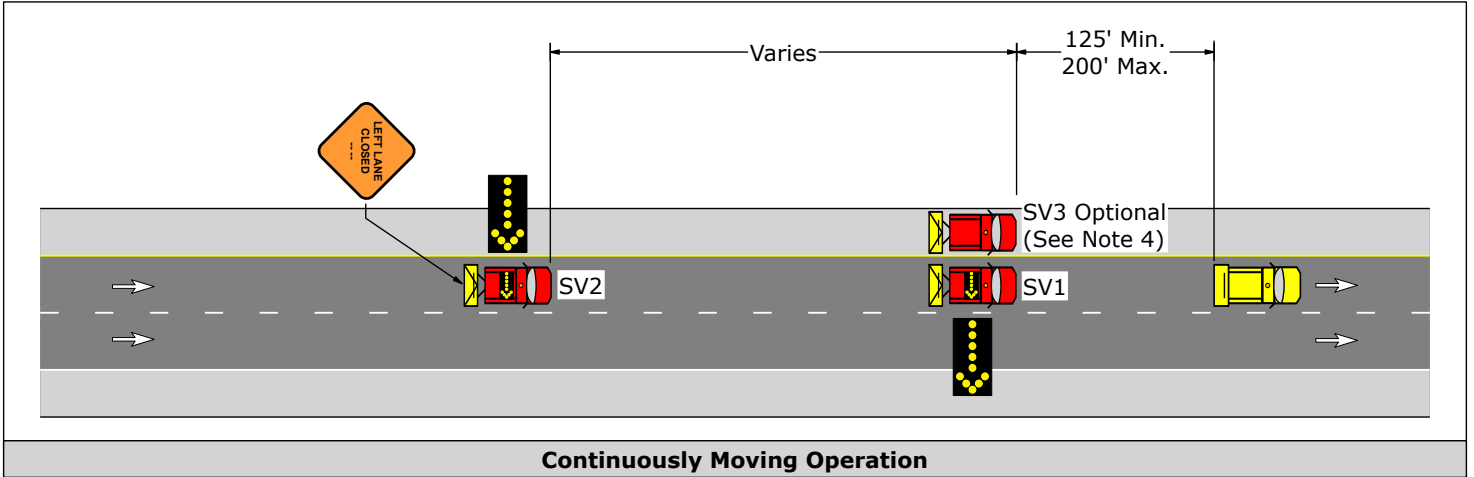


PATA 602-B

1. The traffic queue behind the operation should be constantly monitored. Remove all workers, work vehicles, and shadow vehicles from the roadway if it is determined that the operation is creating stopped traffic at the end of the queue. The operation may resume after queued traffic has cleared.
2. Spacing between shadow vehicles may vary to deter traffic from driving in between. Whenever adequate stopping sight distance exists to the rear, shadow vehicles should maintain a reasonable distance and proceed at the same speed as the work operation vehicle, but should slow down in advance of vertical or horizontal curves that restrict sight distance.
3. SV2 should be positioned as shown, however straddling the edge line is permitted.
4. SV3 is optional. It may be driven beside SV1 to provide additional protection to workers on foot. Where narrow shoulders are encountered, SV3 should fall behind SV1 and return to original position when possible.



PATA 602-B

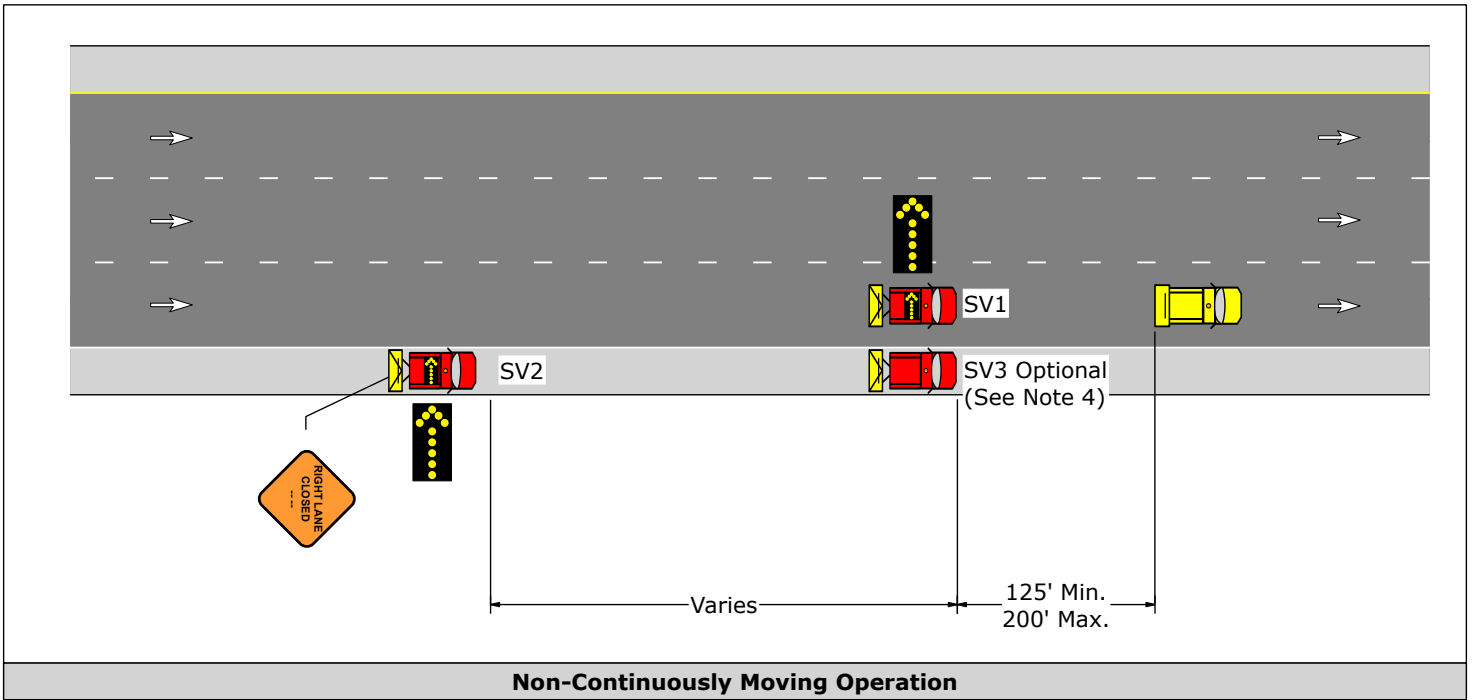
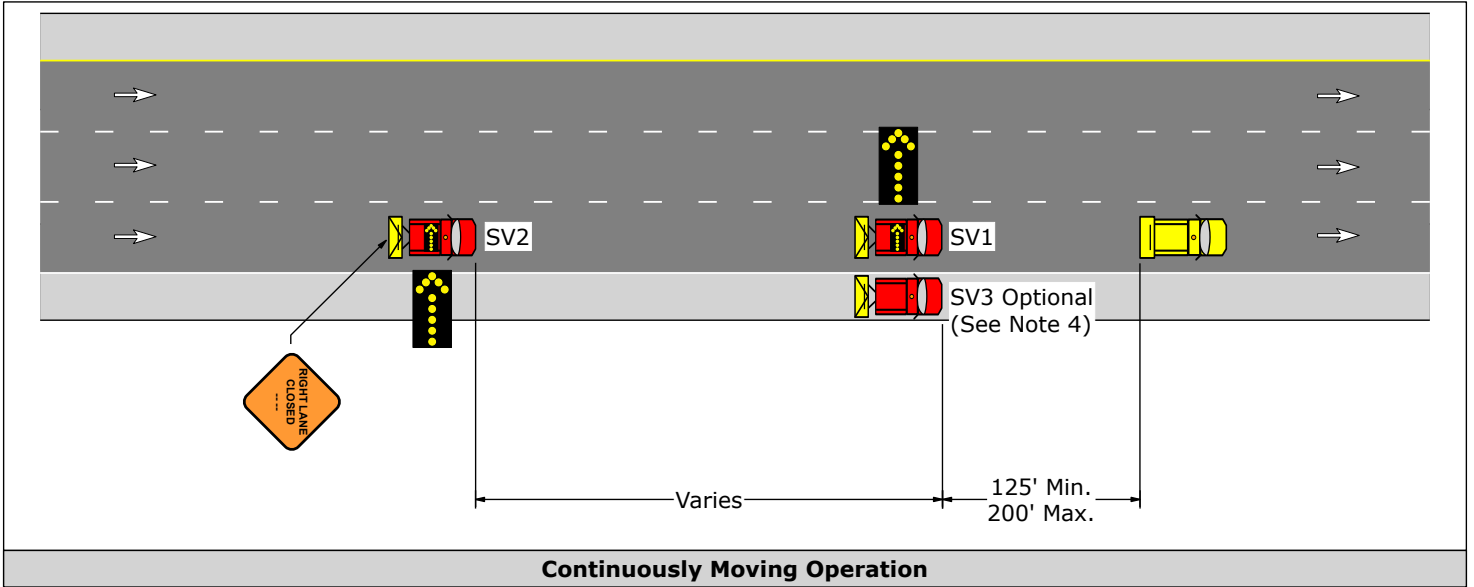


PATA 603-A

1. The traffic queue behind the operation should be constantly monitored. Remove all workers, work vehicles, and shadow vehicles from the roadway if it is determined that the operation is creating stopped traffic at the end of the queue. The operation may resume after queued traffic has cleared.
2. Spacing between shadow vehicles may vary to deter traffic from driving in between. Whenever adequate stopping sight distance exists to the rear, shadow vehicles should maintain a reasonable distance and proceed at the same speed as the work operation vehicle, but should slow down in advance of vertical or horizontal curves that restrict sight distance.
3. SV2 should be positioned as shown, however straddling the edge line is permitted.
4. SV3 is optional. It may be driven beside SV1 to provide additional protection to workers on foot. Where narrow shoulders are encountered, SV3 should fall behind SV1 and return to original position when possible.



PATA 603-A

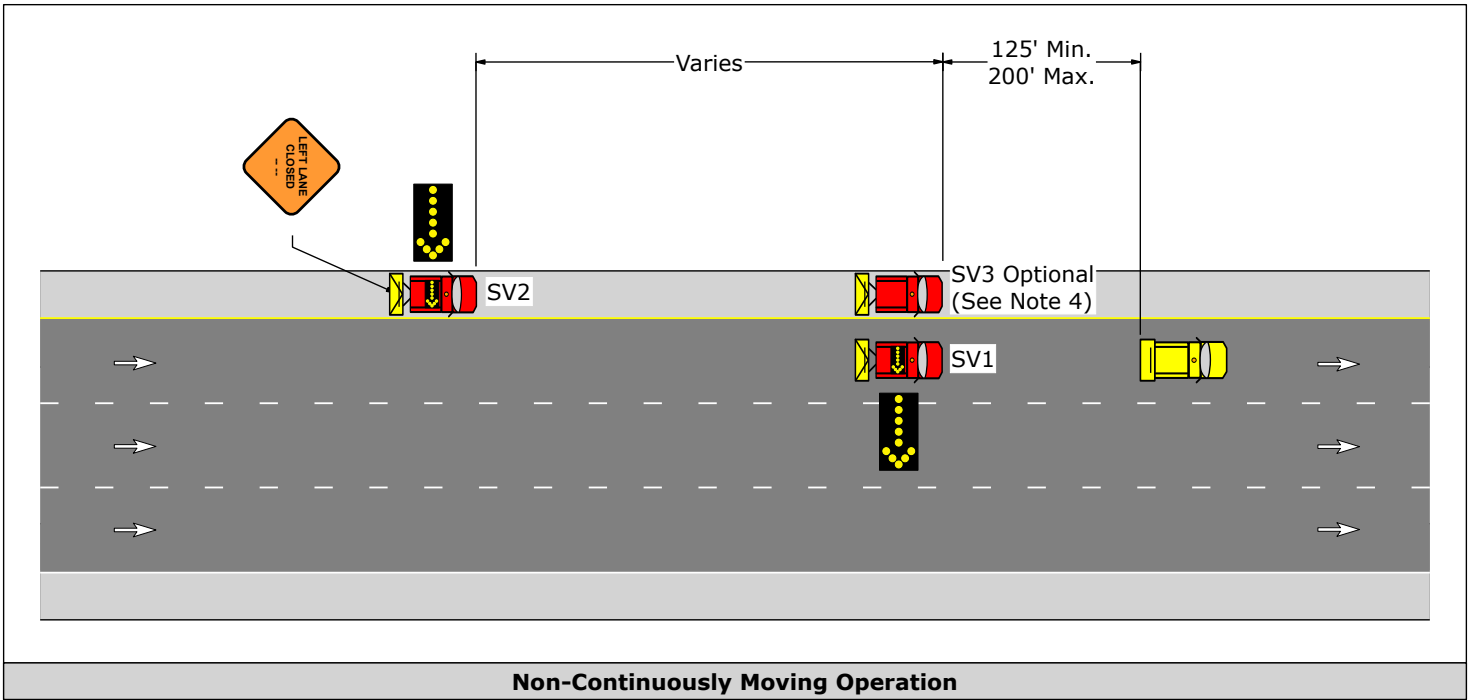
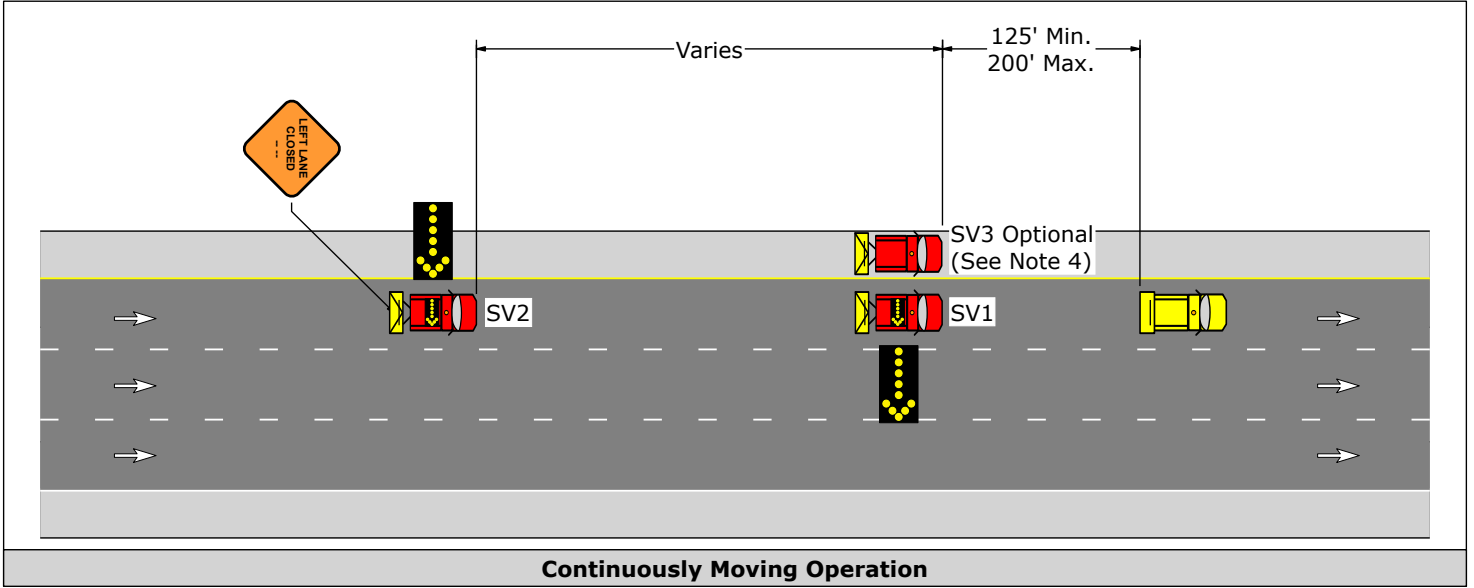


PATA 603-B

1. The traffic queue behind the operation should be constantly monitored. Remove all workers, work vehicles, and shadow vehicles from the roadway if it is determined that the operation is creating stopped traffic at the end of the queue. The operation may resume after queued traffic has cleared.
2. Spacing between shadow vehicles may vary to deter traffic from driving in between. Whenever adequate stopping sight distance exists to the rear, shadow vehicles should maintain a reasonable distance and proceed at the same speed as the work operation vehicle, but should slow down in advance of vertical or horizontal curves that restrict sight distance.
3. SV2 should be positioned as shown, however straddling the edge line is permitted.
4. SV3 is optional. It may be driven beside SV1 to provide additional protection to workers on foot. Where narrow shoulders are encountered, SV3 should fall behind SV1 and return to original position when possible.



PATA 603-B

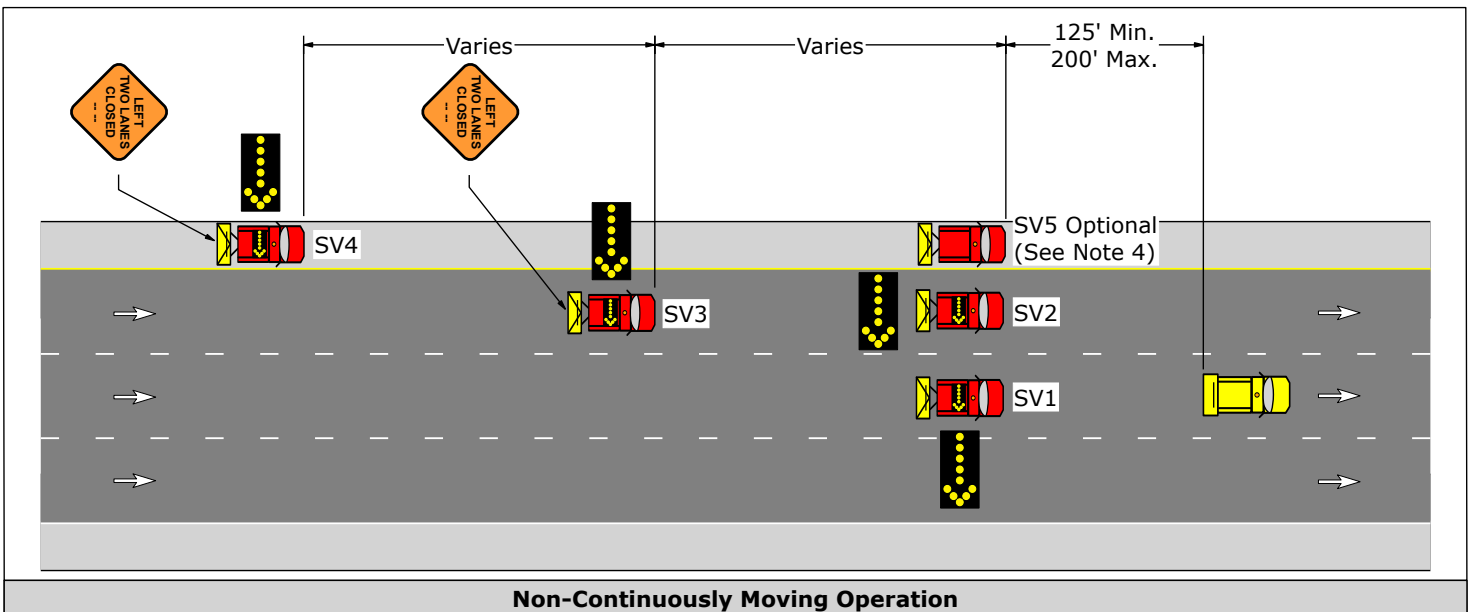
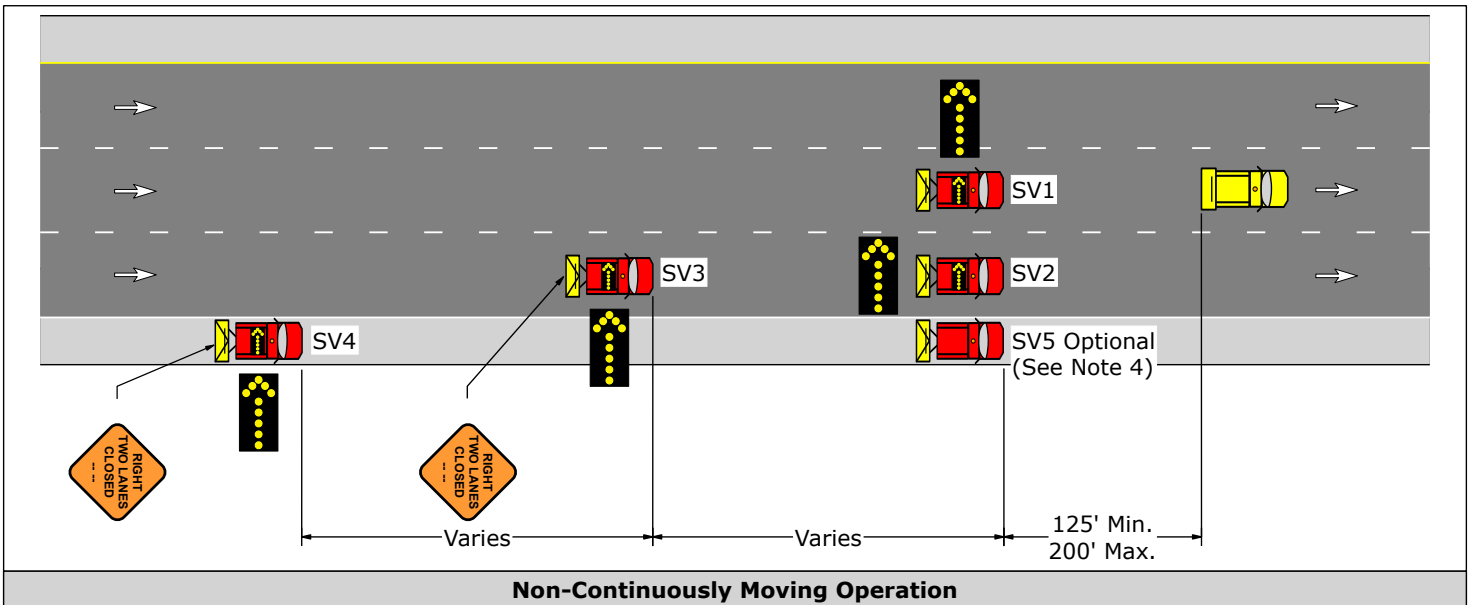
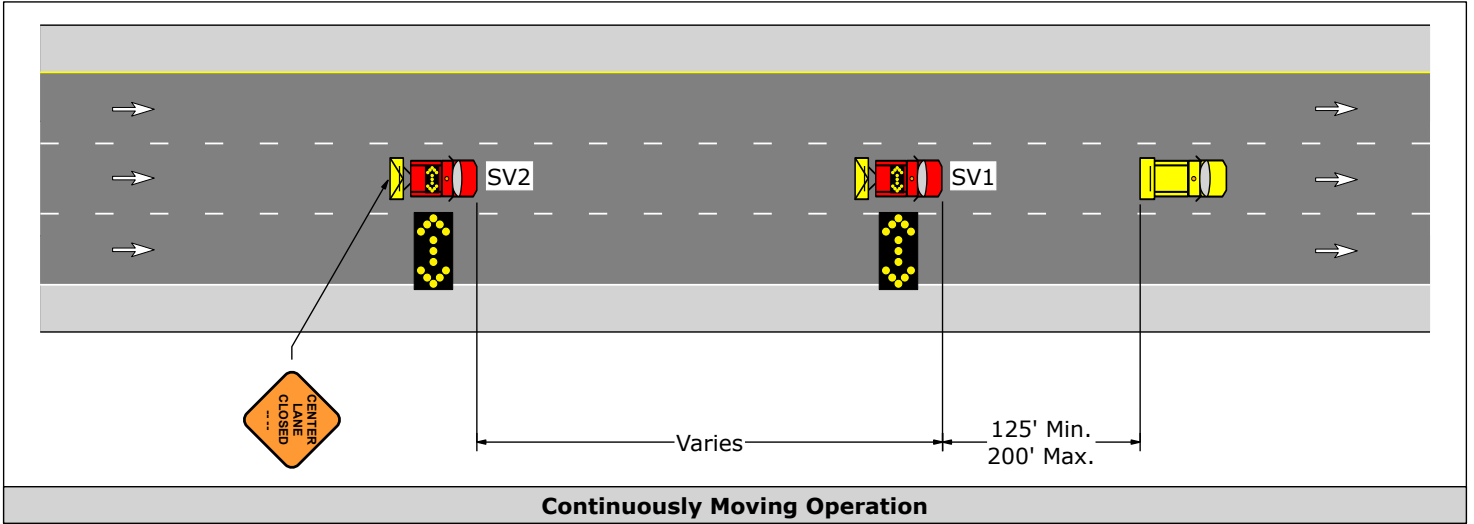


PATA 603-C

1. The traffic queue behind the operation should be constantly monitored. Remove all workers, work vehicles, and shadow vehicles from the roadway if it is determined that the operation is creating stopped traffic at the end of the queue. The operation may resume after queued traffic has cleared.
2. Spacing between shadow vehicles may vary to deter traffic from driving in between. Whenever adequate stopping sight distance exists to the rear, shadow vehicles should maintain a reasonable distance and proceed at the same speed as the work operation vehicle, but should slow down in advance of vertical or horizontal curves that restrict sight distance.
3. SV4 shown on the shoulder should be positioned entirely on the shoulder, however straddling the edge line is permitted.
4. SV5 is optional. It may be driven beside SV2 to provide additional protection to workers on foot. Where narrow shoulders are encountered, SV5 should fall behind SV2 and return to original position when possible.







PATA 603-C



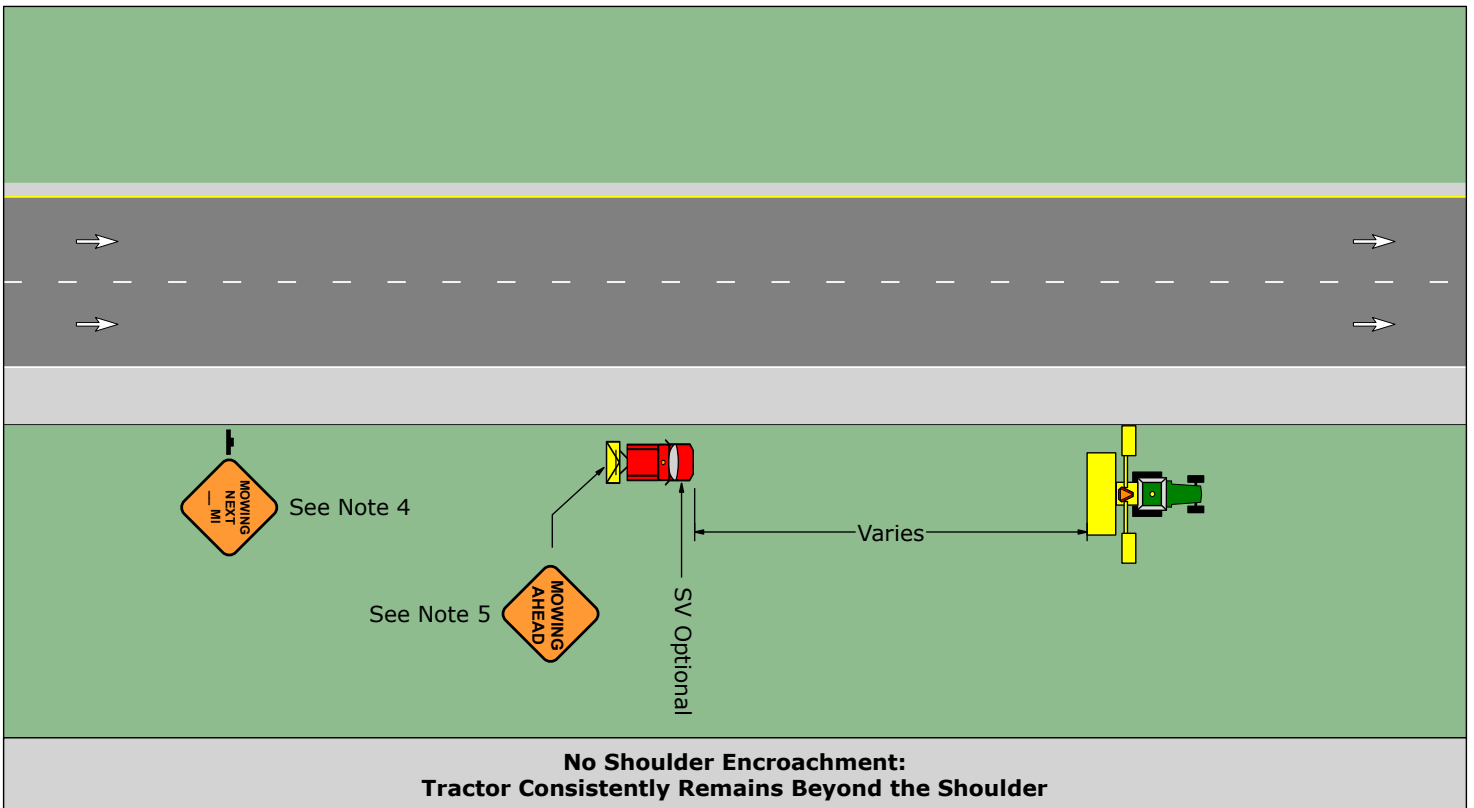
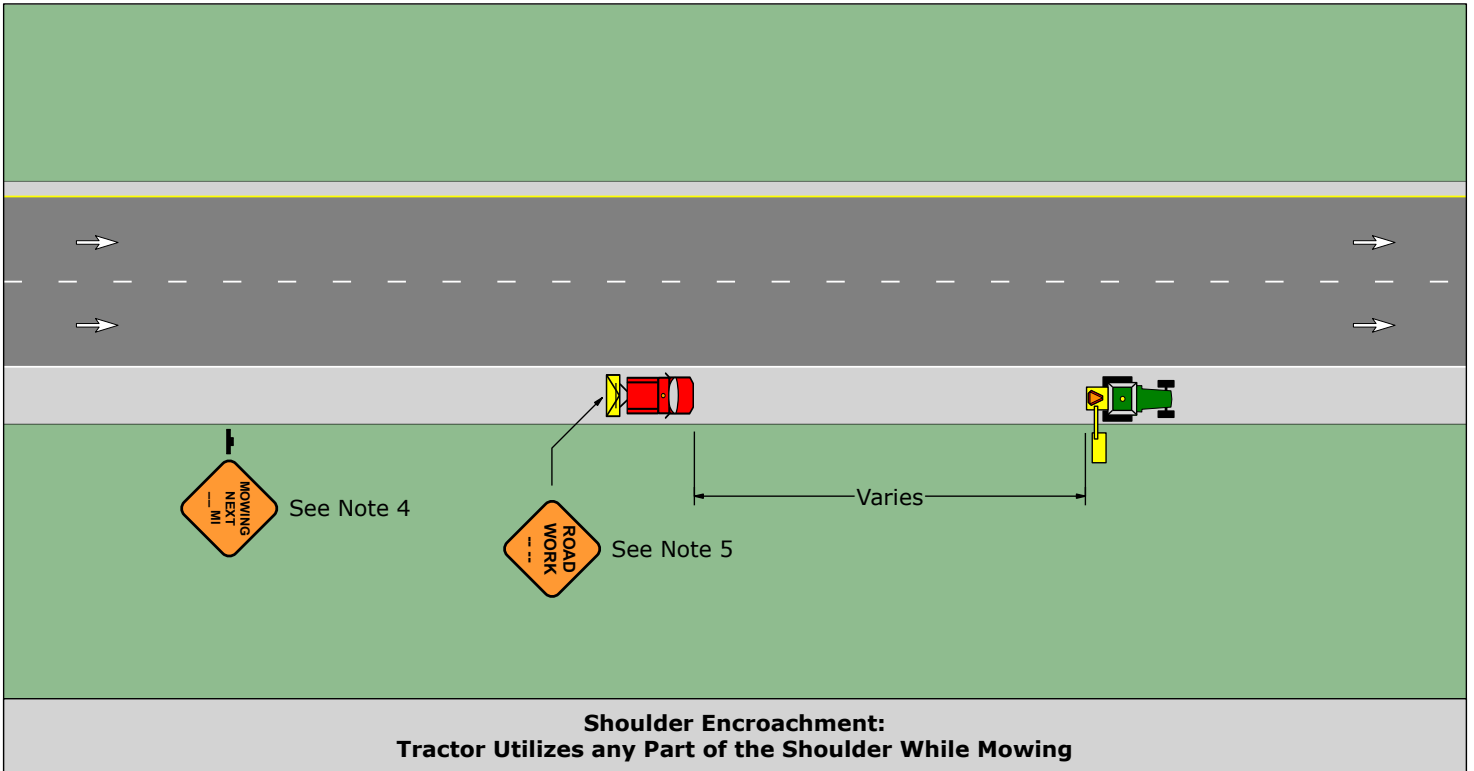
PATA 604

1. This PATA is for mowing operations. Mowing is to be performed without the tractor encroaching upon the roadway and/or shoulder whenever possible. A shadow vehicle is required if the tractor will encroach upon the shoulder or roadway while performing the mowing operation.
2. If a shadow vehicle is utilized, the spacing between the mower and the shadow vehicle may vary. The variation in distance between the mower and shadow vehicle is dependent on the speed, sight distance, and type of operation. Whenever adequate stopping sight distance (Distance E) exists to the rear, the shadow vehicle should maintain a reasonable distance and proceed at the same speed as the mower. The shadow vehicle should slow down in advance of vertical or horizontal curves that restrict sight distance.
3. During mowing operations beyond the shoulder, the mowing implement may overlap the shoulder up to 12" without requiring a shadow vehicle.
4. The Mowing Next XX Miles (W21-14) sign is optional when a shadow vehicle is utilized. Install the sign 500' prior to the area to be mowed. The mowing operation must remain downstream and within the distance posted on the sign (up to 5 miles maximum).
5. When a shadow vehicle is utilized, an appropriate TTC sign, such as a Mowing Ahead (W21-8) sign or Road Work Ahead (W20-1) sign, shall be mounted on the rear of the shadow vehicle.
6. The shadow vehicle may be equipped with an arrow board.
7. Mowers may utilize the shoulder or roadway to navigate around roadside obstacles such as utility poles, traffic signs, etc. The operator shall yield the right of way to all traffic before entering the roadway in accordance with Pennsylvania Consolidated Statutes, Title 75 (Vehicle Code), Section 3324 and exit the roadway immediately after passing the obstruction.
6. The mower is required to have a Slow Moving Vehicle Emblem (V1-6-1) sign mounted to the rear and positioned as near as practicable to the center of the vehicle. A flashing, oscillating, or revolving yellow light which is visible from any direction (360° visibility) must be active when mowing is in progress.

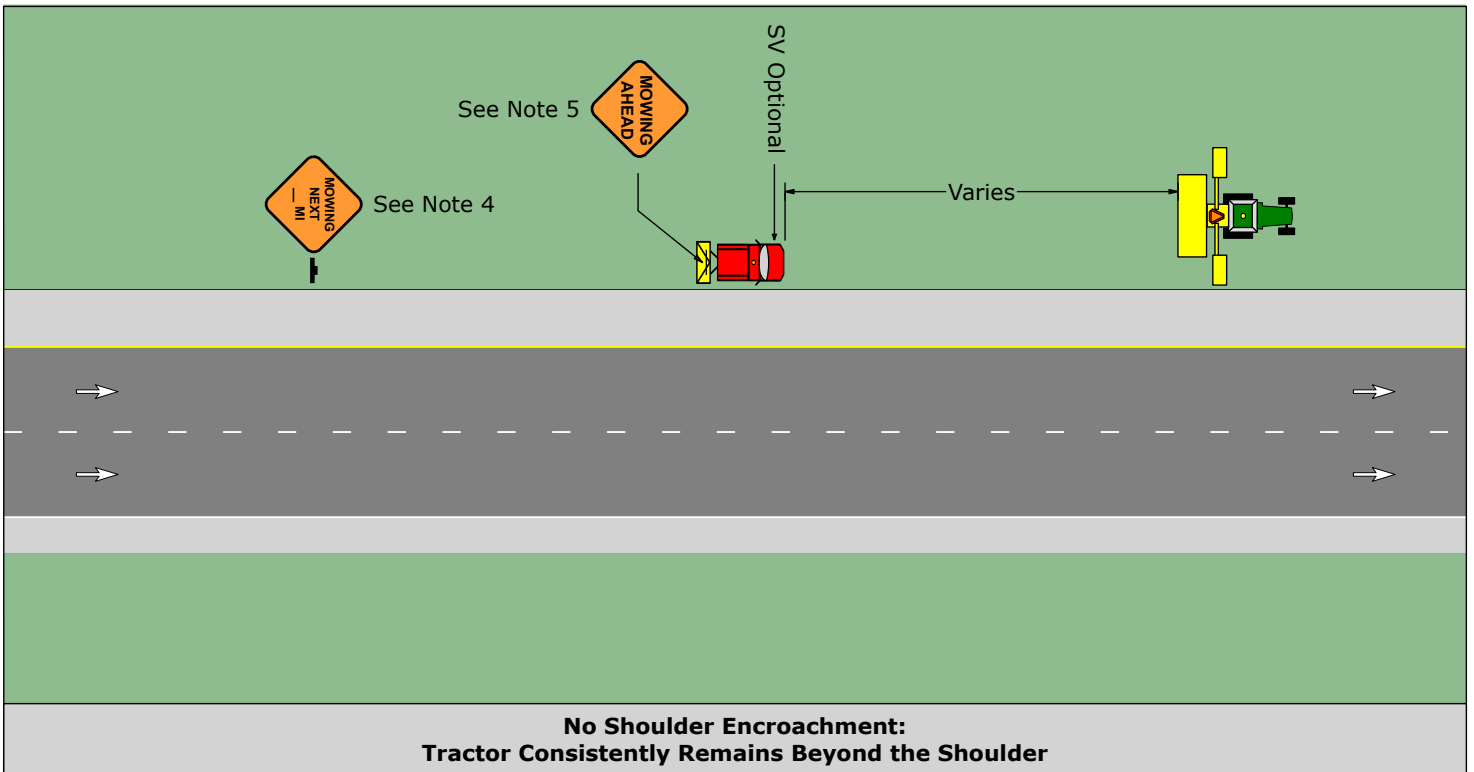
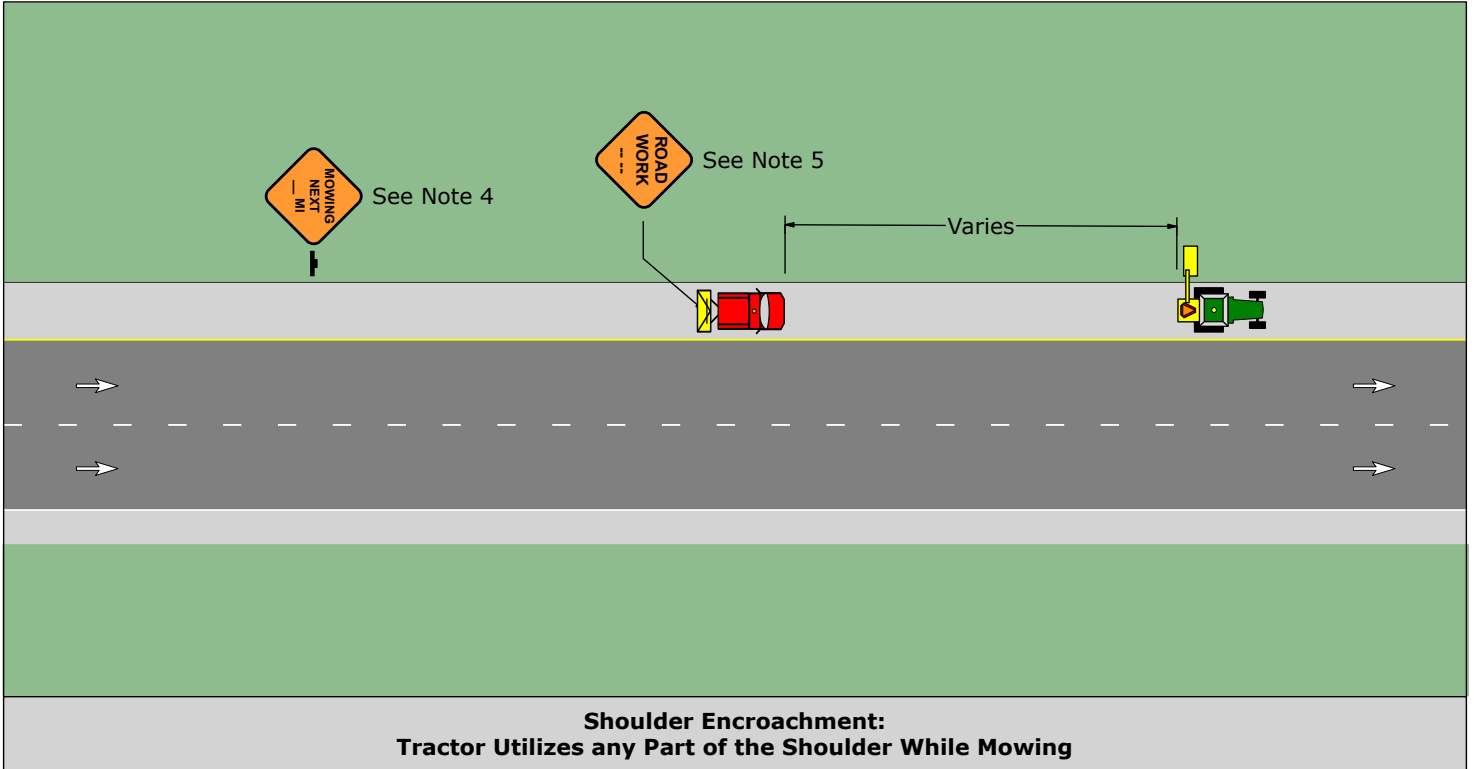
Signs			
			
W20-1	W21-14	G80-1	V1-6-1

Shadow Vehicle Visibility to Approaching Motorists	
Speed	Buffer Space
S (MPH)	E (Feet)
40	250
45	360
50	425
55	495
60	570
65	645
70	730

PATA 604



PATA 604



TTC Signal Operations

(PATA 700 Series)

PATA Drawing Reference Guide for TTC Signals

Refer to Appendix D Additional Information

Type of Highway	Type of Application	Type of TTC Signal Support		
Existing Two-Lane/Two-Way Highway Operates with Temporary One-Lane/Two-Way Traffic Flow	Short Term or Long Term Non Complex or Complex Auto or Manual Control	Pedestal-Mounted Portable	Trailer-Mounted Portable	Overhead Span Wire Fixed Supports
	Short-term Non Complex Condition Auto or Manual Control	PATA 701	PATA 702	N/A
	Short-term Complex Condition Auto or Manual Control	PATA 703	PATA 704	N/A
	Long-term Complex or Non-Complex Condition Auto or Manual Control	N/A	PATA 706	PATA 705

PATA 701

1. Pedestal-mounted portable TTC signals used for short-term stationary operations with non-complex conditions shall comply with guidance and requirements from the following:
 - a) Provisions of this PATA drawing.
 - b) Guidance and acceptance procedures in Appendix D.
 - c) Design and application requirements in most current version of Publications 149 and 212.
 - d) Specifications in Publication 408.
 - e) Construction project details on an approved Traffic Control Plan.
2. This figure may be used if all of the following field conditions are satisfied:
 - a) The operation is short-term and stationary.
 - b) The portable TTC signals are used to control one-lane, two-way traffic, and no more than two approaches to the work zone will be controlled by the portable TTC signals.
 - c) There is no at-grade railroad crossing within the one-lane, two-way traffic section (between STOP HERE ON RED SIGNS) and within 300' of a portable TTC signal.
 - d) No roadway approach to the portable TTC signal is on a downgrade of 5% or more, if the normal speed limit is greater than 35 miles per hour.
 - e) There are no intersections or uncontrolled driveways within the one-lane, two-way traffic section.
 - f) The roadway ADT is 10,000 vehicles per day or less, and the distance between "Stop Here On Red" signs is less than 1000'.
3. Electronically submit a completed Notice of Commencement Form (TE-161) to the appropriate PennDOT DTE so that it is received at least 3 business days before the desired beginning time of the portable TTC signal usage, except for emergency work. The DTE may authorize commencement of work immediately on a case-by-case basis and shall provide information regarding the TTC zone to the appropriate DTMC or RTMC.
4. Pedestal-mounted portable TTC signals for short-term stationary operations with non-complex conditions may be operated in one of three modes: Manual-control by an operator(s), fixed-time control, or actuated control.
5. For manual control, a single operator may be used if the operator is located within the activity area and has an unobstructed view of both traffic traveling through the one-lane section and traffic on the approach to each portable TTC signal unit. Otherwise, a separate operator is required at each portable TTC signal unit and communication must be maintained between operators. For manual control:
 - a) Portable TTC signal operations should remain in a manually controlled mode and should not be changed unless directed by PennDOT.
 - b) Supplemental signal indicator lamps are required to show the operator(s) the status of signal indications.
6. For actuated control, the detection zone for vehicles approaching the signals should be limited to between 30' and 100' from the signal head.
7. Signal supports should be a minimum of 2 feet off the edge of travel way. If this is not possible, the supports shall be adequately delineated by channelizing devices.
8. Pedestal-mounted portable TTC signals shall have two signal faces on each approach and be continuously visible to approaching traffic from a point meeting the signal visibility distances specified in the table on Notes Page 3 of 3. All signal lenses shall be 12" in diameter.
9. The bottom of TTC signal housings shall be at least 8', but not more than 15' above the sidewalk or, if there is no sidewalk, above the center of the roadway.
10. The length of yellow change intervals is normally in the range from about 3 seconds to 6 seconds. Use a 5-second yellow change interval, or an appropriate value from Publication 149 based on actual site conditions.

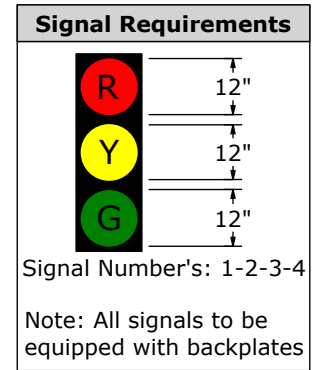
PATA 701

11. An all-red clearance interval must be used. The length of the all-red clearance interval is based on the length of the one-lane, two-way traffic section controlled by the portable TTC signals and the speed of traffic through that section. Monitor traffic operations during the period of portable TTC signal usage and adjust the length of the all-red clearance interval to account for site conditions and to provide for safe and efficient traffic operations. Unless otherwise indicated by PennDOT, the minimum length of all-red clearance intervals shall be as indicated on the table on Notes Page 3 of 3.
12. For fixed time and actuated operations, the minimum green interval provided for each approach shall be 10 seconds, unless otherwise indicated by PennDOT. The length of green intervals should be such as to provide for safe and efficient traffic operations. For green intervals, monitor traffic operations as traffic volumes change throughout the period of portable TTC signal usage and adjust green intervals to provide for safe and efficient traffic operations.
13. When not in operation, portable TTC signals shall be removed from the roadside or hooded with material described in Publication 408 Section 901.3(a). All TTC signs related to the TTC signal shall also be removed, covered or turned away from the roadway.
14. Red signal indications shall be displayed to both approaches when the TTC signal operates in flashing mode.
15. Additional signs and devices shall be installed as required in Publications 212, 213, actual site conditions and as identified on an approved Traffic Control Plan.
16. Signal modules must be replaced in accordance with the manufacturers' recommendations, and a record of the change must be maintained by the user.
17. In the event of TTC signal failure, traffic must be controlled by flaggers or work must cease and the roadway reopened until adequate TTC can be reestablished.
18. All deficiencies will be subject to work zone liquidated damages as referenced in Publication 408, Section 108.07 unless the portable TTC signals are controlled by a State Agency.
19. PennDOT reserves the right to inspect each portable TTC signal. PennDOT also reserves the right to suspend operation of the portable TTC signal if the user willfully or negligently fails to comply with the conditions contained in Note 1 or fails to make any changes in the operation of the signal, or remove it, when so ordered by PennDOT.

PATA 701

Signal Phases							
	Phase 1			Phase 2			Emergency Flashing
	↓ T			L ↑			
	Intervals			Intervals			
Signal	1	2	3	1	2	3	
① ②	G	Y	R	R	R	R	R
③ ④	R	R	R	G	Y	R	R
Fixed	**	5	*	**	5	*	
Minimum***	10			10			
Passage****	3			3			
Maximum ^	45			45			
Memory	L			L			
Any field adjustment of "STOP HERE ON RED SIGNS" requires new calculation of clearance intervals in accordance with PennDOT specifications.							
* See Table and Note 11.							
** For manual operations, interval determined by operator.							
*** See note 12. Minimum intervals not applicable for manual operations.							
**** Passage interval not applicable for manual or fixed operations.							
^ Field verify necessary green time. 45 seconds is maximum unless otherwise directed by the appropriate							

All-Red Clearance Interval (See Note 11)			
Length of One-Lane Two-Way Traffic Section between STOP HERE ON RED SIGN signs (FT)	Require Minimum Length of All-Red Clearance Interval (Seconds)		
	15 MPH	20 MPH	25 MPH
1000	45	34	27
950	43	32	26
900	41	31	25
850	39	29	23
800	36	27	22
750	34	26	20
700	32	24	19
650	30	22	18
600	27	20	16
550	25	19	15
500	23	17	14
450	20	15	12



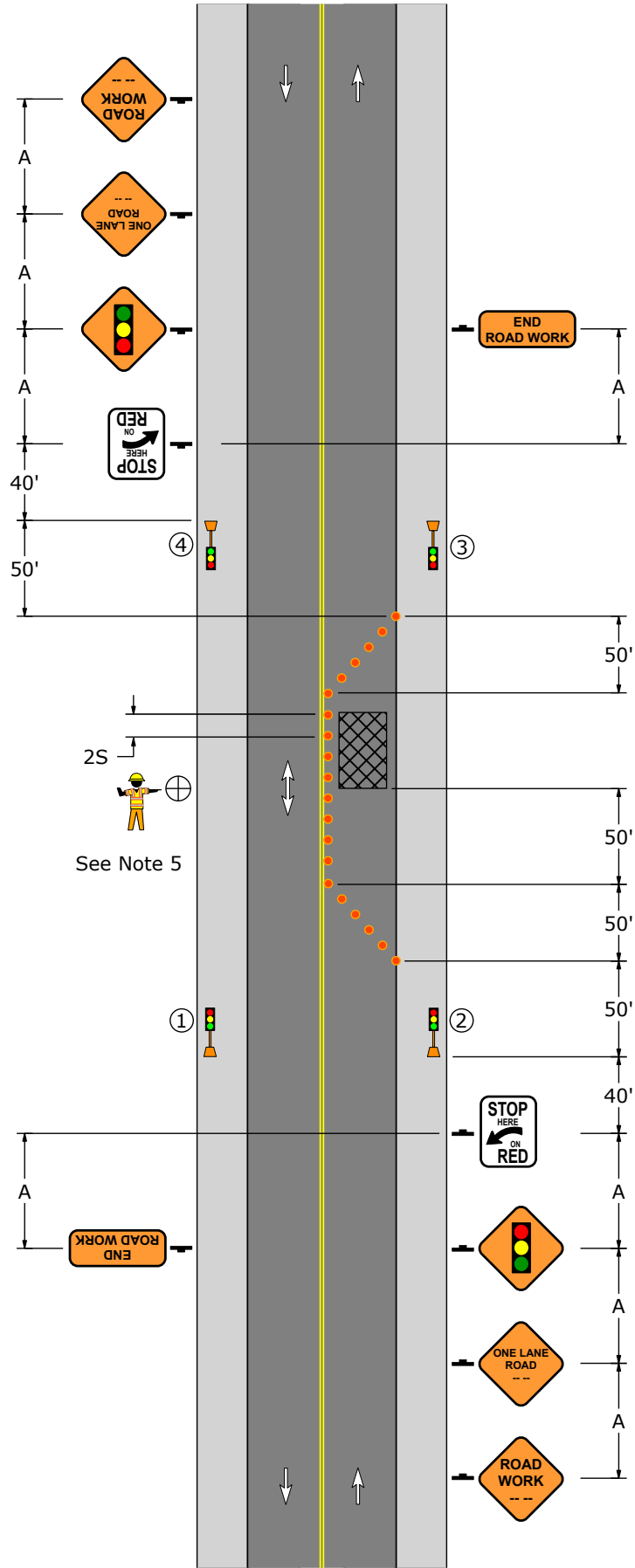
Signal Face Visibility (See Note 8)	
Normal Speed Limit (MPH)	Minimum Visibility Distance (FT)
25	215
30	270
35	325
40	390
45	460
50	540
55	625

Sign Spacing and Channelizing Device Spacing			
Speed	Channelizing Devices Spacing	Sign Spacing	
		Urban	Rural
S (MPH)	2S (Feet)	A (Feet)	A (Feet)
25	50	100 - 200	500 - 800
30	60	100 - 200	500 - 800
35	70	100 - 200	500 - 800
40	80	350 - 500	500 - 800
45	90	350 - 500	500 - 800
50	100	350 - 500	500 - 800
55	110	350 - 500	500 - 800

Taper Lengths and Minimum Number Of Channelizing Devices		
Speed	50' Per Lane Taper	
S (MPH)	Length (Feet)	Minimum Number Of Devices
25	50	6
30	50	6
35	50	6
40	50	6
45	50	6
50	50	6
55	50	6

Signs				
W20-1	W20-4	W3-3	G20-2	R10-6AL

PATA 701



PATA 702

1. The use of trailer-mounted portable TTC signals for short-term stationary operations with non-complex conditions shall comply with guidance and requirements from the following:
 - a) Provisions of this PATA drawing.
 - b) Guidance and acceptance procedures in Appendix D.
 - c) Design and application requirements in most current version of Publications 149 and 212.
 - d) Specifications in Publication 408.
 - e) Construction project details on an approved Traffic Control Plan.
2. This figure may be used if all of the following field conditions are satisfied:
 - a) The operation is short-term and stationary.
 - b) The portable TTC signals are used to control one-lane, two-way traffic, and no more than two approaches to the work zone will be controlled by the portable TTC signals.
 - c) There is no at-grade railroad crossing within the one-lane, two-way traffic section (between STOP HERE ON RED SIGNS) and within 300' of a portable TTC signal.
 - d) No roadway approach to the portable TTC signal is on a downgrade of 5% or more, if the normal speed limit is greater than 35 miles per hour.
 - e) There are no intersections or uncontrolled commercial driveways within the one-lane, two-way traffic section. The proposed method of traffic control for non-commercial driveways shall be acceptable to PennDOT.
 - f) The roadway ADT is 10,000 vehicles per day or less, and the distance between "Stop Here On Red" signs is less than 1000'.
3. Electronically submit a completed Notice of Commencement Form (TE-161) to the appropriate PennDOT DTE so that it is received at least 3 business days before the desired beginning time of the portable TTC signal usage, except for emergency work. The DTE may authorize commencement of work immediately on a case-by-case basis and shall provide information regarding the TTC zone to the appropriate DTMC or RTMC.
4. Trailer-mounted portable TTC signals for short-term stationary operations with non-complex conditions may be operated in one of three modes: Manual-control by an operator(s), fixed-time control, or actuated control.
5. For manual control, a single operator may be used if the operator is located within the activity area and has an unobstructed view of both traffic traveling through the one-lane section and traffic on the approach to each portable TTC signal unit. Otherwise, a separate operator is required at each portable TTC signal unit and communications must be maintained between operations. For manual control:
 - a) Portable TTC signal operations should remain in a manually controlled mode and should not be changed unless directed by PennDOT.
 - b) Supplemental signal indicator lamps are required to show the operator(s) the status of signal indications.
6. For actuated control, the detection zone for vehicles approaching the signals should be limited to between 30' and 100' from the signal head.
7. Delineation is required for trailers unless they are placed behind barrier or more than 2' beyond curb. Refer to PATA 009.
8. Trailer-mounted portable TTC signals shall have a minimum of two signal faces on each approach and be continuously visible to approaching traffic from a point meeting the signal visibility distances specified in the table on Notes Page 3 of 3.
 - a) Mount at least one signal head overhead on the mast arm.
 - b) Provide horizontal mast arm capable of extending a minimum distance of 9' from the edge of the trailer. Locate signal faces apart a minimum horizontal distance of 8' measured between centers of signal faces along a line perpendicular to the centerline of the approach.
 - c) All signal lenses shall be 12" in diameter.

PATA 702

9. Optional signal configurations shall only be used when physical obstructions make it unreasonable to use the primary configuration.
10. The bottom of the housing of a signal face suspended over the roadway shall be a minimum of 15', but not more than 19' above the pavement. The bottom of the housing of a signal face that is not mounted over the roadway shall be at least 8', but not more than 15' above the sidewalk or, if there is no sidewalk, above the pavement grade at the center of the roadway.
11. The length of yellow change intervals is normally in the range from about 3 seconds to 6 seconds. Use a 5-second yellow change interval, or an appropriate alternative value from Publication 149 based on actual site conditions.
12. An all-red clearance interval must be used. The length of the all-red clearance interval is based on the length of the one-lane, two-way traffic section controlled by the portable traffic control signals and the speed of traffic through that section. Monitor traffic operations during the period of portable traffic control signal usage and adjust the length of the all-red clearance interval to account for site conditions and to provide for safe and efficient traffic operations. Unless otherwise indicated by PennDOT, the minimum length of all-red clearance intervals shall be as indicated on the table on Notes Page 3 of 3.
13. For fixed time and actuated operations, the minimum green interval provided for each approach shall be 10 seconds, unless otherwise indicated by PennDOT. The length of green intervals should be such as to provide for safe and efficient traffic operations. For green intervals, monitor traffic operations as traffic volumes change throughout the period of portable TTC signal usage and adjust green intervals to provide for safe and efficient traffic operations.
14. When not in operation, portable TTC signals shall be removed from the roadside or hooded with material described in Publication 408 Section 901.3(a). All TTC signs related to the TTC signal shall also be removed, covered or turned away from the roadway.
15. All signal heads shall flash red while the TTC signal operates in flashing mode.
16. Additional signs and devices shall be installed as required in Publications 212, 213, actual site conditions and as identified on an approved Traffic Control Plan.
17. Signal modules must be replaced in accordance with the manufacturers' recommendations, and a record of the change must be maintained by the user.
18. In the event of TTC signal failure, traffic must be controlled by flaggers or work must cease and the roadway reopened until adequate TTC can be reestablished.
19. All deficiencies will be subject to work zone liquidated damages as referenced in Publication 408, Section 108.07 unless the portable TTC signals are controlled by a State Agency.
20. PennDOT reserves the right to inspect each portable TTC signal. PennDOT also reserves the right to suspend operation of the portable TTC signal if the user willfully or negligently fails to comply with the conditions contained in Note 1 or fails to make any changes in the operation of the signal, or remove it, when so ordered by PennDOT.

PATA 702

Signal Phases							
	Phase 1			Phase 2			Emergency Flashing
	↓ └─┬─┘ ↓			└─┬─┘ ↑			
	Intervals			Intervals			
Signal	1	2	3	1	2	3	
① ②	G	Y	R	R	R	R	R
③ ④	R	R	R	G	Y	R	R
Fixed	**	5	*	**	5	*	
Minimum***	10			10			
Passage****	3			3			
Maximum							
Memory	NL			NL			

Any field adjustment of "STOP HERE ON RED SIGNS" requires new calculation of clearance intervals in accordance with PennDOT specifications.

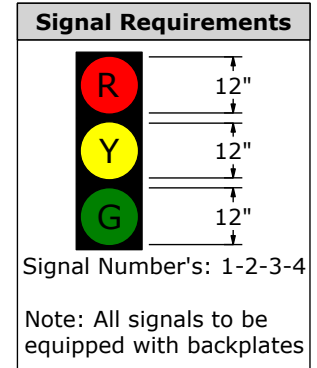
* See Table and Note 12.

** For manual operations, interval determined by operator.

*** See note 13. Minimum intervals not applicable for manual operations.

**** Passage interval not applicable for manual operations.

All-Red Clearance Interval (See Note 12)			
Length of One-Lane Two-Way Traffic Section between STOP HERE ON RED SIGN signs (FT)	Require Minimum Length of All-Red Clearance Interval (Seconds)		
	15 MPH	20 MPH	25 MPH
1000	45	34	27
950	43	32	26
900	41	31	25
850	39	29	23
800	36	27	22
750	34	26	20
700	32	24	19
650	30	22	18
600	27	20	16
550	25	19	15
500	23	17	14
450	20	15	12



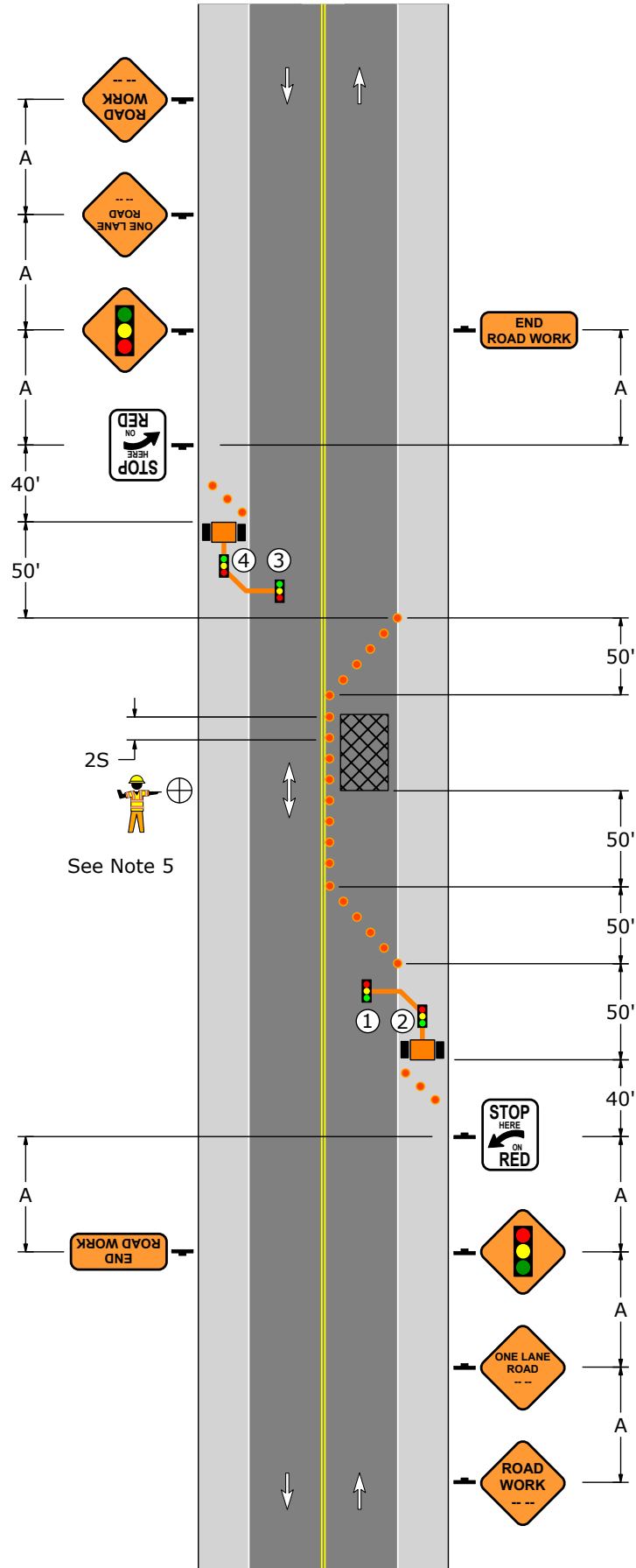
Signal Face Visibility (See Note 8)	
Normal Speed Limit (MPH)	Minimum Visibility Distance (FT)
25	215
30	270
35	325
40	390
45	460
50	540
55	625

Sign Spacing and Channelizing Device Spacing			
Speed	Channelizing Devices Spacing	Sign Spacing	
		Urban	Rural
S (MPH)	2S (Feet)	A (Feet)	A (Feet)
25	50	100 - 200	500 - 800
30	60	100 - 200	500 - 800
35	70	100 - 200	500 - 800
40	80	350 - 500	500 - 800
45	90	350 - 500	500 - 800
50	100	350 - 500	500 - 800
55	110	350 - 500	500 - 800

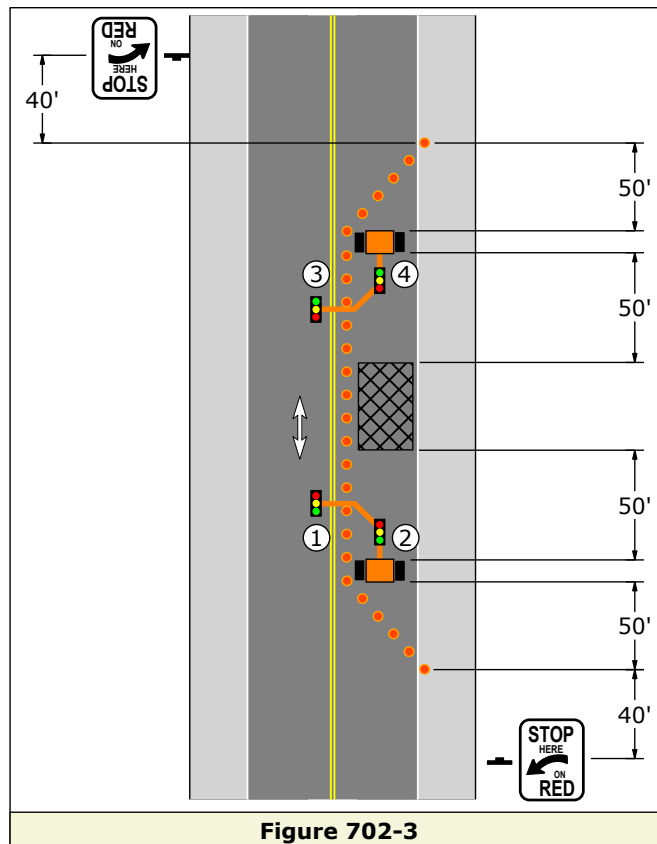
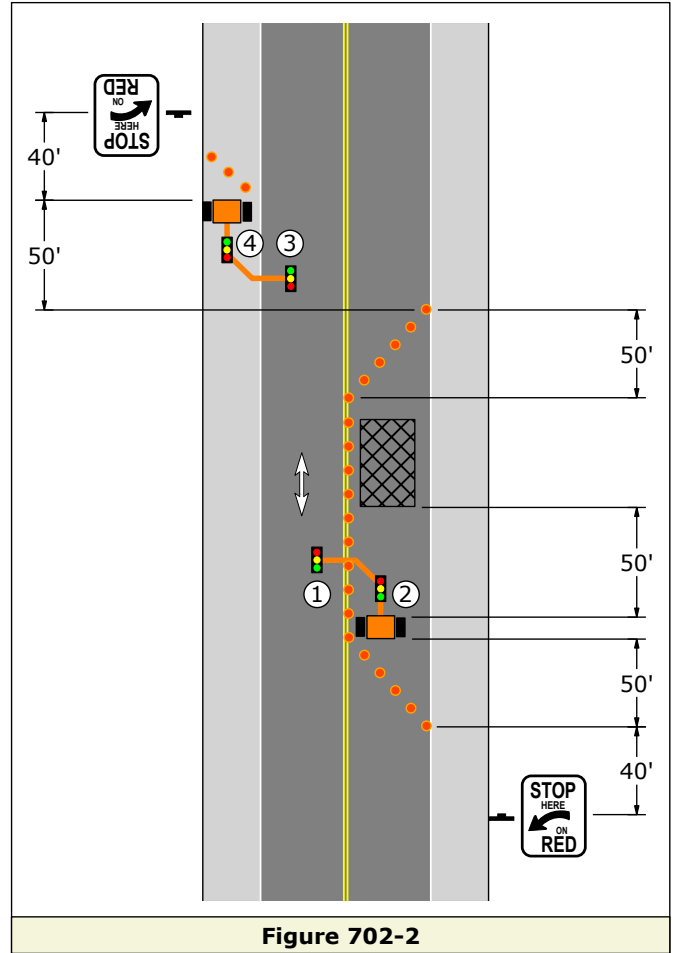
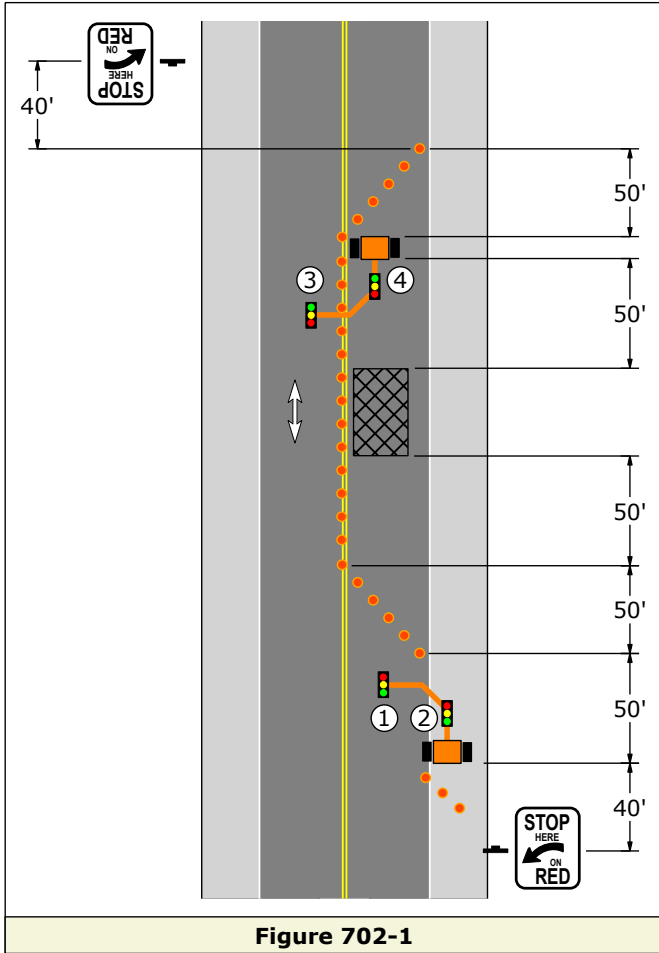
Taper Lengths and Minimum Number Of Channelizing Devices		
Speed	50' Per Lane Taper	
S (MPH)	Length (Feet)	Minimum Number Of Devices
25	50	6
30	50	6
35	50	6
40	50	6
45	50	6
50	50	6
55	50	6

Signs				
W20-1	W20-4	W3-3	G20-2	R10-6AL

PATA 702



PATA 702 Alternate Trailer Locations



Blank Page

PATA 703

1. The use of pedestal-mounted portable TTC signals for short-term stationary operations with complex conditions shall comply with guidance and requirements from the following:
 - a) Provisions of this PATA drawing.
 - b) Guidance and acceptance procedures in Appendix D.
 - c) Design and application requirements in most current version of Publications 149 and 212.
 - d) Specifications in Publication 408.
 - e) Construction project details on an approved Traffic Control Plan.
2. This figure may be used if all of the following field conditions are satisfied:
 - a) The operation is short-term and stationary.
 - b) The portable TTC signals are used to control one-lane, two-way traffic, and no more than two approaches to the work zone will be controlled by the portable TTC signals.
 - c) There is no at-grade railroad crossing within the one-lane, two-way traffic section (between STOP HERE ON RED SIGNS) and within 300' of a portable TTC signal.
 - d) No roadway approach to the portable TTC signal is on a downgrade of 5% or more, if the normal speed limit is greater than 35 miles per hour.
 - e) The roadway ADT is 10,000 vehicles per day or less, and the distance between "Stop Here On Red" signs is less than 1000'.
 - f) Flaggers shall be utilized to maintain control of traffic at all side roads and driveways that intersect the TTC zone between the signal locations. If necessary, provide additional flaggers to properly control all movements within an intersection.
 - g) Flaggers and signal operators shall be in communication with each other at all times.
3. Electronically submit a completed Notice of Commencement Form (TE-161) to the appropriate PennDOT DTE so that it is received at least 3 business days before the desired beginning time of the portable TTC signal usage, except for emergency work. The DTE may authorize commencement of work immediately on a case-by-case basis and shall provide information regarding the TTC zone to the appropriate DTMC or RTMC.
4. Pedestal-mounted portable TTC signals for short-term stationary operations with complex conditions may be operated in one of three modes: Manual-control by an operator(s), fixed-time control, or actuated control.
 - a) When there is traffic on side roads or driveways, the operator shall take control of the signals and operate as manually-controlled.
 - b) When there is not any traffic from side roads or driveways, the signals may be placed in a fixed-time control mode, or an actuated control mode.
5. For manual control, a single operator may be used if the operator is located within the activity area and has an unobstructed view of both traffic traveling through the one-lane section and traffic on the approach to each portable TTC signal unit. Otherwise, a separate operator is required at each portable TTC signal unit and communications must be maintained between operators. Supplemental signal indicator lamps are required to show the operator(s) the status of signal indications.
6. For actuated control, the detection zone for vehicles approaching the signals should be limited to between 30' and 100' from the signal head.
7. Signal supports should be a minimum of 2 feet off the edge of travel way. If this is not possible, the supports shall be adequately delineated by channelizing devices.
8. Pedestal-mounted portable TTC signals shall have two signal faces on each approach and be continuously visible to approaching traffic from a point meeting the signal visibility distances specified in the table on Notes Page 3 of 3. All signal lenses shall be 12" in diameter.
9. The bottom of TTC signal housings shall be at least 8', but not more than 15' above the sidewalk or, if there is no sidewalk, above the center of the roadway. All signal lenses shall be 12 inches in diameter.

PATA 703

10. The length of yellow change intervals is normally in the range from about 3 seconds to 6 seconds. Use a 5-second yellow change interval, or an appropriate alternative value from PennDOT Publication 149 based on actual site conditions.
11. An all-red clearance interval must be used. The length of the all-red clearance interval is based on the length of the one-lane, two-way traffic section controlled by the portable traffic control signals and the speed of traffic through that section. Monitor traffic operations during the period of portable traffic control signal usage and adjust the length of the all-red clearance interval to account for site conditions and to provide for safe and efficient traffic operations. Unless otherwise indicated by PennDOT, the minimum length of all-red clearance intervals shall be as indicated on the table on Notes Page 3 of 3.
12. For fixed time and actuated operations, the minimum green interval provided for each approach shall be 10 seconds, unless otherwise indicated by PennDOT. The length of green intervals should be such as to provide for safe and efficient traffic operations. Use green intervals as indicated, monitor traffic operations as traffic volumes change throughout the period of portable TTC signal usage and adjust green intervals to provide for safe and efficient traffic operations.
13. When not in operation, portable TTC signals shall be removed from the roadside or hooded with material described in Publication 408 Section 901.3(a). All TTC signs related to the TTC signal shall also be removed, covered or turned away from the roadway.
14. Red signal indications shall be displayed to both approaches when the TTC signal operates in flashing mode.
15. Additional signs and devices shall be installed as required in PennDOT Publications 212 and 213, and as required based on actual site conditions.
16. Signal modules must be replaced in accordance with the manufacturers' recommendations, and a record of the change must be maintained by the user.
17. In the event of TTC signal failure, traffic must be controlled by flaggers or work must cease and the roadway reopened until adequate TTC can be reestablished.

PATA 703

All-Red Clearance Interval (See Note 11)			
Length of One-Lane Two-Way Traffic Section between STOP HERE ON RED SIGN signs (FT)	Require Minimum Length of All-Red Clearance Interval (Seconds)		
	15 MPH	20 MPH	25 MPH
1000	45	34	27
950	43	32	26
900	41	31	25
850	39	29	23
800	36	27	22
750	34	26	20
700	32	24	19
650	30	22	18
600	27	20	16
550	25	19	15
500	23	17	14
450	20	15	12

Signal Face Visibility (See Note 8)	
Normal Speed Limit (MPH)	Minimum Visibility Distance (FT)
25	215
30	270
35	325
40	390
45	460
50	540
55	625

Sign Spacing and Channelizing Device Spacing			
Speed	Channelizing Devices Spacing	Sign Spacing	
		Urban	Rural
S (MPH)	2S (Feet)	A (Feet)	A (Feet)
25	50	100 - 200	500 - 800
30	60	100 - 200	500 - 800
35	70	100 - 200	500 - 800
40	80	350 - 500	500 - 800
45	90	350 - 500	500 - 800
50	100	350 - 500	500 - 800
55	110	350 - 500	500 - 800

Taper Lengths and Minimum Number Of Channelizing Devices		
Speed	50' Per Lane Taper	
S (MPH)	Length (Feet)	Minimum Number Of Devices
25	50	6
30	50	6
35	50	6
40	50	6
45	50	6
50	50	6
55	50	6

Signs				
W20-1	W20-4	W3-3	G20-2	R10-6AL

PATA 704

1. The use of trailer-mounted portable TTC signals for short-term stationary operations with complex conditions shall comply with guidance and requirements from the following:
 - a) Provisions of this PATA drawing.
 - b) Guidance and acceptance procedures in Appendix D.
 - c) Design and application requirements in most current version of Publications 149 and 212.
 - d) Specifications in Publication 408.
 - e) Requirements of the approved TTC Signal Permit (TE-964P).
 - f) Construction project details on an approved Traffic Control Plan.
2. Advance written approval must be obtained from PennDOT prior to using trailer-mounted TTC signals for short-term operations with complex conditions on any public highway.
 - a) Electronically submit a completed Application for Permit to Operate TTC Signals (TE-952P) to the appropriate PennDOT DTE so that it is received at least 3 business days before the desired beginning time of TTC signal usage, except for emergency work. The DTE may authorize commencement of work immediately on a case-by-case basis and shall provide information regarding the TTC zone to the appropriate RTMC or DTMC.
 - b) A TTC Signal Permit (TE-964P) is required before using TTC signals in accordance with this PATA. A copy of the permit must be maintained on site during the usage period.
 - c) The operation and maintenance of this TTC signal by the permittee shall be in accordance with the conditions and requirements contained and referenced in the TTC signal permit and Note 1.
3. Delineation is required for trailers unless they are placed behind barrier or more than 2' beyond curb.
4. Trailer-mounted portable TTC signals shall have a minimum of two signal faces on each approach and be continuously visible to approaching traffic from a point meeting the signal visibility distances specified in the table on Notes Page 2 of 2.
 - a) Mount at least one signal head overhead on the mast arm.
 - b) Provide horizontal mast arm capable of extending a minimum distance of 9' from the edge of the trailer. Locate signal faces apart a minimum horizontal distance of 8' measured between centers of signal faces along a line perpendicular to the centerline of the approach.
 - c) All signal lenses shall be 12" in diameter
5. Optional signal configurations shall only be used when physical obstructions make it unreasonable to use the primary configuration.
6. The bottom of the housing of a signal face suspended over the roadway shall be a minimum of 15', but not more than 19' above the pavement. The bottom of the housing of a signal face that is not mounted over the roadway shall be at least 8', but not more than 15' above the sidewalk or, if there is no sidewalk, above the pavement grade at the center of the roadway.
7. The length of yellow change intervals is normally in the range from about 3 seconds to 6 seconds. Use a 5-second yellow change interval, or an appropriate alternative value from Publication 149 based on actual site conditions.
8. An all-red clearance interval must be used. The length of the all-red clearance interval is based on the length of the one-lane, two-way traffic section controlled by the portable traffic control signals and the speed of traffic through that section. Monitor traffic operations during the period of portable traffic control signal usage and adjust the length of the all-red clearance interval to account for site conditions and to provide for safe and efficient traffic operations. Unless otherwise indicated by PennDOT, the minimum length of all-red clearance intervals shall be as indicated on the table on Notes Page 3 of 3.
9. For fixed time and actuated operations, the minimum green interval provided for each approach shall be 10 seconds, unless otherwise indicated by PennDOT. The length of green intervals should be such as to provide for safe and efficient traffic operations. For green intervals, monitor traffic operations as traffic volumes change throughout the period of portable TTC signal usage and adjust green intervals to provide for safe and efficient traffic operations.
10. When not in operation, portable TTC signals shall be removed from the roadside or hooded with material described in Publication 408 Section 901.3(a). All TTC signs related to the TTC signal shall also be removed, covered or turned away from the roadway.

PATA 704






11. All signal heads shall flash red while the TTC signal operates in flashing mode.
12. Additional signs and devices shall be installed as required in Publications 212, 213, actual site conditions and as identified on an approved Traffic Control Plan.
13. Signal modules must be replaced in accordance with the manufacturers' recommendations, and a record of the change must be maintained by the user.
14. In the event of TTC signal failure, traffic must be controlled by flaggers or work must cease and the roadway reopened until adequate TTC can be reestablished.
15. All deficiencies will be subject to work zone liquidated damages as referenced in Publication 408, Section 108.07 unless the portable TTC signals are controlled by a State Agency.
16. PennDOT reserves the right to inspect each portable TTC signal. PennDOT also reserves the right to revoke a TTC Signal Permit or to suspend operation of the portable TTC signal if the user willfully or negligently fails to comply with the conditions contained in Note 1 or fails to make any changes in the operation of the signal, or remove it, when so ordered by PennDOT. The user shall not make any change in operation of the TTC signal as defined in the TTC Signal Permit without prior written approval of PennDOT.

All-Red Clearance Interval (See Note 8)			
Length of One-Lane Two-Way Traffic Section between STOP HERE ON RED SIGN signs (FT)	Require Minimum Length of All-Red Clearance Interval (Seconds)		
	15 MPH	20 MPH	25 MPH
1000	45	34	27
950	43	32	26
900	41	31	25
850	39	29	23
800	36	27	22
750	34	26	20
700	32	24	19
650	30	22	18
600	27	20	16
550	25	19	15
500	23	17	14
450	20	15	12

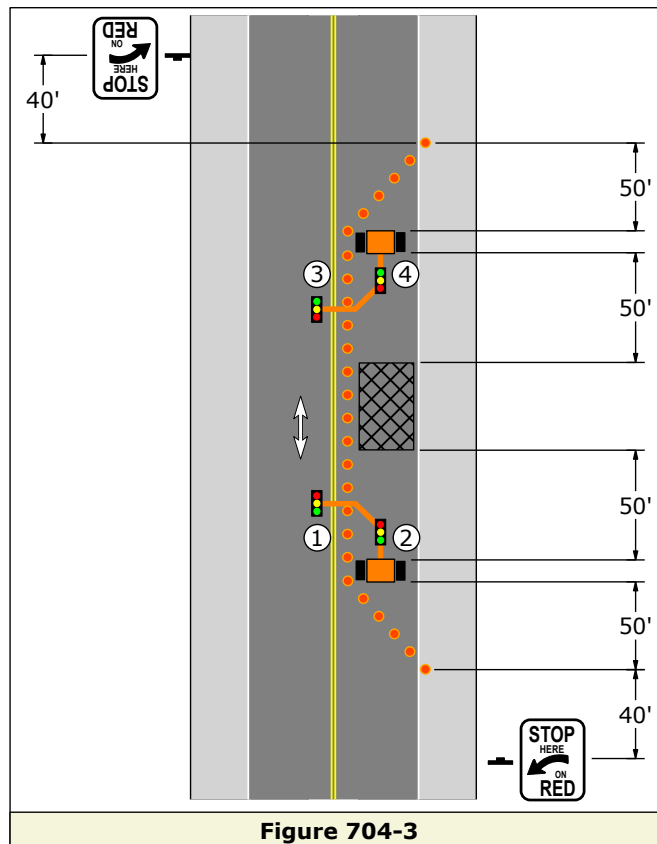
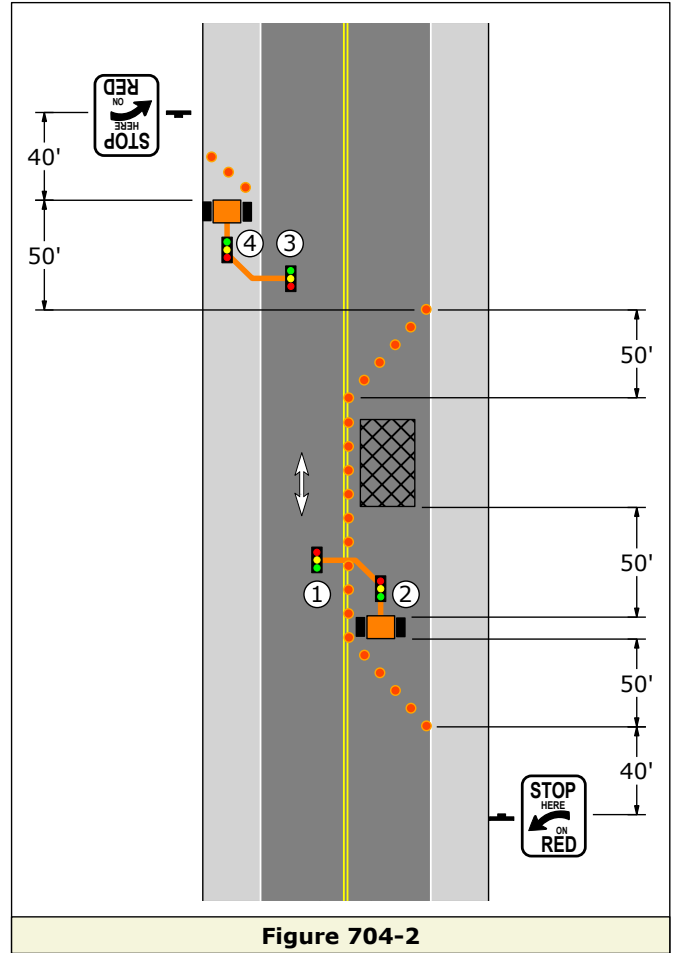
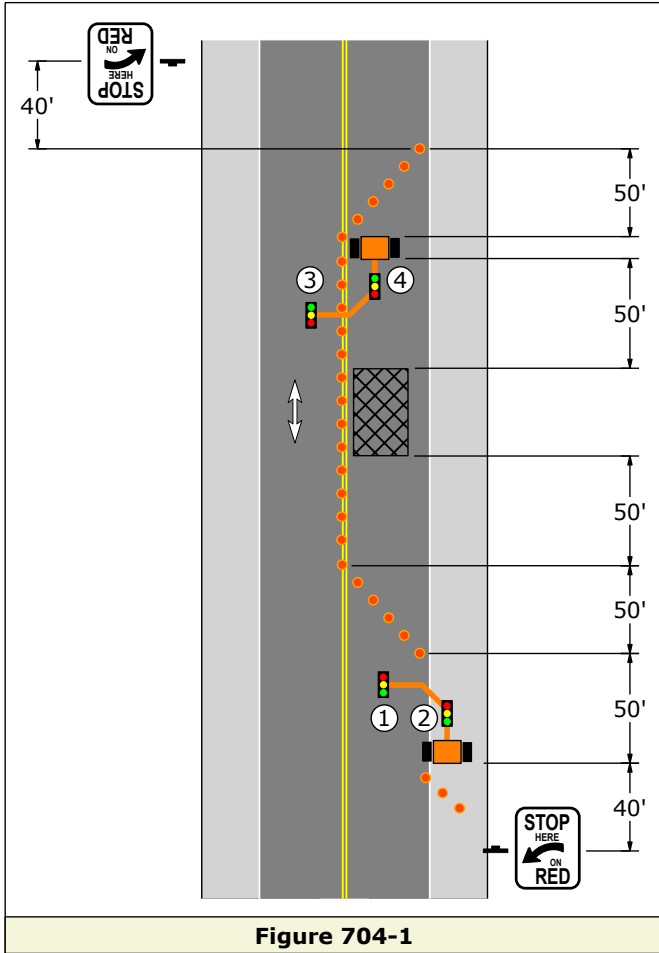
Signal Face Visibility (See Note 4)	
Normal Speed Limit (MPH)	Minimum Visibility Distance (FT)
25	215
30	270
35	325
40	390
45	460
50	540
55	625

Sign Spacing and Channelizing Device Spacing			
Speed	Channelizing Devices Spacing	Sign Spacing	
		Urban	Rural
S (MPH)	2S (Feet)	A (Feet)	A (Feet)
25	50	100 - 200	500 - 800
30	60	100 - 200	500 - 800
35	70	100 - 200	500 - 800
40	80	350 - 500	500 - 800
45	90	350 - 500	500 - 800
50	100	350 - 500	500 - 800
55	110	350 - 500	500 - 800

Taper Lengths and Minimum Number Of Channelizing Devices		
Speed	50' Per Lane Taper	
S (MPH)	Length (Feet)	Minimum Number Of Devices
25	50	6
30	50	6
35	50	6
40	50	6
45	50	6
50	50	6
55	50	6

Signs				
				
W20-1	W20-4	W3-3	G20-2	R10-6AL

PATA 704 Alternate Trailer Locations



PATA 705

1. The use of fixed-support TTC signals for long-term stationary operations shall comply with guidance and requirements from the following:
 - a) Provisions of this PATA drawing.
 - b) Guidance and acceptance procedures in Appendix D.
 - c) Design and application requirements in most current version of Publications 149 and 212.
 - d) Specifications in Publication 408.
 - e) Requirements of the approved TTC Signal Permit (TE-964P).
 - f) Construction project details on an approved Traffic Control Plan.
2. Advance written approval must be obtained from PennDOT prior to using fixed-support TTC signals for long-term operations on any public highway.
 - a) Electronically submit a completed Application for Permit to Operate TTC Signals (TE-952P) to the appropriate PennDOT DTE so that it is received at least 15 business days before the desired beginning time of TTC signal usage, except for emergency work. The DTE may authorize commencement of work immediately on a case-by-case basis and shall provide information regarding the TTC zone to the appropriate RTMC or DTMC.
 - b) A TTC Signal Permit (TE-964P) is required before using TTC signals in accordance with this PATA. A copy of the permit must be maintained on site during the usage period.
 - c) The operation and maintenance of this TTC signal by the permittee shall be in accordance with the conditions and requirements contained and referenced in the TTC signal permit and Note 1.
3. The fixed-support TTC signals shall have a minimum of two signal faces on each approach and be continuously visible to approaching traffic from a point meeting the signal visibility distances specified in the table on Notes Page 2 of 2.
 - a) Two signal head indications over the roadway are preferred, See Appendix D for more information on signal head placement for long-term operations.
 - b) All signal lenses shall be 12" in diameter
4. The bottom of the housing of a signal face suspended over the roadway shall be a minimum of 15', but not more than 19' above the pavement. The bottom of the housing of a signal face that is not mounted over the roadway shall be at least 8', but not more than 15' above the sidewalk or, if there is no sidewalk, above the pavement grade at the center of the roadway.
5. Remove all existing, conflicting pavement markings and signing; restore permanent markings and signing when long-term operations are complete.
 - a) Stop lines shall be installed with all TTC signal long-term stationary operations. Remove lenses from conflicting raised pavement markers.
 - b) A no-passing zone shall be established when an existing passing zone is present. A temporary double yellow pavement marking line shall be installed throughout the entire length of the TTC zone. Place a No Passing Zone (W14-3) sign at the start of the temporary double yellow pavement marking line (across from the Road Work Ahead (W20-1) sign).
 - c) After TTC signals are removed, the stop lines and other temporary pavement markings shall be removed and the permanent pavement markings and signs restored.
6. When not in operation, portable TTC signals shall be removed from the roadside or hooded with material described in Publication 408 Section 901.3(a). All TTC signs related to the TTC signal shall also be removed, covered or turned away from the roadway.
7. All signal heads shall flash red while the TTC signal operates in flashing mode.
8. Additional signs and devices shall be installed as required in Publications 212, 213, actual site conditions and as identified on an approved Traffic Control Plan.
9. Signal modules must be replaced in accordance with the manufacturers' recommendations, and a record of the change must be maintained by the user.







PATA 705

10. In the event of TTC signal failure, traffic must be controlled by flaggers or work must cease and the roadway reopened until adequate TTC can be reestablished.

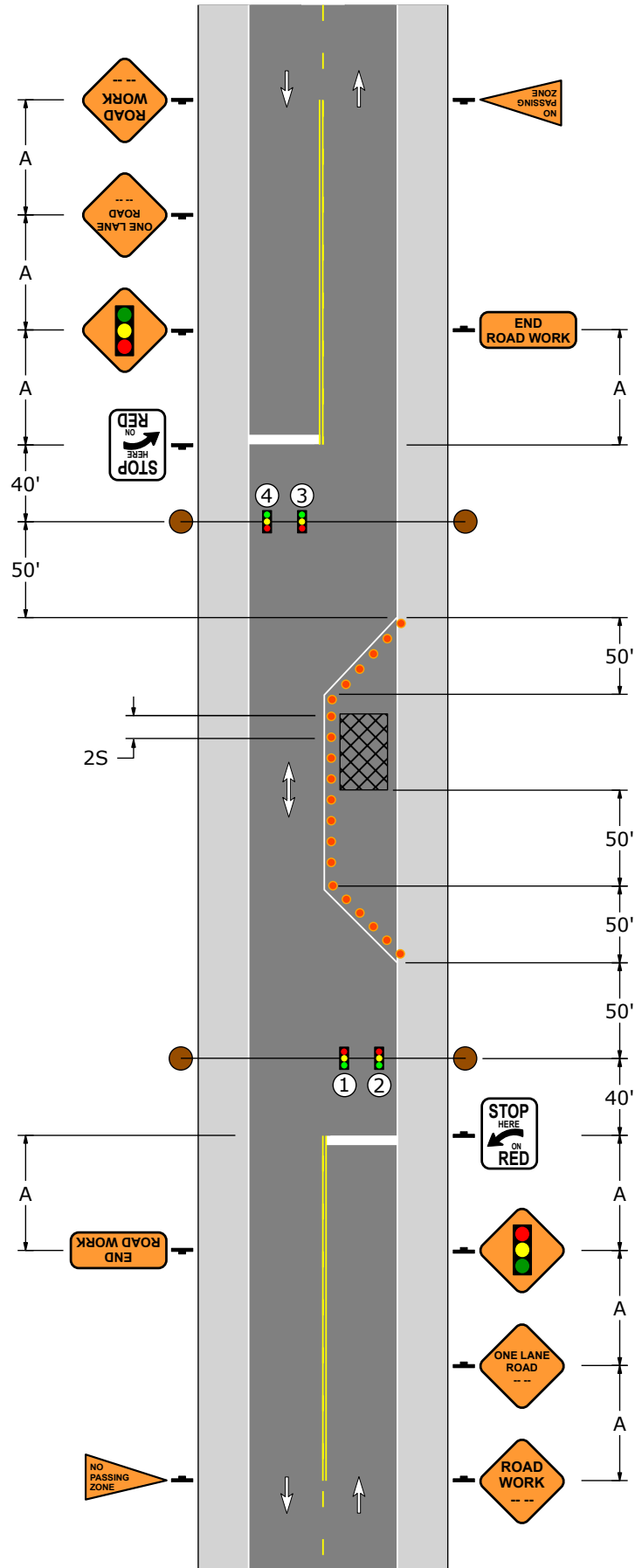
Signal Face Visibility (See Note 3)	
Normal Speed Limit (MPH)	Minimum Visibility Distance (FT)
25	215
30	270
35	325
40	390
45	460
50	540
55	625

Sign Spacing and Channelizing Device Spacing			
Speed	Channelizing Devices Spacing	Sign Spacing	
		Urban	Rural
S (MPH)	2S (Feet)	A (Feet)	A (Feet)
25	50	100 - 200	500 - 800
30	60	100 - 200	500 - 800
35	70	100 - 200	500 - 800
40	80	350 - 500	500 - 800
45	90	350 - 500	500 - 800
50	100	350 - 500	500 - 800
55	110	350 - 500	500 - 800

Taper Lengths and Minimum Number Of Channelizing Devices		
Speed	50' Per Lane Taper	
S (MPH)	Length (Feet)	Minimum Number Of Devices
25	50	6
30	50	6
35	50	6
40	50	6
45	50	6
50	50	6
55	50	6

Signs					
					
W20-1	W20-4	W3-3	W14-3	G20-2	R10-6AL

PATA 705



Blank Page

PATA 706

1. The use of trailer-mounted portable TTC signals for long-term stationary operations shall comply with guidance and requirements from the following:
 - a) Provisions of this PATA drawing.
 - b) Guidance and acceptance procedures in Appendix D.
 - c) Design and application requirements in most current version of Publications 149 and 212.
 - d) Specifications in Publication 408.
 - e) Requirements of an approved TTC Signal Permit (TE-964P).
 - f) Construction project details on an approved Traffic Control Plan.
2. Advance written approval must be obtained from PennDOT prior to using trailer-mounted portable TTC signals for long-term operations on any public highway.
 - a) Electronically submit a completed Application for Permit to Operate TTC Signals (TE-952P) to the appropriate PennDOT DTE so that it is received at least 15 business days before the desired beginning time of TTC signal usage, except for emergency work. The DTE may authorize commencement of work immediately on a case-by-case basis and shall provide information regarding the TTC zone to the appropriate RTMC or DTMC.
 - b) A TTC Signal Permit (TE-964P) is required before using TTC signals in accordance with this PATA. A copy of the permit must be maintained on site during the usage period.
 - c) The operation and maintenance of this TTC signal by the permittee shall be in accordance with the conditions and requirements contained and referenced in the TTC signal permit and Note 1.
3. Delineation is required for trailers unless they are placed behind barrier or more than 2' beyond curb.
4. Trailer-mounted portable TTC signals shall have a minimum of two signal faces on each approach and be continuously visible to approaching traffic from a point meeting the signal visibility distances specified in the table on Notes Page 3 of 3. Pedestal-mounted portable TTC signal units are not permitted for long-term operations.
 - a) Mount at least one signal head overhead on the mast arm.
 - b) Provide horizontal mast arm capable of extending a minimum distance of 9' from the edge of the trailer. Locate signal faces apart a minimum horizontal distance of 8' measured between centers of signal faces along a line perpendicular to the centerline of the approach.
 - c) All signal lenses shall be 12" in diameter
5. Remove all existing, conflicting pavement markings and signing; restore permanent markings and signing when long-term operations are complete.
 - a) Stop lines shall be installed with all TTC signal long-term stationary operations. Remove lenses from conflicting raised pavement markers.
 - b) A no-passing zone shall be established when an existing passing zone is present. A temporary double yellow pavement marking line shall be installed throughout the entire length of the TTX zone. Place a No Passing Zone (W14-3) sign at the start of the temporary double yellow pavement marking line (across from the Road Work Ahead (W20-1) sign).
 - c) After TTC signals are removed, the stop lines and other temporary pavement markings shall be removed and the permanent pavement markings and signs restored.
6. Optional signal configurations shall only be used when physical obstructions make it unreasonable to use the primary configuration.
7. The bottom of the housing of a signal face suspended over the roadway shall be a minimum of 15', but not more than 19' above the pavement. The bottom of the housing of a signal face that is not mounted over the roadway shall be at least 8', but not more than 15' above the sidewalk or, if there is no sidewalk, above the pavement grade at the center of the roadway. See Appendix D for more information on signal head placement for long-term operations.

PATA 706







8. Remove all existing, conflicting pavement markings and signing; restore permanent markings and signing when long-term operations are complete.
 - a) Stop lines shall be installed with all TTC signal long-term stationary operations. Remove lenses from conflicting raised pavement markers.
 - b) A no-passing zone shall be established when an existing passing zone is present. A temporary double yellow pavement marking line shall be installed throughout the entire length of the TTC zone. Place a No Passing Zone (W14-3) sign at the start of the temporary double yellow pavement marking line (across from the Road Work Ahead (W20-1) sign).
 - c) After TTC signals are removed, the stop lines and other temporary pavement markings shall be removed and the permanent pavement markings and signs restored.
9. All trailer-mounted portable TTC signal units used for stationary long-term operations must be interconnected via radio or hard wire to ensure fail-safe operation and proper functioning.
10. When not in operation, portable TTC signals shall be removed from the roadside or hooded with material described in Publication 408 Section 901.3(a). All TTC signs related to the TTC signal shall also be removed, covered or turned away from the roadway.
11. All signal heads shall flash red while the TTC signal operates in flashing mode.
12. Additional signs and devices shall be installed as required in Publications 212, 213, actual site conditions and as identified on an approved Traffic Control Plan.
13. Signal modules must be replaced in accordance with the manufacturers' recommendations, and a record of the change must be maintained by the user.
14. In the event of TTC signal failure, traffic must be controlled by flaggers or work must cease and the roadway reopened until adequate TTC can be reestablished.
15. The local or servicing police department must be provided with the name and telephone number of an emergency contact person who is available 24 hours per day, 7 days per week during the period of TTC signal usage.
16. Steps must be taken to ensure continued proper placement and to forestall possible vandalism of the portable TTC signal units. Tires and the 'hitch' must be removed from the trailer. Housings that contain controlling equipment, batteries, crank mechanisms for horizontal arms, and other mechanisms to adjust placement or operation must be locked to eliminate any tampering by unauthorized personnel.
17. PennDOT reserves the right to inspect each portable TTC signal. PennDOT also reserves the right to suspend operation of the portable TTC signal if the user willfully or negligently fails to comply with the conditions contained in Note 1 or fails to make any changes in the operation of the signal, or remove it, when so ordered by PennDOT. The user shall not make any change in the operation of the portable TTC signal as defined in the approved RRC signal permit without prior written approval of PennDOT.

PATA 706

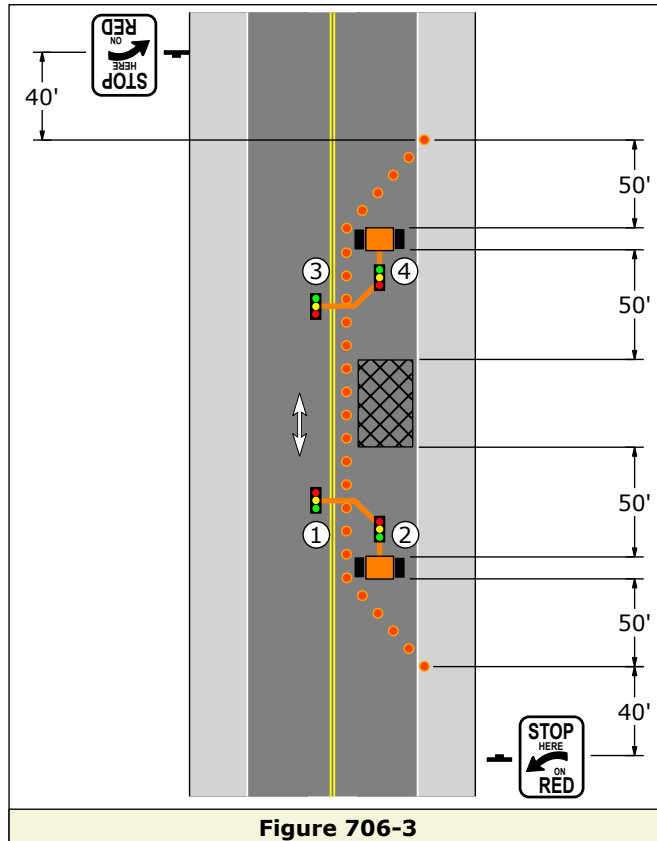
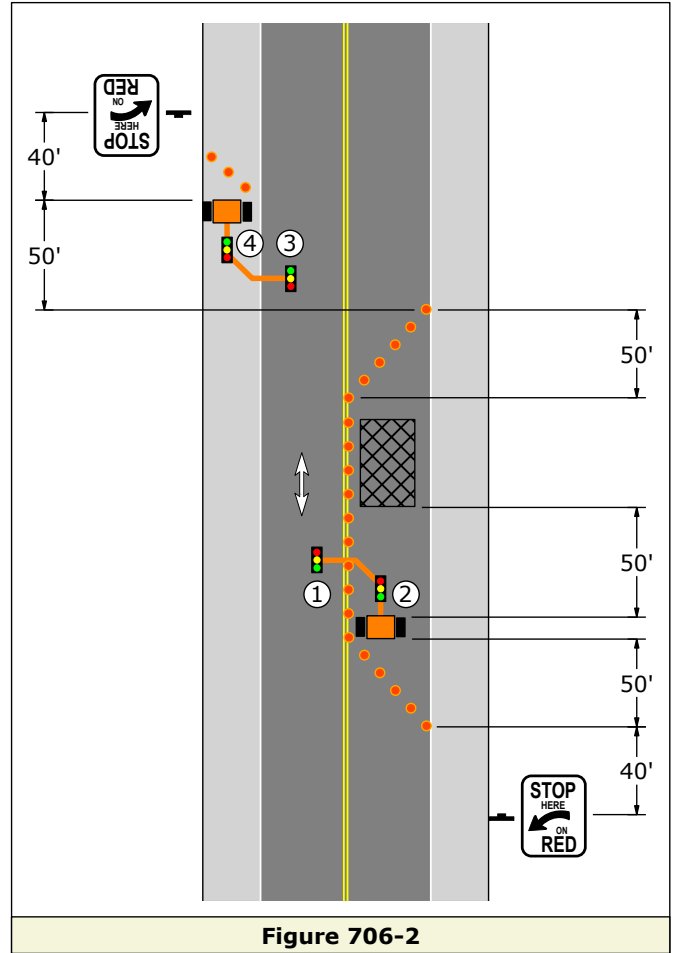
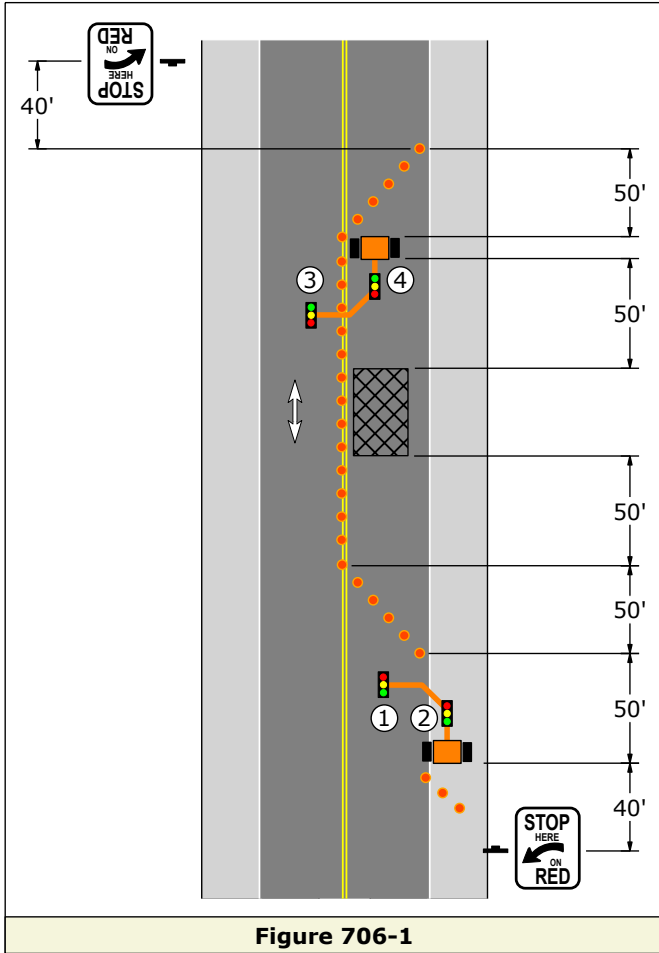
Signal Face Visibility (See Note 4)	
Normal Speed Limit (MPH)	Minimum Visibility Distance (FT)
25	215
30	270
35	325
40	390
45	460
50	540
55	625

Sign Spacing and Channelizing Device Spacing			
Speed	Channelizing Devices Spacing	Sign Spacing	
		Urban	Rural
S (MPH)	2S (Feet)	A (Feet)	A (Feet)
25	50	100 - 200	500 - 800
30	60	100 - 200	500 - 800
35	70	100 - 200	500 - 800
40	80	350 - 500	500 - 800
45	90	350 - 500	500 - 800
50	100	350 - 500	500 - 800
55	110	350 - 500	500 - 800

Taper Lengths and Minimum Number Of Channelizing Devices		
Speed	50' Per Lane Taper	
S (MPH)	Length (Feet)	Minimum Number Of Devices
25	50	6
30	50	6
35	50	6
40	50	6
45	50	6
50	50	6
55	50	6

Signs					
					
W20-1	W20-4	W3-3	W14-3	G20-2	R10-6AL

PATA 706 Alternate Trailer Locations


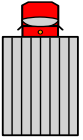





Hauling Operations

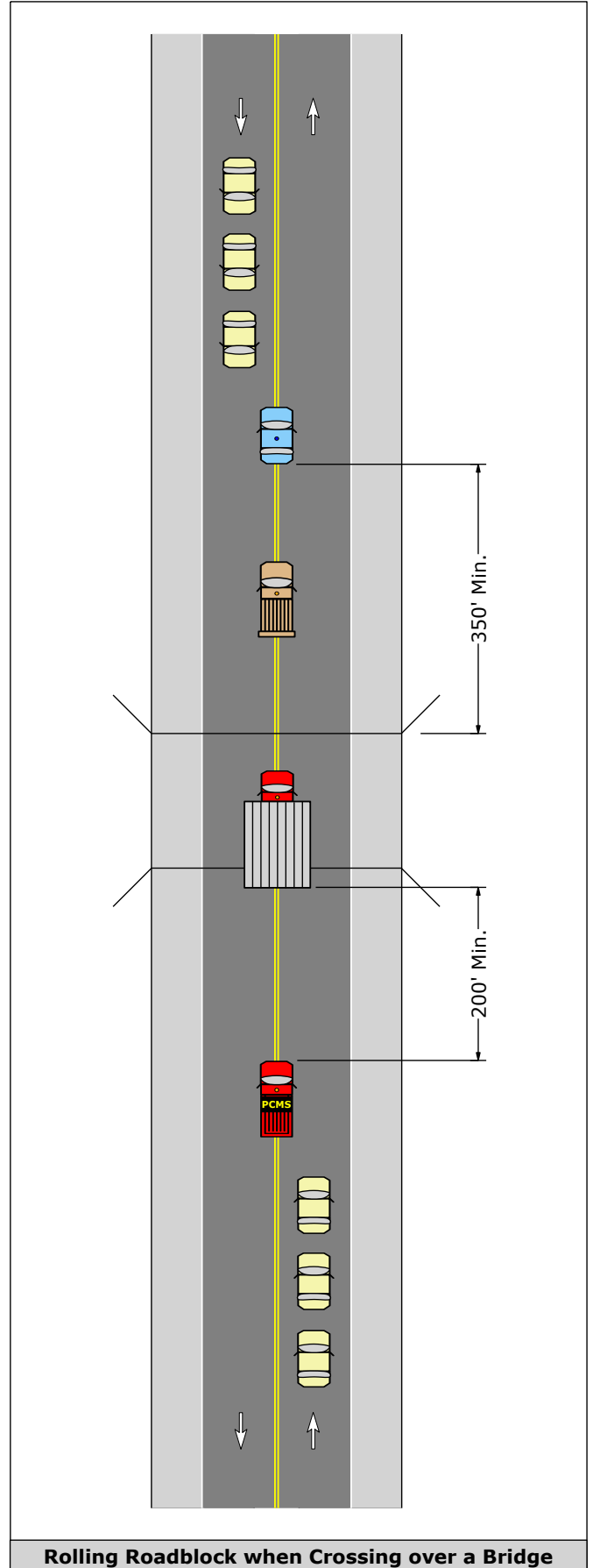
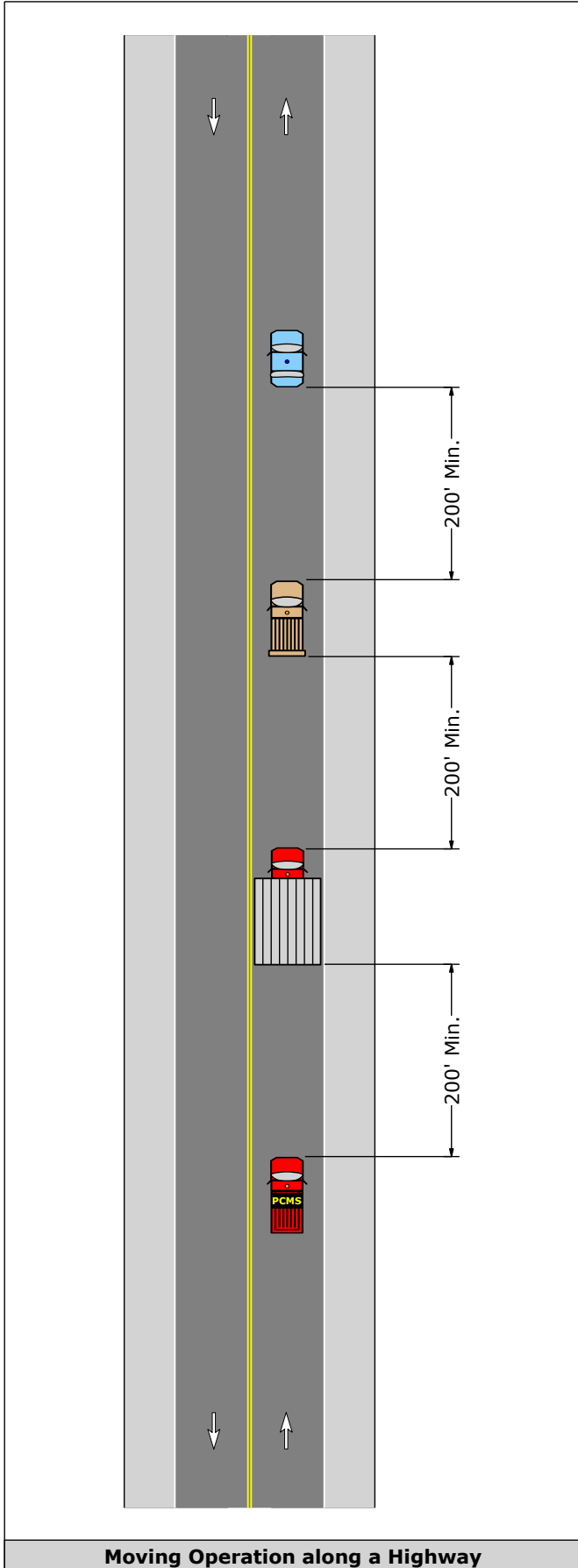
(PATA 800 Series)

PATA 801

1. If a static sign is used, it shall use minimum 12-inch, black legend on a fluorescent yellow retroreflective sheeting material. If a PCMS is used, it shall be of a type approved by the Department and listed in Publication 35 (Approved Constriction Materials - Bulletin 15).
2. The hauler shall have CB radios in all vehicles for communication, including one in the State Police Vehicle. One of the operators shall also have a cellular telephone for emergency purposes.


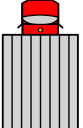




Symbol	Description
	PRIVATE ESCORT VEHICLE - This vehicle is provided by the hauler and shall be equipped with a flashing or revolving yellow light. When the State Police Vehicle is not used, this vehicle shall be used to stop the approaching traffic at a distance of at least 350' before the bridge, and then release the approaching traffic only after Superload or Non-Superload Vehicle has cleared the bridge and is in the normal travel lane. In order to stop traffic, it may be necessary to have someone use a red flag.
	SUPERLOAD OR NON-SUPERLOAD - This vehicle shall be equipped with two flashing or revolving yellow lights, one on the front and one on the back. This vehicle should be positioned either in the center or the right side of the roadway in accordance with the permit. When the State Police Vehicle is used, this vehicle should maintain a minimum distance behind Vehicle A of 200' or one bridge span in length, whichever is greater.
	SHADOW VEHICLE - The shadow vehicle shall be supplied and operated by the hauler. It shall be equipped with a flashing or revolving yellow light and a sign with the message "DO NOT PASS". The sign may be either a static sign or a PCMS, see Note 1. If a static sign is used, the sign shall be removed when it is not applicable. This vehicle should be positioned either in the center or on the right side of the roadway similar to the Superload or Non-Superload Vehicle. When on the bridge, the vehicle should maintain a minimum following distance behind the Superload or Non-Superload Vehicle of 200' or on the bridge span length, whichever is greater.
	STATE POLICE VEHICLE - This vehicle is only required for superloads. When used, the vehicle shall be a marked vehicle with activated revolving or flashing lights. The trooper in this vehicle should stop approaching traffic at a distance of at least 350' before the bridge. The trooper should release the approaching traffic only after the Superload or Non-Superload Vehicle has cleared the bridge and is in the normal travel lane.
	TRAFFIC UNRELATED TO OPERATIONS - This represents local traffic that may be impacted by the superload movement operations.

PATA 801

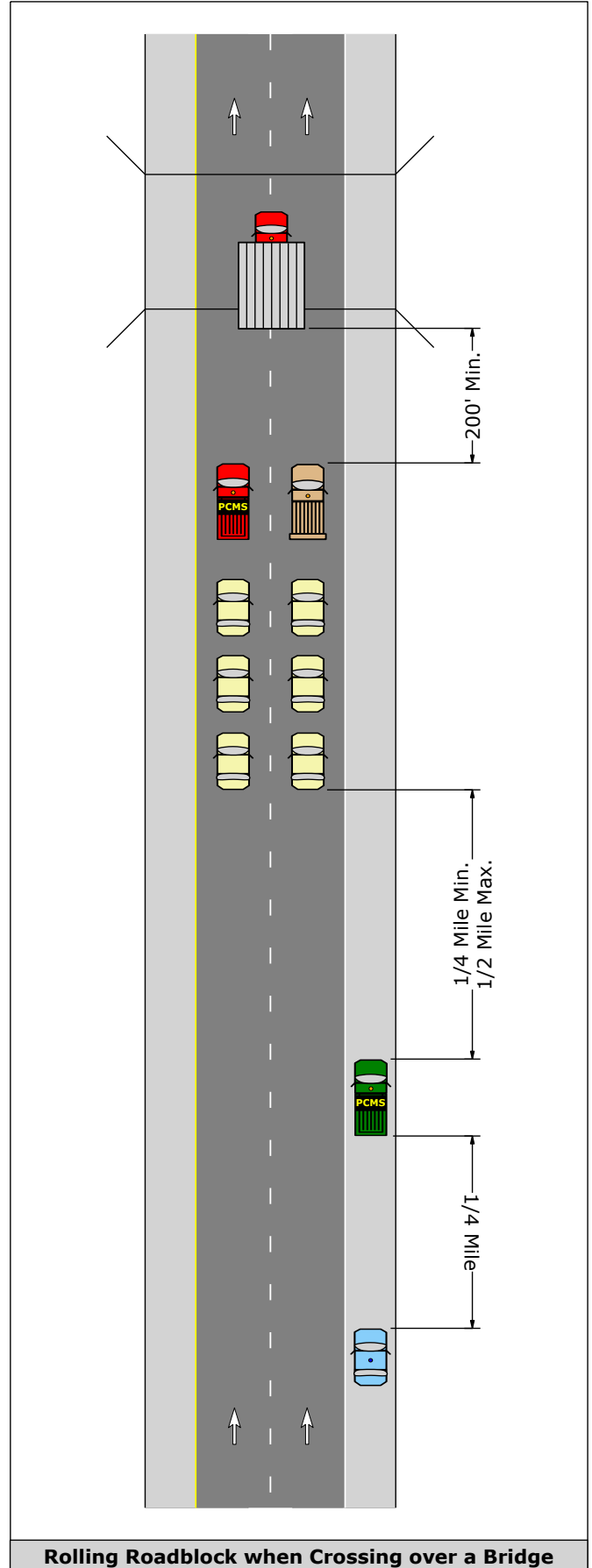
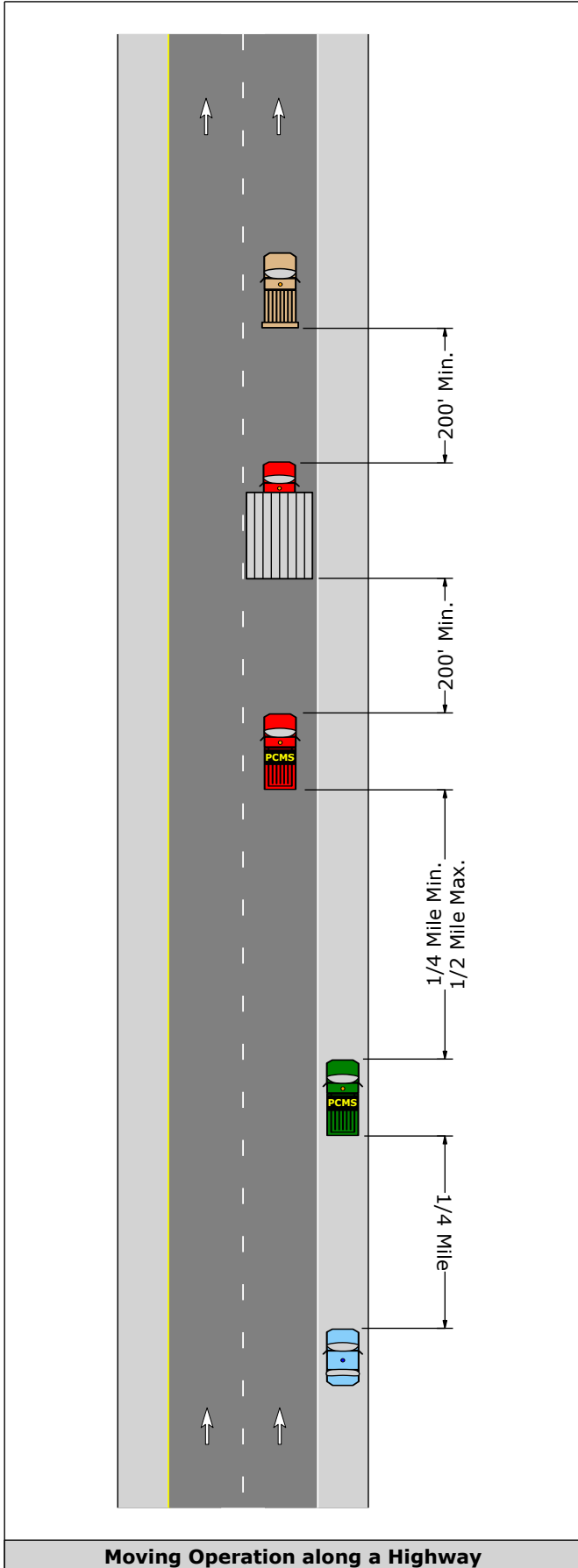


PATA 802

1. If used, the TMA and PCMS shall be of a type approved by the Department and listed in Publication 35 (Approved Construction Materials - Bulletin 15).
2. The hauler shall have CB radios in all vehicles for communication, including one in the State Police Vehicle. One of the operators shall also have a cellular telephone for emergency purposes.
3. When operating between locations with crawl speeds, all vehicles should normally be in the right lane. The PCMS should display messages such as "OVERSIZE LOAD" and "PASS WITH CARE" and/or "USE LEFT LANE".


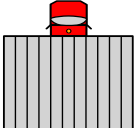




Symbol	Description
	PRIVATE ESCORT VEHICLE - This vehicle is provided by the hauler and shall be equipped with a flashing or revolving yellow light. The vehicle should normally be positioned on the right side of the roadway in advance of the Superload or Non-Superload Vehicle. However, prior to reaching the bridge, this vehicle may allow the Superload or Non-Superload Vehicle to pass in order to run parallel with the Shadow Vehicle and form a rolling roadblock.
	SUPERLOAD OR NON-SUPERLOAD - This vehicle shall be equipped with two flashing or revolving yellow lights, one on the front and one on the back. This vehicle should maintain a minimum distance behind the Private Escort Vehicle of 200' or one bridge span length, whichever is greater.
	SHADOW VEHICLE - The shadow vehicle shall be supplied and operated by the hauler. It shall be equipped with a flashing or revolving yellow light. A TMA and PCMS are recommended to be utilized. If used, they shall be of a type approved by the Department (see Note 1). The Shadow Vehicle should maintain a minimum distance behind the Superload or Non-Superload of 200' or one bridge span length, whichever is greater.
	QUEUE MONITORING VEHICLE - This vehicle is supplied by the hauler and positioned on the shoulder whenever possible. It shall be equipped with a flashing or revolving yellow light and a PCMS, see Note 1, alternately displaying preprogrammed messages "PREPARE TO STOP" and "SLOW DOWN".
	STATE POLICE VEHICLE - This vehicle is only required for superloads. When used, the vehicle shall be a marked vehicle with activated revolving or flashing lights. Whenever possible, the vehicle should be positioned on the shoulder
	TRAFFIC UNRELATED TO OPERATIONS - This represents local traffic that may be impacted by the superload movement operations.

PATA 802

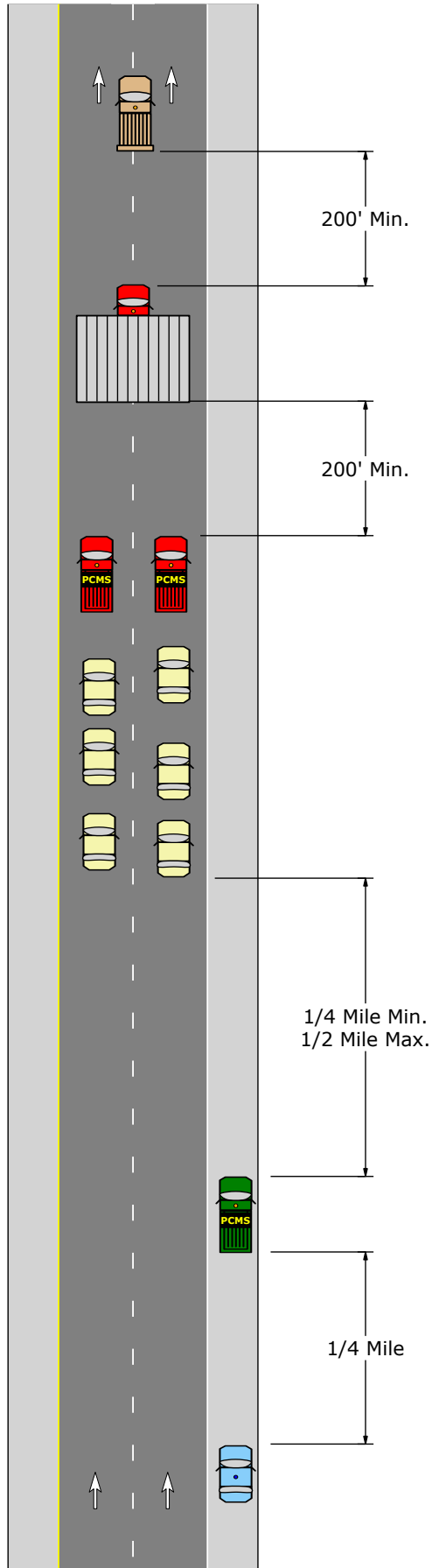


PATA 803

1. If used, the TMA and PCMS shall be of a type approved by the Department and listed in Publication 35 (Approved Construction Materials - Bulletin 15).
2. The hauler shall have CB radios in all vehicles for communication, including one in the State Police Vehicle. One of the operators shall also have a cellular telephone for emergency purposes.
3. When operating between locations with crawl speeds, all vehicles should normally be in the right lane. The PCMS should display messages such as "PASS WITH CARE" and/or "USE LEFT LANE".


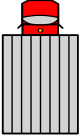




Symbol	Description
	PRIVATE ESCORT VEHICLE - This vehicle is provided by the hauler and shall be equipped with a flashing or revolving yellow light. The vehicle should maintain a distance of at least 200' in advance of the Superload or non-Superload Vehicle.
	SUPERLOAD OR NON-SUPERLOAD - This vehicle shall be equipped with two flashing or revolving yellow lights, one on the front and one on the back. This vehicle should maintain a minimum distance behind the Private Escort Vehicle of 200' or one bridge span length, whichever is greater.
	SHADOW VEHICLE - The shadow vehicle shall be supplied and operated by the hauler. It shall be equipped with a flashing or revolving yellow light. A TMA and PCMS are recommended to be utilized. If used, shall be of a type approved by the Department (see Note 1). The Shadow Vehicle should maintain a minimum distance behind the Superload or Non-Superload of 200' or one bridge span length, whichever is greater.
	QUEUE MONITORING VEHICLE - This vehicle is supplied by the hauler and shall be equipped with a flashing or revolving yellow light. The vehicle shall be equipped with a standard "OVERSIZE LOAD" (7'x18") sign and/or a PCMS that alternately displays the messages "PREPARE TO STOP" and "SLOW DOWN" with 10" minimum letter height. The sign(s) must be legible for at least 650'. Whenever possible, the vehicle should be positioned on the shoulder.
	STATE POLICE VEHICLE - This vehicle is only required for superloads. When used, the vehicle shall be a marked vehicle with activated revolving or flashing lights. Whenever possible, the vehicle should be positioned on the shoulder
	TRAFFIC UNRELATED TO OPERATIONS - This represents local traffic that may be impacted by the superload movement operations.

PATA 803

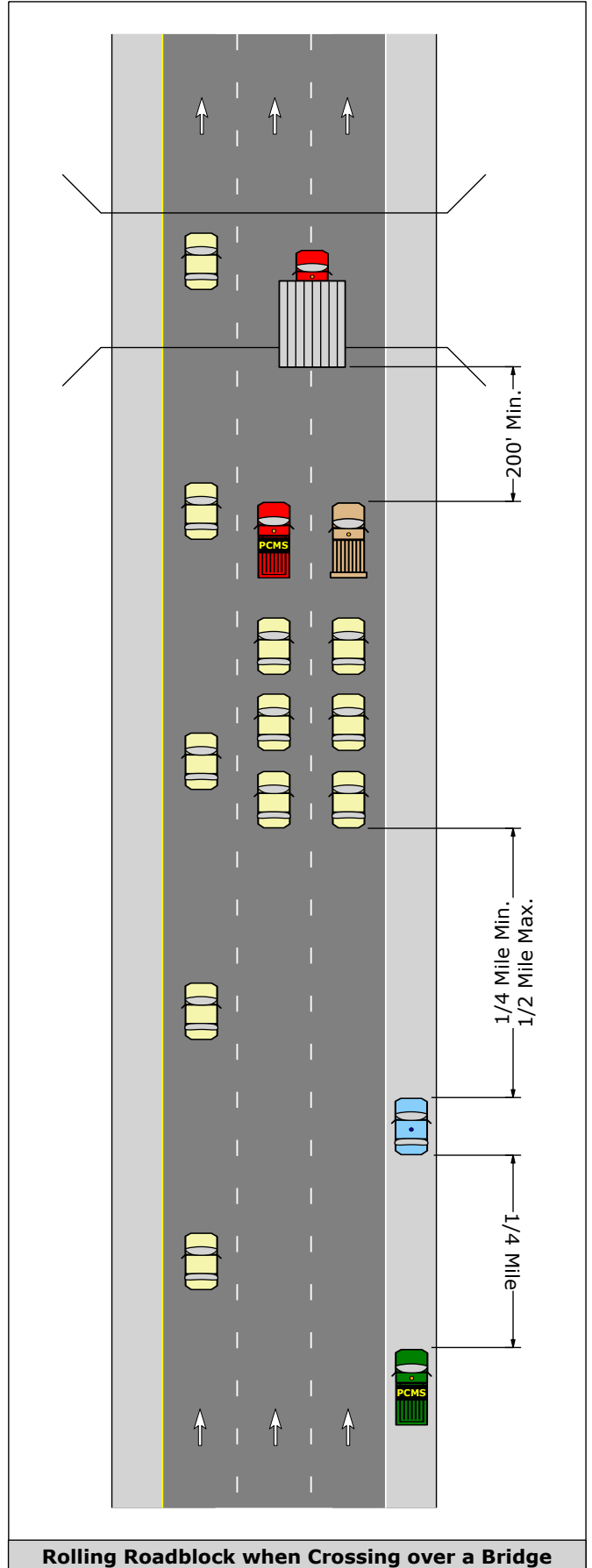
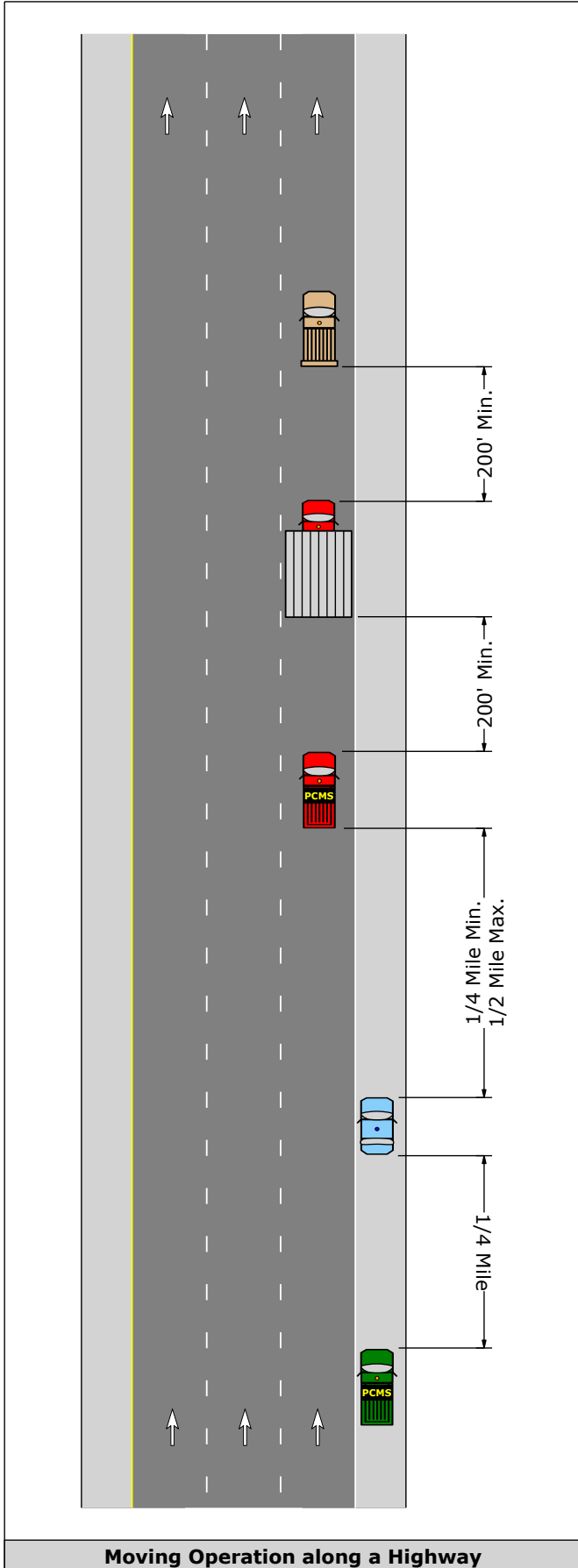


PATA 804

1. If used, the TMA and PCMS shall be of a type approved by the Department and listed in Publication 35 (Approved Construction Materials - Bulletin 15).
2. The hauler shall have CB radios in all vehicles for communication, including one in the State Police Vehicle. One of the operators shall also have a cellular telephone for emergency purposes.
3. When operating between locations with crawl speeds, all vehicles should normally be in the right lane unless superload width restricts the center lane then the Shadow Vehicle and Queue Monitoring Vehicle shall be in the center lane. The PCMS should display messages such as "PASS WITH CARE" and/or "USE LEFT LANE".


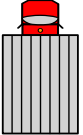




Symbol	Description
	PRIVATE ESCORT VEHICLE - This vehicle is provided by the hauler and shall be equipped with a flashing or revolving yellow light. The vehicle should normally be positioned on the right side of the roadway in advance of the Superload or Non-Superload Vehicle. However, prior to reaching the bridge, this vehicle may allow the Superload or Non-Superload Vehicle to pass in order to run parallel with the Shadow Vehicle and form a rolling roadblock.
	SUPERLOAD OR NON-SUPERLOAD - This vehicle shall be equipped with two flashing or revolving yellow lights, one on the front and one on the back. This vehicle should maintain a minimum distance behind the Private Escort Vehicle of 200' or one bridge span length, whichever is greater.
	SHADOW VEHICLE - The shadow vehicle shall be supplied and operated by the hauler. It shall be equipped with a flashing or revolving yellow light. A TMA and PCMS are recommended to be utilized. If used, shall be of a type approved by the Department (see Note 1). The Shadow Vehicle should maintain a minimum distance behind the Superload or Non-Superload of 200' or one bridge span length, whichever is greater.
	QUEUE MONITORING VEHICLE - This vehicle is supplied by the hauler and positioned on the shoulder whenever possible. It shall be equipped with a flashing or revolving yellow light and a PCMS, see Note 1, alternately displaying preprogrammed messages "PREPARE TO STOP" and "USE LEFT LANE" or "DO NOT PASS".
	STATE POLICE VEHICLE - This vehicle is only required for superloads. When used, the vehicle shall be a marked vehicle with activated revolving or flashing lights. Whenever possible, the vehicle should be positioned on the shoulder
	TRAFFIC UNRELATED TO OPERATIONS - This represents local traffic that may be impacted by the superload movement operations.

PATA 804

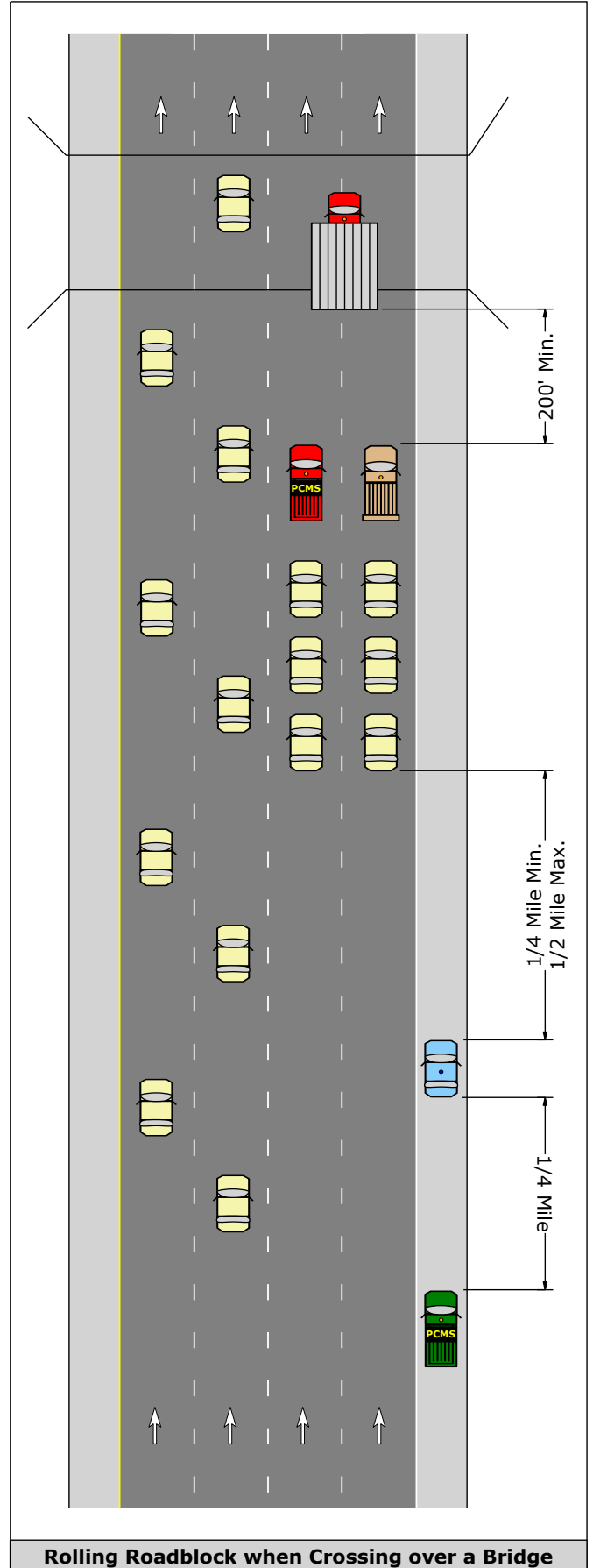
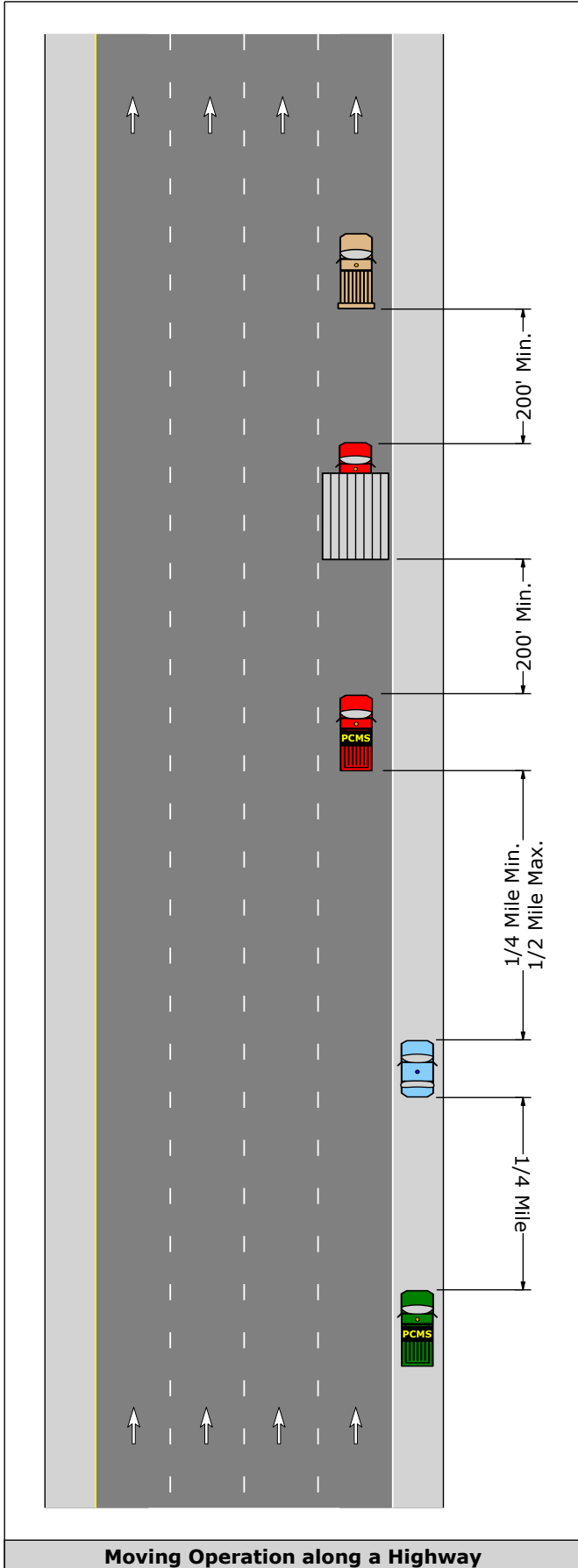


PATA 805

1. If used, the TMA and PCMS shall be of a type approved by the Department and listed in Publication 35 (Approved Construction Materials - Bulletin 15).
2. The hauler shall have CB radios in all vehicles for communication, including one in the State Police Vehicle. One of the operators shall also have a cellular telephone for emergency purposes.
3. When operating between locations with crawl speeds, all vehicles should normally be in the right lane unless superload width restricts the center lane then the Shadow Vehicle and Queue Monitoring Vehicle shall be in the center lane. The VMS should display messages such as "OVERSIZE LOAD" and "PASS WITH CARE" and/or "USE LEFT LANES".

Symbol	Description
	PRIVATE ESCORT VEHICLE - This vehicle is provided by the hauler and shall be equipped with a flashing or revolving yellow light. The vehicle should normally be positioned on the right side of the roadway in advance of the Superload or Non-Superload Vehicle. However, prior to reaching the bridge, this vehicle may allow the Superload or Non-Superload Vehicle to pass in order to run parallel with the Shadow Vehicle and form a rolling roadblock.
	SUPERLOAD OR NON-SUPERLOAD - This vehicle shall be equipped with two flashing or revolving yellow lights, one on the front and one on the back. This vehicle should maintain a minimum distance behind the Private Escort Vehicle of 200' or one bridge span length, whichever is greater.
	SHADOW VEHICLE - The shadow vehicle shall be supplied and operated by the hauler. It shall be equipped with a flashing or revolving yellow light. A TMA and PCMS are recommended to be utilized. If used, shall be of a type approved by the Department (see Note 1). The Shadow Vehicle should maintain a minimum distance behind the Superload or Non-Superload of 200' or one bridge span length, whichever is greater.
	QUEUE MONITORING VEHICLE - This vehicle is supplied by the hauler and positioned on the shoulder whenever possible. It shall be equipped with a flashing or revolving yellow light and a PCMS, see Note 1, alternately displaying preprogrammed messages "PREPARE TO STOP" and "USE LEFT LANE" or "DO NOT PASS".
	STATE POLICE VEHICLE - This vehicle is only required for superloads. When used, the vehicle shall be a marked vehicle with activated revolving or flashing lights. Whenever possible, the vehicle should be positioned on the shoulder
	TRAFFIC UNRELATED TO OPERATIONS - This represents local traffic that may be impacted by the superload movement operations.

PATA 805



Blank Page

Appendix A

Appendix A TTC Sign Nomenclatures and Sizes

Nomenclature	Description	Conventional Highway		Freeway
		Single Lane	Multi-Lane	
R1-1	STOP	30x30	36x36	36x36 or 48x48
R1-1-2	RAMP	36x18		36x18 or 48x24
R1-1-3	RAMP STOP SIGN (Roll Up)	36x48		48x60
R1-1-4	RAMP YIELD SIGN (Roll Up)	36x48		48x60
R1-2	YIELD	36x36	48x48	48x48 or 60x60
R2-1	SPEED LIMIT	24x30	30x36	48x60
R3-2	NO LEFT TURN	24x24	36x36	36x36
R3-9CP	BEGIN Plaque	24x12 / 30x15 / 36x18		
R3-9DP	END Plaque	24x12 / 30x15 / 36x18		
R4-7	KEEP RIGHT	24x30		48x60
R4-9	STAY IN LANE	24x30		48x60
R9-9	SIDEWALK CLOSED	24x12		
R9-10	SIDEWALK CLOSED USE OTHER SIDE	24x12		
R9-11A	SIDEWALK CLOSED CROSS HERE	24x12		
R10-6AL	STOP HERE ON RED (Left Arrow)	24x30		
R11-2	ROAD CLOSED	48x30		
R11-2-1	BRIDGE CLOSED	48x30		
R11-3A	ROAD CLOSED - LOCAL TRAFFIC ONLY	60x30		
R11-3B	BRIDGE OUT - LOCAL TRAFFIC ONLY	48x24		
R11-4	ROAD CLOSED TO THRU TRAFFIC	60x30		
R22-1	WORK ZONE - TURN ON HEADLIGHTS	48x36		72x48
W1-3L	LEFT REVERSE TURN	30x30	36x36	48x48
W1-3R	RIGHT REVERSE TURN	30x30	36x36	48x48
W1-4L	LEFT REVERSE CURVE	30x30	36x36	48x48
W1-4R	RIGHT REVERSE CURVE	30x30	36x36	48x48
W3-1	STOP AHEAD	36x36		48x48
W3-2	YIELD AHEAD	36x36		48x48
W3-3	SIGNAL AHEAD	36x36		48x48
W3-4	BE PREPARED TO STOP	36x36		48x48
W4-1L	MERGE LEFT	36x36		48x48
W4-1R	MERGE RIGHT	36x36		48x48
W4-2L	LEFT LANE ENDS - Pavement Width Transition	36x36		48x48
W4-2R	RIGHT LANE ENDS - Pavement Width Transition	36x36		48x48
W5-4	RAMP NARROWS	36x36		48x48
W5-5	LANES SHIFT	36x36		48x48

Appendix A TTC Sign Nomenclatures and Sizes

Nomenclature	Description	Conventional Highway		Freeway
		Single Lane	Multi-Lane	
W8-101	RUMBLE STRIPS AHEAD	36x36		48x48
W9-3	CENTER LANE CLOSED	36x36		48x48
W11-2	PEDESTRIAN	30x30	36x36	
W12-1	DOUBLE ARROW	36x36		
W14-3	NO PASSING ZONE (pennant)	48x36		
W16-7P	DIAGONAL DOWNWARD POINTING ARROW Plaque	24x12		
W16-9P	AHEAD Plaque	24x24	36x24	
W20-1	ROAD WORK	36x36		48x48
W20-2	ADVANCE DETOUR	36x36		48x48
W20-3	ROAD CLOSED	36x36		48x48
W20-4	ONE LANE ROAD	36x36		48x48
W20-5AL	LEFT TWO LANES CLOSED		48x48	
W20-5AR	RIGHT TWO LANES CLOSED		48x48	
W20-5L	LEFT LANE CLOSED	36x36		48x48
W20-5R	RIGHT LANE CLOSED	36x36		48x48
W20-7	FLAGGER Symbol	36x36		
W20-101	LANES BLOCKED AHEAD	36x36		48x48
W21-5	SHOULDER WORK	30x30	36x36	48x48
W21-5BL	LEFT SHOULDER CLOSED	30x30	36x36	48x48
W21-5BR	RIGHT SHOULDER CLOSED	30x30	36x36	48x48
W21-5-1	FRESH OIL & CHIPS	36x36		
W21-14	MOWING NEXT XX MI	36x36		48x48
W21-16	NO PAVEMENT MARKINGS	36x36		48x48
W21-19	ACTIVE WORK ZONE WHEN FLASHING	36x36		48x48
W21-20	END ACTIVE WORK ZONE	36x36		48x48
W21-101	RAMP WORK AHEAD			48x48
W23-101	THIS BRIDGE TO BE CLOSED FOR MAINTENANCE	96x48		
W24-1L	SINGLE LANE DOUBLE REVERSE CURVE LEFT	30x30	36x36	48x48
W24-1R	SINGLE LANE DOUBLE REVERSE CURVE RIGHT	30x30	36x36	48x48
W25-4	EXIT Gore Sign (white-on-green or bland-on-orange)			48x48
G20-1	LENGTH OF WORK	60x30		
G20-1-2	ROAD WORK TO BEGIN NEXT WEEK	48x36		
G20-2	END ROAD WORK	36x18		60x24
G20-4	PILOT CAR - FOLLOW ME	36x18		
G20-5AP	WORK ZONE Plaque	24x18 / 36x24 / 48x36		

Appendix A TTC Sign Nomenclatures and Sizes

Nomenclature	Description	Conventional Highway		Freeway
		Single Lane	Multi-Lane	
G20-6	DETOUR FOLLOW RED ARROW	48x30		
G20-6-1	RED ARROW	24x12		
G20-6-2	DETOUR (in red text)	24x12		
G80-1	LANE CLOSED DO NOT PASS	48X24		84x36
M1-4	U.S. ROUTE MARKER (one or two digits)	24x24		36x36
M1-4	U.S. ROUTE MARKER (three digits)	36x24		45x36
M1-5	PA. ROUTE MARKER (one or two digits)	24x24		36x36
M1-5	PA. ROUTE MARKER (three digits)	24x24		45x36
M3-1	NORTH (marker)	24x12		30x15
M3-2	EAST (marker)	24x12		30x15
M3-3	SOUTH (marker)	24x12		30x15
M3-4	WEST (marker)	24x12		30x15
M4-6	END (marker)	24x12		30x15
M4-8A	END DETOUR	24x18		36x30
M4-9L	DETOUR, LEFT	30x24		48x36
M4-9R	DETOUR, RIGHT	30x24		48x36
M4-9S	DETOUR, STRAIGHT	30x24		48x36
M4-9SL	LEFT ADVANCE DETOUR	30x24		48x36
M4-9SR	RIGHT ADVANCE DETOUR	30x24		48x36
M4-10L	DETOUR ARROW, LEFT	48x18		
M4-10R	DETOUR ARROW, RIGHT	48x18		
M5-1L	ADVANCE 90 DEGREE LEFT TURN (marker)	21x15		30x18
M5-1R	ADVANCE 90 DEFREE RIGHT TURN (marker)	21x15		30x18
M6-1	90 DEGREE TURN (marker)	21x15		30x18
M6-3	STRAIGHT THROUGH (marker)	21x15		30x18
D14-103	ALL TRAFFIC MUST EXIT (roll up sign may be 48x48)			60x60

Appendix B

2014 Traffic Sign Retroreflective Sheeting Identification Guide



This document is intended to help identify sign sheeting materials for rigid signs and their common specification designations. It is not a qualified product list. FHWA does not endorse or approve sign sheeting materials. Many other sheeting materials not listed here are available for delineation and construction/work zone uses.

Many sign sheeting materials have watermarks and/or patterns that are used to identify the material type and manufacturer. The watermarks shown in this guide have been enhanced. The watermarks will be less visible in practice and may not be present on smaller pieces of sheeting due to the spacing.

Retroreflective Sheeting Materials Made with Glass Beads

Example of Sheeting (Shown to scale)								
ASTM D4956-04	I	II	II	III	III	III	III	III
ASTM D4956-13	I	II	II	III	III	III	III	III
AASHTO M268-13	(1)	(1)	(1)	A	A	A	A	A
Manufacturer	Several companies	Avery Dennison®	Nippon Carbide	3M™	ATSM, Inc.	Avery Dennison®	Nippon Carbide	ORAFOL Americas Inc
Brand Name	Engineer Grade	Super Engr Grade	Super Engr Grade	High Intensity	High Intensity	High Intensity	High Intensity	ORALITE® High Intensity
Series	Several	T-2000	15000	2800 3800	ATSM HI	T-5500	N500	5800
NOTES:	(2) (8)	(3) (4) (9)	(4)	(3) (4) (9)	(4)	(4)	(4)	(4)
1) Sheeting material does not meet minimum AASHTO classification criteria. 2) Glass Bead Engineer Grade sheeting is uniform without any patterns or identifying marks. 3) Material no longer sold in the United States as of the date of this publication. 4) Section 2A.08 of the 2009 MUTCD (http://mutcd.fhwa.dot.gov) does not allow this sheeting type to be used for new legends on green signs.								

- ASTM D4956-04 is referenced in Table 2A-3 of the 2009 MUTCD.
- ASTM D4956-13 is the most current ASTM sign sheeting specification (the 2013 version is designated by "-13").
- AASHTO M268-13 is the most current AASHTO specification (the 2013 version is designated by "-13").

Manufacturer Contact Information

3M - http://www.3m.com/roadwaysafety	ATSM, Inc. - http://www.atsminc.com
Avery Dennison - http://www.reflectives.averydennison.com	Nippon Carbide - http://www.nikkalite.com
ORAFOL Americas Inc. - http://www.orafolamericas.com	

FHWA Publication Number: FHWA-SA-14-022. You may download and print the electronic version of this document, available at www.fhwa.dot.gov/retro

2014 Traffic Sign Retroreflective Sheeting Identification Guide

This document is intended to help identify sign sheeting materials for rigid signs and their common specification designations. It is not a qualified product list. FHWA does not endorse or approve sign sheeting materials. Many other sheeting materials not listed here are available for delineation and construction/work zone uses. Many sign sheeting materials have watermarks and/or patterns that are used to identify the material type and manufacturer. The watermarks shown in this guide have been enhanced. The watermarks will be less visible in practice and may not be present on smaller pieces of sheeting due to the spacing.

Retroreflective Sheeting Materials Made with Micro-Prisms

Example of Sheeting (Shown to scale)								
D4956-04	(5)	(5)	III, IV	III, IV, X	(5)	(5)	(5) / X	(5)
D4956-13	I	I	III, IV	III, IV	III, IV	III, IV	VIII	VIII
M268-13	(6)	(6)	B	B	B	B	B	B
Manufacturer	3M™	Avery Dennison®	Avery Dennison®	3M™	ORAFOL Americas Inc	Nippon Carbide	Nippon Carbide	3M™
Brand Name	EGP	PEG	HIP	HIP	ORALITE® HIP	HIM	Crystal Grade	Reflective Sheeting
Series	3430	T-2500	T-6500	3930	5900/5930	CRG 94000	CRG 92000	3940
NOTES:	(8)	(8)						

Example of Sheeting (Shown to scale)								
D4956-04	VIII	VII, VIII, X	IX	IX	(5)	(5)	(5)	(5)
D4956-13	VIII	VIII	IX	IX	IX	IX	XI	XI
M268-13	B	(7)	B	B	B	B	D	D
Manufacturer	Avery Dennison®	3M™	3M™	Avery Dennison®	Nippon Carbide	ORAFOL Americas Inc	3M™	Avery Dennison®
Brand Name	MVP Prismatic	Diamond Grade™ LDP	Diamond Grade™ VIP	OmniView™	Crystal Grade	ORALITE®	Diamond Grade™ DG3	OmniCube™
Series	T-7500	3970	3990	T-9500	95000	7900	4000	T-11500
NOTES:		(9)			(9)			

- 5) Material was either unavailable in 2005 (previous version of this Guide) or unassigned in the 2004 version of ASTM D4956.
 6) Sheeting material does not meet minimum AASHTO classification criteria.
 7) Material has been discontinued prior to AASHTO M268-10.
 8) Section 2A.08 of the 2009 MUTCD (<http://mutcd.fhwa.dot.gov>) does not allow this sheeting type to be used for new yellow or orange signs, or new legends on green signs.
 9) Material no longer sold in the United States as of the date of this publication.

Resources

Federal Highway Administration – <http://www.fhwa.dot.gov/retro>
 Manual on Uniform Traffic Control Devices (MUTCD) – <http://mutcd.fhwa.dot.gov>
 Texas A&M Transportation Institute – <http://tti.tamu.edu/visibility>
 ASTM – <http://www.astm.org> AASHTO – <http://www.transportation.org>

Blank Page

Appendix C

Source: ATSSA, Quality Guidelines for Temporary Traffic Control Devices and Features

Quality Guidelines

TTC Sign Faces



ACCEPTABLE

Sign is new or like new. There may be some abrasions on sign face, legend or border, but very little loss of lettering. Sign is retroreflective to show the same shape and similar color by both day and night.



MARGINAL

Sign legend is completely legible per the design criteria of the MUTCD despite many surface abrasions on the sign face, individual letters or within the border. Sign surface is free of any residue. Background may be a little faded, but is retroreflective.



UNACCEPTABLE

Sign legibility is diminished as some letters are obscured or damaged more than 50% from new condition. Asphalt splatter, cement slurry or other material on the sign face is unacceptable. There is considerable color fading and sign is not retroreflective.

Sign Coverings



ACCEPTABLE

Sign is fully covered with black rubber roofing material (45 mils thick) or black vinyl coated polyester material having min. weight of 18 ounces per square yard (20 mils thick). Tape is not applied to the sign face and sign is not damaged during the process of covering or uncovering.



MARGINAL

Sign is mostly covered with black rubber roofing material (45 mils thick) or black vinyl coated polyester material having min. weight of 18 ounces per square yard (20 mils thick). Covering is sized to match the sign so small parts of the sign background are visible, but legend is not visible.



UNACCEPTABLE

Only the legend is covered and/or large areas of sign face is visible. Material is not opaque thus allowing sign legend to be seen. Unapproved material such as burlap or plastic trash bags are taped or clipped to the sign. Plywood or other rigid signs are placed over the sign face.

Quality Guidelines

Personal Protective Equipment (Safety Vests)



ACCEPTABLE

New or like-new high-visibility safety apparel meeting Class 2 or 3 performance requirements found in the ANSI/ISEA 107-2004 or current publication. Safety apparel is not faded or soiled, has excellent color contrast and retroreflectivity.



MARGINAL

Safety apparel has slightly faded colors or is slightly soiled. Retroreflective material is in good condition.



UNACCEPTABLE

Safety apparel is significantly soiled and/or material is badly faded with poor color contrast. Retroreflective material is deteriorated or damaged and has little to no reflective qualities.

Stop/Slow Paddles



ACCEPTABLE

Both sign faces are in new or like new condition. Shaft is tall enough to provide at least 72" from the road surface to the bottom of the Stop/Slow sign faces. Sign is retroreflective to show the same shape and similar color by both day and night.



MARGINAL

Sign legend is completely legible per the design criteria of the MUTCD. Few scratches or surface abrasions may exist on the sign face or background, but do not effect recognition of the sign or the retroreflectivity. Paddle length provides minimum height of 72" from the road surface to the



UNACCEPTABLE

Either side of the Stop/Slow sign faces have foreign material such as tar splatter, tape, concrete residue, etc. Sign sheeting is peeling or has reduced retroreflective properties. Shaft length provides less than 72" height from the road surface to the bottom of the Stop/Slow sign faces, regardless of sign condition.

Quality Guidelines

Channelizing Devices - Cones (28" Min to 36" Max.)



ACCEPTABLE

New or like-new cones have the conical shape and must be freestanding in its normal position. Surface has no punctures or abrasions and has minimal asphalt splatter, cement slurry or other foreign material. Two retroreflective bands provide high-visibility.



MARGINAL

Cones maintain the conical shape, however the surface has some asphalt splattering or otherwise shows some wear from use. Two retroreflective bands are mainly clear, but may have slight tears or scratches while still providing good visibility.



UNACCEPTABLE

Cones do not give the appearance of a well maintained TTC device. Punctures or a large portion of the cone surface is marred with the presence of asphalt splatter or other foreign material. At least one retroreflective band is missing or badly damaged. Cone may not be able to remain completely upright.

Channelizing Devices - Cones (42")



ACCEPTABLE

New or like-new cones have the clearly identifiable shape and must be freestanding in its normal position. Surface has no punctures or abrasions and has minimal asphalt splatter or other foreign material. Four retroreflective bands (two alternating white and orange) provide high-visibility.



MARGINAL

Cones maintain the original shape, however the surface has some asphalt splattering or otherwise shows some wear from use. Four retroreflective bands are mainly clear, but may have slight tears or scratches while still providing good visibility.



UNACCEPTABLE

Cones do not give the appearance of a well maintained TTC device. Large areas of the cone surface are marred with the presence of asphalt splatter or other foreign material or may have punctures. At least one retroreflective band is missing or badly damaged. Cone may not be able to remain upright.

Quality Guidelines

Channelizing Devices - Vertical Panels



ACCEPTABLE

Panel is new or like new with no visible damages. Panel remains in completely vertical while attached to the base. Orange and white stripes on retroreflective sheeting displays high visibility.



MARGINAL

Panel surface has numerous surface abrasions and perhaps slight color fading is evident. Panel remains vertical while freestanding on the base. Most of the surface is free of tar splatter and most of the retroreflective sheeting is intact with a few scratches.



UNACCEPTABLE

Sheeting displays obvious loss of retroreflectivity, damage or color fading. Surface has been fouled with tar splatter, concrete slurry or other foreign matter. Panel is not plumb when freestanding on its base.

Channelizing Devices - Drums



ACCEPTABLE

Drum is new or in like new condition. Surface has no punctures or abrasions and has minimal asphalt splatter or other foreign material. Four retroreflective bands (two alternating white and orange) provide high-visibility.



MARGINAL

Drum maintains the original shape. It may be dented if dent is repairable or it may be evident that drum was previously dented. A minor percentage of surface area has asphalt splattering or other foreign matter. Four retroreflective bands are mainly clear, but may have slight tears or scratches.



UNACCEPTABLE

Drums do not give the appearance of a well maintained TTC device. At least one retroreflective band is missing or badly damaged. Large areas of the surface are marred with the presence of tar or other splatter. Drum does not have the same shape or color during both daylight and nighttime.

Quality Guidelines

Rails on Type 1, 2, or 3 Barricades



ACCEPTABLE

New or like-new rails are straight and have retroreflective sheeting that displays high-visibility. Panels are not damaged or deformed. Orange and white stripes display vivid contrast during daytime and nighttime conditions.



MARGINAL

Color fading is evident on the face of retroreflective sheeting. There may be surface abrasions or slight tears in sheeting, but each rail has stripes that provide good contrast and are reflective. Some asphalt splatter or foreign matter may be present on a minor percentage of the total area.



UNACCEPTABLE

The surface is damaged or a high percentage of the sheeting is covered with foreign material. Wear from long periods of use is evident. Panels have been broken or do not provide the same amount of square inches of retroreflective area as when they were new.

PCMS Display Board



ACCEPTABLE

100% of the pixels per character operate properly. PCMS message is completely visible and legible.



MARGINAL

PCMS message display has at least 90% of the pixels per character operating properly. Message is still legible and easily understood.



UNACCEPTABLE

Less than 90% of the pixels making up all characters or symbols are operating properly. Message may not be comprehensible.

Quality Guidelines

Arrow Board Lamps or LED Lights (Merge Mode)



ACCEPTABLE

All lamps or led lights are flashing yellow. All are functioning properly within the arrowhead. One lamp or light may be out within the arrow stem. All operating lights have the capability of dimming brightness to 50% of full brilliance.



MARGINAL

All lamps or led lights are flashing yellow. All are functioning properly within the arrowhead. Two or fewer lamps or lights are out within the arrow stem. All operating lights have the capability of dimming brightness to 50% of full brilliance.



UNACCEPTABLE

Lamps or led lights display a color other than yellow. Any yellow lamps or lights out within the arrowhead, or more than two within the arrow stem. Lamps or lights and not capable of dimming to 50% of full brilliance.

Arrow Board Lamps or LED Lights (Caution Mode)



ACCEPTABLE

All lamps or led lights are flashing yellow and functioning properly with the capability of dimming brightness to 50% of full brilliance. All lamps work for the Alternating Diamond pattern (not shown).



MARGINAL

No more than one lamp or led light is out while other lamps or lights are flashing yellow with the capability of dimming brightness to 50% of full brilliance. One lamp may be out for the Alternating Diamond pattern (not shown).



UNACCEPTABLE

More than one lamp or led light is out while other lamps or lights are flashing yellow with the capability of dimming brightness to 50% of full brilliance. More than one lamp out for the Alternating Diamond pattern (not shown).

Quality Guidelines

Temporary Concrete Barrier

Concrete barrier to be used in TTC areas must be visually inspected prior to its reuse and placement. Any element showing any one of the following discrepancies shall not be installed (refer to images below).

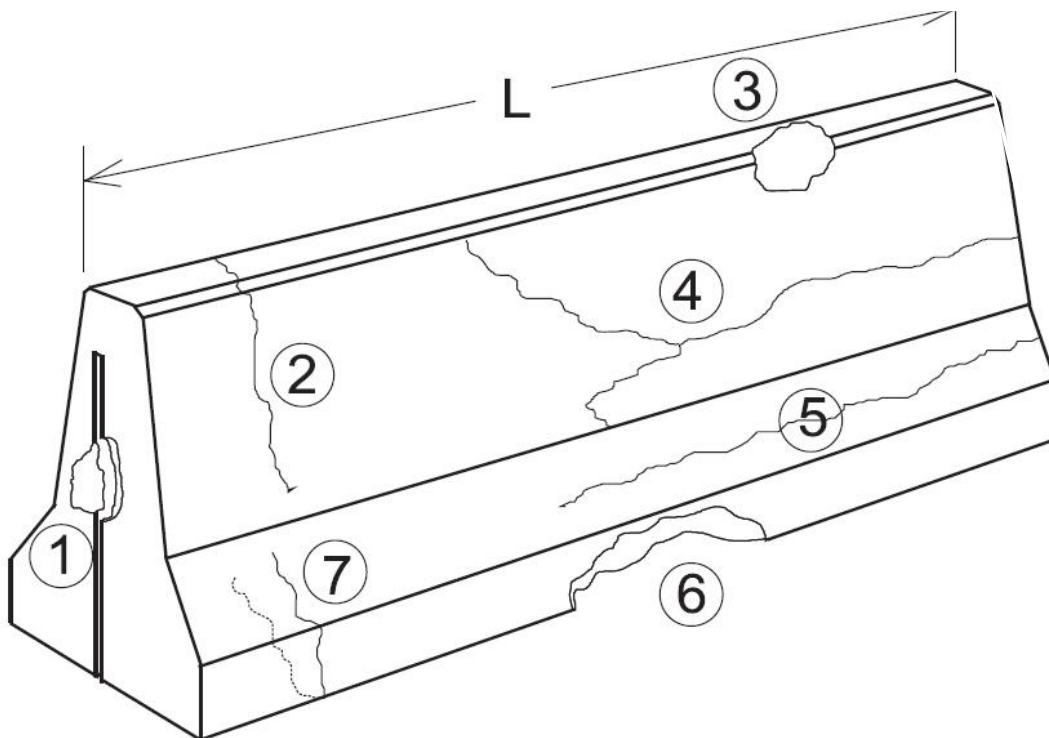
1. Cracked or destroyed slot and plate connection where more than 25% is missing or broken.
2. Crack on top which runs down either vertical face for more than 16 inches.
3. Chip on top or vertical face which is more than 1 square foot in area and/or 2 inches deep; smaller areas and depths can be field patched. Chips less than one inch depth will not require attention.
4. Horizontal crack in web which is greater than $L/2$ or any length that forms a Y with arms greater than 12 inches.
5. Horizontal crack in sloping area that is greater than $L/2$ and/or intersects a vertical crack.
6. Chip on vertical curb greater than 1 square foot and/or 3 inches deep; smaller areas and depths can be field patched. Chips less than one inch depth will not require attention.
7. Vertical crack across bottom and up curb into sloping face.

"Crack" is defined as an opening of at least 1/8 inch, measured with a feeler gauge when barrier is at rest or in place.

Delineators shall be applied to temporary concrete barrier in accordance with TC-8604 standards (Publication 111).

Continuous white or yellow 6 inch wide pavement markings may be installed on the lower sloped surface in lieu of placing temporary edge line pavement markings on the road surface. The line may be any approved paint pavement marking or tape that satisfies the minimum retroreflectivity requirements.

Barrier must be thoroughly cleaned by high-pressure water blasting before applying pavement markings. If barrier has markings from a previous deployment, retroreflectivity must be measured and deemed adequate prior to acceptance. Inacceptable markings shall be removed prior to applying new markings.



Appendix D

Traffic Signals Documentation Type Index

Temporary Traffic Control Signal Requirements and Timeframes
TE 952P: Application for Permit to Operate Temporary Traffic Control Signals
Application Instructions for Permit to Operate Temporary Traffic Control Signals
Example: Application for Permit to Operate Temporary Traffic Control Signals
Guidelines for the Selection of Temporary Traffic Control Signals in Work Zones
Design Guidelines For Long-Term Temporary Signal Control in Work Zones
WZTC-0003: Temporary Traffic Control Signals Non-Compliance Documentation Form
WZTC-0003: Temporary Traffic Control Signals User Comment Form
TE 161: Notice of Commencement for Temporary Traffic Signals

Temporary Traffic Control Signal Requirements and Timeframes

Type of Application	Publication 213 Figure	PennDOT Approval Required Prior to Use	Advance Site Visit Required by User	Application Required	Site-Specific Drawing Required	Prior PennDOT Notification Via TE-161 Required	Deadline for District Receipt of all Required Materials
Long-Term Stationary Operation, Fixed Supports	PATA 705	X	X	X	X		At least 15 working days prior to desired usage
Long-Term Stationary Operation, Trailer Mounted, Portable Traffic Control Signals	PATA 706	X	X	X	X		At least 15 working days prior to desired usage
Short-Term Stationary Operation, Pedestal Mounted, Non-complex Condition Automatic or Manual Control	PATA 701		X			X	At least 3 business hours prior to desired usage
Short-Term Stationary Operation, Trailer Mounted, Non-Complex Condition Automatic or Manual Control	PATA 702		X			X	At least 3 business hours prior to desired usage
Short-Term Stationary Operation, Pedestal Mounted, Complex Condition Automatic or Manual Control	PATA 703		X			X	At least 3 business hours prior to desired usage
Short-Term Stationary Operation, Trailer Mounted Complex Condition Automatic or Manual Control	PATA 704	X	X	X			At least 3 business days prior to desired usage

APPLICATION FOR PERMIT TO OPERATE TEMPORARY TRAFFIC CONTROL SIGNALS

PLEASE TYPE OR PRINT INK ALL INFORMATION IN BLUE OR BLACK



A Applicant's Contact Information	
Applicant's Name	
Applicant's Company	
Company Address	
Company Phone Number	Company Fax Number
Cellular Phone Number	E-mail Address
Name of Emergency Contact Person (Must be available 24 hrs./day, 7 days/week during period of usage.)	Cellular Phone Number
B Description of Traffic Control Device	
Type of Device	
Select One:	
<input type="checkbox"/> Mounted on Fixed Supports <input type="checkbox"/> Trailer Mounted <input type="checkbox"/> Pedestal Mounted <input type="checkbox"/> AFAD <input type="checkbox"/> Other (explain)	
Traffic Control Device Manufacturer	Manufacturers Model No.
PennDOT Approval No.	
C Work Zone Information	
Was a site visit performed prior to submitting this application? <input type="checkbox"/> Yes <input type="checkbox"/> No	
Date of Traffic Control Device Usage:	Begin End
Engineering District	County Municipality
On State Route (SR)	Direction
From: Segment	Offset
To: Segment	Offset
On Local Road	Direction
From	
To	
Normal Speed Limit	mph
ADT	veh/day
Maximum Length of One-Lane, Two-Way Traffic Section feet (Between <i>STOP HERE ON RED</i> Signs)	
The traffic control device will be used to control: (Check all that apply)	
<input type="checkbox"/> One-Lane, Two-Way Traffic <input type="checkbox"/> No More than Two approaches <input type="checkbox"/> Other (please describe):	
Type of Operation: <input type="checkbox"/> Long-Term Stationary <input type="checkbox"/> Short Term Stationary <input type="checkbox"/> Other (please describe):	

APPLICATION INSTRUCTIONS FOR PERMIT TO OPERATE TEMPORARY TRAFFIC CONTROL SIGNALS

A. Applicant's Contact Information

- Applicant's Name: The individual responsible for the proper placement of the work zone traffic control devices.
- Applicant's Company: The Company the Applicant represents.
- Company Address: The official mailing address of the Applicant's company.
- Company Phone Number: The phone number of the Applicant's company.
- Company Fax Number: The fax number of the Applicant's company.
- Cellular Phone Number: The Applicant's cellular phone number.
- Email Address: The Applicant's email address.
- Name of Emergency Contact Person: The person that will be available 24 hours per day, 7 days per week during the period of usage and who will be responsible for the continued proper usage of the device.
- Cellular Phone Number: The emergency contact person's cellular phone number.

B. Description of Traffic Control Device

- Mounted on Fixed Supports: As defined in the Manual on Uniform Traffic Control Devices (MUTCD), it is a temporary traffic control signal that is temporarily mounted on fixed supports. The fixed supports are typically span wires mounted on temporarily installed poles. These Devices are normally used for long-term stationary applications where appropriate field conditions exist.
- Trailer Mounted: Trailer mounted portable traffic control signal systems consist of two trailers, with each trailer having a vertical upright and a horizontal arm to accommodate the mounting of at least two signal heads. These devices may be used for short-term stationary and long-term stationary applications where the appropriate conditions exist.
- Pedestal Mounted: Pedestal mounted portable traffic control signal systems consist of four units, with a pedestal mounted signal head on each unit. These devices may be used for short-term stationary applications where appropriate field conditions exist.
- Automated Flagger Assistance Device (AFAD): A manually controlled device operated by one or more individuals to safely stop and control traffic through a work zone. These devices may be used for short-term stationary applications where appropriate field conditions exist.
- Other (explain): Other applications which do not fall into the criteria listed above. Please give a detailed description so that proper evaluation may be made.
- Traffic Control Device Manufacturer: The manufacturer of the devices that will be used for work zone traffic control.
- Manufacturers Model No.: The model number assigned to the device by the manufacturer.
- PennDOT Approval No.: The PennDOT device approval number in PennDOT Publication 35 "Approved Construction Materials (Bulletin 15)." This number can be accessed through the ECAMMS website:
<https://www.ecamms.pa.gov/Public/Pages/Bulletins/BulletinSearch.aspx?BulletinTypeKey=2>. If problems exist with finding an approval number, please contact either the appropriate PennDOT Engineering District Office or PennDOT Central office at (717) 783-0333.

C. Work Zone Information

- Was a site visit performed prior to this application request?
 - Yes: A proper field visit was made prior to the submission of this application to determine if the device was acceptable and met all of the criteria specified in Publication 213 to safely and efficiently operate the device.
 - No: A proper field visit was not made prior to the submission of this application.
- Date(s) of Traffic Control Device Usage: Please specify the approximate beginning and end date(s) and times that the device will be used. Upon approval of this application, if the dates are modified, please contact the appropriate Engineering District representative.
- Engineering District: The Engineering District where the proposed usage will be. This is the Engineering District that will be reviewing the completed application. The following link is a map of the PennDOT Engineering Districts:
http://www.dot.state.pa.us/public/Bureaus/BOMO/Portal/wz_map.pdf.
- County: The county where the traffic control device will be used.
- Municipality: The municipality where the traffic control device will be used.
- On State Route (SR): The state highway where the traffic control device will be deployed. For further guidance please refer to the following link and select the appropriate county map:
<http://www.penndot.gov/ProjectAndPrograms/Planning/Maps/Pages/County-Type-10.aspx>.
- Direction: The direction of travel which may be either North/South or East/West. The link above may help with the determination of travel direction.
- From Segment: The roadway segment on the State Route the device will be deployed. These segment numbers may be found either on small markers posted along the roadway or from straight-line diagrams.
- Offset: The roadway location from the beginning of the segment to the approximate location of the device in feet.
- To Segment: The roadway segment on the State Route the device will be deployed. These segment numbers may be found either on small markers posted along the roadway or from straight-line diagrams.
- Offset: The roadway location from the beginning of the segment to the approximate location of the device in feet.
- On Local Road: use the local road name. Identify the nearest intersecting roadways when determining the local roadway location.
- Direction: The direction of travel which may be either North/South or East/West. The link above may help with the determination of travel direction.
- From: Indicate nearest intersecting roadway.
- To: Indicate nearest intersecting roadway.
- Normal Speed Limit: This is the legal speed limit on the roadway prior to the beginning of the work. If no speed limit is posted, please mark unposted.
- ADT: This is known as Average Daily Traffic. This number can be found by accessing the following link and selecting the appropriate county map:
<http://www.penndot.gov/ProjectAndPrograms/Planning/Maps/Pages/Traffic-Volume.aspx>. If problems exist with finding an ADT, Please contact either the appropriate PennDOT Engineering District Office or PennDOT Central Office at (717) 783-0333.
- Maximum Length of One-Lane, Two-Way Section: This is the approximate distance between “STOP HERE ON RED” (R10-6AR) signs in feet. This is very important for determining the proper

- all-red clearance interval needed to safely and efficiently move traffic through the work zone.
 - The traffic control device will be used to control:
 - One-Lane, Two-Way Traffic
 - No More than Two Approaches
 - Other (please describe)
 - Type of Operation:
 - Long-Term Stationary: Work that occupies a location for a period of more than 24 hours
 - Short-Term Stationary: An operation that will occupy a location for up to 24 hours.
 - Other (please describe): Any work that does not fall into the previous two categories.
 - Will all signal faces exceed the thresholds for signal face visibility specified on the Publication 213 figure?
 - Yes
 - No
 - Does the site contain an intersection or intersections within the one-lane, two-way traffic section?
 - Yes: The site contains an intersection or intersections within the work zone.
 - No: The site does not contain an intersection within the work zone.
 - Does the site contain an uncontrolled commercial driveway within the one-lane, two-way traffic section?
 - Yes: The site contains uncontrolled commercial driveways within the work zone.
 - No: The site does not contain an uncontrolled commercial driveway within the work zone.
 - Is any roadway approach to the traffic control device on a steep downgrade (5% or more)?
 - Yes: An approach has a steep downgrade of 5% or more.
 - No: No approach has a steep downgrade of 5% or more.
 - Does the site contain an at-grade railroad crossing within 300 feet of the work zone?
 - Yes: The site contains an at-grade railroad crossing within 300 feet of the work zone
 - No: The site does not contain an at-grade railroad crossing within 300 feet of the work zone
 - Proposed work description: Provide a description of the type of work being performed within the work zone.
-

D. Traffic Control Device Operational Information

- Mode of Operation
 - Manually-Controlled: The traffic control device will be operated at all times by an individual who will ensure safe and efficient travel through the work zone.
 - Pre-Timed: The traffic control device will operate automatically in a pre-determined timing pattern based on time of day and will continue to operate that way throughout the day.
 - Actuated: The traffic control device will operate using sensors and will change green time as traffic demand warrants.
 - AFAD: The traffic control device will be operated at all times by an individual who will ensure safe and efficient travel through the work zone.
 - Other (explain): Other applications that do not fall into the criteria listed above. Please give a detailed description so that proper evaluation may be made.
- PennDOT Publication Figure: The determination of the correct figure to be followed from

PennDOT Publication 213.

- All-red clearance time: This is to ensure that the proper amount of time is being used to allow traffic to travel through the work zone before opposing traffic is allowed to go. This should be determined from the charts on the appropriate Publication 213 figure.

E. Applicant Certification

This section needs to be filled out in its entirety. It will need to be signed by the applicant and notarized.

F. PennDOT Acknowledgement

This section is for PennDOT use to either accept the application or reject the application with an explanation.

APPLICATION FOR PERMIT TO OPERATE TEMPORARY TRAFFIC CONTROL SIGNALS

PLEASE TYPE OR PRINT INK ALL INFORMATION IN BLUE OR BLACK



A Applicant's Contact Information	
Applicant's Name	
Applicant's Company	
Company Address	
Company Phone Number	Company Fax Number
Cellular Phone Number	E-mail Address
Name of Emergency Contact Person <small>(Must be available 24 hrs./day, 7 days/week during period of usage.)</small>	Cellular Phone Number
B Description of Traffic Control Device	
Type of Device	
Select One:	
<input type="checkbox"/> Mounted on Fixed Supports <input type="checkbox"/> Trailer Mounted <input type="checkbox"/> Pedestal Mounted <input type="checkbox"/> AFAD <input type="checkbox"/> Other (explain)	
Traffic Control Device Manufacturer	Manufacturers Model No.
PennDOT Approval No.	
C Work Zone Information	
Was a site visit performed prior to submitting this application? <input type="checkbox"/> Yes <input type="checkbox"/> No	
Date of Traffic Control Device Usage:	Begin End
Engineering District	County Municipality
On State Route (SR)	Direction
From: Segment	Offset
To: Segment	Offset
On Local Road	Direction
From	
To	
Normal Speed Limit	mph
ADT	veh/day
Maximum Length of One-Lane, Two-Way Traffic Section feet (Between <i>STOP HERE ON RED</i> Signs)	
The traffic control device will be used to control: (Check all that apply)	
<input type="checkbox"/> One-Lane, Two-Way Traffic <input type="checkbox"/> No More than Two approaches <input type="checkbox"/> Other (please describe):	
Type of Operation: <input type="checkbox"/> Long-Term Stationary <input type="checkbox"/> Short Term Stationary <input type="checkbox"/> Other (please describe):	

C	Work Zone Information... continued
Will all signal faces exceed the thresholds for signal face visibility specified on the Publication 213 figure?	<input type="checkbox"/> Yes <input type="checkbox"/> No
Does the site contain an intersection within the one-lane, two-way traffic section?	<input type="checkbox"/> Yes <input type="checkbox"/> No
Does the site contain an uncontrolled commercial driveway within the one-lane, two-way traffic section?	<input type="checkbox"/> Yes <input type="checkbox"/> No
Is any roadway approach to the traffic control device on a steep downgrade (5% or more)	<input type="checkbox"/> Yes <input type="checkbox"/> No
Does the site contain an at-grade railroad crossing within 300 feet of the work zone?	<input type="checkbox"/> Yes <input type="checkbox"/> No
Proposed work description:	

D	Traffic Control Device Operational Information
Mode of Operation	
Select One:	
<input type="checkbox"/> Manually-Controlled <input type="checkbox"/> Pre-Timed <input type="checkbox"/> Actuated <input type="checkbox"/> AFAD <input type="checkbox"/> Other (explain)	
PennDOT Publication Figure: PATA _____ will be followed.	
All-red clearance time is _____ seconds based on assumed traffic speed of _____ mph within one-lane, two-way section.	
The proposed minimum green time shall be at least 10 seconds.	
The proposed maximum green time shall be determined based on field conditions.	
The proposed yellow change clearance interval shall be five (5) seconds unless otherwise indicated by PennDOT.	

E	Applicant Certification
The applicant certifies that the information provided on this application and accompanying documents is true and correct.	
The applicant certifies that, if approved, the traffic control devices will be operated and maintained in compliance with PennDOT Publications 212 and 213, and the provisions of the temporary traffic control signal permit as issued by PennDOT.	
The applicant agrees that it will indemnify, save harmless and defend (if requested) the Commonwealth of Pennsylvania, its agents, representatives and employees, from all suits, actions or claims of any character, name or description, damages, judgments, expenses, attorneys' fees and compensation arising out of personal injury, death or property damage, sustained or alleged to have been sustained in whole or in part by any and all persons whatsoever as a result of or arising out of any act, omission, neglect or misconduct of the applicant, its officers, agents, contractors or employees, during the period of temporary traffic control signal usage.	
By _____	
Signature of Applicant	Date
Sworn before me this _____ day of _____, 20 _____	
Notary _____	

Guidelines for the Selection of Temporary Traffic Control Signals in Work Zones

Background

It is common for construction, maintenance, and utility operations to require the closing of a traffic lane during the course of their work. For the duration of the lane closure, traffic must be either diverted to another route via a detour, or merged into other lanes. When the lane closure is located on two-lane, two-way roadways and detour routes are not practical, then alternating traffic on the remaining open lane is the typical operational choice.

Purpose

The purpose of these guidelines is to provide guidance for selecting the appropriate temporary traffic signal for short-term and long-term lane closures on two-lane, two-way roadways. These guidelines supplement PennDOT Publication 213 and assist in the determination of the minimum requirements for work zone traffic control for various traffic and roadway parameters. Definitions of terminology and distance charts for various parameters are also available in this document.

MUTCD Guidance on Temporary Traffic Control Signals

Section 4D.20 Temporary Traffic Control Signals

“Standard:

A temporary traffic control signal shall be defined as a traffic control signal that is installed for a limited time period. A portable traffic control signal shall be defined as a temporary traffic control signal that is designed so that it can be easily transported and reused at different locations.

Support:

A temporary traffic control signal is generally installed using methods that minimize the costs of installation, relocation, and/or removal. Typical temporary traffic control signals are for specific purposes, such as for one-lane, two-way facilities in temporary traffic control zones (see Chapter 4G), for a haul-road intersection, or for access to a site that will have a permanent access point developed at another location in the near future.

Standard:

Advance signing shall be used when employing a temporary traffic control signal. A temporary traffic control signal shall:

- A. Meet the physical display and operational requirements of a conventional traffic control signal.*
- B. Be removed when no longer needed.*
- C. Be placed in the flashing mode when not being used if it will be operated in the steady mode within 5 working days; otherwise, it shall be removed.*
- D. Be placed in the flashing mode during periods when it is not desirable to operate the signal, or the signal heads shall be covered, turned, or taken down to indicate that the signal is not in operation.*

Guidance:

A temporary traffic control signal should be used only if engineering judgment indicates that installing the signal will improve the overall safety and/or operation of the location. The use of temporary traffic control signals by a work crew on a regular basis in their work area should be subject to the approval of the jurisdiction having authority over the roadway.

A temporary traffic control signal should not operate longer than 30 days unless associated with a longer-term temporary traffic control zone project.

For use of temporary traffic control signals in temporary traffic control zones, reference should be made to Section 6F.80.”

Section 6F.80 Temporary Traffic Control Signals Standard:

“Temporary traffic control signals (see Section 4D.20) used to control road user movements through TTC zones and in other TTC situations shall meet the applicable provisions of Part 4.

Support:

Temporary traffic control signals are typically used in TTC zones such as temporary haul road crossings; temporary one-way operations along a one-lane, two-way highway; temporary one-way operations on bridges, reversible lanes, and intersections.

Standard:

One-lane, two-way vehicular traffic flow (see Chapter 4G) requires an all-red interval of sufficient duration for road users to clear the portion of the TTC zone controlled by the traffic control signals. Safeguards shall be incorporated to avoid the possibility of conflicting signal indications at each end of the TTC zone.

Guidance:

Where pedestrian traffic is detoured to a temporary traffic control signal, engineering judgment should be used to determine if pedestrian signals or accessible pedestrian signals (see Section 4E.06) are needed for crossing along an alternate route.

When temporary traffic control signals are used, conflict monitors typical of traditional traffic control signal operations should be used.

Option:

Temporary traffic control signals may be portable or temporarily mounted on fixed supports. Standard:

The supports for temporary traffic control signals shall not encroach into the minimum required width of a "pedestrian access route" of 1200 mm (48 in) or an "alternate circulation path" of 900 mm (36 in).

Guidance:

Temporary traffic control signals should only be used in situations where temporary traffic control signals are preferable to other means of traffic control, such as changing the work staging or work zone size to eliminate one-way vehicular traffic movements, using flaggers to control one-way or crossing movements, using STOP or YIELD signs, and using warning devices alone.

Support:

Factors related to the design and application of temporary traffic control signals include the

following:

- A. Safety and road user needs;
- B. Work staging and operations;
- C. The feasibility of using other TTC strategies (for example, flaggers, providing space for two lanes, or detouring road users, including bicyclists and pedestrians);
- D. Sight distance restrictions;
- E. Human factors considerations (for example, lack of driver familiarity with temporary traffic control signals);
- F. Road-user volumes including roadway and intersection capacity;
- G. Affected side streets and driveways;
- H. Vehicle speeds;
- I. The placement of other TTC devices;
- J. Parking;
- K. Turning restrictions;
- L. Pedestrians;
- M. The nature of adjacent land uses (such as residential or commercial);
- N. Legal authority;
- O. Signal phasing and timing requirements;
- P. Full-time or part-time operation;
- Q. Actuated, fixed-time, or manual operation;
- R. Power failures or other emergencies;
- S. Inspection and maintenance needs;
- T. Need for detailed placement, timing, and operation records; and
- U. Operation by contractors or by others.

Although temporary traffic control signals can be mounted on trailers or lightweight portable supports, fixed supports offer superior resistance to displacement or damage by severe weather, vehicle impact, and vandalism.

Guidance:

Other TTC devices should be used to supplement temporary traffic control signals, including warning and regulatory signs, pavement markings, and channelizing devices.

The design and placement of temporary traffic control signals should include interconnection to other traffic control signals along the subject roadway.

Temporary traffic control signals not in use should be covered or removed.”

Key Terms and Definitions

Automated Flagger Assistance Device (AFAD) – A manually-controlled device operated by one or more individuals to safely stop and control traffic through a work zone.

Long-Term Portable Traffic Control Signal Operation – All physical and operational requirements should be part of the Traffic Control Plan.

Long-Term Stationary Operation – As defined in PennDOT Publication 213: work that occupies a location more than 24 hours.

Long-Term Stationary Operation for Temporary Traffic Control Signals - All other stationary operations that do not meet the short-term stationary operation for temporary traffic control signals criteria.

Multiple Phase Traffic Signal Operation – An operation when more than two vehicle movements occur during the signal cycle.

Pedestal-Mounted Portable Traffic Control Signal System – The system consists of four units, with a pedestal-mounted signal head on each unit.

Performance Specification – The required product performance, which may include but is not limited to equipment, physical requirements, operational requirements, etc. **Manually-Controlled Portable Traffic Control Signal Operation** – when a portable traffic control signal is being controlled manually.

Portable Traffic Control Signal- As defined in the MUTCD: a temporary traffic control signal that is designed so that it can be easily transported and reused at different locations. Types of portable signals are trailer-mounted and pedestal-mounted.

Red Clearance Interval – An interval that follows a yellow change interval and precedes the next conflicting green interval. It provides additional time before conflicting traffic movements, including pedestrians, are released. The duration of a red clearance interval shall be predetermined.

Short-Term Emergency Operation – An emergency application defined in PennDOT Publication 212.

Short-Term Stationary Operation – As defined in PennDOT Publication 213: work that occupies a location up to 24 hours.

Short-Term Stationary Operation for Temporary Traffic Control Signals – is defined as daylight work areas with work in active progress, emergency nighttime work areas with work in active progress, or work areas of relatively short duration where work begins during daylight and continues in active progress during hours of darkness.

Signal Phase – The right-of-way, yellow change, and red clearance intervals in a cycle that are assigned to an independent traffic movement or combination of movements.

Site-Specific Drawing – A drawing that clearly depicts the work zone and the anticipated operations. Typically, this is part of the Traffic Control Plan (TCP).

Temporary Traffic Control Signal – As defined in the MUTCD, a traffic control signal that is installed for a limited time period. Temporary traffic control signals may be portable or temporarily mounted on fixed supports. Common types of temporary traffic control signals are signals mounted on span wire with temporary supports and trailer-mounted portable signals.

Temporary Traffic Control Signal Application – An application that allows the PennDOT Engineering District Office to obtain the minimum required information to ensure safe and efficient operation of the temporary traffic control signal.

Temporary Traffic Control Signal on Fixed Supports – As defined in the MUTCD: A temporary traffic control signal that is temporarily mounted on fixed supports. They are typically constructed with span wires mounted on temporarily-installed poles.

Temporary Traffic Control Signal Permit – The PennDOT Engineering District Office acceptance that the proper documentation was received to ensure safe and effective use of temporary traffic control signals. This permit will allow proper use of the device in accordance with the provisions of the permit and PennDOT Publication 213.

Traffic Signal Timing – The amount of time allocated for the display of a signal indication.

Trailer-Mounted Portable Traffic Control Signal System – The system consists of two trailers, with each trailer having a vertical upright and a horizontal arm to accommodate the mounting of at least two

signal heads.

Two-Phase Traffic Signal Operation – An operation when two different vehicle movements occur during the signal cycle. One-lane, two-way traffic control is often a two-phase operation assuming that additional phases are not needed for driveways and intersecting roads.

Work in Active Progress – Workers, other than flaggers, are present and are actively engaged in performing the necessary work.

Yellow Change Interval – The first interval following the green interval during which the yellow signal indication is displayed. It is used to warn traffic of an impending change in the right-of-way assignment. The duration of a yellow change interval shall be predetermined.

Temporary Traffic Control Signals for Long-Term Stationary Operations

In the design phase of every project that will have temporary traffic signals, it is required that both installations on fixed supports and trailer-mounted portable traffic control signals always be considered before completing the design of the Traffic Control Plan (TCP). In some instances, trailer-mounted portable signals or installations on fixed supports can be used. On the other hand, in certain instances, installations on fixed supports may be preferable to trailer-mounted signals, or vice-versa, depending on the nature of the project, site conditions, traffic conditions, and other specific factors.

Before developing a TCP with temporary traffic signals, it is absolutely essential that the designer visit the proposed worksite beforehand. The site visit will enable the designer to evaluate various factors that will help in the determination of whether the TCP should permit both temporary signal design options, or one or the other. These factors include lateral clearance, trailer or pole placement, signal operation (phasing and timing), and others. Please also note that pedestal-mounted portable traffic control signals will not be considered for long-term stationary operations.

To establish the proper and acceptable temporary traffic control signal within a work zone, the following criteria should be considered:

Long-Term Stationary Operation Using Trailer-Mounted Portable Traffic Control Signals:

Pros:

- Systems can be deployed quickly.
- Especially conducive to deployments for emergencies.
- Systems can be easily set up and taken down each day, or for multiple construction phases.
- Equipment can be reused on future projects.
- Equipment capable of being leased.
- Cost savings potential.
- Capable of wireless radio or hardwire interconnect.
- Commonly equipped with monitoring system for location, low battery status, and conflicts using website and/or cell phone paging.
- Commonly equipped with batteries that are solar recharging.
- Commonly equipped with solar panels, rechargeable batteries, and ability to run via commercial power.
- Wireless remote commonly available.

Cons:

- Arm length can sometimes affect signal head placement.
- Arm length affects number of signal heads that can be placed overhead.

- Trailer size and/or arm length in conjunction with physical features can sometimes limit adequate placement.
- Manufacturers have different operating systems.
- More susceptible to vandalism.
- Less appropriate for long-duration jobs on multilane, high-speed roadways.

Long-Term Stationary Operation Using Temporary Traffic Control Signals on Fixed Supports:

Pros:

- Desirable signal head placement can be achieved.
- More than two overhead signals can be erected.
- Less susceptible to vandalism.
- Pole placement sometimes may be easier to accommodate than trailers due to physical features.
- Fixed supports may be more desirable for long duration deployments. More appropriate for multilane approaches.
- Employs common traffic signal control equipment and operational features.

Cons:

- Inability to set up and take down each day.
- Less appealing for short-duration jobs or jobs with short-duration, multiple set- ups.
- Equipment and material availability is sometimes an issue.
- Less cost savings potential.

If the designer determines that only one temporary signal design option is justified for a particular project, then the TCP shall be prepared accordingly, and written documentation shall be maintained in the project file outlining the reasons for this determination. It would also be desirable to clearly indicate on the TCP that the other option will not be permitted for the project.

If the designer determines that trailer-mounted portable signals or installations on fixed supports would be acceptable, then the TCP should clearly show the exact design and operation of both alternatives so that additional plans from the contractor would not be necessary. The TCP should include the design of all anticipated needed features. For example, if platforms or other special features will be needed, their design and placement should be in the TCP. Engineering judgment should be used and documented to determine the safest and most efficient operation for the work zone.

Temporary Traffic Control Signals for Short-Term Stationary Operations

Before developing and/or determining your traffic control plan (TCP) using PennDOT Publication 213, it is absolutely essential that the user visit the proposed worksite beforehand. The site visit will enable the user to evaluate various factors that will help in the determination of whether the TCP should permit temporary signal (portable signal) options, or other traffic control methods such as flaggers. These factors include lateral clearance, trailer or pedestal placement, signal operation (phasing and timing), and others. Please also note that installations on fixed supports are not considered viable for short-term stationary operations because of the amount of time and materials needed for installation.

If the user determines that portable traffic control signals will be an option and would like to pursue that option, then a completed application (TE-952P) for PATAs 704, 705 and 706 or a Notice of Commencement for Portable Traffic Signals (TE-161) for PATAs 701, 702 and 703 shall be submitted to PennDOT's appropriate Engineering District Office. These forms will be submitted within the timeframe specified in the Temporary Traffic Control Signal Requirements and Timeframes chart on page D-2. If the Engineering District Office agrees with the proposed usage from the completed application (TE-952P), they will issue a temporary signal permit.

Design Guidelines for Long-Term Temporary Signal Control in Work Zones

The following design guidelines are to further clarify temporary signal requirements when determining location specific long-term temporary signal plans in compliance with PATA 705 (Temporary signals on fixed supports for long-term stationary operations) and PATA 706 (Portable temporary signals for long-term stationary operations). Once finalized, these guidelines will be added to Appendix D of Publication 213 (Temporary Traffic Control Guidelines).

Preliminary Design

The following information should be determined at an initial scoping meeting prior to submitting any temporary signal control plans in work zones.

- Determine work zone limits including the length of the closure or lane restriction.
- Determine the type of work zone control on the project (i.e., detour, ½ width construction, temporary roadways, etc....)
- Determine existing field conditions (such as the AADT, grades, geometry, etc....) and appropriate clear zones.
- Determine the project schedule to determine how long the work zone will be in operation and whether it would be in operation over the winter.
- After determining the work zone limits, the traffic control for all driveways, local highways, and state highways within the work area needs to be evaluated. The purpose of the scoping meeting is to clarify any changes to the initial traffic control of the work zone.
- Work zone tapers, transitions, lane widths, and other key factors need to be discussed and agreed to at the initial project scoping.
- Pedestrian Accommodations and Needs and Location and Operation of Existing Driveways within the influence area of the traffic signal.
- When Temporary Signals are selected, conduct a preliminary assessment with proper justification documented to determine the type of temporary signals to be used. The designer and/or applicant should consider and document their decisions based on the "Guidelines for the Selection of Temporary Traffic-Control Signals in work zones" identified in Publication 213, Appendix D.
- Complete all of the data requested within the TE-952P (Application for Permit to Operate Temporary Traffic Control Signals). While application does not need to be filled out completely, the data requested within this form is needed to answer the previous bullets.
- Any preliminary plans that have been developed and that have not been submitted to the Department.

The initial project scoping meetings should be completed prior to any submissions to the Department. It is highly recommended that the information provided above be provided to the Department at least five business days prior to the scoping meeting. Contact the appropriate District Traffic Engineer or identified traffic unit representative to set up an appropriate date and time for the meeting. The meeting can be held either in person (office or field) or through a web conference call to help streamline the process.

Long-Term Temporary Signal Design

- **Temporary Pole or Portable Signal Placement** –
 - When installing poles, contact PA-1 Call to appropriately mark all subsurface utilities.
 - Field evaluate and mark the pole or portable signal placement locations to determine any safety concerns with sight distance limitations due to horizontal and/or vertical curvature.
 - If the alternative portable signal locations or another alternative to PATA's 705 and 706 are selected, provide justification as to why this option was selected. Signal supports should be a minimum of two feet off the edge of the travel way as identified within Publication 149, Chapter 5.

- **Signal Head Placement** –
 - 12-inch Housing with backplates are required. Retro-reflective tape around the border could be considered, but visibility and sight distance concerns should be documented and justification provided.
 - The mounting height of the bottom of the traffic signal housing should be 17-feet above the center of the roadway surface. Additional mounting heights may be considered, but they need prior approval from the appropriate District.
 - Circular indications are typically used, but other arrow indications may be needed. If these arrow indications are needed, then the added and/or replaced indications will need to provide appropriate engineering judgement and justification, such as meeting conflict factor thresholds (see Publication 149 Chapter 3 – Operational Requirements).
 - For fixed support signal configurations, two signal indications over the roadway are preferred with one indication approximately 3-feet to the right of the existing double yellow markings and the other indication shall be approximately spaced (desirable distance is 12-feet, but it may need to be reduced to 8-feet apart). If another configuration is being considered, contact the appropriate District with the concerns and/or issues. Additional supplemental signal indications either on the column of the pole, on the portable unit, or another separate portable unit may be considered if appropriate justifications to geometric, safety, and sight distance concerns can be documented.
 - Full tunnel visors should be installed on the temporary signal indications. If louvers, other type of visors, or optically programmed signals are needed, then additional justification and engineering judgement should be provided indicating the safety and mobility benefits for installing the alternative solutions such as geometric, safety, or sight distance concerns.

- **Time Phasing and Sequencing** –
 - Phasing – Traffic signal phasing should be evaluated to determine the most appropriate and most efficient operation. If this is not an existing traffic signal, phasing should be established to minimize delay on the main highway. Existing traffic signal phasing should be evaluated and considered, but appropriate documentation and justification should be provided if phasing changes are being recommended.
 - Sequencing – Establishing the sequencing of a traffic signal should take into account the location specific factors. Typical sequencing is recommended, but if more complex sequencing would be needed then a more detailed evaluation would need to be reviewed, documented, and justification provided.

- Timing –
 - All-Red Clearance Interval – Use the calculations developed in PennDOT Publication 46. Additional time needs to have good documentation and justification.
 - Yellow Vehicle Change Interval – Use the calculations developed in PennDOT Publication 46. Additional time needs to have good documentation and justification.
 - Green Times – Minimum and maximum green times should be initially developed based on the amount of traffic obtained from either previous traffic counts or through Department published HPMS data. Highway Capacity Manual (HCM) Analysis and/or micro simulation may be used to determine the anticipated impact of the work zone. Field adjustments may be needed, but all adjustments should be justified and provided on the temporary traffic signal permit plan.
 - Pedestrian clearance times (if needed) – Use the calculations developed in PennDOT Publication 46. Additional time needs to have good documentation and justification.
 - The traffic signal should rest in red for all of the approaches during off peak periods. Rest in red would apply to all approaches. Other types of operation could be considered, but appropriate justification and documentation would be needed.
 - All traffic signal detection zones should be on locking mode to ensure that all calls placed on the traffic signal are serviced unless using non-locking is justified. Other types of operation could be considered, but appropriate justification and documentation are needed.
 - Other factors – other traffic signal controller settings such as delay, volume density operation, and other operational improvements can be considered, documented, and justification provided.
- Sign and Pavement Marking Placement
 - Sign and pavement markings should be in compliance with the layout and parameters provided within PATA 705 and 706. Additional sign and pavement markings would require documentation and justification.
 - Typically “No Turn on Red” signs shall be provided for all controlled driveways and side roadways. Other applications could be considered, but appropriate justification and documentation would be needed.
 - Typically “No Pedestrian Crossing Signs” are only needed when a pedestrian restriction is needed. Note that all the Department’s policies and procedures regarding pedestrian accommodations need to be considered.
 - Additional signs required for the location should be discussed at the initial scoping meeting. The additional signs should be documented and justified why they are needed for the project.
- Vehicle Detection Placement –
 - All temporary traffic signals should be fully actuated at each approach
 - Non-Intrusive video or radar detection are the preferred methods. Mounting and positioning of devices shall be per the manufacturers guidelines. If other alternatives are being considered then documentation and justification is needed.
 - All detection equipment used shall be Bulletin 15 approved.

- Pedestrian Detection –
 - Pedestrian Push Buttons – If previously available at the intersection or if needed for operational improvements. All new pedestrian push buttons shall meet existing ADA accessible criteria. Existing pushbuttons shall meet the same ADA accessible criteria and the temporary pedestrian push button should have the same functionality as the previous button (i.e., APS previously then APS needs to be installed for the temporary condition). If there is an official pedestrian detour that does not use a temporary signal location, then that location may not need pushbuttons based on engineering judgement.

- Preemption –
 - Emergency Vehicle Preemption – Location specific documentation and justification are needed. The following geometric, safety, mobility, or service criteria should be used to assist with engineering judgement
 - Identification that this is a known and critical route used by emergency responders.
 - Within two miles from a hospital
 - At a work zone location with a minimal sight distance of 1,000 feet
 - Along extreme curves where end of the work zone cannot be seen
 - Other unusual situations need to be approved by the Highway Safety and Traffic Operations Division (HSTOD)

Once it is determined that emergency vehicle preemption is needed then the type of preemption (optical or acoustic) needs to be evaluated and properly documented.
 - Ramp Preemption – Note that temporary signals within 1,000-feet from a limited Access ramp should be considered. Location specific documentation and justification is needed. The justification should identify any geometric, safety, mobility, or ramp service issues that would require the placement of Ramp Preemption.
 - Railroad Preemption – Note that temporary signals within 1,000-feet from a railroad should be considered. Location specific documentation and justification is needed. The justification should identify any geometric, safety, mobility, or railroad service issues that would require the placement of Railroad Preemption.
 - Queue Preemption – Location specific documentation and justification is needed. The following geometric, safety, mobility, or service criteria should be used to assist with the engineering judgement:
 - Along an existing documented and known crash location
 - Along approaches that have limited vertical and/or horizontal sight distance
 - Along approaches with negative grades exceeding 4%
 - At an intersection with approaches that have an existing posted speed limit at or above 40mph
 - Along approaches where the traffic queue exceeds the temporary advanced sign locations
 - Along approaches where it may back-up onto a limited access facility
 - Other unusual situations need to be approved by HSTOD

- Lighting –
 - Location specific documentation and justification is needed. The following geometric, safety, mobility, or service criteria should be used to assist with the engineering judgement:
 - Along an existing documented and known crash location
 - Along approaches that have limited vertical and/or horizontal sight distance
 - Along approaches with negative grades exceeding 4%
 - At an intersection with approaches that have an existing posted speed limit at or above 40mph
 - At an intersection where there is pedestrian accommodations
 - Other unusual situations need to be approved by HSTOD

- Other Alternatives –
 - Advanced Message Board Synchronization – Location specific documentation and justification is needed. The following geometric, safety, mobility, or service criteria should be used to assist with the engineering judgement:
 - All locations with an AADT above 10,000
 - Along an existing documented and know crash location
 - Along approaches that have limited vertical and/or horizontal sight distance
 - Along approaches with negative grades exceeding 4%
 - Along approaches that have an existing posted speed limit at or above 40mph
 - Along approaches where traffic queue exceeds the temporary advanced sign locations
 - Other unusual situations need to be approved by HSTOD

Once it is determined that advanced message board synchronization is needed then the type of message needs to be evaluated and properly documented
 - Generators and/or Battery-Back-up – Location specific documentation and justification is needed. The following geometric, safety, mobility, or service criteria should be used to assist with the engineering judgement:
 - All locations with an AADT above 10,000
 - Along an existing documented and known crash location
 - At intersections with complex phasing (more than 5 phases)
 - At intersections with railroad preemption
 - Other unusual situations need to be approved by HSTOD
 - Advanced Work Zone Communications – Location specific documentation and justification is needed. The following geometric, safety, mobility, or service criteria should be used to assist with the engineering judgement:
 - At intersections where traffic signal interconnection with another traffic signal or ITS are required
 - Other unusual situations need to be approved by HSTOD

- Additional Bike/Pedestrian Accommodations or animal drawn vehicles – Location specific documentation and justification is needed. The following geometric, safety, mobility, or service criteria should be used to assist with the engineering judgement:
 - Along an existing documented and known pedestrian or bike crash location
 - Along approaches that have limited vertical and/or horizontal sight distance and pedestrian accommodations will be provided
 - At locations where a defined trail crossing is near the work zone
 - Documentation of any animal drawn vehicle routes
 - Other unusual situations need to be approved by HSTOD

- Plan Presentation –
 - Temporary Signal Permit Plan presentation is to be in conformance with the same guidance provided for permanent signal permit plans identified within Publication 14, (DM-3).
 - Temporary Signal Permit Plans should have a signature block for the District Traffic Engineer and the Contractor. (*Note: Additional approvals should be completed internally prior to the District Traffic Engineer signature*)
 - The following General Notes should be provided on the temporary signal permit plan:
 - Signals must flash a minimum of three days and a maximum of seven days prior to red, yellow, green operation, unless otherwise directed by the District Traffic Engineer.
 - Contact the appropriate District Traffic Engineer or District Signal Supervisor one week prior to the anticipated temporary signal flash, turn-on, and phase change.
 - The Project Engineer or the District Traffic Unit representatives have the right to modify this plan in order to move traffic more safely and expeditiously according to accepted traffic engineering practices.
 - For other signing, see the Maintenance and Protection of Traffic plan, and/or Pennsylvania Department of Transportation Publication 213, Latest Edition.
 - Install, operate and maintain this temporary traffic signal in accordance with the Pennsylvania Department of Transportation Regulations on Specifications (Publication 408/2011), Traffic Control Standards (Publication 148), Traffic Signal Design Handbook (Publication 149), and Traffic Engineering Manual (Publication 46)
 - All maintenance necessary for the proper visibility of the signals, including trimming trees, is the responsibility of the contractor.
 - Contractor/Project Manager is responsible to contact all stakeholders (PennDOT, Municipality, etc.) to explain temporary traffic signal installation to ensure safe work zone operations.
 - The contractor installs and maintains all signs and pavement markings indicated on the temporary signal permit, unless otherwise indicated.
 - All stop bars are to be placed perpendicular to the centerline of the roadway.
 - All temporary pavement markings are to be removed upon completion of the project.
 - Remove all existing pavement markings and signs that conflict with the temporary signal permit.
 - All traffic control devices, tapers and signing to be installed as shown and in accordance with Pennsylvania Publication 213.

- This drawing cannot be used as a construction drawing unless the contractor complies with the provisions of Act 287, as amended, prevention of damage to underground utilities. Prior to construction contact utility companies as well as proper notification to PA 1-call.
 - No adjustments shall be made to the stop bar lengths without approval from the district traffic unit.
 - The contractor is responsible for coordination of any relocation of overhead utilities that may interfere with the clear vision of the signal heads.
 - All Pavement Markings and signs must be restored to their original configuration at the completion of the project.
 - Install all signs and pavement markings as indicated on the temporary signal permit plan before the signals are placed in red, yellow, green operation.
 - Additional general notes and/or information should be documented and justification provided. If possible, this information should be provided at the initial scoping meeting.
 - The designer shall have their professional engineer seal and signature on each temporary signal plan title sheet.
- Field Adjustments and Traffic Signal Permitting –
 - All initial time, sequencing, and phasing are to be documented on the initial temporary signal permit plan. Any field modifications and/or adjustments should be initially documented on As-Built drawings, but then updated on the temporary signal permit plans. All adjustments should be documented and justification provided.
 - The District Traffic Unit will be notified at least 1-week prior to a temporary signal turn on or phase shift. The District may have a representative available to review and approve compliance to the temporary signal permit plan.
 - Temporary signal flashing is to be coordinated with the District and discussed at the project scoping meeting. Signals must flash a minimum of three days and a maximum of seven days prior to red, yellow, green operation, unless otherwise directed by the District Traffic Engineer. Alternatives to flashing could be the placement of portable changeable message signs prior to the installation of a temporary signal to notify motorists of the future operational change.
 - The initial turn on or any phase changes is to occur on a Tuesday, Wednesday, or Thursday from 9am to 2pm unless otherwise authorized by the District Traffic Engineer. The temporary traffic signal is not to be turned on the day before or after a holiday. It is highly suggested that the placement of the temporary signals be established prior to placement of barrier and pavement markings (*Note: all conflicting markings and signs need to be covered prior to this occurring*). Therefore, if the temporary signal is initially in place, then the traffic signal representative can verify the temporary signal field conditions, time, phasing and sequencing so that the signal can be officially turned on prior to all barrier and pavement marking construction activities have been completed. Channelizing devices can be used temporarily until the markings can be installed.
 - The temporary signal permit initial design is to be approved by the Department. All contractor signatures and TE-925P need to be completed prior to the field inspection. The Department will not issue the official temporary signal permit until field conditions and operational improvements have been evaluated. Typically the District will bring the temporary signal permit and plan to the field review of the initial turn-on or phase change.

Temporary Signal Design Submission Materials

The following are required when submitting a temporary signal plan for the Department's review:

- Completed and Signed TE-952P (Application for Permit to Operate Temporary Traffic Control Signals)
- Completed Work Zone Traffic Control Plan
- Completed and Signed Temporary Signal Permit Plan
- Appropriate Signal calculations (i.e., clearance calculations, pedestrian calculations, HCM analysis, Synchro analysis, etc....)
- Additional documentation and justification as outlined within these design guidelines
- Project scoping meeting minutes or documentation
- Source of Supply information for either the portable traffic signal and/or the temporary signal equipment on fixed supports

Temporary Signal Review Comments

The Temporary Signal review should take into account what was discussed and agreed to at the initial scoping meeting. As specified above, if additional documentation and justification is needed for the comments (i.e., addition or deletion of materials) then this should be provided in the comments provided to the designer. It is suggested that, if more than two submissions and/or if additional clarification is needed, then an additional meeting or conversation should be conducted with the designer.

The purpose of this form is to provide the user of temporary traffic control signals the means to comment on both positive and negative feedback received from PennDOT's Engineering District Offices. Please supply all supporting documentation when submitting a comment form. PennDOT's Central Office will review all comments and will work with District Offices to resolve immediate issues, to improve future practices and to seek uniformity among PennDOT's eleven Engineering District Offices.

General Information

Temporary Signal User: _____ Date of Non-Compliance: _____

District: _____ County: _____ Municipality: _____

SR: _____ Segment: _____ Offset: _____

Name of Submittee: _____ Email or Phone Number: _____

Please attach supporting documentation (e.g., application, permit, TCP etc.). Provide a description of the nature of the non-compliance.

Please submit completed form to:

Pennsylvania Department of Transportation
Bureau of Maintenance and Operations
ATTN: Temporary Traffic Signals
400 North Street, 6th Floor
Harrisburg, PA 17120-0064

The purpose of this form is to provide the user of temporary traffic control signals the means to comment on both positive and negative feedback received from PennDOT's Engineering District Offices. Please supply all supporting documentation when submitting a comment form. PennDOT's Central Office will review all comments and will work with District Offices to resolve immediate issues, to improve future practices and to seek uniformity among PennDOT's eleven Engineering District Offices.

General Information

User Name: _____ Date Submitted: _____
Company: _____ Phone #: _____
Cell Number: _____ Email Address _____
Company Address: _____

Please attach supporting documentation. Please use the space below to provide your comments.

Please submit completed form to:

Pennsylvania Department of Transportation
Bureau of Maintenance and Operations
ATTN: Temporary Traffic Signals
400 North Street, 6th Floor
Harrisburg, PA 17120-0064

Notice of Commencement for Temporary Traffic Signals



DEPARTMENT USE ONLY

County : _____
 Engineering District : _____
 Notification Date : _____
 Notification Time : _____

The purpose of this notice of commencement form is to allow manufacturer certified pedestal-mounted portable traffic signal operators to submit the following traffic engineering form in accordance with Publication 213, PATA 701 or 703. The manufacturer's training certification requires Department approval prior to implementation. **NOTE:** A copy of this form is required on the work site.

A - Operator Information

Operator's Name: _____ Field Phone #: _____
 Company: _____
 Operator's Certification #: _____ Alternative Phone Number: _____
 Pedestal-Mounted Portable Traffic Signal Manufacturer: _____
 Manufacturer Model Number: _____

B - Location Information

County: _____ PennDOT Engineering District: _____
 Date of Deployment: _____ Operating Times: _____
 State Route (SR) or Local Roadway Name: _____
 Beginning Location (Segment/Offset, Intersection, etc...): _____
 Ending Location (Segment/Offset, Intersection, etc...): _____
 Description of Proposed Work:

C - Terms and Conditions

By checking the boxes below, as a certified Temporary Signal Operator, I and my associates, understand and accept the following:

PATA Number or Custom Traffic Control Plan: _____

The operator certifies that they have previously field reviewed the deployed location prior to issuing this Notice of Commencement.

The operator certifies that they have a valid certification provided by the manufacturer and the work zone complies to the conditions established within Publication 213, PATA 701, 702 or 703.

The operator certifies that all pedestal-mounted portable signal conditions and settings are in accordance with Publication 213, PATA 701,702 or 703 or otherwise written approval is provided by the District Traffic Engineer or designee which complies to the conditions established within Publication 213, PATA 701, 702 or 703.

The operator agrees that it will indemnify, save harmless and defend (if requested) the Commonwealth of Pennsylvania, its agents, representatives and employees, from all suits, actions or claims of any character, name or description, damages, judgments, expenses, attorneys' fees and compensation arising out of personal injury, death or property damage, sustained or alleged to have been sustained in whole or in part by any and all persons whatsoever as a result of or arising out of any act, omission, neglect or misconduct of the applicant, its officers, agents, contractors or employees, during the period of temporary traffic control signal usage.

I will submit this Notice of Commencement to the appropriate District Traffic Engineer at least 3 business hours prior to deployment unless otherwise specified by the District Traffic Engineer.

I AGREE TO THESE TERMS AND CONDITIONS SPECIFIED ABOVE.

Responsible Person: _____ Submit Date _____

Blank Page

Appendix E

To be completed by TMC personnel

RCRS ID #

Date Received

Time Received

TMC 100 Road Work Reporting Form

County
 State Route
 Direction
 Cause
 Status
 Verification Method
 Form Completed By
 Phone

On-Scene Contact
 On-Scene Contact Phone
 Event Beginning Date
 Event Beginning Time
 Estimated Date to Reopen
 Estimated Time to Reopen
 24/7 Work Zone Pattern

Daily patterns must be reported each day prior to the start of work. Check all days the work will be active.

Daily Pattern

Sunday	Thursday
Monday	Friday
Tuesday	Saturday
Wednesday	

Beginning and Ending Location or Incident Location must be completed

Incident Location

County
 Municipality
 Street
 or Exit/SR Terminator
 or On Ramp
 or Mile
 or Intersecting State Route
 or Segment/Offset

Beginning Location of Event

County
 Municipality
 Street
 or Exit/SR Terminator
 or On Ramp
 or Mile
 or Intersecting State Route
 or Segment/Offset

Ending Location of Event

County
 Municipality
 Street
 or Exit/SR Terminator
 or On Ramp
 or Mile
 or Intersecting State Route
 or Segment/Offset

Description (Describe the work being performed: eg. line painting, guide rail repair, pothole patching, etc.)

Description of Event

Notes

Contractor Information

24/7 Contractor Name
 24/7 Contact Name
 24/7 Phone Number

Restriction Details

Prohibit Permit Travel

Maximum Length	ft.	in.	Maximum Width	ft.	in.
Maximum Height	ft.	in.	Maximum Gross Weight	lbs	

Detour Details

Is Detour in Place? Yes No NA
 Detour Information
 and Route

District	Region	Email Address	Phone Number	Dates of Operation	Days of Operation	Operational Period	Off hours Contact District
1	Western	Ra-pdd1trafficunit@pa.gov Copy District 11	814-673-9661	November 1 to April 1	Sunday to Saturday	24 hours	11
2	Central	Pd-dist2-ORTMC@pa.gov	814-768-0725	365	Sunday to Saturday	24 Hours	
3	Central	Pd-dist2-ORTMC@pa.gov	814-768-0725	365	Sunday to Saturday	24 Hours	
4	Eastern	Ra-pddist40TMC@pa.gov Copy District 8	570-963-4058	365	Monday to Friday	07:00 to 18:00	8
5	Eastern	Pd-district5-OTOC@pa.gov Copy District 8	610-871-4600	365	Monday to Friday	06:00 to 20:00	8
6	Southeastern	Pd-district6-ORTMC@pa.gov	610-205-6934	365	Sunday to Saturday	24 Hours	
8	Eastern	Pd-dist8-OTMC@pa.gov	717-265-7600	365	Sunday to Saturday	24 Hours	
9	Central	Pd-dist2-ORTMC@pa.gov	814-768-0725	365	Sunday to Saturday	24 Hours	
10	Western	Pd-district11RTMC@pa.gov	412-429-6030	365	Sunday to Saturday	24 Hours	
11	Western	Pd-district11RTMC@pa.gov	412-429-6030	365	Sunday to Saturday	24 Hours	
12	Western	Pd-district11RTMC@pa.gov	412-429-6030	365	Sunday to Saturday	24 Hours	