

SURGICAL

CATALOGUE



PRODUCING QUALITY GOODS FOR 15 YEARS

We are Producers of quality surgical, dental, beauty and general stainless steel products in singleuse and multiuse type. We guarantee on our products and facilitate our customers with easy return policies.



For more information visit www.mjwintl.net

Manufacturers and Exporters of Surgical, Dental & Beauty Instruments

Head Office

BI24S 88/8 Bara Pathar
Christian Town, Sialkot
Pakistan (51310)
0092 524 264829

Branch Office

Flat 1, Kinsale Grange
57 Langley Park Road,
Sutton-Surrey SM2-5GZ UK.
Mob: 00447701084895

Contact Details

Email: info@mjwintl.net
mjwinternational2005@gmail.com
Mobile: 0092 321 712 1510
Mobile: 0092 333 371 3443



FACTORY OVERVIEW

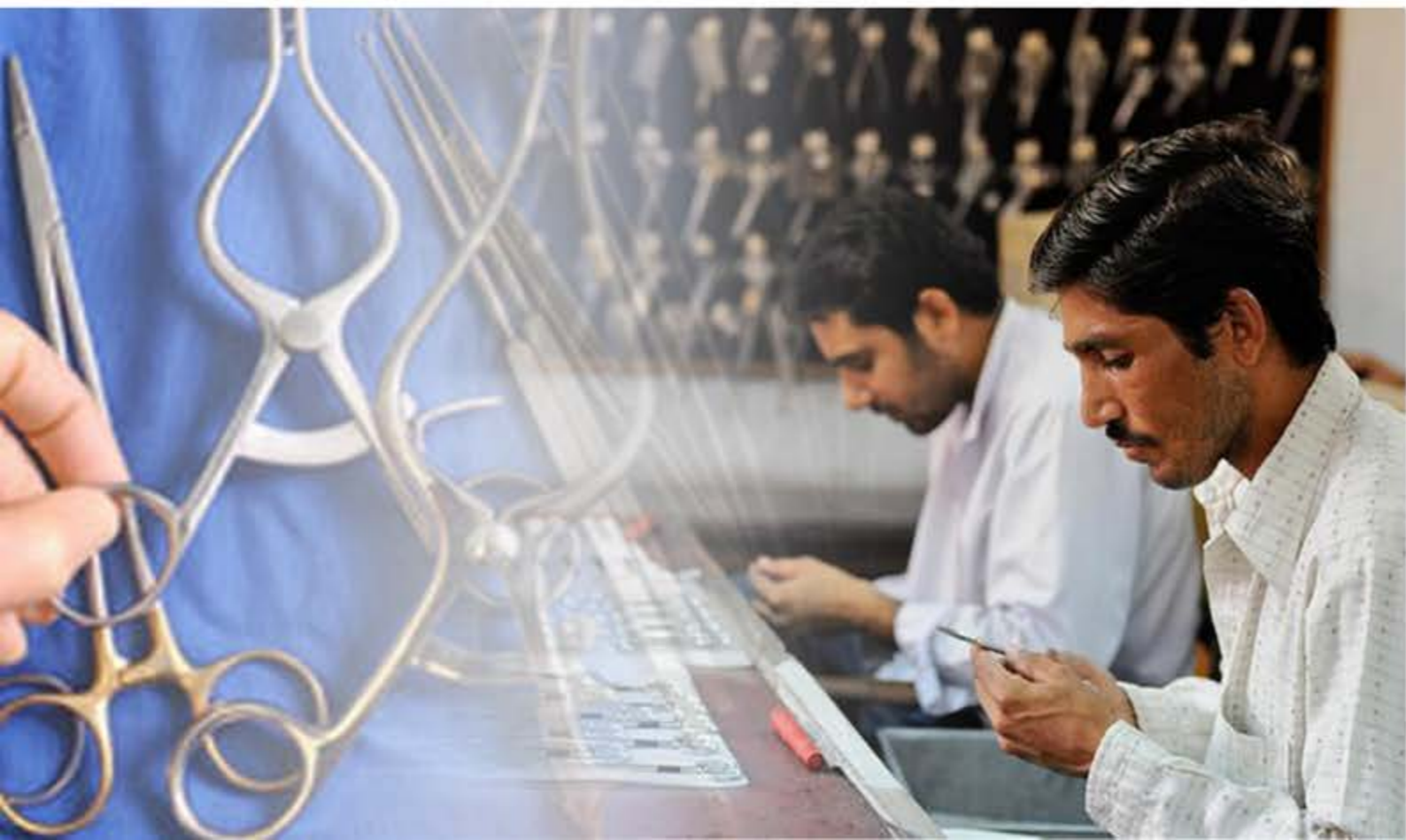

INTRODUCTION

for fifteen years MJW Surgical has been supplying the Healthcare Industry with finest quality surgical instruments & innovative products for surgery. With our extensive knowledge and experience in the medical field, our products are specifically designed to offer both exceptional quality and value for money to Healthcare Professionals and Organisations. During the last few years there have been numerous developments within our company, with the Introduction of many new innovative products and services to our portfolio, which has allowed MJW Surgical to make a significant impact on the healthcare market. Our head office is based in Sialkot, Pakistan housing all Customer Service and Administrative functions. Additionally, we have an office in the UK covering Europe and the USA. Our range of specialised surgical instrumentation is uniquely manufactured in Sialkot to the highest standards of craftsmanship. Our goal is to continue to develop new, innovative medical products that will enhance the quality of surgical procedures.

OUR SERVICE COMMITMENT

QUALITY of All surgical instruments and products manufactured and distributed by MJW Surgical conform to the highest European and International Standards with all products bearing the relevant CE mark for their classification.

GUARANTEE OF SATISFACTION

All products undergo rigorous quality control assessment and are fully guaranteed. Any product proving unsatisfactory in normal use will be replaced or repaired free of charge following inspection.

VALUE FOR MONEY

We believe our surgical instruments and products to be competitively priced representing excellent value for money. We are happy to offer discounts for contracts.

QUOTATION SERVICE















We offer a no obligation quotation service whereby we will specify, code and price your requirements using our extensive product library which enables us to cross-reference most products.

PRODUCT INFORMATION

Sectional catalogues are available for most surgical specialities.

INNOVATION

Our objective is to work in close conjunction with all medical and nursing personnel to develop new and innovative products and services.

Diagnostic, Anesthesia Scalpels & Knives	05 06		PAGE 01 To 22	Blader Ratractor Urinary Instrument & Trocars	15		PAGE 204 To 208	
Scissors			07	PAGE 23 To 51	Vaginal Specula & Retractors		16	PAGE 209 To 220
Forceps, Clamps	08 09 10			PAGE 52 To 95	Utrine Dilators, Probes Forceps, Myoma Inst.	17 18		PAGE 221 To 236
Needle Holders, Probes Suture and Pocket Instruments			11	PAGE 96 To 114	Biopsy Instruments		19	PAGE 237 To 245
Hooks And Retractors	12			PAGE 115 To 167	Obstertrics & Tracheotomy	20		PAGE 246 To 256
Forceps, Intestinal Clamp			13	PAGE 168 To 186	Cardiovascular & Thoracic Surgery Instruments		21	PAGE 257 To 309
Biopsy Forceps	14			PAGE 187 To 203	Bone Punches & Rongeurs	22		PAGE 310 To 318

C O N T E N T S



Amputation, Elevator, Bone Files, Raspatories, Curettes

23 24



PAGE 319 To 347

Bone Rongeurs, Cutting, Holding Forceps. Mallets, Tempers, Chisel, Gauges, Meniscus Inst.



25 26

PAGE 348 To 379

Wire Extension, Wire Cutting Plier, Forceps & Finger Nail Instruments

27



PAGE 380 To 392

Plaster Instruments



28

PAGE 393 To 397

Suction Instrument Sterilizing & Dissecting Set

29



PAGE 398 To 406

Tungsten Carbide Instruments



30

PAGE 407 To 413

Hospital Wares

31



PAGE 414 To 424







05-116
ZIEGLER Ø 90mm
Head mirror only
with rubber coating



05-117
ZIEGLER Ø 90mm
Head mirror only
with metal coating



05-118
ZIEGLER
Head band of plastic, black only
05-119
ZIEGLER
Head band of plastic, white only



05-120
MURPHY
Head band of celluloid, white only



05-121
Head band of plastic,
white, soft pattern



05-122
Head mirror (05-116)
with black plastic head
band (05-118)



05-122A
Calibrated with velcro cuff, in bag
with manometer
05-122B
Non calibrated with velcro cuff, in bag
with manometer



05-122C
Calibrated with velcro cuff
mercury tube 300 mm,
also available with auto lock
05-122D
Non calibrated with velcro cuff
mercury tube 300 mm,
also available with auto lock



05-126
spare bulb

05-123
CLAR
Head light, 6 volt, with adjustable joint,
white celluloid head band,
cord with plugs for transformer 04-05-139 and 140

05-124
White celluloid head band, only, for 04-05-123

05-125
Spare mirror only, for 04-05-123



05-131
spare bulb

05-127
CLAR
Head light, 6 volt, with adjustable joint,
white celluloid head band, with foam rubber pad
and cord with plugs for transformer 05-139 and 140

05-128
White celluloid head band, only, for head light 05-127

05-129
mirror only, for head light 05-127

05-130
spare foam rubber pad, for head band 05-128



05-133
spare bulb

05-132
JANSEN
Head light, 6 volt, with adjustable joint,
white plastic head band,
cord with plugs for transformer 05-139 and 140



05-135
spare bulb

05-134
LANGENBECK
Head light, 3.7 volt, with
adjustable joint,
white plastic head band,
cord with plugs for
transformer 05-139 and 140



05-136
HERBERHOLD
Pocket-Accu, 6 volts, with cord 05-137 for head lights
05-132 05-123 05-127



05-137
Extension cord only, to connect
the accu to the cord of the head lights
05-132 05-123 05-127



05-138
Charging Set for pocket
accu 05-136
mains current: 220-240
volts, 50-60 Hz



05-139
220 volt / 220 volts
05-140
120 volt / 120 volts
Transformer

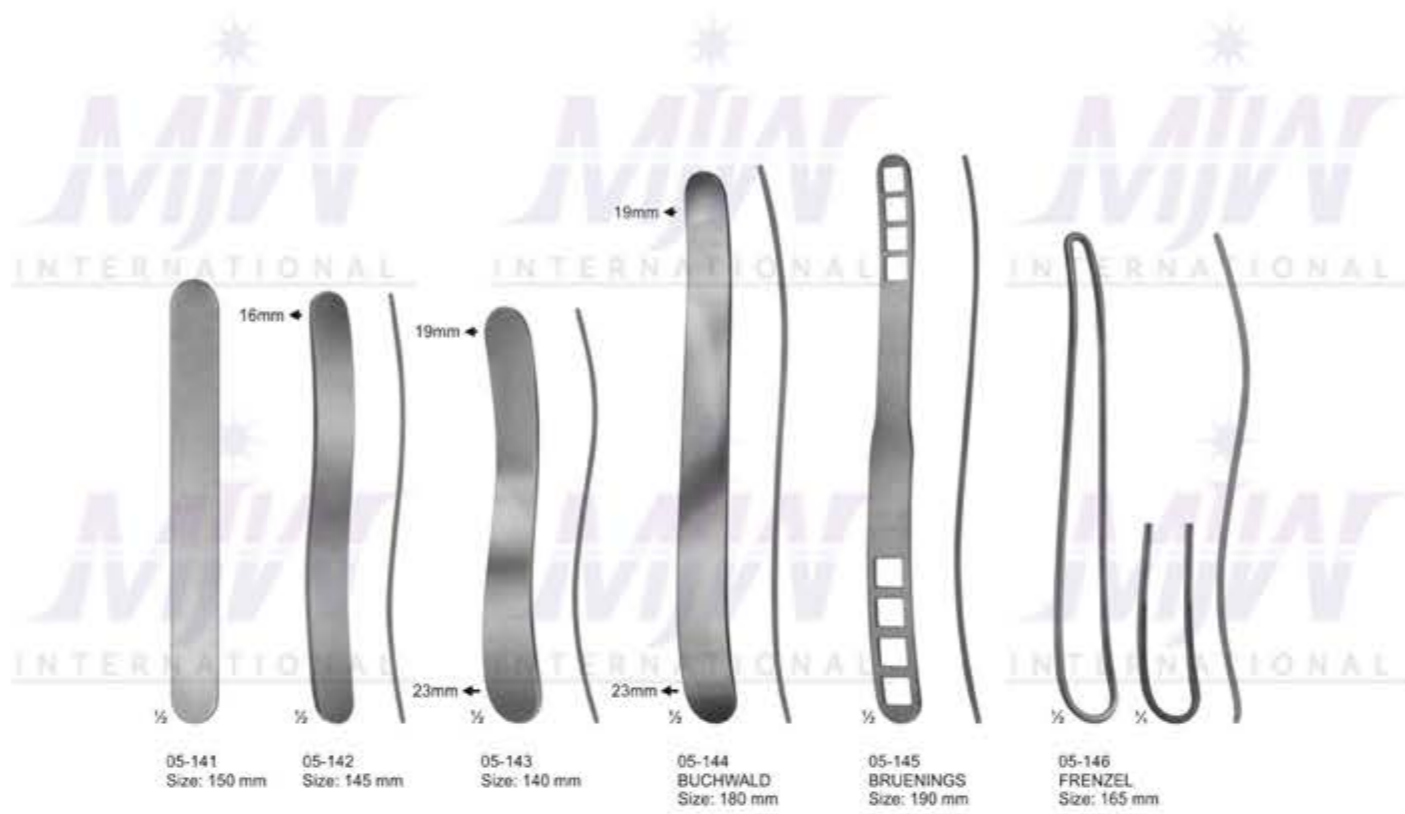





05-182
MILLER
Laryngoscope Set, Consists Of Battery Handle (Without Battery)
With Four Miller Laryngoscope Blades, Fig 1 to 4
05-182F
Fiber optic Laryngoscope set with medium handle
Set of 4



05-182 A Fig. 0 Working Length, 55 mm (Baby's)
05-182 B Fig. 1 Working Length, 80 mm (Children's)
05-182 C Fig. 2 Working Length, 130 mm (Adolescent's)
05-182 D Fig. 3 Working Length, 170 mm (Women's)
05-182 E Fig. 4 Working Length, 180 mm (Men's)



05-183
GUEDEL-NEGUS
Laryngoscope Set, Consists Of Battery Handle (Without Battery)
With Four Miller Laryngoscope Blades
05-183F
Fiber optic Laryngoscope set with medium handle
Set of 4



05-183 A Fig. 1 Working Length, 70 mm (Children's)
05-183 B Fig. 2 Working Length, 90 mm (Adolescent's)
05-183 C Fig. 3 Working Length, 110 mm (Women's)
05-183 D Fig. 4 Working Length, 135 mm (Men's)



05-184
McINTOSH
Laryngoscope Set, Consists Of Battery Handle (Without Battery)
With Three McIntosh Blades, Fig. 1, Fig. 2, Fig. 3
05-184F
Fiber optic laryngoscope set with medium handle (Without Battery)
With Three McIntosh Blades, Fig. 1, Fig. 2, Fig. 3
05-185
McINTOSH
Laryngoscope Set, Consists Of Battery Handle (Without Battery)
With Five McIntosh Blades, Fig. 0, Fig. 1, Fig. 2, Fig. 3, Fig. 4
05-185F
Fiber optic laryngoscope set with medium handle (Without Battery)
With Three McIntosh Blades, Fig. 1, Fig. 2, Fig. 3



05-185 A Fig. 0 Working Length, 55 mm (Baby's)
05-185 B Fig. 1 Working Length, 75 mm (Children's)
05-185 C Fig. 2 Working Length, 90 mm (Adolescent's)
05-185 D Fig. 3 Working Length, 110 mm (Women's)
05-185 E Fig. 4 Working Length, 135 mm (Men's)



05-186
FOREGGER
Laryngoscope Set, Consists Of
Battery Handle (Without Battery)
With Three Foregger Blades,
Fig. 1, Fig. 2, Fig. 3.



05-186 A Fig. 1 Working Length, 70 mm (Children's)
05-186 B Fig. 2 Working Length, 90 mm (Adolescent's)
05-186 C Fig. 3 Working Length, 110 mm (Women's)
05-186 D Fig. 4 Working Length, 135 mm (Men's)

05-187
FOREGGER
Laryngoscope Set, Consists Of
Battery Handle (Without Battery)
With Four Foregger Blades,
Fig. 1, Fig. 2, Fig. 3, Fig. 4.







13-06-111
Size: 255 mm
wooden handle.

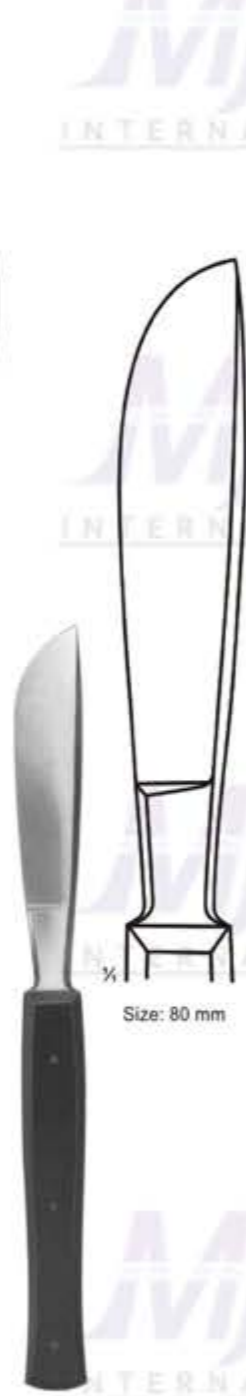

13-06-112
210mm
with wooden handle



13-06-113 - 115
WALB
with wooden handle

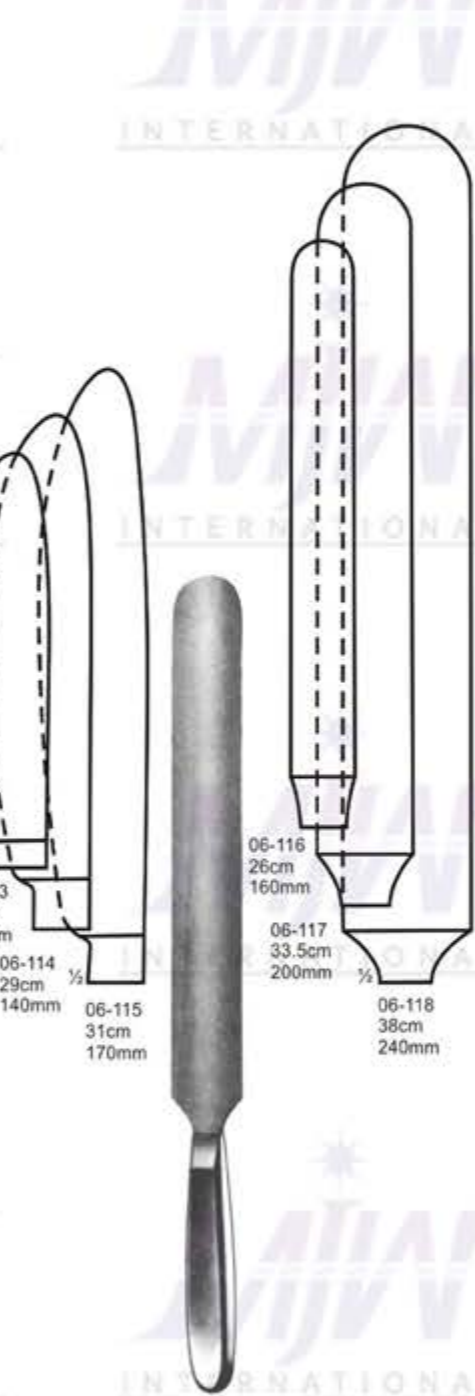

13-06-116 - 118
VIRCHOW
with hollow handle



06-119 - 124
GRAEFE
Size: 130 mm



06-125 - 126
DIEFFENBACH
Size: 160 mm



06-128
Size: 180 mm
Langenbeck
Length of Blade
55 mm

06-129
Size: 180 mm
Langenbeck
Length of Blade
55 mm









	SECTION	PAGE
Scissors	07	23-51
Forceps		
Clamps	8-9-10	52-95

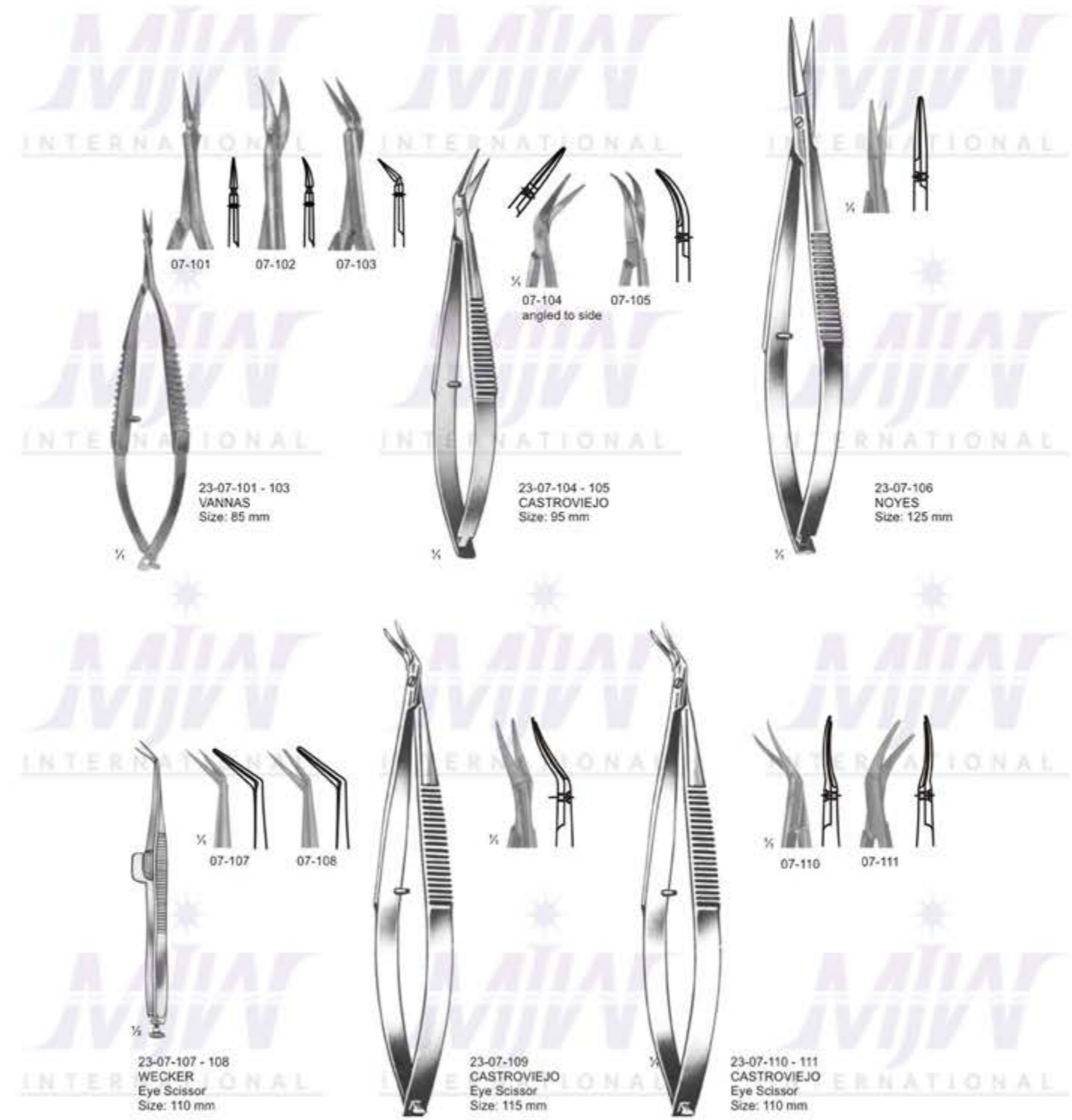

23-07-101 - 103
VANNAS
Size: 85 mm

23-07-104 - 105
CASTROVIEJO
Size: 95 mm

23-07-106
NOYES
Size: 125 mm

23-07-107 - 108
WECKER
Eye Scissor
Size: 110 mm

23-07-109
CASTROVIEJO
Eye Scissor
Size: 115 mm

23-07-110 - 111
CASTROVIEJO
Eye Scissor
Size: 110 mm

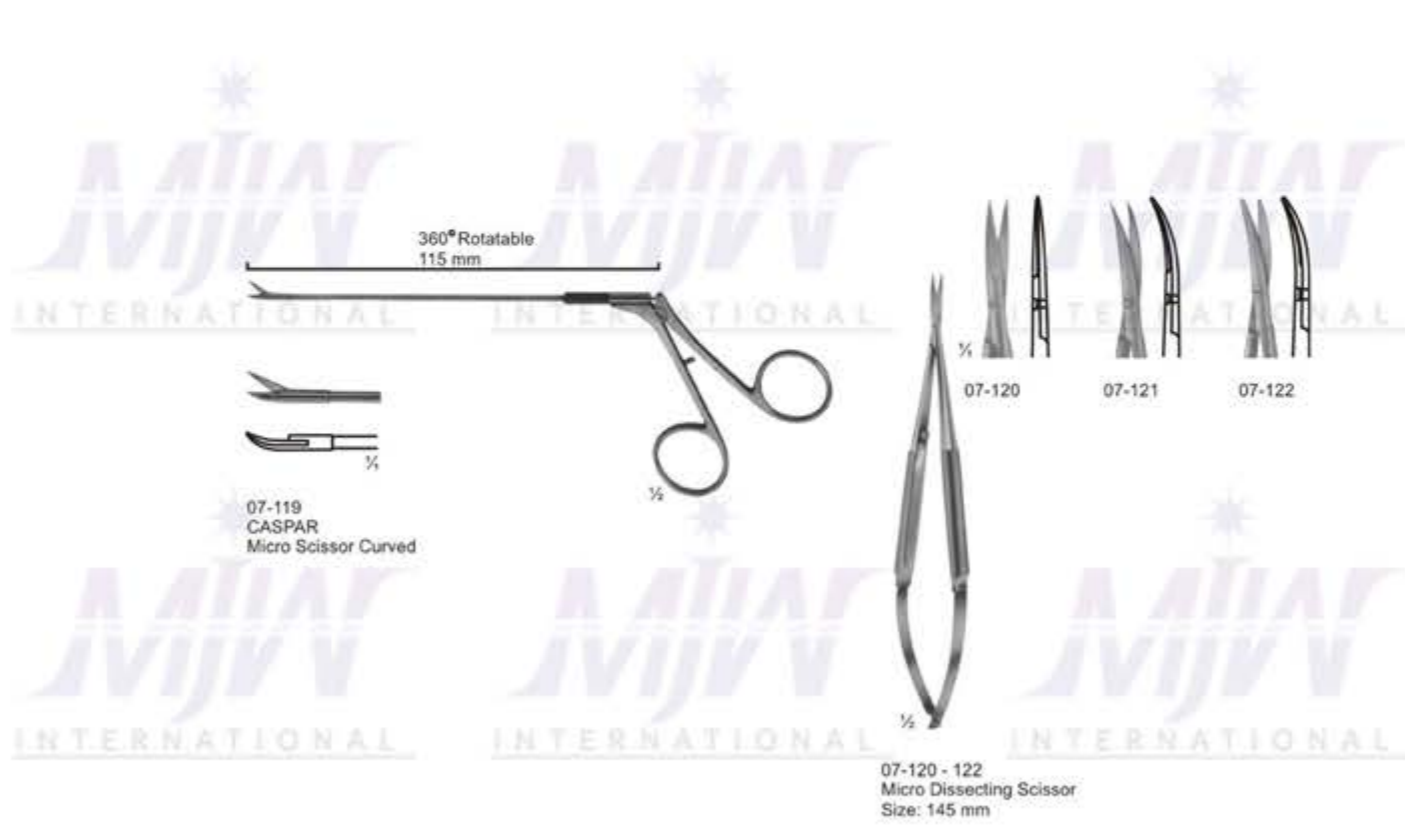







07-163 - 171 (Standard Types)
 07-163 (105 mm)
 07-164 (115 mm)
 07-165 (130 mm)
 07-166 (145 mm)
 07-167 (150 mm)
 07-168 (165 mm)
 07-169 (175 mm)
 07-170 (185 mm)
 07-171 (200 mm)

07-163
 Size: 105 mm

07-171
 Size: 200 mm

07-172 - 178 (Standard Types)
 07-172 (115 mm)
 07-173 (130 mm)
 07-174 (145 mm)
 07-175 (150 mm)
 07-176 (165 mm)
 07-177 (175 mm)
 07-178 (185 mm)

07-172
 Size: 115 mm

07-178
 Size: 185 mm



07-179 - 182
 Slender Types

07-179 130 mm
 07-180 145 mm
 07-181 130 mm
 07-182 145 mm

07-183 - 184
 For Wound Edges
 1 Blade Serrated

07-183 130 mm
 07-184 130 mm



31-07-185 (130 mm)
 31-07-186 (145 mm)
 31-07-187 (150 mm)
 31-07-188 (165 mm)
 31-07-189 (175 mm)
 (Standard Types)

31-07-185
 Size: 130 mm

31-07-189
 Size: 175 mm

COOPER
 Standard Types
 31-07-190 (115 mm)
 31-07-191 (130 mm)
 31-07-192 (145 mm)
 31-07-193 (150 mm)
 31-07-194 (165 mm)
 31-07-195 (175 mm)

31-07-190
 Size: 115 mm

31-07-195
 Size: 175 mm



Standard Types
 31-07-196 (115 mm)
 31-07-197 (130 mm)
 31-07-198 (145 mm)
 31-07-199 (150 mm)
 31-07-200 (165 mm)
 31-07-200A (115 mm)
 31-07-201 (130 mm)
 31-07-201A (145 mm)
 31-07-202 (150 mm)
 31-07-202A (165 mm)

31-07-196
 Size: 115 mm

31-07-200
 Size: 165 mm

31-07-200A
 Size: 115 mm

31-07-202A
 Size: 165 mm



07-203
Size: 145 mm

07-204
Size: 145 mm



07-205
Size: 145 mm

07-206
Size: 145 mm



07-211
LITTLER
Dissecting Scissors
Tips with eye for suture
Size: 115 mm

07-212
COTTLE
Bulldog Scissors
Size: 115 mm

STEVENS-GRADLE
07-213 Sharp/Sharp, straight
07-213A Blunt/Blunt, straight
07-214 Sharp/Sharp, curved
07-214A Blunt/Blunt, curved
10 cm
Ribbon Tenotomy scissor



07-207
Size: 130mm

07-208
Size: 145mm

07-209
Size: 165mm

07-210 (130 mm)
SYSTRUNK
Nail Splitting Scissors



07-215
STEVENS
Fine Dissecting Scissors
Size: 110 mm



07-216
Sharp

07-217
Sharp

07-218
Blunt

07-219
Blunt

07-216 - 219
STEVENS
Vessel and tendon Scissors
Size: 110 mm



07-220
Size: 125 mm

07-221
Size: 150 mm

145 mm
175 mm

07-220 - 221
KILNER
Special flat points for dissecting
and undermining the skin

07-222
KILNER
Fine dissecting scissors
Size: 115 mm

07-223
JAMESON
Dissecting scissors
Size: 150 mm

07-224 145mm
07-225 175mm
REYNOLDS
Dissecting scissors



07-232
Size: 115 mm

07-233
Size: 135 mm

07-234

07-235

07-232 - 233
FOMON
Lower lateral scissors

07-234 - 235
LANDOLT
Enucleation scissors
Size: 120 mm



07-227
Very delicate

07-228
Delicate

07-229
Very delicate

07-230
Delicate

07-231
Delicate

07-226
DE BAKEY
Ateriotomy scissors
Size: 175 mm

07-227 - 228
TOENNIS - ADSON
Dissecting scissors
Size: 175 mm

07-229 - 231
TOENNIS
Dissecting scissors
Size: 180 mm



MAYO(straight)
07-236 (140 mm)
07-237 (155 mm)
07-238 (170 mm)

MAYO(curved)
07-239 (140 mm)
07-240 (155 mm)
07-241 (170 mm)

MAYO-STILLE(straight)
07-242 (140 mm)
07-243 (170 mm)

MAYO-STILLE(curved)
07-244 (140 mm)
07-245 (170 mm)



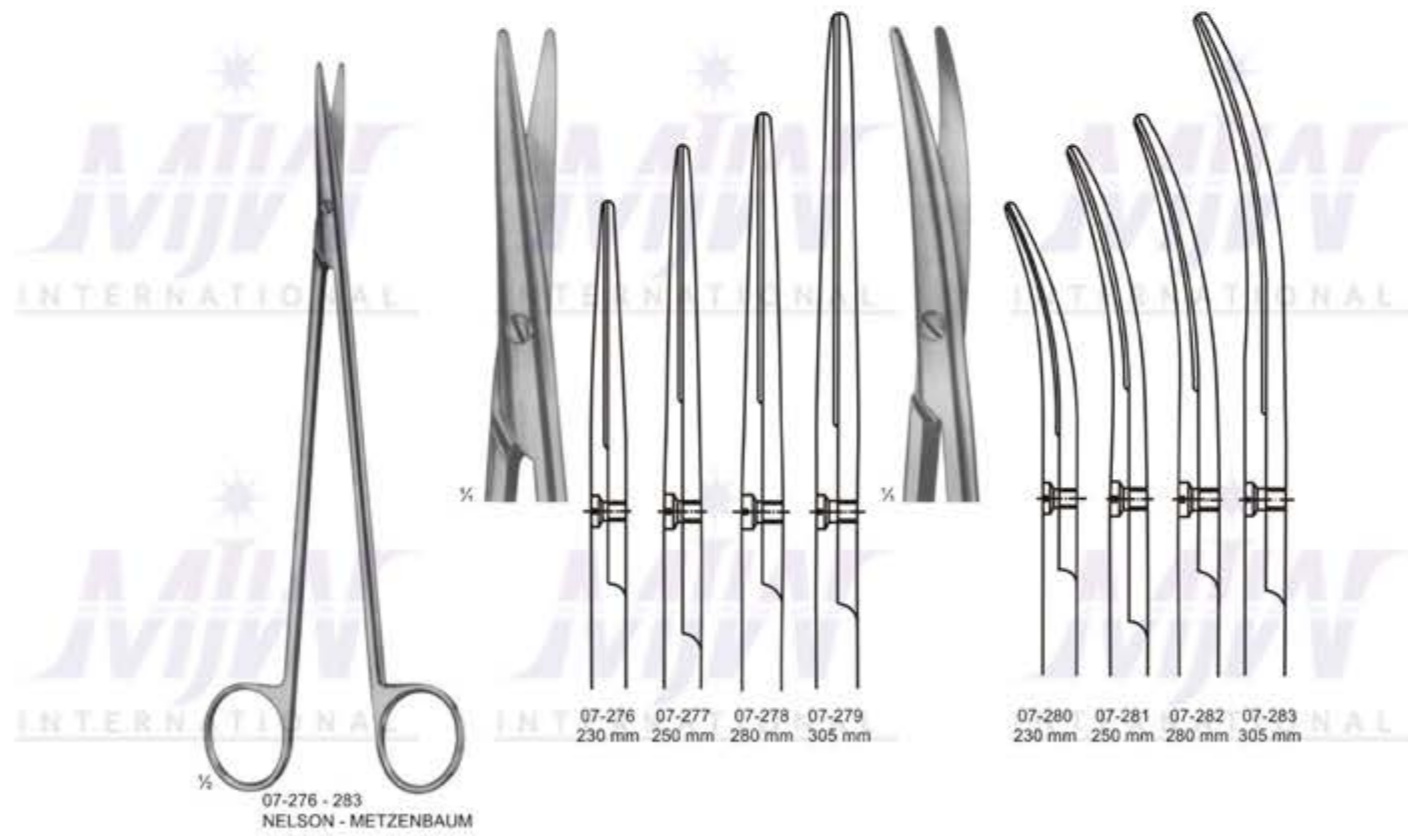



07-293
OLIVECRONA
Dura Scissors

07-294
STRULLY
Pointed
Size: 220 mm

07-295
STRULLY
Probe Pointed
Size: 220 mm



07-299
1 Finely Toothed Blade
Size: 130 mm

07-300
LOCKLIN
Curved Sideways,
1 Toothed Blade
Size: 155 mm

07-301
FOMON
Blades Serrated
Size: 145 mm

07-302
COTTLE
Size: 165 mm



07-296
THOREK
Size: 180 mm

07-297
POTTS-SMITH
Size: 190 mm

07-298
SATINSKY
Size: 245 mm



07-303
HEYMANN-KNIGHT
Size: 175 mm

07-304
DEAN
Blades Serrated
Size: 170 mm

07-305
GOOD
Size: 195 mm



07-306
KILLIAN
Size: 200 mm



07-307 - 308



07-307
195 mm



07-308
225 mm



07-309 - 312
SIMS

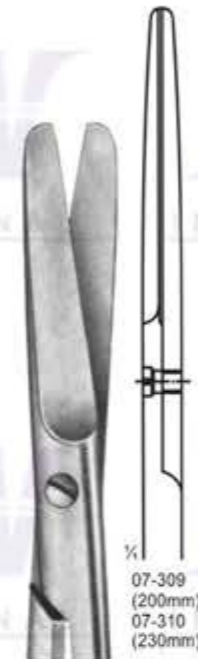

07-309
(200mm)

07-310
(230mm)



07-311
(200mm)

07-312
(230mm)



07-313 - 316
SIMS



07-313
(200mm)

07-314
(230mm)



07-315
(200mm)

07-316
(230mm)



07-317
SIMS



Size: 200 mm



07-318
SIMS



Size: 210 mm



07-319 - 321
WERTHEIM



07-319 145 mm
07-320 200 mm
07-321 230 mm

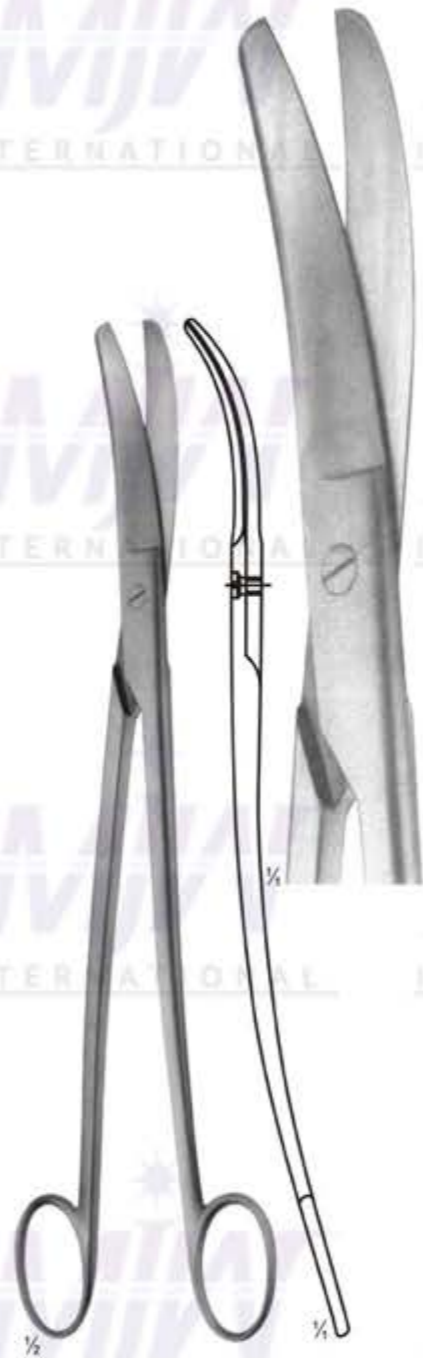

07-322
SIEBOLD
Uterine Scissors
Size: 245 mm



07-323
BOZEMANN
Uterine Scissors
Size: 220 mm

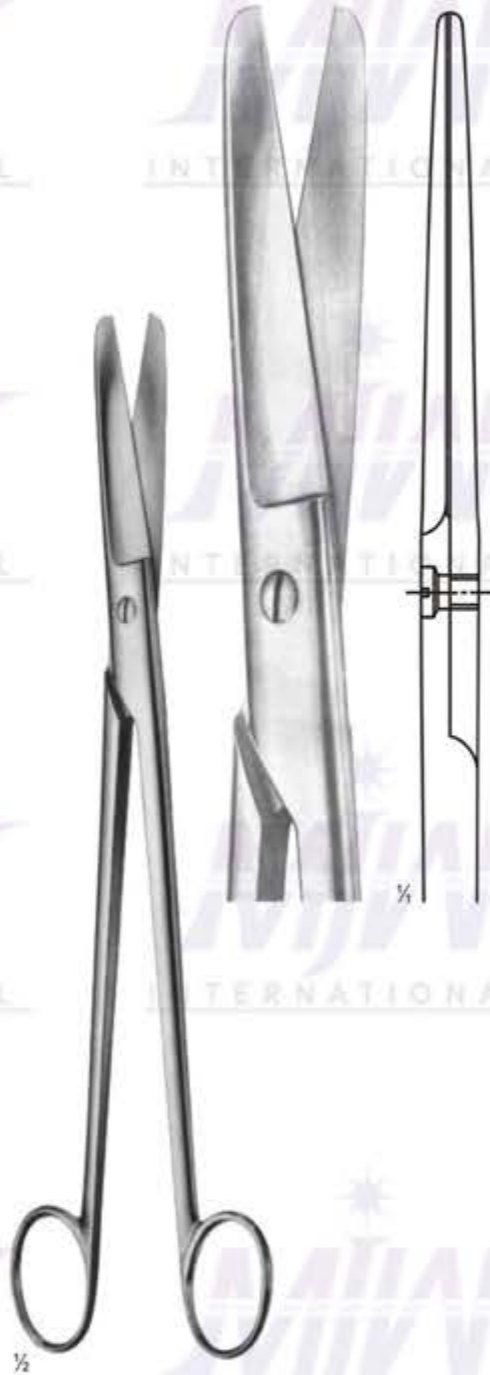

07-324
SIMS-SIEBOLD
Uterine Scissors
Size: 250 mm



07-325
SCHUMACHER
Umbilical Cord Scissors
Size: 155 mm



07-326
Umbilical Cord Scissors
Size: 105 mm

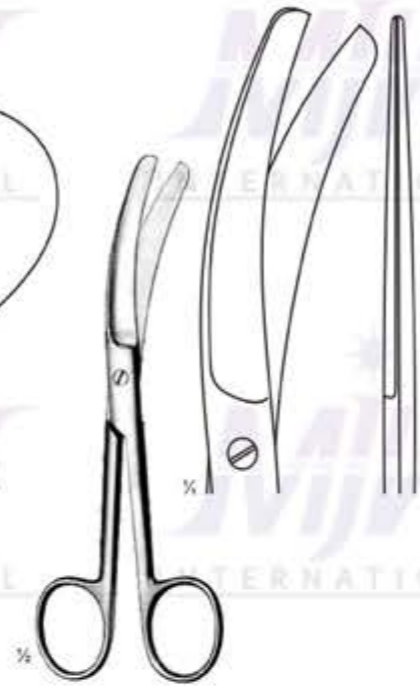

07-327
Umbilical
Cord Scissors
135 mm



BRAUN-STADLER
07-328
14.5 cm / 5 1/2"
07-329
18 cm / 7 1/4"

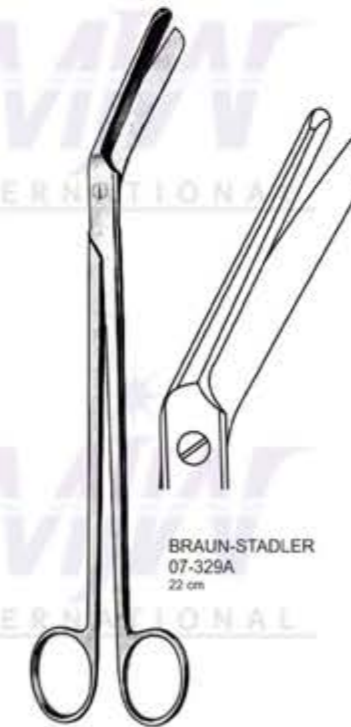

BRAUN-STADLER
07-329A
22 cm



07-330
EPISIOTOMY
SCISSORS
240 mm





07-340 - 344
BEEBE
Size: 110 mm

07-340

07-341

07-342
Broad Blades

07-343
1 Blade Serrated

07-344
NAUJOKS
Strongly Curved



07-348
NAIL SCISSORS
Size: 90 mm

07-349
NAIL SCISSORS
especially fine pattern
Size: 90 mm

07-350
BABY NAIL
SCISSORS
Size: 85 mm

07-351 - 354
NAIL SCISSORS
07-351(90mm) str
07-352 (90mm) cvd
07-353 (100mm) str
07-354 (110mm) cvd

07-355 - 357
NAIL SCISSORS
07-355 (95mm) str
07-356 (95mm) cvd
07-357 (105mm) str



07-345
1 Blade Serrated
Size: 120 mm

07-346
STRACK
Size: 100 mm

07-347
HARVEY
blades serrated
Size: 125 mm



07-358
KNOWLES
Size: 140 mm

07-359
KNOWLES
Size: 145 mm

07-360
Size: 150 mm

07-361
SMITH
Size: 180 mm

07-362
BANDAGE CUTTING
SCISSORS
Size: 310 mm



07-363
UNIVERSAL BANDAGE & CLOTH SCISSORS,
WITH TOOTHED EDGES, AUTO CLEAVABLE up to 143°C
180 mm



07-364
LISTER BANDAGE & CLOTH
SCISSORS, WITH TOOTHED EDGES,
AUTO CLEAVABLE up to 143°C
Size: 145 mm



07-365
NURSE'S SCISSORS
Size: 145 mm
AUTO CLEAVABLE up to 143°C



07-372
CLOTH SCISSORS
205 mm



07-373
SMITH
(Mod. USA)
20 cm



07-374
SEUTIN
Plaster scissors
230 mm



07-366
115 mm



07-367
140 mm



07-368
180 mm



07-369
200 mm

07-366 - 369
LISTER



07-370
155 mm



07-371
180 mm

07-370 - 371
LISTER



07-375
200 mm



07-376
230 mm

07-375 - 376
ESMARCH (Plaster scissors)



235 mm



07-378
BANDAGE SCISSORS
235 mm



















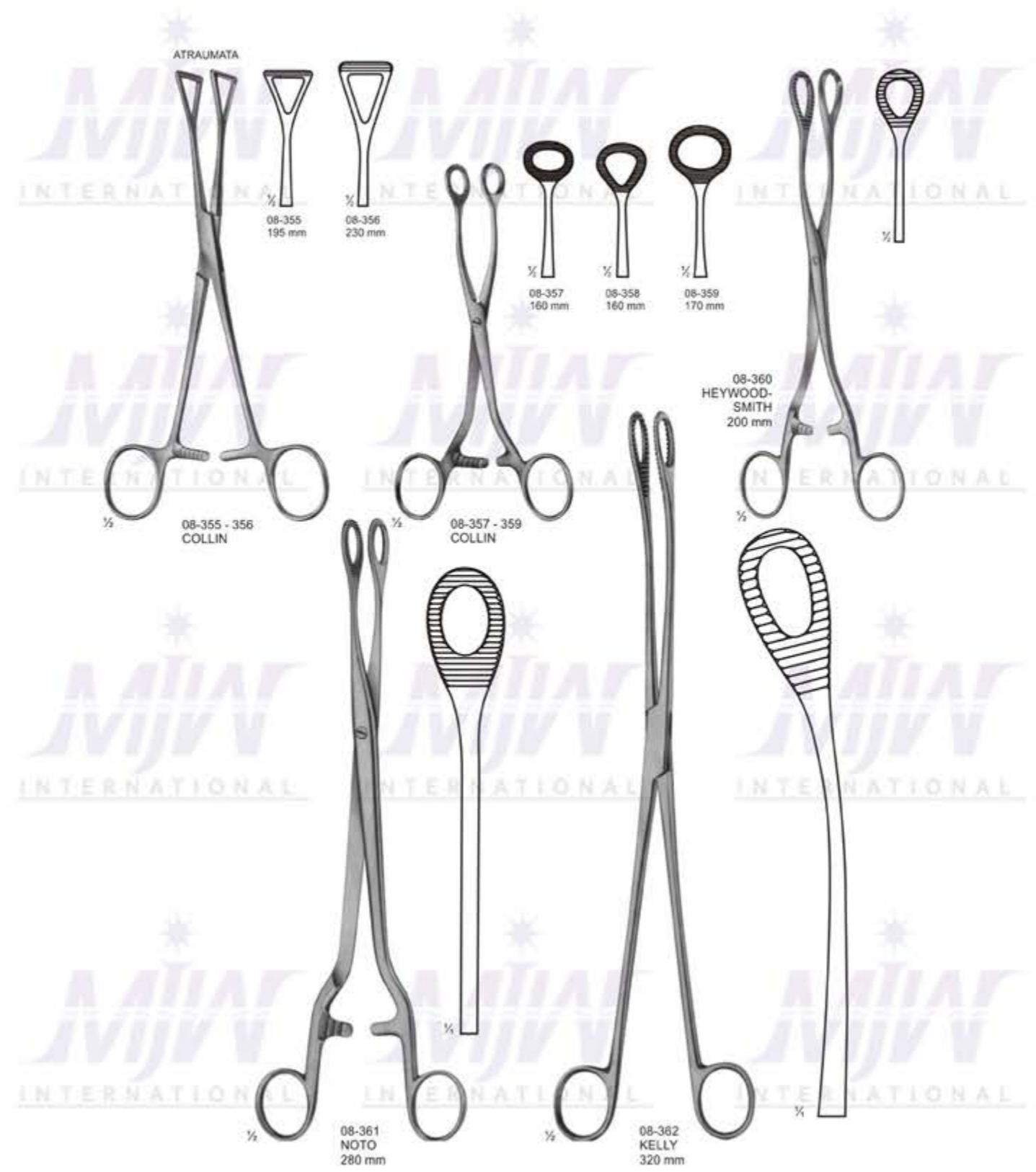

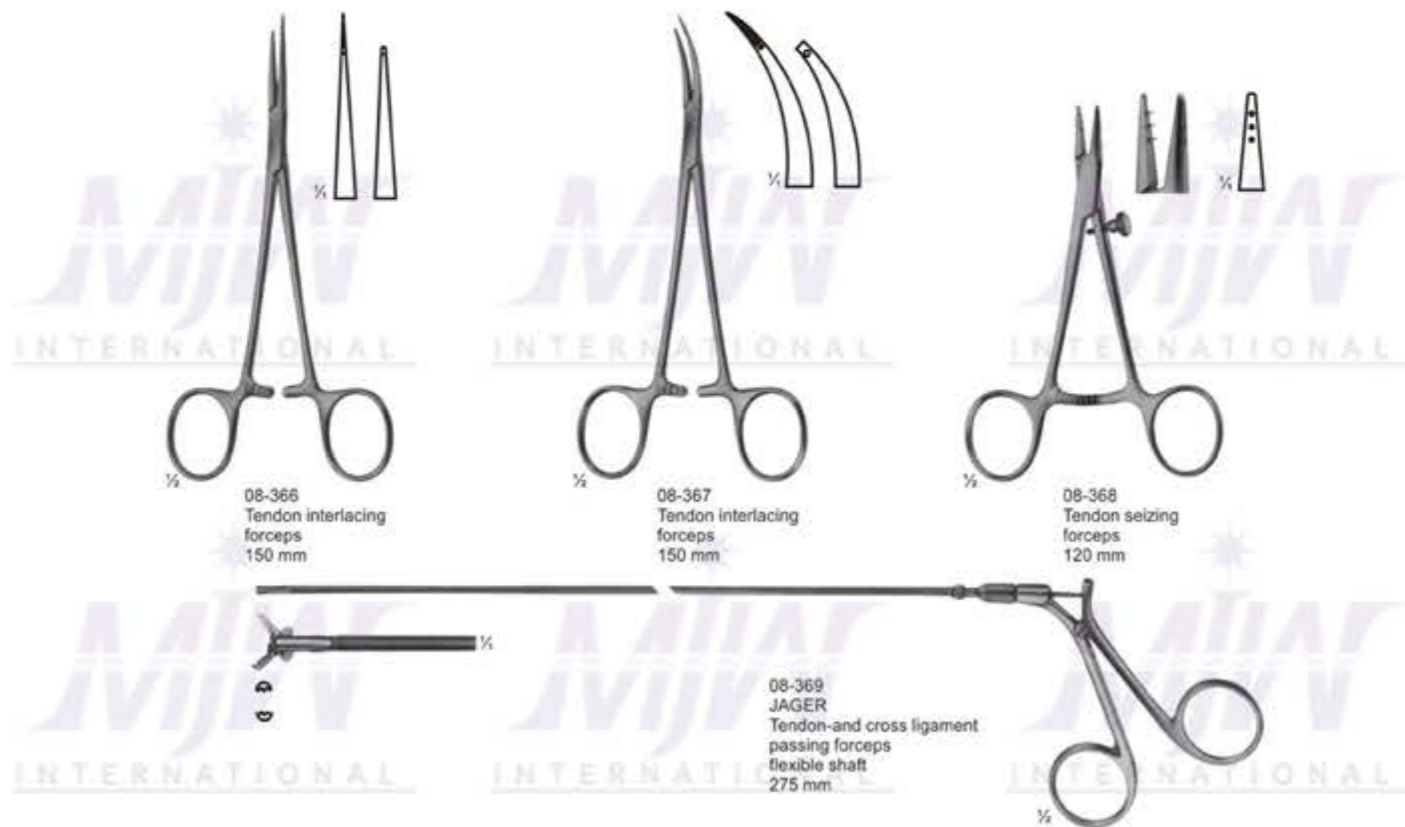





Closing force



09-148 35 mm

09-149 35 mm

09-150 45 mm

09-151 45 mm

09-154 GLOVER
Length 57 mm
Jaws 35 mm

09-155 DE BAKEY
Length 73 mm
Jaws 38 mm

09-156 DE BAKEY
Length 99 mm
Jaws 63 mm

DE BAKEY	Total length	Length of jaw
09-158	80mm	25mm
09-159	90mm	35mm
09-160	105mm	50mm
09-161	124mm	68mm

DE BAKEY	Total length	Length of jaw
09-162	78mm	25mm
09-163	86mm	35mm
09-164	97mm	50mm
09-165	114mm	68mm

GLOVER	Total length	Length of jaw
09-166	68mm	33mm
09-167	96mm	50mm
09-168	117mm	69mm

DE BAKEY
09-152 Length 50 mm Jaws 27 mm

DE BAKEY
09-153 Length 48 mm Jaws 27 mm

09-157 DE BAKEY
Length 95 mm
Jaws 54 mm

GLOVER	Total length	Length of jaw
09-169	65mm	33mm
09-170	91mm	50mm
09-171	110mm	69mm

10-101 CARREL 85 mm

10-102 - 105 BABY-MOSQUITO (HARTMANN) 100 mm

10-106 - 109 MICRO-HALSTED 125 mm

8.5 cm 14 cm 16.5 cm

8.5 cm 14 cm

8.5 cm 8.5 cm 8.5 cm

10-110 - 113 HALSTED-MOSQUITO 125 mm

10-114 - 115 PROVIDENCE-HOSPITAL 140 mm

10-116 - 117 KELLY 140 mm

10-118 - 119 DANDY Curved sideways 140 mm

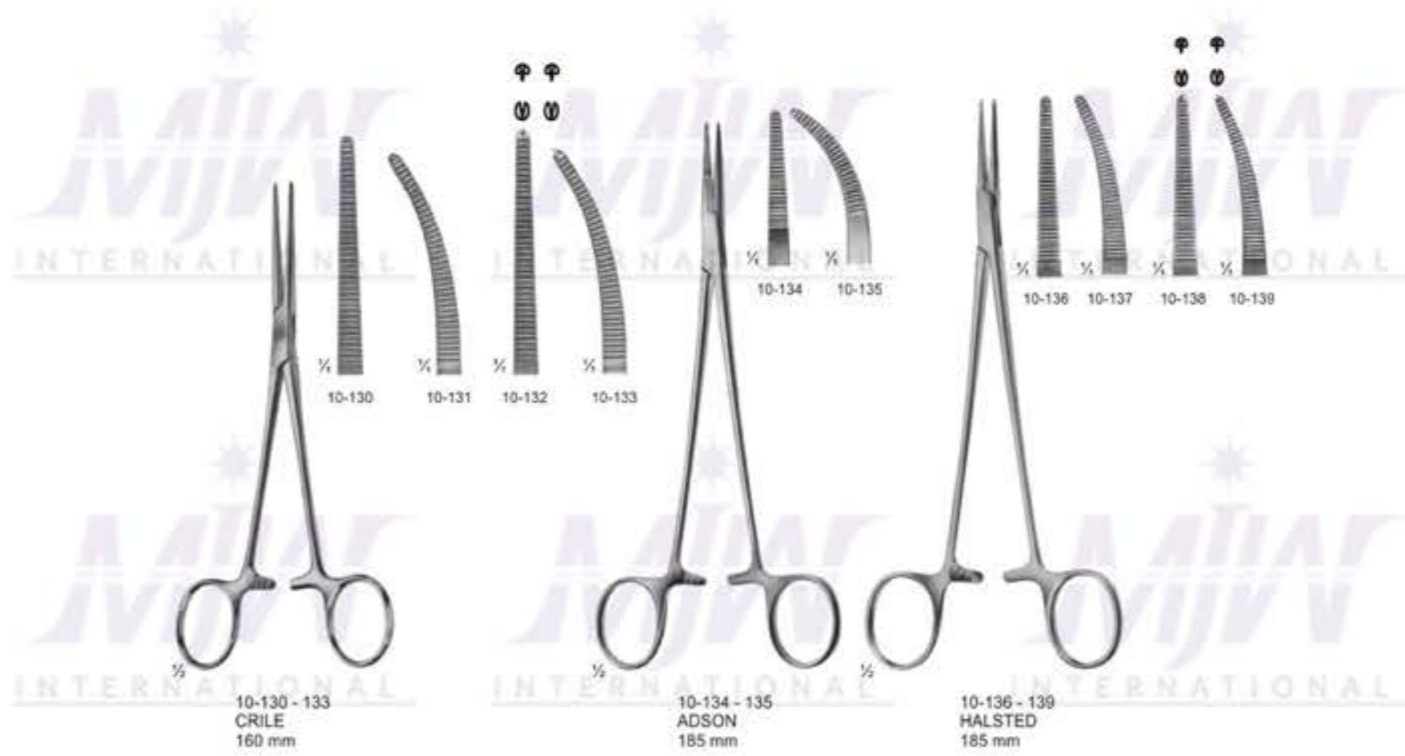



10-156
FRICKE
Artery forceps
130 mm



10-157
KRONLEIN
130 mm



10-158
PEAN
125 mm



10-164 - 167
PEAN
Slender type



10-168 - 175
SPENCER-WELLS



10-159 - 160
PEAN



10-161
PEAN
125mm



10-162 - 163
PEAN



10-176 - 185
ROCHESTER-PEAN

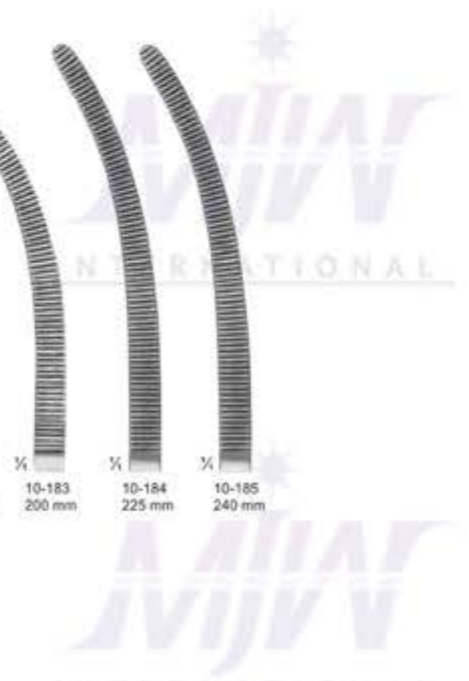
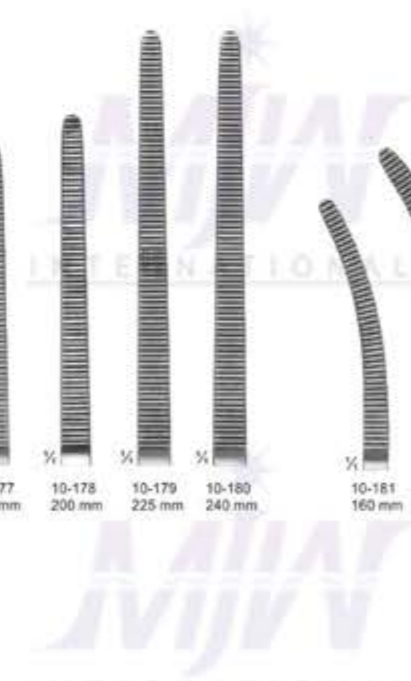



10-186 - 191
PEAN

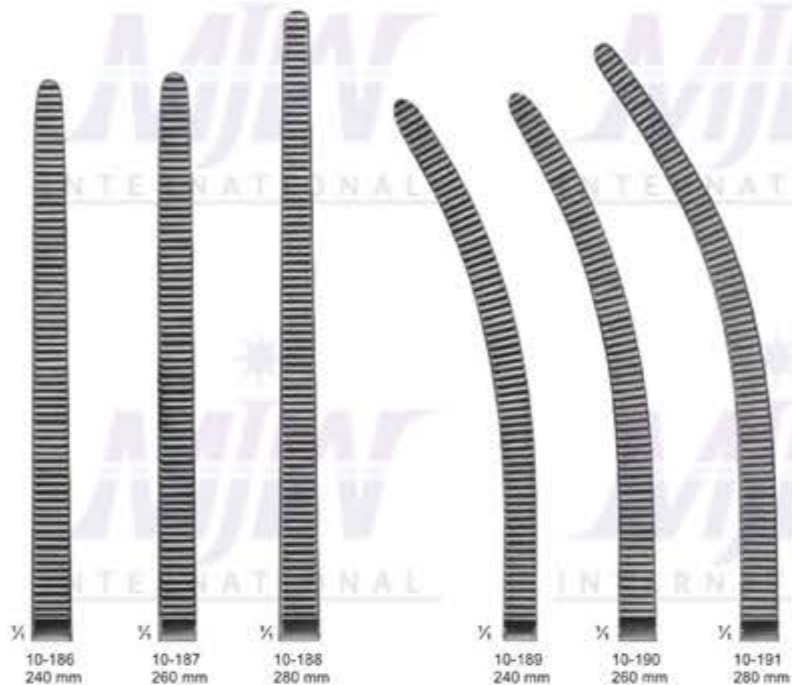

10-192
KOCHER
Strong Pattern
145 mm



10-193 - 195
KOCHER



10-196 - 197
ROCHESTER-OCHSNER
140 mm



10-198 - 209
KOCHER-OCHSNER

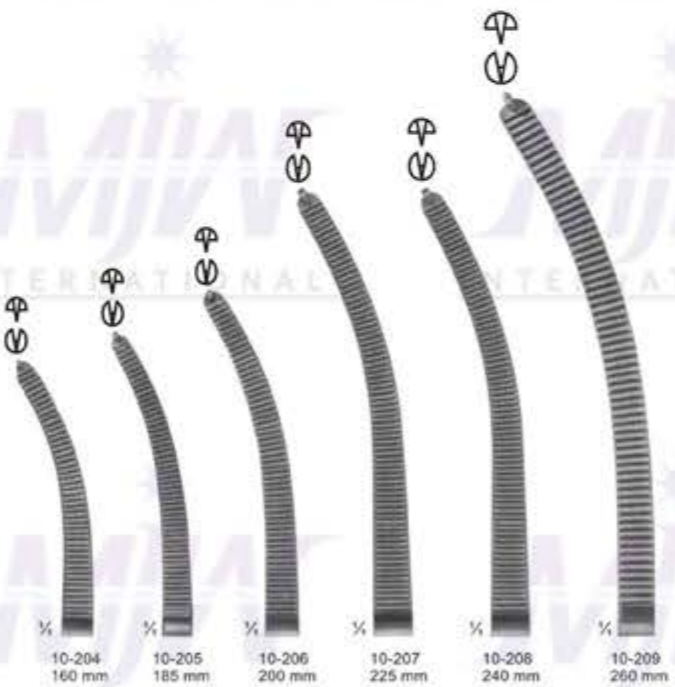
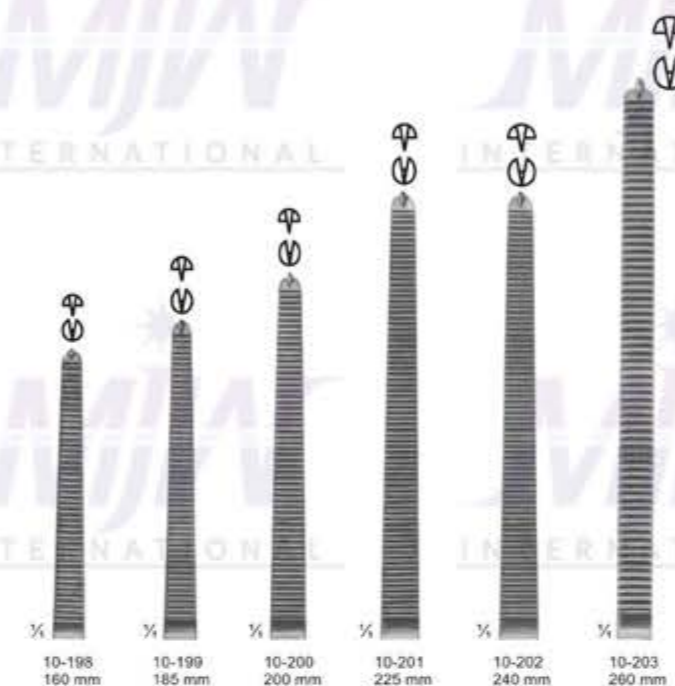

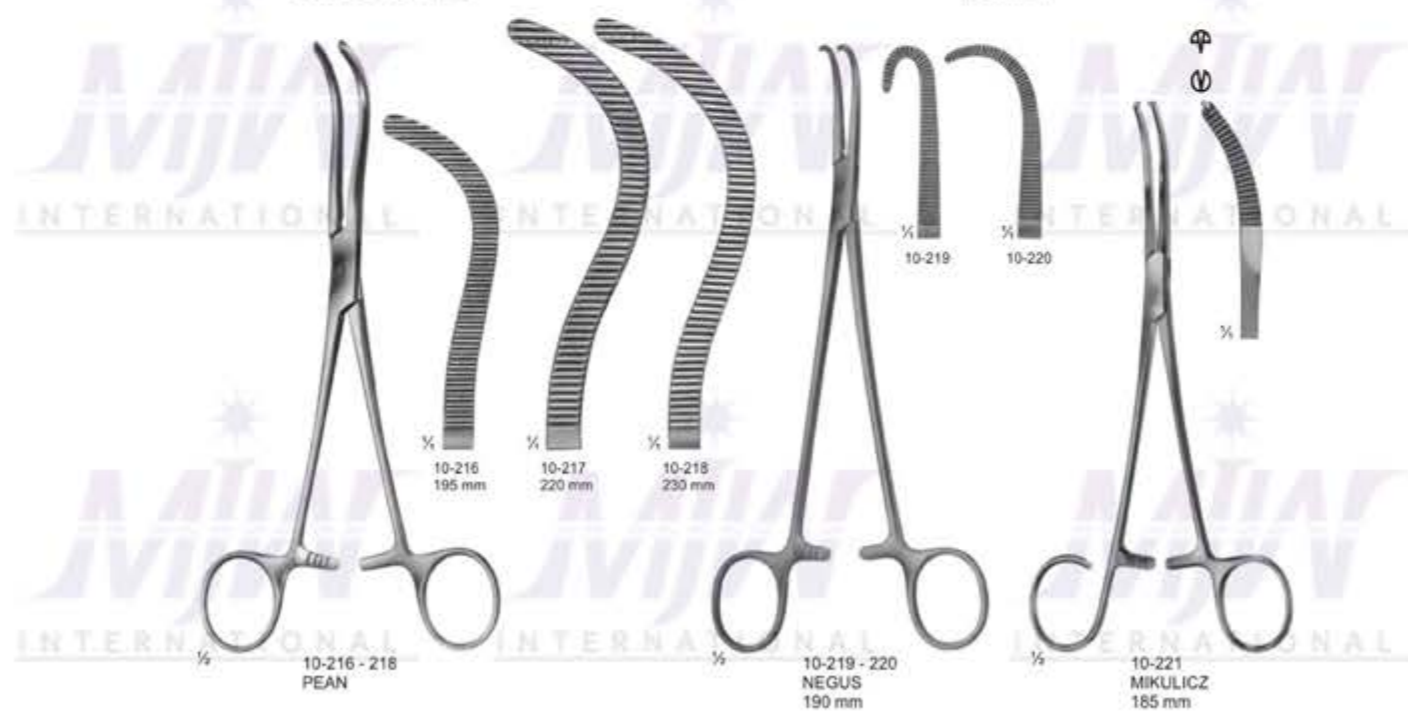



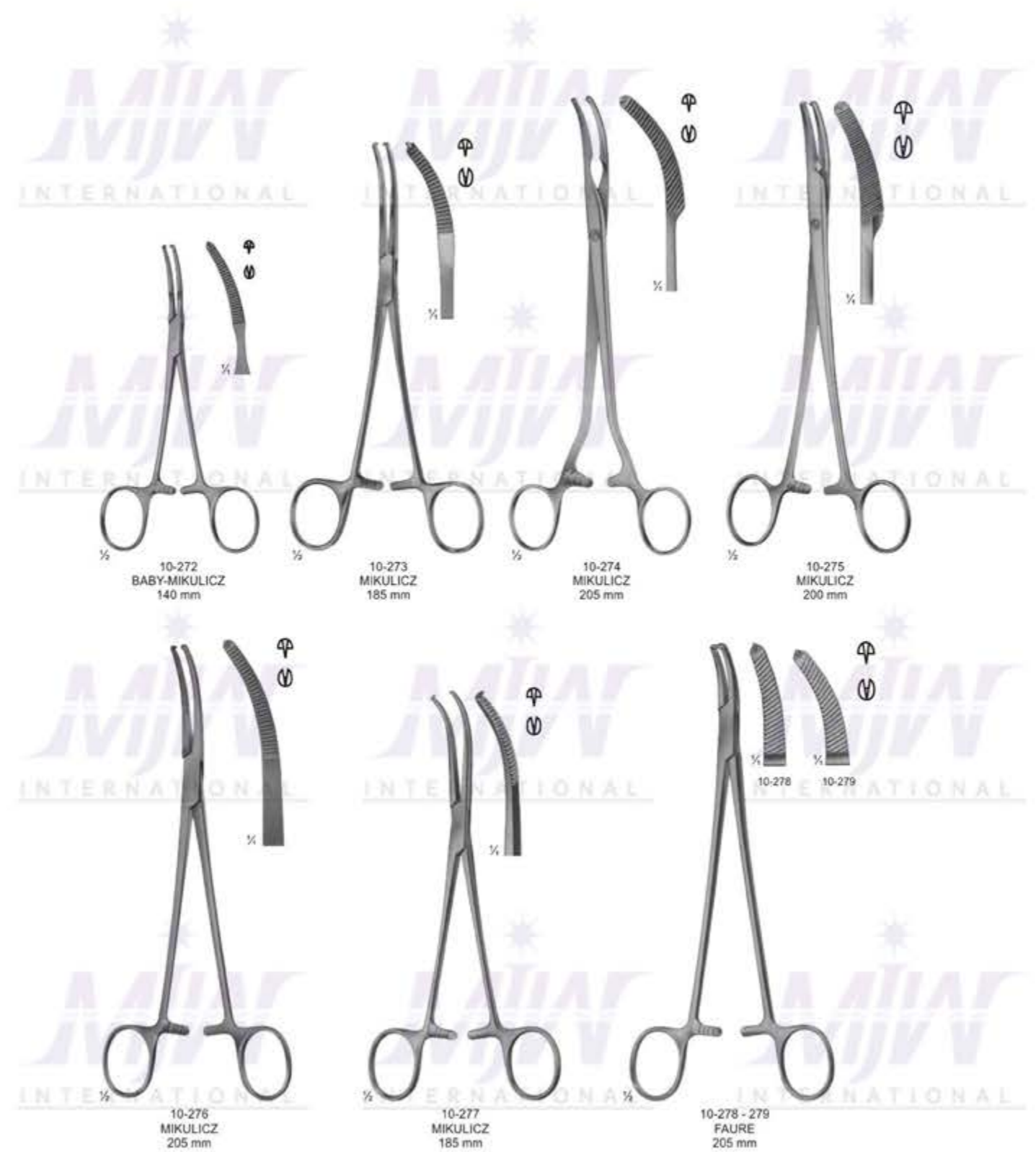



ATRAUMATA



10-296
WERTHEIM
Hysterectomy Forceps
255 mm



10-297
WERTHEIM
Parametrium Clamp
260 mm



10-298 - 300
DICK

10-298 255 mm
10-299 265 mm
10-300 275 mm

ATRAUMATA



10-301
WERTHEIM
250 mm



10-302
WERTHEIM-CULLEN
215 mm



10-303 - 304
230 mm

10-304
80 mm

10-303
60 mm

	SECTION	PAGE
Needle Holders		96-101
Suture Instruments	11	
Probes, Pocket Instruments Set		102-114

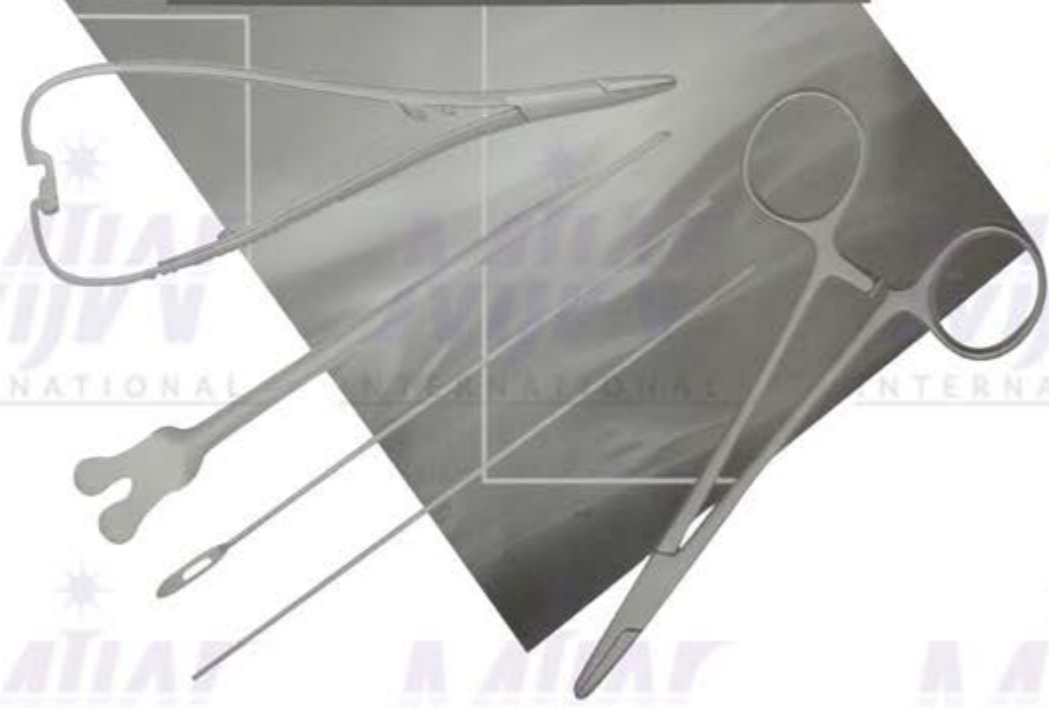







Spare Needles









11-231 - 233
11-231 130 mm
11-232 145 mm
11-233 160 mm
Directors

11-234
DOYEN
145 mm
Directors

11-235
NELATON
160 mm
Directors

11-236
Director with tip
Diam. Of tip 3,3 mm
140 mm

11-237
BRODIE
Director with tip,
Diam. Of tip 3,5 mm
200 mm



Nr. 1
11-238
LOCKHART-MUMMERY
165 mm
Straight

Nr. 2
11-239
LOCKHART-MUMMERY
165 mm
45° Curved

Nr. 3
11-240
LOCKHART-MUMMERY
165 mm
90° Curved

Nr. 4
11-241
LOCKHART-MUMMERY
165 mm
Retrograde Curved

11-242
Director with wire
loop, malleable
190 mm

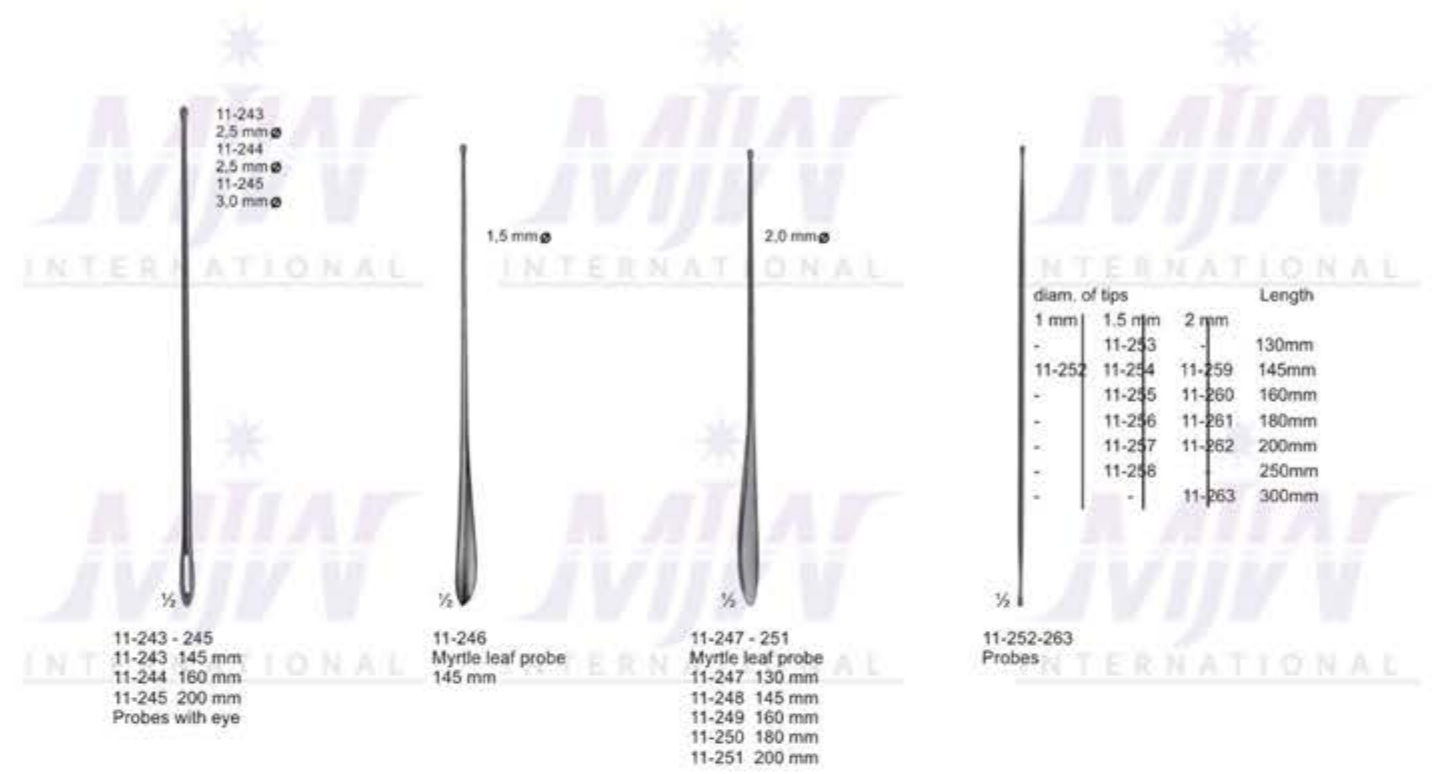

11-243
2,5 mm
11-244
2,5 mm
11-245
3,0 mm

11-243 - 245
11-243 145 mm
11-244 160 mm
11-245 200 mm
Probes with eye

11-246
Myrtle leaf probe
145 mm

11-247 - 251
Myrtle leaf probe
11-247 130 mm
11-248 145 mm
11-249 160 mm
11-250 180 mm
11-251 200 mm

diam. of tips			Length
1 mm	1,5 mm	2 mm	
-	11-243	-	130mm
11-252	11-244	11-259	145mm
-	11-245	11-260	160mm
-	11-246	11-261	180mm
-	11-247	11-262	200mm
-	11-248	-	250mm
-	-	11-263	300mm

11-252-263
Probes



11-264
Double ended probe,
malleable, diam. of tips
3 mm with hole
190 mm

11-265 - 266
250mm 300mm
Double ended probes,
tin, malleable,
diam. of tips
3,5 mm with hole

11-267
Double ended probe,
tin, malleable,
diam. of tips 4 mm
400 mm

11-268 - 270
11-268 1,5 mm
11-269 2,0 mm
11-270 2,5 mm
300 mm
Probes





11-299
MICHEL
125 mm



11-300
HEGENBARTH
120 mm



11-301
WACHENFELDT
120 mm



11-302
WACHENFELDT
120 mm



11-303
MICHEL
125 mm



11-304
MICHEL modif.
130 mm



11-305
HEATH
135 mm



11-306
COLLIN
135 mm



- 11-307
Suturing instruments set, in metal case consisting of:
1 Michel clip applying and removing forceps,
1 Scissors, curved, sharp/sharp, 115mm
25 MICHEL clips, 16 x 3mm
1 Delicate tissue forceps, 130mm
1 Scalpel, bellied
1 MATHIEU needle holder, 140mm
1 Perforated metal case, stainless containing:
1 Suture needle
1 Suture needle
1 Suture needle



- 11-308
Pocket instrument set, in metal case consisting of:
Bottom tray
1 MATHIEU needle holder, 140mm
1 MICHEL clip forceps, combined
1 Myrtle leaf probe, 130mm
1 Sharp double curette
1 Skin hook
1 Detachable scalpel handle, no.4
1 Perforated metal case, containing
6 Scalpel blades
1 Perforated metal case, stainless, containing
1 Suture needle
1 Suture needle
1 Suture needle



- Top tray
1 Tissue forceps, 130mm
1 KOCHER haemostatic forceps, 130mm
1 Straight surgical scissors, 130mm
1 Dissecting forceps, 130mm
1 FEILCHENFELD splinter forceps, 115mm
25 MICHEL clip, 16 x 3mm
1 Flacon of suture skin, sterile in alcohol



- 11-309
Pocket instrument set, in metal case consisting of:
Bottom tray
1 MAYO-HÉGER needle holder, 150mm
1 MICHEL clip forceps, combined
1 Myrtle leaf probe, 130mm
1 Sharp double curette
1 Skin hook
1 Detachable scalpel handle, no. 4
1 Perforated metal case, consisting
6 Scalpel blades
1 Perforated metal case, stainless, consisting:
1 Suture needle
1 Suture needle
1 Suture needle



- Top tray
1 Tissue forceps, 130mm
1 CRILE haemostatic forceps, 140mm
1 Straight surgical scissors, 130mm
1 Dissecting forceps, 130mm
1 FEILCHENFELD splinter forceps, 115mm
25 MICHEL clip, 16 x 3mm
1 Flacon of suture silk, sterile in alcohol

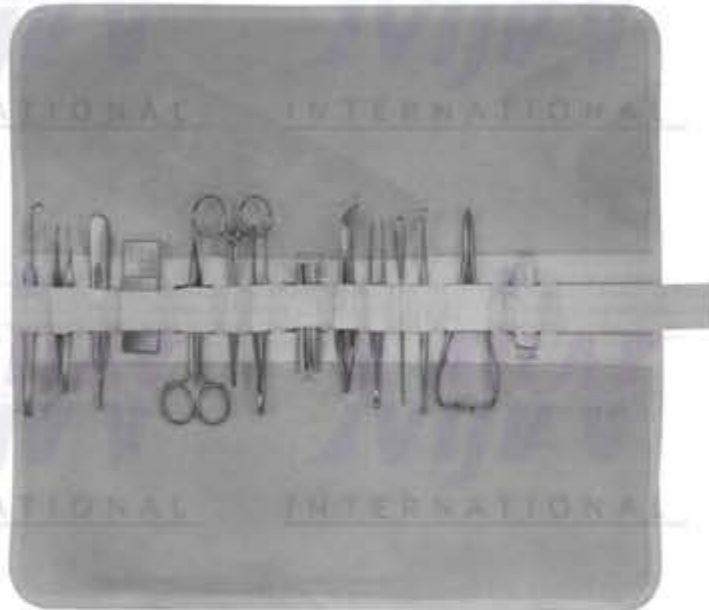

11-310
Pocket instrument set in metal case 170 x 90mm
canvas roll only, sterilizable in autoclave,
consisting of:
1 Myrtle leaf probe, 130mm
1 Sharp double curette
1 FEILCHENFELD splinter forceps, 115mm
1 Dissecting forceps, 130mm
1 Tissue forceps, 130mm

1 Straight surgical scissors, 130mm
1 Scalpel handle no. 4
1 Perforated metal case, consisting
of:
6 scalpel blades
1 KOCHER haemostatic forceps, 130mm
1 Skin hook
1 MATHIEU needle holder, 140mm
1 Tube of suture skin, sterile in alcohol
1 MICHEL clip forceps, 120mm



25 MICHEL clip, 16 x 3mm
1 Perforated metal case, stainless,
consisting:
1 Suture needle
1 Suture needle
1 Suture needle

11-310 A
Canvas roll only, sterilizable in
autoclave

Suitable
Metal Cases



250 x 125 x 55mm



233 x 148 x 57mm

1 DESCHAMPS needle, blunt, 210mm
1 DOYEN Director, curved, 140mm
2 Wound retractors, 4 blunt prongs, 160mm
2 DESMARRES wound retractors, 135mm
1 FINSSEN retractors, 2 x3 blunt prongs, 80mm
1 Scalpel handle no. 4
4 Sterile scalpel blades, no 18, single peel pack
1 Needle box, perforated, round, diam. 65mm
1 HEGAR-MAYO DUROGRIP needle holder, 180mm

11-311 A
Canvas roll only, sterilizable in autoclave



11-311
Venae sectio set, canvas roll only, sterilizable in autoclave,
consisting of:
2 Tissue forceps, 1 x 2 teeth, 140mm
1 Dissecting forceps, 145mm
1 FEILCHENFELD splinter forceps, 115mm
1 Straight scissors, sharp, 110mm
1 Curved scissors, blunt, 115mm
3 HALSTED mosquito forceps, curved on flat, 125mm



11-312
Venae sectio set, in metal case
consisting of:
Bottom tray

1 MATHIEU needle holder, fine pattern 140mm
1 Ligature needle, fine short pattern
1 DOYEN director, curved
1 HEGENBARTH clip forceps,
1 ELSCHNIG tissue forceps, 1 x 2 teeth fine, 105mm
1 Dressing forceps, fine 105mm
1 Tissue forceps, 1 x 2 teeth, 110mm
1 Vessel scissors, straight, with 1 ball point, 110mm
1 Vessel scissors, curved, pointed 105mm
1 FINSSEN retractor
1 Perforated needle case

Top tray

1 Scalpel, pointed
1 Scalpel, bellied
2 HALSTED mosquito forceps, curved, 125mm
2 HALSTED mosquito forceps, straight, 1x 2 teeth, 125mm
3 BACKHAUS towel forceps, 90mm
2 Flacon holder



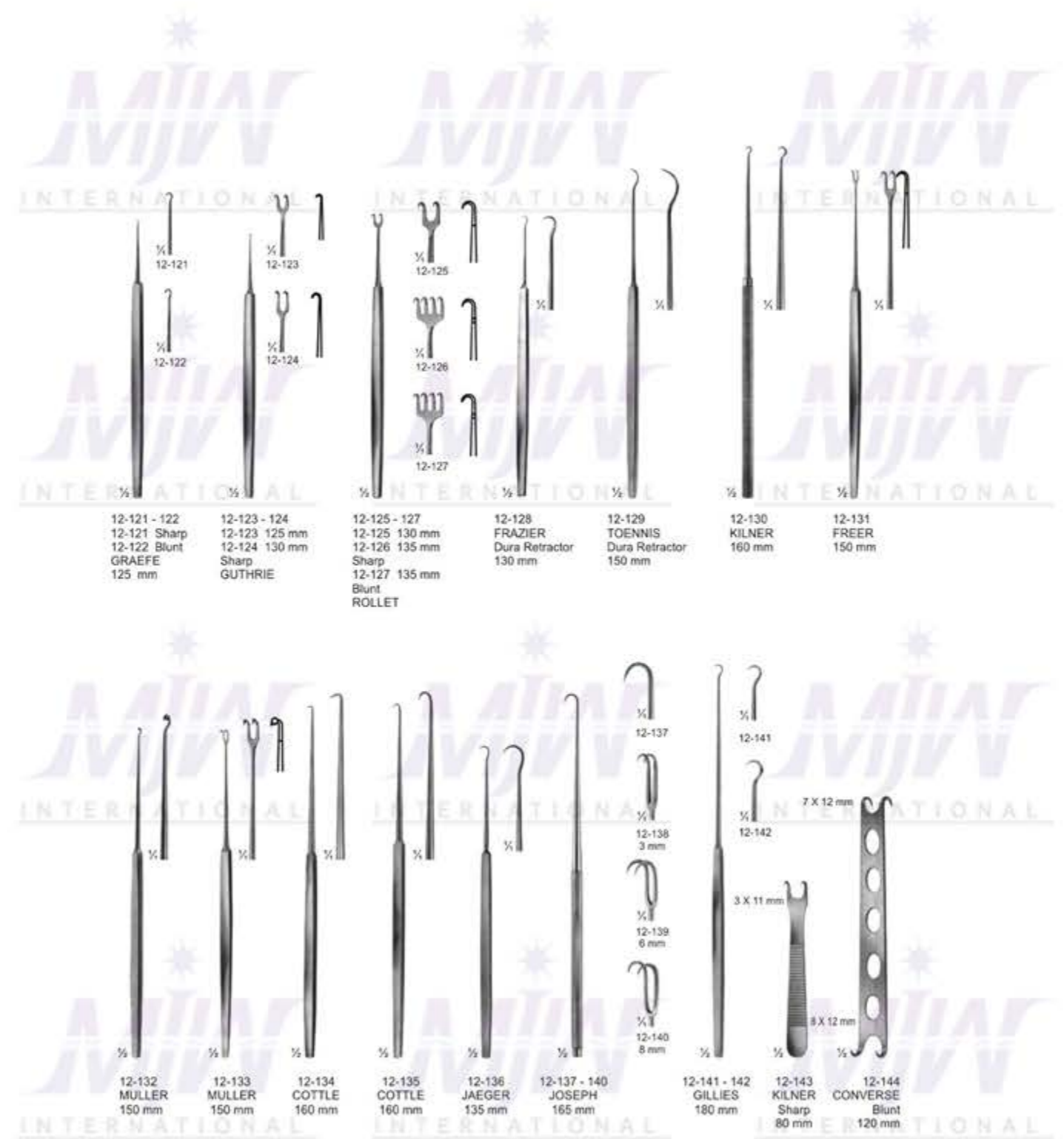



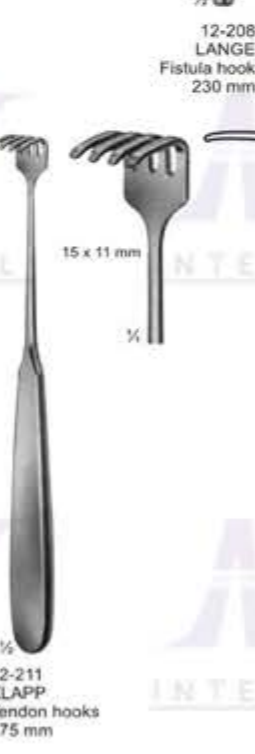







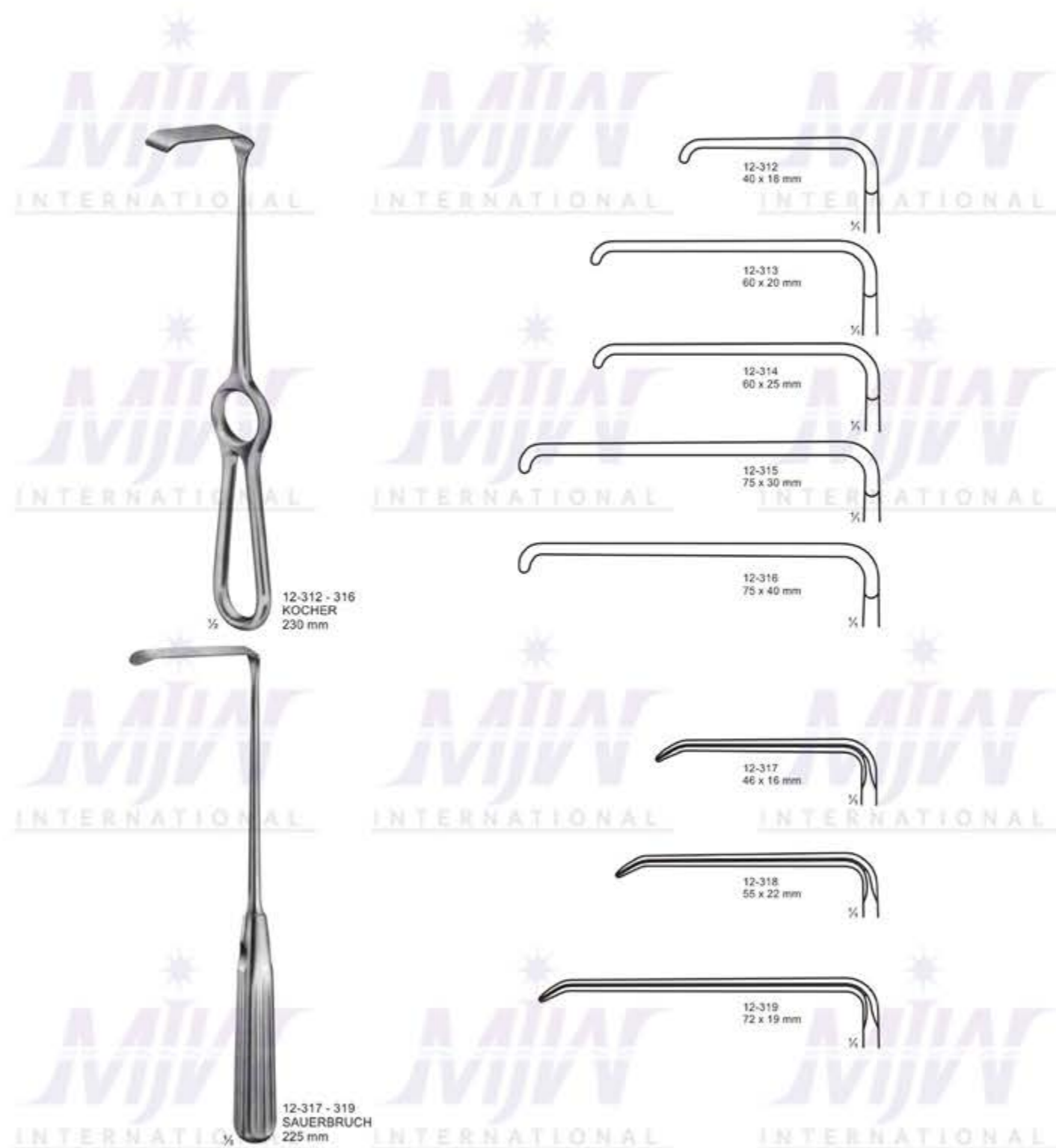

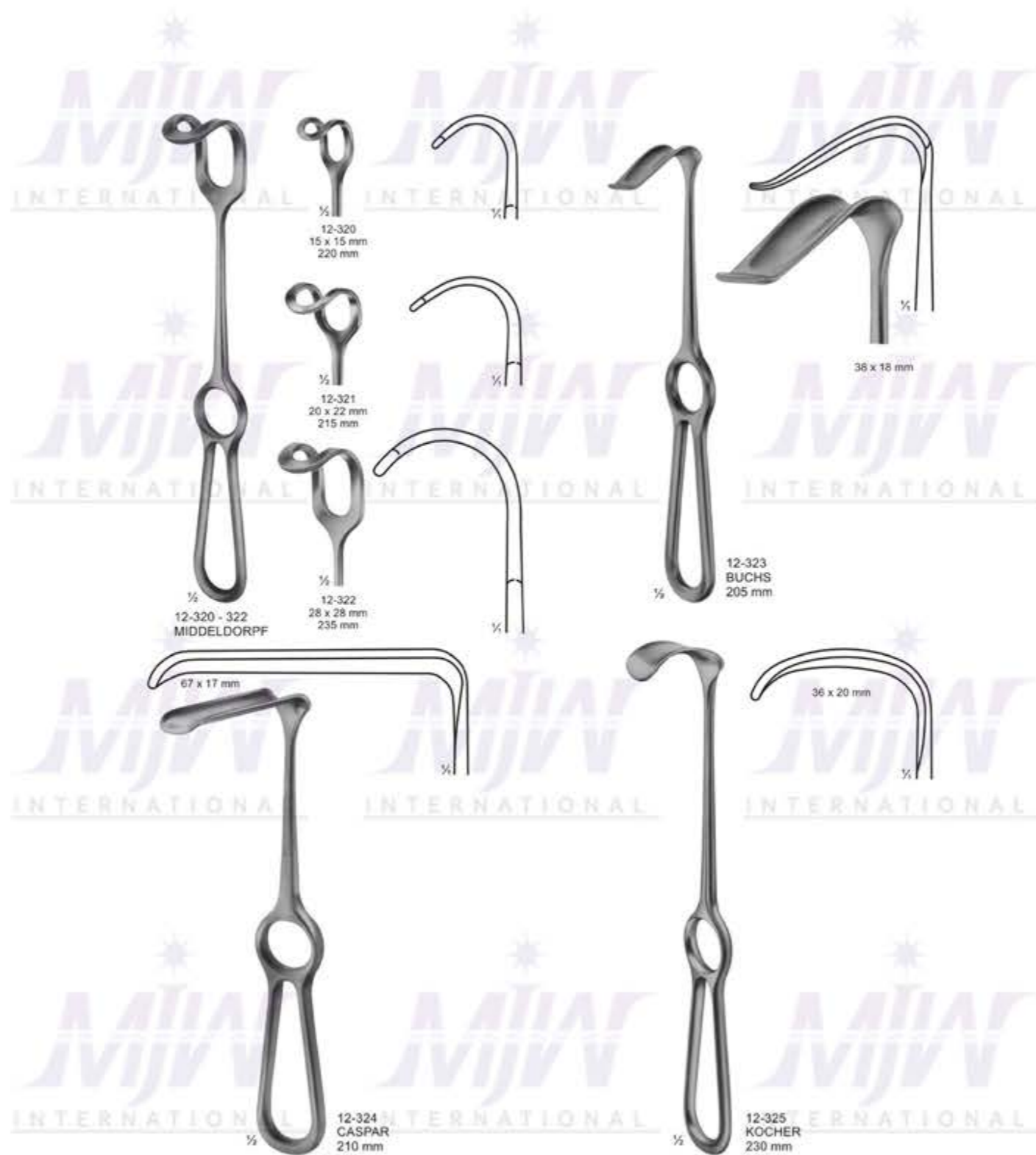







12-358
Retractor blades for handles

Depth	Width	18mm	22mm	26mm	30mm	40mm	50mm
55mm	12-358A	12-358B	12-358C	12-358D	12-358E	-	-
75mm	12-358F	12-358G	12-358H	12-358I	12-358J	-	-
95mm	12-358K	12-358L	12-358M	12-358N	12-358O	-	-
115mm	12-358P	12-358Q	12-358R	12-358S	12-358T	-	-
135mm	-	-	-	-	-	12-358U	-
145mm	-	-	-	-	-	-	12-358V



- 12-351 - 357
- BRUNNER
- 275 mm
- 12-351 80 x 20
- 12-352 100 x 25
- 12-353 120 x 25
- 12-354 130 x 30
- 12-355 140 x 30
- 12-356 160 x 30
- 12-357 180 x 30

12-358
Handle with cold
light carrier for
retractor blades.
280 mm

Handle
arrangement
variable

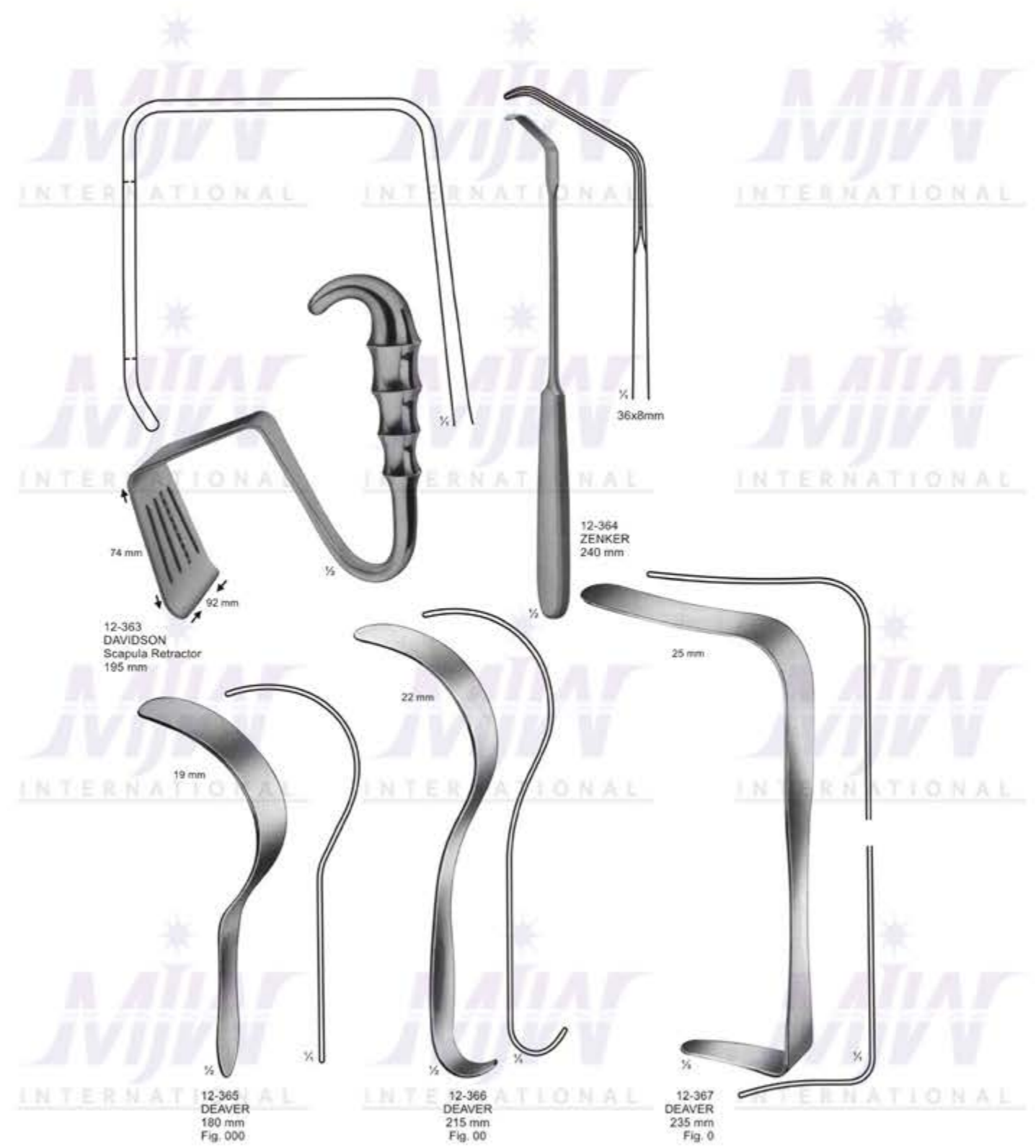









slightly concave

- 12-395 Fig.1 32 x 40 mm
- 12-396 Fig.2 34 x 50 mm
- 12-397 Fig.3 41 x 60 mm
- 12-398 Fig.4 46 x 75 mm
- 12-399 Fig.5 64 x 85 mm

12-384 - 394
DOYEN
240 mm

12-395 - 399
FRITSCH
240 mm

12-400
DOYEN
250 mm

Length of Blades	Width of Blades		
	35mm	45mm	60mm
62mm	12.384	12.387	12.391
92mm	12.385	12.388	12.392
122mm	12.386	12.389	12.393
160mm		12.390	12.394

- 12-401-405
ROCHARD
310 mm
- 12-401 48 x 90 mm
- 12-402 48 x 105 mm
- 12-403 48 x 120 mm
- 12-404 48 x 135 mm
- 12-405 48 x 155 mm

12-406
ROCHARD
Fixation device for 12-401-405

110 x 70 mm

O' Sullivan-O' Connor
12-401A
Adult
12-401B
Baby



12-407 - 410
DOYEN
280 mm



12-411
DOYEN-CHILD
Fixation device
220 mm



12-412
Chain (12-412A)
with weight (12-412B)
645g
790 mm

- 12-407 48 x 90 mm
- 12-408 48 x 105 mm
- 12-409 48 x 120 mm
- 12-410 48 x 135 mm



Oral Instruments
Cheek & Nasal Retractors, Alar Hooklet



Mayo
12-421S
17 cm



Converse
12-421C
10.5 cm
44 x 11 mm blade



Cawood Minnesota
12-421M
15 cm
20 mm



12-421MM
14.5 cm
Fenestrated



Doyen
12-426S
13 cm
24/30 mm
12-426SS
16 cm
30/34 mm



Tobold
12-426T
12 cm

63 mm



45 mm
12-421
REVERDIN
285 mm

40 mm



50 mm
12-422
HABERER
Malleable
305 mm



12-423 - 425
12-423 30 mm
12-424 40 mm
12-425 50 mm
Malleable
330 mm

17 mm



25 mm
12-426
TUFFIER
Malleable
200 mm



12-427
BOSE
60 mm



12-428
FINSEN
50 mm



12-429
FINSEN
70 mm



12-430
FINSEN modif.
75 mm



12-431
45 mm

12-432
55 mm



12-433
MUELLER
65 mm



12-434
100 mm



12-435
70 mm



12-436
100 mm



12-437
LOGAN
modif. REILL
50 mm



12-438
JANSEN
100 mm



12-439
JANSEN
100 mm



12-440
BARRAQUER
45 mm

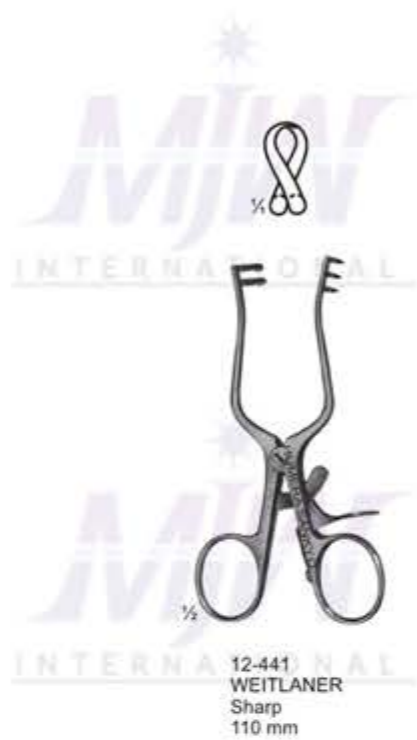



12-453
ADSON-BABY
Blunt
140 mm



12-454
MOLLISON
Sharp
155 mm



12-455
MAYO-ADAMS
165 mm



MEYERDING
12-455A 25 x 60 mm blade
12-455B 25 x 55 mm blade
12-455C 25 x 35 mm blade
12-455D 22 x 60 mm blade



DARLING
12-455E
18 cm
(Poplitea)



DARLING
12-455F
18 cm
(Poplitea)



12-456
ANDERSON-ADSON
Sharp
190 mm



12-457
NORFOLK and
NORWICH
Blunt
220 mm



12-458
ADSON
Sharp
265 mm





Scoville
12-469A
50 mm deep
Blunt



Scoville
12-469B
70 mm deep
Blunt



Scoville
12-469C
50 mm deep
Sharp



Scoville
12-469D
70 mm deep
Sharp



Scoville
12-469E 60 x 25 mm
12-469F 64 x 50 mm
12-469G 68 x 25 mm
Toothed



12-469
62 x 52 mm
PR= Pair



12-470
47 x 51 mm



12-471
30 x 40 mm



12-472
37 x 62 mm



12-468
SCOVILLE-RICHTER
Retractor (12-468A) with 1 pair
blades (12-469) reversible type.
The Retractor bar and shanks
may be easily rotated 180° when
blades are in situ.



12-473
CLOWARD modif.
Spreader Only
Consisting of:
12-473 A Spreader Only 10"
12-474 1 Blade
12-475 1 Blade
12-476 1 Blade
12-477 1 Blade
12-478 1 Blade



40 mm
16 mm
12-474



45 mm
16 mm
12-475



40 mm
16 mm
12-479



45 mm
16 mm
12-480



50 mm
16 mm
12-476



55 mm
16 mm
12-477



50 mm
16 mm
12-481



55 mm
16 mm
12-482



60 mm
16 mm
12-478



60 mm
16 mm
12-483

Blades only used for 12-473 A



12-484 CASPAR
Retractor, adjustable, consisting of:
5 medial blades (12-485-489) 5 Lateral
blades. (12-490-494) and the retractor
only (12-484B) By Reversing the Screw,
The Retractor Can be Used From Both Sides



12-484 A CASPAR
Counter retractor, adjustable,
consisting of: 5 blades. (12-495-499)
and the retractor only (12-484C)



12-512 CLOWARD
155 mm



12-513 CLOWARD
135 mm

To be used preferably for transverse retraction.



12-485 40 x 23 mm
12-486 45 x 23 mm
12-487 50 x 23 mm
12-488 55 x 23 mm
12-489 60 x 23 mm
Medial blades

12-490 40 x 23 mm
12-491 45 x 23 mm
12-492 50 x 23 mm
12-493 55 x 23 mm
12-494 60 x 23 mm
Lateral blades

12-495 45 x 23 mm
12-496 50 x 23 mm
12-497 55 x 23 mm
12-498 60 x 23 mm
12-499 65 x 23 mm
Blunt blades

12-500 50 x 25 mm
12-501 60 x 25 mm
Blunt blades,
for harvesting of the
fusion graft from the
iliac crest

To be used preferably for up and down retraction.



12-502 40 x 25 mm
12-503 45 x 25 mm
12-504 50 x 25 mm
12-505 55 x 25 mm
12-506 60 x 25 mm
Medial Titan blades
semi transparent to x-ray

12-507 40 x 25 mm
12-508 45 x 25 mm
12-509 50 x 25 mm
12-510 55 x 25 mm
12-511 60 x 25 mm
Lateral Titan blades
semi transparent to x-ray

Blades only, to be used with 12-484B and 12-484C



12-514 INGE
170 mm

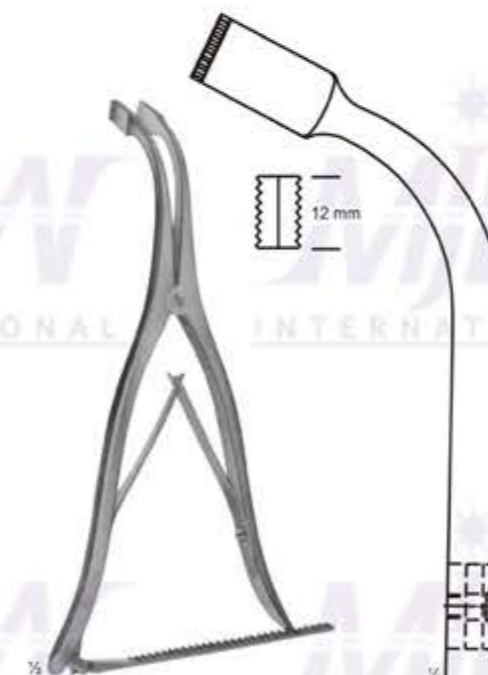

12-515 INGE
275 mm

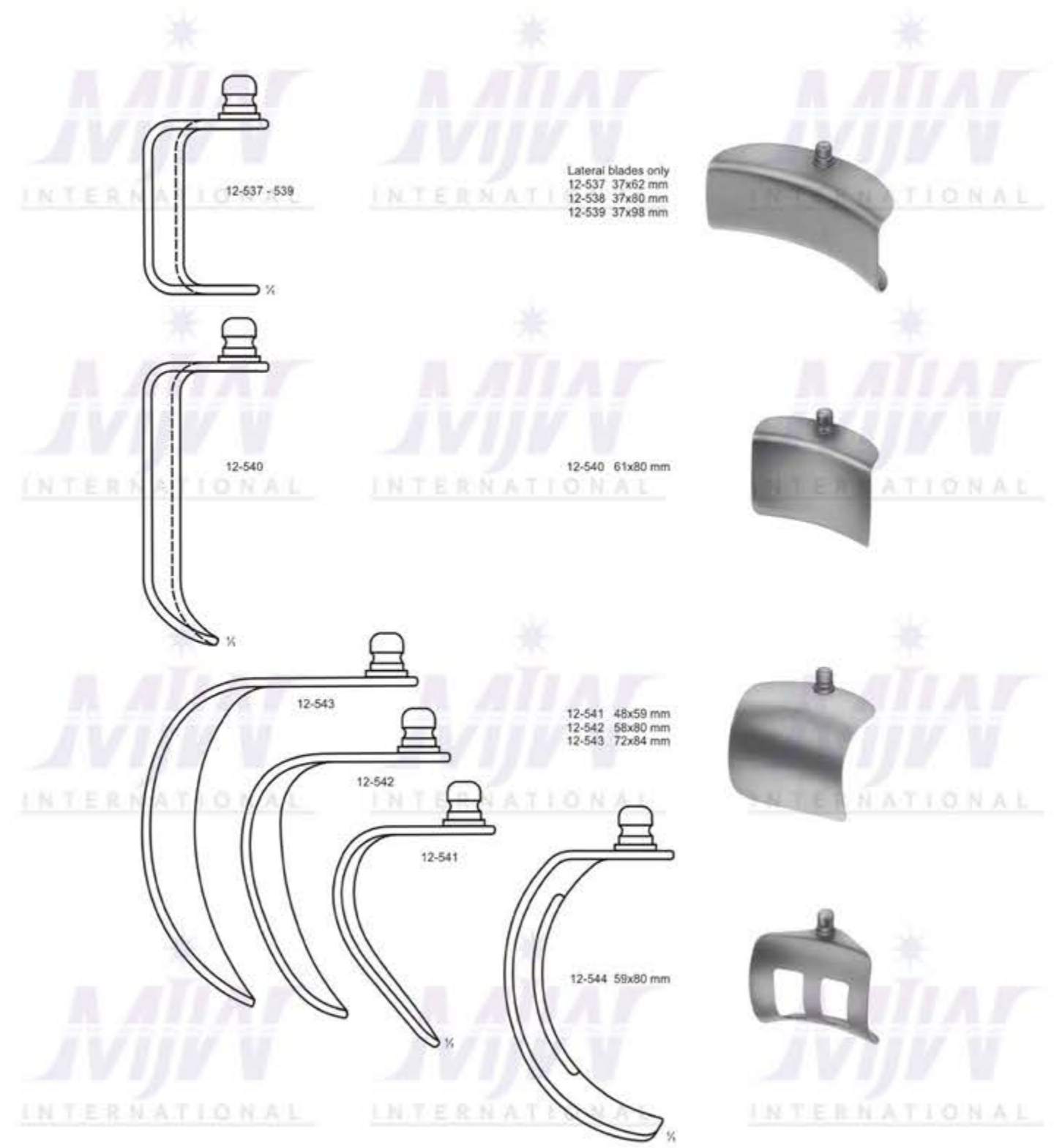
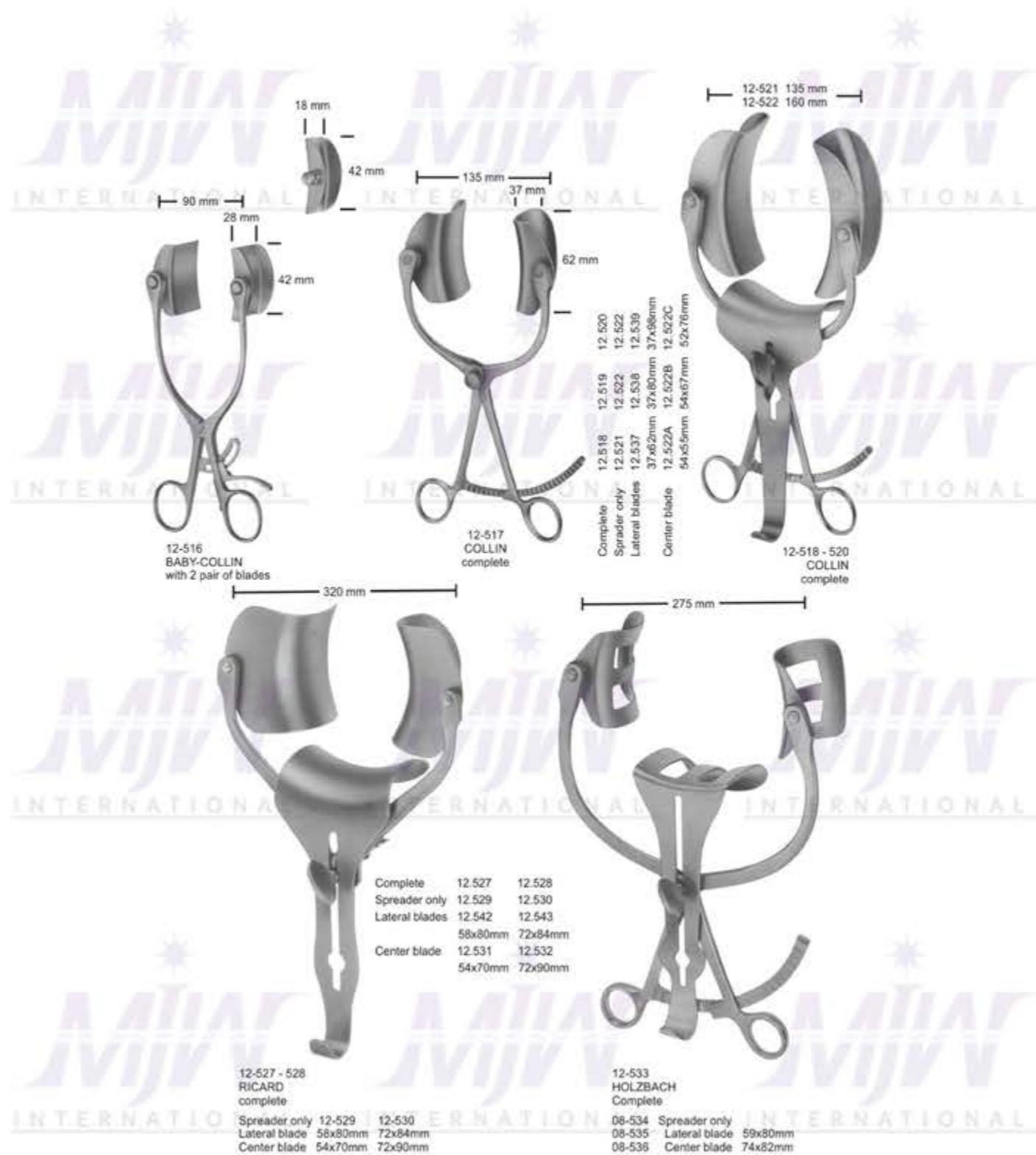



12-545
GOSSET
Blades:38 mm deep



12-546
HERTZLER
Blades 20 X 25 mm



12-547
BALFOUR-BABY
Lateral blades 27 mm deep
(12-548) Center blade 21x24 mm



12-552
BALFOUR
Lateral blades 60 mm deep
(12-553) Center blade
47 x 80 mm



12-554
BALFOUR
Lateral blades 105 mm deep
(12-555) Center blade
107x 59 mm



12-556
Center blade only
54x80 mm



12-549
GOSSET
Blades:55mm deep



12-550
GOSSET
Lateral blades 58 mm deep
(12-551) Center blade
59 x 57 mm



12-557 - 560
BALFOUR
Spreader only 12-561 12-562 12-563 12-564
Lateral blades 50 mm 60 mm 75 mm 90 mm
Center blade 47 x 80 mm 62x76 mm 80x80 mm 80x80 mm



Lateral blades
12-565 50 mm deep
12-566 60 mm deep
12-567 75 mm deep
12-568 90 mm deep
Sales Unit of blades:PR = pair

Complete	12-557	12-558	12-559	12-560
Spreader only	12-561	12-562	12-563	12-564
Lateral blades	12-565	12-566	12-567	12-568
	50mm	60mm	75mm	90mm
Center blade	12-569	12-570	12-571	12-572
	47x80mm	62x76mm	80x80mm	80x80mm

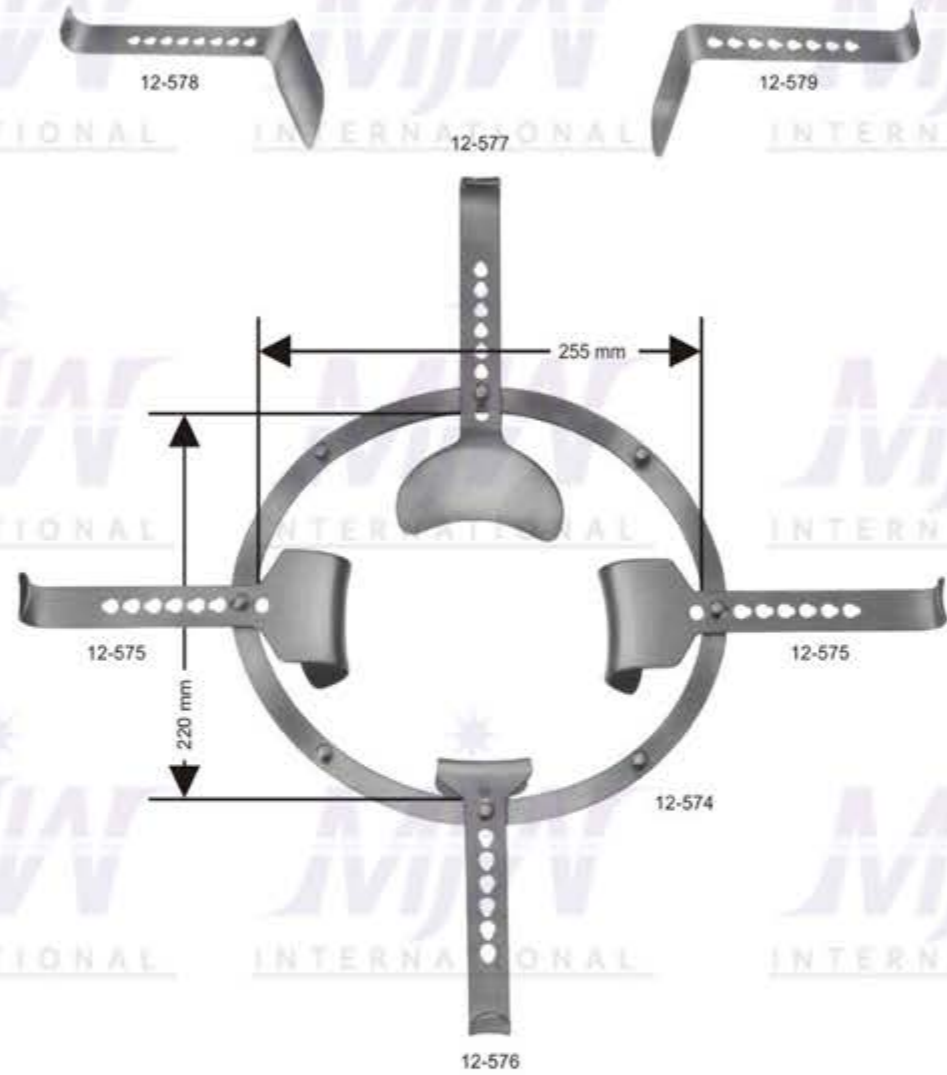

- 12-573 SEMM consisting of:
- 12-574 1 frame 225 x 220 mm
- 12-575 2 blades 46 x 64 mm
- 12-576 1 blade 53 x 54 mm (for bladder)
- 12-577 1 blade 82 x 97 mm (for intestine)
- 12-578 1 blade 98 x 51 mm (for intestine)
- 12-579 1 blade, narrow 107 x 36 mm



- 12-580 KIRSCHNER with folding frame (12-581) and 2 blades of each (12-583 - 584)
- 12-582 KIRSCHNER with vaulted fixed frame (12-585) and 2 blades of each (12-583 - 584)
- 12-586 275 x 355 mm Frame only, over-sized
- 12-587 295 x 275 mm Frame only

Addition valves for corpulent persons.



- 12-588 KIRSCHNER 64 x 80 mm
- 12-589 KIRSCHNER-BALFOUR 80x 82 mm
- 12-590 - 592 KIRSCHNER 12-590 90x 69mm 12-591 92x 95mm 12-592 78x 58mm
- 12-593 - 595 KIRSCHNER 12-593 108x42mm 12-594 91x 55mm 12-595 121x 55mm

	SECTION	PAGE
Forceps,	13	168-186
Intestinal Clamps		
Biopsy Forceps	14	187-203
Blader Retractor, Trocars & Urinary Instruments	15	204-208





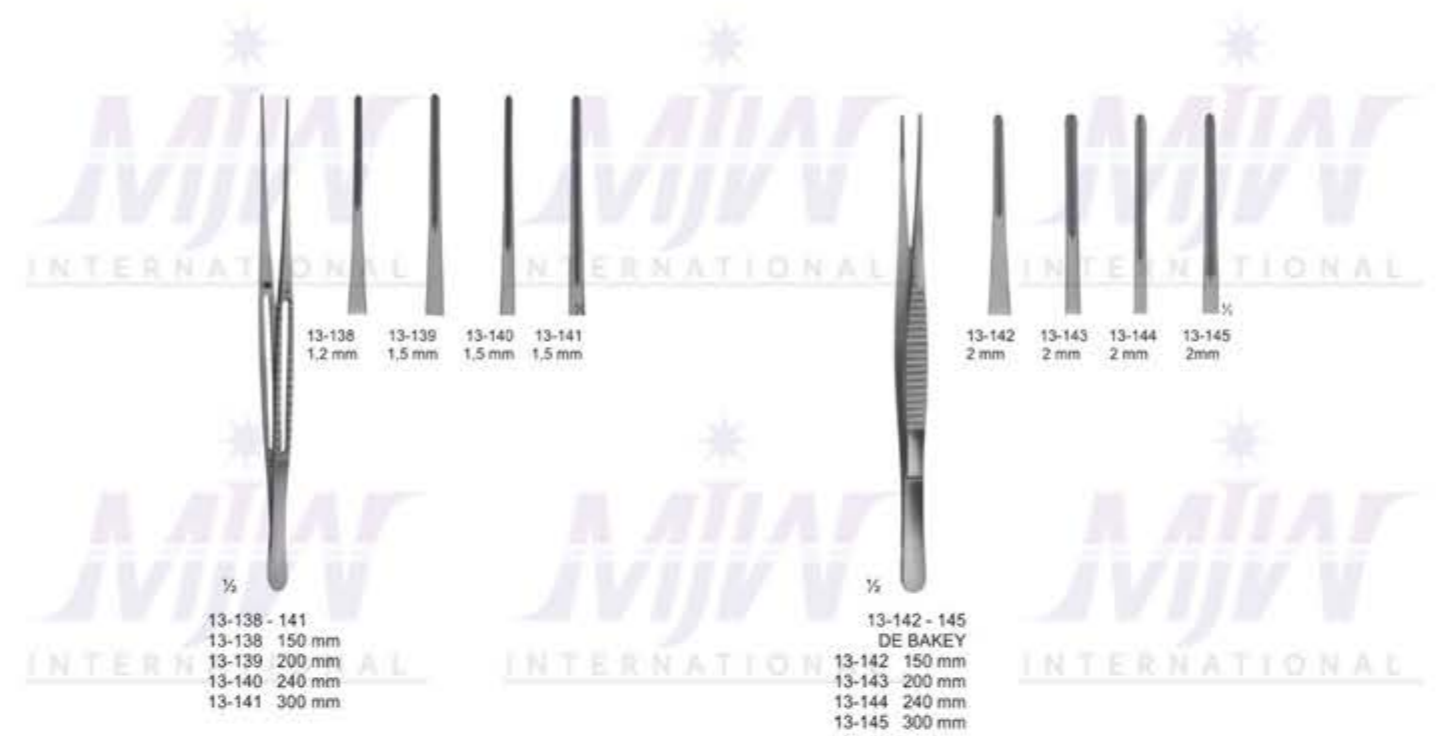





13-168 13-169

13-168 - 171
KOCHER
with elastic blades
13-168-13-170 210 mm
13-169-13-171 230 mm



13-170 13-171



13-172 13-173

13-172 - 173
DOYEN
with elastic blades
240 mm



13-174

13-174 - 175
DOYEN
with elastic blades
235 mm



13-175



Atraumata

13-176

13-176 - 177
DOYEN
with elastic blades
230 mm



13-177





13-190

13-190 - 191
NUSSBAUM
with elastic blades
250 mm



13-191



13-192

13-192
MOYNIHAN
280 mm



13-193

13-193 - 194
MAYO-ROBSON
hard elastic
250 mm



13-194



13-195

13-195 - 196
MAYO-ROBSON
250 mm



13-196

Atraumata



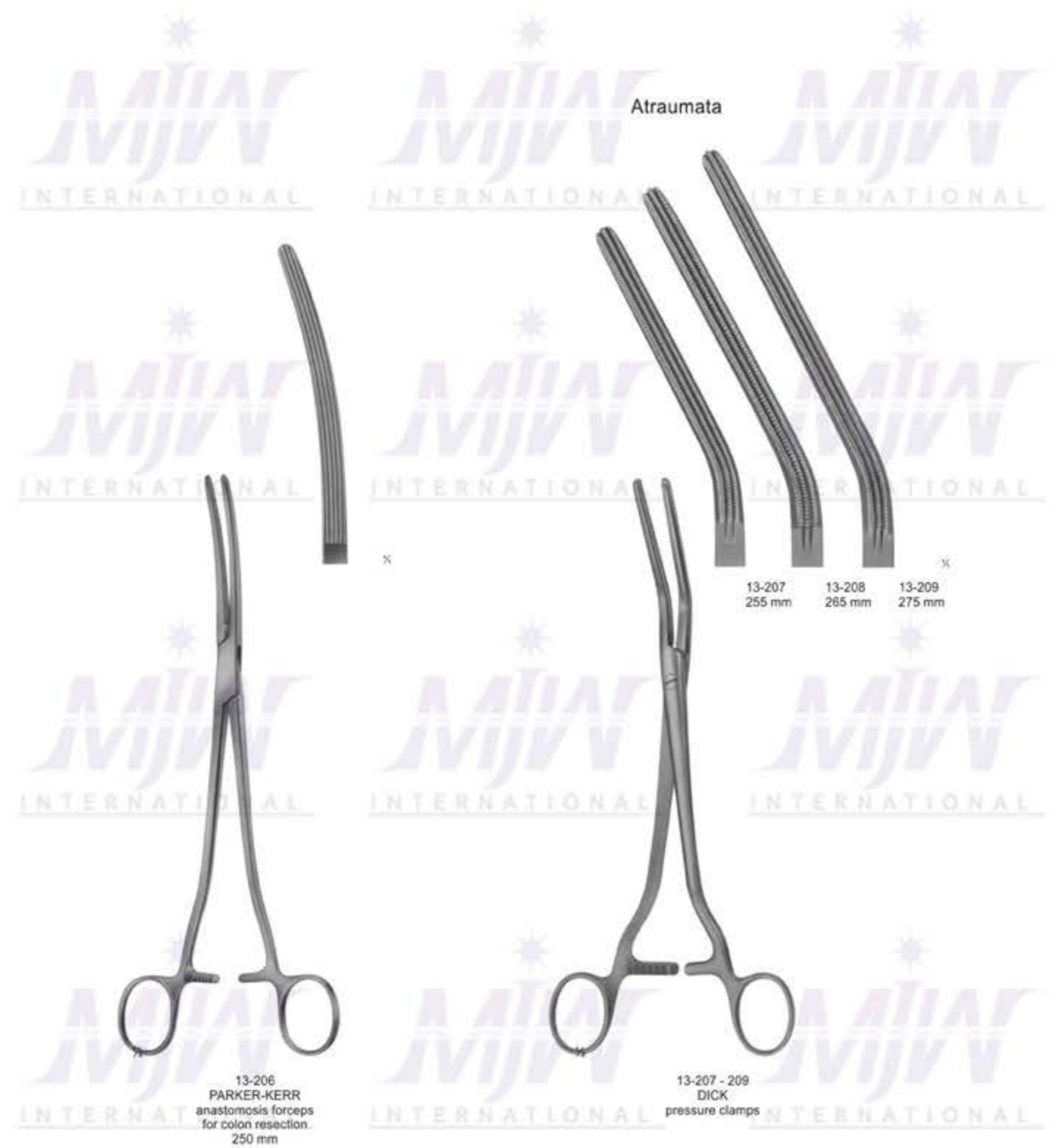



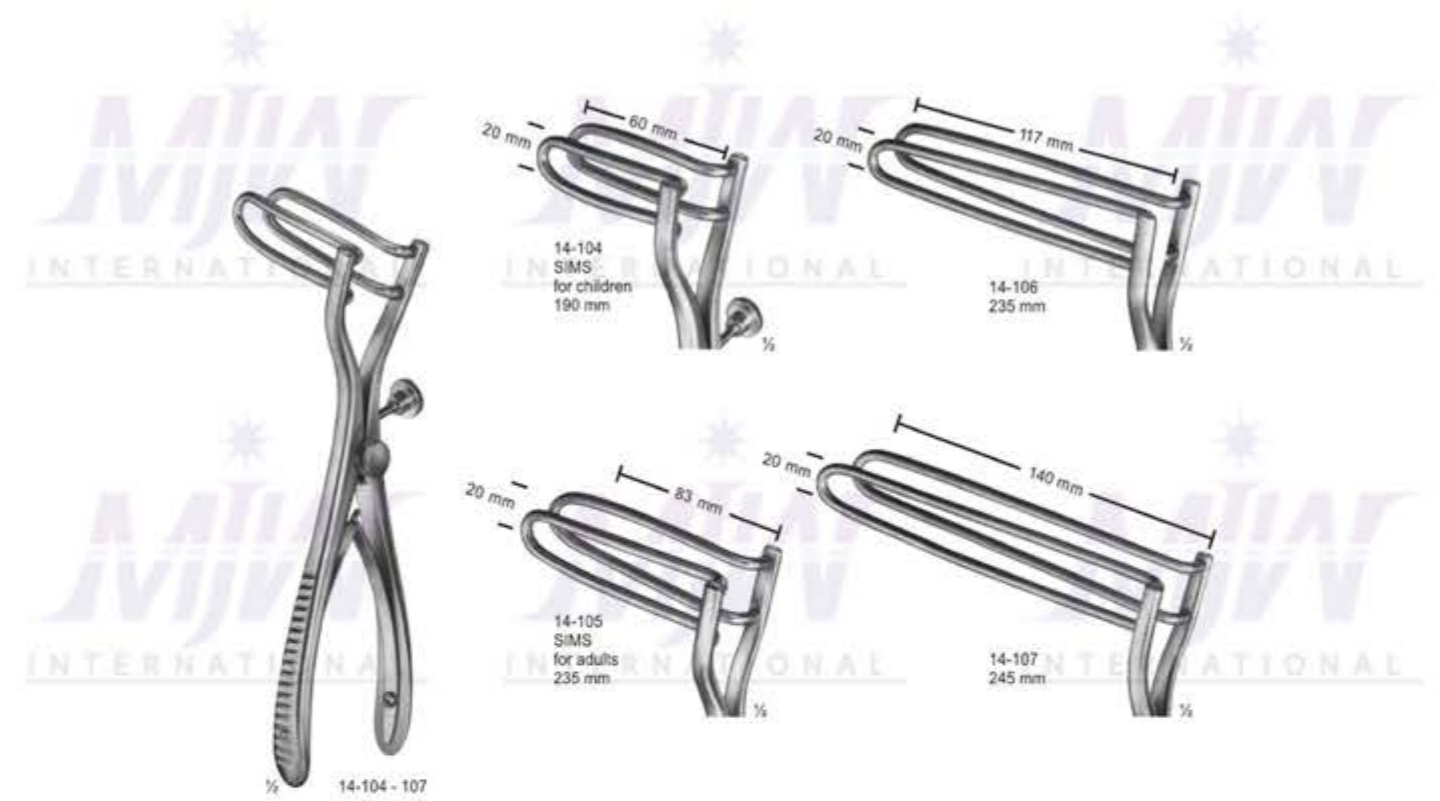



14-110
IVES-FANSLER
Anuscope
145 mm
24mm ϕ



14-111
KELLY
Sphincteroscope
160 mm
21mm ϕ



14-112
KELLY
Sphincteroscope
160 mm
27mm ϕ



14-113
KELLY
Proctoscope
140 mm
22mm ϕ



14-114

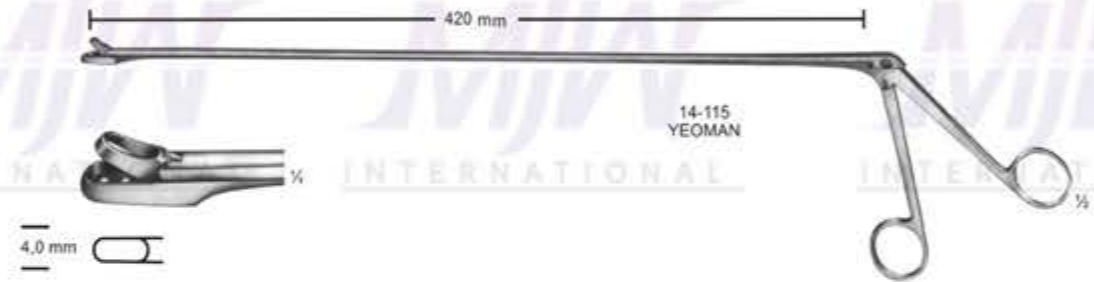
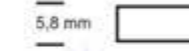

14-115
YEOMAN



14-116
HERGET



With Drawing Cut

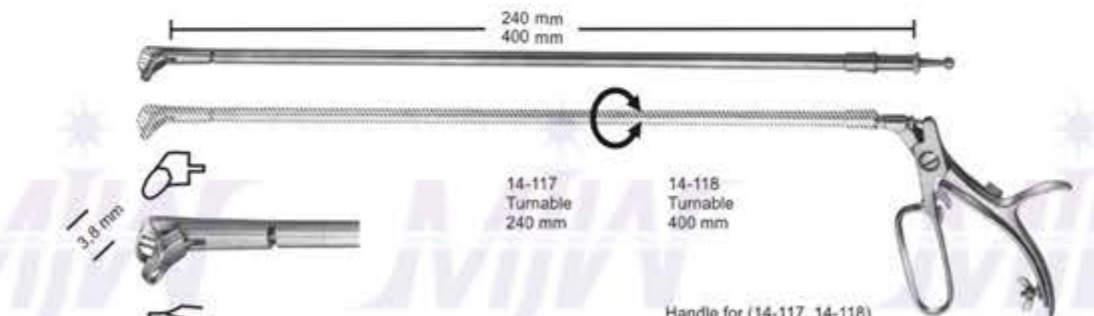

14-117
Turnable
240 mm

14-118
Turnable
400 mm

Handle for (14-117, 14-118)

With Drawing Cut,
Attachments only

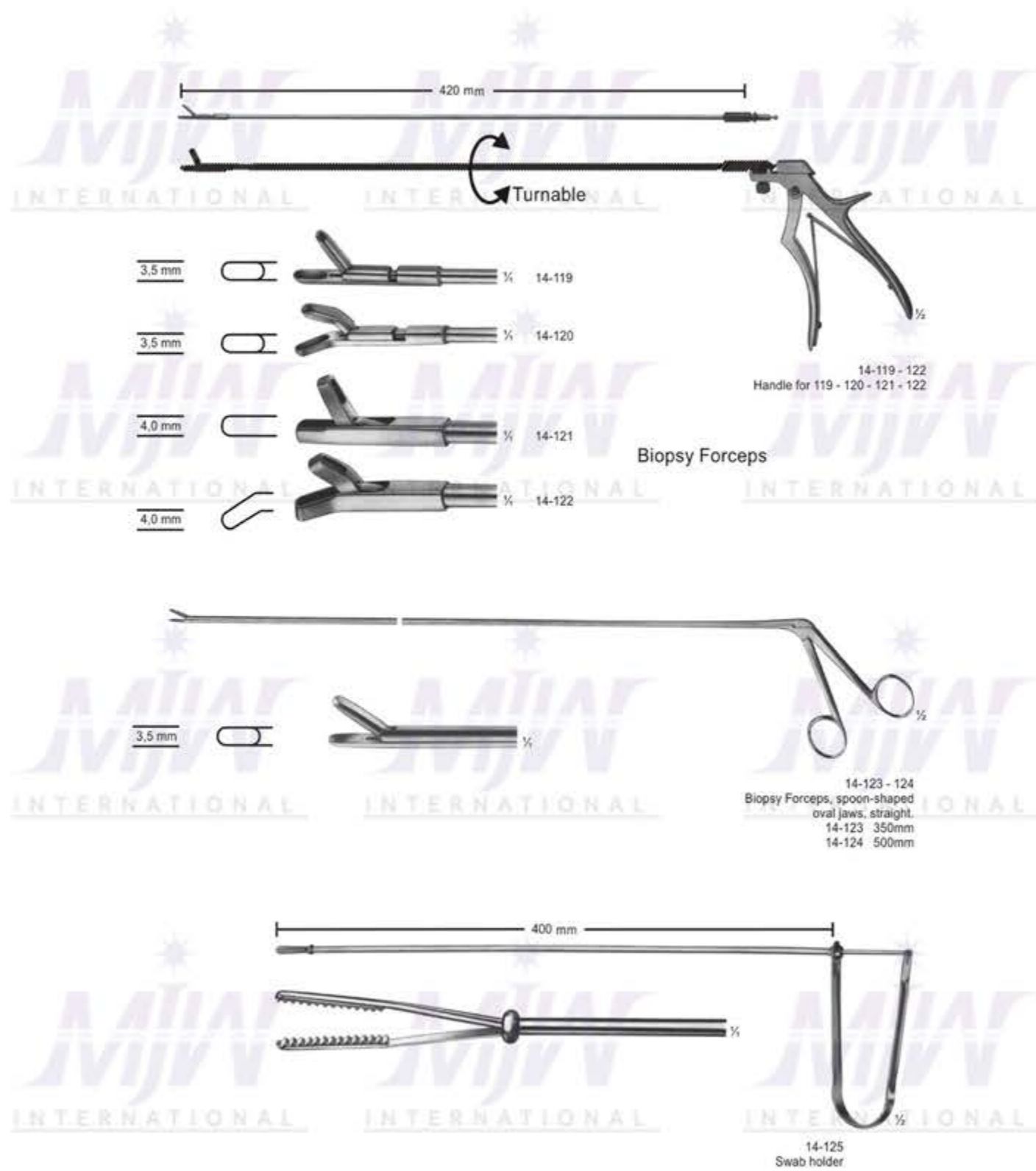

Atraumata



14-130
250 mm-14-131
270 mm



14-132 - 133
FERGUSSON
200 mm

Pressure Clamp

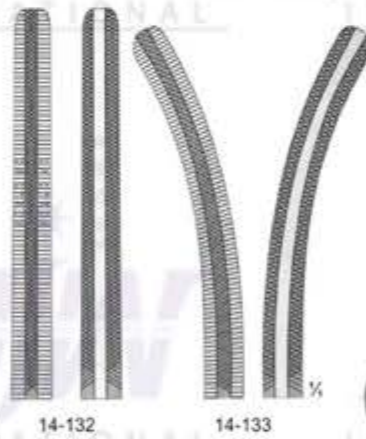

14-132 14-133



14-134
RUDD
Haemorrhoidal ligator
with loading
attachment and 100
ligature rubber rings
315 mm



14-135
LOWER
180 mm



14-136
LAHEY (SWEET)
190 mm



14-137
LAHEY
220 mm



14-138
DESJARDINS
Gall duct-and cystic forceps
210 mm



14-139
NISSEN
Gall duct-and cystic forceps
215 mm

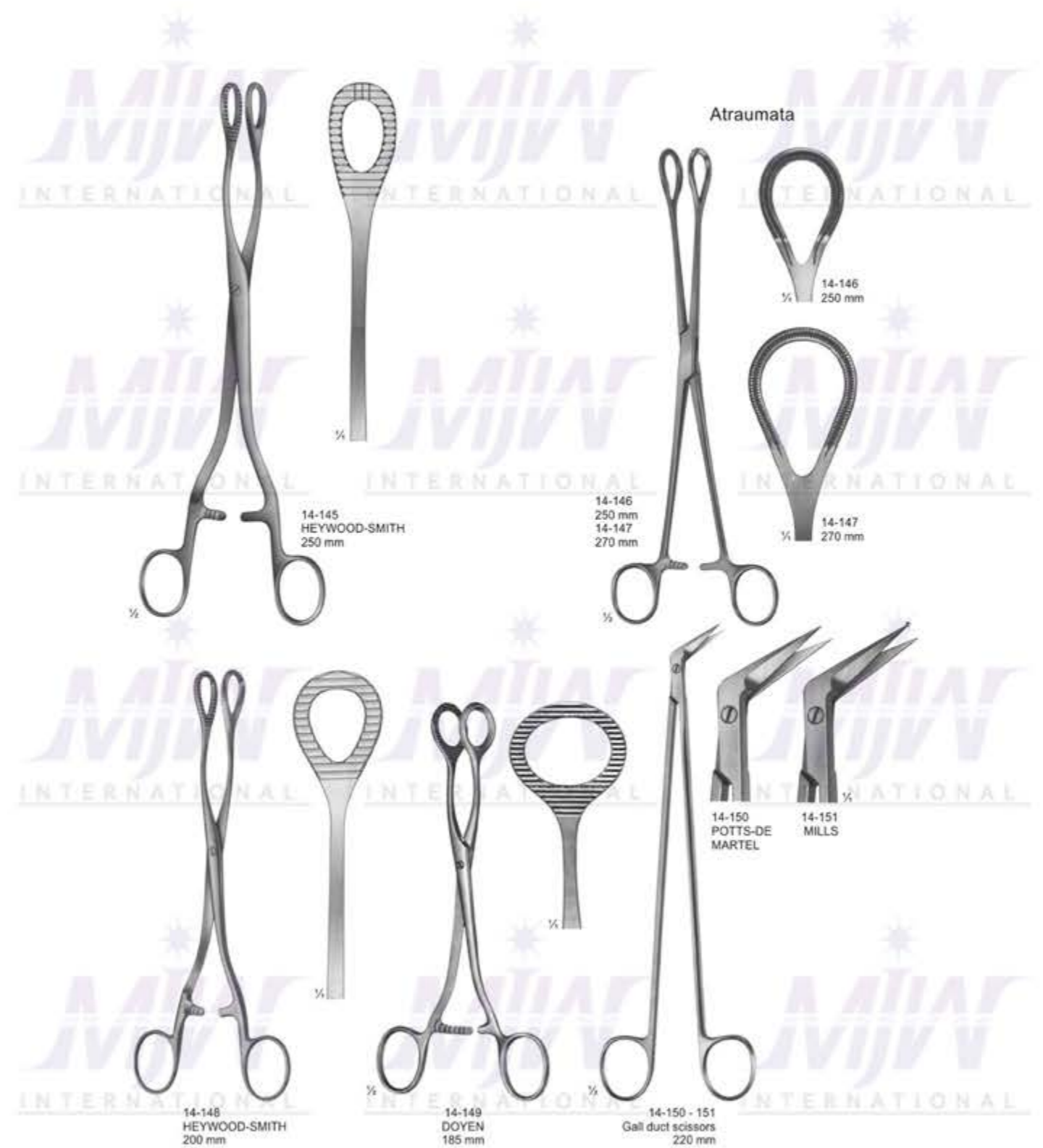

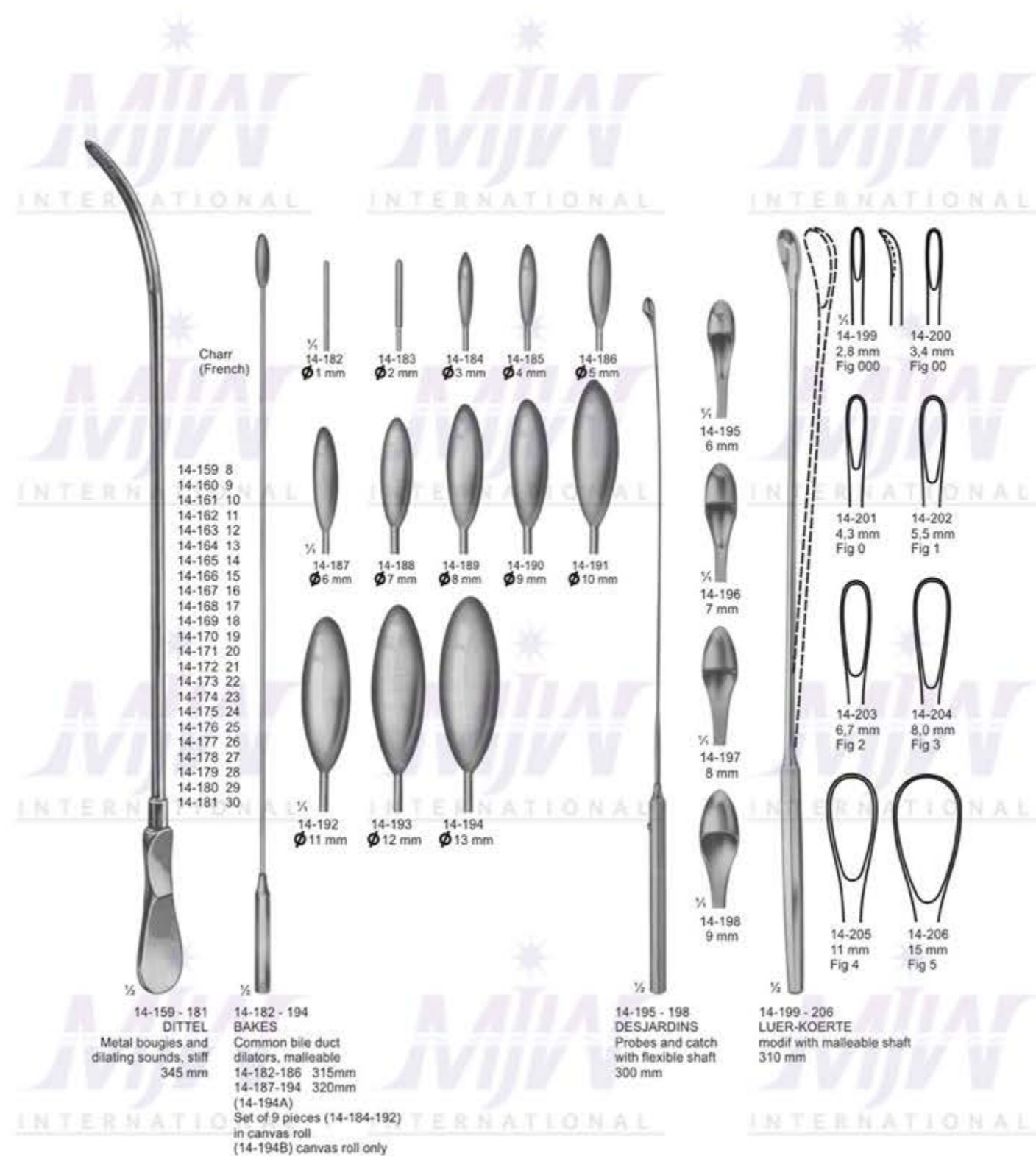

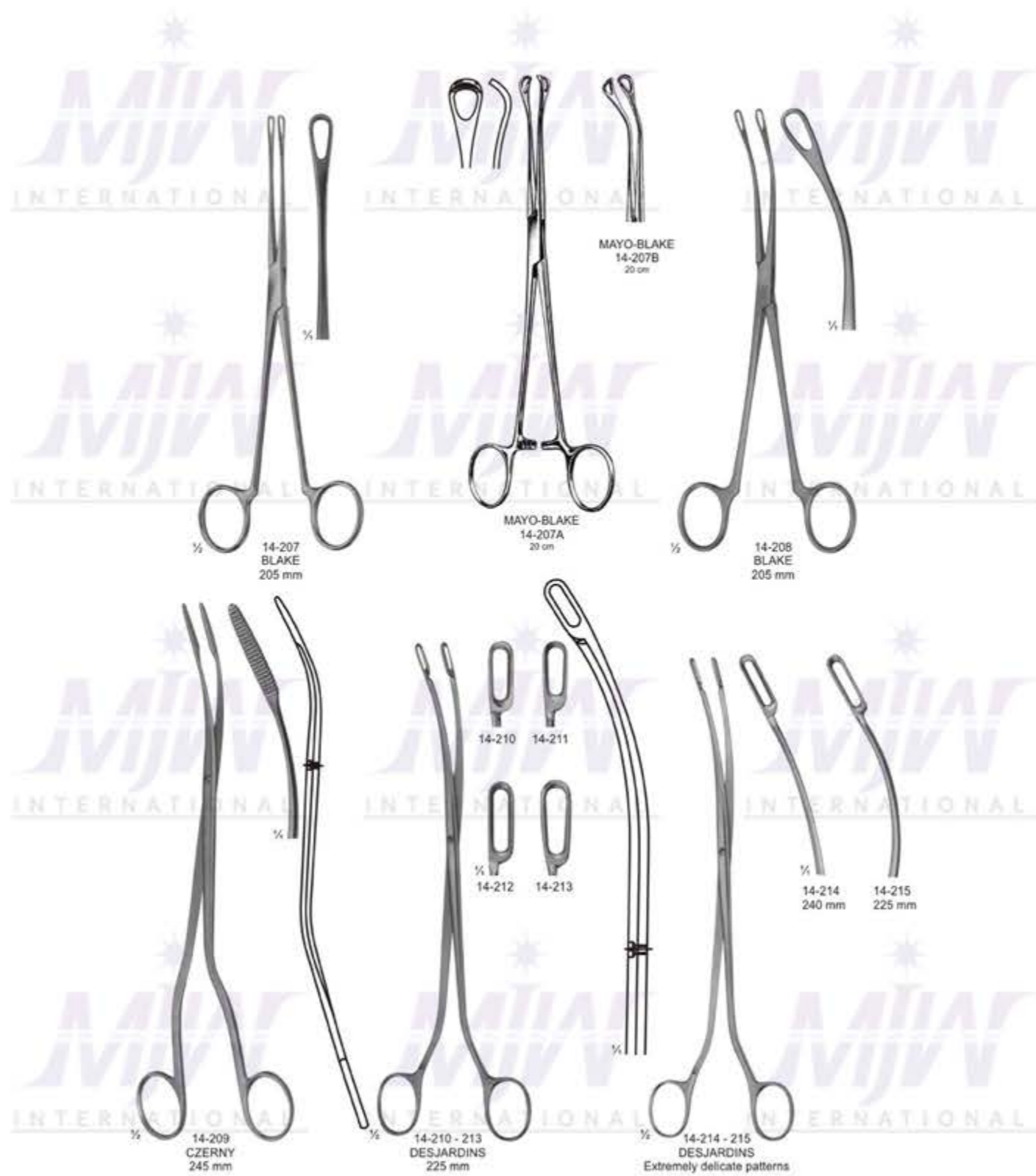



14-222
STILLE
220 mm



14-223
HERRICK
225 mm



14-224
WERTHEIM
225 mm



14-225
COLLIN
285 mm



14-226
DARTIGUES
255 mm



ELSASSIER
14-226A
20 cm
Fig. 1



ELSASSIER
14-226B
20 cm
Fig. 2

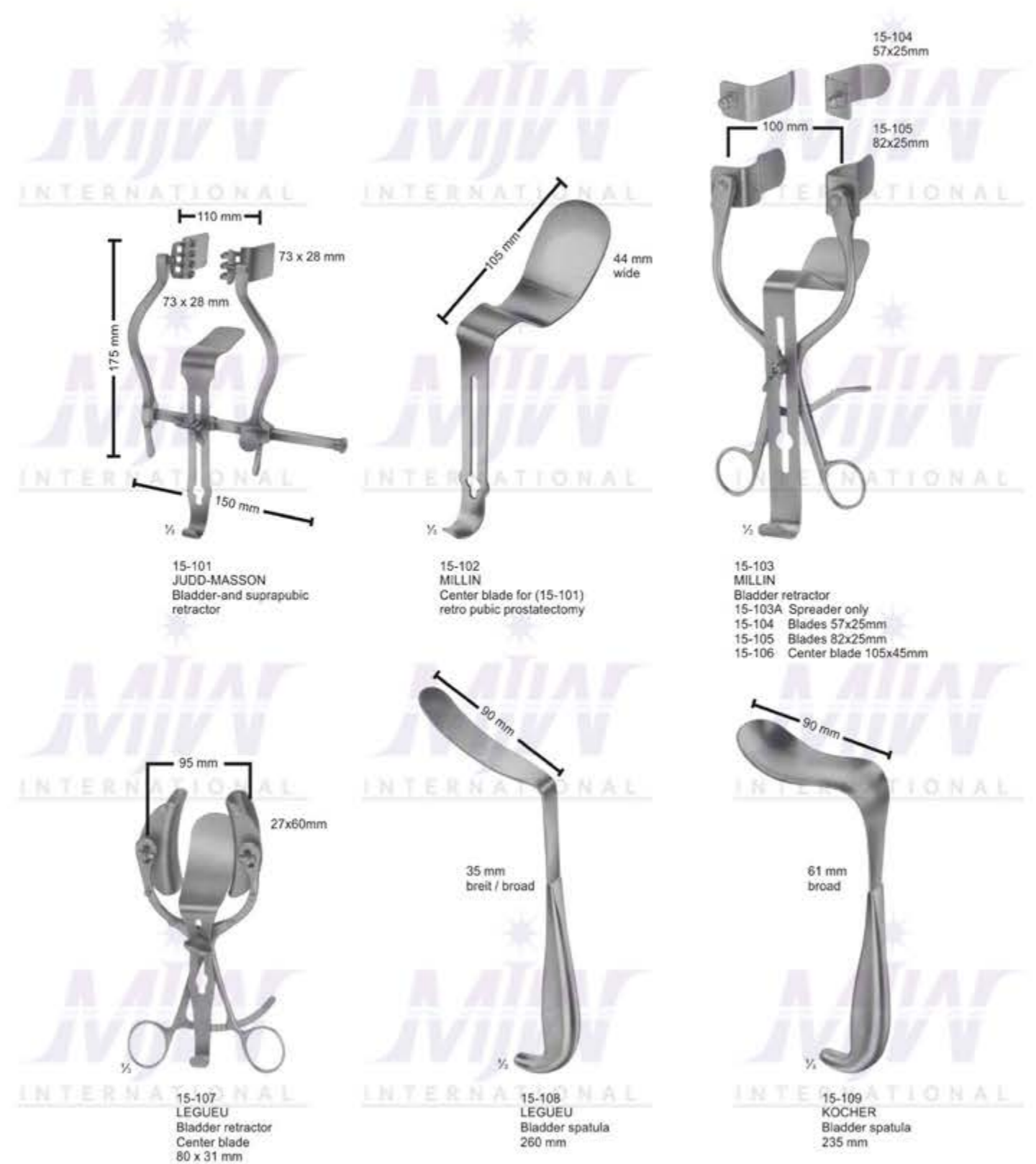

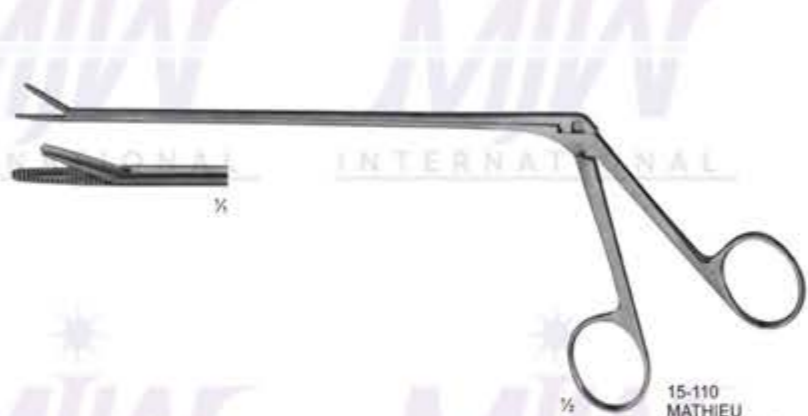

15-110
MATHIEU
Foreign body forceps
Length of shaft
190 mm



15-111
MILLIN
Lobe grasping
forceps
235 mm



15-112
Ureter forceps
240 mm



15-113
MILLIN
Lobe grasping
forceps
245 mm



15-114
MILLIN
Bladder neck spreader
285 mm



15-115
GUYON
Catheter guide
(introducer)
365 mm



VEN BUREN
15-115-8 to 15-115-36
Set of 29

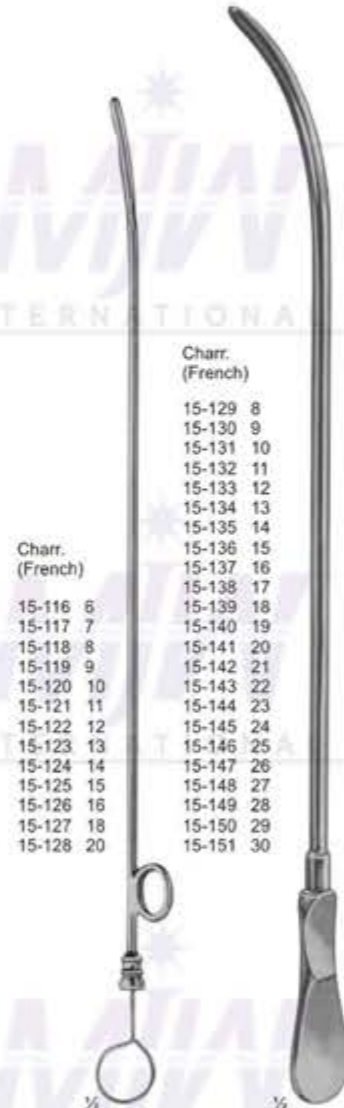

15-116 - 128
Female catheters,
metal
160 mm



15-129 - 151
DITTEL
Urethral bougies
and dilating sounds
345 mm



15-152 - 188
GUYON
Urethral bougies
and dilating sounds,
without filiform guides,
with thread in tip
255 mm

Charr. (French)	Charr. (French)
15-129 8	15-138 17
15-130 9	15-139 18
15-131 10	15-140 19
15-132 11	15-141 20
15-133 12	15-142 21
15-134 13	15-143 22
15-135 14	15-144 23
15-136 15	15-145 24
15-137 16	15-146 25
15-138 17	15-147 26
15-139 18	15-148 27
15-140 19	15-149 28
15-141 20	15-150 29
15-142 21	15-151 30
15-143 22	
15-144 23	
15-145 24	
15-146 25	
15-147 26	
15-148 27	
15-149 28	
15-150 29	
15-151 30	

15-152 Ben. 24/Charr. 12
15-153 Ben. 25
15-154 Ben. 26/Charr. 13
15-155 Ben. 27
15-156 Ben. 28/Charr. 14
15-157 Ben. 29
15-158 Ben. 30/Charr. 15
15-159 Ben. 31
15-160 Ben. 32/Charr. 16
15-161 Ben. 33
15-162 Ben. 34/Charr. 17
15-163 Ben. 35
15-164 Ben. 36/Charr. 18
15-165 Ben. 37
15-166 Ben. 38/Charr. 19
15-167 Ben. 39
15-168 Ben. 40/Charr. 20
15-169 Ben. 41
15-170 Ben. 42/Charr. 21
15-171 Ben. 43
15-172 Ben. 44/Charr. 22
15-173 Ben. 45
15-174 Ben. 46/Charr. 23
15-175 Ben. 47
15-176 Ben. 48/Charr. 24
15-177 Ben. 49
15-178 Ben. 50/Charr. 25
15-179 Ben. 51
15-180 Ben. 52/Charr. 26
15-181 Ben. 53
15-182 Ben. 54/Charr. 27
15-183 Ben. 55
15-184 Ben. 56/Charr. 28
15-185 Ben. 57
15-186 Ben. 58/Charr. 29
15-187 Ben. 59
15-188 Ben. 60/Charr. 30



Fr.	Fr.	Fr.
15-189-08	15-189-19	15-189-30
15-189-09	15-189-20	15-189-31
15-189-10	15-189-21	15-189-32
15-189-11	15-189-22	15-189-33
15-189-12	15-189-23	15-189-34
15-189-13	15-189-24	15-189-35
15-189-14	15-189-25	15-189-36
15-189-15	15-189-26	
15-189-16	15-189-27	
15-189-17	15-189-28	
15-189-18	15-189-29	

Assisted by two haemostats or ligatures the foreskin is pushed over the bell-shaped protection - rod and the glass is placed into it.
 By now, the wing - nut is tightened as close as possible, so the foreskin is annularly compressed. The foreskin is cut with a scalpel, right next to the compression ring. The circumcision clamp remains a few minutes to avoid bleeding. In case that any large vein, especially the frenular artery, is cut through, a ligature must be set.
 The advantage of the method described is the cosmetically favourable scar which is left after rejection of the small necrotized portion.



15-190 - 192 WINKELMANN	
15-190	12mm
15-191	16mm
15-192	20mm

Circumcision Clamps



MOGEN 15-192A 7 cm



15-190 A	8 mm
15-190 B	11 mm
15-190 C	13 mm
15-190 D	16 mm
15-190 E	21 mm
15-190 F	26 mm
15-190 G	32 mm

Luer Lock



15-193 KLIMA ROSEGGER 35 X 1,8 mm Sternal puncture needle



15-194 Universal trocar with 4 tips

15-195 - 199 NELSON	Inside diam	Outside diam
15-195	2,2 mm	3,0 mm
15-196	3,0 mm	4,0 mm
15-197	4,0 mm	5,0 mm
15-198	5,0 mm	6,0 mm
15-199	5,5 mm	6,5 mm

for hydrocele and abdominal puncture



15-200 - 203	Inside diam	Outside diam
15-200	2,2 mm	3,0 mm
15-201	3,0 mm	4,0 mm
15-202	4,0 mm	5,0 mm
15-203	5,0 mm	6,0 mm

for abdominal puncture, with stop-cock and lateral drain



15-204 - 205 BUELAU	Inside diam	Outside diam
15-204	6,5 mm	8,0 mm
15-205	9,0 mm	10,0 mm

Empyema trocars



15-206 - 209 OCHSNER	Inside diam	Outside diam
15-206	3,0 mm	4,0 mm
15-207	3,6 mm	4,6 mm
15-208	4,3 mm	5,3 mm
15-209	5,0 mm	6,0 mm

Gall bladder trocars



15-210 PIERCE Antrum trocar 4,0 mm



15-211 COAKLEY Antrum trocar 3,0 mm

	SECTION	PAGE
Vaginal Specula	16	209-220
Retractors		
Utrine Dilators, Probes, Forceps, Myoma Instruments	17 18	221-236



16-101
COLLIN
for children
53 x 10 mm



CLUM
16-101A
Sakurai's vaginal speculum

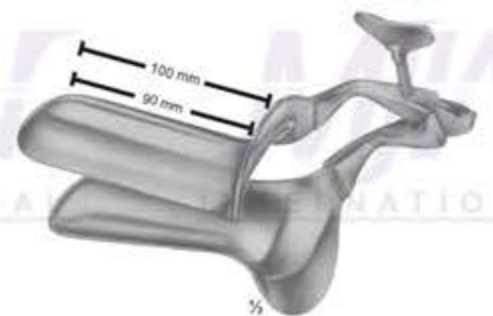

16-102 - 105
COLLIN
16-102 100/90mm 28 mm
16-103 100/90mm 32 mm
16-104 105/95mm 35 mm
16-105 115/105mm 40 mm
Total length/working
length width



16-106
COLLIN
for virgins
95/85 x 18 mm



CUSCO
16-107A Small
16-107B Medium
16-107C Large



16-107
CUSCO
for virgins
75 x 17 mm



16-108
CUSCO
for virgins
75 x 17 mm



CUSCO
Japanese model
16-108A Small
16-108B Medium
16-108C Large
Stainless steel forged handle
16-108D Small
16-108E Medium
16-108F Large
Stainless steel sheet handle



16-109 - 111
CUSCO
Swiss patterns features:
long and narrow
16-109 92X23-25 mm
16-110 100x25-27 mm
16-111 110x27-30 mm



16-112 - 115
CUSCO
STANDARD
16-112 80X24 mm
16-113 80X32 mm
16-114 90X36 mm
16-115 110X37 mm



CUSCO PLIANT
16-112 A 16 x 100 mm
16-112 B 20 x 100 mm
16-112 C 25 x 100 mm
16-112 D 28 x 100 mm
16-112 E 30 x 100 mm
16-112 F 32 x 100 mm
16-112 G 36 x 100 mm



16-116 - 119
CUSCO
16-116 80X24 mm
16-117 80X32 mm
16-118 90X36 mm
16-119 110X37 mm



Flat (duck beak)

16-120 - 122
CUSCO
16-120 80X32 mm
16-121 90X37 mm
16-122 115X37 mm



16-123 - 124
SEYFFERT
16-123 100X17 mm
16-124 110X33 mm
230 mm



CUSCO FIXE
16-112 H 16 x 100 mm
16-112 J 25 x 100 mm
16-112 K 32 x 100 mm
16-112 L 35 x 100 mm
16-112 M 40 x 100 mm



16-125
SEMM
for children
and virgins
180 mm
90X14-18mm



16-126 - 128
GRAVE
16-126 75X20 mm
16-127 95X30 mm
16-128 105X33 mm



16-129 - 130
PEDERSON
16-129 100X22 mm
16-130 120X25 mm



16-131 - 132
BRIESKY
16-131 72X25 mm / 77X30 mm 140mm
16-132 75X30 mm / 92X38 mm 170mm



16-133 - 135
SIMS
16-133 70X26 mm / 75 X30 mm
125 mm
16-134 75X30 mm / 80X35 mm
150 mm
16-135 80X36 mm / 90X40mm
175mm



16-136 - 138
SEIDL
16-136 80X8 mm
16-137 80X10 mm
16-138 90X14 mm
For children and infants
170 mm



16-139
KRISTELLER
70X15 mm. (170 mm)
For children

16-140 - 142
KRISTELLER
16-140 70X27 mm
16-141 75X30 mm
16-142 90X36 mm
175 mm







JAYLE
16-181A 60 x 40 mm, 60 x 40 mm
16-181B 90 x 40 mm, 90 x 40 mm
Blade with weight



16-182
60 X 45 mm



16-183
90 X 45 mm



16-184
112 X 45 mm



16-182 - 184
DOYEN
235 mm

Length of blades	Width of blades		
	35 mm	45 mm	60 mm
60 mm	16-185	16-188	16-192
90 mm	16-186	16-189	16-193
120 mm	16-187	16-190	16-194
160 mm	16-188	16-191	16-195



16-185 - 195
DOYEN
240mm



DE LEE
Universal Retractor
16-195A
24 cm
Blade 2 1/2" x 2"



16-196 - 200
BREISKY
WIENER MODELL/
VIENNA PATTERN
16-196 100 X 20 mm
16-197 100 X 25 mm
16-198 100 X 30 mm
16-199 100 X 35 mm
16-200 100 X 40 mm
300 mm



16-201 - 205E
BREISKY
320 mm



16-208
removable strainer only

16-201 130 x 20 mm
16-202 130 x 25 mm
16-203 130 x 30 mm
16-204 130 x 35 mm
16-205 130 x 40 mm
16-205A 155 x 40 mm
16-201A 100 x 20 mm
16-202B 100 x 25 mm
16-203C 100 x 30 mm
16-204D 100 x 35 mm
16-205E 100 x 40 mm

16-206 - 207
WEISSBARTH
16-206 80 X 28 mm
16-207 85 X 42 mm
210 mm



16-209
DOYEN
lateral speculum
80 x 30 mm
250 mm



16-211
115 X 26 mm
275 mm



16-212
AUVARD
65 X 38 mm - 28 mm
1,530 kg = 3 lbs
with fixed weight
230 mm

16-213 - 214
AUVARD
16-213 75 X 42-40 mm
16-214 105 X 43-40 mm
1,470 kg = 3 lbs
with detachable weight
230 mm

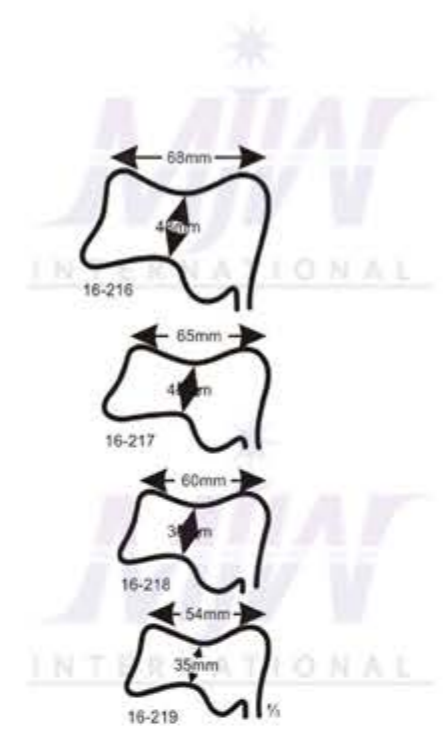

16-216 - 219
MARTIN
with hook shaped
handle for hanging
in weights
270 mm



The mentioned blades (16-221 - 225 and 16-229 - 236) can be exchanged. They fit handle (16-226), as well as handles (16-237 and 16-238).



16-228
BOZEMANN
Set consisting of:
2 handle (16-237 - 238)
8 blades (16-229 - 236)



16-226
16-220 - 225
SCHERBACK
Set consisting of:
handle 16-226
weight 16-227
4 blades 16-221-225



16-237
230 mm

16-238
220 mm



ST-MARKS
16-239
29 cm / 11 1/2"

ST-MARKS
16-240
32.5 cm / 13"

ST-MARKS
16-241
32.5 cm / 13"

THROKSON
33 cm
16-242 40 x 170 mm
16-242A 50 x 170 mm
16-242B 65 x 170 mm
with holes
16-242C 40 x 170 mm
16-242D 50 x 170 mm
16-242E 65 x 170 mm
with 3 slots



17-101 - 143
HEGAR
with very conical point
185 mm

17-101	1 mm
17-102	2 mm
17-103	3 mm
17-104	4 mm
17-105	5 mm
17-106	6 mm
17-107	7 mm
17-108	8 mm
17-109	9 mm
17-110	10 mm
17-111	11 mm
17-112	12 mm
17-113	13 mm
17-114	14 mm
17-115	15 mm
17-116	16 mm
17-117	17 mm
17-118	18 mm
17-119	19 mm
17-120	20 mm
17-121	21 mm
17-122	22 mm

17-123	23 mm
17-124	24 mm
17-125	25 mm
17-126	26 mm
17-127	1 1/2 mm
17-128	2 1/2 mm
17-129	3 1/2 mm
17-130	4 1/2 mm
17-131	5 1/2 mm
17-132	6 1/2 mm
17-133	7 1/2 mm
17-134	8 1/2 mm
17-135	9 1/2 mm
17-136	10 1/2 mm
17-137	11 1/2 mm
17-138	12 1/2 mm
17-139	13 1/2 mm
17-140	14 1/2 mm
17-141	15 1/2 mm
17-142	16 1/2 mm
17-143	17 1/2 mm

Set of 13 dilators

17-144	1/2 mm
17-145	3/4 mm
17-146	5/8 mm
17-147	7/8 mm
17-148	9/10 mm
17-149	11/12 mm
17-150	13/14 mm
17-151	15/16 mm
17-152	17/18 mm
17-152a	19/20 mm
17-152b	21/22 mm
17-152c	23/24 mm
17-152d	25/26 mm



Set Of 5 Dilators



17-152-5



PRATT
17-153A
Double ended
26.5 cm

Set of 6, Sizes 13 through 43 French

Sizes 13/15 French
Sizes 17/19 French
Sizes 21/23 French
Sizes 25/27 French
Sizes 29/31 French
Sizes 33/35 French
Sizes 37/39 French
Sizes 41/43 French



17-153
HEGAR
Double ended
Uterine dilator set
with 8 dilators
20 cm
Available in canvas and synthetic pouch

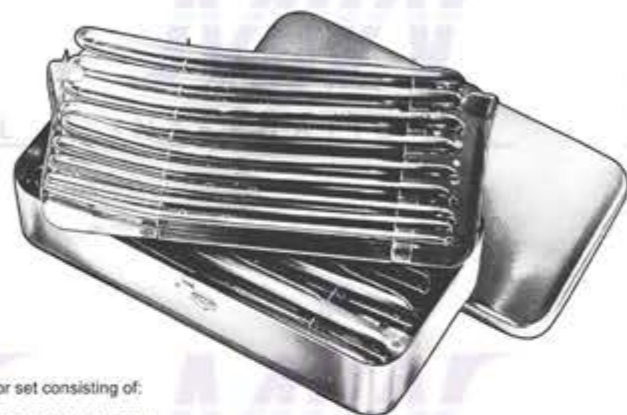

17-154
HEGAR
(17-104 - 117) Dilator set consisting of:
14 Dilators,
(17-155)1 Rack for dilators (4 - 12 mm)
(17-156)1 Rack for Dilators (13 - 17 mm)
(17-157)1 Metal case only,
with hinged lid, stainless 200 X 100 X 35 mm

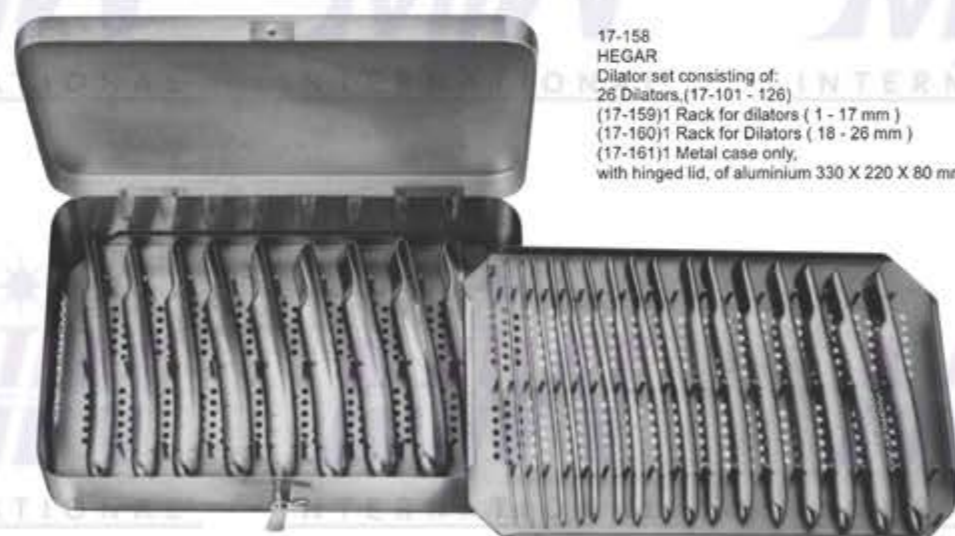

17-158
HEGAR
Dilator set consisting of:
26 Dilators, (17-101 - 126)
(17-159)1 Rack for dilators (1 - 17 mm)
(17-160)1 Rack for Dilators (18 - 26 mm)
(17-161)1 Metal case only,
with hinged lid, of aluminium 330 X 220 X 80 mm



17-163
KOGAN
Endospecula for cervix
and urethra, without ratchet
240 mm



17-164
KOGAN
Endospecula for cervix
and urethra, with
scale-ratchet and fixing screws
240 mm

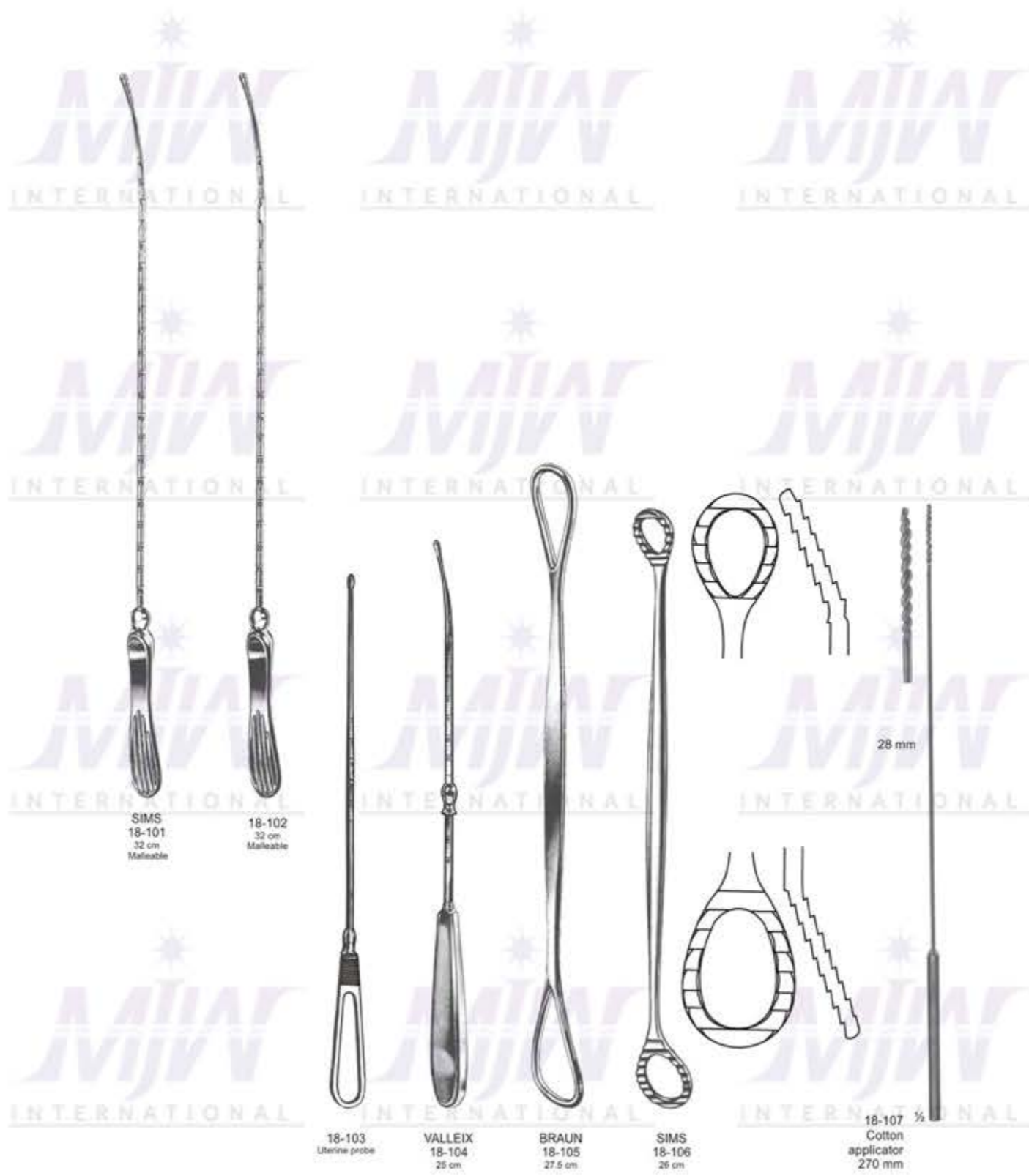



18-112
260 mm

18-112 - 113
BOZEMANN



18-113
250 mm



18-114
BOZEMANN-DOUGLAS
260 mm



18-115
BRAUN
slender type
250 mm



Standard

18-116
SCHROEDER
250 mm



18-117
POZZI
heavy type
255 mm



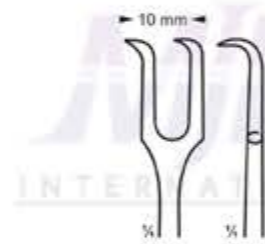



18-128
JACOBS
215 mm



18-129
LITTLEWOOD
185 mm



18-130
MUSEUX
200 mm



18-131 - 133
MUSEUX
240 mm



18-134 - 135
MUSEUX
265 mm



18-136 - 137
MUSEUX
curved sideways
240 mm



18-138
HEYWOOD-SMITH
200 mm



18-139
KELLY
320 mm



18-140
HEYWOOD-SMITH
250 mm



18-141
NOTO
280 mm

Atraumata



18-143
250mm



18-144
270mm



18-145
BUMM
280 mm



18-142
DOYEN
185 mm



18-143 - 144



18-146
COLLIN
250 mm



BEACHAM
18-147
26 cm
Amniotome for
amniotic bladder



SKENE
18-148
24 cm
Curved sideways



JARCHO
18-148A
20 cm

Uterine Dilating Forceps



WYLIE
18-148B
29 cm



SIMS
18-148C
29 cm



GODELL
18-148D
34 cm



18-149
SOMER
235 mm

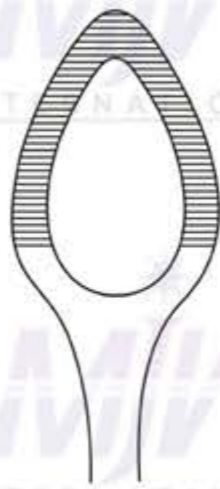

18-150
STRASSMANN
265 mm



With movable jaws



18-151
COLLIN
265 mm



18-152
APPREX
approx. 260 mm

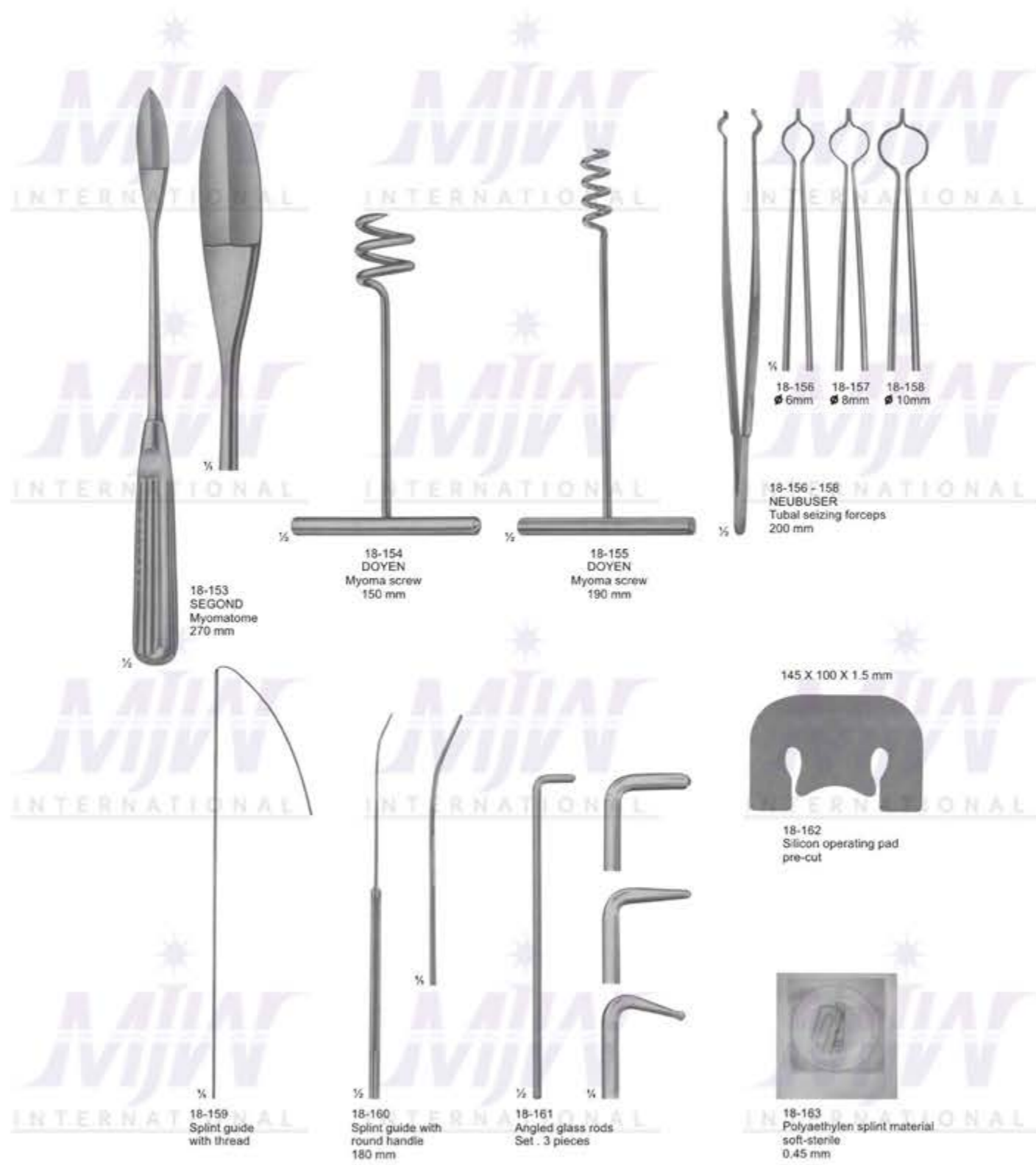

	SECTION	PAGE
Biopsy	19	237-245
Instruments		
Obstetrics	20	246-254



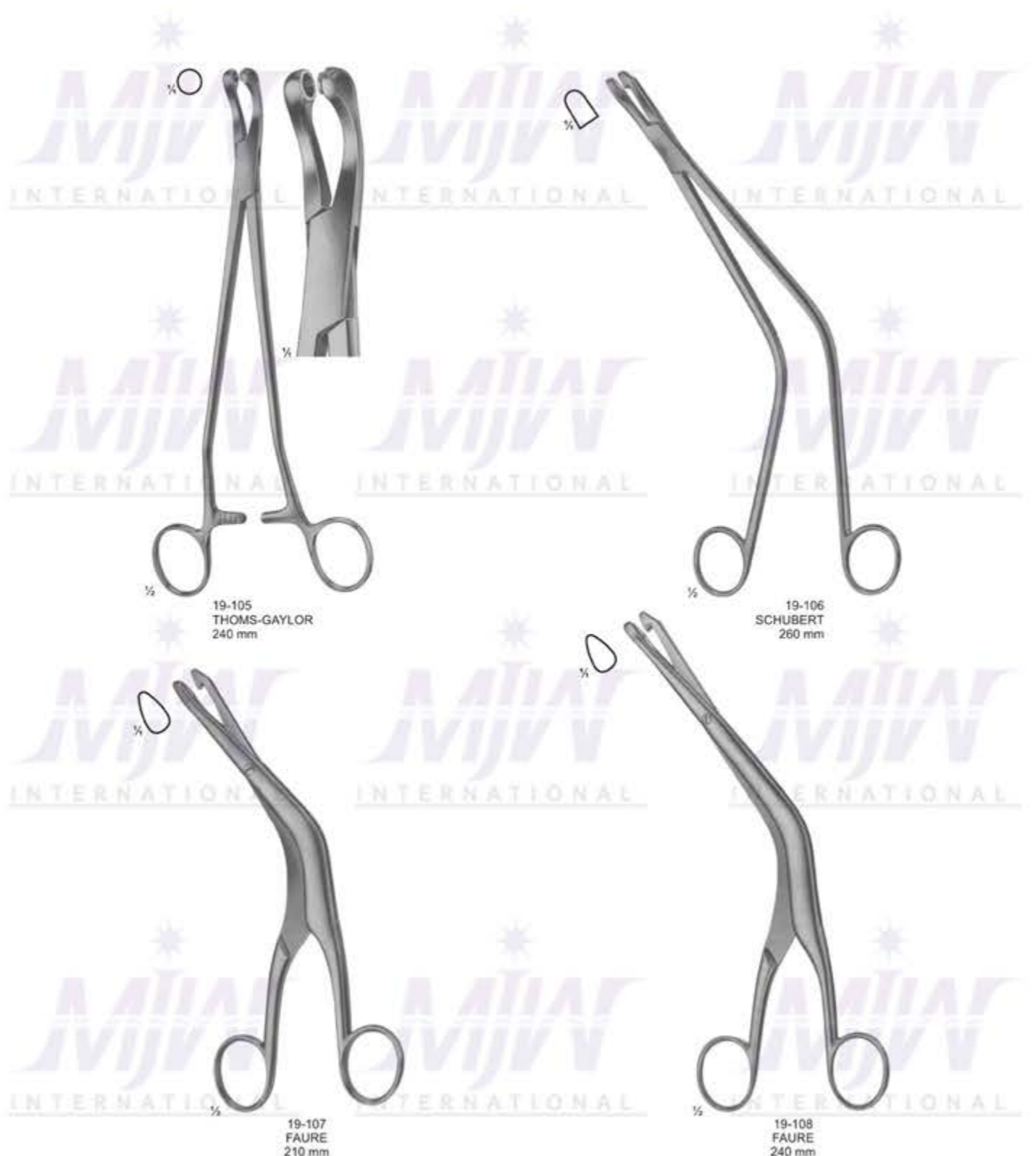

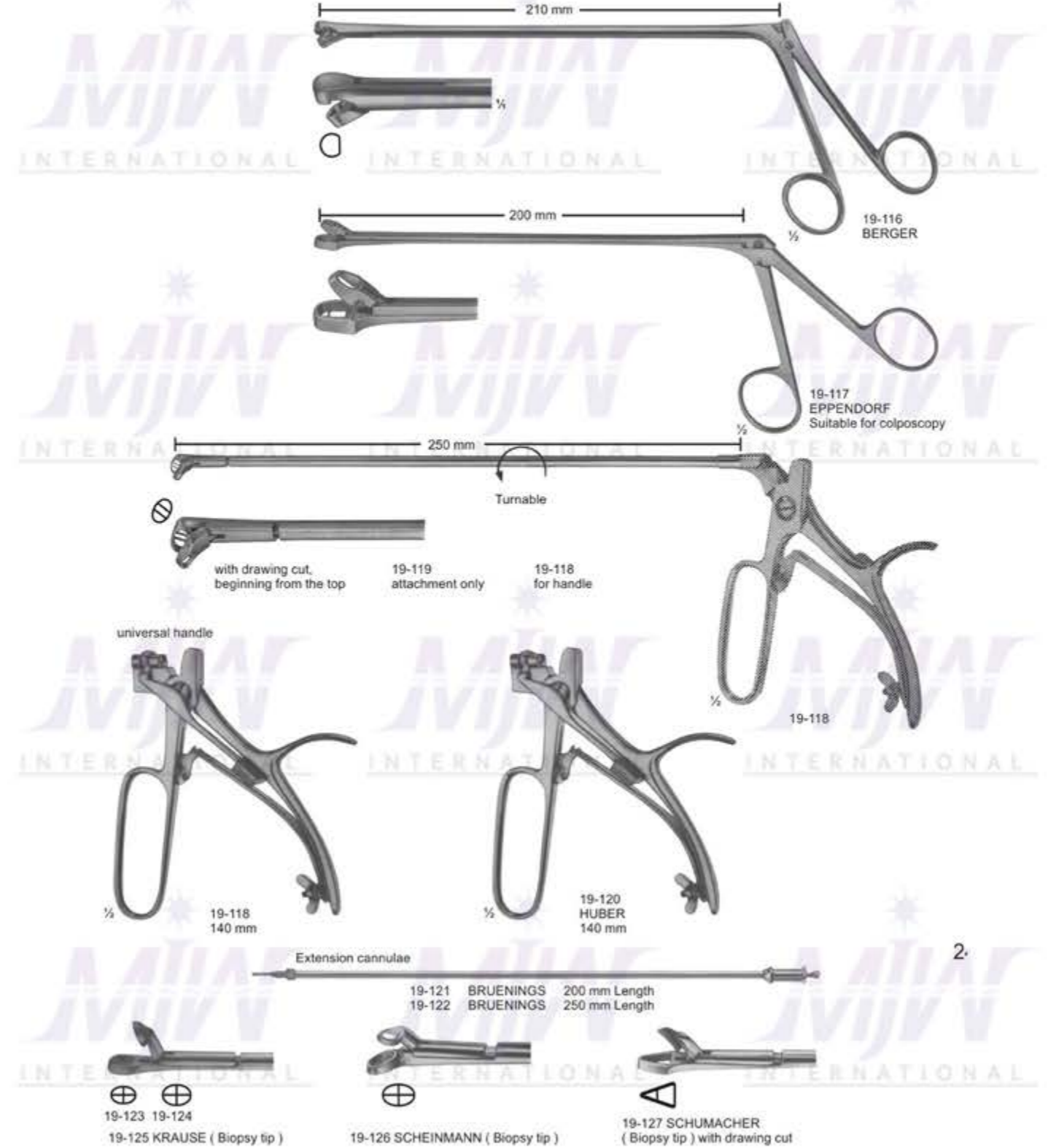
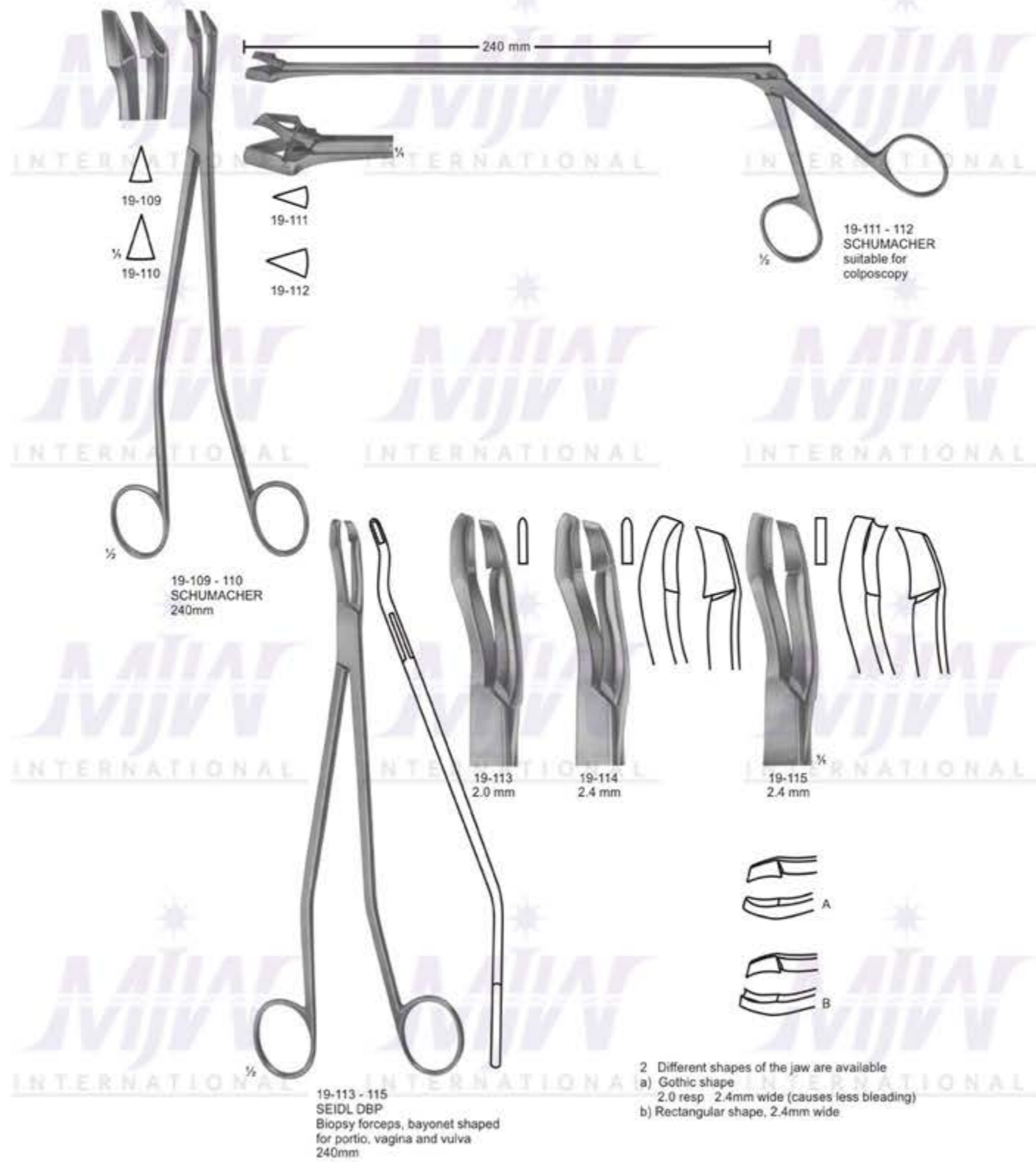
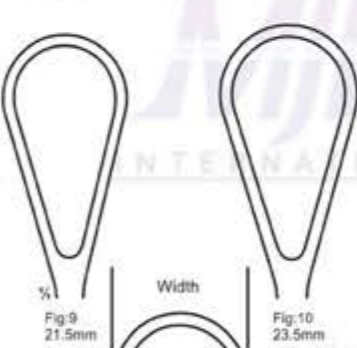
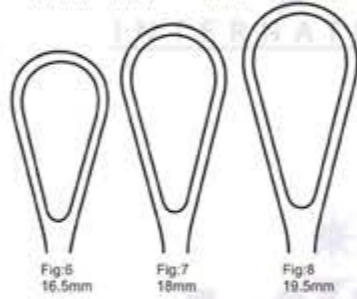
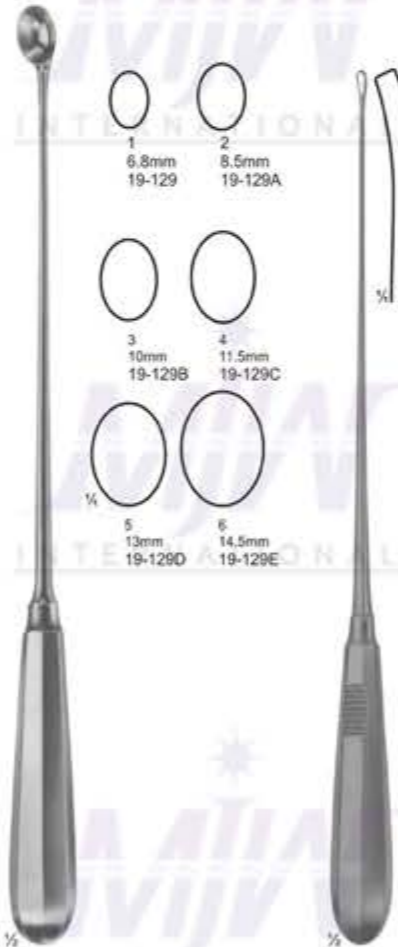

Table of Recamier		Sharp		Blunt
Fig	Width	Rigid	Malleable	Rigid
00	4.5mm	19.130		
0	7.5mm	19.131		19.142
1	8.5mm	19.132	19.153	19.143
2	10.5mm	19.133	19.154	19.144
3	12.0mm	19.134	19.155	19.145
4	14.0mm	19.135	19.156	19.146
5	15.0mm	19.136	19.157	19.147
6	16.5mm	19.137	19.158	19.148
7	18.0mm	19.138	19.159	19.149
8	19.5mm	19.139	19.160	19.150
9	21.5mm	19.140		19.151
10	23.5mm	19.141		19.152
19-130 - 19-141	Sharp - Rigid			
19-153 - 19-160	Sharp - Malleable			
19-142 - 15-152	Blunt - Rigid			



19-126 - 128E
SIMON
max.240 mm



19-129 - 129A
SCHRODER
max.310 mm



19-130 - 160
RECAMIER
max.300 mm

Fig	Width	Sharp		Blunt
		Rigid	Malleable	Rigid
1	7.5mm	19.161	19.167	19.173
2	8.5mm	19.162	19.168	19.174
3	10.5mm	19.163	19.169	19.175
4	12.0mm	19.164	19.170	19.176
5	14.0mm	19.165	19.171	19.177
6	15.0mm	19.166	19.172	19.178
19-161 - 19-166	Sharp - Rigid			
19-167 - 19-172	Sharp - Malleable			
19-173 - 19-178	Blunt - Rigid			



Fig	Width	Blunt - Malleable
0	16.5mm	19.179
1	18.5mm	19.180
2	19.5mm	19.181
3	21.5mm	19.182
4	23.5mm	19.183
5	26.0mm	19.184
6	28.5mm	19.185

Fig.2
19.5mm

Fig.3
21.5mm



19-161 - 178
SIMS
max. 255 mm



19-179 - 185
BUMM
blunt-malleable
max. 290 mm



19-186
BLAKE
275 mm

Fig	Width	Sharp		Blunt	
		Malleable	Malleable	Malleable	Malleable
1	23.5mm	19.190	19.192	19.192	19.192
2	26.0mm			19.193	19.193
3	28.5mm	19.191	19.194		



19-187
COLLIN
300 mm

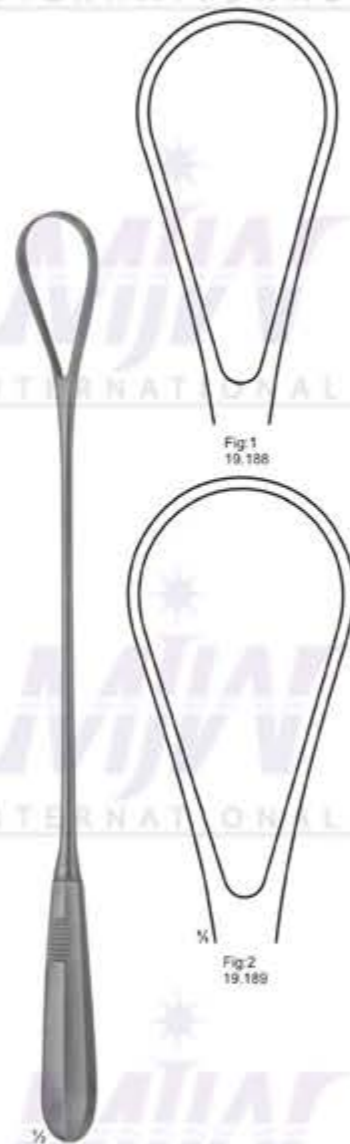

19-188 - 189 RECAMIER		Fig	Width	Blunt	
				Rigid	Rigid
blunt-rigid		1	34.5mm	19.188	19.188
max. 360 mm		2	39.5mm	19.189	19.189



19-190 - 194
BUMM
max. 310 mm
19-190 - 191 sharp-malleable
19-192 - 194 blunt-malleable

19-195 - 200
Suction curettes, stainless steel, fitting
hose connection. (19-201)

Working tips are smoothly rounded off,
therefore no danger of perforation.



(suitable for suction biopsy)
19-195: diam 4 mm
19-196: diam 6 mm
19-197: diam 8 mm
19-198: diam 10 mm
19-199: diam 12 mm
19-200: diam 14 mm

19-201
Hose connection inside diam. 11 mm,
curved, stainless steel.



The new connection between suction curette
and hose connection, (19-201)
Guarantees quick changing and free turning
of the suction curettes on the hose connection.

19-202
Transparent suction hose 1.8 mm long,
inside diam 11 mm, outside diam 16.5 mm
can be sterilized in an autoclave at 1 bar
overpressure (120°C)



19-203
Strainer for tissues, plastic, for single use only,
to be used for histopathological examination.



19-204 diam 8 mm-19-205 diam 10 mm
BOZEMANN-FRITSCH
Uterine Flushing Tube
350 mm



19-207
19-208

19-206
SCHULZE
Salpingograph, for utero-salpingography
in wooden case, consisting of:
19-207 Manometer only
19-208 Connection only, without manometer
19-209 Uterine cannula with tape without cone
19-210 Cone only, small
19-211 Cone only, medium
19-212 Cone only, large
19-213 Record syringe, 10CC, luer-lock mount.



19-209
19-210
19-211
19-212
19-213

19-214
SCHULZE
Salpingograph, equipment like(19-206)
but without manometer.



20-101
THOLE
for internal and external measure-
ments, graduated in centimeters

20-102
DE LEE
graduated in centimeters
and inches

20-103
COLLIN
graduated in
centimeters

20-104
MARTIN
graduated in
centimeters



20-105
SCHNEIDER
graduated in centimeters
The additional straight arm
can be replaced. The pelvimeter
with straight arm is used for
localisation of the portio vaginalis
uteri and of vaginal metastasis.



20-106
BREISKY
graduated in
centimeters



20-107 4 mm
20-107A 6 mm
20-107B 8 mm
20-107C 10 mm
20-107D 12 mm
20-107E 14 mm
20-107F 16 mm

Gyneco



Smellie
20-107G
33 cm / 13"



Wallich
20-107H
42 cm / 16 1/2"

20-107J 12 mm
20-107K 14 mm
20-107L 16 mm
20-107M 20 mm
Blunt



CUZZI
30 cm / 12"



Toothed back



20-108
14.5 mm
Blunt



20-108A
18 mm
Blunt



20-108B
21 mm
Blunt



DANIS
20-108C
24 cm / 9 1/2"



BOER
20-109
29 cm
Craniotomy forceps



SELLHEIM
20-110
30 cm
Obstetric lever



DUBIOS
27.5 cm
Decapitating scissors
(embryotomy)



BRAUN
20-111
32.5 cm
Decapitating hook



20-112

20-113



20-114
NAEGELE
355 mm



20-115
NAEGELE
400 mm



KIELLAND
20-115A
42 cm



BARNES-NEVILLE
20-115B
43.5 cm
With traction handle



PIPER
20-116C
44.5 cm

For delivery of the
after coming head in
breech presentation



SIMPSON-BRAUN
305mm

20-116
30.5 cm
20-116A
30.5 cm



KIELLAND-LUIKART
20-116B
39.5 cm

Solid
blades



MCLEAN
20-116C
39.5 cm / 15 1/2"
Solid blades,
short shank.



BARTON
20-116D
35.5 cm / 14"
One hinged blade



DEMELIN SUZOR
20-117
32 cm



BOERMA
20-117A
28 cm
For caesarean section



SIMPSON
20-118
23.5 cm
For caesarean section



WRIGLEY
20-118A
25 cm
For caesarean section



MURLESS
20-119
25.5 cm
Head extractor
with hinged shaft and sliding collar lock



DEWEY
20-119A
35.5 cm
Obstetrical forceps
with axis traction

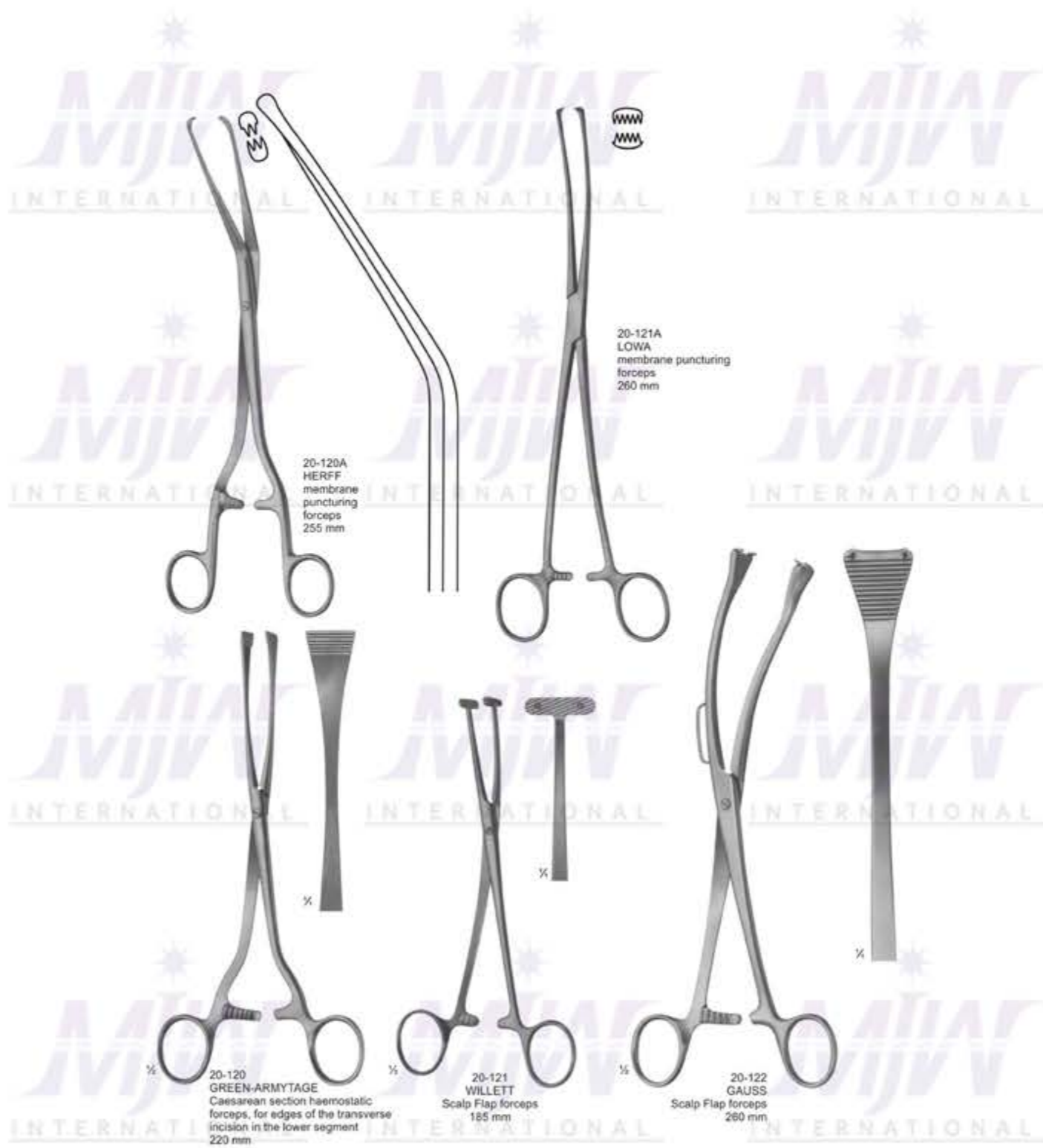



SECTION	PAGE
Cardiovascular, Tracheotomy & Thoracic Surgery	21 255-309

Fig.	0	1	2	3	4	5	6	7	8	9	10
Ø mm	4	5	6	7	8	9	10	11	12	13	14
Charr./Fr.	12	15	18	21	24	27	30	33	36	39	42



20-137
UECKERMANN-DENKER
Cryothyrotomy trocar
with silver cannula
130mm



Diam. X length	Fig.
4x50 mm	0
5x50 mm	1
6x50 mm	2
7x55 mm	3
8x60 mm	4
9x65 mm	5
10x70 mm	6
11x80 mm	7
12x85 mm	8
13x90 mm	9
14x90 mm	10

20-138 - 148
LUER
German silver



20-149 - 158
JACKSON
German Silver



Diam. X length	Fig.
4x50 mm	0
5x48 mm	1
6x58 mm	2
7x70 mm	3
8x78 mm	4
9x84 mm	5
10x84 mm	6
11x86 mm	7
12x88 mm	8
13x90 mm	9



Diam. X length	Fig.
5x48 mm	1
6x58 mm	2
7x70 mm	3
8x78 mm	4
9x84 mm	5
10x84 mm	6
11x86 mm	7
12x88 mm	8
13x90 mm	9
14x90 mm	10

20-159 - 168
JACKSON
Stainless Steel





21-118 185 mm
21-119 215 mm
21-120 230 mm
21-121 HALLE 180 mm

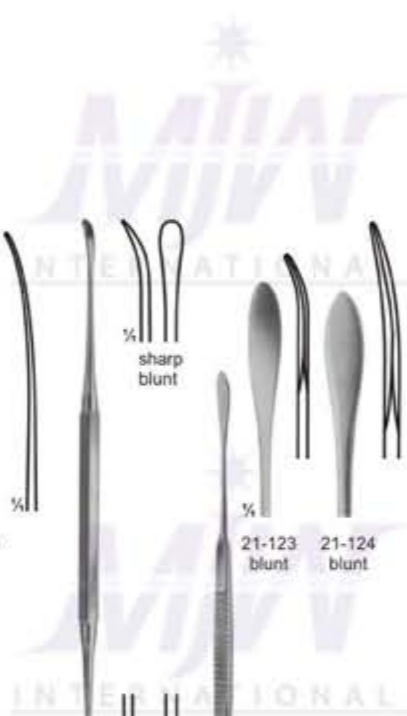

21-122 FREER sharp/blunt 185 mm
21-123 - 124 SCHMID blunt 140 mm 235 mm



21-125 DAVIS 245 mm
21-126 - 127 TOENNIS 240 mm



21-128 - 136 Endarterectomy strippers 550 mm

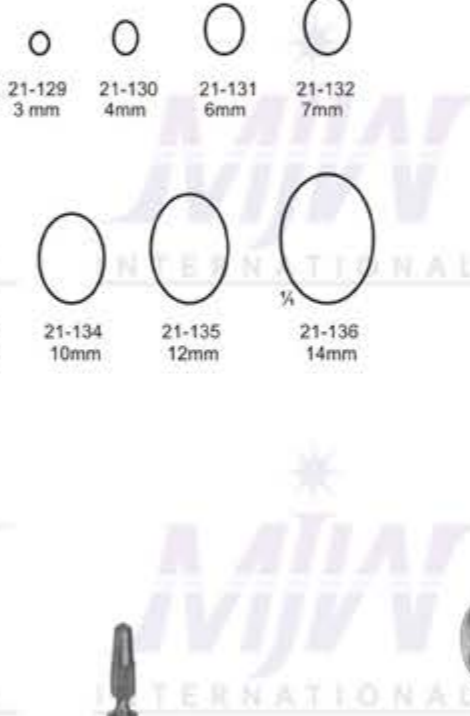

21-137 Handle for(21-128-136) 110 mm



21-138 - 139 RUMEL-BELMONT 325 mm
21-138 - 4,0 mm Ø
21-139 - 6,4 mm Ø



21-140 - 141 Guide only

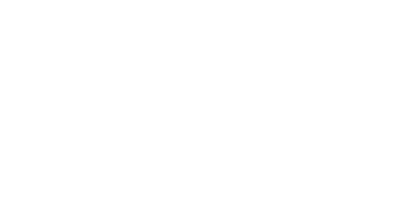



21-142
SCHULZ
Biopome, with flexible Shaft, 510 mm long,
with round jaws 3 mm diam.
Biopsy forceps, for biopsy from the right atrium
through cava jugularis, prior to heart implantations.



21-144
COOLEY
Dilator for
mitral valve
for children



21-143
TUBBS
Dilator for
mitral valve



Tunnelling tubes with conical tip	Length 300mm	Length 400mm	Length 500mm
12mm	21-146	21-149	21-152
14mm	21-147	21-150	21-153
17mm	21-148	21-151	21-154
Handle Forceps	21-155	21-156	21-157

21-145
Handle

21-155
Forceps



DE BAKEY
21-158
1 : 2 rows of teeth



DE BAKEY
21-159
2 : 3 rows of teeth



COOLEY
21-160
2 : 2 rows of teeth



DARDIK
21-161
2 : 3 rows of teeth









Mosquito Forceps





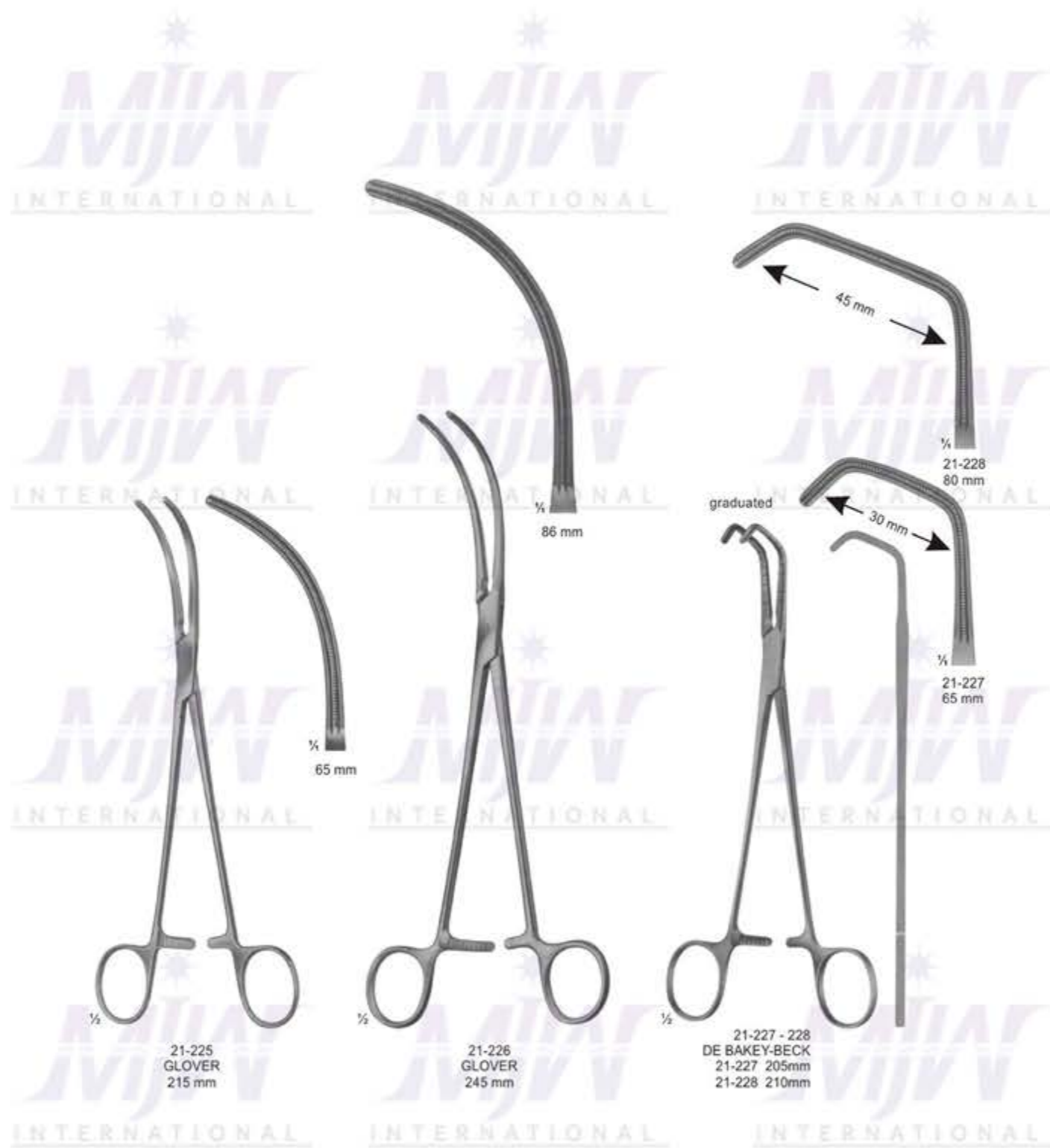





21-253
DE BAKEY
190 mm



21-254
DE BAKEY
200 mm



21-255
DE BAKEY
180 mm



21-256 - 257
LELAND-JONES
190 mm



21-258
LELAND-JONES
195 mm



21-259
DE BAKEY
200 mm



21-260
WERTHEIM
250 mm

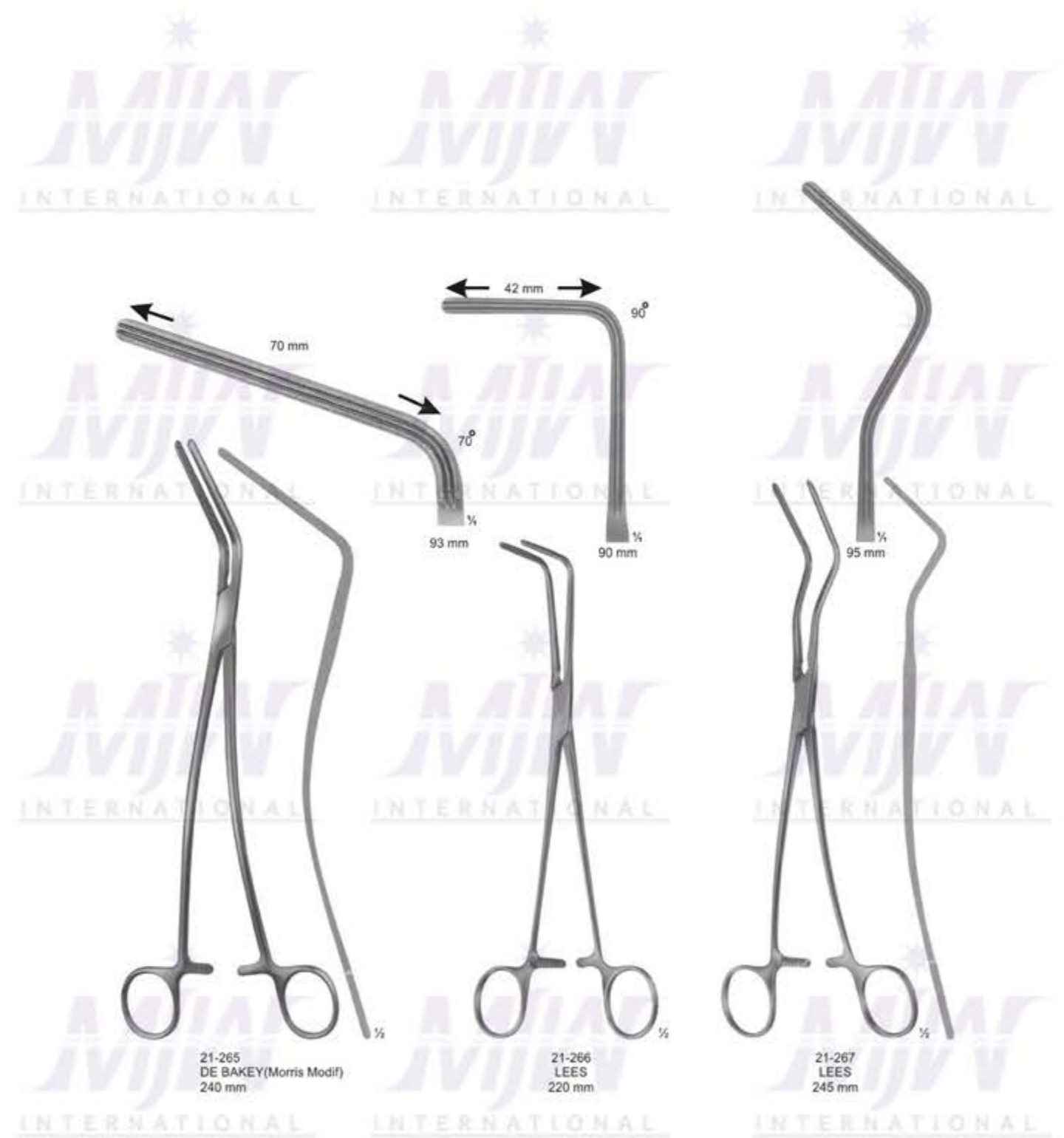





21-278
DIETRICH
210 mm

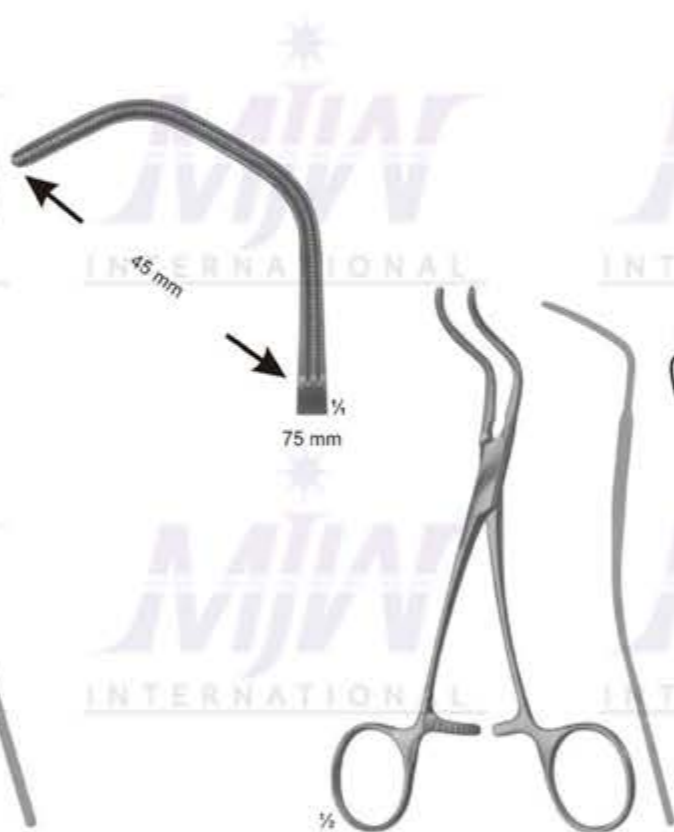

21-279
SUBRAMANIAN(Modif)
155 mm



21-280
OCHSNER
260 mm



21-281
DE BAKEY
265 mm



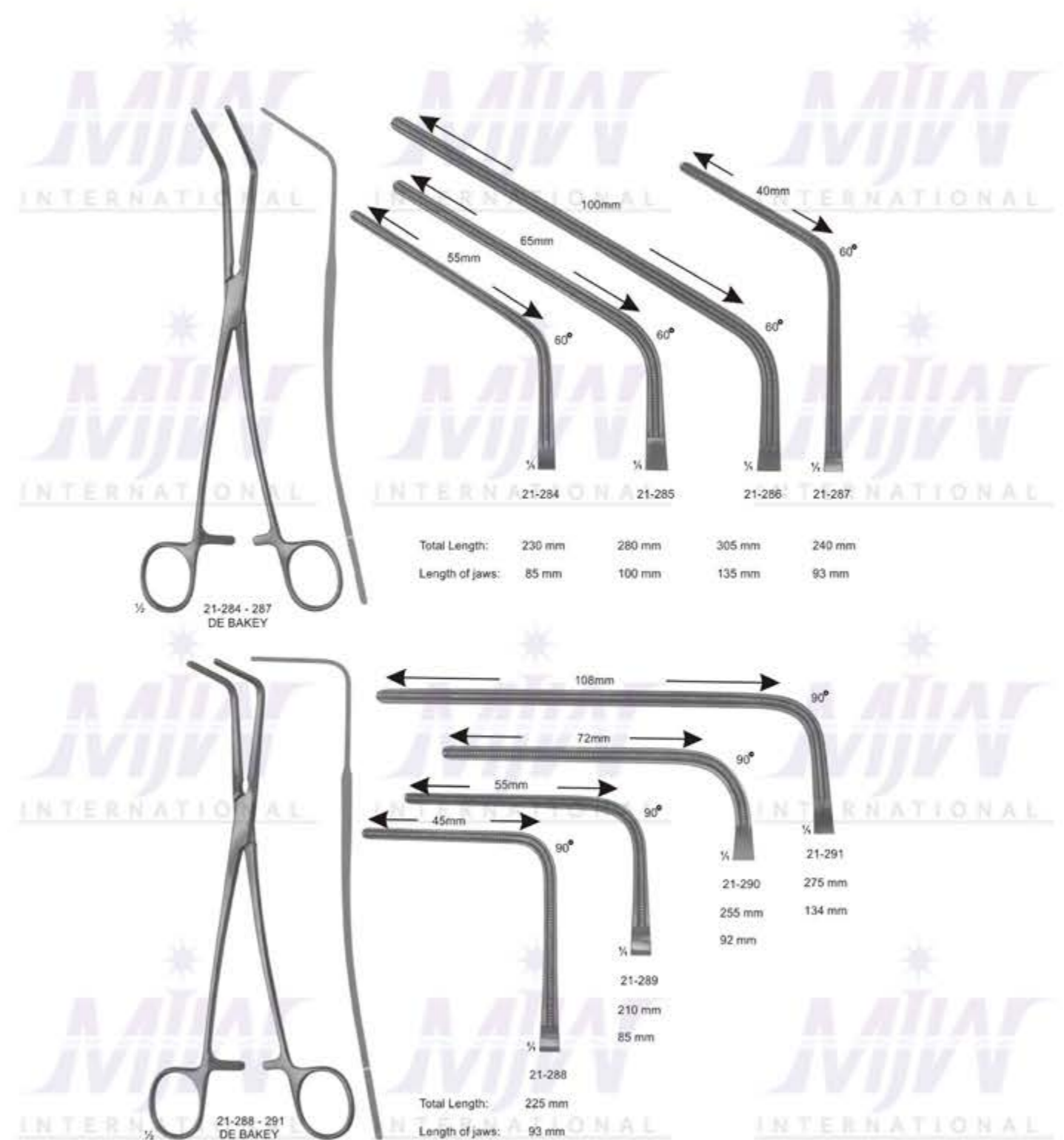
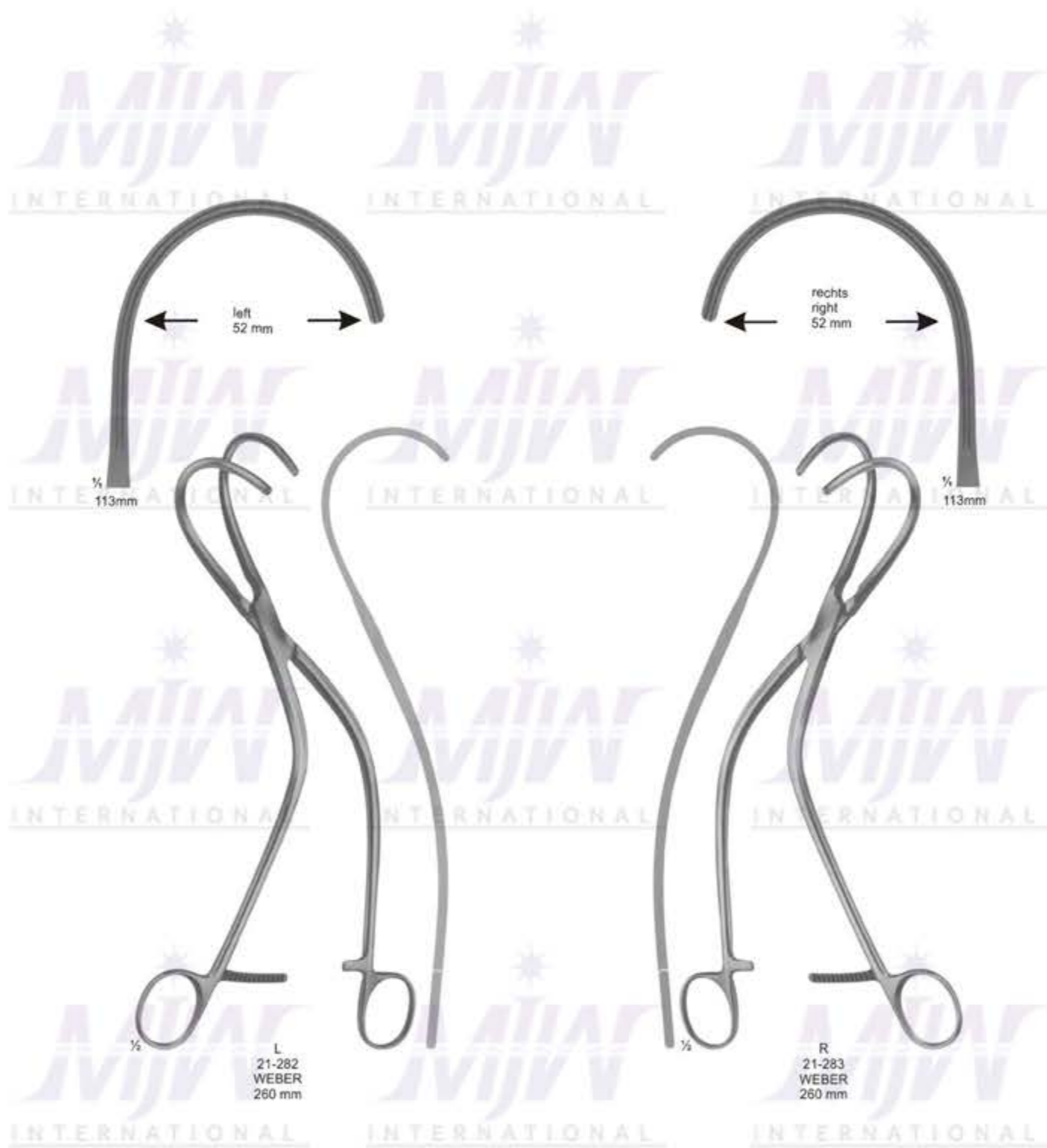

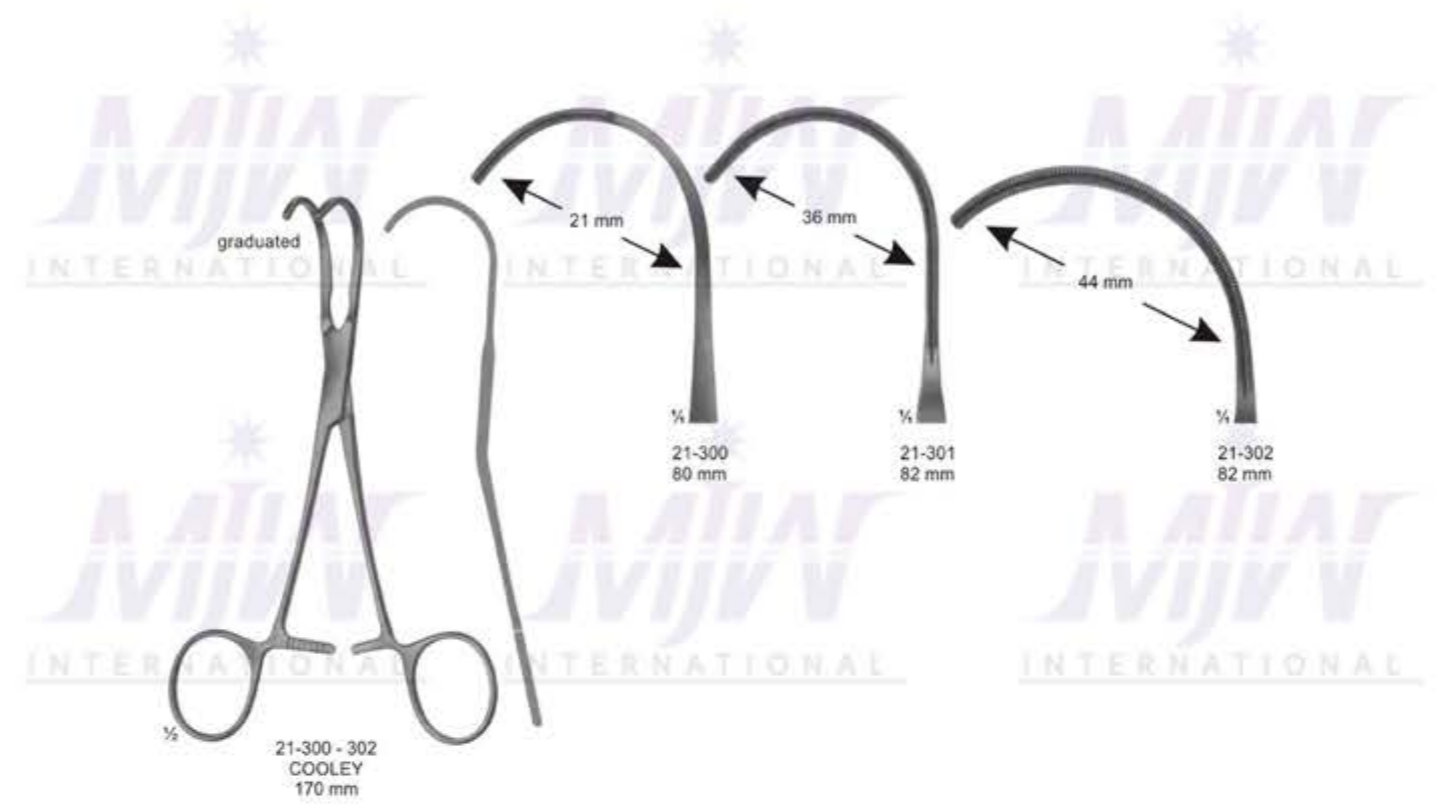

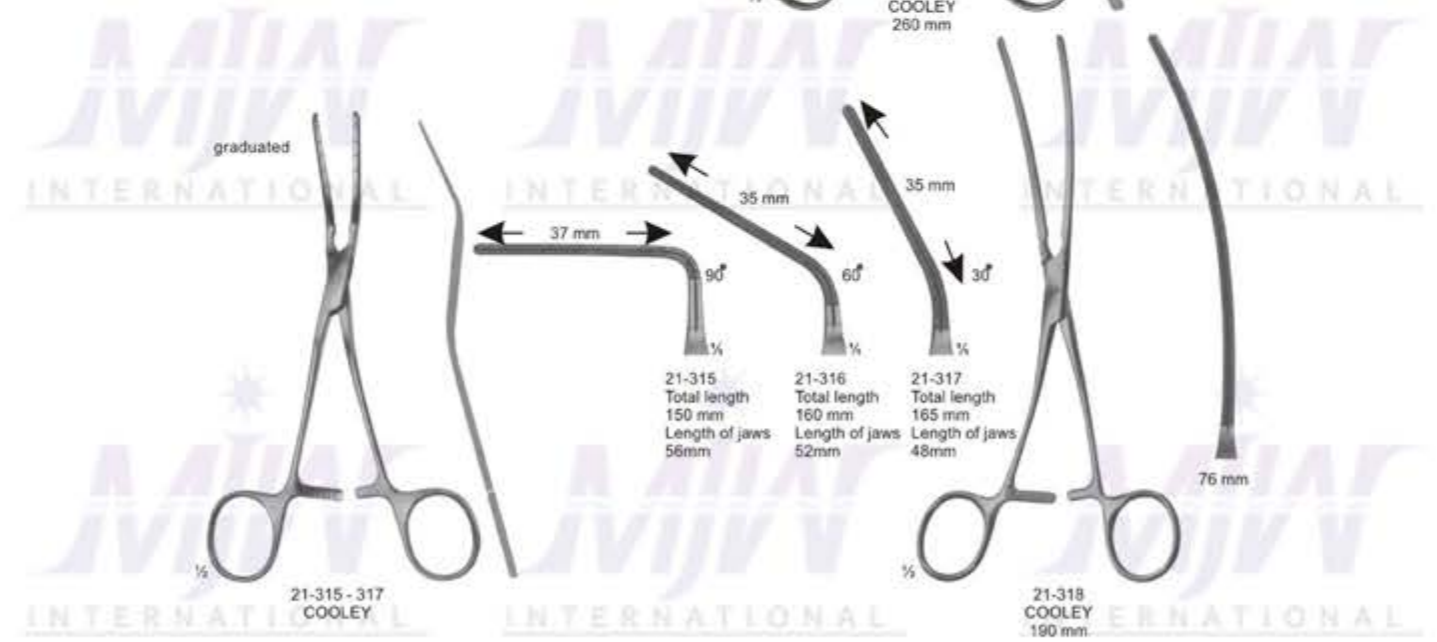

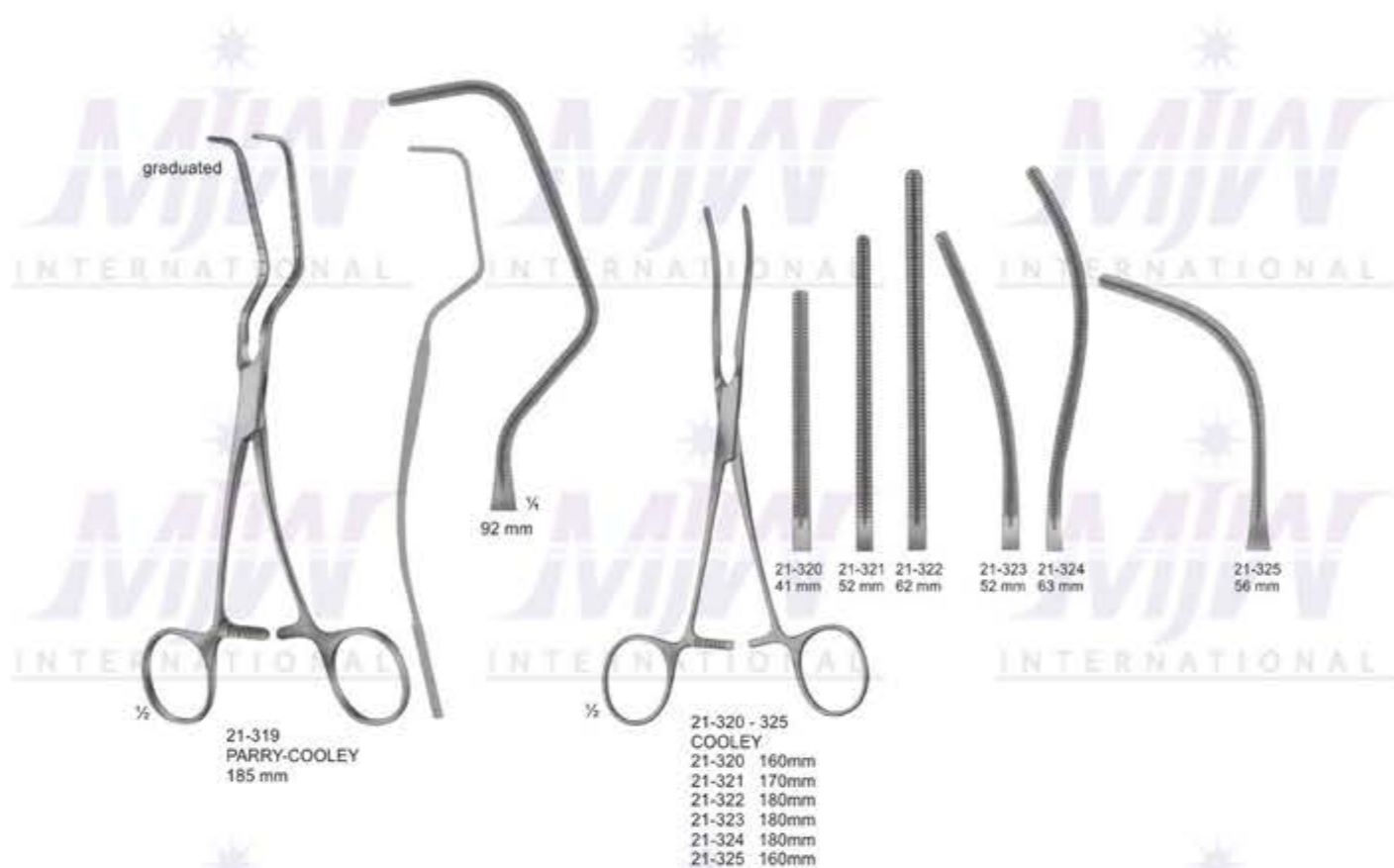

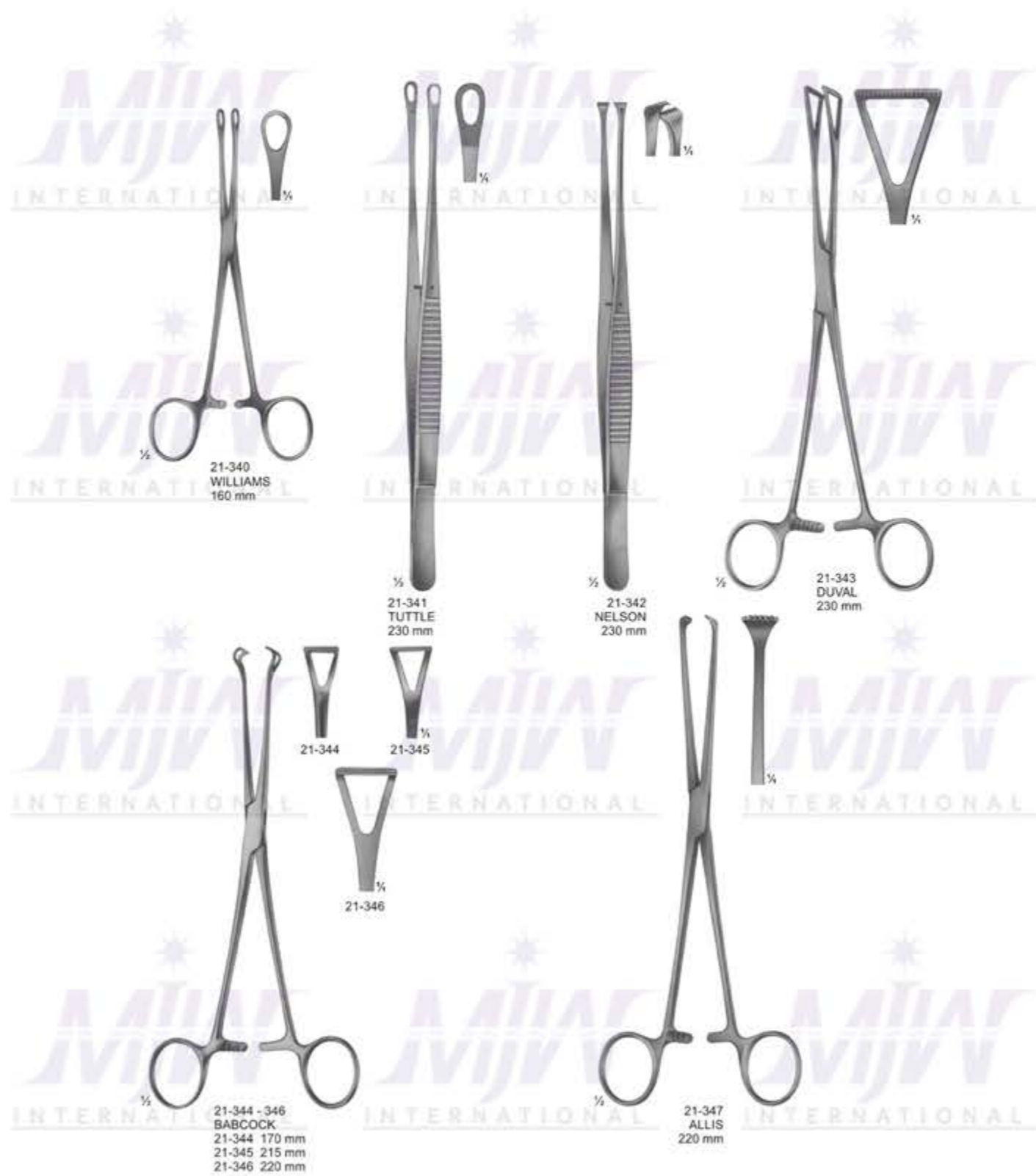





21-360
PERTUISET
Carotid Clamp
90 mm



21-361
CRAFOORD-SELLORS
240 mm

1/4
Elastic



21-362 - 363
CRAFOORD
240 mm

1/4
21-362
Elastic
1/4
21-363



1/4
21-364
PRICE THOMAS
225 mm



1/4
21-365 - 366
PRICE THOMAS
225 mm



1/4
21-365
jaws with pins



1/4
21-366
jaws with pins

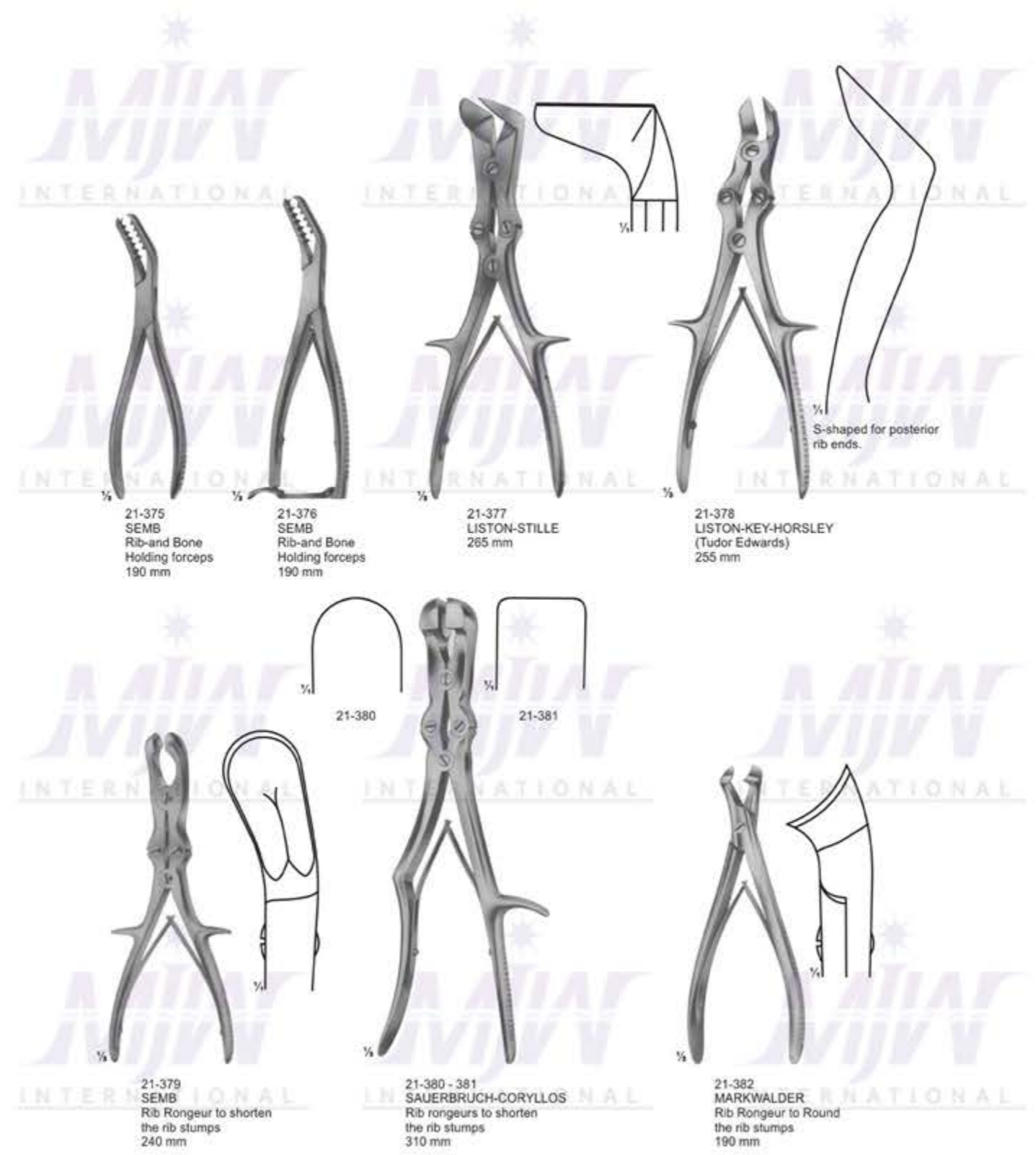



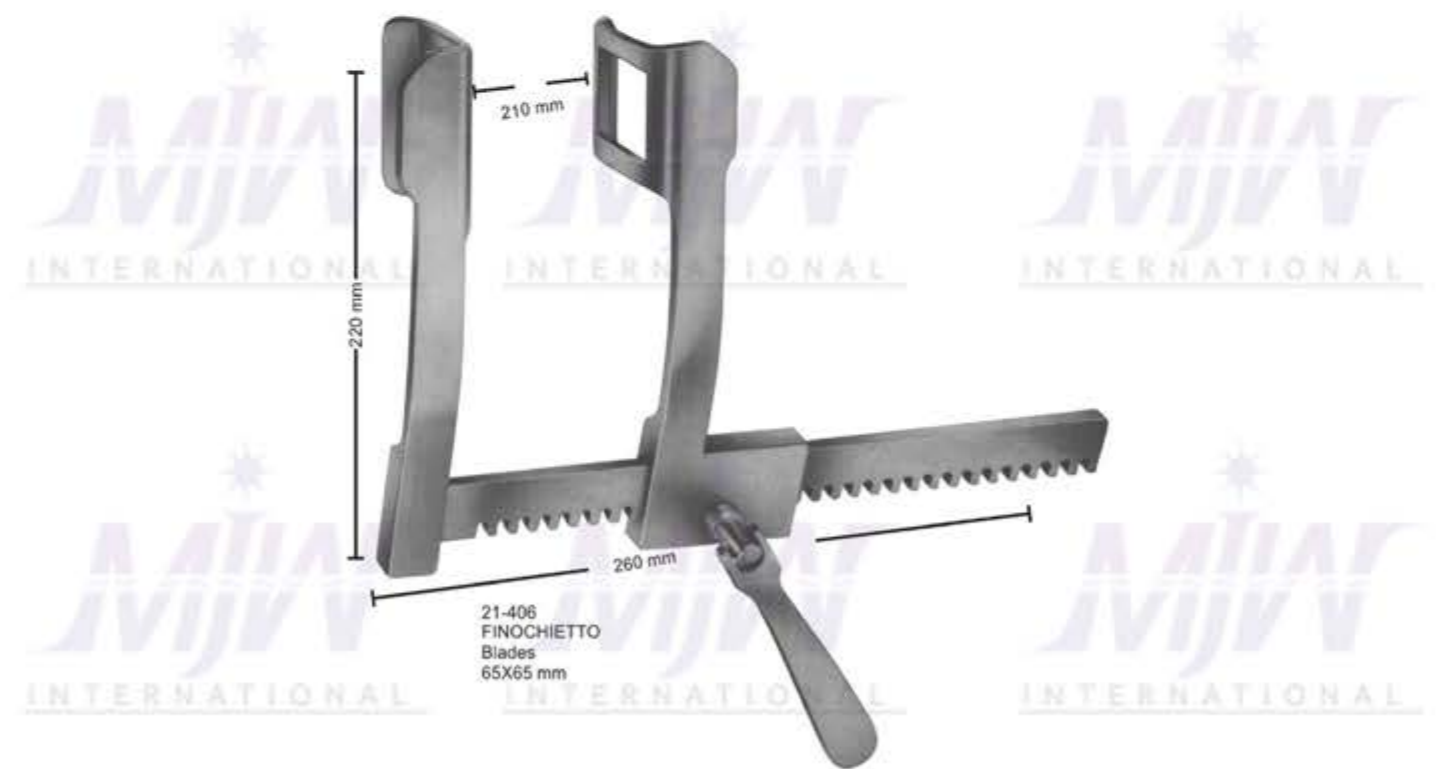
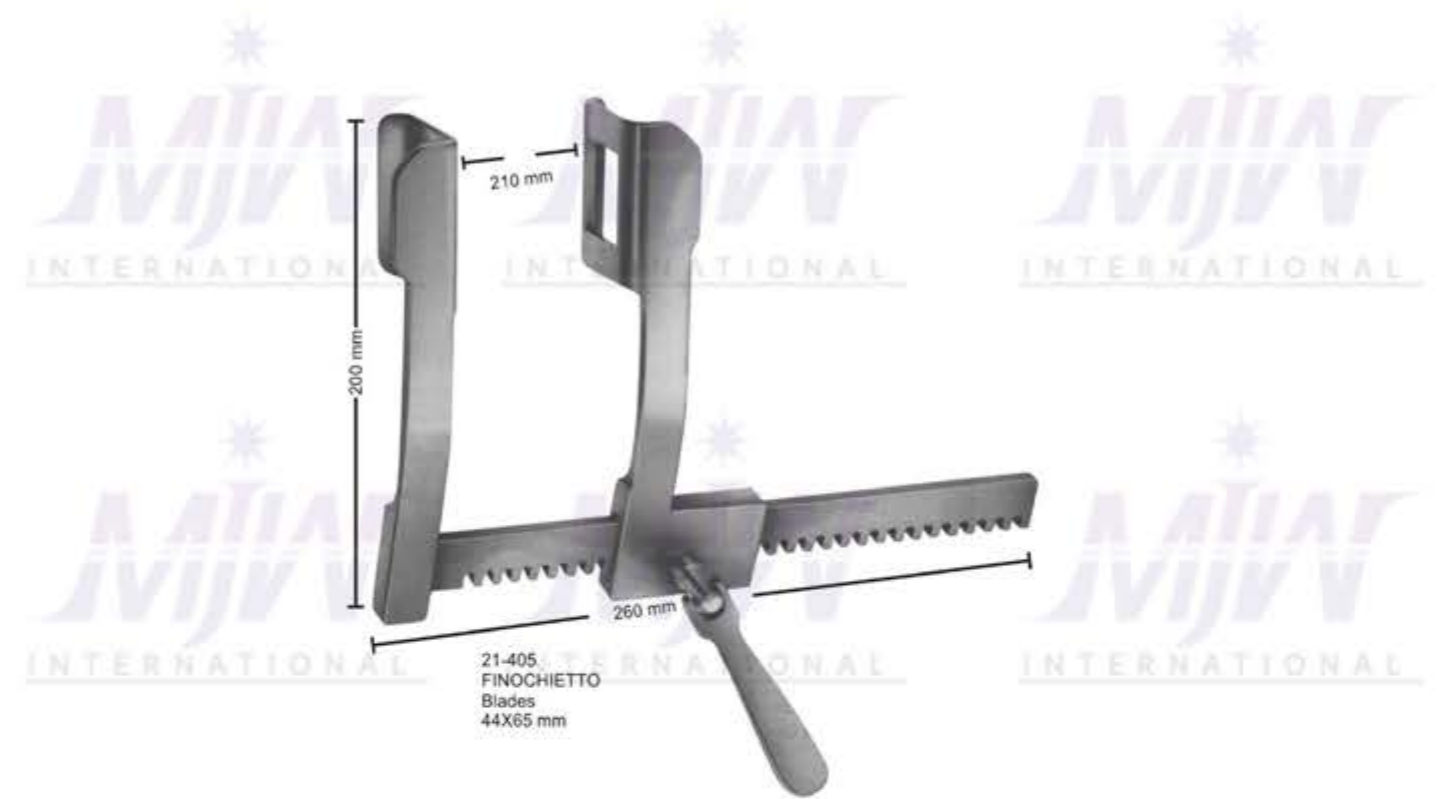



21-408
Blades
30x80 mm

21-409
Blades
40x67 mm

21-410
Blades
80x67 mm

21-411
Blade, Only, for preparation
of a. Mammaria, 25.5x80mm

21-407
FINOCHIETTO-BURFORD
with 2 pairs of blades
(21-409-410)



21-412
DE-BAKEY
with 3 pairs of blades
(21-414 - 21-416)

21-414
Blades
30x30 mm

21-415
Blades
40x40 mm

21-416
Blades
50x50 mm

Components for 21-412
Spreader only
Blades only
21-414 30x30mm
21-415 40x40mm
21-416 50x50mm
The Blades are delivered in Pairs.



21-417
DE-BAKEY
with 3 pairs of blades
(21-419, 420, 422)

Components for 21-417
Spreader only
Blades only
21-419 50x80mm
21-420 60x60mm
21-422 40x100mm
The Blades are delivered in Pairs.

21-419
Blades
50x80 mm

21-420
Blades
60x60 mm

21-421
Blades
80x60 mm

21-422
Blades
40x100 mm

21-423
Sternotomy Blades (50x66 mm)

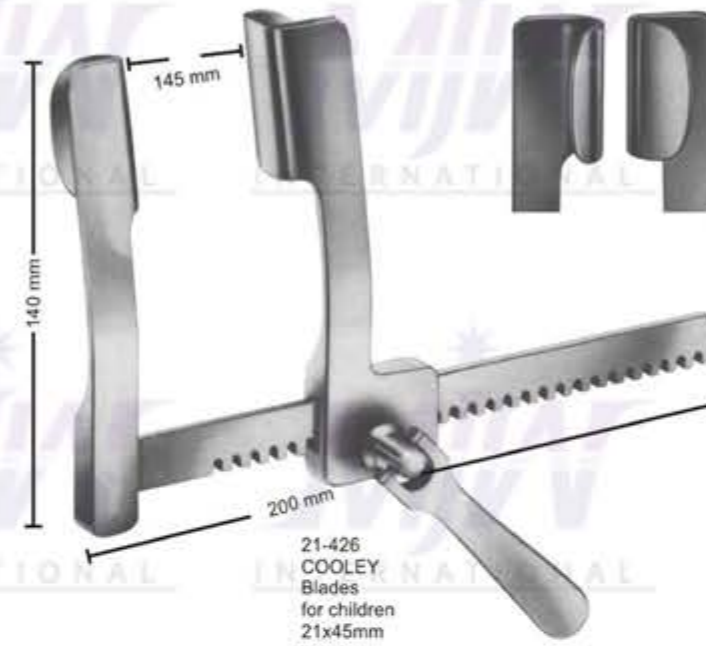



21-429
Blades
45 x 65 mm
Fig. 1

21-430
Blades
70 x 75 mm
Fig. 2

Blades with Ball Snap System
Delivery: in Pairs

21-428
Thoracic Retractor (Mercedes-Retractor)
complete consisting of:
21-428 A Retractor only
21-430 1 Pair of blades 42x65 mm
21-429 1 Pair of blades 75x75 mm



Ablaza-Morse
21-431
15 cm

Lemmon
21-431A
14 cm
21-431B
18 cm
Sternum-approximator
For adults



Sellors
21-432
20 cm



Bailey-Baby
21-433/e



Bailey
21-434
20 cm
Short claws



Bailey-Gibbon
21-434A
20 cm
Long claws



21-435
0.3 mm Ø



Eves
21-435A
28 cm

Eves
21-435B
28 cm



Bruenings
21-435C
28 cm



Tyding
21-436
With one straight tip

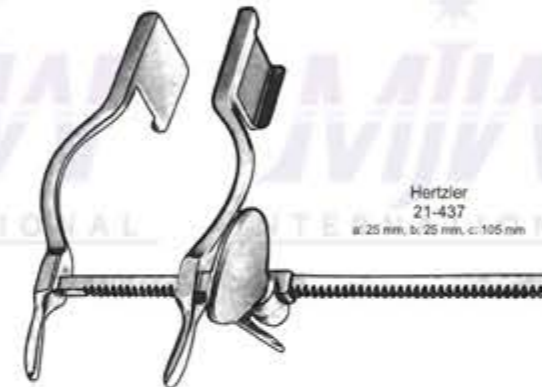
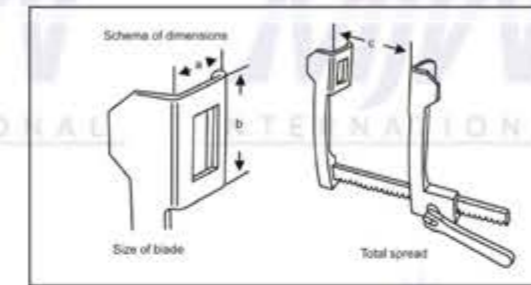

Hertzler
21-437
a: 25 mm, b: 25 mm, c: 105 mm



Morris
21-438
26 cm / 10 1/2"



Cooley
21-439



Cooley
21-440
24.5 cm / 9 1/2"
Right



Cooley
21-440A
24.5 cm / 9 1/2"
Right, slightly serrated



Cooley
21-440B
25.5 cm / 10"
Left

Orthopaedic Instruments
310 To 392



SECTION PAGE

Bone Punches And Rongeurs	22	310-318
Amputation, Elevators, Raspatories, Bone Levers Bone Files And Curettes	23-24	319-347
Mallets, Tampers, Chisels, Gauges, Bone Holding, Rongeurs & Cutting Forceps, Meniscus Instruments	25-26	348-379
Wire Extension, Finger Nail instruments	27	380-392

Angled positions for punchus

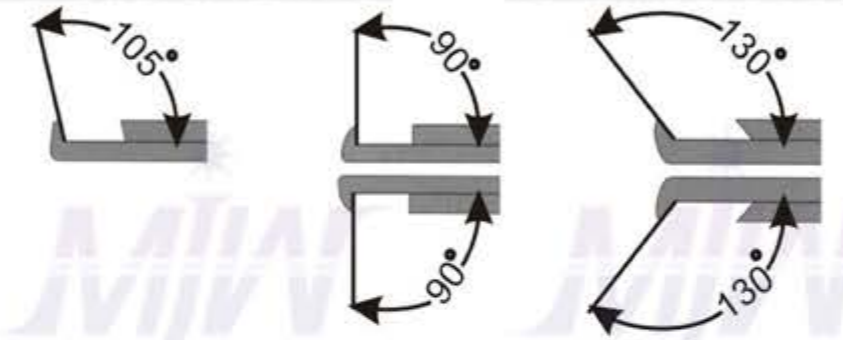

90° upwards cutting



90° upwards cutting



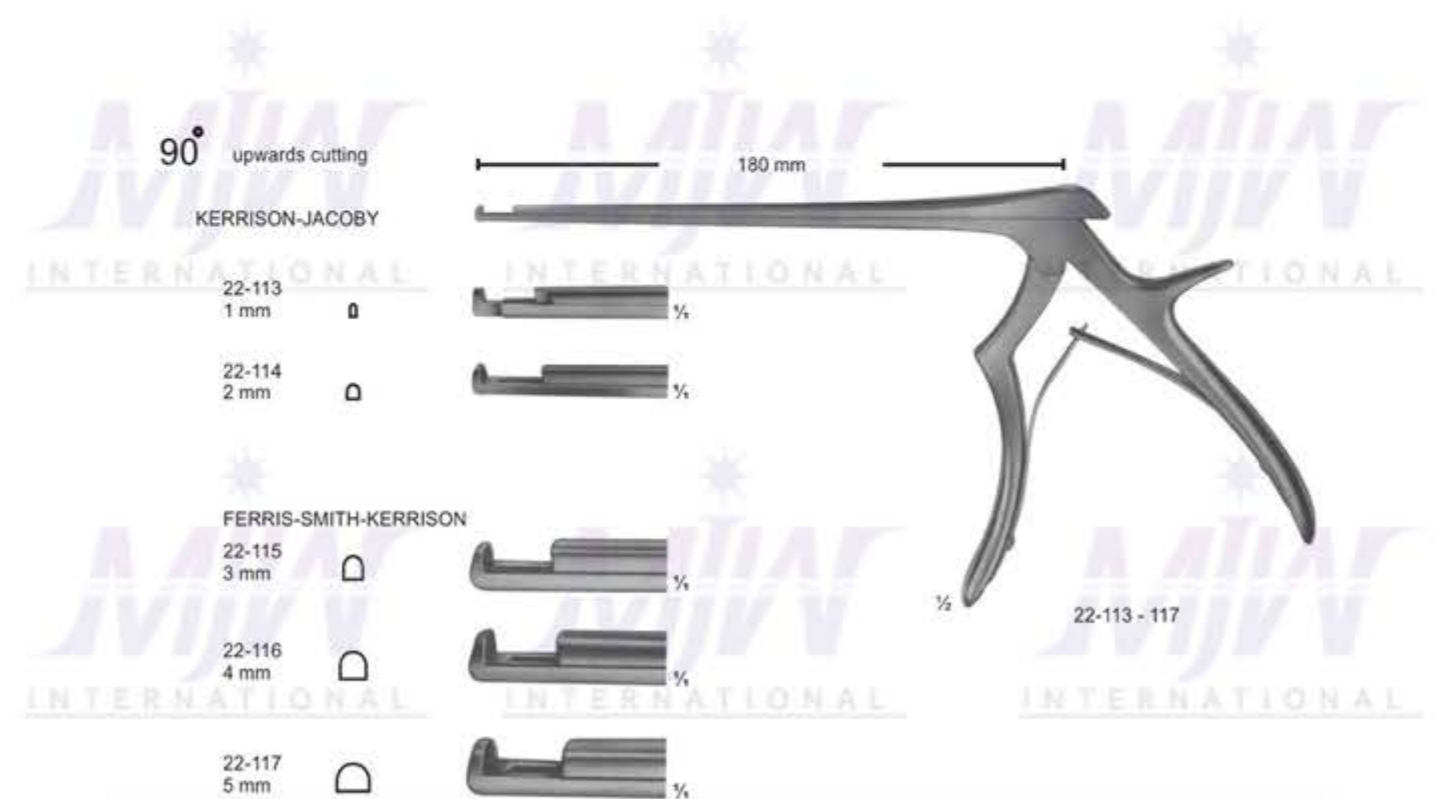
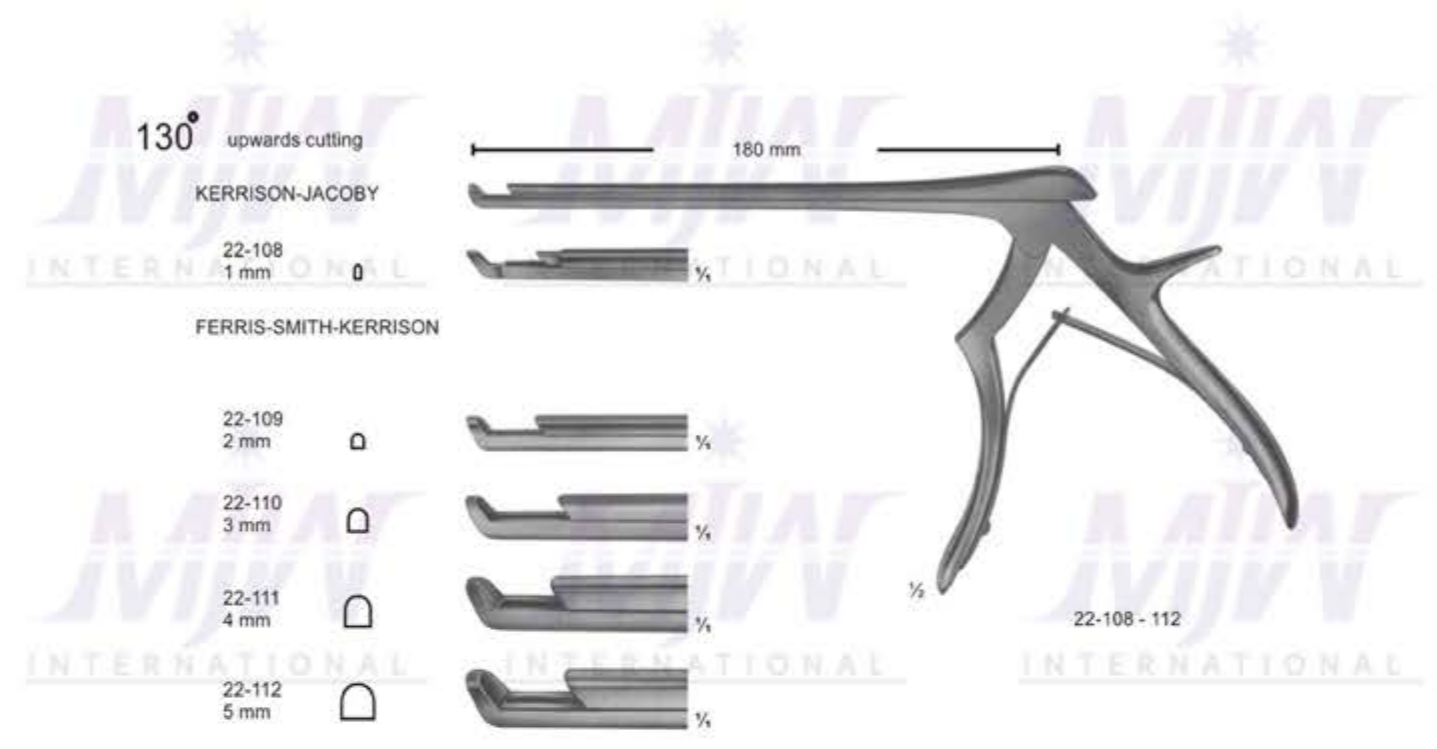

Angled positions for rongeurs



- 22-118
3,0 mm
- 22-119
3,6 mm
- 22-120
4,2 mm
- 22-121
4,8 mm
- 22-122
5,8 mm



LOVE-GRUENWALD

- 22-125
2 X 10 mm

- 22-126
3 X 10 mm

SPURLING

- 22-127
4 X 10 mm



- 22-128
2 mm

- 22-129
3 mm

- 22-130
4 mm

- 22-131
5 mm



150°

- 22-132
2 mm

- 22-133
3 mm

- 22-134
4 mm



150°
Lower part of jaws movable

22-135
2 mm

22-136
3 mm

22-137
4 mm



22-135 - 137
CASPAR

Length of shaft
140 mm

22-138

22-139

22-140

22-141

22-142

22-143

22-144

22-145

22-146

22-147

Length of shaft
160 mm

22-148

22-149

22-150

22-151

22-152

22-148

22-149

22-150

22-151

22-152



22-138 - 152
CASPAR

150°

Length of shaft
140 mm

22-153

22-154

22-155

Length of shaft
160 mm

22-156

22-157

22-158

Length of shaft
185 mm

22-159

22-160

22-161



22-153 - 161
CASPAR

150°
Lower part of jaw movable

Length of shaft
140 mm

22-162

22-163

Length of shaft
160 mm

22-164

22-165

Length of shaft
185 mm

22-166

22-167

size of jaws

3 X 12 mm

4 X 14 mm

22-162 - 167
CASPAR

22-166 - 167
CASPAR



22-168
2 X 10 mm
CUSHING

22-169
3 X 10 mm
LOVE-GRUENWALD

22-170
4 X 10 mm
SPURLING

150°

22-171
3 X 10 mm
LOVE-GRUENWALD

22-172
4 X 10 mm
SPURLING



22-168 - 170



22-171 - 172

150°
Upper part of jaw movable

22-173
3 X 10 mm
LOVE-GRUENWALD

22-174
4 X 10 mm
SPURLING

22-175
Ø 7 mm

18-176
YASARGIL
Ø 2.2 mm

18-177
YASARGIL
Ø 3.5 mm

180 mm

180 mm

190 mm

22-173 - 174

22-175
OLDBERG

22-176 - 177

22-178
4 mm

Osteophyte Rongeur

22-179
4 mm

Osteophyte Rongeur

22-180
5.5 mm

Very Heavy Pattern

145 mm

180 mm

200 mm

22-178
CASPAR

22-179
CASPAR

22-180
WAGNER



ADSON
23-101
15 cm
Drill guide

23-102
14 cm

23-103
14 cm

23-104
30 cm
Straight ball spike



PERTHES
23-105
18 cm

PERTHES
23-105A
21 cm

BUTCHER
23-105B
Blade 45 cm
Post mortem saw

23-105C
Blade 40 cm
Post mortem saw

23-105D
Blade 20 cm
Post mortem saw



23-105A For children
23-105B For adults



23-106
PERCY
removeable handles



23-107
PERCY
reversible handles



23-108
CHARRIERE
Length of blade
215 mm
complete with one saw
blade each(23-109 and 23-110)
350 mm

Spare saw blades, carbon steel
23-109 12 mm
23-110 20 mm



23-111
RUST
Length of blade
235 mm
complete with one saw
blade each(23-113, 23-114
and 2 saw blades 23-115)
390 mm
23-112 Bow only

Spare saw blades, carbon steel
23-113 6 mm
23-114 8 mm
23-115 12 mm
23-116 20 mm



23-117
BIER
Length of blade
270 mm
complete with one saw
blade each(23-118, 23-119 and 23-120)
420 mm

Spare saw blades, carbon steel
23-118 4 mm
23-119 6 mm
23-120 8 mm



23-121
CHARRIERE
Length of blade
180 mm
Spare saw blade,
carbon steel (23-122)
270 mm

23-123
CHARRIERE
Length of blade
240 mm
Spare saw blade,
carbon steel(23-124)
340 mm



23-125
SATTERLEE
Length of blade
200 mm
Spare saw blade,
carbon steel(23-126)
290 mm



23-127
LANGENBECK
Length of blade
115 mm
Metacarpal saw
235 mm

23-128A 2 mm \varnothing
 23-128B 3 mm \varnothing
 23-128C 4 mm \varnothing
 23-128D 5 mm \varnothing
 23-128E 6 mm \varnothing
 23-12F 8 mm \varnothing
 23-128G 10 mm \varnothing
 15.5 cm / 6"

KIENNY
 23-135A
 17.5 cm / 7"

TRILLAT
 23-135A 9 x 9 mm
 23-135B 9 x 10 mm
 20 cm / 8"

CILINDRIQUES DOUBLE
 23-137A 8 x 15 mm \varnothing
 16 cm / 6 1/2"
 23-137B 6 x 8 mm \varnothing
 23-137C 10 x 12 mm \varnothing
 21 cm / 8 1/2"

Gigli
 23-136A
 Handle with lock

23-128 - 131
 OLIVECRONA
 23-128 300 mm
 23-129 400 mm
 23-130 500 mm
 23-131 700 mm

23-132 - 135
 GIGLI
 23-132 300 mm
 23-133 400 mm
 23-134 500 mm
 fine, 6 wires twisted
 23-135 500mm
 coarse, 4 wires twisted

23-136
 GIGLI
 Handle

23-137
 LEBSCHÉ
 Conductor for
 wire saws, malleable
 250 mm

4.5 mm
 4.5 mm
 5 mm
 5.5 mm

24-101
 24-102
 24-103
 24-104

24-101 - 102
 KOENIG
 155 mm

24-103
 WILLIGER
 165 mm

24-104
 WILLIGER
 170 mm

6 mm
 8 mm
 10 mm
 11 mm

24-105
 QUERVAIN
 195 mm

24-106 - 107
 LANGENBECK
 195 mm

24-108
 LANGENBECK
 230mm

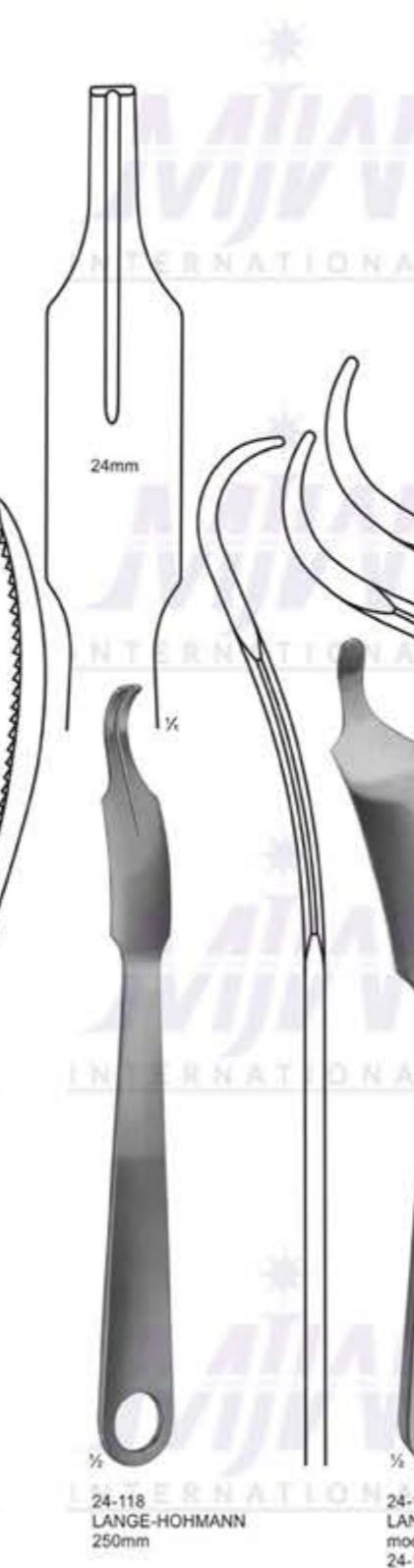

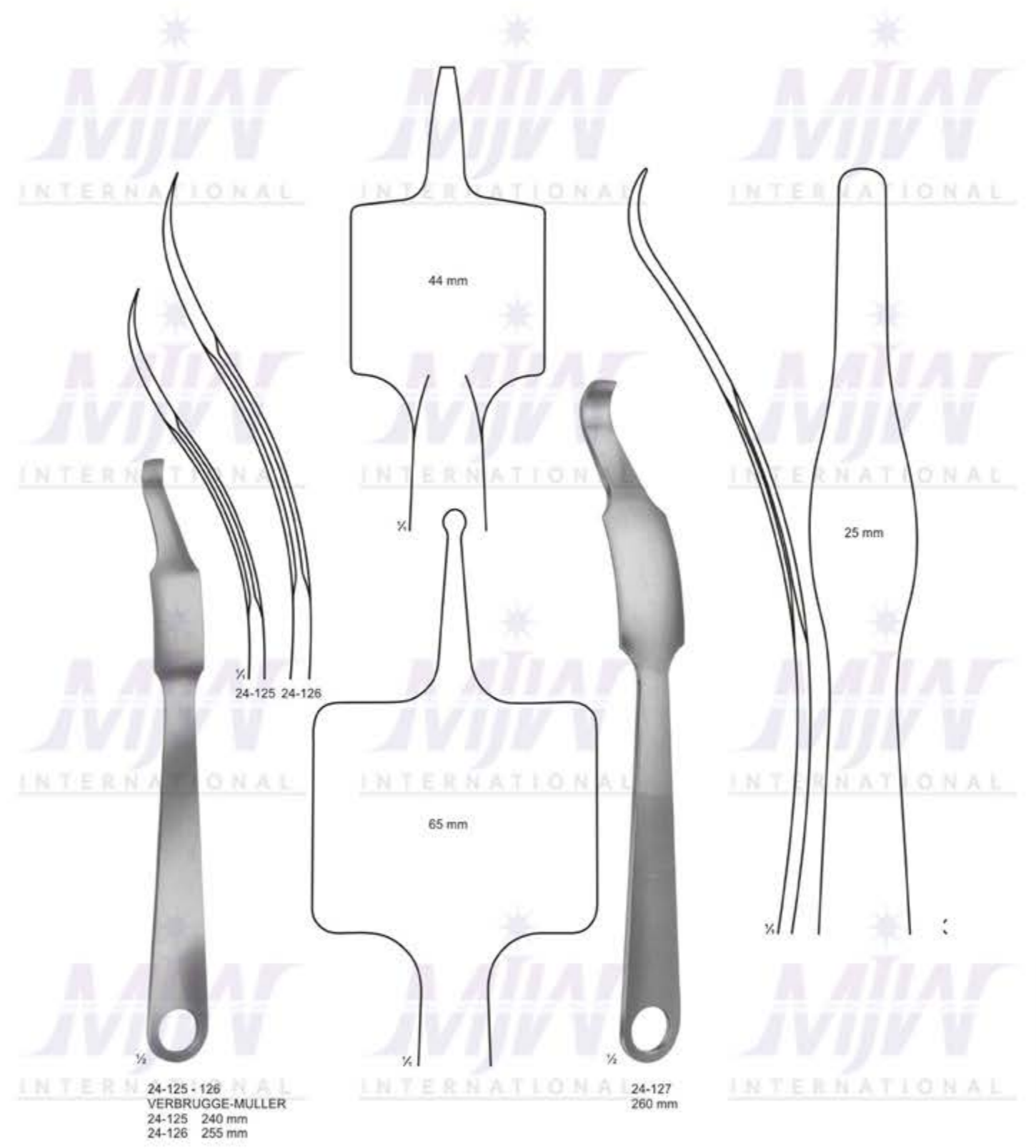
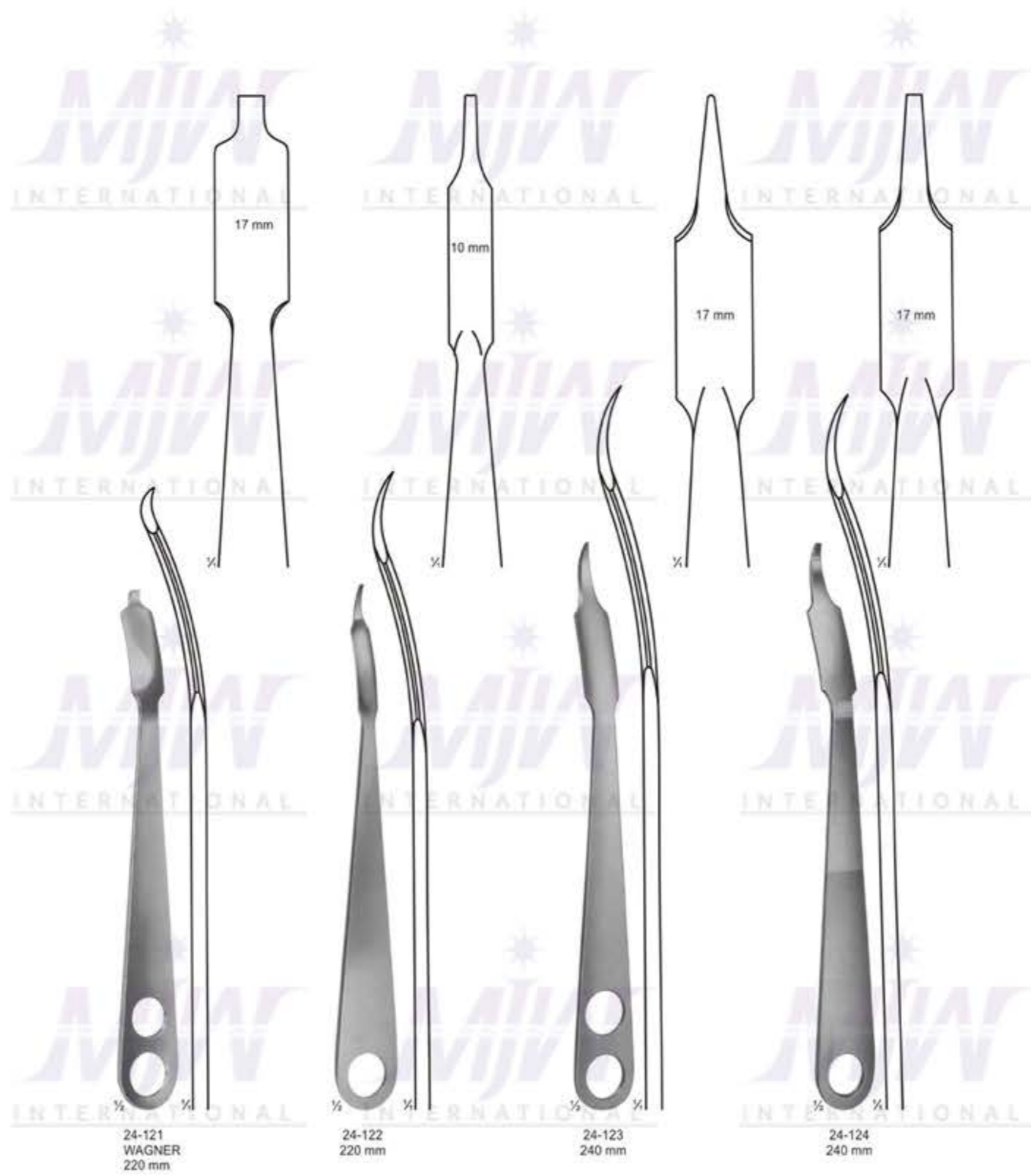

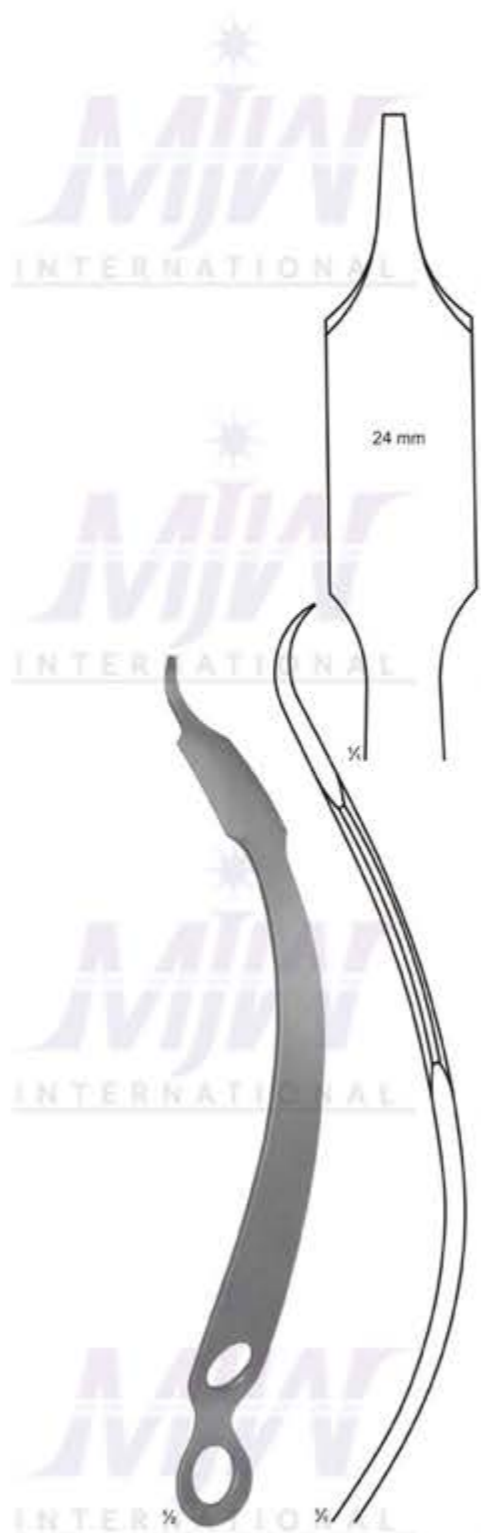

24-128
HOHMANN-ALDINGER
270 mm



24-129
SCHUMACHER mod. WAGNER
345 mm

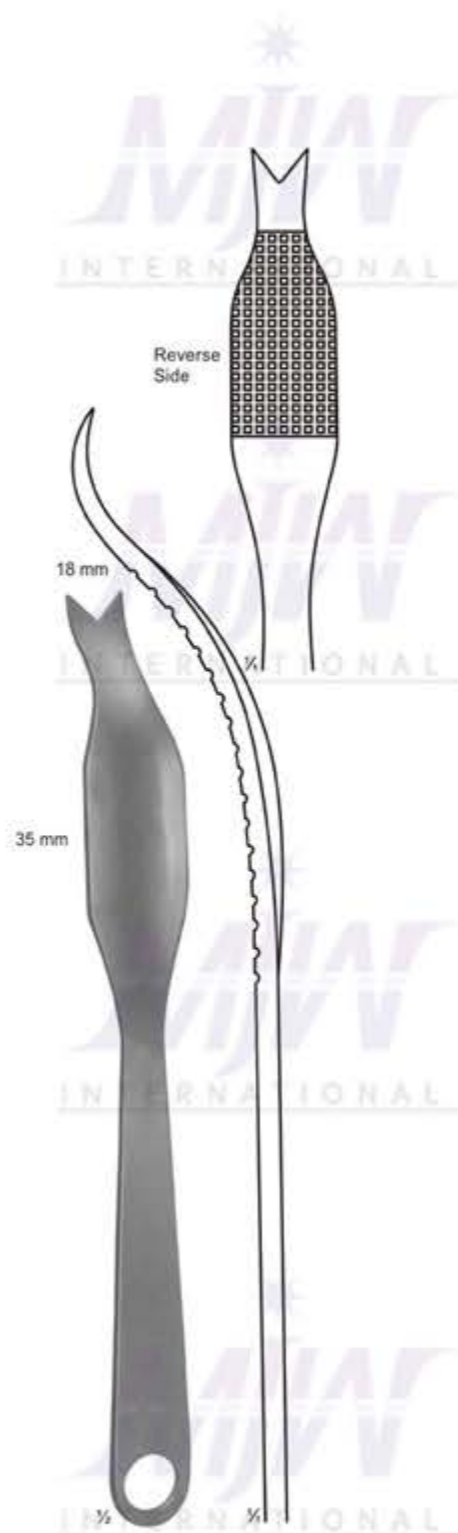

24-130
SCHUMACHER
290 mm



24-131
TAGER
Bone lever for
angle joint operations
175 mm



24-132
BENNETT
235 mm



24-133
MURPHY-LANE
Luxation lever
340 mm

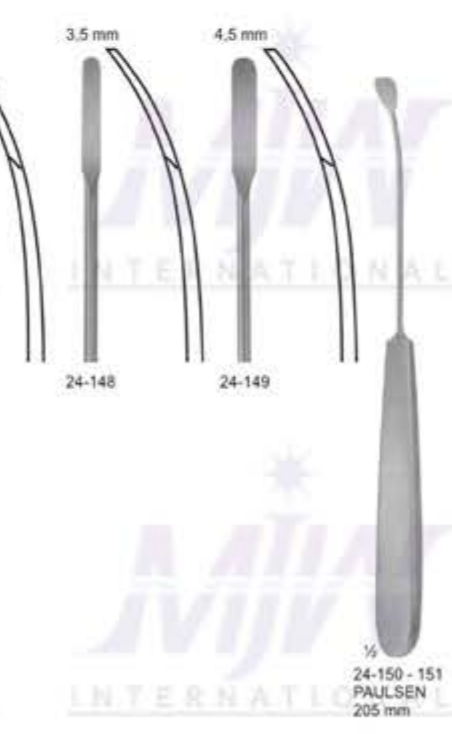
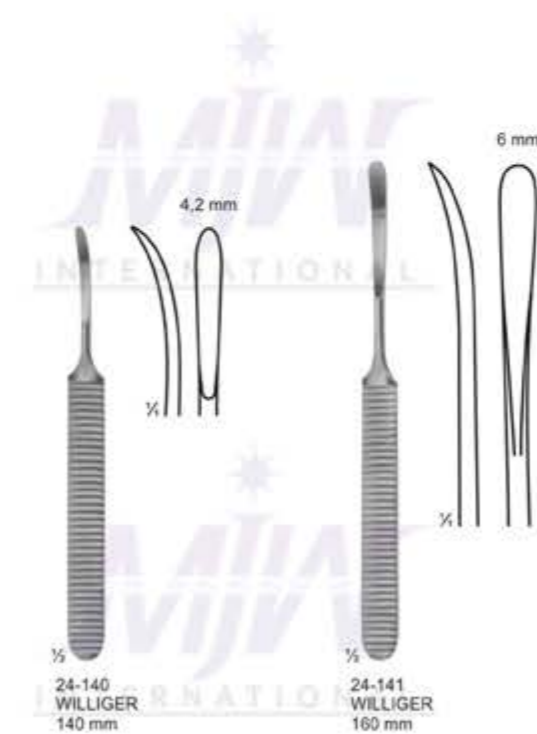
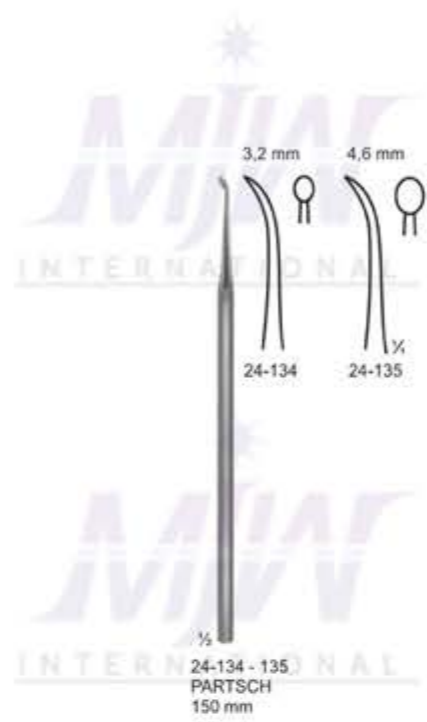

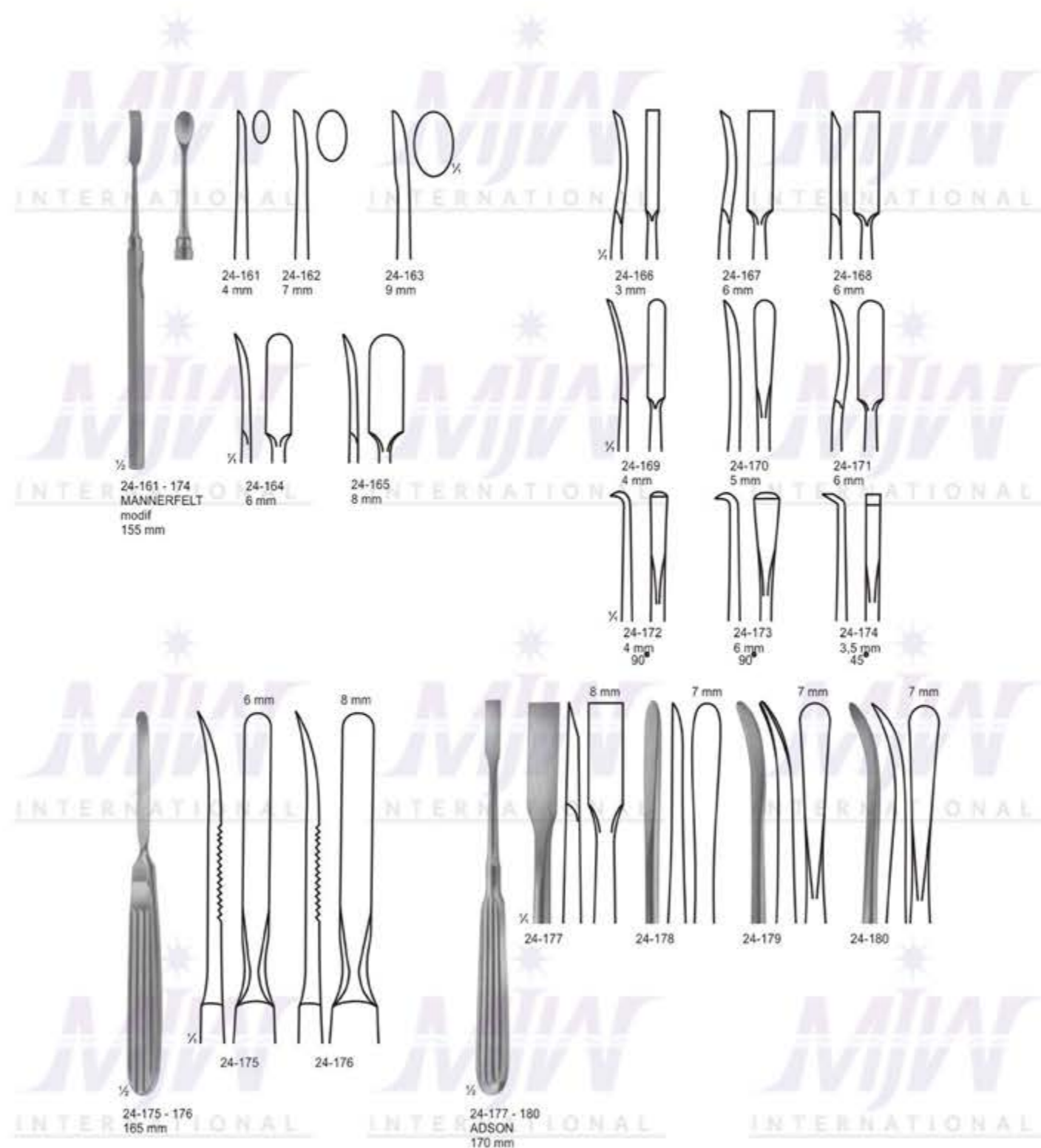
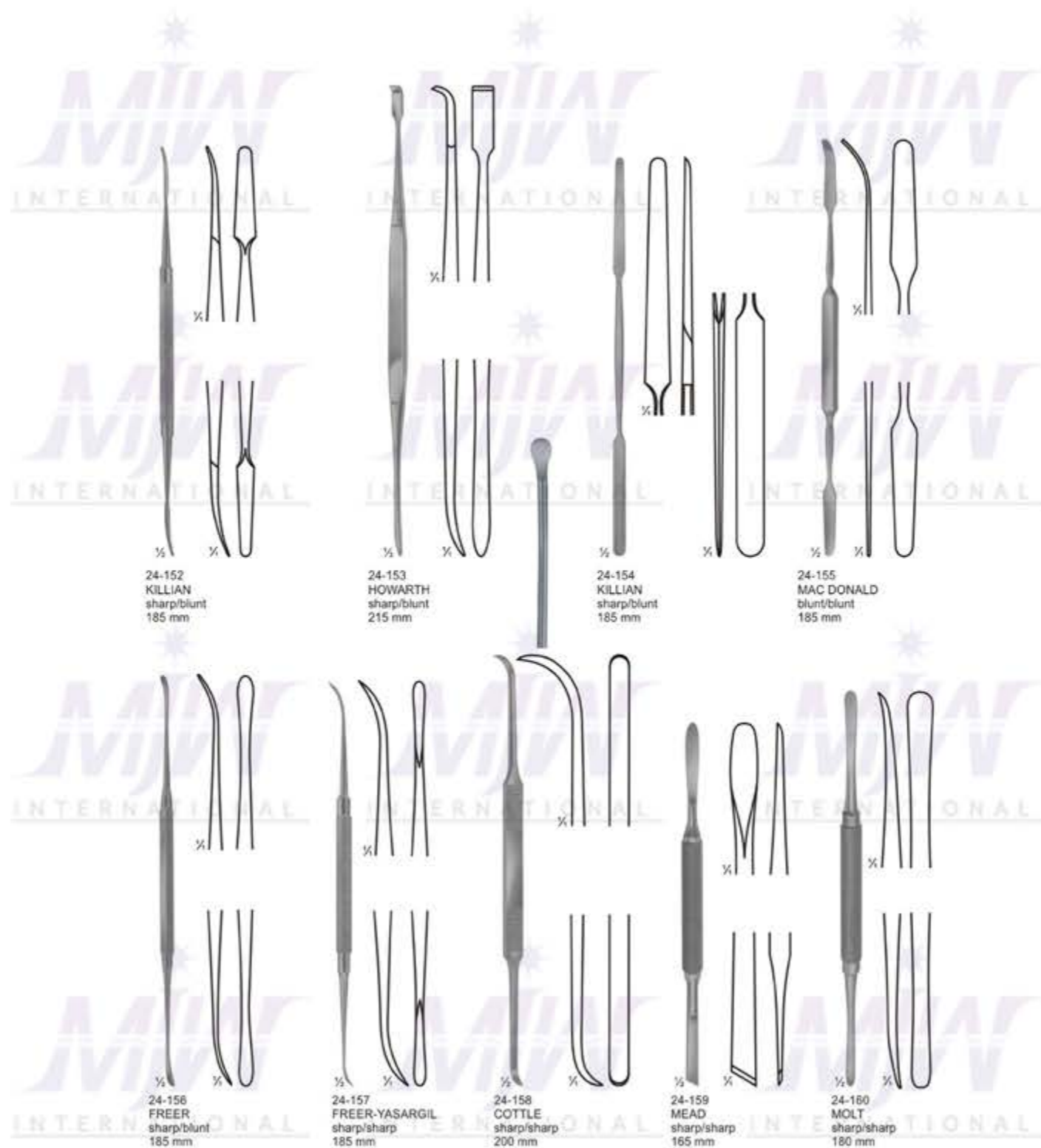



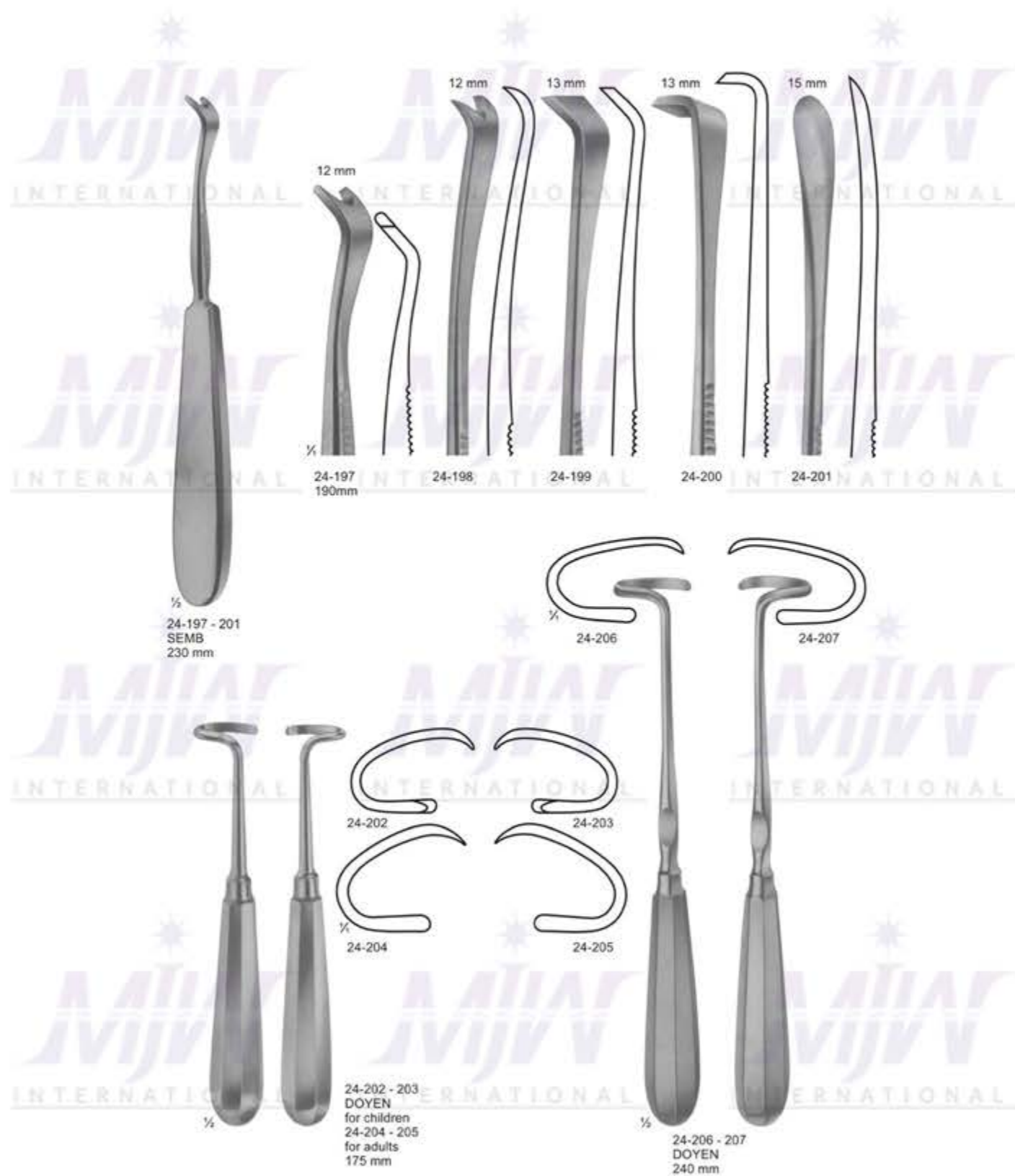



24-211
JOSEPH
fine, chequered

24-212
coarse, chequered
165 mm

24-213
LEWIS
Fine teeth
24-214
coarse teeth
175mm



24-215
MALTZ
down stroke
180 mm

24-216
AUFRICT
up stroke
24-217
down stroke
220 mm

24-218
GALLAHER
190 mm



24-219
FOMON
215mm

24-220
FOMON
215mm

24-221 - 223
MILLER
180 mm

4,3 mm
5 mm



24-224 - 228
DUROGRIP
205 mm

Teeth
24-224 12/14
24-225 16/20
24-226 24/30
24-227 36/44
24-228 52/62



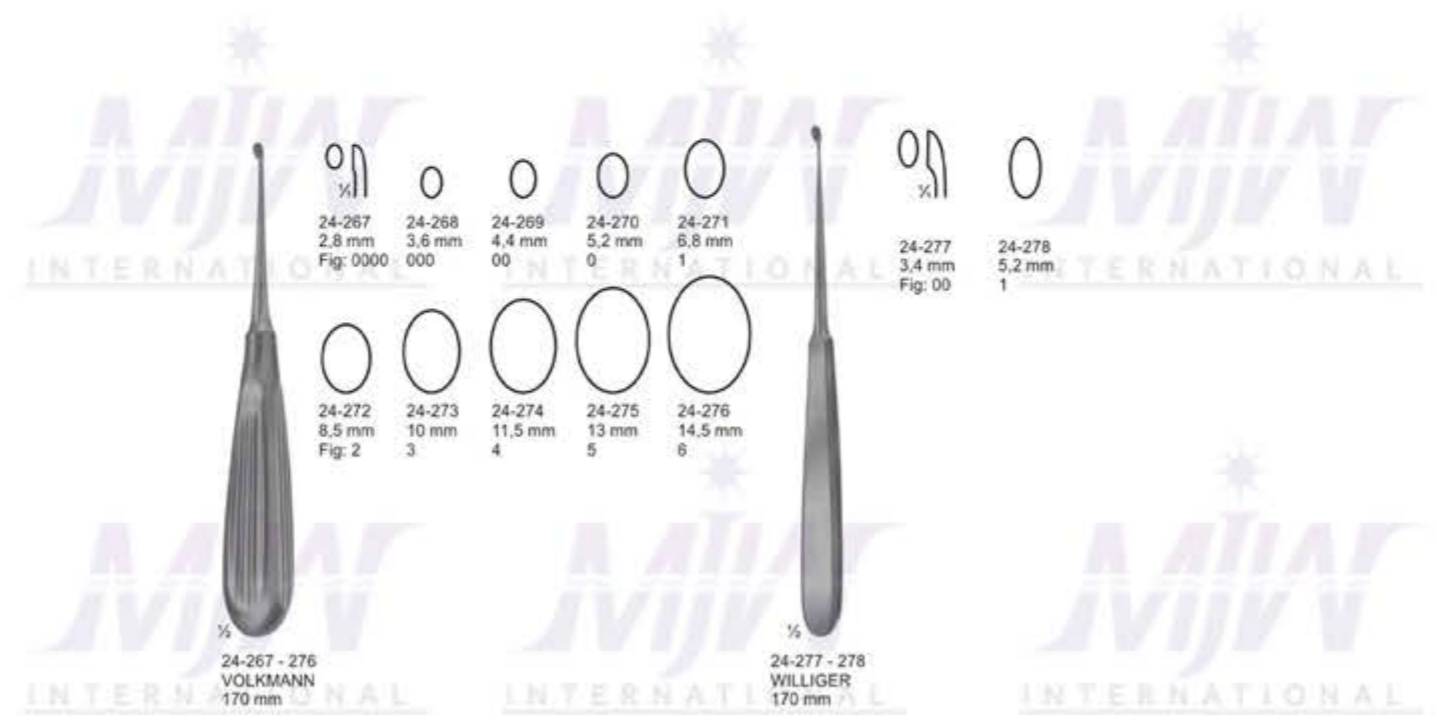

24-279 1,8 mm
24-280 2,0 mm
24-281 2,4 mm
24-282 2,6 mm
24-283 2,8 mm

malleable
24-284 4,4 mm Fig: 00
24-285 5,2 mm Fig: 0
24-286 6,8 mm Fig: 1

24-287 2,8 mm Fig: 0000
24-288 3,6 mm Fig: 000
24-289 4,4 mm Fig: 00
24-290 5,2 mm Fig: 0

24-279 - 283 LEMPERT 215 mm
24-284 - 286 HALLE 215 mm
24-287 - 290 DAUBENSPECK 200 mm

24-291 3,6 mm Fig: 000
24-292 4,4 mm Fig: 00
24-293 5,2 mm Fig: 0
24-294 6,8 mm Fig: 1

24-295 3,6 mm Fig: 000
24-296 4,4 mm Fig: 00
24-297 5,2 mm Fig: 0
24-298 6,8 mm Fig: 1

24-299 3 mm
24-300 4 mm
24-301 5 mm

24-291 - 294 250 mm
24-295 - 298 250 mm
24-299 - 301 BUSHE 250 mm

6 mm

24-302 TESSIER 220 mm

24-303 3,6 mm Fig: 000
24-304 4,4 mm Fig: 00
24-305 5,2 mm Fig: 0

24-306 6,8 mm Fig: 1
24-307 8,5 mm Fig: 2
24-308 10 mm Fig: 3
24-309 11,5 mm Fig: 4
24-310 13 mm Fig: 5
24-311 14,5 mm Fig: 6

24-303 - 305 SIMON 235 mm
24-306 - 311 SIMON 240 mm

24-312 3,6 mm Fig: 000
24-313 4,4 mm Fig: 00
24-314 5,2 mm Fig: 0

24-315 3,6 mm Fig: 000
24-316 4,4 mm Fig: 00
24-317 5,2 mm Fig: 0

24-318 4 mm
24-319 5 mm
24-320 6 mm

24-312 - 314 CASPAR 220 mm
24-315 - 317 CASPAR 220 mm
24-318 - 320 CASPAR toothed 220 mm

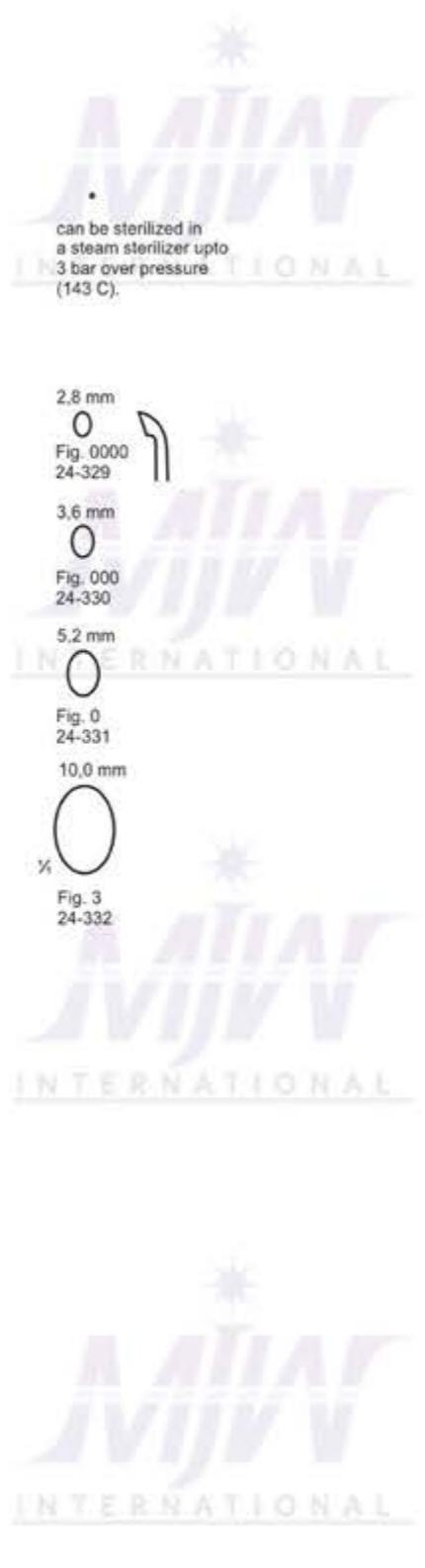
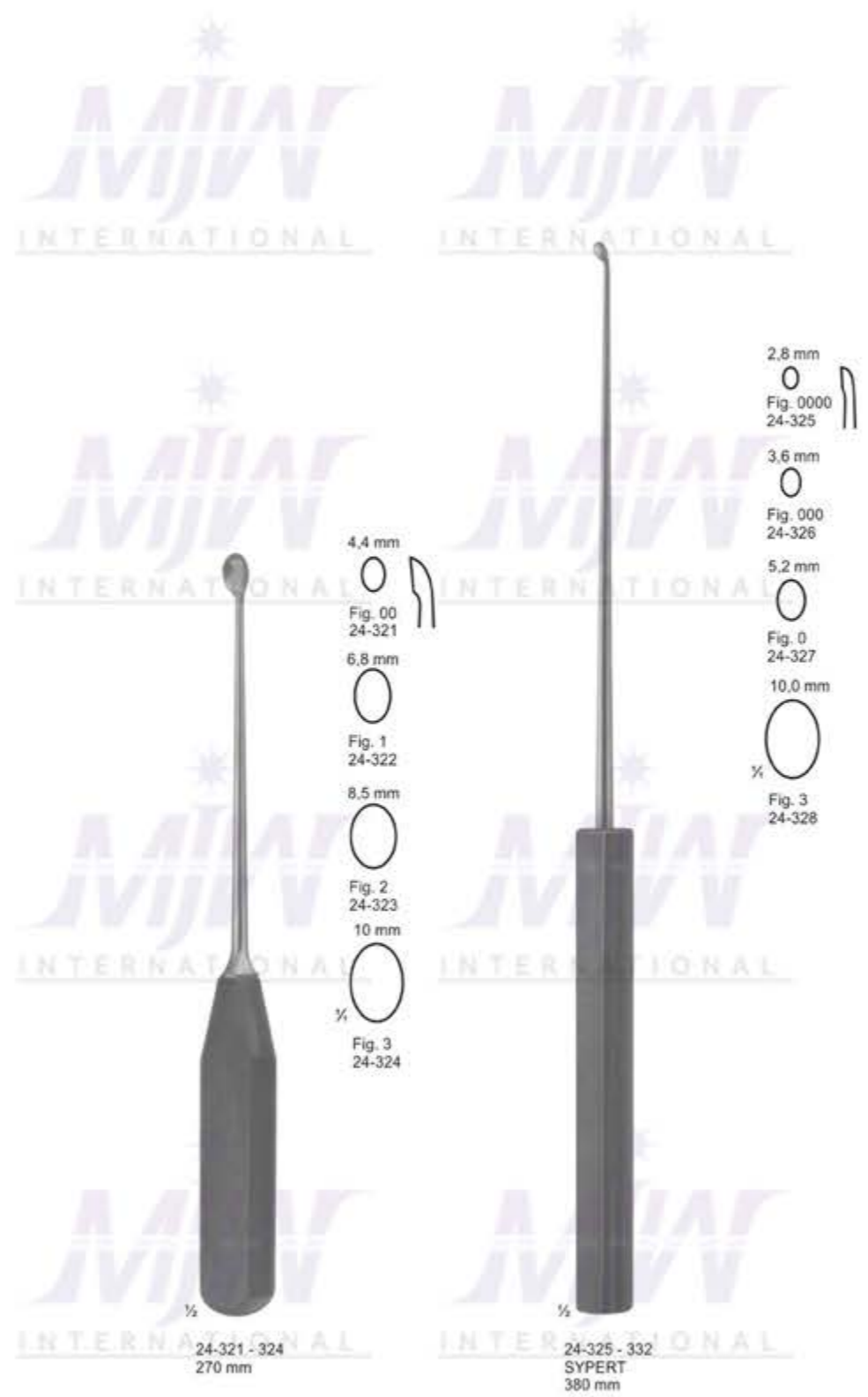





ALEXANDER
25-173 - 176
Gouges
170 mm

25-173 5 mm
25-174 7 mm
25-175 9 mm
25-176 11 mm

LAMBOTTE
25-177 - 182
Osteotomes
125 mm

25-177 4 mm
25-178 6 mm
25-179 8 mm
25-180 10 mm
25-181 12 mm
25-182 15 mm

COTTLE
25-183 - 187
Osteotomes with depth markings
180 mm

25-183 4 mm
25-184 6 mm
25-185 8 mm
25-186 10 mm
25-187 12 mm

COTTLE
25-188 - 191
Chisel-Osteotomes with depth markings
180 mm

25-188 4 mm
25-189 7 mm
25-190 9 mm
25-191 12 mm

COTTLE
25-192 8mm
Fish-tail Chisel, with protected ends
180 mm

STILLE
25-193 - 197
Chisels
205 mm

25-193 10 mm
25-194 12 mm
25-195 15 mm
25-196 20 mm
25-197 25 mm

STILLE
25-198 - 202
Gouges
205 mm

25-198 10 mm
25-199 12 mm
25-200 15 mm
25-201 20 mm
25-202 25 mm

WALTER
25-203 - 204
gouges for taking grafts from the ribs
205 mm

25-203 10 mm
25-204 15 mm

STILLE
25-205 - 210
Osteotomes
205 mm

25-205 8mm
25-206 10 mm
25-207 12 mm
25-208 15 mm
25-209 20 mm
25-210 25 mm

STILLE
25-211 - 215
Osteotomes
205 mm

25-211 10 mm
25-212 12 mm
25-213 15 mm
25-214 20 mm
25-215 25 mm

STILLE
25-216 - 220
Osteotomes, curved
205 mm

25-216 10 mm
25-217 12 mm
25-218 15 mm
25-219 20 mm
25-220 25 mm

LAMBOTTE
25-221 - 232
Osteotomes
245 mm

25-221 4 mm
25-222 8 mm
25-223 10 mm
25-224 13 mm
25-225 15 mm
25-226 18 mm
25-227 20 mm
25-228 25 mm
25-229 30 mm
25-230 38 mm
25-231 44 mm
25-232 50 mm

LAMBOTTE
25-233 - 238
Osteotomes, curved
245 mm

25-233 8 mm
25-234 13 mm
25-235 18 mm
25-236 25 mm
25-237 30 mm
25-238 38 mm





26-101
Reposition forceps,
for small fragments
135 mm



26-102
HAASE
Reposition forceps,
for mandibular
fractures
165 mm



26-103
REILL
Reposition forceps,
170 mm



26-106
Patella forceps
185 mm



26-107
Forceps with
ratchet fixation
140 mm



26-104
Reposition forceps
205 mm



26-105
MEYER
Reposition forceps
for fingers, with drill
guide for KIRSCHNER
wires up to diam. 1.0 mm
170 mm



26-108
Forceps with
thread fixation
170 mm



26-109
Forceps with
thread fixation
235 mm



26-110
DINGMANN modif
185 mm



26-111
Sequestrum
forceps
200 mm



26-112
VAN BUREN
Sequestrum
forceps
225 mm

Laterally
curved



26-113
LANGENBECK
205 mm

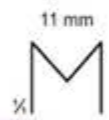

26-114
FERGUSSON
205 mm

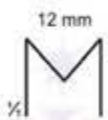

26-115
SEMB
190 mm

8 mm



FARABEU
26-116 19 cm
26-116A 23 cm
26-116B 26 cm
Adjustable



26-117
FARABEU
255 mm

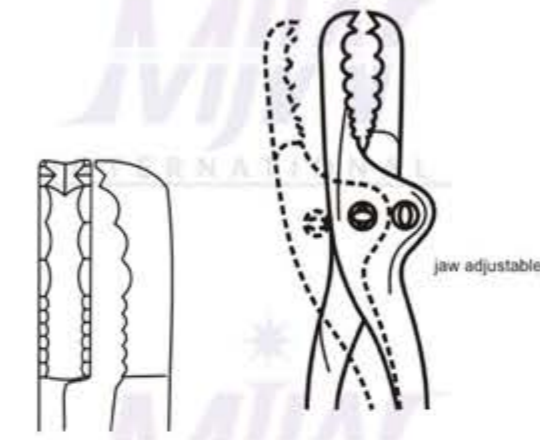

jaw adjustable



FARABEU-LAMBOTTE
26-118 19 cm
26-118A 23 cm
26-118B 26 cm
Adjustable



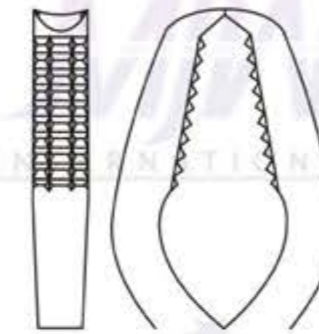
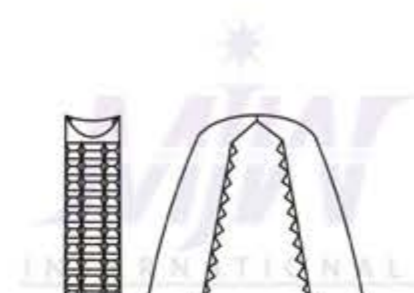

26-119
KERN-LANE
240 mm

26-120
LANE
330 mm

26-121
KERN-LANE
240 mm

LANE
26-122
30 cm
26-122A
32.5 cm
Bone holding forceps
Standard model, without ratchet
26-122B
32.5 cm
Standard model, with ratchet
26-122C
42.5 cm
With ratchet

HEY GROVES
26-123
42.5 cm
With ratchet
21 cm
26-123A
25 cm
26-123B
30.5 cm

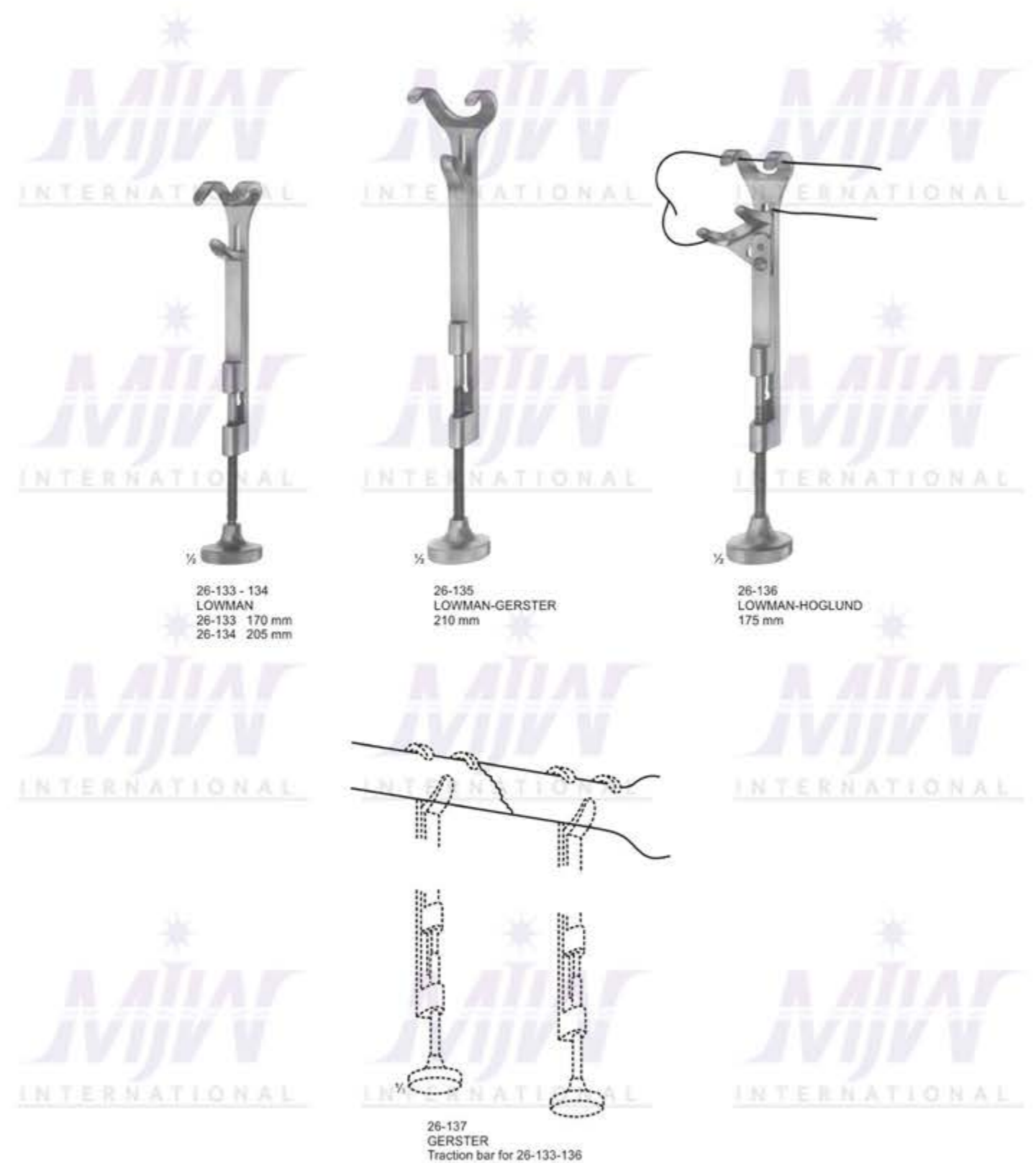
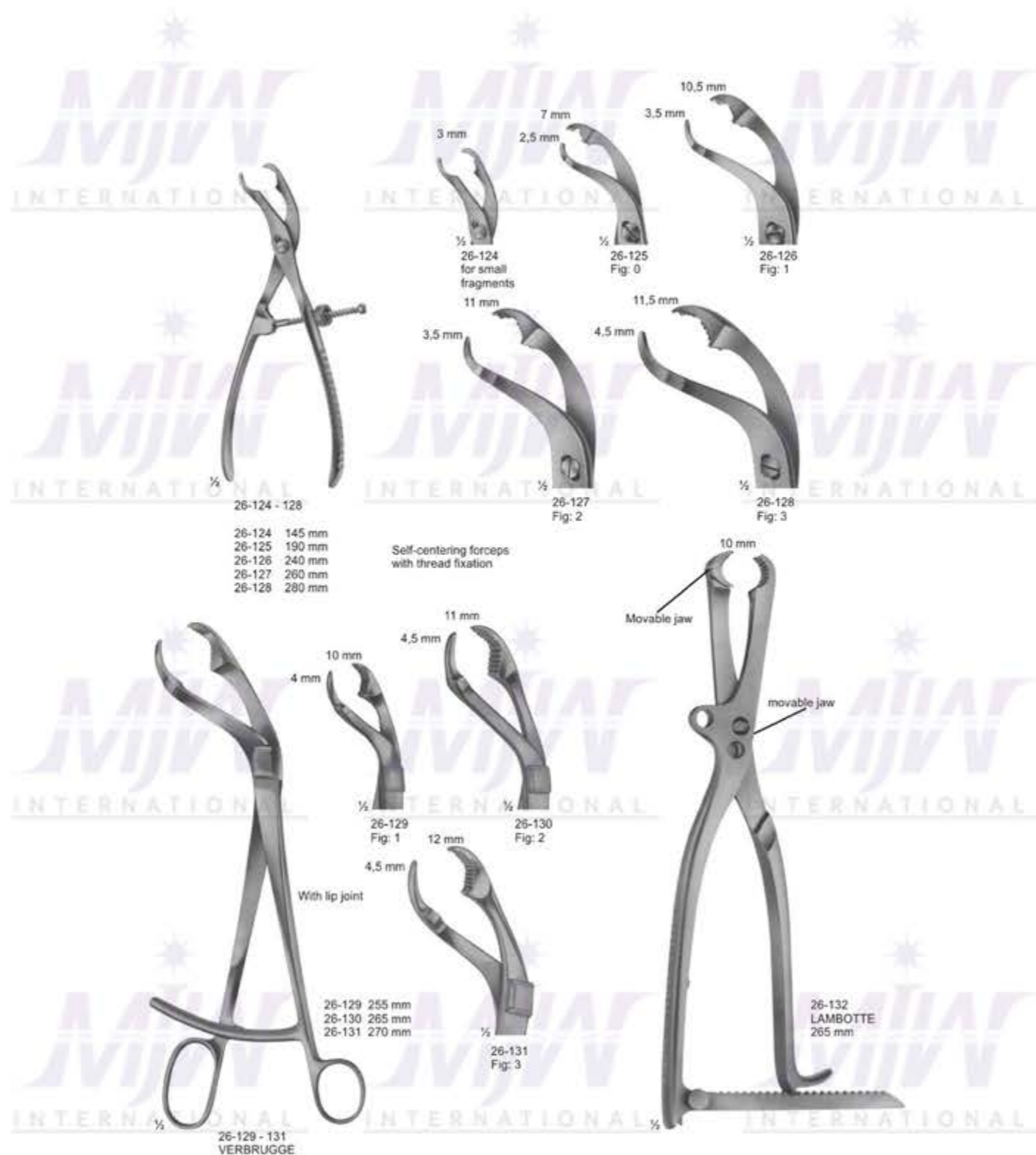



26-138 - 139
Synovectomy rongeur
width of jaws 1.2 mm
130 mm



26-140 - 141
Synovectomy rongeur
width of jaws 2.0 mm
130 mm



26-142
STELLBRINK
Synovectomy rongeur
175 mm



26-146
LUER
150 mm



26-147
LUER
155 mm



26-148
BLUMENTHAL
155 mm



26-143
STELLBRINK
Synovectomy rongeur
170 mm



26-144
LUER-FRIEDMANN
145 mm



26-145
140 mm



26-149
BLUMENTHAL
150 mm



26-150 - 151
JANSEN
175 mm



26-152
BANE-HARTMANN
175 mm



26-153
ALEXANDER
140 mm



26-154
JANSEN
190 mm



26-155 - 156
LEMPERT
200 mm



26-160 - 161
LUER
175 mm



26-162
LUER
180 mm



26-163
LUER
180 mm



26-157
BEYER
180 mm



26-158
MEAD
165 mm



26-159
MEAD
165 mm



26-164
OLIVECRONA
205 mm



26-165 - 166
BOHLER
155 mm



26-167
MARQUARDT
200 mm



26-168
RUSKIN
190 mm

26-169
ROETTGEN-RUSKIN
240 mm

26-170 - 171
ECHLIN
230 mm

26-172
STILLE
235 mm

26-173
LEKSELL-STILLE
240mm

26-174
STILLE-RUSKIN
240mm





26-175
LUER-STILLE
225 mm



26-176
LUER-STILLE
225 mm



26-177
LUER-STILLE
270 mm



26-178
SEMB
240 mm

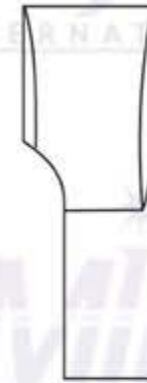

26-178A



26-178B



SAUERBRUCH
30 cm



SYPERT
36 cm



26-178C
3 mm



26-178D
5 mm



26-178E
6 mm



26-178F
8 mm



26-178G
3 mm



26-178H
5 mm



26-178J
6 mm



26-178K
8 mm



DALE

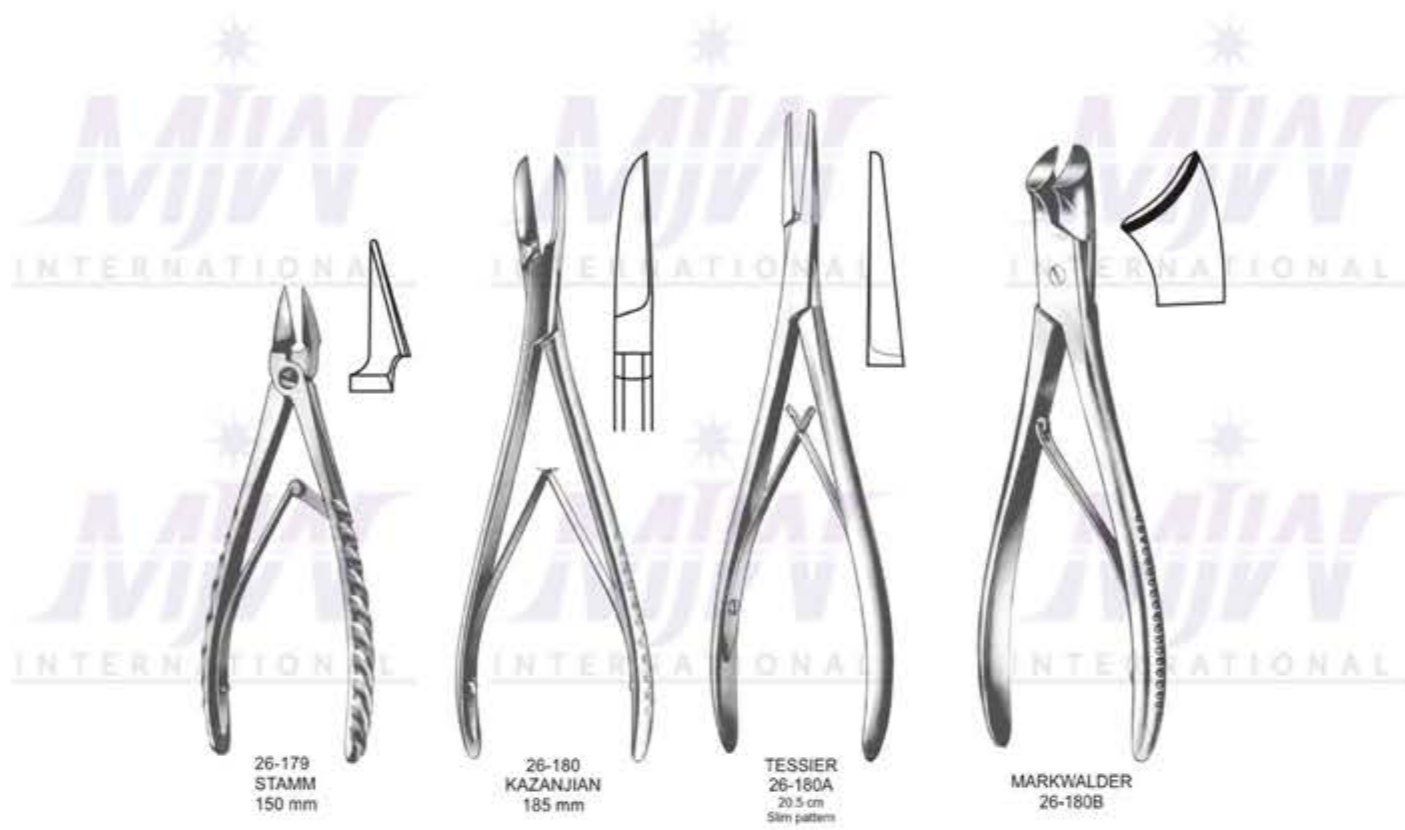







26-211
CANAD. MODELL
200 mm



27-101 - 107
KIRSCHNER
Wire traction bows,
to be used with
KIRSCHNER-wires
up to 2.5 mm diam.,
With 3 hooks,
stainless steel



27-108
Wrench, double - ended,
for wire traction bows 27-101 - 27-115



27-109
Wire tightener, with
clamping jaws



27-110
Traction hook only,
large size



27-111
Traction hook only,
small size



Kuentcher
26 cm
27-111A 8 mm
27-111B 10 mm
27-111C 12.5 mm

Kuentcher
27-111D
35 cm



27-112
Fixation clamp, to secure clamping
jaws of 27-109 stainless steel



27-113 Wire traction bow, adjustable, with 3 hooks, small size



27-114 Wire traction bow, adjustable, with 3 hooks, large size

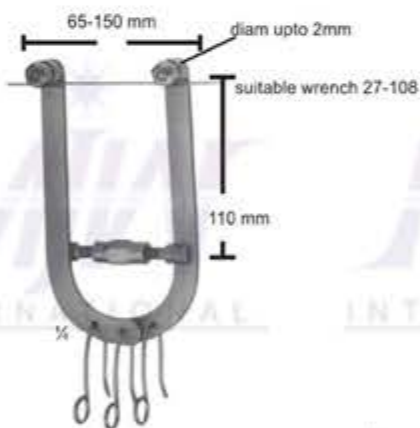

27-115 Wire traction bow, adjustable, with 3 hooks, small size for elbow and calcaneus, for adolescents



27-116 max. 105 mm
27-117 max. 160 mm
27-118 max. 200 mm

27-116 80-95 mm
27-117 90-120 mm
27-118 140-170 mm

diam upto
27-116 1.6 mm
27-117 2.0 mm
27-118 2.5 mm

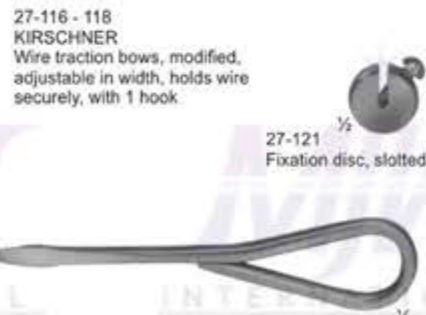

27-116 - 118 KIRSCHNER Wire traction bows, modified, adjustable in width, holds wire securely, with 1 hook



27-119 Fixation disc, slotted



27-120 idem, aluminum, transparent to X-rays



27-121 Fixation disc, slotted



27-122 Screw driver, for above fixations discs



Boehler traction bows, to be used with STEINMANN pins, 4mm diam	Boehler traction bows, to be used with STEINMANN pins, 5mm diam	Inside width	For
27-123 with pin (27-135)	27-129 without pin	16x9cm	Arm
27-124 without pin	27-129 without pin		
27-125 with pin (27-137)		21x11cm	Femur and knee
27-126 without pin	27-130 without pin		
27-127 with pin (27-139)		21x15cm	Femur and knee
27-128 without pin			



27-146 SCHWARZ Traction bow for fingers, to be used with KIRSCHNER-wire up to 1.6 mm diam.



27-147 Small distractor as a repositioning device for distraction and compression of small bones, for wires with 3.0 mm diam.



27-131 - 145 STEINMANN triangular shaft ended and trocar point

diam #	4,0 mm	5,0 mm
Length		
80 mm	27-131	
100 mm	27-132	
120 mm	27-133	
140 mm	27-134	
150 mm	27-135	27-141
160 mm	27-136	
180 mm	27-137	27-142
200 mm	27-138	27-143
210 mm	27-139	
250 mm	27-140	27-144
300 mm		27-145



27-148 Protection cap for 4,0 mm STEINMANN Pins



27-149 Protection cap for 5,0 mm STEINMANN Pins

27-150
REILL
Drilling chuck, cannulated, for shanks from 2.0 - 2.5 mm diam 115 mm

27-151
Drilling chuck, cannulated, for shanks from 0.8 - 2.0 mm diam 150 mm

27-152
Drilling chuck, cannulated, for shanks up to 4.5 mm diam with key (27-156) 140 mm

27-153
LOUTE
Wire tightener, improved pattern, with movable tip, for wires up to 1.0 mm diam. 220 mm

Movable tip made of (material used for implants). While twisting the movable head remains stable, therefore the wire will not slip off.

Chuck jaws made of material used for implants

27-154
Drilling chuck, cannulated, for shanks up to 6.35 mm diam., To be tightened by hand 100 mm

27-155
Drilling chuck, cannulated, for shanks up to 4.5 mm diam., And for triangular shaft width across flats 4.7 mm (schanz screws, steinmann pins), with key (27-156)

27-157
Drilling chuck, cannulated, for shanks up to 6.35 mm diam., With key (27-158) 160 mm

27-159
275 mm
Fig. 3

27-160
275 mm
Fig. 2

27-161
275 mm
Fig. 1

27-159 - 161
DEMEL
Wire guides

27-162
240 mm

27-163
270 mm

27-164
225 mm

GRAFT PASSER
27-164A
XL-Large
Curved
Slot cut into head

27-164B
X-Small

27-164C
Small

27-164D
Large

27-164E
X-Large

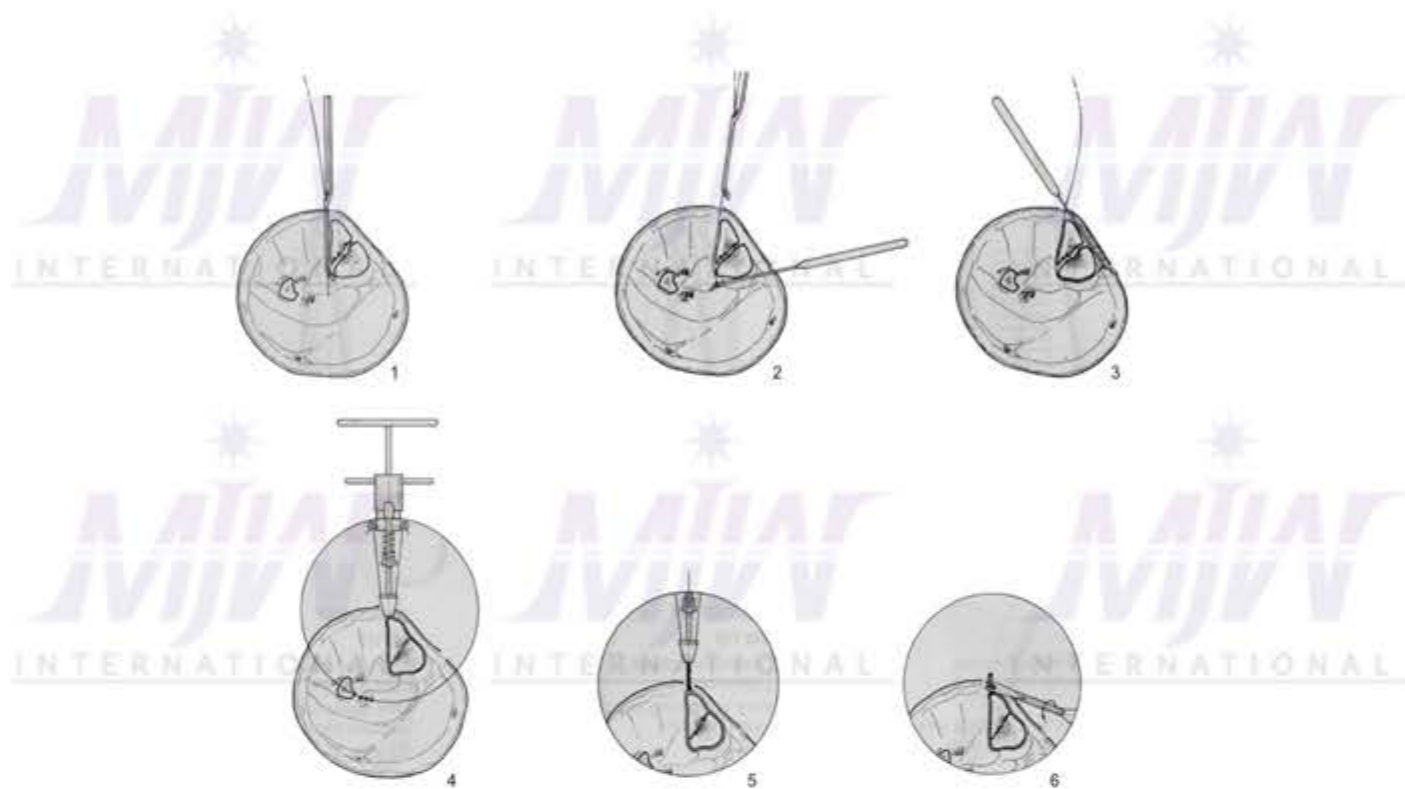



27-177 130 mm
27-178 180 mm

27-177 - 178
Extraction pliers
for boring wires



FLAT-NOSED PLIERS
PARALLEL
27-179 13 cm
27-179A 17 cm

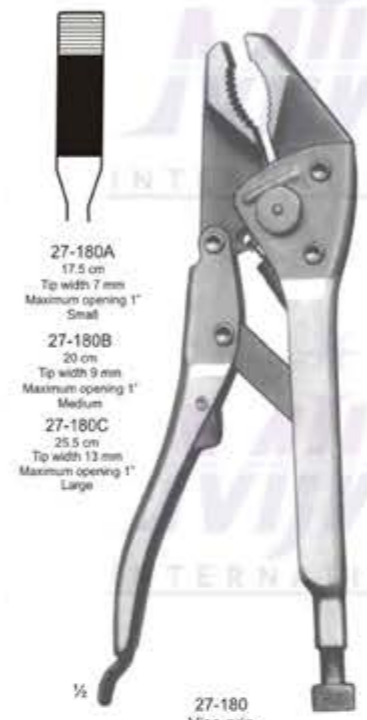

27-180A 17.5 cm
Tip width 7 mm
Maximum opening 1" Small
27-180B 20 cm
Tip width 9 mm
Maximum opening 1" Medium
27-180C 25.5 cm
Tip width 13 mm
Maximum opening 1" Large

27-180
Vise grip
200 mm



27-186 27-187
ANGLE DUROTIP 130 mm ANGLE
130 mm

for soft wire up to diam.	0,5 mm	0,6 mm
for hard wire up to diam.	0,3 mm	0,4 mm

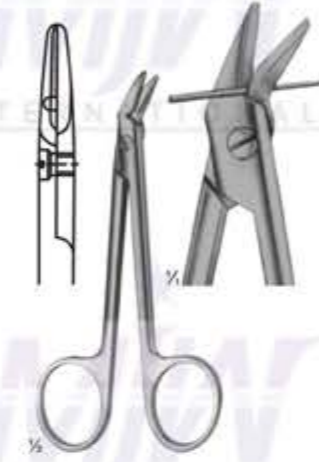

27-188 27-189
DUROTIP 120 mm DUROTIP
120 mm

for soft wire up to diam.	1,2 mm	1,2 mm
for hard wire up to diam.	0,8 mm	0,8 mm



27-190
HARVEY
125 mm

0,4 mm
0,3 mm



27-181 - 184
ROUND PLIERS
180mm



27-182 145 mm
27-183 180 mm
27-184 180 mm
Extraction pliers for wires



27-185
Bending pliers
for wires up to
1.8 mm diam.



27-191
150 mm

for soft wire up to diam.	1,5 mm
for hard wire up to diam.	1,0 mm



27-192
160 mm

1,5 mm
1,2 mm



27-193
140 mm
DUROTIP

1,5 mm
1,0 mm



27-194
180 mm

for soft wire
up to diam. 2.0 mm
For hard wire 1.5 mm
up to diam
specially hardened
cutting edges, front
and lateral cutting
action



27-195
REILL
175 mm

for soft wire
up to diam. 2.0 mm
For hard wire 1.6 mm
up to diam
specially hardened
cutting edges, for
cutting off wires close
to the bone



DUROTIP
27-196
235 mm

for soft wire
up to diam. 3.0 mm
For hard wire
up to diam 2.2 mm



27-197
240 mm

for soft wire
up to diam. 2.0 mm
For hard wire 1.6 mm
up to diam

specially
hardened
cutting
edges



27-198
145 mm

for soft wire
up to diam. 1.5 mm
For hard wire 1.0 mm
up to diam

Durotip



27-199
145 mm

for soft wire
up to diam. 2.0 mm
For hard wire 1.5 mm
up to diam

Durotip



27-200
220 mm

for soft wire
up to diam. 3.5 mm
For hard wire 2.5 mm
up to diam

Durotip



27-197A
16 cm



27-197B
16 cm

for soft wires up to 2.5 mm
for hard wires up to 2.0 mm



27-201
320 mm



for soft wire
up to diam. 3.0 mm
For hard wire
up to diam. 3.0 mm



27-202A
25 cm
For wires up to 3.0 mm
Head cutter



27-202B
38 cm
For wires up to 4.0 mm
Head cutter

DUROTIP

27-202
Cutter for cutting off
KIRSCHNER wires,
Tibia head screws,
bolts, pins, up to 6 mm diam.
470 mm



PENNER
27-203A
15.5 cm



27-203
RADOLF
135 mm

27-204
Nail extracting
forceps
145 mm



27-205
Finger nail drill
with 3 drill points

27-206 27-207 27-208
Drill points only

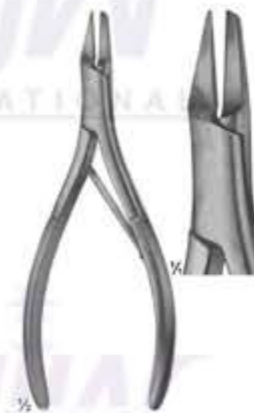

27-209
Nail splitting
forceps
135 mm



27-210
17 cm
Ring cutter

WALTON
27-210A
16 cm
27-210B
Spare blade for ring cutters



27-211
Finger ring saw
150 mm

	SECTION	PAGE
Plaster Instruments	28	393-397
Suction Instruments		398-404
Sterilizing Forceps	29	405

Plaster Knives



Plaster Saw



For small plaster dressings



28-122
160 mm



28-123 - 124
ESMARCH
28-123 200mm
28-124 230mm



28-125
BERGMANN
230 mm



BRUNS
28-126 Plain
23.5 cm
28-126A serrated
24 cm
Open shanks with pin

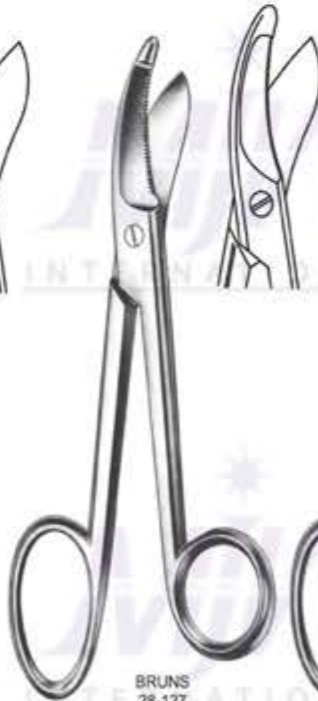

BRUNS
28-127
23.5 cm
Closed shanks, serrated



BRUNS
28-128
24 cm
Open shanks with pin, serrated



SEUTIN
28-128A
23 cm

Also To Be Used As
Bandage Scissors

Also To Be Used As
Bandage Scissors



TESSIER
28-129
19 cm
1 serrated cutting edge



TESSIER
28-129A
19.5 cm
1 serrated cutting edge



UNIVERSAL
28-130
20 cm



LORENZ
28-131
23 cm



EXCENTRIC
28-131A 16 cm
28-131B 19 cm



TORNADO
28-131C
24 cm
Undulated cutting edge

Bandage Scissors

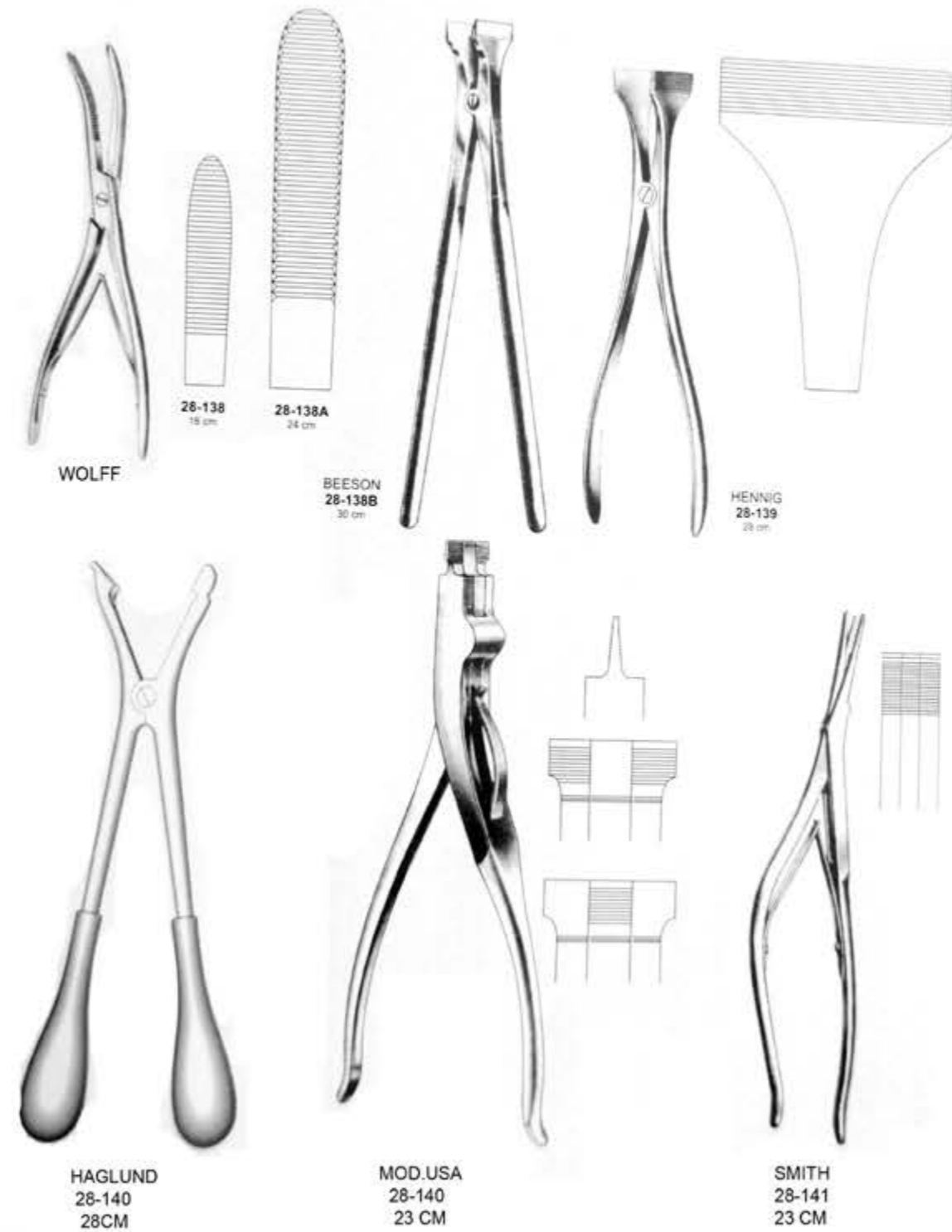
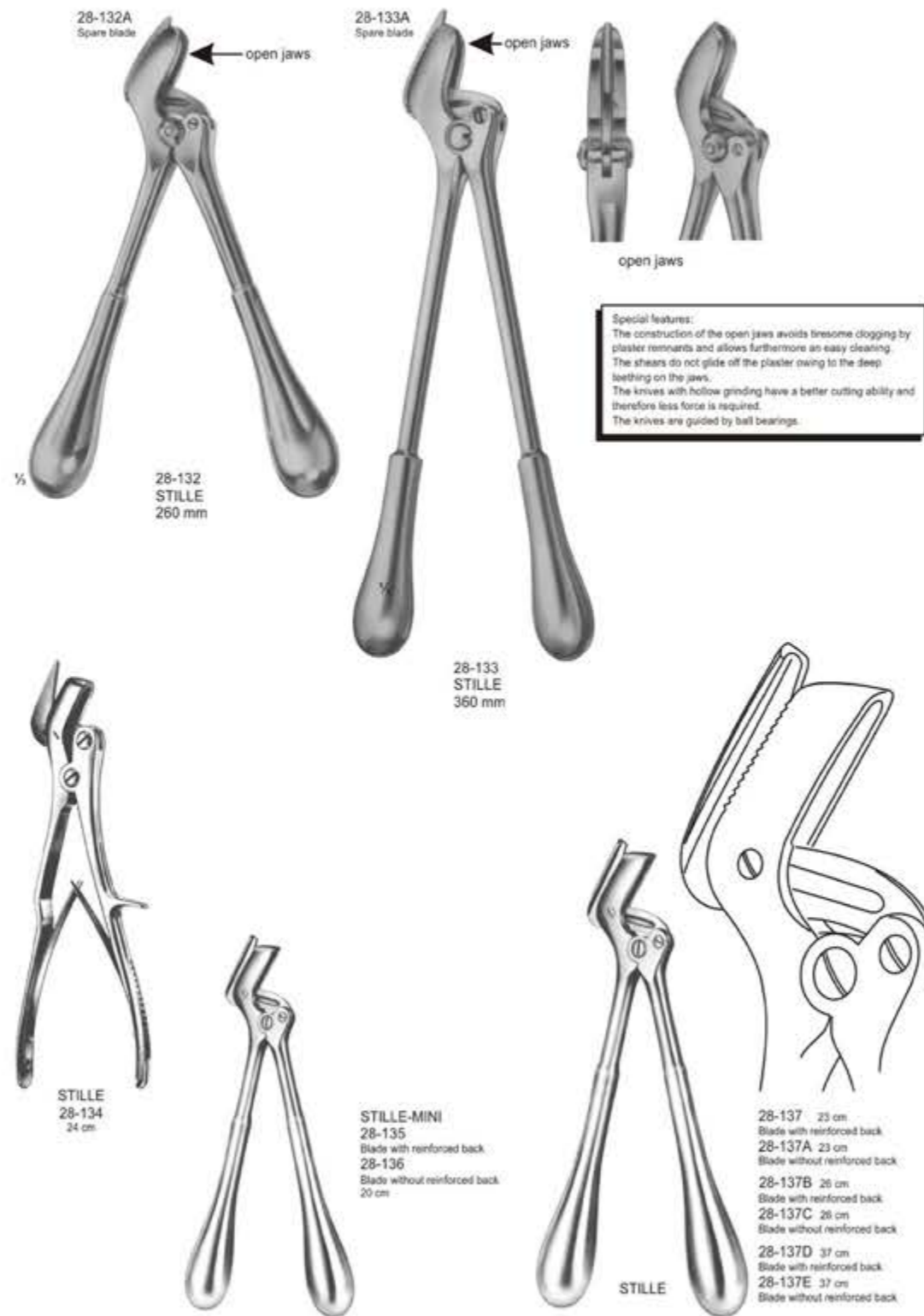

29-112
For aspirating fluid from the excretory ducts of large glands and for keeping the operating area clear 170 mm

29-113
Trocar
For puncturing
150 mm

29-102 5 mm
29-103 6 mm
29-103A 7 mm
29-103B 8 mm
29-103C 9 mm
29-103D 10 mm
29-103E 12 mm
29-103F 14 mm

	A	B	C
29-102	5 mm	1 mm	4.0 mm
29-103	6 mm	1 mm	5.0 mm
29-103A	7 mm	1 mm	5.5 mm
29-103B	8 mm	1 mm	6.0 mm
29-103C	9 mm	1 mm	6.5 mm
29-103D	10 mm	2 mm	7.5 mm
29-103E	12 mm	2 mm	10 mm
29-103F	14 mm	2 mm	11 mm

Uterine suction tube

29-101
13 cm
Uterine suction connector

Uterine suction tubes

29-104
29 cm
3 mm
Specimen & aspirating curette

29-105
29 cm
4.5 mm
Specimen & aspirating curette

Aspirating currettes 29 cm

29-106 6 mm

29-107 8 mm

29-108 10 mm

29-109 12 mm

29-110 14 mm

29-111
12 cm
Coupling piece

29-114
For clearing large quantities of fluid
190 mm

29-115 150mm
Suction handle, with vacuum regulator and finger cut-off, brass, mirror-finish chromium-plated

29-116 170mm
Suction handle, with hand regulation valve and quick-shutter, brass, mirror-finish chromium-plated

olive
Ø 9 mm

olive
Ø 9 mm

Both suction handles have bayonet fitting and can be used for the suction cannulae.

29-117
Trocar
For puncturing
170 mm

29-118
Hollow needle,
sharp
150 mm

29-119
double curved
For general surgery
230 mm

29-120
For tonsillectomy,
oral and laryngeal
operations
190 mm

29-121
For tonsillectomy,
oral and laryngeal
operations
220 mm

Ø 11 mm

Ø 7.5 mm

With bayonet fitting to be used with suction handles (29-115 - 29-116)

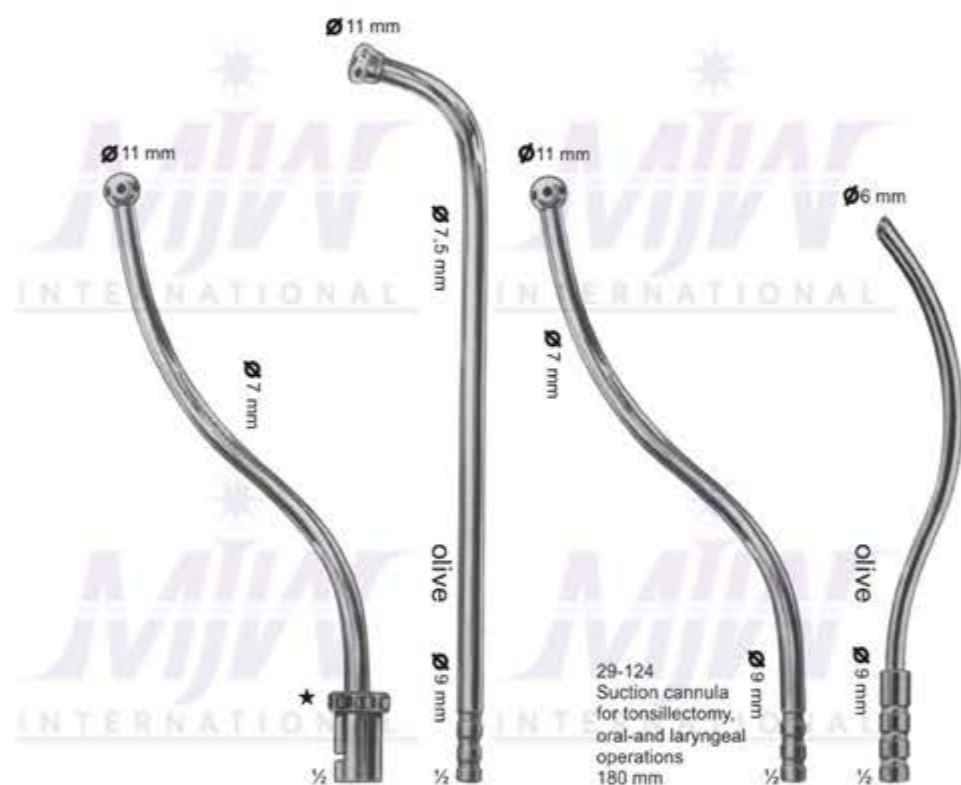

29-122
For tonsillectomy,
oral-and laryngeal
operations
180 mm

29-123
Suction cannula
for tonsillectomy,
oral-and laryngeal
operations
220 mm

29-124
Suction cannula
for tonsillectomy,
oral-and laryngeal
operations
180 mm

29-125
S-shaped blunt cannula
for aspirating fluid from
the excretory ducts of
large glands and for
keeping the operating
area clear
170 mm

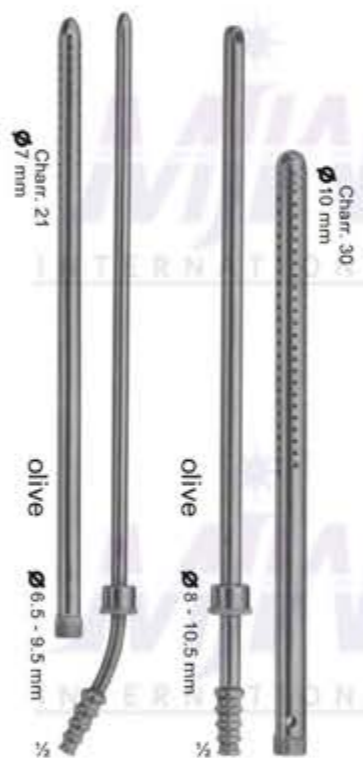

29-126
POOLE
Suction cannula,
with outer tube
to be screwed off
225 mm

29-127
POOLE
Suction cannula,
with outer tube
to be screwed off
225 mm



29-128
YANKAUER
with especially large
central bore, 4.8 mm
diam.
285 mm

29-129
YANKAUER
with central bore,
2,0 mm diam.
285 mm

29-130
DE-BAKEY
with central bore,
3,0 mm diam.with
lateral slots
275 mm

29-131
DE-BAKEY
with finger cut-off
and stylet
270 mm



29-132
DE-BAKEY
with finger cut-off
and stylet
160 mm

29-133
with finger
cut-off
190 mm



29-134 - 137
PLESTER
with finger cut-off and stylet, thumb piece parallel to curve, with LUER hub
195 mm

29-138 - 142
FERGUSSON
with finger cut-off and stylet, thumb piece 90° to curve, with LUER hub
180 mm

29-143 4,0 mm
FERGUSSON
insulated, with finger cut-off and stylet, thumb piece 90° to curve, with LUER hub
180 mm

29-144 3,0 mm
29-145 5,0 mm
FRAZIER
with finger cut-off and stylet, thumb piece 90° to curve, with LUER hub
180 mm

29-146 5,0 mm diam. Tip 6,5 mm wide, Nasal suction tube, with LUER hub
180 mm

29-147 4,5 mm
29-148 5,5 mm
Nasal suction tubes
175 mm

29-149
GORNEY
Suction dissector
180 mm

29-150 4 mm wide
29-151 5 mm wide
Suction raspatories, sharp, bayonet-shaped, with stylet
200 mm

29-152
LOPEZ-REINKE
Tonsil dissector with suction device
235 mm

29-153
WULLSTEIN
Suction tube, conical, silver, olive with LUER hub
160 mm

29-154 1,5 mm-29-155 2,0 mm
WULLSTEIN
Suction tube, cylindrical, silver, with stylet olive with LUER hub
160 mm

YASARGIL usable length diam.		YASARGIL usable length diam.	
29-156 130 mm	1,5 mm	29-164 130 mm	2,5 mm
29-157 150 mm	1,5 mm	29-165 150 mm	2,5 mm
29-158 180 mm	1,5 mm	29-166 180 mm	2,5 mm
29-159 220 mm	1,5 mm	29-167 220 mm	2,5 mm
29-160 130 mm	2,0 mm	29-168 130 mm	3,5 mm
29-161 150 mm	2,0 mm	29-169 150 mm	3,5 mm
29-162 180 mm	2,0 mm	29-170 180 mm	3,5 mm
29-163 220 mm	2,0 mm	29-171 220 mm	3,5 mm
		29-172 180 mm	4,5 mm

29-173 - 175
LANDOLT
150 MM
diam Ø 3 mm

29-173 8 mm / curved
29-174 11mm / curved
29-175 15mm / curved

29-176 500 mm-29-177 350 mm
with rubber tip, with LUER hub

29-178 2,0 mm diam
with finger cut-off, thumb piece 90° to curve, with LUER hub
250 mm

29-179 2,5 mm diam
29-180 3,0 mm diam

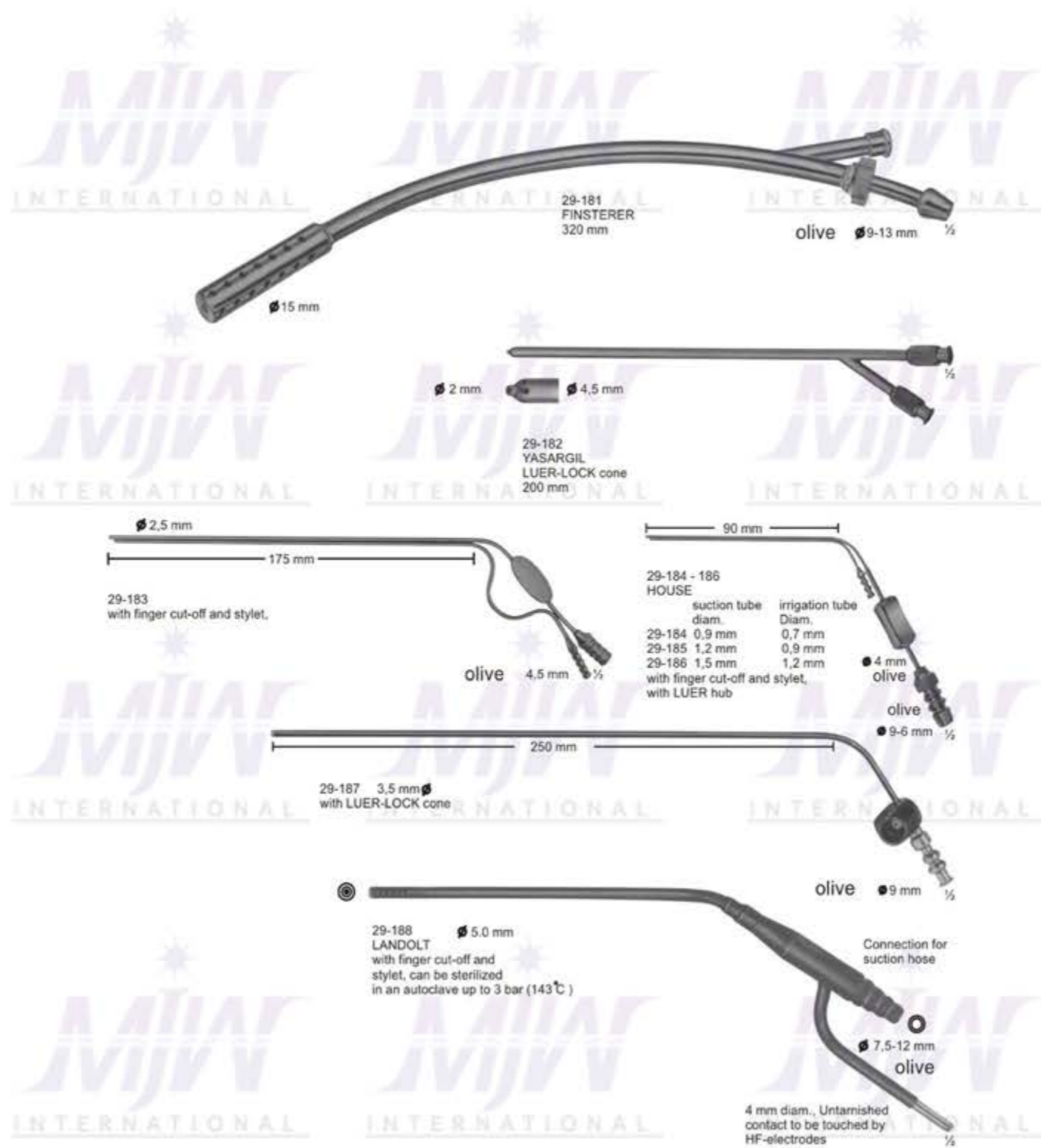

TUNGESTEN CARBIDE INSTRUMENTS
FOR THOSE.....
WHO DEMAND SECURITY & ACCURACY.



29-210
GENERAL BIOLOGY DISSECTING SET
SINGLE LEATHER CASE.



29-211
BASIC DISSECTING SETS
VINYLE POUCH.



29-212
ANATOMY DISSECTING SET
DOUBLE FOLDING LEATHER CASE.



29-213
LARGE ANIMAL SET
DOUBLE FOLDING
LEATHER CASE.



29-214
MICRO DISSECTING SET
DOUBLE FOLDING
LEATHER CASE.



29-215
NEW INSTRUCTORS DISSECTING SET
(Set Of 12)



29-216
BASIC DISSECTING SETS
In Attractive Zipper Case
(set of 9)



29-217
BASIC DISSECTING SETS (Set of 13)
(In Attractive Zipper Case)



Tungsten Carbide is One Of The Hardest Alloys. We Bond These Inserts Into High Quality German Stianless SteelVery Special Reasonns Of The End Users. We Offer A Wide Range Of Instruments Which Includes Scissors, Forceps And Needle Holders Of All kinds Made Of German Stainless Steel. Briefly, We Strive To End Up With Quality, Precision And Conformity To Our Buyers/specification And Standard By All Means. The Process Indeed Involves Complex Machining Operations, Skill And Experience. Let Us Please Secure Your Atteion To Serve You Better. **MANAGEMENT**

Instruments with Tungsten Carbide Inserts

TC GOLD



STANDARD
30-101 to 30-106

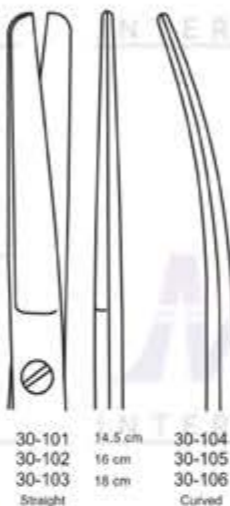

30-101 14.5 cm
30-102 16 cm
30-103 18 cm
Straight

30-104
30-105
30-106
Curved



STANDARD
30-107 to 30-112

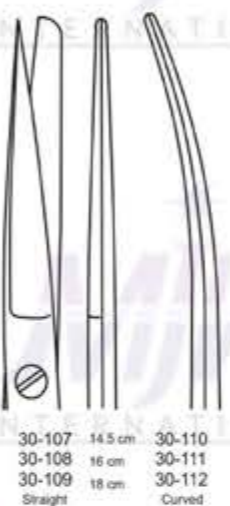

30-107 14.5 cm
30-108 16 cm
30-109 18 cm
Straight

30-110
30-111
30-112
Curved



STANDARD
30-113 to 30-118

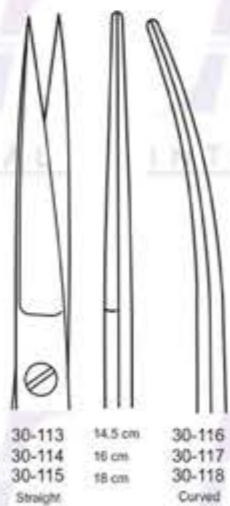

30-113 14.5 cm
30-114 16 cm
30-115 18 cm
Straight

30-116
30-117
30-118
Curved



MAYO
30-119 to 30-124

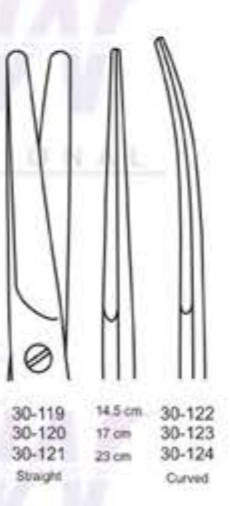

30-119 14.5 cm
30-120 17 cm
30-121 23 cm
Straight

30-122
30-123
30-124
Curved



MAYO-LEXER
30-125 to 30-126
16 cm



30-125
Straight

30-126
Curved



METZENBAUM
30-127 to 30-133

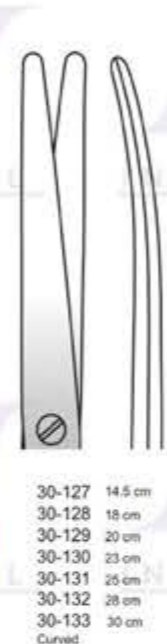

30-127 14.5 cm
30-128 18 cm
30-129 20 cm
30-130 23 cm
30-131 25 cm
30-132 28 cm
30-133 30 cm
Curved

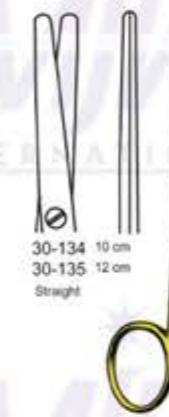

METZENBAUM
30-134 to 30-137

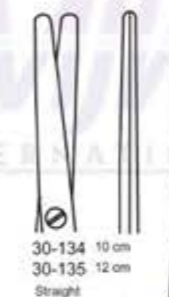

30-134 10 cm
30-135 12 cm
Straight

30-136 10 cm
30-137 12 cm
Curved

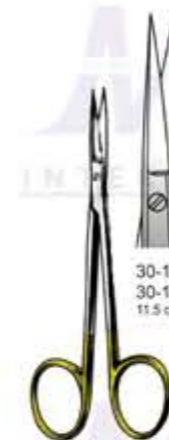

IRIS
30-138 to 30-139



30-138 Straight
30-139 Curved
11.5 cm

Instruments with Tungsten Carbide Inserts

TC GOLD



MAYO-STILLE
30-150 to 30-153

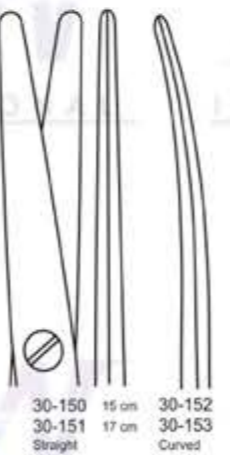

30-150 15 cm
30-151 17 cm
Straight

30-152
30-153
Curved



METZENBAUM-FINO
30-140 to 30-149

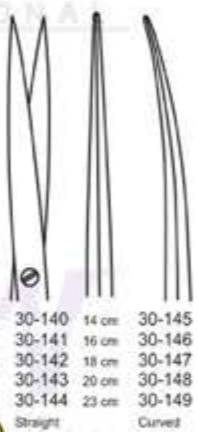

30-140 14 cm
30-141 16 cm
30-142 18 cm
30-143 20 cm
30-144 23 cm
Straight

30-145
30-146
30-147
30-148
30-149
Curved



LISTER
30-154 to 30-159

30-154 9 cm
30-155 11 cm
30-156 14 cm
30-157 16 cm
30-158 18 cm
30-159 20 cm



BRUNS
30-160
24 cm Serrated

Instruments with Tungsten Carbide Inserts
TC GOLD



Instruments with Tungsten Carbide Inserts
TC GOLD



Instruments with Tungsten Carbide Inserts
TC GOLD



90-456
18 cm / 7"
For soft wires up to 2 mmØ
For hard wires up to 1.5 mmØ



90-457
22 cm / 8 1/2"
For soft wires up to 3.5 mm
For hard wires up to 2.5 mm

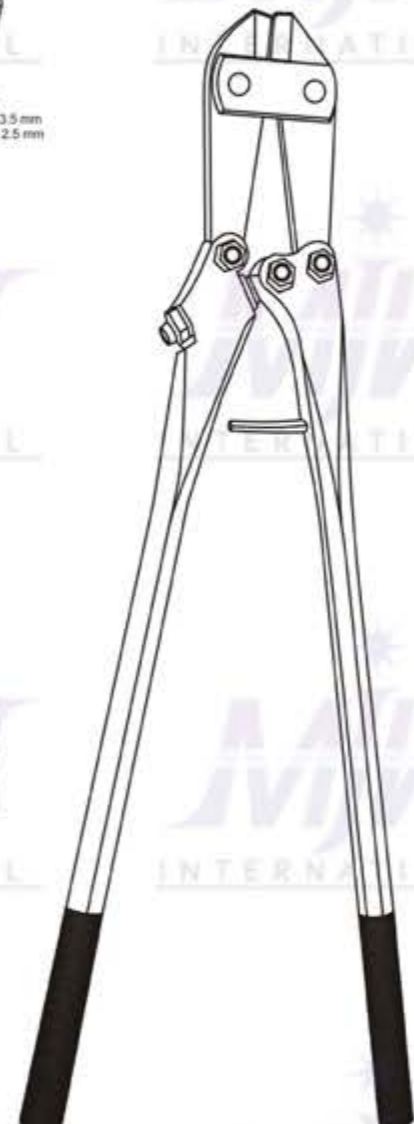

TC wire cutter For wire
90-463 38.5 cm / 15" 5 mm
90-464 45 cm / 17 1/2" 6 mm
90-465 56 cm / 22" 7.5 mm



90-458
22 cm / 8 1/2"
For soft wires up to 2.5 mmØ
For hard wires up to 2.2 mmØ



90-459 14 cm / 5 1/2"
90-460 16 cm / 6 1/2"
90-461 18 cm / 7"
90-462 22 cm / 8 1/2"
For soft wires up to 3 mmØ
For hard wires up to 2.2 mmØ

SECTION PAGE	
Surgical Holloware	31
	414 to 424



STERILIZER DRUM	
ART #	SIZE
31-101	125x80mm
31-102	125x120mm
31-103	150x100mm
31-104	150x150mm
31-105	180x180mm
31-106	190x140mm
31-107	190x190mm
31-108	200x200mm
31-109	240x120mm



31-101 To 31-118

STERILIZER DRUM	
ART #	SIZE
31-110	240x240mm
31-111	290x140mm
31-112	290x240mm
31-113	290x290mm
31-114	340x160mm
31-115	340x340mm
31-116	390x150mm
31-117	390x200mm
31-118	390x290mm



31-119

ELECTRIC STERILIZER	
ART #	SIZE
31-119	280x125x65mm

PERFORATED TRAY	
ART #	SIZE
31-131	200x100x40mm
31-132	250x120x50mm
31-133	300x150x50mm
31-134	350x170x50mm
31-135	400x200x50mm



31-131 To 31-135

INSTRUMENTS TRAY WITHOUT LID	
ART #	SIZE
31-136	100x150x25mm
31-137	150x200x40mm
31-138	200x250x45mm
31-139	250x300x50mm
31-140	300x350x50mm
31-141	150x300x50mm
31-142	200x300x50mm
31-143	230x150x50mm



31-136 To 31-143

ELECTRIC STERILIZER	
ART #	SIZE
31-120	200x100x120mm
31-121	250x120x140mm
31-122	300x150x150mm
31-123	350x170x170mm
31-124	400x200x180mm
31-125	450x230x190mm



31-120 To 31-125

INSTRUMENTS TRAY WITH LID	
ART #	SIZE
31-144	100x150x25mm
31-145	150x200x40mm
31-146	200x250x45mm
31-147	250x300x50mm
31-148	300x350x50mm
31-149	150x300x50mm
31-150	200x300x50mm
31-151	230x150x50mm



31-144 To 31-151

NON ELECTRIC STERILIZER	
ART #	SIZE
31-126	200x100x65mm
31-127	250x125x65mm
31-128	300x150x100mm
31-129	350x170x65mm
31-130	400x200x100mm



31-126 To 31-130



31-152 To 31-153

CATHETERS TRAY WITH LID	
ART #	SIZE
31-152	300x80x40mm
31-153	350x90x45mm
31-153A	400x100x50mm



BURR TRAY	
ART #	SIZE
31-154	190x100x20mm



SCALER TRAY WITH COVER	
ART #	SIZE
31-155	200x100x16mm

INSTRUMENTS BOX WITH HOOKS	
ART #	SIZE
31-156	170x70x30mm
31-157	180x80x40mm
31-158	200x100x40mm
31-159	230x120x50mm
31-160	250x125x50mm
31-161	300x150x50mm
31-162	350x170x50mm
31-163	400x200x90mm
31-164	500x200x120mm



31-156 To 31-164



31-165 To 31-173

INSTRUMENTS BOX	
ART #	SIZE
31-165	170x70x30mm
31-166	180x80x40mm
31-167	200x100x40mm
31-168	230x120x50mm
31-169	250x125x50mm
31-170	300x150x50mm
31-171	350x170x50mm
31-172	400x200x90mm
31-173	500x200x120mm

INSTRUMENTS BOX PERFORATED	
ART #	SIZE
31-174	200x100x40mm
31-175	250x150x40mm
31-176	300x150x40mm

26-339-4458 To 26-339-4480



31-174 To 31-176



Kidney Tray Shallow	
ART #	SIZE
31-177	17 cm
31-178	22 cm
31-179	24 cm



Kidney Tray With Cover	
ART #	SIZE
31-180	15 cm
31-181	20 cm
31-182	25 cm
31-183	30 cm



31-184 To 31-190

KIDNEY TRAY	
ART #	SIZE
31-184	12 cm
31-185	15 cm
31-186	18 cm
31-187	20 cm
31-188	25 cm
31-189	28 cm
31-190	30 cm



URINAL FEMALE	
ART #	SIZE
31-191	STANDARD

URINAL MALE	
ART #	SIZE
31-192	STANDARD

URINAL MALE VERTICAL	
ART #	SIZE
31-193	Standard



31-194 To 31-195

BEDPAN PERFECTION TYPE	
ART #	SIZE
31-194	370x290mm
31-195	320x240mm



31-196

BEDPAN PERFECTION TYPE SEEMLESS	
ART #	SIZE
31-196	350x300mm

26-341-4511 To 26-341-4530



31-197 To 31-198

BEDPAN SLEEPER TYPE		
ART #	SIZE	
31-197	Adult	
31-198	Child	



31-199 To 31-200

BEDPAN SIMPLE, PRESSED BODY WITH HANDLE		
ART #	SIZE	
31-199	Adult	
31-200	Child	



31-203

BEDPAN CHAMBER PORT		
ART #	SIZE	
31-203	Standard	



31-204

BEDPAN HAND MADE		
ART #	SIZE	
31-204	Standard	

BEDPAN HAND MADE		
ART #	SIZE	
31-205	Standard	



31-205



31-206

BEDPAN PLASTIC MADE		
ART #	SIZE	
31-206	Standard	



31-201 To 31-202

BEDPAN HAND MADE		
ART #	SIZE	
31-201	Adult	
31-202	Child	

SPONGE BOWL		
ART #	SIZE	
31-207	12 cm	
31-208	15 cm	
31-209	20 cm	

31-207 To 31-209



31-210 To 31-214

WASH BASIN		
ART #	SIZE	
31-210	300x80mm	
31-211	320x85mm	
31-212	330x90mm	
31-213	350x110mm	
31-214	400x115mm	



31-215 To 31-228

Lotion Bowl Without Spout		
ART #	SIZE	
31-215	40x19mm	
31-216	50x25mm	
31-217	60x30mm	
31-218	80x40mm	
31-219	100x50mm	
31-220	120x60mm	
31-221	140x60mm	
31-222	150x65mm	
31-223	180x85mm	
31-224	200x100mm	
31-225	250x120mm	
31-226	300mm	
31-227	350mm	
31-228	400mm	



31-229 To 31-244

GALLIPOT		
ART #	SIZE	
31-229	01 oz	
31-230	02 oz	
31-231	03 oz	
31-232	04 oz	
31-233	05 oz	
31-234	06 oz	
31-235	07 oz	
31-236	08 oz	
31-237	09 oz	
31-238	10 oz	
31-239	11 oz	
31-240	12 oz	
31-241	13 oz	
31-242	14 oz	
31-243	15 oz	
31-244	16 oz	



31-245 To 31-247

MEDICINE CUP		
ART #	SIZE	
31-245	50ml	
31-246	60ml	
31-247	70ml	



31-248 To 31-250

Pail/bucket With Lid		
ART #	SIZE	
31-248	06 Ltr	
31-249	10 Ltr	
31-250	15 Ltr	



31-248A To 31-250D

Pail/bucket Without Lid		
ART #	SIZE	
31-248A	06 Ltr	
31-248B	10 Ltr	
31-248C	15 Ltr	
31-248D	20 Ltr	



31-251 To 31-254

MEASURING JUG		
ART #	SIZE	
31-251	0.5 Ltr	
31-252	1.0 Ltr	
31-253	1.5 Ltr	
31-254	2.0 Ltr	



31-256

31-255 To 31-256

KICK BUCKET WITH TROLLEY		
ART #	SIZE	
31-255	390x280x180mm	
31-256	Only Trolley	



31-257 To 31-259

Douch Can / Irrigator

ART #	SIZE
31-257	1.0 Ltr
31-258	1.5 Ltr
31-259	2.0 Ltr



31-260 To 31-266

DRESSING JAR

ART #	SIZE
31-260	80x60mm
31-261	80x80mm
31-262	100x100mm
31-263	120x120mm
31-264	150x150mm
31-265	180x180mm
31-266	200x200mm



31-267 To 31-273

DRESSING JAR

ART #	SIZE
31-267	80x60mm
31-268	80x80mm
31-269	100x100mm
31-270	120x120mm
31-271	150x150mm
31-272	180x180mm
31-273	200x200mm

FORCEPS JAR

ART #	SIZE
31-274	30x90mm
31-275	50x125mm
31-276	50x170mm
31-277	50x200mm
31-278	40x230mm
31-279	70x110mm
31-280	80x150mm
31-281	100x200mm
31-282	150x30mm

31-274 To 31-282

FENNLE

ART #	SIZE
31-283	Ø 100mm
31-284	Ø 120mm
31-285	Ø 150mm
31-286	Ø 200mm

31-283 To 31-286



SPRIT LAMP DOUBLE NOT

ART #	SIZE
31-287	STANDARD



SPRIT LAMP SINGLE NOT

ART #	SIZE
31-288	STANDARD



31-289 To 31-291

SPUTUM CUP

ART #	SIZE
31-289	100x50mm
31-290	100x80mm
31-291	75x80mm

31-257 To 31-291

ENDOONIC BOX

ART #	SIZE
31-292	100x40x50mm

31-292



31-293

COTTON HOLDER

ART #	SIZE
31-293	

TUBE RACK

ART #	SIZE
31-294	6.35x15.25x8cm for 12 Tubes
31-295	6.35x17.75x7.5cm for 27 Tubes
31-296	7.5x17.75x6.35cm for 36 Tubes

31-294 To 31-296



Needle Case Round with Cover

ART #	SIZE
31-297	65x15mm



NEEDLE CASE ROUND

ART #	SIZE
31-298	80x20mm



NEEDLE CASE RECTANGLE

ART #	SIZE
31-299	70x70x10mm

DUSTBIN	
ART #	SIZE
31-300	210mm
31-301	240mm
31-302	270mm
31-303	300mm

31-300 To 31-303



DUSTBIN WITH STAND	
ART #	SIZE
31-303A	STANDARD

31-303A



31-303B

AUTOCLAVE PROCESSOR COOKER	
ART #	SIZE
31-303B	STANDARD

WIRE MESH TRAY	
ART #	SIZE
31-304	240x250x5mm
31-305	480x250x5mm
31-306	550x250x5mm
31-307	240x250x7mm
31-308	480x250x7mm
31-309	240x250x10mm
31-310	480x250x10mm

31-304 To 31-310



WIRE MESH TRAY WITH LID	
ART #	SIZE
31-311	240x250x5mm
31-312	480x250x5mm
31-313	550x250x5mm
31-314	240x250x7mm
31-315	480x250x7mm
31-316	240x250x10mm
31-317	480x250x10mm

31-311 To 31-317

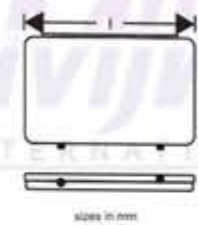

Sterilization Storage
Needle Sterilizing Cases



31-218
Sauerbruch
210 x 125 x 17 mm
perforated lid and
bottom



31-219
Sauerbruch
210 x 125 x 17 mm
perforated lid and
bottom



31-220
150 x 95 x 13 mm



31-221
150 x 95 x 13 mm
perforated lid and
bottom



31-222
150 x 95 x 13 mm
perforated bottom



31-223
150 x 95 x 13 mm
perforated lid and
bottom



31-224
150 x 95 x 13 mm



31-225
150 x 95 x 13 mm
perforated lid and
bottom



31-226
150 x 95 x 11 mm
Needle tray perforated
bottom



31-227 - 230

Sterilizing Trays of wire mesh
for container 60cm long.

31-227	250 x 250 x 50	mm
31-228	480 x 250 x 50	mm
31-229	520 x 250 x 75	mm
31-230	520 x 250 x 100	mm



31-231- 236

Sterilizing Tray Of Perforated
Steel Sheet

31-231	240 x 240 x 50	mm
31-232	240 x 240 x 80	mm
31-233	240 x 240 x 100	mm
31-234	480 x 260 x 50	mm
31-235	520 x 260 x 80	mm
31-236	520 x 260 x 100	mm



Nominal Dimensions

31-237	60 x 30 x 15	cm
31-238	60 x 30 x 30	cm

ALPHABETICAL

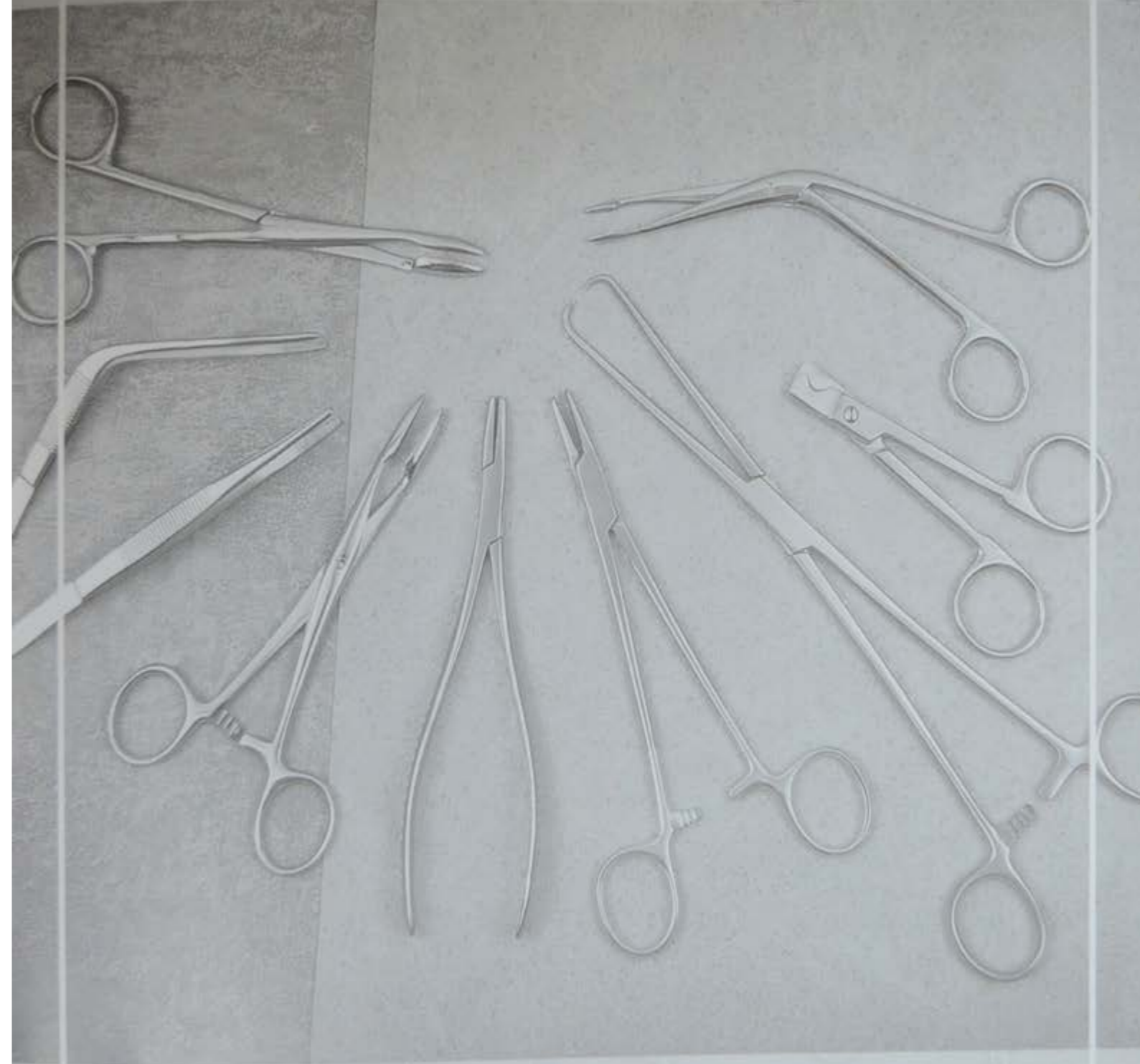

INDEX

A

Abdominal Blades	163
Retractors	144-147, 162-167
Abraham Tonsil Knife	17
Adson Delicate Haemostatic Forceps	80
Dissecting Forceps	55,62,411
Needle Holders	98
Raspatories	334
Retractors	155-156
Adson-Baby Self-Retaining Retractors	154
Adson-Brown Tissue Forceps	63
Aesthesiometers	1
Alexander Bone Rongeurs	367
Gouges	353
Rib Raspatories	299
ALM Organ Grasping Forceps	74
Retractors	151
Sponge Forceps	68
Allen Intestinal Clamps	173
Allis Artery Traction Forceps	73
Intestinal Grasping Forceps	171
Lung Grasping Forceps	290
Tissue Grasping Forceps	168
Allison Lung Spatulas	138,309
ALY Aesthesiometers	1
Amputation Knives	16,319
Retractors	320
Saws	321-322
Anastomosis Clamps	184-186,265-266, 269-270,275-276, 285-286,293
Anderson-Adson Retractors	155
Andrew Tongue Depressors	5
Anestrophon Stethoscope	2
Angle Wire Cutters	388
Antrum Trocars	208
Anusocopes	189
Aorta Clamps	280-281,288
Aorta-Anastomosis Clamps	282
Aorta-Aneurysm Clamps	278-279
Aorta Cross Clamps	276-277
Aortic Dilators	260
Appendectomy Clamps	182
Approx Elevating Forceps	235
Arruga Forceps	62
Needle Holders	96,412,413
Artery Traction Forceps	73
Asch Secretion Curette/Scoop	237
Aspiration Curettes	398
Ateriotomy Scissors	34
Aufrecht Bone Rasps	339
Austin Micro Forceps	52
Autopsy Knives	13,16
Auricle Clamps	294
Auvard Vaginal Speculums	218
Ayre Cone Knife	17
B	
Babcock Intestinal Grasping Forceps	169,171
Lung Grasping Forceps	290
Baby-Adson Forceps	87
Baby-Allis Artery Traction Forceps	73
Baby-Allis Tissue Grasping Forceps	168
Baby-Collin Abdominal Retractors	162
Baby-Crile Delicate Haemostatic Forceps	80
Baby-Kocher Intestinal Clamps	173
Baby-Metzenbaum Scissors	38
Baby-Mikulicz Peritoneum Forceps	91
Baby-Mixer Forceps	87
Baby-Mosquito (Hartmann) Haemostatic Forceps	79
Baby-Nail Scissors	49
Baby-Overholt Forceps	87
Baby-Roux Retractors	123
Baby-Senn-Miller Retractors	123
Backhaus Towel Clamps	75
Backhaus-Kocher Towel Clamps	75
Bailey Rib Spreaders and Contractors	307
Bainbridge Intestinal Clamps	173
Bakes Common Bile Duct Dilators	198
Balfour Abdominal Retractors	165
Balfour-Baby Abdominal Retractors	164
Bandage Cutting Scissors	49-51,393,394
Bane-Hartmann Bone Rongeurs	366
Barraquer Micro Needle Holders	97,419
Retractors	151
Barth Bone Curettes	342
Bayonet Shaped Forceps	53-54,61
Bumgartner Needle Holders	98
Beckmann-Adson Retractors	156
Beckmann-Eaton Retractors	156
Beebe Wire and Plate Scissors	48
Beer Cilia Forceps	66
Bed Pans	417-18
Bending Pliers	387
Bengolea Delicate Haemostatic Forceps	81
Bennett Bone Levers	330
Berger Biopsy Forceps	240
Bergh Cilia Forceps	66
Bergmann Mallets	350
Plaster Scissors	394
Trachea Retractors	118
Berliner Percussion Hammer	1
Bertillon Caliper for Head	11
Bethune Rib Shears	296
Beyer Bone Rongeurs	367
Biemer Curettes for Aspiration Lipectomy	398
Vein Scissors	24
Bier Amputation Saws	322
Bircher Meniscus and Cartilage Forceps	377
Bircher-Ganske Meniscus & Cartilage Forceps	377
Biopsy Curettes	237
Forceps	238-240
Forceps For Rectum	190-191
Biopsy Instruments	237-240
Tips	240
Biopptome	260
Bishop-Harmon Forceps	62
Blade Breakers	19
Bladder Retractors	204
Spatula	204
Blake Embolus Grasping Forceps	257
Gall Stone Dilators	198
Gall Stone Forceps	199
Uterine Curettes	242
Blood Lancet	7
Blumenthal Bone Rongeurs	366
Bohler Bone Cutting Forceps	374
Bone Rongeurs	368
Traction Bows	382
Bonaccollo Forceps	55
Bone Clamps	364
Curettes	342-347
Cutting Forceps	297,373-376
Files	399-341
Holding Forceps	358-363
Levers	324-330
Rasps	339-341
Retractors	125
Rongeurs	365-372
Shears	42
Bonney Dissecting Forceps	58
Tissue Forceps	65
Bose Self-Retaining Retractors	151

Bose Trachea Retractors	118
Tracheal Hooks	256
Bowel Scissors	46
Bowles Stethoscopes	2
Bowman Probes	109
Boynton Needle Holders	101
Boys-Allis Artery Traction Forceps	73,168
Bozemann Uterine Dressing Forceps	225,226
Uterine Scissors	44
Vaginal Speculums	219
Bozemann-Douglas Uterine Dressing Forceps	226
Bozemann-Fritsch Uterine Flushing Tube	245
Brain Knives	13
Braun Artery Traction Forceps	73
Cranioclast	254
Tenaculum Forceps	227
Uterine Depressor	224
Vaginal Speculums	215
Braun-Stadler Scissors	45,51,248
Breisky Pelvimeter	246
Vaginal Speculums	211,217
Brock Micro Needle Holders	97
Brodie Director	107
Brom Vein Hook	115
Bronchus Clamps	277
Forceps	295
Brophy Dissecting Forceps	56
Tissue Forceps	64
Brown Forceps	63
Bruenings Extension Cannulae	240
Tongue Depressor	5
Tonsil Knife	17
Brunner Guiding Probes	105,106
Ligature Needles	105
Retractors	137
Rib Shears	296
Bruns Bandage and Plaster Scissors	51,394
Bone Curettes	344
Bryant Sponge Forceps	344
Buchs Retractors	130
Buchwald Tongue Depressors	5
Buck Cotton Applicators	110
Percussion Hammer	1
Buck-Gramcko Bone Levers	325
Buelau Empyema Trocars	208
Bulldog Clamps	77,78
Bumm Ovum Curettes	243
Ovum Forceps	232
Uterine Curettes	242
Bunt Safety Pin	76
Bushe Bone Curettes	345

C

Calipers	11
Canad. Model Meniscus Knives	379
Cardiovascular Scissors	40
Carroll Caliper	11
Carotid Clamps	294
Carrel Delicate Haemostatic Forceps	79
Cartilage Forceps	377
Knives	13,16
Caspar Bone Curettes	346
Knot tier and Ligature Adjuster	106
Micro Scissors	24
Nerve and Vessel Hooks	116
Raspatories	335
Retractors	130,160
Rongeurs	314-316,318
Tampers	351
Castaneda Multi Purpose Clamps	265

Castroviejo Blade Holder	19
Caliper	11
Micro Spring Scissors	23
Needle Holders	96,412
Tissue Forceps	62
Castroviejo-Koshima Needle Holders	412
Castroviejo-Micro Needle Holders	412
Catlin Knife	16
Cerclage Instruments	384
Wire Tightner	383
Chaput Artery Traction Forceps	73,168
Charging Set	4
Charriere Amputation Saws	321,322
Cheate Forceps with Jar	423
Cheek and Lip Retractors	5
Cheron Sponge Forceps	69
Chisels	351-353,355,356
Choledochus Forceps	195
Cilia Forceps	66
Circumcision Clamps	207
Citelli Punches	310
Citelli-Beyer Punches	310
Clar Head Light	4
Claus Van Eicken Needle	104
Cleaning Brush	256
Clip Applying and Removing Forceps	111
Clip Applying Forceps	111
Cloth Scissors	50,51
Cloward Lamina Spreader	161
Retractors	159
Coagulation Hooks	116
Suction Cannulae	404
Coakley Antrum Trocars	208
Coarctation Clamps	272,273,288
Collin Abdominal Retractor	162
Clip Applying Forceps	111
Druck Pressure	11
Elevating Forceps	233,235
Intestinal Grasping Forceps	169,171
Kidney Elevating Forceps	202
Organ and Tissue Grasping Forceps	71
Ovum Curettes	243
Pelvimeters	246
Retractors	123
Rib Shears	296
Scalpel Handle	20
Sponge Forceps	69,71
Tongue Forceps	6
Vaginal Speculums	209
Collin-Hartmann Retractors	123
Combined Suction and Irrigation Cannulae	404
Comedone Extractors	18
Compression Forceps	94-95
Conductors	323
Cone Knife	17
Contractors	307
Converse Dura and Skin Retractor	117
Needle Holder	98
Cooley Aortic Dilators	260
Clamps	284-288
Multi Purpose Clamps	266,287
Sternotomy Spreaders	305
Cooley-Beck Anastomosis Clamps	284
Cooper Surgical Scissors	31
Ligature Needle	104
Coronary Artery Scissors	39
Cottle Bulldog Scissors	33
Chisels	353
Forceps	61
Mallets	348
Nasal Scissors	41
Osteotomes	353
Raspatories	333,335

Retractors	122	Demel Wire Guide	384
Wound Retractors	117	Denhardt Mouth Gag	6
Cotton Applicators	109,110,224	Denis Browne Intestinal Forceps	65,170
Crafoord Auricle Clamps	294	Derf Needle Holders	98
Delicate Haemostatic Forceps	81	Dermotomes	22
Crafoord-Sellors Auricle Clamps	294	Derra Multi Purpose Clamps	266
Cranioclast	254	Derra-Cooley Anastomosis Clamps	285
Crite Delicate Forceps	80	Deschamps Ligature Needles	103,104
Needle Holders	100	Desjardins Forceps	90,194
Nerve and Vessel Hook	115	Gall Duct Probes	197
Retractors	123	Gall Stone Forceps	199
Crite-Murray Needle Holders	98	Gall Stone Probes	198
Crite-Wood Needle Holders	98	Desmarres Retractors	122
Cusco Vaginal Speculums	209,210	Diagnostic Sets	8
Cushing Dissecting Forceps	56,409	Dick Anastomosis Clamps	184,276
Nerve and Vessel Hooks	115,116	Atraumata Compression Clamps	94
Retractors	122	Dieffenbach Bulldog Clamps	77
Rongeurs	316	Scalpels	14
Cushing-Kocher Retractors	122	Diethrich Aorta Clamps	280
Cushing -Taylor Forceps Bayonet	409	Scissors	39
Czerny Gall Stone Forceps	199	Dilators	256,257
Retractors	124	Dingmann Bone Holding Forceps	358
Tenaculum Forceps	229	Directors Probes	107
D		Distractors	382
Dandy Delicate Forceps	79	Dissecting Forceps	57,58,87-90,
Dardik Multi Purpose Clamps	289	263,269,291,	
Dartigues Elevating Forceps	233	292	
Kidney Elevating Forceps	202	Dissecting SETS	406
Daubenspeck Bone Curettes	345	Knives	12
Davidson Scapula Retractors	139,308	Scissors	33-38,409
Davis Vascular Spatulas	258	Dittel Gall Duct Dilators	198
De Bakey Anastomosis Clamps	186	Urethral Bougies	206
Aorta Clamps	281	Doyen Gall Bladder Forceps	196
Aorta-Aneurysm Clamps	278,279	Intestinal Clamps	174-176
Ateriotomy Scissors	34	Myoma Screws	236
Bulldog Clamps	78	Needle Holder	98
Clamps	264-283	Ovum Forceps	232
Coarctation Clamps	272,273	Directors	107
Dissecting Forceps	263	Raspatories	298,337
Forceps (Full range)	60,172,263	Retractors	146-147
Multi Purpose Clamps	266,283	Towel Clamps	75
Needle Holders	409	Vaginal Speculums	216,217
Offset Scissors	39	Doyen-Child Fixation Device	147
Patent-Ductus Clamps	273	Dressing Forceps	67-71
Peripheral-Vascular Clamps	274,275	Sterilizing Drums	412
Retractors	157	Drilling Chucks	383
Rib Spreaders	303	Duplay Sponge Forceps	67
Ring Handle Bulldog Clamps	264	Tenaculum Forceps	228
Suction Cannulae	309,401	Durogrip Bone Rasps	340
Tangential Occlusion Clamps	271,272	Wire Holding Forceps	386
Vascular Clamps	274,275	Durotip Angle Wire Cutters	388
Vascular Dilators	257	Wire Cutting Pliers	389,391
Vessel Scissors	39	Wire Cutting Scissors	388
De Bakey-Beck Vena Cava Clamps	270	Dura Knives	18
De Bakey-Bainbridge Atraumata Haemostatic Forceps	267	Retractors	117
De Bakey-Harken Vena Cava Clamps	271	Scissors	40
De Bakey-Hess Bulldog Clamps	77	Duval Intestinal Forceps	65,169
De Bakey-Kelly Atraumata Haemostatic Forceps	268	Intestinal Grasping Forceps	170
De Bakey-Mixer Dissecting & Ligature Forceps	269	Lung Grasping Forceps	290
De Bakey-Pean Atraumata Haemostatic Forceps	268	Duval-Collin Intestinal Grasping Forceps	169
De Bakey-Satinsky Tangential Occlusion Clamps	272	E	
De Lee Pelvimeter	246	Ear Specula	07
Dean Tonsil Scissors	41	Echlin Bone Rongeurs	369
Deaver Retractors	139-143	Eiselsberg Ligature Scissors	47
Surgical Scissors (Flat Lock)	32	Needle Holders	100
Dejerine Percussion Hammer	1	Eiselsberg-Mathieu Needle Holder	101
Delicate Dissecting Forceps	55-56	Elevators	258,299,324,
Haemostatic Forceps	79-81	331-336	
Scissors	26-29,33,41	Elsching Forceps	62
Tissue Forceps	62	Embolus Grasping Forceps	257
		Emmet Fistula Hooks	121
		Sponge and Dressing Forceps	69

Empyema Trocars	208
Endarterectomy Strippers	259
Endospecula For Cervix	223
Engel Plaster Saw	393
Engl. Mod. Towel Clamps	75
Enucleation Scissors	35
Episiotomy Scissors	45,248
Eppendorf Biopsy Forceps	240
Esmarch Bandage & Plaster Scissors	51,394
Plaster Knife	393
Ether Mask	6
Examination and Measuring Instruments	11
Exploration Hooks	116
Extension Cannulae	240
Cord	4
Extraction Pliers	387
Eye Scissors	23

F	
Farabeuf Bone Holding Forceps	360
Raspatories	336
Retractors	123
Farabeuf-Lambotte Bone Holding Forceps	360
Farrell Cotton Applicators	109,110
Faure Biopsy Forceps	238
Peritoneum Forceps	91
Favoloro Artery Scissors	39
Feilchenfeld Splinter Forceps	66
Female Catheters Urinary Instruments	206
Femur Retractor	157
Fergusson Bone Holding Forceps	359
Haemorrhoidal Forceps	193
Suction Tube	402
Fergusson-Ackland Mouth Gag	6
Ferris-Smith-Kerrison Punches	312
Fiber Optic Battery Handle	10
Fine Scissors	27,33,34,410
Finger Nail Drill	392
Nail Instruments	392
Ring Saw	392
Finocchioletto Dissecting & Ligature Forceps	89,291
Needle Holders	411
Rib Spreaders	300,301
Finocchioletto-Burford Rib Spreaders	302
Finsen Self-Retaining Retractors	151,256
Finsterer Combined Cannulae	404
Fishtail Chisel	353
Fistula Hooks	121
Fixation Clamp	380
Discs	381
Flap Knives	16
Flat Nosed Pliers	386,387
Foerster-Ballenger Sponge Holding Forceps	70
Fomon Dissecting Scissors	35
Forceps	60-61
Nasal Scissors	41
Rasps/Bone File	340
Retractors	120
With Tungsten Carbide Inserts	52-66
Ford-Bowles Stethoscopes	411-412
Foregger Laryngoscopes	2
Fowler Tonsil Knife	10
Francke Blood Lancet	17
Frazier Fine Wound Retractors	7
Suction Tube	117
Freer Chisels	402
Fine Wound Retractors	351
Gouges	117
Raspatories	351
Vascular Spatulas	332,333
Freer-Yasargil Raspatories	258
	333

Frenzel Tongue Depressors	5
Fricke Artery Forceps	58,82
Fritsch Retractors	146
G	
Gall Bladder Forceps	196
Trocars	208
Gall Duct Dilators	198
Forceps	194-195
Probes	197
Scissors	196
Gall Stone Forceps	199
Scopes	198
Gallaher Bone File	339
Gastro-Intestinal Forceps	181
Gauss Scalp Flap Forceps	251
Gelpi Retractors	157
Vaginal Retractors	220
Genito-Urinary Instruments	205-207
Gerald Dissecting Forceps	56
Tissue Forceps	64
Gerster Bone Clamps	364
Giertz-Stille Rib Shears	269
Gigli Wire Saws and Handle	323
Gill Forceps	62
Gill-Hess Forceps	62
Gillies Fine Wound Retractors	117
Needle Holders	100
Tissue Forceps	64
Glass Rods	236
Glover Anastomosis Clamps	269,270
Bulldog Clamps	78
Vana Cava Clamps	270
Gluck Rib Shears	296
Good Tonsil Scissors	41
Gorney Suction Dissector	402
Gosset Abdominal Retractors	164
Gouges	351-353,355-356
Graefe Fine Wound Retractors	117
Knives	14
Nerve and Vessel Hooks	115
Tissue Forceps	63
Grave Vaginal Speculums	211
Gray Forceps	90,195
Green-Armytage Obstetrics Forceps	251
Gross Sponge Forceps	67
Gruenwald Forceps	61
Guedel-Negus Laryngoscopes	9
Guide	259
Guiding Probes	105,106
Guthrie Fine Wound Retractors	117
Guyon Catheter Guide	206
Kidney Clamps	200
Urethral Bougies	206-207
Gynaecological Instruments	245
Scissors	43-44

H	
Haase Tamper	351
Reposition Forceps	357
Haberer Intestinal Spatulas	150
Haemostatic ATRAUMATA Forceps	267,268
Haemostatic Forceps	70,79-86,92
Haemorrhoidal Forceps	192-193
Hajak Irrigation Cannula	197
Mallets	349
Hajak-Kofler Punches	311
Halogen Replacement Lamp	10

Halle Bone Curettes	345
Raspatories	332
Vascular Spatulas	258
Halsey Needle Holder	98,413
Halsted Delicate Forceps	80,81
Halsted-Mosquito Delicate Forceps	79,81
Handles	7,20,21,137,215,219,240,259,261,323,399
Harken Vena Cava Clamps	293
Hartmann Intestinal Clamps	174
Nasal Specula	187
Harvey Wire Cutting Scissors	48,388
Harrington Retractors	138
Harrington-Pemberton Retractors	308
Head Bands	3
Lights	4
Mirrors	3
Heaney Hysterectomy Forceps	92,93
Heaney (Hegar) Needle Holders	99
Heath Clip Removing Forceps	111
Mallet	350
Hebra Comedone Extractors	18
Hegar Needle Holders	99,410
Uterine Dilators	221-222
Hegar-Olsen Needle Holders	100
Hegar-Vascular Needle Holders	410
Hegenarth Clip Applying Forceps	111
Heiss Delicate Haemostatic Forceps	81
Ligature Forceps	89
Heister Mouth Gag	6
Hemingway Bone Curettes	343
Hennig Plaster Spreader	397
Herberhold Pocket-Accu	4
Herff Membrane Puncturing Forceps	247
Herget Biopsy Forceps	190
Herrick Kidney Pedicle Clamps	201
Hertzler Retractors	164
Rib Spreaders	300
Herz Tendon Seizing Forceps	72
Hess Forceps	62
Hey Groves Bone Holding Forceps	362
Heymann-Knight Nasal Scissors	41
Heywood-Smith Gall Bladder Forceps	196
Haemorrhoidal Forceps	192
Ovum Forceps	231
Sponge Holding Forceps	71
Tongue Forceps	6
Hoepfner Vessel Clamps	292
Hohmann-Aldinger Bone Levers	329
Holzbach Abdominal Retractor	162
Hopkins Plaster Knife	393
Hose Connection	244
Hosel Retractors	131
Hosemann Choledochus Forceps	195
Hospital Wares	414-424
House Irrigation Cannulae	333
Howarth Raspatories	240
Huber Handle	54
Hunt Tumor & Vessel Forceps	66
Hunter Splinter Forceps	104
Hurd Ligature Needles	92-94
Hysterectomy Forceps	
I	
Incision Surgical Scissors	32
Inge Lamina Spreaders	161
Instrument Boxes	416
Instruments for Micro Tubal Operation	236
Interosseous Knife	16,319

Intestinal Clamps	173-180
Forceps	65,168-171
Spatulas	149-150
Intestinal And Pylorus Clamps	183
Iowa Membrane Puncturing Forceps	247
Irrigation Cannulae	257,404
Israel Retractors	127
Ives-Fansler Anusscopes	189
J	
Jackson Tendon Seizing Forceps	72
Tracheal Tubes	255
Vaginal Speculums	214
Jackson Burrows Retractors	157
Jacobs Tenaculum Forceps	230
Jacobson Bone Curettes	342
Needle Holder	96
Jaeger Fine Wound Retractors	117
Jager Tendon Seizing Forceps	72
Jameson Dissecting Scissors	34
Needle Holder	99
Jansen Bone Curettes	342,343
Bone Rongeurs	366,367
Forceps	61
Head Light with Plastic Band	4
Raspatories	336
Retractors	151
Jars	406
Jenkner Instrument set for Tunnelling and Pulling-through Vascular Grafts	261
Jeweler Forceps	52
Johns-Hopkins Bulldog Clamps	77
Joll (Friedman) Retractors	157,220
Jones Towel Clamps	75
Jonesco Ligature Needles	104
Jordan Instruments	385
Joseph Bone File	339
Delicate Scissors	29
Fine Wound Retractors	117
Nasal Knives	18
Raspatories	331
Judd-Allis Tissue Grasping Forceps	168
Judd-Masson Bladder Retractors	204
K	
Kader Intestinal Spatula	149
Kalt Needle Holders	96,412
Kazanjan Bone Cutting Forceps	373
Kelly Delicate Forceps	79
Delicate Scissors	29
Obstetrical Forceps	254
Ovum Forceps	231
Proctoscopes	189
Retractors	133,145
Sphincteroscopes	189
Sponge Holding Forceps	71
Kern-Lane Bone Holding Forceps	361
Kerpel Bone Curettes	343
Kerrison Punches	311
Kerrison-Jacoby Punches	312
Kersting Anastomosis Clamps	186
Kidney Clamps	200-201
Dishes	415
Elevating Forceps	202
Stone Forceps	203
Killian Bone Shears	42
Probes	109
Raspatories	333
Rectal Specula	187

Kilner Dissecting Scissors	34,410
Fine Wound Retractors	117
Needle Holder	98
Kirschner Guiding Probes	106
Retractors	167
Wire Tractions	380,381
Kirschner-Balfour Blade	167
Klapp Tendon Hooks	121
Kleinschmidt Spur Crusher	182
Klima Rosegger Sternal Puncture Needle Knives	208
12-14,16-18,22,319,393	
Knot tier and Ligature Adjuster	106
Knowles Bandage Scissors	49
Kocher Bladder Spatulas	204
Bone Retractors	125,126
Guiding Probes	106
Haemostatic Forceps	84
Intestinal Clamps	175,177,178
Retractors	122,125,126,129,130
Suture Needles	104
Kocher-Langenbeck Retractors	128
Kocher-Ochsner Haemostatic Forceps	85
Koenig Guiding Probes	106
Elevators	324
Raspatories	331
Retractors	122
Koerte Retractors	127
Kogan Endospecula	223
Koile Micro Needle Holders	7
Krause Biopsy Tips	240
Krayenbuhl Nerve and Vessel Hooks	116
Kristeller Vaginal Speculums	211-214
Kronecker Ligature Needles	103
Kronlein Haemostatic Forceps	82
Krypton Replacement Lamp	10
Kuhne Cover Glass Forceps	55
Kummel Intestinal Spatula	149
Kustner Tenaculum Forceps	229
L	
Laborde Tracheal Dilators	256
Lahey Artery Traction Forceps	73
Gall Duct Forceps	194
Tenaculum Forceps	228
Lahey (Sweet) Dissecting and Ligature Forceps	90
Gall Duct Forceps	194
Lambotte Bone Holding Forceps	363
Osteotomes	353,354
Rib Raspatories	299
Lamina Spreaders	161
Laminectomy Retractors	155,156,158
Landolt Coagulation Suction Cannulae	404
Enucleation Scissors	35
Raspatories	335
Suction Cannulae	403
Lane Bone Holding Forceps	361,362
Bone Levers	326
Intestinal Forceps Twin	181
Intestinal Grasping Forceps	170
Tissue Forceps	65
Towel Clamps	75
Lane Trethowan Bone Levers	326
Lange Fistula Hooks	121
Lange-Hohmann Bone Levers	326
Langenbeck Amputation Saws	322
Bone Holding Forceps	359
Bone Levers	324
Elevators	324

Flap Knife	16
Head Light	4
Needle Holders	416
Raspatories	336
Resection Knives	14,319
Retractors	128
Rib Raspatories	299
Langenbeck-Green Retractors	120
Langenbeck-Mannerfelt Retractors	119
Langhals Needle Holders	416
Laryngeal Mirrors	7
Laryngoscopes	9,10
Lathbury-Farrell Cotton Applicators	109,110
Lawrence Forceps	89
Lazar Micro Forceps	52
Lebsche Conductor for Wire Saws	323
Sternum Chisels	296
Lees Bronchus Clamps	277
Legueu Bladder Retractors	204
Bladder Spatula	204
Leksell-Stille Bone Rongeurs	370
Leland-Jones Peripheral-Vascular Clamps	274,275
Lempert Bone Curettes	345
Bone Rongeurs	367
Lerliche Intestinal Spatula	149
Lewis Bone Rasps	339
Lewkowitz Ovum Forceps	253
Lexer Gouges	355,356
Osteotomes	355,356
Scissors	37,406
Lexer-Mini Gouges	355
Osteotomes	355
Lichtenberg Needle Holders	412
Ligature Adjuster	106
Forceps	53,58,87-90,269,291-292
Needles	103-105
Pliers	386
Scissors	47
Lister Bandage Scissors	50
Sinus Forceps	67
Liston Bone Cutting Forceps	373,375
Knife	16
Liston-Key-Horsley Bone Cutting Forceps	297,376
Liston-Stille Bone Cutting Forceps	297,376
Littauer Ligature Scissors	47
Littler Dissecting Scissors	33
Littlewood Tenaculum Forceps	230
Liver Retractor	145
Lloyd-Davis Sigmoid Anastomosis Clamps	185
Lloyd-Davies Rectal Scissors (Goligher's)	46
Lockhart-Mummery Probes	107
Locklin Scissors	41
Lockwood Intestinal Grasping Forceps	169
Logan modif. Reill Self-Retaining Retractors	151
Lopez-Reinke Tonsil Dissector	402
Loma Towel Clamps	76
Loute Wire Tightener	383
Love-Gruenwald Rongeurs	314,316,317
Lower Forceps	90,194
Lowman Bone Clamps	364
Lowman-Gerster Bone Clamps	364
Lowman-Hoglund Bone Clamps	364
Lucae Forceps	61
Lucas Bone Curettes	343
Chisels	352
Gouges	352
Luer Bone Rongeurs	366,368
Haemorrhoidal Forceps	192
Retractors	123
Tracheal Tubes	255
Luer-Friedmann Bone Rongeurs	365

Luer-Koerte Gall Stone Scoops 198
Luer-Stille Bone Rongeurs 371,372
Lung Dissecting Forceps 65
Grasping Forceps 290
Spatulas, Retractors 138-143,308-309
Luxation Lever 330

M

Mac Donald Raspatories 333
Magill Forceps 8
Maier Sponge Forceps 68
Maltz Bone Rasps 339
Mallets 348-350
Mannerfelt Osteotomes 351,352
Raspatories 334
Retractors 119
Markwalder Rib Rongeurs 297
Marquardt Bone Rongeurs 368
Martin Meniscus and Cartilage Forceps 377
Needle Holders 414
Pelvimeters 246
Retractors 135
Tenaculum Forceps 228
Uterine Probes 224
Vaginal Speculums 218
Martini Bone Curettes 342
Masing Retractors 122
Masson Needle Holders 99,411
Masson-Luethy Needle Holders 99
Mathieu Foreign Body Forceps 205
Needle Holders 101,412
Rectal Specula 188
Retractors 124
Vaginal Speculums 215
Mathieu-Kocher Needle Holders 412
Mathieu-Ryder Needle Holders 410
Mathieu-Stille Needle Holders 101
Mathieu-Vascular Needle Holders 412
Mayo Gall Duct Probes 197
Safety Pin 76
Scissors 35-37,408
Uterine Probes 224
Mayo-Adams Retractors 154
Mayo-Harrington Scissors 36,409
Mayo-Hegar Needle Holders 99,413
Mayo-Lexer Scissors 37,406
Mayo-Noble Scissors 36
Mayo-Robson Intestinal Clamps 180
Mayo-Stille Scissors 35,36,406
Mc Indoe Forceps 56
Tissue Forceps 64
Mc Kenty Raspatories 331
Mcintosh Laryngoscopes 10
Mead Bone Rongeurs 367
Mallets 348
Raspatories 333
Measuring Instruments 11
Medicine Cups 419
Membrane Puncturing Forceps 247
Meniscus Knives 378,379
Forceps 377
Mercedes Retractor 306
Metacarpal Saw 322
Metzenbaum Dissecting Scissors 26,38,407,408
Metzenbaum-Fino Dissecting Scissors 407,408
Meyer Reposition Forceps 357
Meyering Retractors 120,134

Michel Clip Applying and Removing Forceps 111
Rhinoscopic Mirrors 7
Micro Dissecting Scissors 23-25
Dissecting Scissors Bayonet Forceps 25
52,53
Jeweller Types Forceps 52
Ligature Forceps Bayonet 53-54,87
Needle Holders 96-97,420
Suture Tying Forceps 52
Micro-Adson Forceps 55,62,87
Micro-Halsted Delicate Forceps 79
Microscopic Forceps 55
Middeldorp Retractors 130
Mikulicz Forceps 86
Intestinal Spatula 149
Peritoneum Forceps 91
Retractors 144,145
Millum Knives 18
Miller Laryngoscopes 9
Rasps 340
Millin Bladder Neck Spreader 205
Bladder Retractors 204
Center Blade for Retractors 204
Ligature Holding Forceps 101
Lobe Grasping Forceps 205
Mills Gall Duct Scissors 194
Mirror Handles 7
Mirrors for Head light 4
Mixer Dissecting and Ligature Forceps 89,90,292
Gall Duct Forceps 195
Mixer-O'Shaughnessy Forceps 89
Modell Piccolo Cotton Applicators 109
Mod. USA Plaster Spreader 397
Modell Tubingen Retractors 135
Mollison Self-Retaining Retractors 154
Molt Raspatories 333
Moeltgen Goniometer 11
Moncorps Millum Knives 18
Mosquito Atraumata Forceps 267
Morris Anastomosis Clamps 186
Ascending Aorta Cross Clamps 276
Retractors 133
Morse Stomotomy Spreaders 304
Mouth Gags 6
Moynihan Forceps 88
Gall Stone Probes 197
Intestinal Clamps 179
Muehling Raspatories 335
Mueller Retractors 151
Multi-Purpose Clamps 283,286-287,289
Muller Fine Wound Retractors 117
Ligature Forceps 77
Micro Forceps 53
Micro Needle Holders 97
Vessel Clips 77
Murphy Head band 3
Murphy-Lane Luxation Levers 330
Museux Artery Traction Forceps 73
Tenaculum Forceps 230
Myoma Instruments 236
Screws 236
Myomatome 17,236
Myrtle Leaf Probes 108

N

Naegle Obstetrical Forceps 249
Nagel Micro Scissors 25
Nail Extraction Forceps 392
Scissors 49
Splitting Forceps 32,392

Nasal Scissors 41
Suction Tubes 402
Specula 187
Naujoks Wire Scissors 48
Needle Holders 96-101
Needle Holders With Tungsten Carbide Inserts 410-412
Needle Sterilizing Cases 423
Neff Meniscus Knives 378
Negus Tonsil Forceps 86
Nelaton Directors 107
Nelson Lung Dissecting Forceps 65
Lung Grasping Forceps 290
Trocars 208
Nelson-Metzenbaum Dissecting Scissors 38
Nerve and Vessel Hooks 115-116
Neubuser Tubal Seizing Forceps 236
Neuro-Surgery Scissors 40
Nissen Dissecting and Ligature Forceps 87
Gall Duct Forceps 194
Non-Traumatic Haemostatic Forceps 267,268
Norfolk and Norwich Retractors 155
Noto Ovum Forceps 231
Sponge Holding Forceps 71
Novak-Schockaert Endometrial Biopsy Curettes 237
Noyes Micro Spring Scissors 23
Nurse's Scissors 50
Nussbaum Intestinal Clamps 179

O

Obstetrical Forceps 247,249,250-254
Pelvimeters 246
Scissors 45,248
Obstetric Instruments 246-254
Ochsner Aorta Clamps 281
Gall Duct Probes 197
Ligature Forceps 58
Trocars 208
Oehler Dissecting Forceps 412
Oldberg Rongeurs 317
Olivecrona Bone Rongeurs 368
Dura Scissors 40
Trigeminal Knife 17
Wire Saws 323
Ombredanne Mallets 350
Operating Scissors 43,44,405
Organ and Grasping Forceps 70,71,74,170,171
Osteotomes 351-356
Osteophyte Rongeurs 318
Otoscope Complete Set 8
Battery Handle 8
Overholt Dissecting and Ligature Forceps 88
Overholt-Geissendoerfer Dissecting and Ligature Forceps 88
Overholt-Mixer Dissecting and Ligature Forceps 87
Ovum Curettes 243
Ovum Forceps 231,232

P

Parker Retractors 123
Parker-Kerr Anastomosis Clamps 184
Parry-Cooley Aorta Clamps 288
Parsch Chisels 352
Gouges 352
Raspatories 331
Parsch Mod. Lange Raspatories 331
Passow Tamper 351
Patent-Ductus Clamps 273,288
Patella Forceps 358
Paulsen Raspatories 332
Payr Guiding Probes 106
Intestinal and Pylorus Clamps 183

Pean Haemostatic Forceps 82-84,86
Haemostatic Forceps Atraumata 268
Kidney Clamps 86,200
Pederson Vaginal Speculums 211
Pedical Clamps 201
Peet Splinter Forceps 66
Pelkmann Uterine Dressing Forceps 225
Pelvimeters 246
Pelvis Retractors 148
Pennington Forceps 70
Percy Amputation Retractors 320
Perforator 254
Perkins Retractors 153
Peripheral-Vascular Clamps 274-275
Percussion Hammers 1
Pericostum Knife 319
Peritoneum Forceps 91
Pertuiset Carotid Clamps 294
Phalangeal Knife 319
Phaneuf Hysterectomy Forceps 92
Piccolo Cotton Applicators 108
Pierce Antrum Trocars 208
Pinard Stethoscopes 2
Piacenta and Ovum Curettes 243,252-254
Plaster Breakers 397
Instruments 393-397
Knives 393
Saw 393
Scissors 51,394
Shears 395,396
Spreaders 397
Pliester Retractors 153
Suction Tube 402
Pliers For Bending and Cutting Wires 387
Pocket Instrument Set 112-113
Polyaethylen Splint Material 236
Polypus and Ovum Forceps 231,232
Pool Suction Tube 400
Post Mortem Knives 13
Potts-De Martel Gall Bladder Scissors 196
Potts-Smith Forceps 409
Scissors 39,40
Pozzi Tenaculum Forceps 227
Pratt Organ Grasping Forceps 74
Rectal Specula 188
Pressure Clamps 94,184,193,276
Price Thomas Bronchus Forceps 295
Probes 106-109,385
Proctoscopes 189
Protection Caps (Steinmann Pins) 382
Providence-Hospital Delicate Forceps 79
Punches 310-312
Putti Bone File 341

Q

Quervain Bone Levers 324
Quinby Delicate Scissors 29

R

Rabner Percussion Hammer 1
Ragnell Scissors Flat Point 26,410
Rampley Sponge Holding Forceps 70
Randall Endometrial Biopsy Curettes 237
Kidney Stone Forceps 203
Rankin Delicate Forceps 80
Raspatories 331-338
Rasps 339-341
Razors 22
Blade Holders 19
Recamier Ovum Curettes 243
Uterine Curettes 241

Rectal Scissors	46
Speculas	187-188
Reill Cutting Pliers	389
Drilling Chucks	383
Reposition Forceps	357
Replacement Lamps	10
Reposition Forceps	357,358
Resection Knives	14,319
Retractors	5,117,148,151-160, 162-167,308
For Cervical Spine	159
For Cervical Vertebral Column	160
For Deep Surgery	134-135,144-145
With Triangle Handles	119
Reverdin Intestinal Spatula	150
Needles	102
Reynolds Dissecting Scissors	34
Rib Holding Forceps	297
Raspatories	298-299
Rongeurs	297
Shears	296
Spreaders	300-303,307
Ricard Abdominal Retractors	162
Richardson Retractors	132
Richardson-Eastman Retractors	132
Richter Vaginal Retractors	220
Ring Handle Bulldog Clamps	264,284
Robin Towel Clamps	76
Rochard Retractors	147
Rochester-Carmalt Haemostatic Forceps	86
Rochester-Ochsner Haemostatic Forceps	84
Rochester-Pean Haemostatic Forceps	83
Roeder Towel Clamps	75
Rohrschneider Needle Holder	96
Rollet Fine Wound Retractors	117
Rongeurs	313-318
Rose Retractors	123
Roser-Koenig Mouth Gag	6
Roetgen-Ruskin Bone Rongeurs	369
Round Bowls	425
Handle Needle Holders	97
Metal Boxes	424
Pliers	387
Roux Retractors	124
Rudd Haemorrhoidal Ligators	193
Rulers	11
Rumel Forceps	89
Rumel-Belmon Tourniquets	259
Ruskin Bone Rongeurs	369
Ruskin-Liston Bone Cutting Forceps	374
Russ-Modell Tissue Forceps	65
Rust Amputation Saws	321
Ryder Needle Holders	414
Ryder-Vascular Needle Holders	414

S

Saalfeld Knife	18
Saddle Hooks	119
Saenger Ovum Forceps	252,253
Safety Pins	76,406
Salenius Meniscus Knives	379
Salpingograph	260
Samii Tissue Grasping, Tumors Forceps	54
Sarot Needle Holders	410
Satinsky Anastomosis Clamps	293
Scissors	40
Satterlee Amputation Saws	322
Sauerbruch Retractors	129
Sterilizing Cases	423
Sauerbruch-Coryllis Rib Rongeurs	297
Saupe Cilia Forceps	66
Scalp Flap Forceps	251
Scalpel Handles	20,21
Knives	14,15,18
Scaphoid Gouges	351
Scapula Retractors	139,308
Schaaf Cilia Forceps	66
Schaedel Towel Clamps	75
Schede Bone Curettes	344
Scheinmann Biopsy Tip	240
Scherback Vaginal Speculums	219
Schimmelbusch Ether Mask	6
Schink Dermatomes	22
Schmid Irrigation Cannulae	257
Vascular Spatula	258
Schmieden Guiding Probes	106
Schmieden-Dick Ligature Needles	105
Schneider Pelvimeters	246
Raspatories	336
Schoemaker-Loth Needle Holder	100
Ligature Scissors	47
Schoenborn Retractors	122
Schroeder Organ Grasping Forceps	74
Tenaculum Forceps	227-229
Uterine Scoops	241
Schubert Biopsy Forceps	238
Schulz Biopptome	260
Schulze Salpingograph	245
Schumacher Biopsy Forceps	239
Biopsy Tips	240
Bone Levers	329
Sternum Shears	296
Umbilical Cord Scissors	45,248
Schumacher mod. Wagner Bone Levers	329
Schwarz Traction Bows	382
Scissors	23-51 407-408
With Tungsten Carbide Inserts	158
Scoville-Richter Self-Retaining Retractors	381
Screw Driver	182
Scudder Stomach Clamps	336
Sedillot Raspatories	17,236
Segond Myotomome	239
Seidl DBP Biopsy Forceps	211
Vaginal Specula	109
Seiffert Probes	363
Self Centering Forceps	151-156,158,256
Self Retaining Retractors	155-156
Laminectomy Retractors	307
Sellors Rib Spreader and Contractor	297,360
Semb Bone Holding Forceps	372
Bone Rongeurs	291
Dissecting and Ligature Forceps	299,337
Rib Raspatories	297
Rib Rongeurs	56,62,411
Semken Delicate Forceps	166
Semm Abdominal Retractors	210
Vaginal Speculums	123
Senn-Miller Retractors	359
Sequestrum Forceps	51,394
Seutin Plaster Scissors	332
Sewall Raspatories	210
Seyffert Vaginal Speculums	44
Siebold Uterine Scissors	185-186
Sigmoid Anastomosis Forceps	236
Silicone Operating Pad	22
Silver Dermatomes	241,346
Simon Bone Curettes/Scoops	121
Fistula Hooks	121,135
Retractors	48
Uterine Scoops	244
Wound Retractors	218
Simplex Cheek and Lip Retractor	5

Simon Bone Curettes/Scoops	241,346
Fistula Hooks	121
Retractors	121,135
Uterine Scoops	241
Wound Retractors	218
Simplex Cheek and Lip Retractor	5
Simpson Obstetrics Forceps	250
Uterine Probes	224
Simpson-Braun Obstetrics Forceps	249,250
Sims Gynaecological Scissors	43
Rectal Specula	187,188
Uterine Curettes	242
Uterine Probes	224
Vaginal Speculums	211
Sims-Maier Sponge Forceps	69
Sims-Siebold Uterine Scissors	44
Skin Retractors	117
Smellie Perforator	254
Smillie Meniscus Knives	379
Smith Bandage Scissors	49
Somer Elevating Forceps	234
Spatulas	109
Special Bone Levers	330
Retractors	157
Spencer Ligature Scissors	47
Spencer-Wells Haemostatic Forceps	83
Sphincteroscopes	189
Splint Guide	236
Splinter Forceps	66
Sponge Forceps	67-71 70-71
Holding Forceps	314,316,317
Spurling Rongeurs	418
Sputum Cup	148
St. Marks Retractors	62
St. Martin Forceps	109
Stacke Probes	373
Stamm Bone Cutting Forceps	57
Standard Dissecting Forceps	30,31,405
Scissors	63
Tissue Forceps	382
Steinmann Pins	365
Stellbrink Bone Rongeurs	46
Stelzner Rectal Scissors	424
Sterilizing Baskets/Trays	423
Cases	414
Drums	55,405
Forceps	208
Sternal Puncture Needle	05
Sternberg Cheek and Lip Retractor	123
Retractors	296
Sternum Instruments	304-305
Sternotomy Spreaders	02
Stethoscopes	26,33
Stevens Dissecting Scissors	417
Needle Holders	66
Stieglitz Splinter Forceps	370
Stille Bone Rongeurs	353
Chisels	37
Dissecting Scissors	353
Gouges	201
Kidney Clamps	353,354
Osteotomes	395,396
Plaster Shears	170
Stille-Barraya Dissecting Forceps	370
Stille-Ruskin Bone Rongeurs	182
Stomach Clamps	48
Strack Scissors	244
Strainer for Tissues	414
Stratle Needle Holders	65
Strassburger Tissue Forceps	234
Strassmann Elevating Forceps	40
Strully Scissors	280
Subramanian Aorta Clamps	309,400,401,404
Suction Cannula	244
Curettes	399
Handles	244
Hose Connection	309,398-404
Instruments	402
Raspatories	309,400-404
Tubes	30-32
Surgical Scissors	106
Suture Hook	102-104
Instruments	411
Scissors	112
Suture Instrument Sets	191
Swab Holder	58
Swedish Pattern Forceps	104
Syme Suture Needle	365
Synovectomy Rongeurs	347
Sypert Bone Curettes With Hartpress Handle	32,392
Systrunk Nail Splitting Scissors	330
Tager Special Bone Levers	313
Takahashi Rongeurs	351
Tampers	271-272
Tangential Occlusion Clamps	1
Taylor Percussion Hammer	229
Teale Tenaculum Forceps	121
Tendon Hooks	72
Interlacing Forceps	72
Seizing Forceps	14-15
Tenotomes	346
Tessier Bone Curettes	246
Thole Pelvimeter	238
Thoms-Gaylor Biopsy Forceps	306
Thoracic Retractors	40
Thorek Scissors	55
Thorpe Corneal Forceps	157,220
Thyroid and Vaginal Retractors	74
Tiemann Organ Grasping Forceps	62-65
Tissue Forceps	54,70,71,73,74, 168,170,171
Grasping Forceps	5
Tobold Tongue Depressor	34
Toennis Dissecting Scissors	117
Fine Wound Retractors	100
Needle Holders	258
Vascular Spatulas	34
Toennis-Adson Dissecting Scissors	5
Tongue Depressors	6
Forceps	259
Tourniquets	402
Tonsil Dissector	86
Forceps	17
Knives	41
Scissors	75,76
Towel Clamps	11
Townley Caliper	118
Trachea Retractors	256
Tracheal Dilators	256
Hooks	255
Tubes	382
Traction Bows	380
Hooks	4
Transformer	244
Transparent Suction Hose	331
Trelat Raspatories	17
Trigeminal Knife	208,398,399
Trocars	61
Troeltsch Forceps	1
Troemner Percussion Hammer	256
Trousseau Tracheal Dilators	256



Troutman-Chris Blade Holder 19
 Tubal Seizing Forceps 236
 Tubbs Aortic Dilators 260
 Tuffier Intestinal Spatula 150
 Rib Spreaders 300
 Tissue Grasping Forceps 168
 Tungsten Carbide Instruments 407-413
 Tunneling Instruments 261
 Turnable Biopsy Forceps 190
 Tuttle Lung Dissecting Forceps 65
 Lung Grasping Forceps 290

U

Ueckermann-Denker Cryochoyrotomy Trocar 255
 Uffendorde Bone Curettes 343
 Ultra-Light Forceps 59,172,262
 Umbilical Cord Scissors 45,248
 Universal Bandage Scissors 50
 Handle 240
 Trays 415
 Trocars 208
 Wire Cutting Scissors 48,388,413
 Unna Extractor 18
 Ureter Forceps 205
 Urethral Bougies Urinary Instruments 206
 Uterine Curettes 241,242
 Depressor 224
 Dilators 221,222
 Dressing Forceps 225,226
 Elevating Forceps 233-235
 Flushing Tube 245
 Probes 224
 Scissors 43,44,409
 Scoops 241
 Secretion Scoop 237
 Tenaculum Forceps 227-230
 US-Army Retractors 124

V

Vacuum Curettes 244,398
 Vaginal Clamps 93-94
 Retractors 157,217,218,220
 Speculas 209-219
 Vaginal and Wound Retractors 218
 Van Buren Bone Holding Forceps 359
 Vannas Micro Spring Scissors 23,24
 Vario Retractors 136,137,215
 Vascular Dilators 257
 Spatulas 258
 Vein Retractors 122
 Vena Cava Clamps 270,271,293
 Venae Sectio Set 113-114
 Verbrugge Bone Holding Forceps 363
 Verbrugge-Muller Bone Levers 328
 Vernier Caliper 11
 Vessel Clamps 292
 Hooks 115,116
 Irrigation Cannulae 257
 Scissors 39
 Vienna Nasal Specula 187
 Vidal Lupus Scraper 18
 Virchow Knife 13
 Vise Grip Pliers 387
 Micro Forceps 52
 Volkman Bone Curettes 342,344
 Bone Retractors 125,126

W

Wachenfeldt Clip Applying Forceps 111
 Wagoner Vessel Hooks 115
 Wagner Bone Levers 327
 Mallets 349
 Meniscus Knives 378
 Raspatories With Hartpress Handle 338
 Rongeurs 318

Walb Knife 13
 Walker Gouges 353
 Wangenstein Forceps 409
 Intestinal Grasping Forceps 170
 Needle Holders 99
 1 1
 Wartenberg Pinwheel 64
 Waugh Tissue Forceps 282
 Weber Aorta-Anastomosis Clamps 98
 Webster Needle Holders 23
 Wecker Eye Scissors 313
 Weil-Blakesley Rongeurs 217
 Weissbarth Vaginal Speculum 152-153
 Wellner Self-Retaining Retractors 377
 Weller Meniscus and Cartilage Forceps 275
 Wertheim Anastomosis Clamps 92-95,201
 Clamps and Forceps 43,409
 Gynaecological Scissors 92
 Hysterectomy Forceps 93
 Parametrium Clamps 95
 Wertheim-Cullen Clamps and Forceps 5
 Wieder Tongue Depressor 106
 Wiener Modell Suture Hooks 291
 Wikstrom Dissecting and Ligature Forceps 61
 Wilde Forceps 251
 Willett Scalp Flap Forceps 170
 Williams Intestinal Grasping Forceps 290
 Lung Grasping Forceps 342,344
 Williger Bone Curettes 324
 Elevators 331
 Raspatories 120
 Retractors 252
 Winter Ovum Forceps 385
 Wire Catcher 388
 Cutters 387,389-391
 Cutting Pliers 48,388,408
 Cutting Scissors 380,381
 Extensions 384
 Guides 386,387
 Holding Forceps 323
 Saws 380,383,385
 Tightener 386
 Tightening Pliers 380,381
 Traction Bow 385
 Twister 207
 Winkelmann Circumcision Clamps 397
 Wolff Plaster Breakers 117-118,122
 Wound Retractors 256
 Wound and Tracheal Hooks 380
 Wrenches 250
 Wrigley Obstetrics Forceps 153
 Wullstein Self-Retaining Retractors 403
 Suction Tube

Y

Yankauer Suction Cannulae 309,401
 Yasargil Ligature Forceps 53,87
 Micro Forceps 53
 Micro Needle Holders 96,97,420
 Micro Scissors Bayonet 25
 Rongeurs 317
 Suction Cannulae 309,403,404
 Tumor & Vessel Forceps 54
 Yasargil-Samii Tissue Grasping Forceps 54
 Yeoman Biopsy Forceps 190
 Young Tongue Forceps 6
 Young-Hrytschak Needle Holder 101
 Young-Milin Boomerang Needle Holder 101

Z

Zenker Forceps 89
 Retractor 139
 Ziegler Head Band 3
 Head Mirror 3
 Millum Knives 18
 Zielke Gouges 355