



Chapter 19

Current Electricity

Electric Current

(1) The time rate of flow of charge through any cross-section is called current. $i = \lim_{\Delta t \rightarrow 0} \frac{\Delta Q}{\Delta t} = \frac{dQ}{dt}$. If flow is uniform then $i = \frac{Q}{t}$. Current is a scalar quantity. It's S.I. unit is *ampere* (A) and C.G.S. unit is *emu* and is called *biot (Bi)*, or *ab ampere*. $1A = (1/10) Bi$ (ab amp.)

(2) *Ampere* of current means the flow of 6.25×10^{18} *electrons/sec* through any cross-section of the conductor.

(3) The conventional direction of current is taken to be the direction of flow of positive charge, *i.e.* field and is opposite to the direction of flow of negative charge.

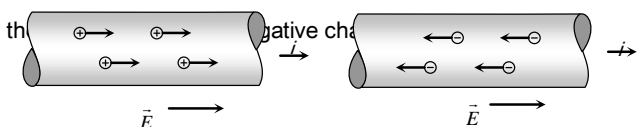

Fig. 19.1

(4) The net charge in a current carrying conductor is zero.

(5) For a given conductor current does not change with change in cross-sectional area. In the following figure $i_1 = i_2 = i_3$

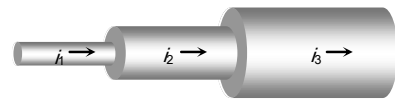

Fig. 19.2

(6) **Current due to translatory motion of charge :** If n particle each having a charge q , pass

through a given area in time t then $i = \frac{nq}{t}$

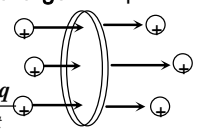
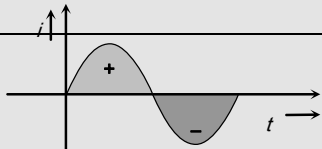
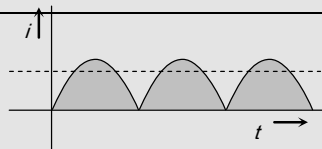
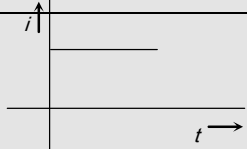

Fig. 19.3



If n particles each having a charge q pass per second per unit area, the current associated with cross-sectional area A is $i = nqA$

If there are n particle per unit volume each having a charge q and moving with velocity v , the current through, cross section A is $i = nqvA$

Table : 19.1 Types of current

Alternating current (ac)	Direct current (dc)	
(i) 	(i) (Pulsating dc) 	(Constant dc) 

2 Current Electricity

	Magnitude and direction both varies with time	
ac → Rectifier → dc		dc → Inverter → ac
(ii) Shows heating effect only		(ii) Shows heating effect, chemical effect and magnetic effect of current
(iii) It's symbol is 		(iii) It's symbol is 

(7) **Current due to rotatory motion of charge** : If a point charge q is moving in a circle of radius r with speed v (frequency ν , angular speed ω and time period T) then corresponding current $i = qv = \frac{q}{T} = \frac{qv}{2\pi r} = \frac{q\omega}{2\pi}$

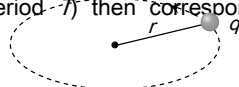

Fig. 19.4

(8) **Current carriers** : The charged particles whose flow in a definite direction constitutes the electric current are called current carriers. In different situation current carriers are different.

(i) Solids : In solid conductors like metals current carriers are free electrons.

(ii) Liquids : In liquids current carriers are positive and negative ions.

(iii) Gases : In gases current carriers are positive ions and free electrons.

(iv) Semi conductor : In semi conductors current carriers are holes and free electrons.

Current Density (J)

Current density at any point inside a conductor is defined as a vector having magnitude equal to current per unit area surrounding that point. Remember area is normal to the direction of charge flow (or current passes) through that point.

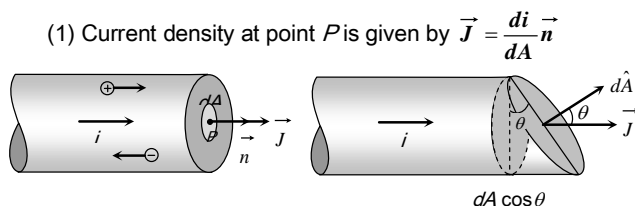

Fig. 19.5

(2) If the cross-sectional area is not normal to the current, but makes an angle θ with the direction of current then

$$J = \frac{di}{dA \cos \theta} \Rightarrow di = J dA \cos \theta = \vec{J} \cdot d\vec{A} \Rightarrow i = \int \vec{J} \cdot d\vec{A}$$

(3) If current density \vec{J} is uniform for a normal cross-section \vec{A} then $\vec{J} = \frac{i}{A}$

(4) Current density \vec{J} is a vector quantity. It's direction is same as that of \vec{E} . It's S.I. unit is amp/m^2 and dimension $[L^{-2}A]$.

(5) In case of uniform flow of charge through a cross-section normal to it as $i = nqvA \Rightarrow J = \frac{i}{A} = nqv$.

(6) Current density relates with electric field as $\vec{J} = \sigma \vec{E} = \frac{\vec{E}}{\rho}$; where σ = conductivity and ρ = resistivity or specific resistance of substance.

Drift Velocity

Drift velocity is the average uniform velocity acquired by free electrons inside a metal by the application of an electric field which is responsible for current through it. Drift velocity is very small it is of the order of 10^{-4} m/s as compared to thermal speed ($\approx 10^5 \text{ m/s}$) of electrons at room temperature.

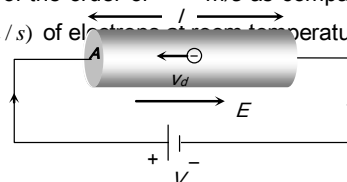

Fig. 19.6

metallic lattice is defined as relaxation time $\tau = \frac{\text{mean free path}}{\text{r.m.s. velocity of electrons}} = \frac{\lambda}{v_{rms}}$. With rise in temperature v_{rms} increases consequently τ decreases.

(2) **Mobility** : Drift velocity per unit electric field is called mobility of electron *i.e.* $\mu = \frac{v_d}{E}$. It's unit is $\frac{m^2}{\text{volt-sec}}$.

Ohm's Law

If the physical conditions of the conductor (length, temperature, mechanical strain etc.) remains some, then the current flowing through the conductor is directly proportional to the potential difference across it's two ends *i.e.* $i \propto V \Rightarrow V = iR$ where R is a proportionality constant, known as electric resistance.

(1) Ohm's law is not a universal law, the substances, which obey ohm's law are known as ohmic substance.

(2) Graph between V and i for a metallic conductor is a straight line as shown. At different temperatures $V-i$ curves are different

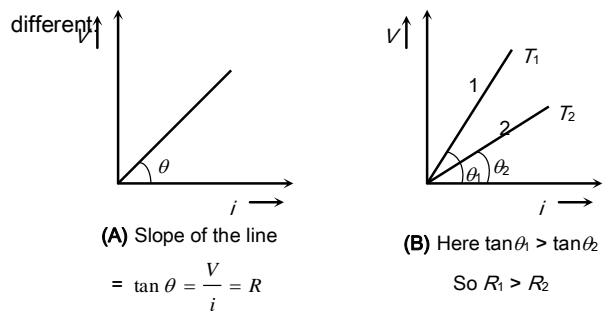

Fig. 19.9

(3) The device or substances which don't obey ohm's law *e.g.* gases, crystal rectifiers, thermoionic valve, transistors etc. are known as non-ohmic or non-linear conductors. For these $V-i$ curve is not linear.

Static resistance $R_{st} = \frac{V}{i} = \frac{1}{\tan \theta}$

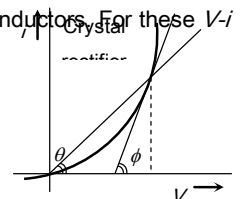

Fig. 19.10

If suppose for a conductor

n = Number of electron per unit volume of the conductor

A = Area of cross-section

V = potential difference across the conductor

E = electric field inside the conductor

i = current, J = current density, ρ = specific resistance, σ = conductivity ($\sigma = \frac{1}{\rho}$) then current relates with drift velocity as

$i = neAv_d$ we can also write

$$v_d = \frac{i}{neA} = \frac{J}{ne} = \frac{\sigma E}{ne} = \frac{E}{\rho ne} = \frac{V}{\rho l ne}$$

(1) The direction of drift velocity for electron in a metal is opposite to that of applied electric field (*i.e.* current density \vec{J}).

$v_d \propto E$ *i.e.*, greater the electric field, larger will be the drift velocity.

(2) When a steady current flows through a conductor of non-uniform cross-section drift velocity varies inversely with area of cross-section ($v_d \propto \frac{1}{A}$)

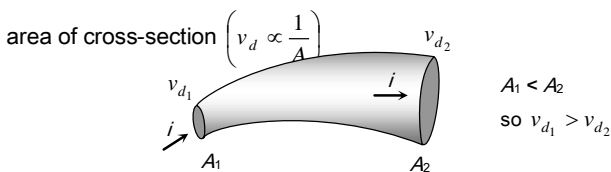

Fig. 19.7

(3) If diameter (d) of a conductor is doubled, then drift velocity of electrons inside it will not change.

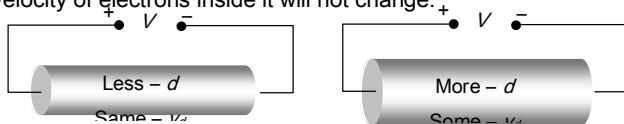

Fig. 19.8

(1) **Relaxation time (τ)** : The time interval between two successive collisions of electrons with the positive ions in the

1040 Current Electricity

$$\text{Dynamic resistance } R_{dyn} = \frac{\Delta V}{\Delta I} = \frac{1}{\tan \phi}$$

Resistance

(1) The property of substance by virtue of which it opposes the flow of current through it, is known as the resistance.

(2) **Formula of resistance** : For a conductor if l = length of a conductor A = Area of cross-section of conductor, n = No. of free electrons per unit volume in conductor, τ = relaxation time then resistance of conductor $R = \rho \frac{l}{A} = \frac{m}{ne^2 \tau} \cdot \frac{l}{A}$; where ρ = resistivity of the material of conductor

(3) **Unit and dimension** : It's S.I. unit is *Volt/Amp.* or *Ohm* (Ω).

$$\text{Also } 1 \text{ ohm} = \frac{1 \text{ volt}}{1 \text{ Amp}} = \frac{10^8 \text{ emu of potential}}{10^{-1} \text{ emu of current}} = 10^9 \text{ emu of}$$

resistance. It's dimension is $[ML^2T^{-3}A^{-2}]$.

(4) **Dependence of resistance** : Resistance of a conductor depends upon the following factors.

(i) Length of the conductor : Resistance of a conductor is directly proportional to it's length *i.e.* $R \propto l$ and inversely proportional to it's area of cross-section *i.e.* $R \propto \frac{1}{A}$

(ii) Temperature : For a conductor

Resistance \propto **temperatur e** .

If R_0 = resistance of conductor at $0^\circ C$

R_t = resistance of conductor at $t^\circ C$

and α, β = temperature co-efficient of resistance

then $R_t = R_0(1 + \alpha t + \beta t^2)$ for $t > 300^\circ C$ and

$$R_t = R_0(1 + \alpha t) \text{ for } t \leq 300^\circ C \text{ or } \alpha = \frac{R_t - R_0}{R_0 \times t}$$

If R_1 and R_2 are the resistances at $t_1^\circ C$ and $t_2^\circ C$ respectively then $\frac{R_1}{R_2} = \frac{1 + \alpha t_1}{1 + \alpha t_2}$.

The value of α is different at different temperature. Temperature coefficient of resistance averaged over the temperature range $t_1^\circ C$ to $t_2^\circ C$ is given by $\alpha = \frac{R_2 - R_1}{R_1(t_2 - t_1)}$ which

gives $R_2 = R_1 [1 + \alpha (t_2 - t_1)]$. This formula gives an approximate value.

Table 19.2 : Variation of resistance of some electrical material with temperature

Material	Temp. coefficient of resistance (α)	Variation of resistance with temperature rise
Metals	Positive	Increases
Solid non-metal	Zero	Independent
Semi-conductor	Negative	Decreases
Electrolyte	Negative	Decreases
Ionised gases	Negative	Decreases
Alloys	Small positive value	Almost constant

Resistivity (ρ), Conductivity (σ) and Conductance (C)

(1) **Resistivity** : From $R = \rho \frac{l}{A}$; If $l = 1m$, $A = 1m^2$ then $R = \rho$ *i.e.* resistivity is numerically equal to the resistance of a substance having unit area of cross-section and unit length.

(i) Unit and dimension : It's S.I. unit is *ohm* \times *m* and dimension is $[ML^3T^{-3}A^{-2}]$

(ii) It's formula : $\rho = \frac{m}{ne^2 \tau}$

(iii) Resistivity is the intrinsic property of the substance. It is independent of shape and size of the body (*i.e.* l and A).

(iv) For different substances their resistivity is also different *e.g.* $\rho_{\text{silver}} = \text{minimum} = 1.6 \times 10^{-8} \Omega\text{-m}$ and $\rho_{\text{fused quartz}} = \text{maximum} \approx 10^{16} \Omega\text{-m}$

$$\rho_{\text{insulator}} \text{ (Maximum for fused quartz)} > \rho_{\text{alloy}} > \rho_{\text{semi-conductor}} > \rho_{\text{conductor}} \text{ (Minimum for silver)}$$

(v) Resistivity depends on the temperature. For metals $\rho_t = \rho_0(1 + \alpha \Delta t)$ *i.e.* resistivity increases with temperature.

(vi) Resistivity increases with impurity and mechanical stress.

(vii) Magnetic field increases the resistivity of all metals except iron, cobalt and nickel.

(viii) Resistivity of certain substances like selenium, cadmium, sulphides is inversely proportional to intensity of light falling upon them.

(2) **Conductivity** : Reciprocal of resistivity is called conductivity (σ) i.e. $\sigma = \frac{1}{\rho}$ with unit *mho/m* and dimensions $[M^{-1}L^{-3}T^3A^2]$.

(3) **Conductance** : Reciprocal of resistance is known as conductance. $C = \frac{1}{R}$ It's unit is $\frac{1}{\Omega}$ or Ω^{-1} or "Siemen".

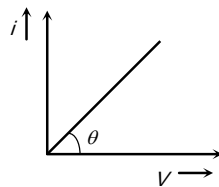

Fig. 19.11

Stretching of Wire

If a conducting wire stretches, it's length increases, area of cross-section decreases so resistance increases but volume remain constant.

Suppose for a conducting wire before stretching it's length = l_1 , area of cross-section = A_1 , radius = r_1 , diameter = d_1 , and resistance $R_1 = \rho \frac{l_1}{A_1}$

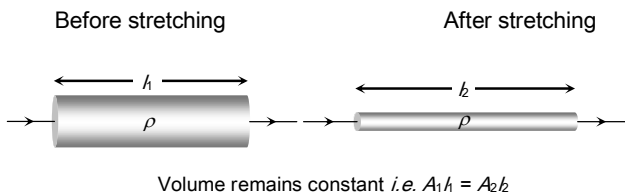

Fig. 19.12

After stretching length = l_2 , area of cross-section = A_2 , radius = r_2 , diameter = d_2 and resistance = $R_2 = \rho \frac{l_2}{A_2}$

Ratio of resistances before and after stretching

$$\frac{R_1}{R_2} = \frac{l_1}{l_2} \times \frac{A_2}{A_1} = \left(\frac{l_1}{l_2}\right)^2 = \left(\frac{A_2}{A_1}\right)^2 = \left(\frac{r_2}{r_1}\right)^4 = \left(\frac{d_2}{d_1}\right)^4$$

(1) If length is given then $R \propto l^2 \Rightarrow \frac{R_1}{R_2} = \left(\frac{l_1}{l_2}\right)^2$

(2) If radius is given then $R \propto \frac{1}{r^4} \Rightarrow \frac{R_1}{R_2} = \left(\frac{r_2}{r_1}\right)^4$

Electrical Conducting Materials For Specific Use

(1) **Filament of electric bulb** : Is made up of tungsten which has high resistivity, high melting point.

(2) **Element of heating devices (such as heater, geyser or press)** : Is made up of nichrome which has high resistivity and high melting point.

(3) **Resistances of resistance boxes (standard resistances)** : Are made up of alloys (manganin, constantan or nichrome) these materials have moderate resistivity which is practically independent of temperature so that the specified value of resistance does not alter with minor changes in temperature.

(4) **Fuse-wire** : Is made up of tin-lead alloy (63% tin + 37% lead). It should have low melting point and high resistivity. It is used in series as a safety device in an electric circuit and is designed so as to melt and thereby open the circuit if the current exceeds a predetermined value due to some fault. The function of a fuse is independent of its length.

Safe current of fuse wire relates with it's radius as $i \propto r^{3/2}$.

(5) **Thermistors** : A thermistor is a heat sensitive resistor usually prepared from oxides of various metals such as nickel, copper, cobalt, iron etc. These compounds are also semiconductor. For thermistors α is very high which may be positive or negative. The resistance of thermistors changes very rapidly with change of temperature.

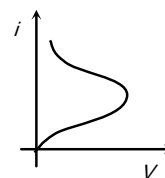

Fig. 19.13

Thermistors are used to detect small temperature change and to measure very low temperature.

Colour Coding of Resistance

To know the value of resistance colour code is used. These code are printed in form of set of rings or strips. By reading the values of colour bands, we can estimate the value of resistance.

The carbon resistance has normally four coloured rings or bands as shown in following figure.

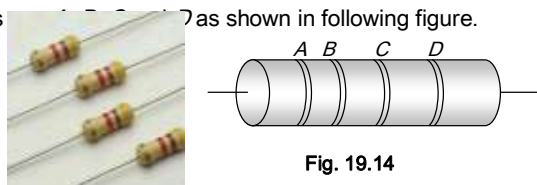

Fig. 19.14

Colour band A and B : Indicate the first two significant figures of resistance in *ohm*.

Band C : Indicates the decimal multiplier *i.e.* the number of zeros that follows the two significant figures *A* and *B*.

Band D : Indicates the tolerance in percent about the indicated value or in other words it represents the percentage accuracy of the indicated value.

The tolerance in the case of gold is $\pm 5\%$ and in silver is $\pm 10\%$. If only three bands are marked on carbon resistance, then it indicate a tolerance of 20%.

Table 19.3 : Colour code for carbon resistance

Letters as an aid to memory	Colour	Figure (A, B)	Multiplier (C)
B	Black	0	10^0
B	Brown	1	10^1
R	Red	2	10^2

O	Orange	3	10^3
Y	Yellow	4	10^4
G	Green	5	10^5
B	Blue	6	10^6
V	Violet	7	10^7
G	Grey	8	10^8
W	White	9	10^9

To remember the sequence of colour code following sentence should be kept in memory.

B B R O Y Great Britain Very Good Wife.

Grouping of Resistance

(1) Series grouping

(i) Same current flows through each resistance but potential difference distributes in the ratio of resistance *i.e.* $V \propto R$

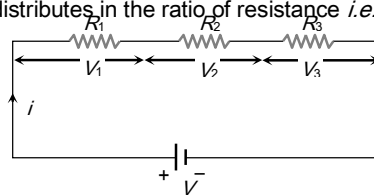

Fig. 19.15

(ii) $R_{eq} = R_1 + R_2 + R_3$ equivalent resistance is greater than the maximum value of resistance in the combination.

(iii) If *n* identical resistance are connected in series $R_{eq} = nR$ and potential difference across each resistance

$$V' = \frac{V}{n}$$

(2) Parallel grouping

(i) Same potential difference appeared across each resistance but current distributes in the reverse ratio of their resistance

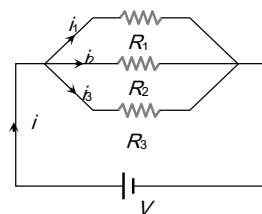

Fig. 19.16

i.e. $i \propto \frac{1}{R}$

(ii) Equivalent resistance is given by $\frac{1}{R_{eq}} = \frac{1}{R_1} + \frac{1}{R_2} + \frac{1}{R_3}$

or $R_{eq} = (R_1^{-1} + R_2^{-1} + R_3^{-1})^{-1}$ or $R_{eq} = \frac{R_1 R_2 R_3}{R_1 R_2 + R_2 R_3 + R_3 R_1}$

Equivalent resistance is smaller than the minimum value of resistance in the combination.

(iv) If two resistance in parallel

$$R_{eq} = \frac{R_1 R_2}{R_1 + R_2} = \frac{\text{Multiplication}}{\text{Addition}}$$

(v) Current through any resistance

$$i' = i \times \left[\frac{\text{Resistance of opposite branch}}{\text{Total resistance}} \right]$$

Where i = required current (branch current),

i = main current

$$i_1 = i \left(\frac{R_2}{R_1 + R_2} \right)$$

$$\text{and } i_2 = i \left(\frac{R_1}{R_1 + R_2} \right)$$

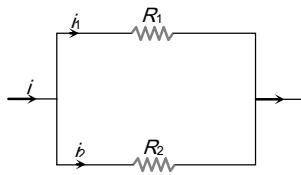

Fig. 19.17

(vi) In n identical resistance are connected in parallel

$$R_{eq} = \frac{R}{n} \text{ and current through each resistance } i' = \frac{i}{n}$$

Cell



The device which converts chemical energy into electrical energy is known as electric cell. Cell is a source of constant emf but not constant current.

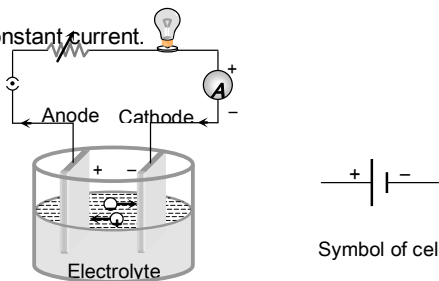

Fig. 19.18

(1) **Emf of cell (\mathcal{E})** : The potential difference across the terminals of a cell when it is not supplying any current is called it's emf.

(2) **Potential difference (V)** : The voltage across the terminals of a cell when it is supplying current to external resistance is called potential difference or terminal voltage. Potential difference is equal to the product of current and resistance of that given part *i.e.* $V = iR$.

(3) **Internal resistance (r)** : In case of a cell the opposition of electrolyte to the flow of current through it is called internal resistance of the cell. The internal resistance of a cell depends on the distance between electrodes ($r \propto d$), area of electrodes [$r \propto (1/A)$] and nature, concentration ($r \propto C$) and temperature of electrolyte [$r \propto (1/\text{temp.})$].

A cell is said to be ideal, if it has zero internal resistance.

Cell in Various Positions

(1) **Closed circuit** : Cell supplies a constant current in the circuit.

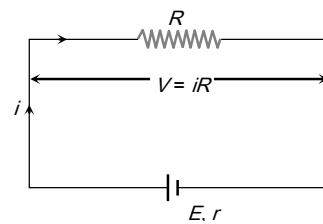

Fig. 19.19

(i) Current given by the cell $i = \frac{E}{R + r}$

(ii) Potential difference across the resistance $V = iR$

(iii) Potential drop inside the cell = ir

(iv) Equation of cell $E = V + ir$ ($E > V$)

(v) Internal resistance of the cell $r = \left(\frac{E}{V} - 1 \right) \cdot R$

(vi) Power dissipated in external resistance (load)

1044 Current Electricity

$$P = Vi = i^2 R = \frac{V^2}{R} = \left(\frac{E}{R+r} \right)^2 R$$

Power delivered will be maximum when $R = r$ so

$$P_{\max} = \frac{E^2}{4r}$$

This statement in generalised form is called “*maximum power transfer theorem*”.

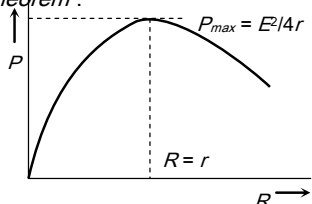

Fig. 19.20

(vii) When the cell is being charged *i.e.* current is given to the cell then $E = V - ir$ and $E < V$.

(2) **Open circuit** : When no current is taken from the cell it is said to be in open circuit

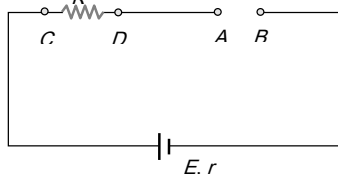

Fig. 19.21

- (i) Current through the circuit $i = 0$
- (ii) Potential difference between A and B, $V_{AB} = E$
- (iii) Potential difference between C and D, $V_{CD} = 0$

(3) **Short circuit** : If two terminals of cell are join together by a thick conducting wire

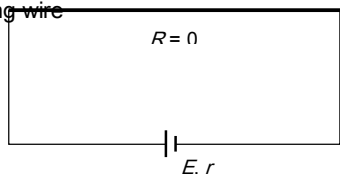

Fig. 19.22

(i) Maximum current (called short circuit current) flows

$$\text{momentarily } i_{sc} = \frac{E}{r}$$

(ii) Potential difference $V = 0$

Grouping of Cells



Group of cell is called a battery.

In series grouping of cell's their emf's are additive or subtractive while their internal resistances are always additive. If dissimilar plates of cells are connected together their emf's are added to each other while if their similar plates are connected together their emf's are subtractive.



Fig. 19.23

(1) **Series grouping** : In series grouping anode of one cell is connected to cathode of other cell and so on. If n identical cells are connected in series

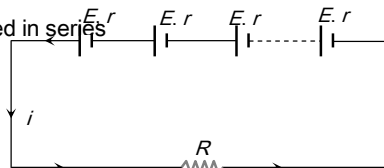

Fig. 19.24

- (i) Equivalent emf of the combination $E_{eq} = nE$
- (ii) Equivalent internal resistance $r_{eq} = nr$
- (iii) Main current = Current from each cell $= i = \frac{nE}{R + nr}$
- (iv) Potential difference across external resistance $V = iR$

- (v) Potential difference across each cell $V' = \frac{V}{n}$
- (vi) Power dissipated in the external circuit $= \left(\frac{nE}{R + nr} \right)^2 \cdot R$
- (vii) Condition for maximum power $R = nr$ and $P_{\max} = n \left(\frac{E^2}{4r} \right)$
- (viii) This type of combination is used when $nr \ll R$.

(2) **Parallel grouping** : In parallel grouping all anodes are connected at one point and all cathode are connected together at other point. If n identical cells are connected in parallel

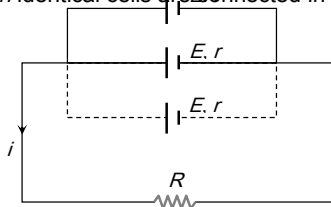

Fig. 19.25

- (i) Equivalent emf $E_{eq} = E$
- (ii) Equivalent internal resistance $R_{eq} = r/n$
- (iii) Main current $i = \frac{E}{R + r/n}$
- (iv) potential difference across external resistance = p.d. across each cell $= V = iR$
- (v) Current from each cell $i' = \frac{i}{n}$
- (vi) Power dissipated in the circuit $P = \left(\frac{E}{R + r/n} \right)^2 \cdot R$
- (vii) Condition for max. power is $R = r/n$ and $P_{\max} = n \left(\frac{E^2}{4r} \right)$
- (viii) This type of combination is used when $nr \gg R$

(3) **Mixed Grouping** : If n identical cell's are connected in a row and such m row's are connected in parallel as shown.

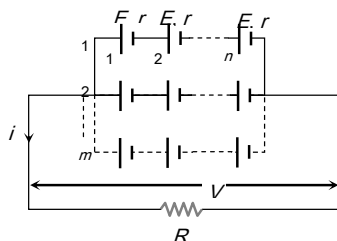

Fig. 19.26

- (i) Equivalent emf of the combination $E_{eq} = nE$
- (ii) Equivalent internal resistance of the combination $r_{eq} = \frac{nr}{m}$
- (iii) Main current flowing through the load $i = \frac{nE}{R + \frac{nr}{m}} = \frac{mnE}{mR + nr}$
- (iv) Potential difference across load $V = iR$
- (v) Potential difference across each cell $V' = \frac{V}{n}$
- (vi) Current from each cell $i' = \frac{i}{n}$
- (vii) Condition for maximum power $R = \frac{nr}{m}$ and $P_{\max} = (mn) \frac{E^2}{4r}$
- (viii) Total number of cell $= mn$

Kirchoff's Laws

(1) **Kirchoff's first law** : This law is also known as junction rule or current law (KCL). According to it the algebraic sum of currents meeting at a junction is zero i.e. $\sum i = 0$.

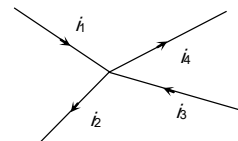

Fig. 19.27

In a circuit, at any junction the sum of the currents entering the junction must equal the sum of the currents leaving the junction. $i_1 + i_3 = i_2 + i_4$

(ii) This law is simply a statement of "conservation of charge".

(2) **Kirchoff's second law** : This law is also known as loop rule or voltage law (KVL) and according to it "the algebraic sum of the changes in potential in complete traversal of a mesh (closed loop) is zero", i.e. $\sum V = 0$

- (i) This law represents "conservation of energy".
- (ii) If there are n meshes in a circuit, the number of independent equations in accordance with loop rule will be $(n - 1)$.

(3) **Sign convention for the application of Kirchoff's law** :
For the application of Kirchoff's laws following sign convention are to be considered

(i) The change in potential in traversing a resistance in the direction of current is $-iR$ while in the opposite direction $+iR$

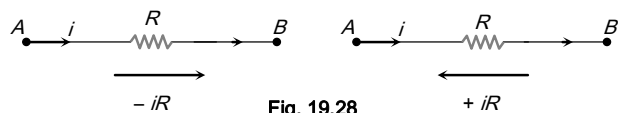

Fig. 19.28

(ii) The change in potential in traversing an emf source from negative to positive terminal is $+E$ while in the opposite direction $-E$ irrespective of the direction of current in the circuit.

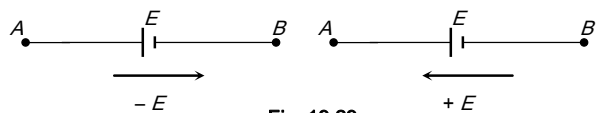

Fig. 19.29

(iii) The change in potential in traversing a capacitor from the negative terminal to the positive terminal is $+\frac{q}{C}$ while in opposite direction $-\frac{q}{C}$.

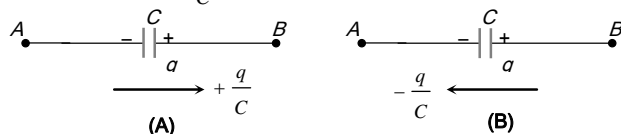

Fig. 19.30

(iv) The change in voltage in traversing an inductor in the direction of current is $-L \frac{di}{dt}$ while in opposite direction it is

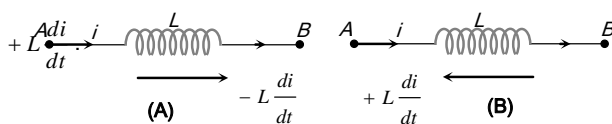

Fig. 19.31

Different Measuring Instruments



(1) **Galvanometer** : It is an instrument used to detect small current passing through it by showing deflection. Galvanometers are of different types e.g. moving coil galvanometer, moving magnet galvanometer, hot wire galvanometer. In dc circuit usually moving coil galvanometer are used.

(i) **It's symbol** : ; where G is the total internal resistance of the galvanometer.

(ii) **Full scale deflection current** : The current required for full scale deflection in a galvanometer is called full scale deflection current and is represented by i_g .

(iii) **Shunt** : The small resistance connected in parallel to galvanometer coil, in order to control current flowing through the galvanometer is known as shunt.

Table 19.4 : Merits and demerits of shunt

Merits of shunt	Demerits of shunt

To protect the galvanometer coil from burning	Shunt resistance decreases the sensitivity of galvanometer.
It can be used to convert any galvanometer into ammeter of desired range.	

(2) **Ammeter** : It is a device used to measure current and is always connected in series with the 'element' through which current is to be measured.

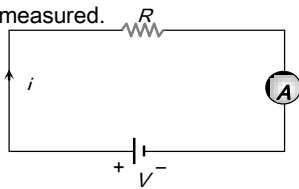

Fig. 19.32

(i) The reading of an ammeter is always lesser than actual current in the circuit.

(ii) Smaller the resistance of an ammeter more accurate will be its reading. An ammeter is said to be ideal if its resistance r is zero.

(iii) **Conversion of galvanometer into ammeter** : A galvanometer may be converted into an ammeter by connecting a low resistance (called shunt S) in parallel to the galvanometer G as shown in figure.

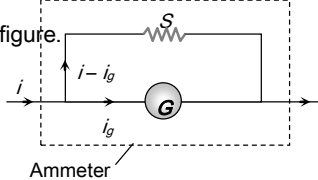

Fig. 19.33

(a) Equivalent resistance of the combination = $\frac{GS}{G+S}$

(b) G and S are parallel to each other hence both will have equal potential difference *i.e.* $i_g G = (i - i_g) S$; which gives

Required shunt $S = \frac{i_g}{(i - i_g)} G$

(c) To pass n th part of main current (*i.e.* $i_g = \frac{i}{n}$) through the galvanometer, required shunt $S = \frac{G}{(n-1)}$.

(3) **Voltmeter** : It is a device used to measure potential difference and is always put in parallel with the 'circuit element' across which potential difference is to be measured.

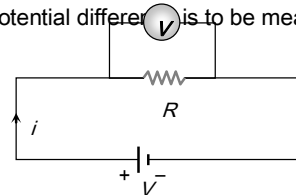

Fig. 19.34

(i) The reading of a voltmeter is always lesser than true value.

(ii) Greater the resistance of voltmeter, more accurate will be its reading. A voltmeter is said to be ideal if its resistance is infinite, *i.e.*, it draws no current from the circuit element for its operation.

(iii) **Conversion of galvanometer into voltmeter** : A galvanometer may be converted into a voltmeter by connecting a large resistance R in series with the galvanometer as shown in the figure.

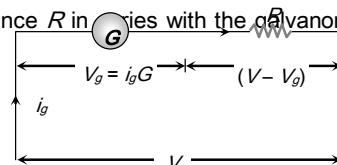

Fig. 19.35

(a) Equivalent resistance of the combination = $G + R$

(b) According to ohm's law $V = i_g (G + R)$; which gives

Required series resistance $R = \frac{V}{i_g} - G = \left(\frac{V}{V_g} - 1 \right) G$

(c) If n th part of applied voltage appeared across galvanometer (*i.e.* $V_g = \frac{V}{n}$) then required series resistance

$R = (n - 1) G$.

(4) Wheatstone bridge

: Wheatstone bridge is an arrangement of four resistance which can be used to measure one of them in terms of rest. Here arms AB and BC are called ratio arm and arms AC and BD are called conjugate arms

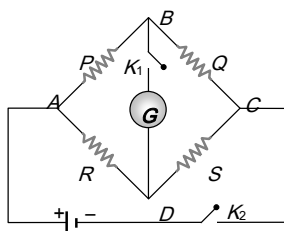

Fig. 19.36

(i) **Balanced bridge** : The bridge is said to be balanced when deflection in galvanometer is zero *i.e.* no current flows through the galvanometer or in other words $V_B = V_D$. In the balanced condition $\frac{P}{Q} = \frac{R}{S}$, on mutually changing the position of cell and galvanometer this condition will not change.

(ii) **Unbalanced bridge** : If the bridge is not balanced current will flow from D to B if $V_D > V_B$ *i.e.* $(V_A - V_D) < (V_A - V_B)$ which gives $PS > RQ$.

(iii) **Applications of wheatstone bridge** : Meter bridge, post office box and Carey Foster bridge are instruments based on the principle of wheatstone bridge and are used to measure unknown resistance.

(5) **Meter bridge** : In case of meter bridge, the resistance wire AC is 100 cm long. Varying the position of tapping point B , bridge is balanced. If in balanced position of bridge $AB = l$, BC $(100 - l)$ so that $\frac{P}{Q} = \frac{l}{100 - l}$. Also $\frac{P}{Q} = \frac{R}{S} \Rightarrow S = \frac{(100 - l)}{l} R$

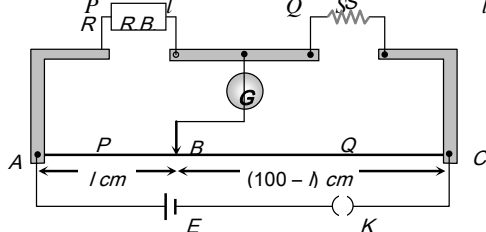

Fig. 19.37

Potentiometer

Potentiometer is a device mainly used to measure emf of a given cell and to compare emf's of cells. It is also used to measure internal resistance of a given cell.

(1) **Circuit diagram** : Potentiometer consists of a long resistive wire AB of length L (about 6 m to 10 m long) made up of mangnine or constantan and a battery of known voltage e and internal resistance r called supplier battery or driver cell. Connection of these two forms primary circuit.

One terminal of another cell (whose emf E is to be measured) is connected at one end of the main circuit and the other terminal at any point on the resistive wire through a galvanometer G . This forms the secondary circuit. Other details are as follows

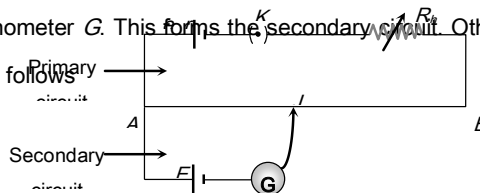

Fig. 19.38

J = Jockey

K = Key

R = Resistance of potentiometer wire,

ρ = Specific resistance of potentiometer wire.

R_h = Variable resistance which controls the current through the wire AB

(i) The specific resistance (ρ) of potentiometer wire must be high but its temperature coefficient of resistance (α) must be low.

(ii) All higher potential points (terminals) of primary and secondary circuits must be connected together at point A and all lower potential points must be connected to point B or jockey.

(iii) The value of known potential difference must be greater than the value of unknown potential difference to be measured.

(iv) The potential gradient must remain constant. For this the current in the primary circuit must remain constant and the jockey must not be slid in contact with the wire.

(v) The diameter of potentiometer wire must be uniform everywhere.

(2) **Potential gradient (x)** : Potential difference (or fall in potential) per unit length of wire is called potential gradient *i.e.*

$$x = \frac{V \text{ volt}}{L \text{ m}} \text{ where } V = iR = \left(\frac{e}{R + R_h + r} \right) \cdot R.$$

$$\text{So } x = \frac{V}{L} = \frac{iR}{L} = \frac{i\rho}{A} = \frac{e}{(R + R_h + r)} \cdot \frac{R}{L}$$

(i) Potential gradient directly depends upon

(a) The resistance per unit length (R/L) of potentiometer wire.

(b) The radius of potentiometer wire (*i.e.* Area of cross-section)

(c) The specific resistance of the material of potentiometer wire (*i.e.* ρ)

(d) The current flowing through potentiometer wire (i)

(ii) potential gradient indirectly depends upon

(a) The emf of battery in the primary circuit (*i.e.* e)

(b) The resistance of rheostat in the primary circuit (*i.e.* R_h)

(R_h)

(3) **Working** : Suppose jockey is made to touch a point J on wire then potential difference between A and J will be $V = xl$

At this length (l) two potential difference are obtained

(i) V due to battery e and

(ii) E due to unknown cell

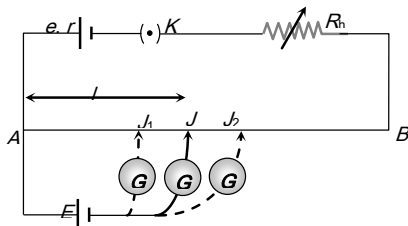

Fig. 19.39

If $V > E$ then current will flow in galvanometer circuit in one direction

If $V < E$ then current will flow in galvanometer circuit in opposite direction

If $V = E$ then no current will flow in galvanometer circuit this condition to known as null deflection position, length l is known as balancing length.

In balanced condition $E = xl$

$$\text{or } E = xl = \frac{V}{L} l = \frac{iR}{L} l = \left(\frac{e}{R + R_h + r} \right) \cdot \frac{R}{L} \times l$$

$$\text{If } V \text{ is constant then } L \propto l \Rightarrow \frac{x_1}{x_2} = \frac{L_1}{L_2} = \frac{l_1}{l_2}$$

(6) **Standardization of potentiometer** : The process of determining potential gradient experimentally is known as standardization of potentiometer.

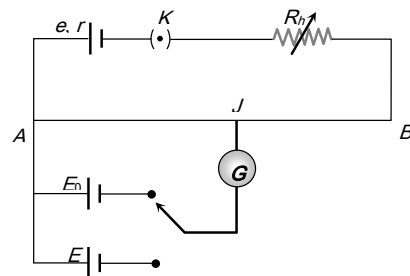

Fig. 19.40

Let the balancing length for the standard emf E_0 is l_0 then by the principle of potentiometer $E_0 = xl_0 \Rightarrow x = \frac{E_0}{l_0}$

1050 Current Electricity

(7) **Sensitivity of potentiometer** : A potentiometer is said to be more sensitive, if it measures a small potential difference more accurately.

(i) The sensitivity of potentiometer is assessed by its potential gradient. The sensitivity is inversely proportional to the potential gradient.

(ii) In order to increase the sensitivity of potentiometer

(a) The resistance in primary circuit will have to be decreased.

(b) The length of potentiometer wire will have to be increased so that the length may be measured more accuracy.

Table 19.5 : Difference between voltmeter and potentiometer

Voltmeter	Potentiometer
It's resistance is high but finite	Its resistance is infinite
It draws some current from source of emf	It does not draw any current from the source of unknown emf
The potential difference measured by it is lesser than the actual potential difference	The potential difference measured by it is equal to actual potential difference
Its sensitivity is low	Its sensitivity is high
It is a versatile instrument	It measures only emf or potential difference
It is based on deflection method	It is based on zero deflection method

Application of Potentiometer

(1) **To determine the internal resistance of a primary cell**

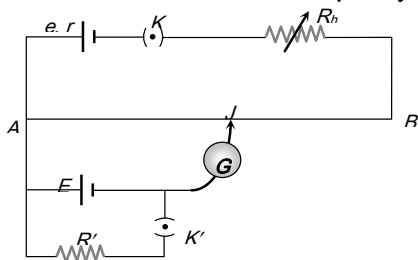

Fig. 19.41

(i) Initially in secondary circuit key K' remains open and balancing length (l_1) is obtained. Since cell E is in open circuit so it's emf balances on length l_1 i.e. $E = x l_1$ (i)

(ii) Now key K' is closed so cell E comes in closed circuit. If the process of balancing repeated again then potential difference V balances on length l_2 i.e. $V = x l_2$

.... (ii)

(iii) By using formula internal resistance $r = \left(\frac{E}{V} - 1 \right) \cdot R'$

$$r = \left(\frac{l_1 - l_2}{l_2} \right) \cdot R'$$

(2) **Comparison of emf's of two cell** : Let l_1 and l_2 be the balancing lengths with the cells E_1 and E_2 respectively then $E_1 =$

$$x l_1 \text{ and } E_2 = x l_2 \Rightarrow \frac{E_1}{E_2} = \frac{l_1}{l_2}$$

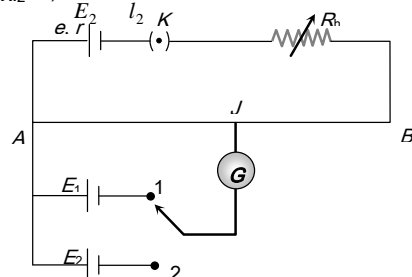

Fig. 19.42

Let $E_1 > E_2$ and both are connected in series. If balancing length is l_1 when cell assist each other and it is l_2 when they oppose each other as shown then :



$$(E_1 + E_2) = x l_1 \quad (E_1 - E_2) = x l_2$$

$$\Rightarrow \frac{E_1 + E_2}{E_1 - E_2} = \frac{l_1}{l_2} \quad \text{or} \quad \frac{E_1}{E_2} = \frac{l_1 + l_2}{l_1 - l_2}$$

(3) **Comparison of resistances** : Let the balancing length for resistance R_1 (when XY is connected) is l_1 and let balancing length for resistance $R_1 + R_2$ (when YZ is connected) is l_2 .

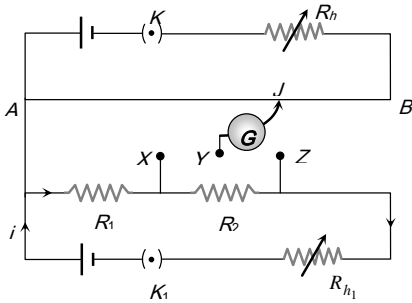

Fig. 19.43

$$\text{Then } iR_1 = xl_1 \text{ and } i(R_1 + R_2) = xl_2 \Rightarrow \frac{R_2}{R_1} = \frac{l_2 - l_1}{l_1}$$

(4) **To determine thermo emf**

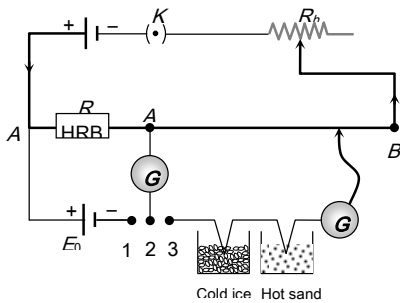

Fig. 19.44

(i) The value of thermo-emf in a thermocouple for ordinary temperature difference is very low (10^{-6} volt). For this the potential gradient x must be also very low (10^{-4} V/m). Hence a high resistance (R) is connected in series with the potentiometer wire in order to reduce current.

(ii) The potential difference across R must be equal to the emf of standard cell *i.e.* $iR = E_0 \therefore i = \frac{E_0}{R}$

(iii) The small thermo emf produced in the thermocouple $e = xl$

(iv) $x = i\rho = \frac{iR}{L} \therefore e = \frac{iRl}{L}$ where $L =$ length of potentiometer wire, $\rho =$ resistance per unit length, $l =$ balancing length for e

(5) **Calibration of ammeter** : Checking the correctness of ammeter readings with the help of potentiometer is called calibration of ammeter.

(i) In the process of calibration of an ammeter the current flowing in a circuit is measured by an ammeter and the same current is also measured with the help of potentiometer. By comparing both the values, the errors in the ammeter readings are determined.

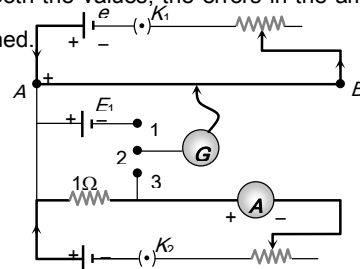

Fig. 19.45

(ii) For the calibration of an ammeter, 1Ω standard resistance coil is specifically used in the secondary circuit of the potentiometer, because the potential difference across 1Ω is equal to the current flowing through it *i.e.* $V = i$

(iii) If the balancing length for the emf E_0 is l_0 then $E_0 = xl_0 \Rightarrow x = \frac{E_0}{l_0}$ (Process of standardisation)

(iv) Let i' current flows through 1Ω resistance giving potential difference as $V = i'(1) = xl_1$ where l_1 is the balancing length. So error can be found as $\Delta i = i - i' = i - xl_1 = i - \frac{E_0}{l_0} \times l_1$

(6) **Calibration of voltmeter**

(i) Practical voltmeters are not ideal, because these do not have infinite resistance. The error of such practical voltmeter

1052 Current Electricity

can be found by comparing the voltmeter reading with calculated value of p.d. by potentiometer.

(ii) If l is balancing length for E_0 the emf of standard cell by connecting 1 and 2 of bi-directional key, then $x = E_0/l$.

(iii) The balancing length l for unknown potential difference V is given by (by closing 2 and 3) $V = x l_1 = (E_0/l_0) l_1$.

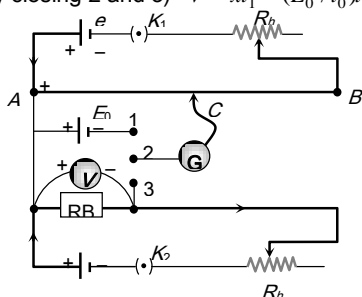

Fig. 19.46

If the voltmeter reading is V then the error will be $(V - V)$ which may be $+ve$, $-ve$ or zero.

Tips & Tricks

Human body, though has a large resistance of the order of $k\Omega$ (say $10 k\Omega$), is very sensitive to minute currents even as low as a few mA . Electrocutation, excites and disorders the nervous system of the body and hence one fails to control the activity of the body.

dc flows uniformly throughout the cross-section of conductor while ac mainly flows through the outer surface area of the conductor. This is known as skin effect.

It is worth noting that electric field inside a charged conductor is zero, but it is non zero inside a current carrying conductor and is given by $E = \frac{V}{l}$ where V = potential difference across the conductor and l = length of the conductor. Electric field

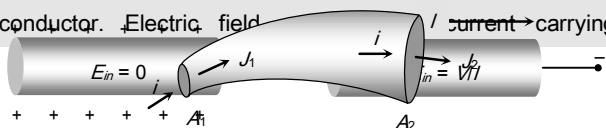

conductor is zero.

For a given conductor $JA = i = \text{constant}$ so that $J \propto \frac{1}{A}$ i.e., $J_1 A_1 = J_2 A_2$; this is called equation of continuity

The drift velocity of electrons is small because of the frequent collisions suffered by electrons.

The small value of drift velocity produces a large amount of electric current, due to the presence of extremely large number of free electrons in a conductor.

The propagation of current is almost at the speed of light and involves electromagnetic process. It is due to this reason that the electric bulb glows immediately when switch is on.

In the absence of electric field, the paths of electrons between successive collisions are straight line while in presence of electric field the paths are generally curved.

Free electron density in a metal is given by $n = \frac{N_A x d}{A}$

where N_A = Avogadro number, x = number of free electrons per atom, d = density of metal and A = Atomic weight of metal.

In the absence of radiation loss, the time in which a fuse will melt does not depend on its length but varies with radius as $t \propto r^4$.

If length (l) and mass (m) of a conducting wire is given then $R \propto \frac{l^2}{m}$.

Macroscopic form of Ohm's law is $R = \frac{V}{i}$, while its

microscopic form is $J = \sigma E$.

After stretching if length increases by n times then resistance will increase by n^2 times *i.e.* $R_2 = n^2 R_1$. Similarly if radius be reduced to $\frac{1}{n}$ times then area of cross-section decreases $\frac{1}{n^2}$ times so the resistance becomes n^4 times *i.e.* $R_2 = n^4 R_1$.

After stretching if length of a conductor increases by $x\%$ then resistance will increase by $2x\%$ (valid only if $x < 10\%$)

Decoration of lightning in festivals is an example of series grouping whereas all household appliances connected in parallel grouping.

Using n conductors of equal resistance, the number of possible combinations is 2^{n-1} .

If the resistance of n conductors are totally different, then the number of possible combinations will be 2^n .

If n identical resistances are first connected in series and then in parallel, the ratio of the equivalent resistance is given by $\frac{R_p}{R_s} = \frac{n^2}{1}$.

If a wire of resistance R , cut in n equal parts and then these parts are collected to form a bundle then equivalent resistance of combination will be $\frac{R}{n^2}$.

If equivalent resistance of R_1 and R_2 in series and parallel be R_s and R_p respectively then $R_1 = \frac{1}{2} [R_s + \sqrt{R_s^2 - 4R_s R_p}]$ and $R_2 = \frac{1}{2} [R_s - \sqrt{R_s^2 - 4R_s R_p}]$.

If a skeleton cube is made with 12 equal resistance each having resistance R then the net resistance across

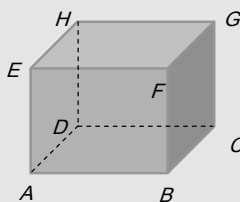

The longest diagonal (EC or AG) = $\frac{5}{6} R$

The diagonal of face (*e.g.* AC , ED , ...) = $\frac{3}{4} R$

A side (*e.g.* AB , BC , ...) = $\frac{7}{12} R$

Resistance of a conducting body is not unique but depends on its length and area of cross-section *i.e.* how the potential difference is applied. See the following figures

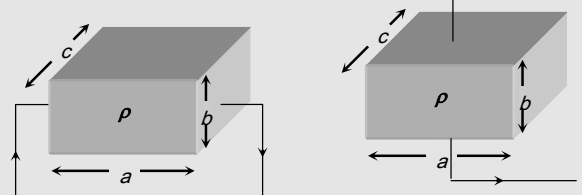

Length = a

Area of cross-section = $b \times c$

$$\text{Resistance } R = \rho \left(\frac{a}{b \times c} \right)$$

Length = b

Area of cross-section = $a \times c$

$$\text{Resistance } R = \rho \left(\frac{b}{a \times c} \right)$$

Some standard results for equivalent resistance

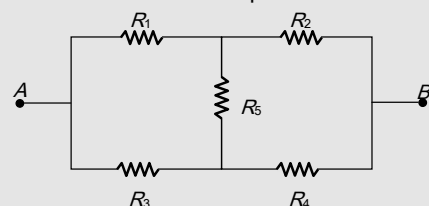

$$R_{AB} = \frac{R_1 R_2 (R_3 + R_4) + (R_1 + R_2) R_3 R_4 + R_5 (R_1 + R_2) (R_3 + R_4)}{R_5 (R_1 + R_2 + R_3 + R_4) + (R_1 + R_3) (R_2 + R_4)}$$

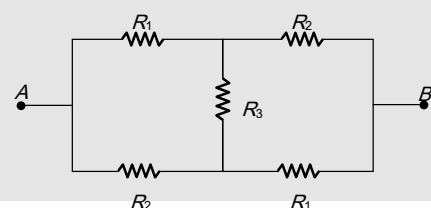

1054 Current Electricity

$$R_{AB} = \frac{2R_1R_2 + R_3(R_1 + R_2)}{2R_3 + R_1 + R_2}$$

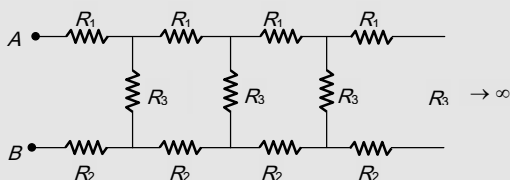

$$R_{AB} = \frac{1}{2}(R_1 + R_2) + \frac{1}{2}[(R_1 + R_2)^2 + 4R_3(R_1 + R_2)]^{1/2}$$

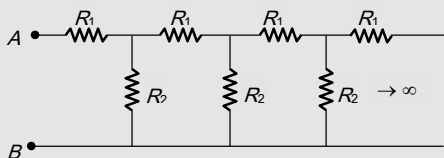

$$R_{AB} = \frac{1}{2}R_1 \left[1 + \sqrt{1 + 4\left(\frac{R_2}{R_1}\right)} \right]$$

It is a common misconception that "current in the circuit will be maximum when power consumed by the load is maximum."

Actually current $i = E/(R+r)$ is maximum ($= E/r$) when $R = \min = 0$ with $P_L = (E/r)^2 \times 0 = 0 \min$. while power consumed by the load $E^2R/(R+r)^2$ is maximum ($= E^2/4r$) when $R = r$ and $i = (E/2r) \neq \max (= E/r)$.

Emf is independent of the resistance of the circuit and depends upon the nature of electrolyte of the cell while potential difference depends upon the resistance between the two points of the circuit and current flowing through the circuit.

Whenever a cell or battery is present in a branch there must be some resistance (internal or external or both)

present in that branch. In practical situation it always happen because we can never have an ideal cell or battery with zero resistance.

In series grouping of identical cells. If one cell is wrongly connected then it will cancel out the effect of two cells *e.g.* If in the combination of n identical cells (each having emf E and internal resistance r) if x cell are wrongly connected then equivalent emf $E_{eq} = (n - 2x)E$ and equivalent internal resistance $r_{eq} = nr$.

Graphical view of open circuit and closed circuit of a cell.

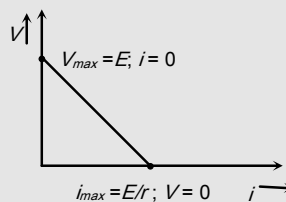

If n identical cells are connected in a loop in order, then emf between any two points is zero.

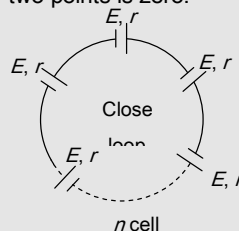

In parallel grouping of two identical cell having no internal resistance

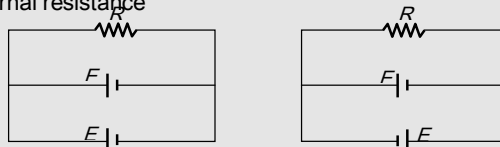

$$E_{eq} = E$$

$$E_{eq} = 0$$

When two cell's of different emf and no internal resistance are connected in parallel then equivalent emf is

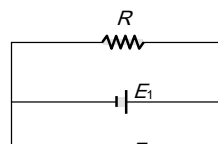

indeterminate, note that connecting a wire with a cell with no resistance is equivalent to short circuiting. Therefore the total current that will be flowing will be infinity.

✍ In the parallel combination of non-identical cell's if they are connected with reversed polarity as shown then equivalent emf

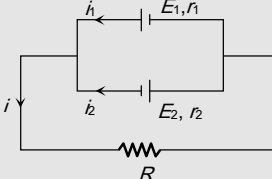
$$E_{eq} = \frac{E_1 r_2 - E_2 r_1}{r_1 + r_2}$$

✍ Wheatstone bridge is most sensitive if all the arms of bridge have equal resistances *i.e.* $P = Q = R = S$

✍ If the temperature of the conductor placed in the right gap of metre bridge is increased, then the balancing length decreases and the jockey moves towards left.

✍ In Wheatstone bridge to avoid inductive effects the battery key should be pressed first and the galvanometer key afterwards.

✍ The measurement of resistance by Wheatstone bridge is not affected by the internal resistance of the cell.

✍ In case of zero deflection in the galvanometer current flows in the primary circuit of the potentiometer, not in the galvanometer circuit.

✍ A potentiometer can act as an ideal voltmeter.