



WAC
LANDSCAPE LIGHTING

ABOUT WAC LANDSCAPE LIGHTING

Dream it. Solve it. Make it.

WAC LIGHTING is a second generation family-owned and operated lighting company with a reputation for quality spanning 40 years. We have a history of inventing and making innovation widely available to the market through competitive pricing and reputable distribution partnerships.

Our choice has consistently been to operate at a higher level of responsibility, giving our customers the true benefits of a world class factory-owned relationship.

Headquartered in New York, we have factories in New York, California, Georgia, and use a dedicated factories in Asia to support a comprehensive research, design, engineering, electronics, fabrication, manufacturing, and testing operation worldwide.

WAC LANDSCAPE LIGHTING is an expansion of our lighting technology brand to offer ground-breaking patented solutions to the irrigation and green industry that address problems currently not addressed by other landscape lighting companies.

Table of Contents

12V LANDSCAPE LIGHTING

LED Grand Accent	5-6
LED Accent	7-8
LED Mini Accent	9-12
LED Interbeam	13-14
LED Adjustable Beam Wall Wash	15-16
LED Wall Wash	17-18
LED Mini Wall Wash	19-20
LED 3" In-Ground	21-24
LED Underwater Spot	25-26
LED Submersible 2" Ingrounds	27-28
LED Recessed Ingrounds + Indicator	29-32
LED ESTRELLA Pendant Ceiling Light	33-34
LED Cylinder Wall Mount	25-36
LED Surface Mount Indicator	37-38
LED Hardscape.....	39-42
LED Path Lights	43-68
LED Bollards	69-79

12V LED Outdoor Tape Light	80-82
24V LED Outdoor Tape Light	83-88
LED Deck & Patio.....	89-90
LED Step Lights	91-96
Transformers/Accessories	97-98

120V EXTERIOR

LED DIRECT WIRE LIGHTING

LED Landscape	99-100
LED Brick Lights.....	101-102
LED Flood Lights	103-108
LED Wall Packs	109-110
LED Decorative	111-114
Photometrics.....	115-125

WHAT HAVE WE DONE FOR YOU LATELY?

Our Newest Patented Products Solve Everyday Challenges

Adjustable Beam Wall Wash

FLEXIBILITY/OPTIONS

Multiple OPTIONS for FLEXIBILITY:

Marine-grade Brass or Corrosion Resistant Aluminum Bronze or Black finishes.

2700K, 3000K, or 4000K

12V or 120V

Color lens & optical lens option

Tree mount, wall mount option

Suitable for use as a Wall Wash Light



BRIGHTNESS

Fixture lumen output range of 200lm to 1500lm can be accomplished. In wattage, this translates to a range from 3W to 25W of LED power. This is all accomplished with a screwdriver for brightness adjustment.

BEAM ANGLE

Architectural beam distributions from 3x4 to 4x5 to 5x6 proportions and everything in between. Rotatable fixture head for vertical distribution. Always a uniform wide beam wash of light.

NEMA 4X3: 60 degrees by 35 degrees

NEMA 5X4: 90 degrees by 60 degrees

NEMA 6X5: 120 degrees by 90 degrees

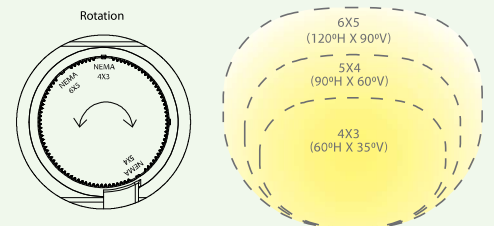

Hardscape Quick Release

BRIGHTNESS

Fixture lumen output range of 10lm to 350lm can be accomplished. In wattage, this translates to a range from 0.5W to 8.5W of LED power. This is all accomplished with a screwdriver for brightness adjustment.

QUICK RELEASE SERVICEABILITY

Based on popular demand, our new patented invention allows for a watertight male/female connection at the fixture for ease of replacement after it is installed.

FLEXIBILITY/OPTIONS

Multiple OPTIONS for FLEXIBILITY:

Marine-grade Brass or Corrosion Resistant Aluminum Bronze, Graphite, or Sand finishes.

Select color temperature option : 2700K or 3000K

Removable stainless steel capstone bracket and rotating mounting clips included



Durability. Flexibility. Guaranteed.

Every WAC Lighting® fixture in our patented line of technology landscape products is thoroughly tested in our nationally recognized NVLAP, UL, and ETL certified laboratories for safety, durability, and robust long term performance, even in the most rugged environments.

LED Life Expectancy

Rated life of LED lights is based on IES (Illuminating Engineering Society) L70 standard accelerated lifetime testing for how long they will operate until only 70% of the original light output remains.

 Listed to UL 1838 standard (12V) | 1598 standard (120V)

DO YOU HAVE WHAT YOU NEED?

OURS | Just three continuously adjustable lights perfectly illuminate small to giant objects everytime.



Adjustable 10° to 50° beam
Power from 7W to 1W
Dims from 365 lumens to 45 lumens



Adjustable 10° to 60° beam
Power from 16W to 2W
Dims from 1045 lumens to 190 lumens



Adjustable 15° to 60° beam
Power from 33W to 15W
Dims from 2000 lumens to 740 lumens

Others are mostly available as low as 100 lumens, which may still be too bright for certain applications at night

Covers most commonly needed accent lighting applications

Other landscape accent lights offer below 1000 lumens

OTHERS | Each light needs to be ordered specifically for fixed beam angles and brightness levels.

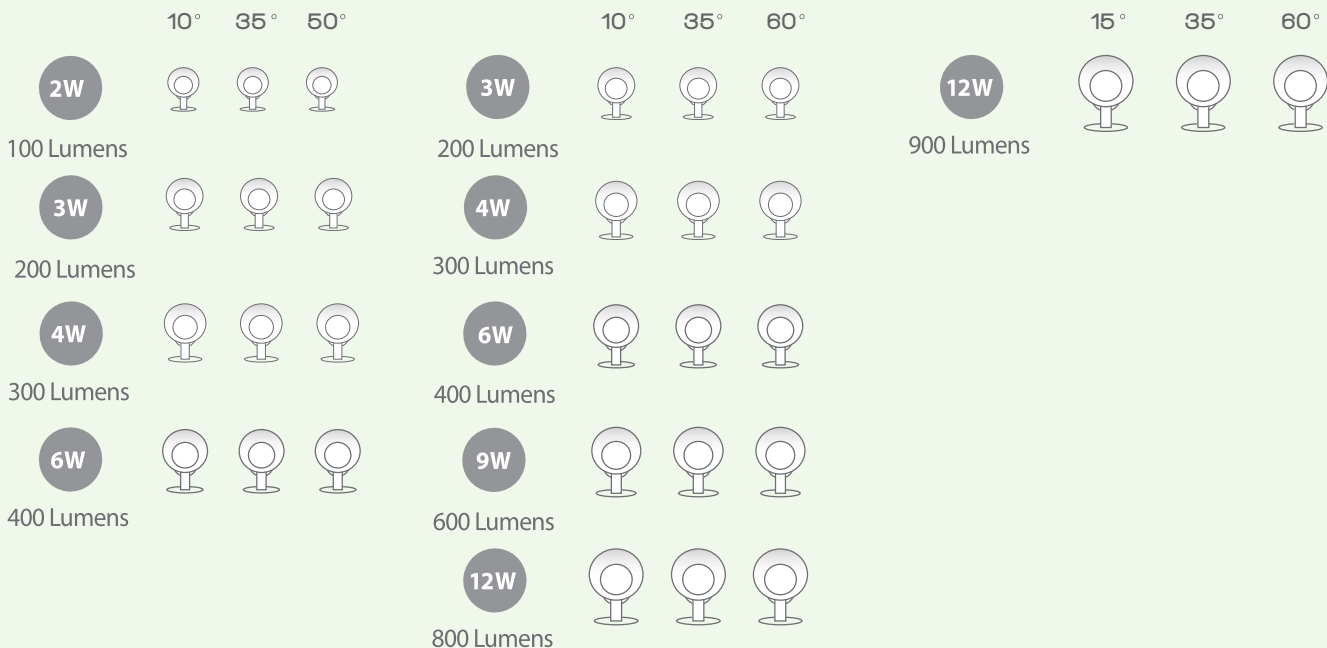

It's All About the DETAILS

Gone are the appearance of many glary LED dots.
Quality LED Illumination comparable to incandescent
without the pain of a high electricity bill.



Continuously Adjustable Brightness Control



Easy Adjustability

Twist the collar to change beam angle. Use a flat or philips head screw driver to adjust brightness and lock aiming direction.

Materials That Mean Business

Unlike other brands of landscape lighting, we actually fabricate each component of each product using the best UV stabilized and corrosion resistant materials available to be able to confidently support a true 10 year warranty.

Marine Grade Die-cast Stainless Steel
Bronze Finished Stainless Steel

Die-cast Corrosion Resistant Aluminum Alloy
Robust Powder coated Bronze and Black Finishes

Die-cast or Machined Marine-Grade Brass
Bronze Finish



THE GRAND ACCENT LED LANDSCAPE

MOONLIGHTING EFFECT

Introducing the first landscape accent lights to deliver up to 2000 lumens of light output. When mounted high in trees and pointing downward, Grand Accent creates a beautiful moonlighting effect with a cool white light and superior lumen output.

- New 4000K color temperature option resembles moonlight
- Adjustable beam 15° to 60°
- Continuously adjustable lumen output 740–2000 lm
- Integral brightness control
- One fixture replaces various halogen accent lights with a much higher wattage



visit product
page online

THE GRAND ACCENT LED LANDSCAPE

PATENTED



1838 listed
1598 listed

12V

Input	9-15VAC
Power	15W to 33W / 21VA -44VA
Brightness	740 lm to 2000 lm
Beam Angle	15° to 60°
CRI	85
Rated Life	45,000 hours

2700K Warm White

5211-27	BK	Black on Aluminum
	BZ	Bronze on Aluminum
	BBR	Bronze on Brass

3000K Pure White

5211-30	BK	Black on Aluminum
	BZ	Bronze on Aluminum
	BBR	Bronze on Brass

4000K Cool White

5211-40	BK	Black on Aluminum
	BZ	Bronze on Aluminum
	BBR	Bronze on Brass

120V

Input	120VAC
Power	13W to 31W / 23VA -48VA
Brightness	780 lm to 2050 lm
Beam Angle	15° to 60°
CRI	85
Rated Life	45,000 hours

3000K Pure White

5212-30	BK	Black on Aluminum
	BZ	Bronze on Aluminum
	BBR	Bronze on Brass

4000K Cool White

5212-40	BK	Black on Aluminum
	BZ	Bronze on Aluminum
	BBR	Bronze on Brass



See photometric data on pages 115-116

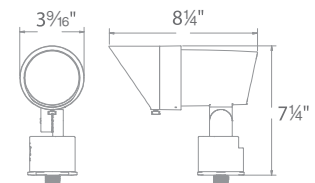

Accessories

5" Long Shroud		5211-LSHR-BK 5211-LSHR-BZ 5211-LSHR-BBR	Black on Aluminum Bronze on Aluminum Bronze on Brass	Reduce glare; ideal for downlighting application
Grand Accent Snoot		5211-SNOOT-BK 5211-SNOOT-BZ 5211-SNOOT-BBR	Black on Aluminum Bronze on Aluminum Bronze on Brass	Reduce glare; ideal for downlighting application
Mounting Stake		9000-ST9-BZ 9000-ST14-BZ	Bronze Bronze	9" Durable PC stake 14" Durable PC stake
Power Stake		M6000-STAKE	Black	Easy wiring accessory designed for 120V products; eliminates the need for a separate J-box.
Surface Mount Flange/Stake		5000-SCP-BK 5000-SCP-BZ 5000-SCP-BBR	Black on Aluminum Bronze on Aluminum Bronze on Brass	Includes three 7 inch threaded stainless steel stabilizing pins for ground mounting or surface mounts with four screws or over a junction box
Guardian Mount		9000-SP9-BZ	Stainless Steel	Heavy duty stainless steel spike to position fixture
Gutter Mount Bracket		5000-GM-BK 5000-GM-BZ	Black on Aluminum Bronze on Aluminum	Stainless steel universal mounting bracket for gutter mounting fixture
Tree Mount Junction Box		5000-TCP-BK 5000-TCP-BZ	Black on Aluminum Bronze on Aluminum	Aluminum box with stainless steel mounting screws; Two 1/2" NPT threaded holes, UL 120V Listed
		5000-TCL-BK 5000-TCL-BZ	Black on Aluminum Bronze on Aluminum	Large aluminum box with stainless steel mounting screws; Two 1/2" NPT threaded holes, UL 120V Listed
Large Tree Mount Canopy Strap		5000-TST-BK	Black on Steel/terylene	Ratcheting device with strap to be used with Large Tree Mount Junction Box (5000-TCL)
		5000-STB-BK	Black on Steel	Tree mount bracket only
Extension Rods		5000-X04-BZ,BK,BBR	4 in	5000-X18-BZ,BK,BBR 18 in 5000-X24-BZ,BK,BBR 24 in
		5000-X08-BZ,BK,BBR	8 in	
		5000-X12-BZ,BK,BBR	12 in	
Optics		LENS-25-AMB	Amber	LENS-25-BLU Blue LENS-25-FR Frosted LENS-25-SPR Spread
		LENS-25-GRN	Green	
		LENS-25-RED	Red	
		5211-HCL		Honeycomb Lens
		LENS-25-BEL		Elongating Beam

9" Mounting stake (12V), Detachable shroud, 6' lead wire and direct burial gel filled wire nuts (12V) or standard wire nuts (120V) included

ACCENT LED LANDSCAPE

- Continuously Adjustable Beam Angles
Indexed at 10°, 25°, 40°, 60°

- Continuously Adjustable Brightness Control
Indexed at 1W, 2W, 8W, 15W, 18W



visit product
page online

ACCENT LED LANDSCAPE

PATENTED

IP66



1838 listed
1598 listed

12V

- Both fixture level dimming and circuit level dimming
- Dim each circuit from either the 12V or 120V side
- Adjustable beam angle 10° to 60°

Input	9-15V
Power	1W to 18W/2VA-23VA
Brightness	50lm to 1160lm
Beam Angle	10° to 60°
CRI	85
Rated Life	70,000 hours

5011-27 2700K	BK Black on Aluminum
5011-30 3000K	BZ Bronze on Aluminum
5011-40 4000K	BBR Bronze on Brass

120V

- Adjustable beam angle 15° to 60°
- Simple to retrofit existing line voltage systems or coordinate well with a new commercial landscape job

Input	110V-120V
Power	3.5W to 14.5W
Brightness	100lm to 900lm
Beam Angle	15° to 60°
CRI	85
Rated Life	45,000 hours

5012-30 3000K	BK Black on Aluminum
	BZ Bronze on Aluminum
	BBR Bronze on Brass



See photometric data on pages 117-118

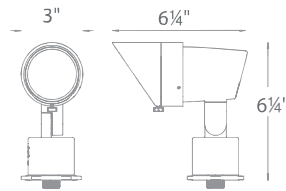

Accessories

6" Long Shroud		5010-LSHR-BK 5010-LSHR-BZ 5010-LSHR-BBR	Black on Aluminum Bronze on Aluminum Bronze on Brass	Reduces glare; ideal for downlighting application		
Accent Snoot		5010-SNOOT-BK 5010-SNOOT-BZ 5010-SNOOT-BBR	Black on Aluminum Bronze on Aluminum Bronze on Brass	Reduces glare; ideal for downlighting application		
Mounting Stake		9000-ST9-BZ 9000-ST14-BZ	Bronze Bronze	9" Durable PC stake 14" Durable PC stake		
Power Stake		M6000-STAKE	Black	Easy wiring accessory designed for 120V products; eliminates the need for a separate J-box.		
Surface Mount Flange/Stake		5000-SCP-BK 5000-SCP-BZ 5000-SCP-BBR	Black on Aluminum Bronze on Aluminum Bronze on Brass	Includes three 7 inch threaded stainless steel stabilizing pins for ground mounting or surface mounts with four screws or over a junction box		
Guardian Mount		9000-SP9-BZ	Stainless Steel	Heavy duty stainless steel spike to position fixture		
Gutter Mount Bracket		5000-GM-BK 5000-GM-BZ	Black on Aluminum Bronze on Aluminum	Stainless steel universal mounting bracket for gutter mounting fixture		
Tree Mount Junction Box		5000-TCP-BK 5000-TCP-BZ	Black on Aluminum Bronze on Aluminum	Aluminum box with stainless steel mounting screws; Two 1/2" NPT threaded holes, UL 120V Listed		
		5000-TCL-BK 5000-TCL-BZ	Black on Aluminum Bronze on Aluminum	Large aluminum box with stainless steel mounting screws; Two 1/2" NPT threaded holes, UL 120V Listed		
Large Tree Mount Canopy Strap		5000-TST-BK	Black on Steel/terylene	Ratcheting device with strap to be used with Large Tree Mount Junction Box (5000-TCL)		
		5000-STB-BK	Black on Steel	Tree mount bracket only		
Extension Rods		5000-X04-BZ,BK,BBR	4 in	5000-X18-BZ,BK,BBR	18 in	Extends distance between Accent light and surface mount canopy, stake, or tree mount box
		5000-X08-BZ,BK,BBR	8 in	5000-X24-BZ,BK,BBR	24 in	
		5000-X12-BZ,BK,BBR	12 in			
Optics		LENS-20-AMB	Amber	LENS-20-BLU	Blue	5011-HCL Honeycomb Lens LENS-20-BEL Elongating Beam
		LENS-20-GRN	Green	LENS-20-FR	Frosted	
		LENS-20-RED	Red	LENS-20-SPR	Spread	

9" Mounting stake (12V), Detachable shroud, 6' lead wire and direct burial gel filled wire nuts (12V) or standard wire nuts (120V) included

MINI ACCENT LED LANDSCAPE

- Adjustable beam angle
- IP66 Rated, protected against high-pressure water jets
- Includes a detachable shroud
- Solid die-cast brass or corrosion resistant aluminum
- Factory sealed watertight fixtures
- Constant output for 9V-15V input
- Can be used as an uplight or downlight
- 2700K or 3000K color temperature



- Continuously Adjustable Brightness Control
Indexed at 1W, 2W, 4W, 6W, 7W

- Continuously Adjustable Beam Angles
Indexed at 10°, 25°, 40°, 50°



visit product
page online

MINI ACCENT LED LANDSCAPE

PATENTED IP66  **us**
1838 listed

12V

- Integral brightness control
- Adjustable beam angle 10° to 50°
- One fixture replaces all older halogen landscape accent light.

Transformer Required (order separately)

Input	9-15VAC
Power	1W to 7W / 2VA -7.6VA
Brightness	45 lm to 365 lm
Beam Angle	10° to 50°
CRI	85
Rated Life	70,000 hours

2700K *Warm White*

5111-27	BK	Black on Aluminum
	BZ	Bronze on Aluminum
	BBR	Bronze on Brass

3000K *Pure White*

5111-30	BK	Black on Aluminum
	BZ	Bronze on Aluminum
	BBR	Bronze on Brass



See photometric data on page 119

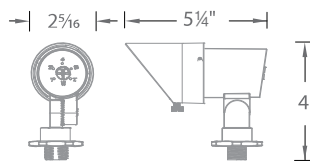

Shown with gutter mount bracket accessory



Continuously adjustable brightness control

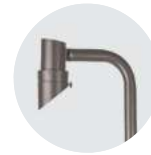

Single and Double stem mount available. See pages 11-12

Accessories

5" Long Shroud		5111-LSHR-BK 5111-LSHR-BZ 5111-LSHR-BBR	Black on Aluminum Bronze on Aluminum Bronze on Brass	Reduce glare; ideal for downlighting application		
Mini Accent Snoot		5111-SNOOT-BK 5111-SNOOT-BZ 5111-SNOOT-BBR	Black on Aluminum Bronze on Aluminum Bronze on Brass	Reduce glare; ideal for downlighting application		
Mounting Stake		9000-ST9-BZ 9000-ST14-BZ	Bronze Bronze	9" Durable PC stake 14" Durable PC stake		
Power Stake		M6000-STAKE	Black	Easy wiring accessory designed for 120V products; eliminates the need for a separate J-box.		
Surface Mount Flange/Stake		5000-SCP-BK 5000-SCP-BZ 5000-SCP-BBR	Black on Aluminum Bronze on Aluminum Bronze on Brass	Includes three 7 inch threaded stainless steel stabilizing pins for ground mounting or surface mounts with four screws or over a junction box		
Guardian Mount		9000-SP9-BZ	Stainless Steel	Heavy duty stainless steel spike to position fixture		
Gutter Mount Bracket		5000-GM-BK 5000-GM-BZ	Black on Aluminum Bronze on Aluminum	Stainless steel universal mounting bracket for gutter mounting fixture		
Tree Mount Junction Box		5000-TCP-BK 5000-TCP-BZ	Black on Aluminum Bronze on Aluminum	Aluminum box with stainless steel mounting screws; Two 1/2" NPT threaded holes, UL 120V Listed		
		5000-TCL-BK 5000-TCL-BZ	Black on Aluminum Bronze on Aluminum	Large aluminum box with stainless steel mounting screws; Two 1/2" NPT threaded holes, UL 120V Listed		
Large Tree Mount Canopy Strap		5000-TST-BK	Black on Steel/terylene	Ratcheting device with strap to be used with Large Tree Mount Junction Box (5000-TCL)		
		5000-STB-BK	Black on Steel	Tree mount bracket only		
Extension Rods		5000-X04-BZ,BK,BBR	4 in	5000-X18-BZ,BK,BBR	18 in	Extends distance between Accent light and surface mount canopy, stake, or tree mount box
		5000-X08-BZ,BK,BBR	8 in	5000-X24-BZ,BK,BBR	24 in	
		5000-X12-BZ,BK,BBR	12 in			
Optics		LENS-16-AMB	Amber	LENS-16-BLU	Blue	5111-HCL Honeycomb Lens LENS-16-BEL Elongating Beam
		LENS-16-GRN	Green	LENS-16-FR	Frosted	
		LENS-16-RED	Red	LENS-16-SPR	Spread	

9" Mounting stake (12V), detachable shroud, 6' lead wire and direct burial gel filled wire nuts (12V) included

MINI ACCENT LED PATH

- IP66 Rated, protected against high-pressure water jets
- Factory sealed, watertight fixtures
- Constant output for 9V-15V input



visit product
page online

MINI ACCENT LED PATH

PATENTED  
 IP66 **UL** US
 1838 listed

12V

- Includes 6", 12" and 24" extensions
- IP66 Rated, protected against high-pressure water jets
- 10°-50° beam adjustability
- Continuously adjustable beam angles and brightness control
- Detachable shroud
- Constant output for 9V-15V input

Transformer Required (order separately)

SINGLE

Input	9-15VAC
Power	1W to 7W/2VA-7.6VA
Brightness	45lm to 365lm
Color Temp	2700 & 3000k
CRI	85
Rated Life	70,000 hours

2700 & 3000K *Warm and Pure White*

Single

6111-27	BZ	Bronze on Aluminum
6111-30	BBR	Bronze on Brass

2700 & 3000K *Warm and Pure White*

Double

6211-27	BZ	Bronze on Aluminum
6211-30	BBR	Bronze on Brass

DOUBLE

Input	9-15VAC
Power	1W to 7W/2VA-7.6VA x2
Brightness	45lm to 365lm x2
Color Temp	2700 & 3000k
CRI	85
Rated Life	70,000 hours

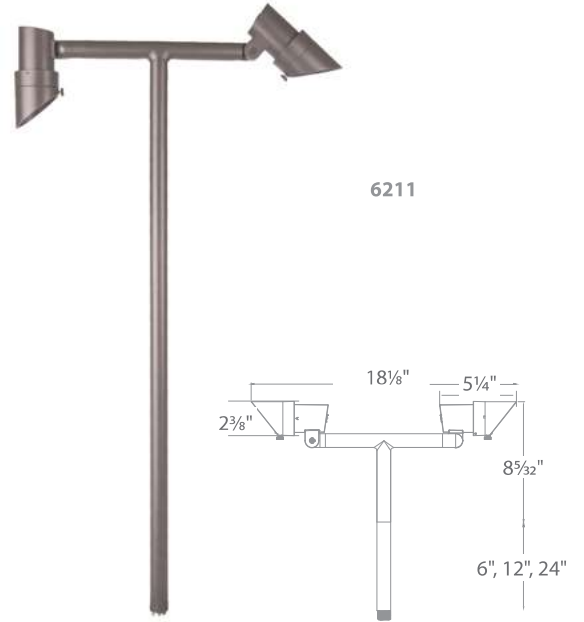



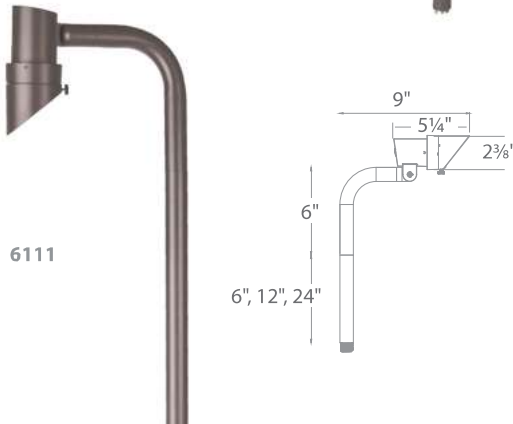

Example: 6111-30BBR

Guardian mount, 6 foot lead wire, and direct burial gel filled wire nuts included

See photometric data on page 119



Accessories

5" Long Shroud		5111-LSHR-BK 5111-LSHR-BZ 5111-LSHR-BBR	Black on Aluminum Bronze on Aluminum Bronze on Brass	Reduce glare; ideal for downlighting application
14" Mounting Stake		9000-ST14-BZ	Bronze	Durable PC stake
Surface Mount Flange/Stake		5000-SCP-BK 5000-SCP-BZ 5000-SCP-BBR	Black on Aluminum Bronze on Aluminum Bronze on Brass	Includes three 7 inch threaded stainless steel stabilizing pins for ground mounting or surface mounts with four screws or over a junction box
Guardian Mount		9000-SP9-BZ	Stainless Steel	Heavy duty stainless steel spike to position fixture

INTERBEAM LED LANDSCAPE



visit product
page online

INTERBEAM LED LANDSCAPE

PATENTS PENDING IP66 1838 listed 

12V

- MLV Dimmable (remote MLV dimmer)
 - Adjustable beam angle 20° to 60°
 - One adjustable light replaces many standards lights in various sizes and styles
- Transformer Required (order separately)*







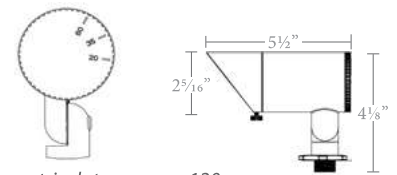

Input	9-15VAC	Input	9-15VAC
Power	6W/7.7VA	Power	3W/5.5VA
Brightness	475lm	Brightness	245lm
Beam Angle	20° to 60°	Beam Angle	20° to 60°
CRI	85	CRI	85
Rated Life	70,000 hours	Rated Life	70,000 hours

2700K	Warm White	2700K	Warm White
5311-27	BK Black on Aluminum	5411-27	BK Black on Aluminum
	BZ Bronze on Aluminum		BZ Bronze on Aluminum
3000K	Pure White	3000K	Pure White
5311-30	BK Black on Aluminum	5411-30	BK Black on Aluminum
	BZ Bronze on Aluminum		BZ Bronze on Aluminum



See photometric data on page 120

Accessories

5" Long Shroud		5111-LSHR-BK 5111-LSHR-BZ	Black on Aluminum Bronze on Aluminum Bronze on Brass	Reduce glare; ideal for downlighting application
Mini Accent Snoot		5111-SNOOT-BK 5111-SNOOT-BZ	Black on Aluminum Bronze on Aluminum Bronze on Brass	Reduce glare; ideal for downlighting application
Mounting Stake		9000-ST9-BZ 9000-ST14-BZ	Bronze Bronze	9" Durable PC stake 14" Durable PC stake
Power Stake		M6000-STAKE	Black	Easy wiring accessory designed for 120V products; eliminates the need for a separate J-box.
Surface Mount Flange/Stake		5000-SCP-BK 5000-SCP-BZ 5000-SCP-BBR	Black on Aluminum Bronze on Aluminum Bronze on Brass	Includes three 7 inch threaded stainless steel stabilizing pins for ground mounting or surface mounts with four screws or over a junction box
Guardian Mount		9000-SP9-BZ	Stainless Steel	Heavy duty stainless steel spike to position fixture
Gutter Mount Bracket		5000-GM-BK 5000-GM-BZ	Black on Aluminum Bronze on Aluminum	Stainless steel universal mounting bracket for gutter mounting fixture
Tree Mount Junction Box		5000-TCP-BK 5000-TCP-BZ	Black on Aluminum Bronze on Aluminum	Aluminum box with stainless steel mounting screws; Two 1/2" NPT threaded holes, UL 120V Listed
		5000-TCL-BK 5000-TCL-BZ	Black on Aluminum Bronze on Aluminum	Large aluminum box with stainless steel mounting screws; Two 1/2" NPT threaded holes, UL 120V Listed
Large Tree Mount Canopy Strap		5000-TST-BK	Black on Steel/terylene	Ratcheting device with strap to be used with Large Tree Mount Junction Box (5000-TCL)
		5000-STB-BK	Black on Steel	Tree mount bracket only
Extension Rods		5000-X04-BZ,BK,BBR 4 in 5000-X08-BZ,BK,BBR 8 in 5000-X12-BZ,BK,BBR 12 in	5000-X18-BZ,BK,BBR 18 in 5000-X24-BZ,BK,BBR 24 in	Extends distance between Accent light and surface mount canopy, stake, or tree mount box
Optics		LENS-16-AMB Amber LENS-16-GRN Green LENS-16-RED Red	LENS-16-BLU Blue LENS-16-FR Frosted LENS-16-SPR Spread	5111-HCL Honeycomb Lens LENS-16-BEL Elongating Beam

Mounting stake (12V), detachable shroud, 6' lead wire and direct burial gel filled wire nuts (12V) included

ADJUSTABLE BEAM WALL WASH LED LANDSCAPE

WITH BEAM AND INTEGRAL BRIGHTNESS CONTROL

- Continuously adjustable NEMA beam distribution 3x4 (35°x60°), 4x5 (60°x90°), 5x6 (90°x120°)
- IP66 Rated, protected against powerful water jets
- Solid die-cast brass or corrosion resistant aluminum alloy



Architectural beam distributions from 3x4 to 4x5 to 5x6 proportions and everything in between.
Always a uniform wide beam wash of light.



NEMA 5x4

NEMA 4x5



visit product page online

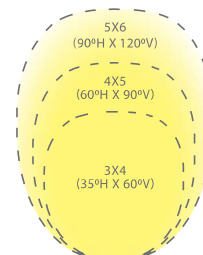
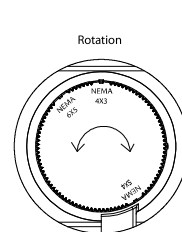
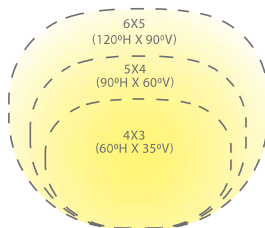
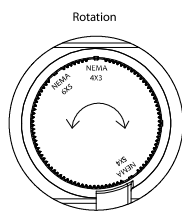

ADJUSTABLE BEAM WALL WASH LED LANDSCAPE PATENTED WITH BEAM AND INTEGRAL BRIGHTNESS CONTROL



12V

- Continuously adjustable NEMA beam distribution 3x4 (35°x60°), 4x5 (60°x90°), 5x6 (90°x120°)
- Integral brightness control
- Rotatable fixture head for vertical distribution

Transformer Required (order separately)

120V

- Continuously adjustable NEMA beam distribution 3x4 (35°x60°), 4x5 (60°x90°), 5x6 (90°x120°)
- Integral brightness control
- Simple to retrofit existing line voltage systems or coordinate well with a new commercial landscape job



Input Power	9-15VAC
Brightness	3W to 25W/4.4VA-27.8VA
Beam Angle	200 lm to 1500 lm
CRI	Assorted NEMA distributions
Rated Life	85
	70,000 hours

Input Power	110V - 120VAC
Brightness	3W to 25W
Beam Angle	200 lm to 1550 lm
CRI	Assorted NEMA distributions
Rated Life	85
	45,000 hours

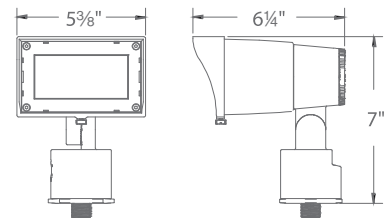

5221-27 2700K	BK	Black on Aluminum
	BZ	Bronze on Aluminum
	BBR	Bronze on Brass

5222-27 2700K	BK	Black on Aluminum
	BZ	Bronze on Aluminum
	BBR	Bronze on Brass

5221-30 3000K	BK	Black on Aluminum
	BZ	Bronze on Aluminum
	BBR	Bronze on Brass

5222-30 3000K	BK	Black on Aluminum
	BZ	Bronze on Aluminum
	BBR	Bronze on Brass

Architectural beam distributions from 3x4 to 4x5 to 5x6 proportions and everything in between.

Always a uniform wide beam wash of light.

See photometric data on pages 125

Accessories

14" Mounting Stake		9000-ST14-BZ	Bronze	Durable PC stake
Surface Mount Flange/Stake		5000-SCP-BK 5000-SCP-BZ 5000-SCP-BBR	Black on Aluminum Bronze on Aluminum Bronze on Brass	Includes three 7-inch threaded stainless steel stabilizing pins for ground mounting or surface mounts with four screws or over a junction box
Guardian Mount		9000-SP9-BZ	Stainless Steel	Heavy duty stainless steel spike to position fixture
Gutter Mount Bracket		5000-GM-BK 5000-GM-BZ	Black on Aluminum Bronze on Aluminum	Stainless steel universal mounting bracket for gutter mounting fixture
Tree Mount Junction Box		5000-TCP-BK 5000-TCP-BZ	Black on Aluminum Bronze on Aluminum	Aluminum box with stainless steel mounting screws; two 1/2" NPT threaded holes, UL 120V listed
		5000-TCL-BK 5000-TCL-BZ	Black on Aluminum Bronze on Aluminum	Large aluminum box with stainless steel mounting screws; two 1/2" NPT threaded holes, UL 120V listed
Large Tree Mount Canopy Strap		5000-TST-BK	Black on Steel/terylene	Ratcheting device with strap for use with Tree Mount Junction Box (5000-TCL)
		5000-STB-BK	Black on Steel	Tree mount bracket only
Optics		LENS-3X5-AMB LENS-3X5-GRN LENS-3X5-RED	Amber Green Red	LENS-3X5-BLU Blue LENS-3X5-FR Frosted LENS-3X5-SPR Spread
				LENS-3X5-BEL Elongating Beam 5221-HCL Honeycomb Lens

14" Mounting stake (12V), detachable shroud, 6' lead wire and direct burial gel filled wire nuts (12V) or standard wire nuts (120V) included

WALL WASH LED LANDSCAPE

- A uniform wide distribution wall wash from a small form factor
- IP66 Rated, protected against powerful water jets
- Solid die-cast brass or corrosion resistant aluminum alloy
- Factory sealed watertight fixtures
- Constant output for 9V-15V, 110V - 120V inputs

- Even Coverage at 15° Upwards, 50° x 80°



- Continuously Adjustable Brightness Control
Indexed at 2W, 4W, 8W, 13W, 16W



visit product
page online

WALL WASH LED LANDSCAPE

PATENTED



1838 listed
1598 listed

12V

- Integral brightness control

Input	9 - 15VAC
Power	2W to 16W / 2 - 23VA
Brightness	190 lm to 980 lm
Beam Angle	15° upward (50° by 80°)
CRI	85
Rated Life	70,000 hours

2700K Warm White

5021-27	BK	Black on Aluminum
	BZ	Bronze on Aluminum
	BBR	Bronze on Brass

3000K Pure White

5021-30	BK	Black on Aluminum
	BZ	Bronze on Aluminum
	BBR	Bronze on Brass

120V

- Integral brightness control

Input	110V - 120VAC
Power	3.5W to 14.5W
Brightness	95 lm to 855 lm
Beam Angle	15° upward (50° by 80°)
CRI	85
Rated Life	45,000 hours

3000K Pure White

5022-30	BK	Black on Aluminum
	BZ	Bronze on Aluminum
	BBR	Bronze on Brass



See photometric data on page 124

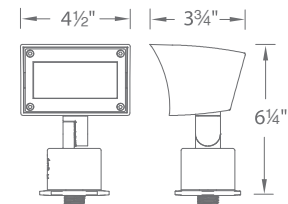

Transformer Required (order separately)

Accessories

Mounting Stake		9000-ST9-BZ 9000-ST14-BZ	Bronze Bronze	9" Durable PC stake 14" Durable PC stake
Power Stake		M6000-STAKE	Black	Easy wiring accessory designed for 120V products; eliminates the need for a separate J-box
Surface Mount Flange/Stake		5000-SCP-BK 5000-SCP-BZ 5000-SCP-BBR	Black on Aluminum Bronze on Aluminum Bronze on Brass	Includes three 7 inch threaded stainless steel stabilizing pins for ground mounting or surface mounts with four screws or over a junction box
Guardian Mount		9000-SP9-BZ	Stainless Steel	Heavy duty stainless steel spike to position fixture
Gutter Mount Bracket		5000-GM-BZ 5000-GM-BK	Stainless Steel Black on Aluminum	Stainless steel universal mounting bracket for gutter mounting fixture
Tree Mount Junction Box		5000-TCP-BK 5000-TCP-BZ	Black on Aluminum Bronze on Aluminum	Aluminum box with Stainless steel mounting screws; two 1/2" NPT threaded holes, UL 120V Listed
		5000-TCL-BK 5000-TCL-BZ	Black on Aluminum Bronze on Aluminum	Large aluminum box with stainless steel mounting screws; two 1/2" NPT threaded holes, UL 120V Listed
Large Tree Mount Canopy Strap		5000-TST-BK	Black on Steel/terylene	Ratcheting device with strap to be used with Large Tree Mount Junction Box (5000-TCL)
		5000-STB-BK	Black on Steel	Tree mount bracket only
Extension Rods		5000-X04-BZ,BK,BBR 4 in 5000-X08-BZ,BK,BBR 8 in 5000-X12-BZ,BK,BBR 12 in	5000-X18-BZ,BK,BBR 18 in 5000-X24-BZ,BK,BBR 24 in	Extends distance between Accent light and surface mount canopy, stake, or tree mount box
Rod L-Coupler		5000-LCO-BK 5000-LCO-BZ	Black Bronze	
Wall Wash Optics		LENS-2X4-AMB Amber LENS-2X4-GRN Green LENS-2X4-RED Red	LENS-2X4-BLU Blue LENS-2X4-FR Frosted LENS-2X4-SPR Spread	5021-HCL Honeycomb Lens

9" Mounting stake (12V), 6' lead wire and direct burial gel filled wire nuts (12V) or standard wire nuts (120V) included

MINI WALL WASH LED LANDSCAPE

WITH DUAL CCT AND INTEGRAL BRIGHTNESS CONTROL

- Select color temperature option
- IP66 Rated, protected against powerful water jets
- Solid die-cast brass or corrosion resistant aluminum alloy



visit product
page online

MINI WALL WASH LED LANDSCAPE

WITH DUAL CCT AND INTEGRAL BRIGHTNESS CONTROL

PATENTED



1838 listed

12V

- Transformer required (order separately)
- Integral brightness control. Select color temperature option
- Mounting stake and direct burial gel-filled wire nuts all included



See photometric data on page 124

Input: 9-15VAC
 Power: 1W to 8W / 2-12VA
 Lumens: 80 lm to 420 lm
 Beam Angle: Symmetrical (70° by 95°)
 CRI: 85
 Rated Life: 60,000 hours
 CCT: 2700K & 3000K
 Warm White & Pure White

2700 & 3000K Warm and Pure White





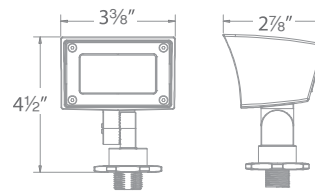



5121-27/30

BK Black on Aluminum
BZ Bronze on Aluminum
BBR Bronze on Brass



A uniform wide distribution wall wash from a small form factor

Accessories

Mounting Stake		9000-ST9-BZ 9000-ST14-BZ	Bronze	Durable PC stake
Surface Mount Flange/Stake		5000-SCP-BK 5000-SCP-BZ 5000-SCP-BBR	Black on Aluminum Bronze on Aluminum Bronze on Brass	Includes three 7 inch threaded stainless steel stabilizing pins for ground mounting or surface mounts with four screws or over a junction box
Guardian Mount		9000-SP9-BZ	Stainless Steel	Heavy duty stainless steel spike to position fixture;
Gutter Mount Bracket		5000-GM-BK 5000-GM-BZ	Black on Aluminum Bronze on Aluminum	Stainless steel universal mounting bracket for gutter mounting fixture
Tree Mount Junction Box		5000-TCP-BK 5000-TCP-BZ	Black on Aluminum Bronze on Aluminum	Aluminum box with stainless steel mounting screws; two 1/2" NPT threaded holes, UL 120V Listed
		5000-TCL-BK 5000-TCL-BZ	Black on Aluminum Bronze on Aluminum	Large aluminum box with stainless steel mounting screws; two 1/2" NPT threaded holes, UL 120V Listed
Large Tree Mount Canopy Strap		5000-TST-BK	Black on Steel/terylene	Ratcheting device with strap to be used with Large Tree Mount Junction Box (5000-TCL)
		5000-STB-BK	Black on Steel	Tree mount bracket only
Extension Rods		5000-X04-BZ,BK,BBR 5000-X08-BZ,BK,BBR 5000-X12-BZ,BK,BBR	4 in 8 in 12 in	5000-X18-BZ,BK,BBR 5000-X24-BZ,BK,BBR 18 in 24 in
Optics		LENS-2X3-AMB LENS-2X3-GRN LENS-2X3-RED	Amber Green Red	LENS-2X3-BLU LENS-2X3-FR LENS-2X3-SPR Blue Frosted Spread
		LENS-2X3-BEL 5121-HCL		Elongating Beam Honeycomb Lens

9" Mounting stake (12V), 6' lead wire and direct burial gel filled wire nuts (12V) or standard wire nuts (120V) included

3" INGROUND LED LANDSCAPE

- Tilt and adjust beam angles
- Integral brightness control
- IP67 Rated, protected from temporary immersion underwater
- Drive over up to 4500lbs
- Solid die-cast brass or corrosion resistant cast aluminum
- Available concrete pour kit
- Constant output for 9V-15V or 110V-120V inputs



visit product
page online

3" Inground Features

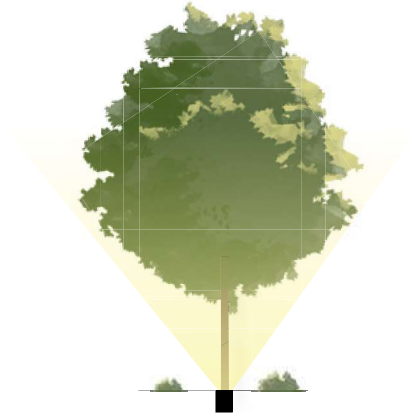

Typical Inground

Most light output goes into the air, causing light pollution



Adjust Beam Angles

Presets at 15°, 30°, 45°, 60°

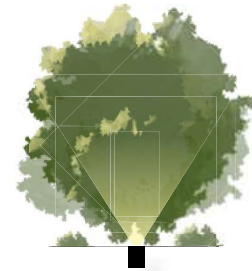

Adjustable WAC Inground

Adjust the light to where you need it

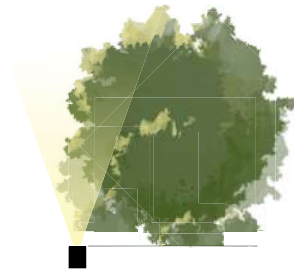

Typical Inground

Most light output goes into the air, causing light pollution



Tilt and Aim

Up to 40° of adjustability preset at -20°, -10°, 0°, 10°, 20°

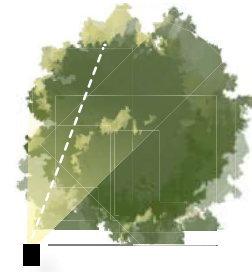

Adjustable WAC Inground

Adjust the light to where you need it

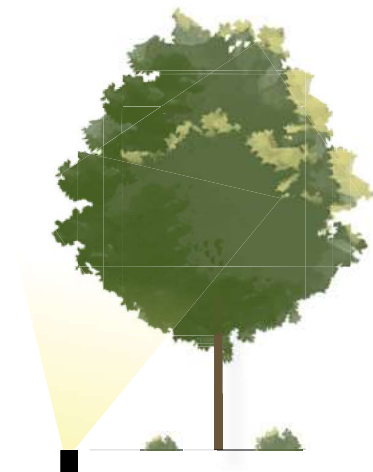

Control Brightness

Adjustable from 70 lm to 505 lm
Presets Comparable to
10W, 25W, 35W, 50W, 75W Halogen source

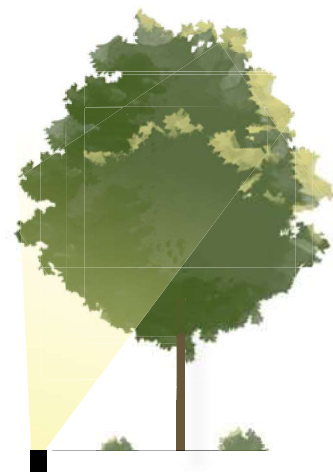



3" INGROUND LED LANDSCAPE



visit product
page online

3" INGROUND LED LANDSCAPE

PATENTED  
 1838 listed
 1598 listed

12V

- Integral brightness control
- Adjustable beam angle
- Directional aim with +/- 20° Tilt

Input	9-15VAC
Power	2W to 12W / 2-17VA
Brightness	70 lm to 505 lm
Beam Angle	15° to 60°
CRI	85
Rated Life	55,000 hours

2700K	<i>Warm White</i>
5031-27	BZ Bronze on Aluminum
	BBR Bronze on Brass

3000K	<i>Pure White</i>
5031-30	BZ Bronze on Aluminum
	BBR Bronze on Brass

Transformer Required (order separately)

120V

- Integral brightness control
- Adjustable beam angle

Input	110V - 120VAC
Power	3W to 11.5W
Brightness	65 lm to 515 lm
Beam Angle	15° to 60°
CRI	85
Rated Life	45,000 hours



3000K	<i>Pure White</i>
5032-30	BZ Bronze on Aluminum
	BBR Bronze on Brass

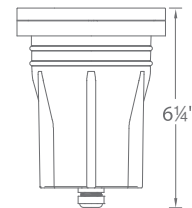
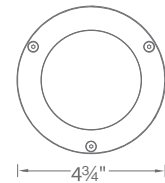

See photometric data on pages 121-122



Accessories

Non-slip lens		5030-NSLEN-CL	<i>Clear/patterned</i>	<i>Slip resistant lens</i>
Rock Guard		5030-GRD-BZ 5030-GRD-BBR	<i>Bronze on Aluminum</i> <i>Bronze on Brass</i>	<i>Protects the fixture surface</i>
Optics		LENS-25-AMB LENS-25-GRN LENS-25-RED LENS-25-BLU LENS-25-FR LENS-25-HCL	<i>Amber</i> <i>Green</i> <i>Red</i> <i>Blue</i> <i>Frosted</i> <i>Honeycomb Louver reduces glare</i>	<i>Enhances saturation of florals and foliage</i>
Concrete Pour Kit		5030-PIP-PVC	<i>Shown with temporary dense foam cap</i>	<i>For installation in concrete; five 1/2" NPT threaded holes, PC</i>

6' lead wire and direct burial gel filled wire nuts (12V) or standard wire nuts (120V) included

UNDERWATER SPOT LED LANDSCAPE



visit product
page online

UNDERWATER SPOT LED LANDSCAPE



- Machined brass thumb screws
- Cast brass construction
- IP68 Rated, suitable for continuous immersion
- Underwater in depths up to 3'
- Factory sealed watertight fixtures
- 30' long lead wire
- Limited lifetime warranty

Transformer Required (order separately)

Input	12-15VAC
Power	10W / 11.2VA
Brightness	780 lm
Beam Angle	60°
Color Temp	3000K Pure White
CRI	85
Rated Life	50,000 hours

5511-30 | **NB** Natural Brass

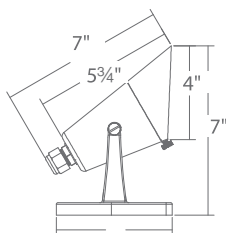
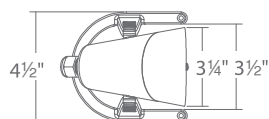

Accessories Submersible luminaires

Wall Wash Optics		LENS-20-AMB Amber LENS-20-GRN Green LENS-20-RED Red	LENS-20-BLU Blue LENS-20-FR Frosted LENS-20-SPR Spread	Enhances saturation of florals and foliage and turtle friendly
Direct Burial Waterproof Wire Nuts		9020-WNT-BK	Silicone filled wire nut with gasket (Pack of 20pcs)	

Detachable shroud and direct burial gel filled wire nuts (12V)

SUBMERSIBLE 2" INGROUND LED LANDSCAPE

- Constant output for 9V-15V input
- 100%-10% dimming - see specification sheet for list of tested dimmers
- May be used in conjunction with all WAC Landscape Lighting products
- Includes a detachable stainless steel mounting bracket for use in or out of water



visit product
page online

SUBMERSIBLE 2" INGROUND LED LANDSCAPE



676 listed

- Solid stainless steel construction
- IP68 Rated, suitable for continuous immersion under water
- Factory sealed watertight fixtures
- 30' long lead wire

Transformer Required (order separately)

Input	9-15VAC
Power	4.1W / 6.6VA
Brightness	245 lm
Beam Angle	25°
Color Temp	3000K
CRI	85
Rated Life	70,000 hours

3000K *Pure White*

2031-30 | **SS** Stainless Steel



Includes stainless steel easy mount accessory for use with underwater applications and above ground on any surface

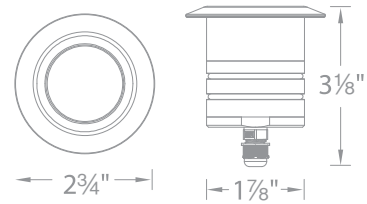

Designed for underwater or wet application
30ft long lead wire

RECESSED INGROUNDS + INDICATOR LED LANDSCAPE

- IP68 Rated, suitable for continuous immersion under water
- Factory sealed watertight fixtures
- Solid stainless steel construction
- Options for use in outdoor downlight applications
- Constant output for 9V-15V input
- 100%-10% dimming - see specification sheet for list of tested dimmers
- Available concrete pour kit with 18" PVC pipe which can be field shortened



visit product
page online

RECESSED INGROUNDS + INDICATOR LED LANDSCAPE



1" APERTURE

Input	9-15VAC	CRI	85
Power	1.9W / 3VA	Beam Angle	50°
Brightness	Up to 80 lm	Rated Life	70,000 hours
Color Temp	2700K Warm white, 3000K Pure white		

Transformer Required (order separately)



1" Slim Round

1011-27 2700K
1011-30 3000K | **SS** Stainless Steel



1" Round

1021-27 2700K
1021-30 3000K | **SS** Stainless Steel



1" Square

1051-27 2700K
1051-30 3000K | **SS** Stainless Steel

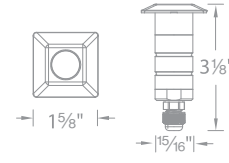
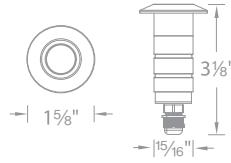
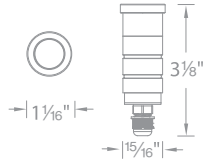

1" Scoop

1061-27 2700K | **BS** Bronze Stainless steel
1061-30 3000K | **SS** Stainless Steel



1" Shroud

1031-27 2700K | **BS** Bronze Stainless steel
1031-30 3000K | **SS** Stainless Steel



1" Louver

1041-27 2700K | **BS** Bronze Stainless steel
1041-30 3000K | **SS** Stainless Steel

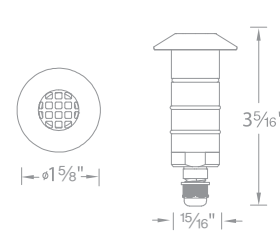
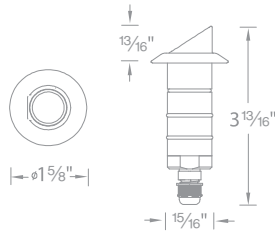
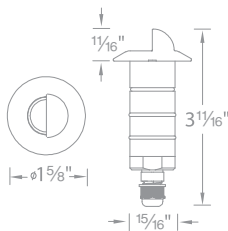

6' Lead Wire included

Optional spring clip accessory included

Optional spring clip accessory included



1000-CON-PVC
1" Concrete Pour Kit

For installation in concrete. 18" PVC pipe included. Installs onto a 4" outdoor rated junction box.

2" RECESSED INGROUNDS + INDICATOR LED LANDSCAPE



2" APERTURE

Input	9-15VAC	Color Temp	2700K Warm white, 3000K Pure white
Power	4.1W / 6.6VA	CRI	85
Brightness	Up to 245 lm	Rated Life	70,000 hours
		Beam Angle	30° (When an open top is used)



Transformer Required (order separately)
 Optional spring clip accessory included
 6' Lead Wire included



2" GROUND HOOD

Beam Angle: *Asymmetrical*

2081-27	2700K	BS	<i>Bronzed Stainless Steel</i>
2081-30	3000K	SS	<i>Stainless Steel</i>

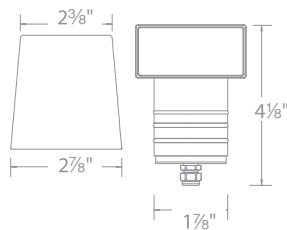

Optional spring clip accessory included

- IP68 Rated, suitable for continuous immersion under water
- Factory sealed watertight fixtures
- Solid stainless steel construction
- Constant output for 9V-15V input
- 10%-100% dimming - see specification sheet for list of tested dimmers
- Available concrete pour kit with 18" PVC pipe which can be field shortened



visit product page online



visit product page online



2000-CON-PVC
 2" Concrete Pour Kit

For installation in concrete.
 18" PVC pipe included. installs onto a 4" outdoor rated junction box.



2" Slim Round

2011-27 2700K **BS** *Bronzed Stainless Steel*
2011-30 3000K **SS** *Stainless Steel*



2" Round

2021-27 2700K **BS** *Bronzed Stainless Steel*
2021-30 3000K **SS** *Stainless Steel*



2" Square

2051-27 2700K **BS** *Bronzed Stainless Steel*
2051-30 3000K **SS** *Stainless Steel*

2" Slim Round with Honeycomb Louver

2012-27 2700K **BS** *Bronzed Stainless Steel*
2012-30 3000K **SS** *Stainless Steel*

2" Round with Honeycomb Louver

2022-27 2700K **BS** *Bronzed Stainless Steel*
2022-30 3000K **SS** *Stainless Steel*

2" Square with Honeycomb Louver

2052-27 2700K **BS** *Bronzed Stainless Steel*
2052-30 3000K **SS** *Stainless Steel*

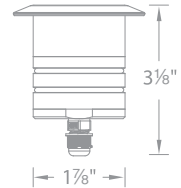
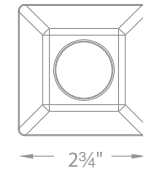
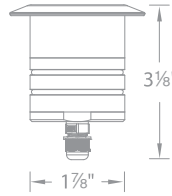
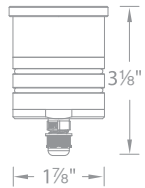

2" Quad-Directional

2101-27 2700K **BS** *Bronzed Stainless Steel*
2101-30 3000K **SS** *Stainless Steel*



2" Single Direction

2091-27 2700K **BS** *Bronzed Stainless Steel*
2091-30 3000K **SS** *Stainless Steel*



2" Bi-Directional

2071-27 2700K **BS** *Bronzed Stainless Steel*
2071-30 3000K **SS** *Stainless Steel*

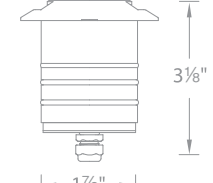
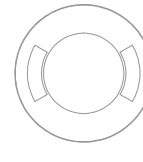
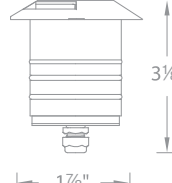
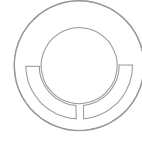
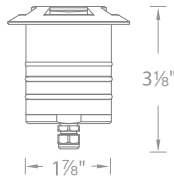

2" Scoop

2131-27 2700K **BS** *Bronzed Stainless Steel*
2131-30 3000K **SS** *Stainless Steel*



2" Shroud

2111-27 2700K **BS** *Bronzed Stainless Steel*
2111-30 3000K **SS** *Stainless Steel*



2" Louver

2121-27 2700K **BS** *Bronzed Stainless Steel*
2121-30 3000K **SS** *Stainless Steel*

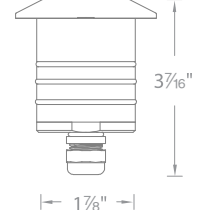
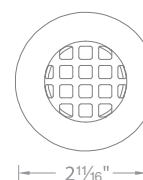
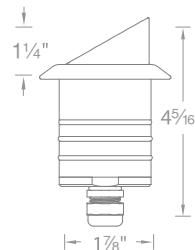
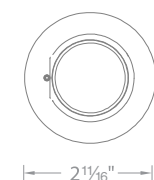
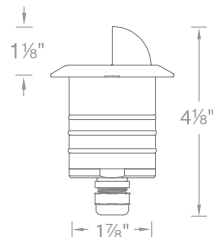
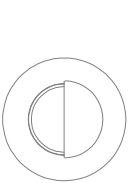

TREE LIGHTS

New!



visit product
page online

TREE LIGHTS LED LIGHT

12V

New!



1838 listed

Input	9-15VAC
Power	1W to 7.5W / 2VA - 8VA
Brightness	45 lm to 380 lm
Color Temp	2700K / 3000K / 4000K
CRI	85
Rated Life	50,000 hours

Transformer Required (order separately)

3811-27/30/40

BK Black on Aluminum
BZ Bronze on Aluminum

6' Chain included

3821-27/30/40

BK Black on Aluminum
BZ Bronze on Aluminum

6' Chain included

3831-27/30/40

BK Black on Aluminum
BZ Bronze on Aluminum
WT White on Aluminum

3821



3831



3811

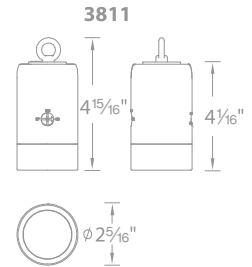
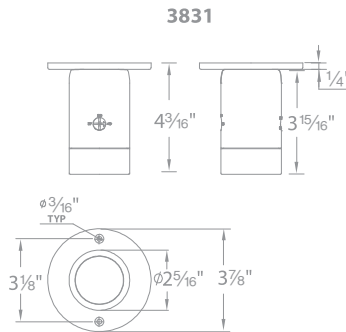
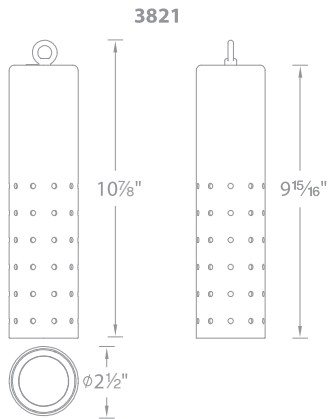

Select Warm White, Pure White, or Cool White (2700K, 3000K or 4000K)



Continuously Adjustable Beam Angles Indexed at 35°, 45°, 55°



Continuously Adjustable Brightness

Accessories

Optics



LENS-11-AMB
LENS-11-GRN
LENS-11-RED

Amber
Green
Red

LENS-11-BLU
LENS-11-FR

Blue
Frosted

CYLINDER WALL MOUNT

New!



visit product
page online

CYLINDER WALL MOUNT

FULLY ADJUSTABLE UP AND DOWNLIGHTS

PATENT
PENDING



IP66



New!

Input	9-15VAC
Power	15W/18VA (7.5W/9.0VA per light)
Brightness	650 lm (325 lm per light)
Color Temp	2700K / 3000K / 4000K
CRI	85
Rated Life	50,000 hours

Transformer Required (order separately)

3611-27/30/40	BK	Black on Aluminum
	BZ	Bronze on Aluminum
	WT	White on Aluminum

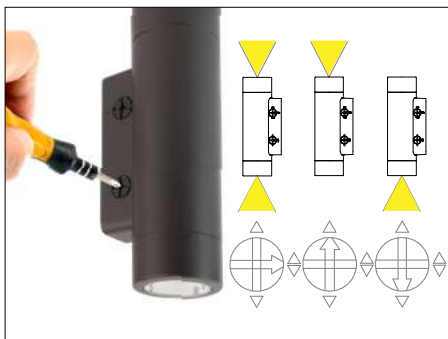
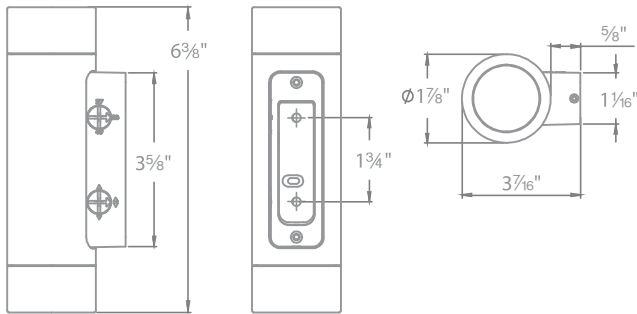

Select Up Light, Down Light
or Both



Continuously Adjustable Beam Angles
Indexed at 35°, 45°, 55°



Select Warm White, Pure White, or Cool White
(2700K, 3000K or 4000K)

Accessories

Optics		LENS-11-AMB	Amber	LENS-11-BLU	Blue
		LENS-11-GRN	Green	LENS-11-FR	Frosted
		LENS-11-RED	Red		

SURFACE MOUNT INDICATOR LED LIGHT

New!



visit product
page online

SURFACE MOUNT INDICATOR LED LIGHT



New!

2" APERTURE

Input 9-15VAC
 Power 2.8W / 3.2VA
 Brightness 3.5 lm - 60 lm
 Color Temp 2700K / 3000K

CRI 90
 Rated Life 60,000 hours

Transformer Required (order separately)
 10' Lead Wire included



2541-27 2700K **BS** *Bronzed Stainless Steel*
2541-30 3000K **SS** *Stainless Steel*

2591-27 2700K **BS** *Bronzed Stainless Steel*
2591-30 3000K **SS** *Stainless Steel*

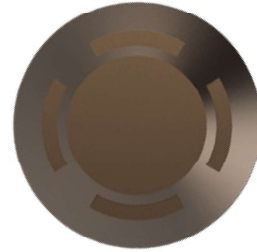
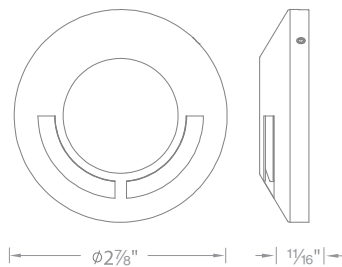
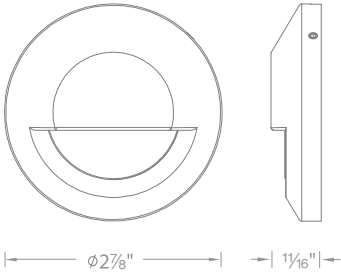

2511-27 2700K **BS** *Bronzed Stainless Steel*
2511-30 3000K **SS** *Stainless Steel*

2571-27 2700K **BS** *Bronzed Stainless Steel*
2571-30 3000K **SS** *Stainless Steel*

2501-27 2700K **BS** *Bronzed Stainless Steel*
2501-30 3000K **SS** *Stainless Steel*

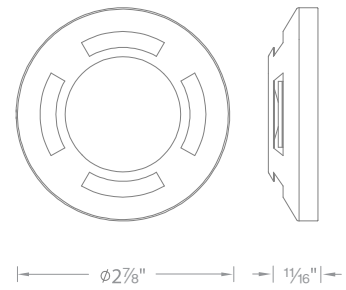
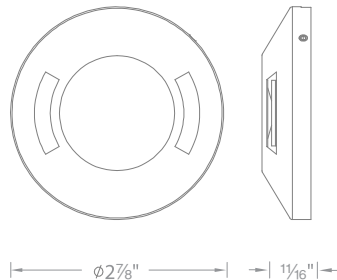
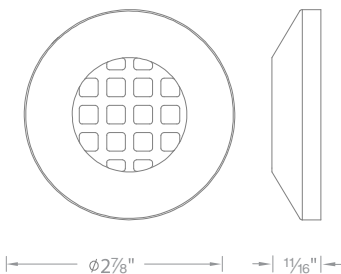

HARDSCAPE LED LANDSCAPE

NEW WITH QUICK RELEASE LIGHT ENGINE, DUAL CCT AND INTEGRAL BRIGHTNESS CONTROL



Select Warm White (2700K) or Pure White (3000K) light



PATENTED QUICK RELEASE
Based on popular demand, our new patented invention allows for a watertight male/female connection at the fixture for ease of replacement after it is installed

IP66 cULus
1838 listed



Continuously adjustable brightness



Removable stainless steel capstone bracket and rotating mounting clips included

LED HARDSCAPE

WITH ALL THE FEATURES YOU NEED



visit product
page online

HARDSCAPE LED LANDSCAPE

EASILY SERVICEABLE, SWITCH WARM TO PURE WHITE, AND ONBOARD DIMMING



12V

- Quick Release connection at fixture to easily detach from capstone bracket after installation
- Integral Brightness control
- Select Color Temperature in the field
- Corrosion-resistant aluminum alloy
- Factory-sealed watertight fixture
- Transformer required (sold separately)
- Tightly spaced and diffused LEDs for even illumination
- 6' lead wire and direct burial gel-filled wire nuts included

Input: 9-15V
Beam Angle: 110°
CRI: 85
Rated Life: 70,000 hours

See photometric data on page 123



7182-27/30 18 inches



7122-27/30 12 inches



7062-27/30 6 inches



7032* 3 inches

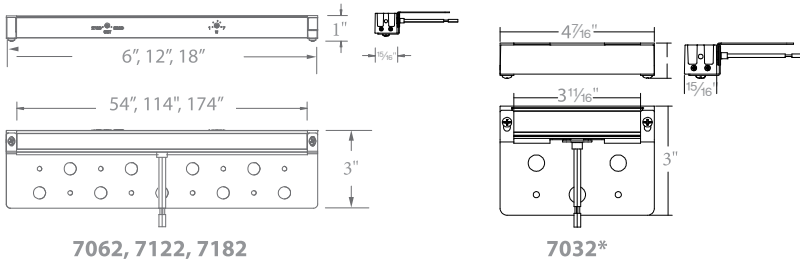

Length	Model	Color Temp	Wattage	Max Lumens	Finishes
3"	7032-27 7032-30	2700K Warm White* 3000K Pure White*	1.5W, 2.6VA	50	BK Black on Aluminum BZ Bronze on Aluminum GH Graphite on Aluminum SD Sand on Aluminum
6"	7062-27/30	2700K Warm White 3000K Pure White	4.5W, 5.6VA	110	BK Black on Aluminum BZ Bronze on Aluminum BBR Bronze on Brass GH Graphite on Aluminum SD Sand on Aluminum
12"	7122-27/30	2700K Warm White 3000K Pure White	7.0W, 7.6VA	230	BK Black on Aluminum BZ Bronze on Aluminum BBR Bronze on Brass GH Graphite on Aluminum SD Sand on Aluminum
18"	7182-27/30	2700K Warm White 3000K Pure White	8.5W, 9.3VA	350	BK Black on Aluminum BZ Bronze on Aluminum GH Graphite on Aluminum SD Sand on Aluminum

Example: **7182-27/30SD**

*Due to its compact size, the 7032 is dedicated in either 2700K or 3000K.

LINEAR PATH LIGHT LED LANDSCAPE



visit product
page online

LINEAR PATH LIGHT LED LANDSCAPE



12V

- Low profile and discreet
- 180° fully rotatable fixture aiming
- Lock desired position in place after adjustment
- Wide Flood Beam 110° x 80°
- Adjustable anti-glare shroud
- Designed for soft ground, wood floor and concrete
- Base mount, riser mount & extension mount
- Path & Accent applications

Transformer Required (order separately)



Input: 9-15VAC
Power: 6.0W/8.6VA
Brightness: 190lm
Beam Angle: 110° x 80°
CRI: 85
Rated Life: 60,000 hours

Model	Color	Finish
6401-27	2700K	BK Black on Aluminum
		BZ Bronze on Aluminum
6401-30	3000K	BK Black on Aluminum
		BZ Bronze on Aluminum

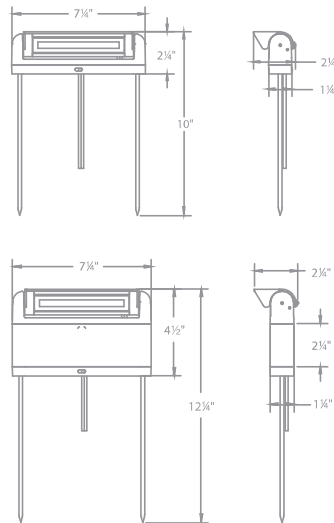



Optional riser attachment included



Extension mount included (Order extension rods separately)

Accessories

9" Mounting Stake		9000-ST9-BZ	Bronze	Durable PC stake
Extension Rods		5000-X04-BZ,BK 5000-X08-BZ,BK 5000-X12-BZ,BK 5000-X18-BZ,BK 5000-X24-BZ,BK	4 in 8 in 12 in 18 in 24 in	Black Bronze Extends distance between Accent light and surface mount canopy, stake, or tree mount box

Detachable shroud, 10' lead wire and direct burial gel filled wire nuts (12V).



visit product
page online

INTERPATH LED AREA LIGHT



- Simple design with small form factor, natural fit to any landscape
- Sturdy center mount design works well in applications where area illumination is desired
- Recommended spacing for installation:
Residential: 4 to 6ft
Commercial: 3 to 4ft

Input	9-15VAC
Power	2.5W / 2.7VA
Brightness	Up to 100 lm
Color Temp	2700K Warm white, 3000K Pure white
CRI	90
Rated Life	60,000 hours

6511-27	2700K	BK	Black on Aluminum
6511-30	3000K	BZ	Bronze on Aluminum
		BBR	Bronze on Brass

6521-27	2700K	BK	Black on Aluminum
6521-30	3000K	BZ	Bronze on Aluminum

EXAMPLE: 6511-30BBR

9" Mounting stake, 6 foot lead wire, and direct burial gel filled wire nuts included

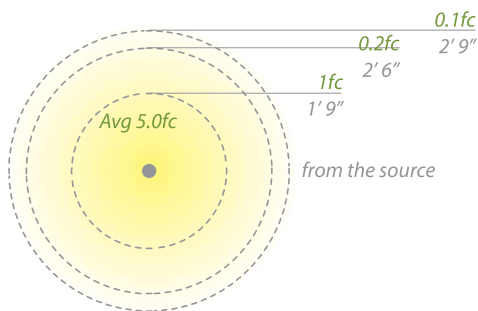

Accessories

9" Mounting Stake		9000-ST9-BZ	Bronze	Durable PC stake
14" Mounting Stake		9000-ST14-BZ	Bronze	Durable PC stake
Surface Mount Flange/Stake		5000-SCP-BK 5000-SCP-BZ 5000-SCP-BBR	Black on Aluminum Bronze on Aluminum Bronze on Brass	Includes three 7 inch threaded stainless steel stabilizing pins for ground mounting or surface mounts with four screws or over a junction box
Guardian Mount		9000-SP9-BZ	Stainless Steel	Heavy duty stainless steel spike to position fixture

TIKI LED AREA LIGHT

- IP66 Rated, protected against high-pressure water jets
- Factory sealed, watertight fixtures
- Solid brass or corrosion resistant aluminum alloy
- Constant output for 9V-15V input



visit product
page online

TIKI LED AREA LIGHT



- Sturdy center mount design works well in applications where area illumination is desired
- Recommended spacing for installation:
Residential: 7 to 9ft
Commercial: 5 to 7ft

Input	9-15VAC
Power	6.5W / 9.5VA
Brightness	Up to 225 lm
Color Temp	2700K Warm white, 3000K Pure white
CRI	90
Rated Life	60,000 hours

22"			
6041-27	2700K	BK	Black on Aluminum
6041-30	3000K	BZ	Bronze on Aluminum
		BBR	Bronze on Brass
15"			
6042-27	2700K	BK	Black on Aluminum
6042-30	3000K	BZ	Bronze on Aluminum

Example: 6041-30BBR

9" Mounting stake, 6 foot lead wire, and direct burial gel filled wire nuts included

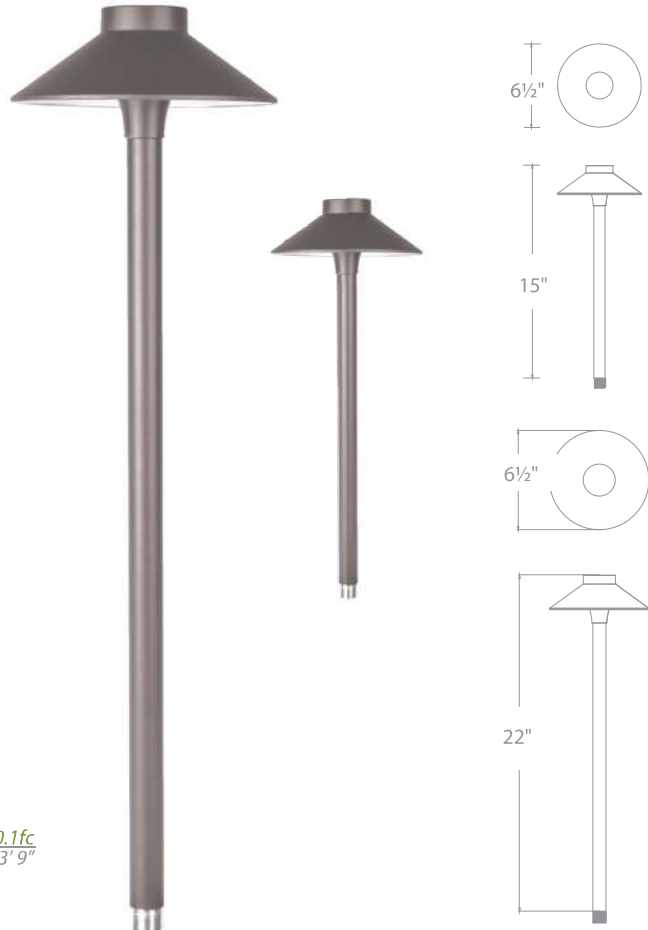
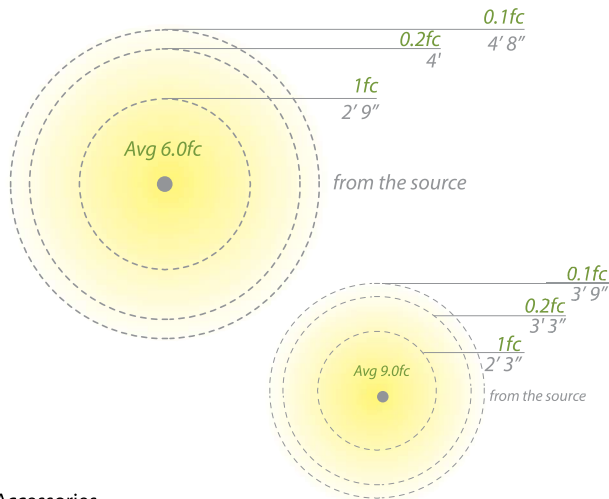

Accessories

9" Mounting Stake		9000-ST9-BZ	Bronze	Durable PC stake
14" Mounting Stake		9000-ST14-BZ	Bronze	Durable PC stake
Surface Mount Flange/Stake		5000-SCP-BK 5000-SCP-BZ 5000-SCP-BBR	Black on Aluminum Bronze on Aluminum Bronze on Brass	Includes three 7 inch threaded stainless steel stabilizing pins for ground mounting or surface mounts with four screws or over a junction box
Guardian Mount		9000-SP9-BZ	Stainless Steel	Heavy duty stainless steel spike to position fixture

CANOPY LED AREA LIGHT

- IP66 Rated, protected against high-pressure water jets
- Factory sealed, watertight fixtures
- Solid brass or corrosion resistant aluminum alloy
- Constant output for 9V-15V input



visit product
page online

CANOPY LED AREA LIGHT



- Sturdy center mount design works well in applications where area illumination is desired
- Recommended spacing for installation:
Residential: 7 to 9ft
Commercial: 5 to 7ft

Input Power	9-15V 6.5W/9.5VA
Brightness	Up to 225 lm
Color Temp	2700 & 3000K
CRI	90
Rated Life	60,000 hours

8" Cap
2700 & 3000K Warm and Pure White

- 6051-27** | **BK** Black on Aluminum
6051-30 | **BZ** Bronze on Aluminum
BBR Bronze on Brass

6" Cap
2700 & 3000K Warm and Pure White

- 6053-27** | **BK** Black on Aluminum
6053-30 | **BZ** Bronze on Aluminum
BBR Bronze on Brass

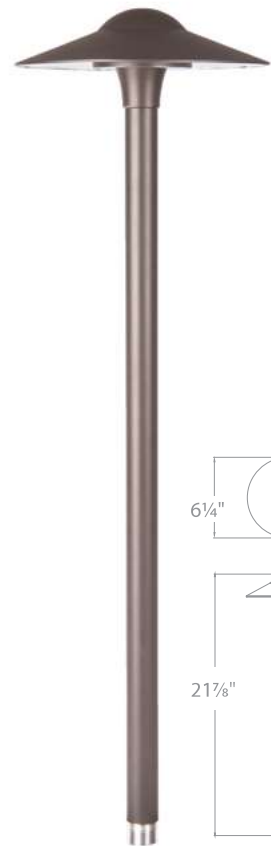



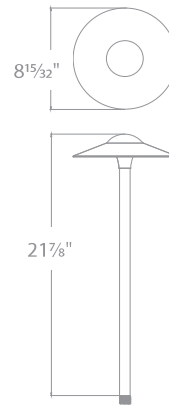
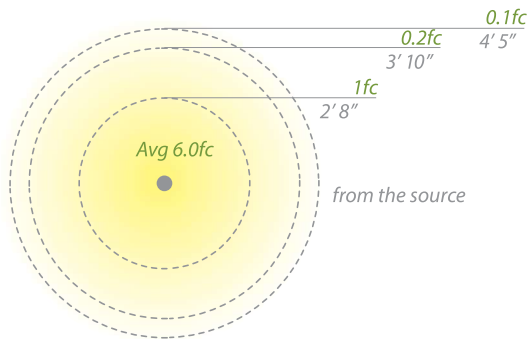

EXAMPLE: 6051-30BZ

Mounting stake, 6 foot lead wire, and direct burial gel filled wire nuts included



Accessories

9" Mounting Stake		9000-ST9-BZ	Bronze	Durable PC stake
14" Mounting Stake		9000-ST14-BZ	Bronze	Durable PC stake
Surface Mount Flange/Stake		5000-SCP-BK 5000-SCP-BZ 5000-SCP-BBR	Black on Aluminum Bronze on Aluminum Bronze on Brass	Includes three 7-inch threaded stainless steel stabilizing pins for ground mounting or surface mounts with four screws or over a junction box
Guardian Mount		9000-SP9-BZ	Stainless Steel	Heavy duty stainless steel spike to position fixture; formed from a single piece of metal

LEDGE LED PATH

- IP66 Rated, protected against high-pressure water jets
- Factory sealed, watertight fixtures
- Constant output for 9V-15V input



visit product
page online

LEDGE LED PATH



- Sleek linear design blends seamlessly into pathways while providing soft, even illumination
- Recommended spacing for installation:
Residential: 8 to 10ft
Commercial: 5 to 7ft
- Transformer Required (order separately)

Input	9-15VAC
Power	3.0W / 4.5VA
Brightness	Up to 105 lm
Color Temp	2700K Warm white, 3000K Pure white
CRI	90
Rated Life	60,000 hours

6081-27	2700K	BK	<i>Black on Aluminum</i>
6081-30	3000K	BZ	<i>Bronze on Aluminum</i>

Example: 6081-27BZ

14" Mounting stake, 6 foot lead wire, and direct burial gel filled wire nuts included

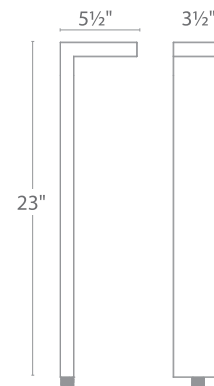
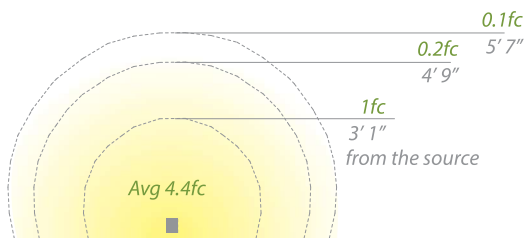

Accessories

9" Mounting Stake		9000-ST9-BZ	Bronze	Durable PC stake
14" Mounting Stake		9000-ST14-BZ	Bronze	Durable PC stake
Surface Mount Flange/Stake		5000-SCP-BK 5000-SCP-BZ 5000-SCP-BBR	Black on Aluminum Bronze on Aluminum Bronze on Brass	Includes three 7 inch threaded stainless steel stabilizing pins for ground mounting or surface mounts with four screws or over a junction box
Guardian Mount		9000-SP9-BZ	Stainless Steel	Heavy duty stainless steel spike to position fixture

SLIDE LED PATH

- IP66 Rated, protected against high-pressure water jets
- Factory sealed, watertight fixtures
- Constant output for 9V-15V input



visit product
page online

SLIDE LED PATH



- Sleek linear design blends seamlessly into pathways while providing soft, even illumination
- Recommended spacing for installation:
Residential: 9 to 11ft
Commercial: 5 to 7ft
- Transformer Required (order separately)

Input 9-15VAC
 Power 3.0W / 4.5VA
 Brightness Up to 95 lm
 Color Temp 3000K
 CRI 90
 Rated Life 60,000 hours

3000K Pure White

6311- Small **BZ** Bronze on Aluminum
6321- Large

14" Mounting stake, 6 foot lead wire, and direct burial gel filled wire nuts included

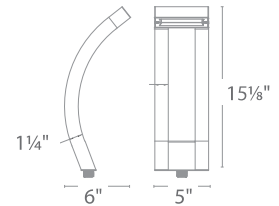

6311

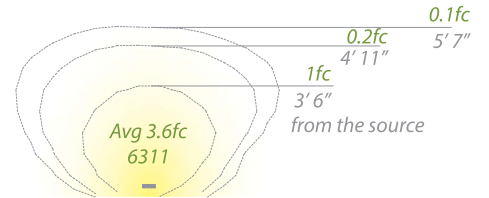



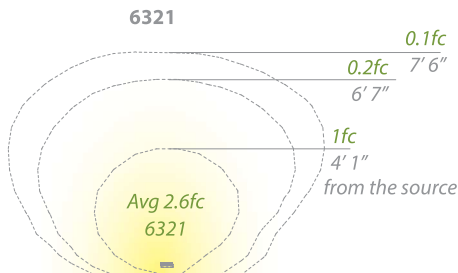
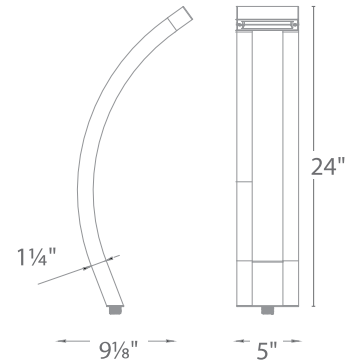

6311 Small
 Residential: 7 to 9ft
 Commercial: 4 to 6ft

6321 Large
 Residential: 9 to 11ft
 Commercial: 5 to 7ft



Accessories

9" Mounting Stake		9000-ST9-BZ	Bronze	Durable PC stake
14" Mounting Stake		9000-ST14-BZ	Bronze	Durable PC stake
Surface Mount Flange/Stake		5000-SCP-BK 5000-SCP-BZ 5000-SCP-BBR	Black on Aluminum Bronze on Aluminum Bronze on Brass	Includes three 7 inch threaded stainless steel stabilizing pins for ground mounting or surface mounts with four screws or over a junction box
Guardian Mount		9000-SP9-BZ	Stainless Steel	Heavy duty stainless steel spike to position fixture

SLOPE LED PATH

- IP66 Rated, protected against high-pressure water jets
- Factory sealed, watertight fixtures
- Constant output for 9V-15V input



visit product
page online

SLOPE LED PATH



- Sleek linear design blends seamlessly into pathways while providing soft, even illumination
- Recommended spacing for installation :
Residential: 7 to 9ft
Commercial: 4 to 6ft
- Transformer Required (order separately)

Input	9-15VAC
Power	2.9W / 4.7VA
Brightness	Up to 95 lm
Color Temp	2700K Warm white, 3000K Pure white
CRI	90
Rated Life	60,000 hours

6021-27	2700K	BK	Black on Aluminum
6021-30	3000K	BZ	Bronze on Aluminum

Example: 6021-30BK

14" Mounting stake, 6 foot lead wire, and direct burial gel filled wire nuts included

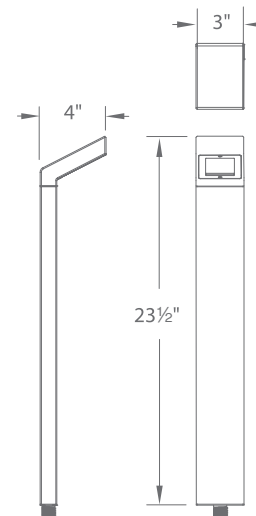
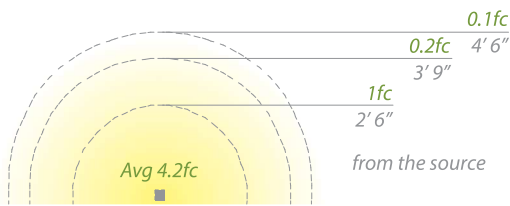

Accessories

9" Mounting Stake		9000-ST9-BZ	Bronze	Durable PC stake
14" Mounting Stake		9000-ST14-BZ	Bronze	Durable PC stake
Surface Mount Flange/Stake		5000-SCP-BK 5000-SCP-BZ	Black on Aluminum Bronze on Aluminum	Includes three 7 inch threaded stainless steel stabilizing pins for ground mounting or surface mounts with four screws or over a junction box
Guardian Mount		9000-SP9-BZ	Stainless Steel	Heavy duty stainless steel spike to position fixture

BALANCE SINGLE LED PATH

- IP66 Rated, protected against high-pressure water jets
- Factory sealed, watertight fixtures
- Constant output for 9V-15V input



visit product
page online

BALANCE SINGLE LED PATH



- Sleek linear design blends seamlessly into pathways while providing soft, even illumination
- Recommended spacing for installation :
Residential: 11 to 13ft
Commercial: 7 to 9ft
- Transformer Required (order separately)

Input	9-15VAC
Power	6.5W / 11.5VA
Brightness	Up to 275 lm
Color Temp	2700K Warm white, 3000K Pure white
CRI	90
Rated Life	60,000 hours



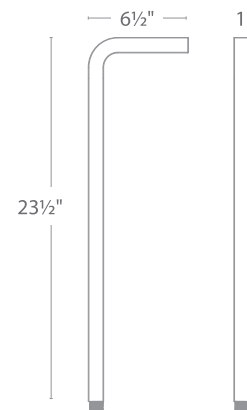
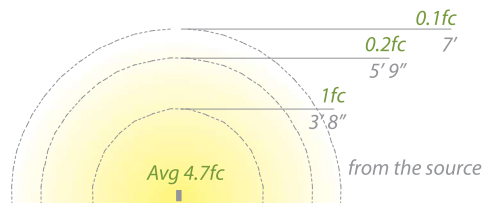

6061-27	2700K	BK	Black on Aluminum
6061-30	2700K	BZ	Bronze on Aluminum

Example: 6061-30BZ

9" Mounting stake, 6 foot lead wire, and direct burial gel filled wire nuts included



Accessories

9" Mounting Stake		9000-ST9-BZ	Bronze	Durable PC stake
14" Mounting Stake		9000-ST14-BZ	Bronze	Durable PC stake
Surface Mount Flange/Stake		5000-SCP-BK 5000-SCP-BZ	Black on Aluminum Bronze on Aluminum	Includes three 7 inch threaded stainless steel stabilizing pins for ground mounting or surface mounts with four screws or over a junction box
Guardian Mount		9000-SP9-BZ	Stainless Steel	Heavy duty stainless steel spike to position fixture

BALANCE DOUBLE LED PATH

- IP66 Rated, protected against high-pressure water jets
- Factory sealed, watertight fixtures
- Constant output for 9V-15V input



visit product
page online

BALANCE DOUBLE LED PATH



- Sleek linear design blends seamlessly into pathways while providing soft, even illumination
- Recommended spacing for installation :
Residential: 11 to 13ft
Commercial: 7 to 9ft
- Transformer Required (order separately)

Input	9-15VAC
Power	10W / 14VA
Brightness	Up to 375 lm
Color Temp	2700K Warm white, 3000K Pure white
CRI	90
Rated Life	60,000 hours

6071-27	2700K	BK	Black on Aluminum
6071-30	3000K	BZ	Bronze on Aluminum



Example: 6071-30BZ

9" Mounting stake, 6 foot lead wire, and direct burial gel filled wire nuts included

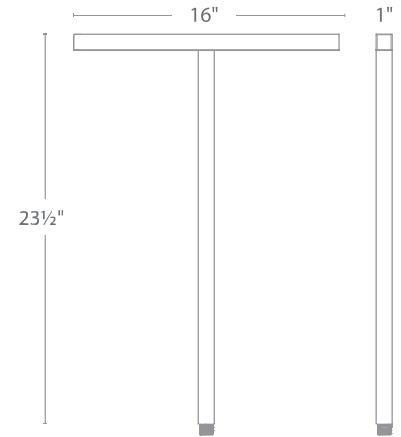
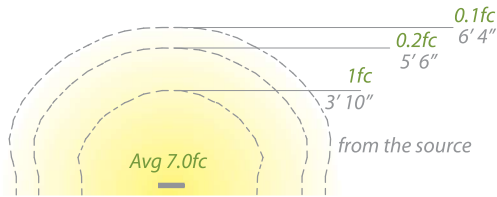

Accessories

9" Mounting Stake		9000-ST9-BZ	Bronze	Durable PC stake
14" Mounting Stake		9000-ST14-BZ	Bronze	Durable PC stake
Surface Mount Flange/Stake		5000-SCP-BK 5000-SCP-BZ	Black on Aluminum Bronze on Aluminum	Includes three 7 inch threaded stainless steel stabilizing pins for ground mounting or surface mounts with four screws or over a junction box
Guardian Mount		9000-SP9-BZ	Stainless Steel	Heavy duty stainless steel spike to position fixture

QUAD LED PATH

- IP66 Rated, protected against high-pressure water jets
- Factory sealed, watertight fixtures
- Constant output for 9V-15V input



visit product
page online

QUAD LED PATH



- Sleek linear design blends seamlessly into pathways while providing soft, even illumination
- Recommended spacing for installation :
Residential: 8 to 10ft
Commercial: 5 to 7ft
- Transformer Required (order separately)

Input	9-15VAC
Power	3W / 4.5VA
Brightness	Up to 100 lm
Color Temp	2700K Warm white, 3000K Pure white
CRI	90
Rated Life	60,000 hours

6091-27	2700K	BZ Bronze on Aluminum
6091-30	3000K	

Example: 6091-30BZ

14" Mounting stake, 6 foot lead wire, and direct burial gel filled wire nuts included

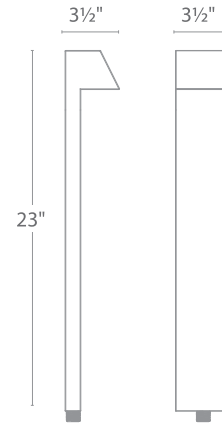
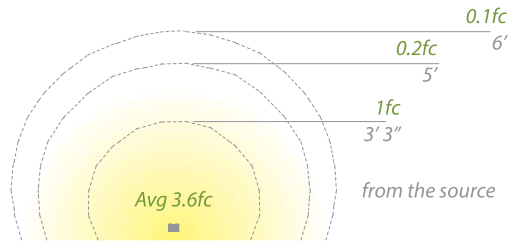

Accessories

9" Mounting Stake		9000-ST9-BZ	Bronze	Durable PC stake
14" Mounting Stake		9000-ST14-BZ	Bronze	Durable PC stake
Surface Mount Flange/Stake		5000-SCP-BK 5000-SCP-BZ	Black on Aluminum Bronze on Aluminum	Includes three 7 inch threaded stainless steel stabilizing pins for ground mounting or surface mounts with four screws or over a junction box
Guardian Mount		9000-SP9-BZ	Stainless Steel	Heavy duty stainless steel spike to position fixture

ECLIPSE LED PATH

- IP66 Rated, protected against high-pressure water jets
- Factory sealed, watertight fixtures
- Solid die-cast corrosion resistant aluminum alloy
- Constant output for 9V-15V input



visit product
page online

ECLIPSE LED PATH



- Sturdy side mount design works well in applications where directional illumination is desired
- Recommended spacing for installation :
Residential: 8 to 10ft
Commercial: 5 to 7ft
- Transformer Required (order separately)

Input	9-15VAC
Power	2.9W / 4.7VA
Brightness	Up to 125 lm
Color Temp	2700K Warm white, 3000K Pure white
CRI	90
Rated Life	60,000 hours

6031-27	2700K	BK	Black on Aluminum
6031-30	3000K	BZ	Bronze on Aluminum

Example: 6031-30BZ

14" Mounting stake, 6 foot lead wire, and direct burial gel filled wire nuts included

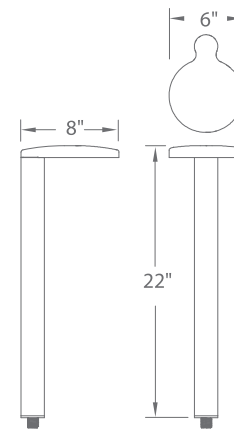
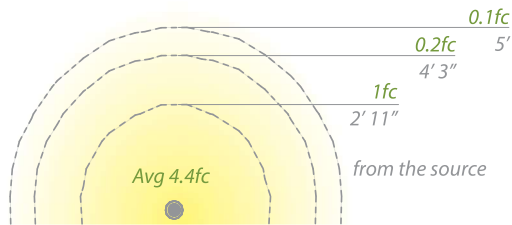

Accessories

9" Mounting Stake		9000-ST9-BZ	Bronze	Durable PC stake
14" Mounting Stake		9000-ST14-BZ	Bronze	Durable PC stake
Surface Mount Flange/Stake		5000-SCP-BK 5000-SCP-BZ	Black on Aluminum Bronze on Aluminum	Includes three 7 inch threaded stainless steel stabilizing pins for ground mounting or surface mounts with four screws or over a junction box
Guardian Mount		9000-SP9-BZ	Stainless Steel	Heavy duty stainless steel spike to position fixture

AREA LED AREA LIGHT

- IP66 Rated, protected against high-pressure water jets
- Factory sealed, watertight fixtures
- Solid brass or corrosion resistant aluminum alloy
- Constant output for 9V-15V input



visit product
page online

AREA LED AREA LIGHT



- Broad appeal makes this fixture suitable for varying landscape designs
- Recommended spacing for installation :
Residential: 11 to 13ft
Commercial: 7 to 9ft
- Transformer Required (order separately)

Input	9-15VAC
Power	5.8W / 9.4VA
Brightness	Up to 150 lm
Color Temp	2700K Warm white, 3000K Pure white
CRI	90
Rated Life	60,000 hours

6011-27	2700K	BK	Black on Aluminum
6011-30	3000K	BZ	Bronze on Aluminum
		BBR	Bronze on Brass

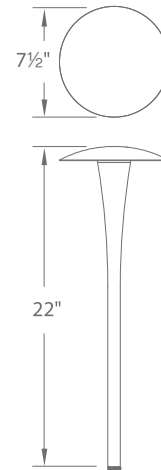



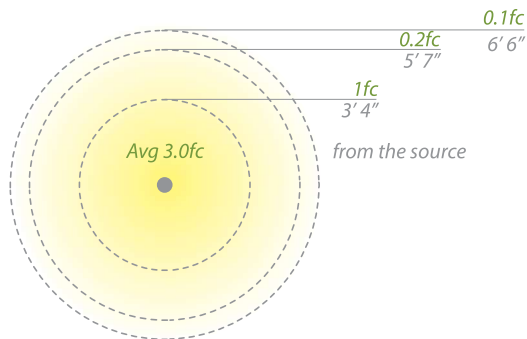

Example: 6011-30BZ

Mounting stake, 6 foot lead wire, and direct burial gel filled wire nuts included



Accessories

9" Mounting Stake		9000-ST9-BZ	Bronze	Durable PC stake
14" Mounting Stake		9000-ST14-BZ	Bronze	Durable PC stake
Surface Mount Flange/Stake		5000-SCP-BK 5000-SCP-BZ	Black on Aluminum Bronze on Aluminum	Includes three 7 inch threaded stainless steel stabilizing pins for ground mounting or surface mounts with four screws or over a junction box
Guardian Mount		9000-SP9-BZ	Stainless Steel	Heavy duty stainless steel spike to position fixture

GATE LED BOLLARD/PATH

- IP66 Rated, protected against high-pressure water jets
- Factory sealed, watertight fixtures
- Constant output for 9V-15V input
- Mounting accessories included



visit product
page online

GATE LED BOLLARD/PATH



- IP66 Rated, protected against high-pressure water jets
- Factory sealed, watertight fixtures
- Constant output for 9V-15V input
- Mounting accessories included
- Detachable back plate for lighting control included
- Transformer Required (order separately)

Input	9-15VAC
Power	7.2W, 7.6VA
Brightness	Up to 115 lm
Color Temp	2700K Warm white, 3000K Pure white
CRI	90
Rated Life	60,000 hours

6651-27	2700K	BK	Black on Aluminum
6651-30	3000K	BZ	Bronze on Aluminum

Example: 6651-30BK

Power stake, 6 foot lead wire, and direct burial gel filled wire nuts included

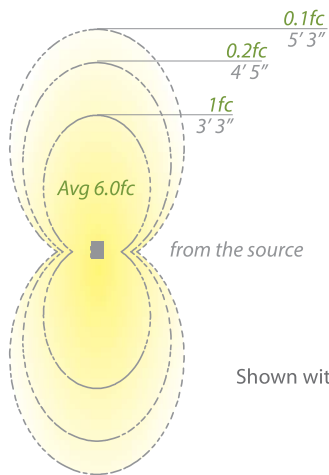
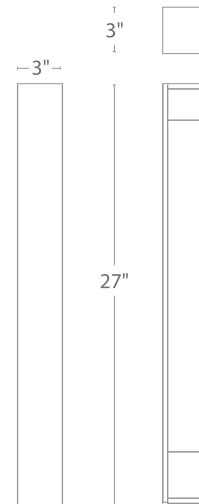

Shown without plate



Shown with plate



Mounting accessory included
12V



M6000-STAKE

- Sleek linear design blends seamlessly into pathways while providing soft, even illumination



Single direction illumination with back plate

SCOOP 12V/120V/277V LED BOLLARD

- IP66 Rated, protected against high-pressure water jets
- Factory sealed, watertight fixtures
- Constant output for 9V-15V input
- Mounting accessories included



visit product
page online

SCOOP 12V/120V/277V LED BOLLARD



12V

Input Power	9-15VAC
Brightness	7.8W/8.5VA
Color Temp	Up to 180 lm
	2700K Warm white, 3000K Pure white
CRI	90
Rated Life	60,000 hours

120V

Input Power	120V
Brightness	12.5W
Color Temp	Up to 350 lm
	2700K Warm white, 3000K Pure white
CRI	90
Rated Life	60,000 hours

277V

Input Power	277V
Brightness	13.2W
Color Temp	Up to 370 lm
	2700K Warm white, 3000K Pure white
CRI	90
Rated Life	60,000 hours

6611-27 2700K **BK** Black on Aluminum
6611-30 3000K **BZ** Bronze on Aluminum

6612-27 2700K **BK** Black on Aluminum
6612-30 3000K **BZ** Bronze on Aluminum

6613-27 2700K **BK** Black on Aluminum
6613-30 3000K **BZ** Bronze on Aluminum

Transformer Required (order separately)

MLV dimming only

TRIAC or ELV dimming

ELV dimming only

Example: 6611-30BK

Recommended spacing for installation :

(12V) 6611

- Residential: 5 to 6ft
- Commercial: 3 to 4ft

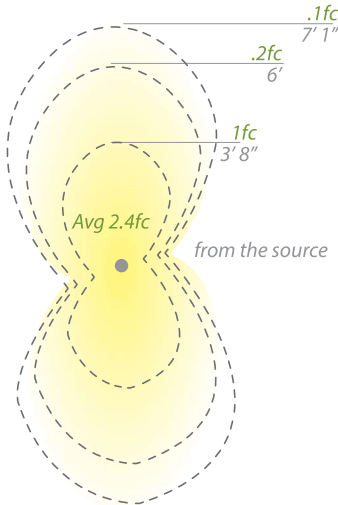

Recommended spacing for installation:

(120V, 277V) 6612, 6613

- Residential: 6.5 to 7.5ft
- Commercial: 4.5 to 5.5ft

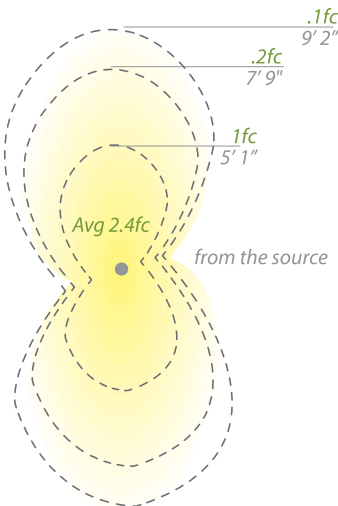

- Sleek linear design blends seamlessly into pathways while providing soft, even illumination

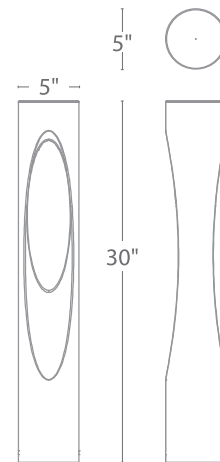

Mounting accessory included

12V

120V/277V



M6000-STAKE

M6610-CON-KIT



Even illumination front and back

CHAMBER 12V/120V/277V LED BOLLARD

- IP66 Rated, protected against high-pressure water jets
- Factory sealed, watertight fixtures
- Constant output for 9V-15V input
- Mounting accessories included



visit product
page online

CHAMBER 12V/120V/277V LED BOLLARD



12V

Input	9-15VAC
Power	5.8W, 6.2VA
Brightness	Up to 150 lm
Color Temp	2700K Warm white 3000K Pure white
CRI	90
Rated Life	60,000 hours

120V

Input	120V
Power	12.5W
Brightness	Up to 400 lm
Color Temp	2700K Warm white 3000K Pure white
CRI	90
Rated Life	60,000 hours

277V

Input	277V
Power	13.2W
Brightness	Up to 450 lm
Color Temp	2700K Warm white 3000K Pure white
CRI	90
Rated Life	60,000 hours

6631-27 2700K **BK** Black on Aluminum
6631-30 3000K **BZ** Bronze on Aluminum

6632-27 2700K **BK** Black on Aluminum
6632-30 3000K **BZ** Bronze on Aluminum

6633-27 2700K **BK** Black on Aluminum
6633-30 3000K **BZ** Bronze on Aluminum

Transformer Required (order separately)

MLV dimming only

TRIAC or ELV dimming

ELV dimming only

Example: 6633-30BK

Recommended spacing for installation :
(12V) 6631

- Residential: 19.5 to 23ft
- Commercial: 13 to 15.5ft

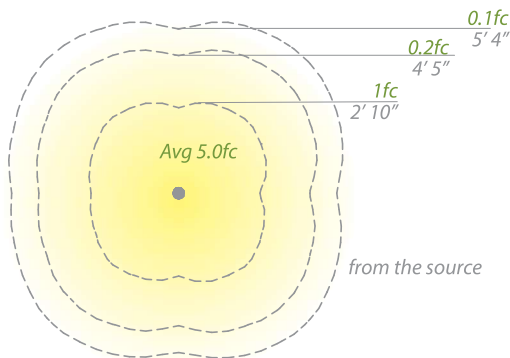

Recommended spacing for installation :
(120V, 277V) 6632, 6633

- Residential: 12.5 to 15ft
- Commercial: 8 to 10ft

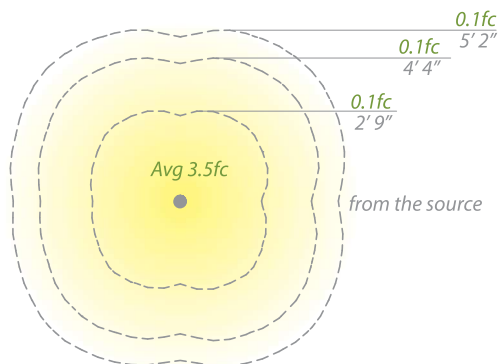

- Sleek linear design blends seamlessly into pathways while providing soft, even illumination

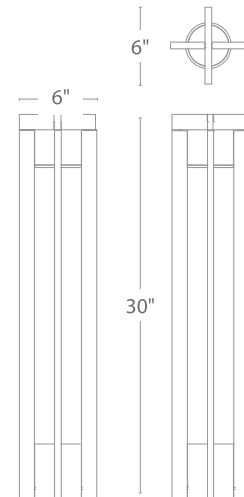

Mounting accessory included

12V

120V/277V



M6000-STAKE

M6630-CON-KIT



CHAMBER 120V 16" & 20" LED OUTDOOR WALL SCONCE

Color Temp: 3000K
 CRI: 90
 Dimming: 100%–10% ELV
 Rated Life: 50,000 hours*
 Input: 120V (277V special order)

- Solid aluminum construction with weather-resistant finish
- Minimal mounting hardware for easy installation
- Light engine is factory sealed for maximum protection from the elements
- No transformer or driver required

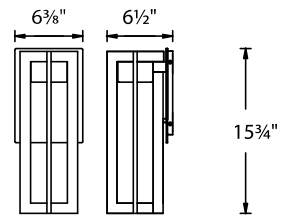

Bold Mid-Century Modern look with intersecting aluminum frames and cutting-edge LED light.

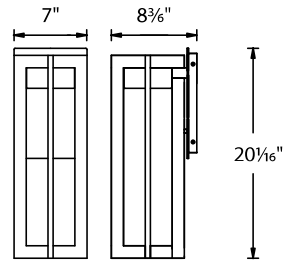

WS-W48616



WS-W48620

	Size	Watt	LED Lumens	Delivered Lumens	Finish
	WS-W48616 16"	12W	1000	255	BK Black BZ Bronze
	WS-W48620 20"	18W	1600	519	

Example: **WS-W48616-BK**

For 277V, add an "F" before the finish: **WS-W48616F-BK**



visit product page online

CHAMBER 120V
16" LED OUTDOOR PENDANT

CHAMBER 120V
20" LED OUTDOOR POST MOUNT

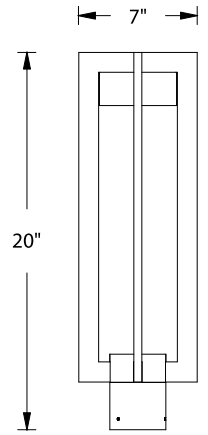
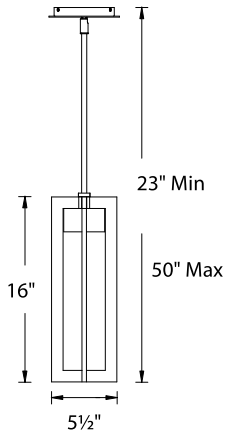

	Size	Watt	LED	Delivered	Finish
			Lumens	Lumens	
PD-W48616	16"	12W	1000	372	BK Black BZ Bronze

Example: **PD-W48616-BK**

	Size	Watt	LED	Delivered	Finish
			Lumens	Lumens	
PM-W48620	20"	17.5W	1600	634	BK Black BZ Bronze

Example: **PM-W48620-BZ**



visit product page online

TOWER 12V/120V/277V (CHECK VOLTAGE) LED BOLLARD

- IP66 Rated, protected against high-pressure water jets
- Factory sealed, watertight fixtures
- Constant output for 9V-15V input
- Mounting accessories included



visit product
page online

TOWER 12V/120V LED BOLLARD



12V

Input Power	9-15VAC
Brightness	5.8W, 6.2VA
Color Temp	Up to 170 lm
	2700K Warm white
	3000K Pure white
CRI	90
Rated Life	60,000 hours

120V

Input Power	120V
Brightness	12.5W
Color Temp	Up to 430 lm
	2700K Warm white
	3000K Pure white
CRI	90
Rated Life	60,000 hours

277V

Input Power	277V
Brightness	13.2W
Color Temp	Up to 470 lm
	2700K Warm white
	3000K Pure white
CRI	90
Rated Life	60,000 hours

6621-27 2700K **BK** Black on Aluminum
6621-30 3000K **BZ** Bronze on Aluminum

6622-27 2700K **BK** Black on Aluminum
6622-30 2700K **BZ** Bronze on Aluminum

6623-27 2700K **BK** Black on Aluminum
6623-30 3000K **BZ** Bronze on Aluminum

Transformer Required (order separately)

MLV dimming only

TRIAC or ELV dimming

ELV dimming only

Example: 6622-30BK

Recommended spacing for installation :

(**12V**) 6621

- Residential: 12 to 14.5ft
- Commercial: 4 to 6.5ft

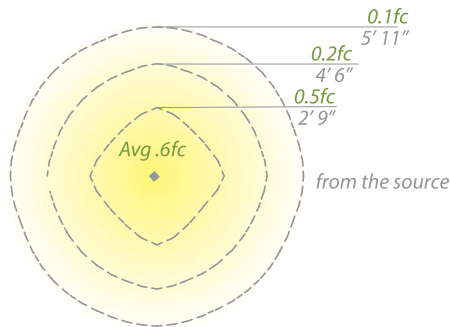

Recommended spacing for installation :

(**120V, 277V**) 6622, 6623

- Residential: 16 to 22ft
- Commercial: 8 to 11ft

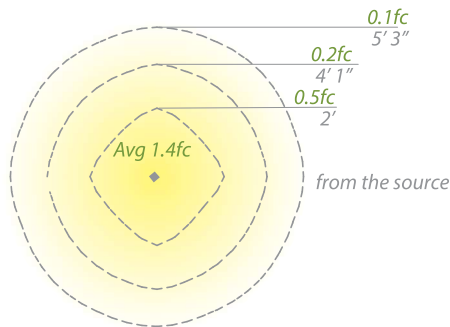

- Sleek linear design blends seamlessly into pathways while providing soft, even illumination

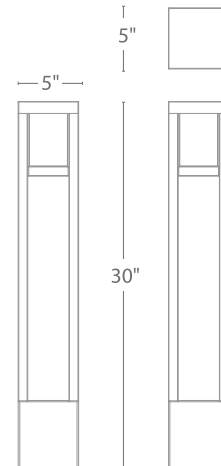

Mounting accessory included

12V

120V/277V



M6000-STAKE

M6620-CON-KIT

ARCHETYPE 12V/120V/277V LED BOLLARD

- IP66 Rated, protected against high-pressure water jets
- Factory sealed, watertight fixtures
- Constant output for 9V-15V input
- Mounting accessories included



visit product
page online

ARCHETYPE 12V/120V/277V LED BOLLARD



12V

Input	9-15VAC
Power	5.8W, 6.2VA
Brightness	Up to 195 lm
Color Temp	2700K Warm white 3000K Pure white
CRI	90
Rated Life	60,000 hours

120V

Input	120V
Power	12.5W
Brightness	Up to 470 lm
Color Temp	2700K Warm white 3000K Pure white
CRI	90
Rated Life	60,000 hours

277V

Input	277V
Power	13.2W
Brightness	Up to 550 lm
Color Temp	2700K Warm white 3000K Pure white
CRI	90
Rated Life	60,000 hours

6641-27	2700K	BK	Black on Aluminum	6642-27	2700K	BK	Black on Aluminum	6643-27	2700K	BK	Black on Aluminum
6641-30	3000K	BZ	Bronze on Aluminum	6642-30	3000K	BZ	Bronze on Aluminum	6643-30	3000K	BZ	Bronze on Aluminum

Transformer Required (order separately)

MLV dimming only

TRIAC or ELV dimming

ELV dimming only

Example: 6641-30BK

Recommended spacing for installation :

(12V) 6641

- Residential: 11.5 to 14ft
- Commercial: 7 to 9ft

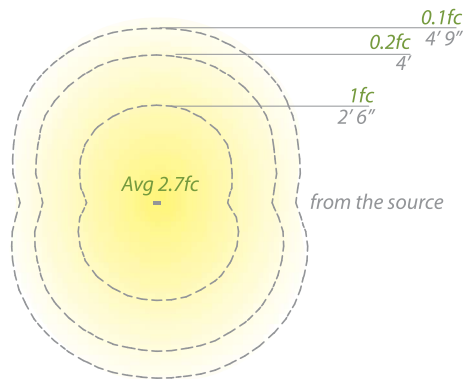

Recommended spacing for installation :

(120V, 277V) 6642, 6643

- Residential: 12.5 to 14.5ft
- Commercial: 8 to 9.5ft

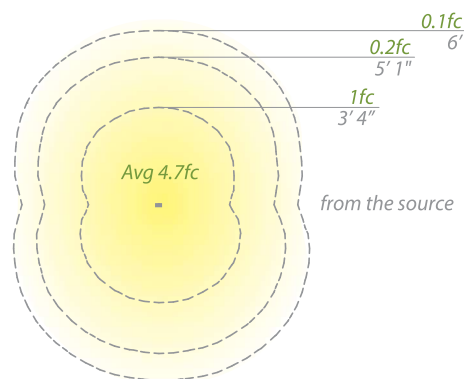

- Sleek linear design blends seamlessly into pathways while providing soft, even illumination

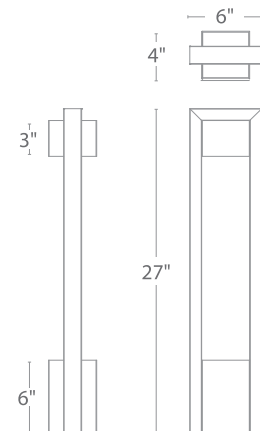

Mounting accessory included

12V

120V/277V



M6000-STAKE

M6640-CON-KIT



ARCHETYPE 120V/277V 18" LED OUTDOOR SCNCE

Color Temp: 3000K
 CRI: 90
 Dimming: 100% - 10% ELV
 Rated Life: 54,000 hours
 Input: 120V

WS-W13918

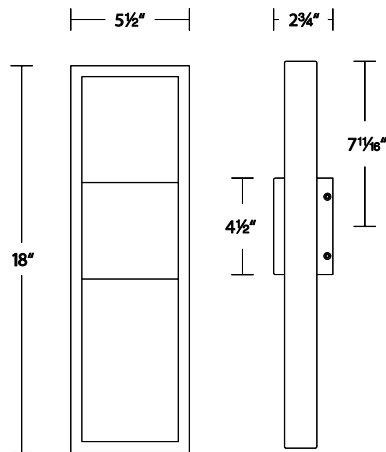

ARCHETYPE 120V/277V 12", 18" & 24" LED OUTDOOR SCNCE

Color Temp: 3000K
 CRI: 90
 Dimming: 100% - 10% ELV
 Rated Life: 54,000 hours
 Input: 120V

WS-W15912

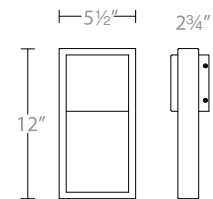

WS-W15918

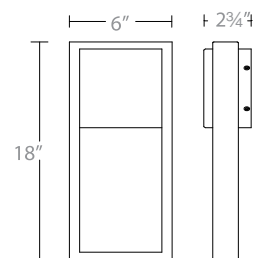

WS-W15924

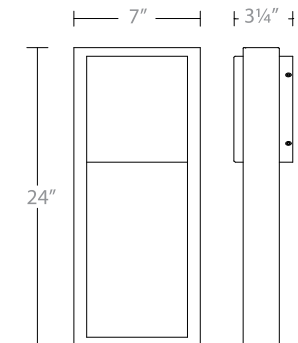

A low-profile, artful design adds a distinctive, sophisticated look in any outdoor application.

- Aluminum hardware with etched glass diffuser
- No transformer or driver required

	Size	Watt	LED Lumens	Delivered Lumens	Finish
WS-W13918	18"	16W	1200	427	BK Black
WS-W13924	24"	22W	1600	760	

Example: **WS-W13918-BK**

	Size	Watt	LED Lumens	Delivered Lumens	Finish
WS-W15912	12"	10W	800	331	
WS-W15918	18"	13W	1000	435	BK Black
WS-W15924	24"	16W	1200	571	

Example: **WS-W15912-BK**