

SATCO | NUVO

AWARE[®]

NEW PRODUCTS | PROMOS | IDEAS



**TOP TRENDS & NEWEST
TECHNOLOGIES INSIDE!**



Vol. 3

STARFISH SMART

PAGES 4-16

FUNCTIONAL

PAGES 18-39

LAMPS

PAGES 42-61

ELECTRICAL

PAGES 62-67

DECORATIVE

PAGES 70-84



NEW DESIGN

pg. 46

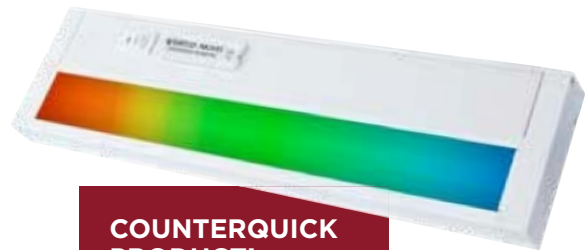

COUNTERQUICK PRODUCT!

pg. 16



LATEST STYLES!

pg. 82

AWARE

Welcome to the third edition of Aware! Our semi - annual special marketing and promotional hybrid brochure which offers educational resources, selling tools, new product introductions and of course savings on a great many items that are on sale for a limited time period.

As we ease into 2023, SATCO|NUVO is ready to service a broad scope of your lighting project needs. From residential lamp replacement to high-rise office and multi-family dwellings; we have the products and inventory to provide a single source solution.

Take note of our expanded STARFISH "SMART" lighting products. We continue to expand this category. Recent introductions include, "SMART" Video Floodlight/Camera, String Lights and CounterQUICK™ Under Cabinet RGBTW lighting system.

New commercial luminaires and retrofit lamps, new decorative lighting from NUVO, and so much more are featured in this timely introduction. Enjoy!



STARFISH™ SMART USES

Creative Uses For STARFISH™



STARFISH™ LED Smart Lighting is a convenient way to connect and create a vibe! STARFISH LED brings a stylish, affordable, lighting solution to illuminate your space. The capabilities of SATCO's Smart bulbs when used with the STARFISH app will create an entirely immersive experience.

Add some atmosphere with dynamic RGB lights! Self-adhering tape lights are flexible and fun, use the smart dimming and tunable white features for a soft elegant glow or to wash the room in colors for a techni-color vibe! STARFISH tape lights fit great along the edge of your TV. Sync the lights with the sounds of your TV to give your room an entire theater vibe.



PLAN A ROMANTIC EVENING UNDER THE STARS!

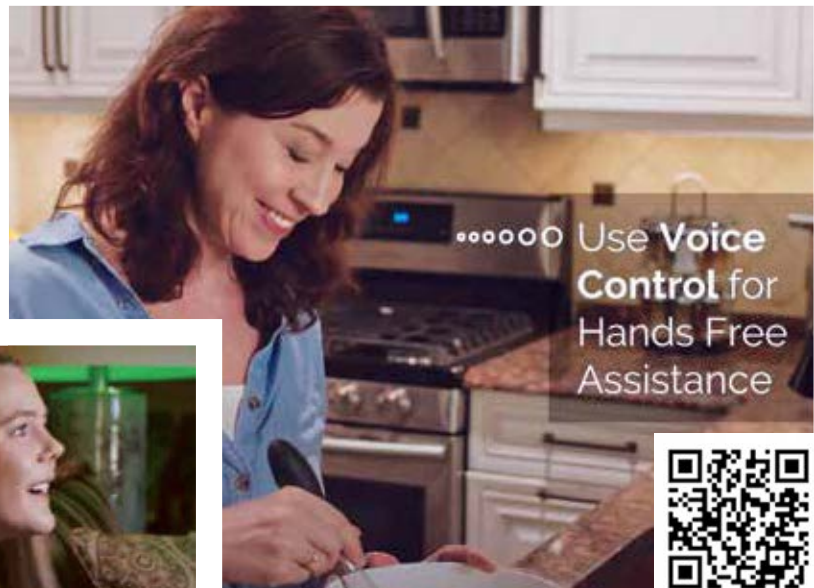

DYNAMIC COLOR CHANGING EFFECTS FOR GAMING!



Light The Way Home



STARFISH Smart bulbs have also been used in wedding venues for colorful dance floor lighting, DJ booth lighting, and up-lighting! There are so many interesting ways to arrange STARFISH Smart lights.



SCAN TO LEARN MORE ABOUT STARFISH SMART LIGHTING!





STARFISH™

The SMART home lighting and control system created to enrich your quality of life through convenience and connection.

live life enlightened™



COLOR CHANGEABLE
TUNABLE WHITE, 80 OR
90 CRI, 2700K-5000K
DIMMABLE WITH
STARFISH APP
SCALABLE
WI-FI ENABLED
NO HUB REQUIRED



WI-FI LED RGB & TUNABLE WHITE BULBS



LED Color Changing and Tunable White bulbs replace standard medium base lamps with smart technology adding dynamic color changes and toning whites from warm-to-cool light.







ITEM	TYPE	CCT	MOD	MOL	WATTS	LUMENS	CRI	BASE	VOLTS	HRS	PK
STANDARD A19 & A21 COLOR CHANGEABLE & TUNABLE WHITE											
S11252	A19	RGB/TW	2.36" (60)	4.57" (116)	9.5W	800	80	E26	120	25K	24
S11253	A19	RGB/TW	2.36" (60)	4.57" (116)	9.5W	800	80	E26	120	25K	24
S11254*	A19	RGB/TW	2.36" (60)	4.57" (116)	10W	800	90	E26	120	15K	24
S11275*	A19	RGB/TW	2.36" (60)	4.57" (116)	10W	800	90	E26	120	15K	24
S11287*	A21	RGB/TW	2.4" (61)	5.35" (135.9)	13W	1100	90	E26	120	15K	48
LED Filament Tunable White											
S11250**	A19	TW	2.36" (59.94)	4.33" (110)	5W	450	80	E26	120	15K	24
S11274**	A19	TW	2.36" (59.94))	4.33" (110)	7.5W	800	90	E26	120	15K	24
S11251**	G25	TW	3.15" (80.01)	4.45" (113.03)	4.5W	450	80	E26	120	15K	24
DIRECTIONAL REFLECTORS COLOR CHANGEABLE & TUNABLE WHITE											
S11283	R20	RGB/TW	2.48" (63)	3.69" (93.7)	6W	480	90	E26	120	25K	24
S11255	BR30	RGB/TW	3.70" (94)	5.12" (130)	9.5W	800	80	E26	120	25K	12
S11256	BR30	RGB/TW	3.70" (94)	5.12" (130)	9.5W	800	80	E26	120	25K	12
S11257*	BR30	RGB/TW	3.70" (94)	5.12" (130)	9.5W	760	90	E26	120	25K	12
S11276*	BR30	RGB/TW	3.70" (94)	5.12" (130)	9.5W	760	90	E26	120	25K	12
S11284*	BR40	RGB/TW	4.72" (127)	6.42" (163.1)	12W	960	90	E26	120	25K	12
S11258	PAR38	RGB/TW	4.72" (127)	5.00" (127)	15W	1200	80	E26	120	25K	12
S11277*	PAR38	RGB/TW	4.72" (127)	5.00" (127)	15W	1200	90	E26	120	25K	12
S11271	MR16	RGB/TW	2.2" (56)	1.97" (50)	5.5W	400	80	GU10	120	25K	48
S11278	MR16	RGB/TW	2.2" (56)	1.97" (50)	5.5W	385	90	GU10	120	25K	48



WI-FI LED COLOR CHANGING AND TUNABLE WHITE DOWNLIGHTS

LED Tunable color changing and white downlights are a practical solution for converting existing recessed lighting into energy efficient smart lighting that is dimmable and adjusts from warm-to-cool settings with the STARFISH™ app.

-  RGB Color
-  Tunable White, 80 and 90 CRI 2700-5000K
-  Wet location
-  Dimmable, with app
-  Connector or Adapter

S11259
S11285







S11260
S11286



ITEM	TYPE	MOD	MOL	WATTS	LUMENS	CRI	BASE	VOLTS	HRS	PACK
TUNABLE WHITE										
S11259**†	RETROFIT	5.12" (130.05)	2.8" (71.12)	8.7W	700	90	E26 ADAPTER	120	25K	6
S11260**†	RETROFIT	7.36" (187)	2.85"(73.5)	10W	800	90	E26 ADAPTER	120	25K	6
RGB COLOR/TUNABLE WHITE										
S11285**†	RETROFIT	5.12" (130.05)	2.8" (71.12)	8.7W	700	90	E26 ADAPTER	120	25K	12
S11286**†	RETROFIT	7.36" (187)	2.85"(73.5)	10W	800	90	E26 ADAPTER	120	25K	12



WI-FI LED COLOR CHANGING AND TUNABLE WHITE DOWNLIGHTS

-  RGB Color
-  Tunable White, 80 and 90 CRI 2700-5000K
-  Wet location
-  Dimmable, with app
-  Connector or Adapter

S11261
S11279



S11262
S11280



Rough-in plate

Remote Driver
6' Extension Cable



ITEM	TYPE	MOD	MOL	WATTS	LUMENS	CRI	BASE	VOLTS	HRS	PACK	
TUNABLE WHITE											
S11261	DOWNLIGHT	5.12" (130.05)	2.8" (71.12)	8.7W	700	90	DIRECT WIRE	120	25K	6	
S11262	DOWNLIGHT	7.36" (187)	2.85"(73.5)	10W	800	90	DIRECT WIRE	120	25K	6	
RGB COLOR/TUNABLE WHITE											
S11279	DOWNLIGHT	5.12" (130.05)	2.8" (71.12)	8.7W	700	90	DIRECT WIRE	120	25K	12	
S11280	DOWNLIGHT	7.36" (187)	2.85"(73.5)	10W	800	90	DIRECT WIRE	120	25K	12	
80-943	ROUGH-IN PLATE / BARS 4" RD							045923809439			
80-944	ROUGH-IN PLATE / BARS 6" RD							045923809446			
80-945	ROUGH-IN PLATE / BARS 8" RD							045923809453			
80-946	GOOF RING 4" - DIRECT WIRE DL - 6" OUTSIDE DIAMETER							045923809460			
80-947	GOOF RING 6" - DIRECT WIRE DL - 8" OUTSIDE DIAMETER							045923809477			
80-948	GOOF RING 8" - DIRECT WIRE DL - 10 1/8" OUTSIDE DIAMETER							045923809484			
80-985	REMOTE DRIVER 6' EXTENSION CABLE							045923809859			

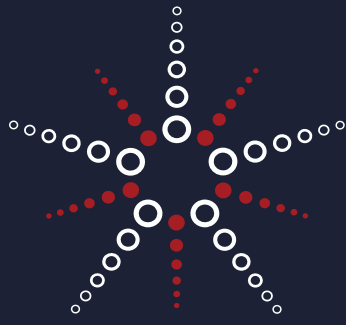

STARFISH™





live life enlight^{ed}™

STARFISH™ WI-FI SMART SWITCHES & OUTLETS



Enable smart on-off or dimming control throughout a circuit utilizing STARFISH™ Wall and Dimmer Switches and Outlets.

-  **Dry location**
-  **Dimmer Only**
-  **Direct Wire, Neutral Wire required**

Enable smart on-off of small appliances with STARFISH™ plug-in outlets.

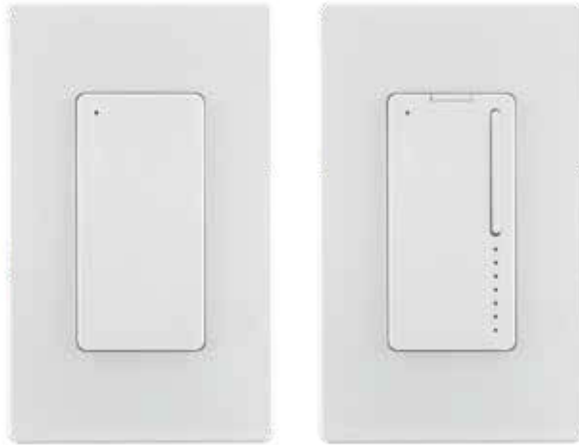

-  **Dry location**
-  **Plug-in**



ON-OFF switch

Dimmer switch

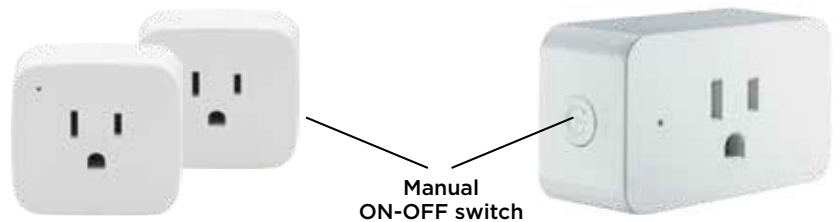

The rectangular Wi-Fi DIMMER outlet allows for on-off and dimming operation of lighting to a maximum of 300W of incandescent or 150W LED loads.

-  **Dry location**
-  **Dimmable, with app**
-  **Plug-in**



Manual ON-OFF switch

The rectangular Wi-Fi DIMMER outlet allows for on-off and dimming operation of lighting to a maximum of 300W of incandescent or 150W LED loads.

-  **Dry location**
-  **Dimmable, with app**
-  **Plug-in**



WiFi Smart Dimmer outlet

STARFISH™ WI-FI SMART SWITCHES & OUTLETS



ITEM	TYPE	WIDTH	DEPTH	HEIGHT	AMPS	INC.	LED	VOLTAGE	PACK
S11267	ON-OFF SWITCH	2.76"(70)	1.71"(43.43)	4.53" (115)	6A	720W	720W	120V	12
S11268	DIMMER	2.76"(70)	1.71"(43.43)	4.53" (115)	N/A	450W	150W	120V	12
S11266	ON-OFF OUTLET	2.87"(72.89)	1.69"(42.92)	1.97" (50.03)	15A	1800W	1800W	120V	12
S11269	MINI SQUARE PLUG-IN OUTLET	1.99"(50.54)	1.99"(50.54)	1.99" (50.54)	10A	1200W	1200W	120V	12
S11270	ON-OFF DIMMER OUTLET	2.87"(72.89)	1.69"(42.92)	1.97" (50.03)	N/A	300W	150W	120V	12



STARFISH™
live life enlightened

STARFISH SMART LED INDOOR/OUTDOOR STRING LIGHTS

WI-FI ENABLED, MULTI-FUNCTION
SYSTEM WITH INFINITE
COLOR OPTIONS

MOBILE APP OR VOICE CONTROL

DIMMABLE WITH APP.**

12-15 SMART LED BULBS INCLUDED

CONNECT UP TO 144 FT.,
3 SETS MAX.

FOR RESIDENTIAL AND
COMMERCIAL USE

HEAVY DUTY 18 GAUGE WIRE

EASY INSTALLATION AND SETUP

3 YEAR WARRANTY

WIFI 2.4GHZ
NO HUB NEEDED



COLOR CHANGEABLE

WARM TO COOL WHITE



S11292



S11288
S11290
S11291

- RGB Color**
- Warm White, 80 CRI
2700K
- Wet location
- Dimmable, with app

STARFISH INDOOR/OUTDOOR STRING LIGHTS



ITEM	CCT TECH	TYPE	LENGTH	WIDTH	HEIGHT	WATTS	CRI	VOLTS	HRS	PACK
S11288	RGB/TW	STRING LIGHTS	24' (7315.2mm)	1.77" (45mm)	7.48" (190mm)	10W	80	120	15K	4
S11289		REPLACEMENT BULB (S11288 ONLY)	-	1.77" (45mm)	3.46" (87.9mm)	1W	80		15K	12
S11290	RGB/TW	STRING LIGHTS	24' (7315.2mm)	1.77" (45mm)	7.48" (190mm)	12W	-	120	15K	4
S11291	RGB/TW	STRING LIGHTS	48' (14630.4mm)	1.77" (45mm)	7.48" (190mm)	15W	-	120	15K	4
S11292	TW	STRING LIGHTS	24' (7315.2)mm	1.77" (45mm)	7.48" (190mm)	12W	-	120	15K	4





Accessories

80-2812	6FT. EXTENSION FOR S11288, 10W
---------	--------------------------------



WI-FI LED COLOR CHANGING & TUNABLE WHITE TAPE LIGHT

Color changing and tunable white indoor and outdoor tape lights are dimmable with thousands of colors and warm-to-cool white settings, damp location certified and offer an ever-changing array of versatility.

-  RGB Color**
-  Tunable White, 80 CRI 3000-6500K
-  Wet location, outdoor
-  Damp location, Indoor
-  Dimmable, with app



S11263
S11264
S11265



Plug & In-Line Controller Included



ITEM	TYPE	DIMENSIONS LENGTH (MM)	WATTS	CRI	VOLTS	HRS	PACK
S11263	INDOOR TAPE	6' (2000mm)	20W	80	120	25K	4
S11264	INDOOR TAPE EXT.*	3' (1000mm)	8W	80	120	25K	48
S11265	OUTDOOR TAPE	16' (5000mm)	28W	80	120	25K	4

*Up to 8 extensions can be used with S11263 6' indoor tape



SECURITY WITHOUT A SUBSCRIPTION

- NO MONTHLY SUBSCRIPTION
- REAL-TIME MOTION EVENTS
- VIDEO HISTORY & NIGHT VISION
- REMOTE ACCESS
- ADJUSTABLE LED FLOODLIGHTS
- 270° MOTION DETECTION
- 20W - 1900 LUMENS - 3000K
- IP65 WEATHERPROOF DESIGN
- 50,000 HOURS
- 5 YEAR WARRANTY

SATCO's Security Floodlight Camera offers the latest technology in home security and surveillance without the monthly subscription fees associated with competing products.

When motion is detected, the 1080p HD camera records events and stores them directly to the devices included 32GB microSD card. Live and recorded events can instantly be viewed on any mobile device using the STARFISH™ app, anywhere, any time.



NO MONTHLY SUBSCRIPTION

Access video content on included 32G microSD Card (expandable to 128G)



REAL-TIME MOTION EVENTS

Get real-time notifications when motion is detected around your home



VIDEO HISTORY

Check your motion recording history to see activity while you're away

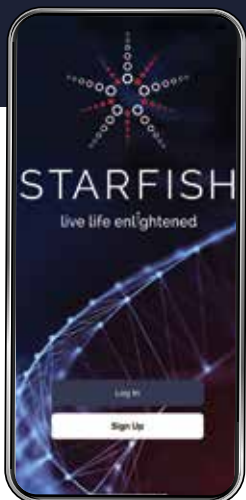

Visit Website



Mobile App

A WHOLE HOME SMART SOLUTION

STARFISH™ is a leading technology that combines smart home security and lighting controls into one complete solution. With a growing line of security and lighting products, SATCO's STARFISH products are the premier choice in building your smart home—all controlled by a single app.



For an in-depth exploration of STARFISH™ features including the latest products, visit SATCOSTARFISH.COM



20 WATTS TOTAL
 3000K CCT, 1900 TOTAL LUMENS
 FLOODLIGHTS 50,000 HOURS
 RATED LIFE

CONTROL
 FLOODLIGHTS CAN BE
 CONTROLLED OR DIMMED
 THROUGH STARFISH™ APP

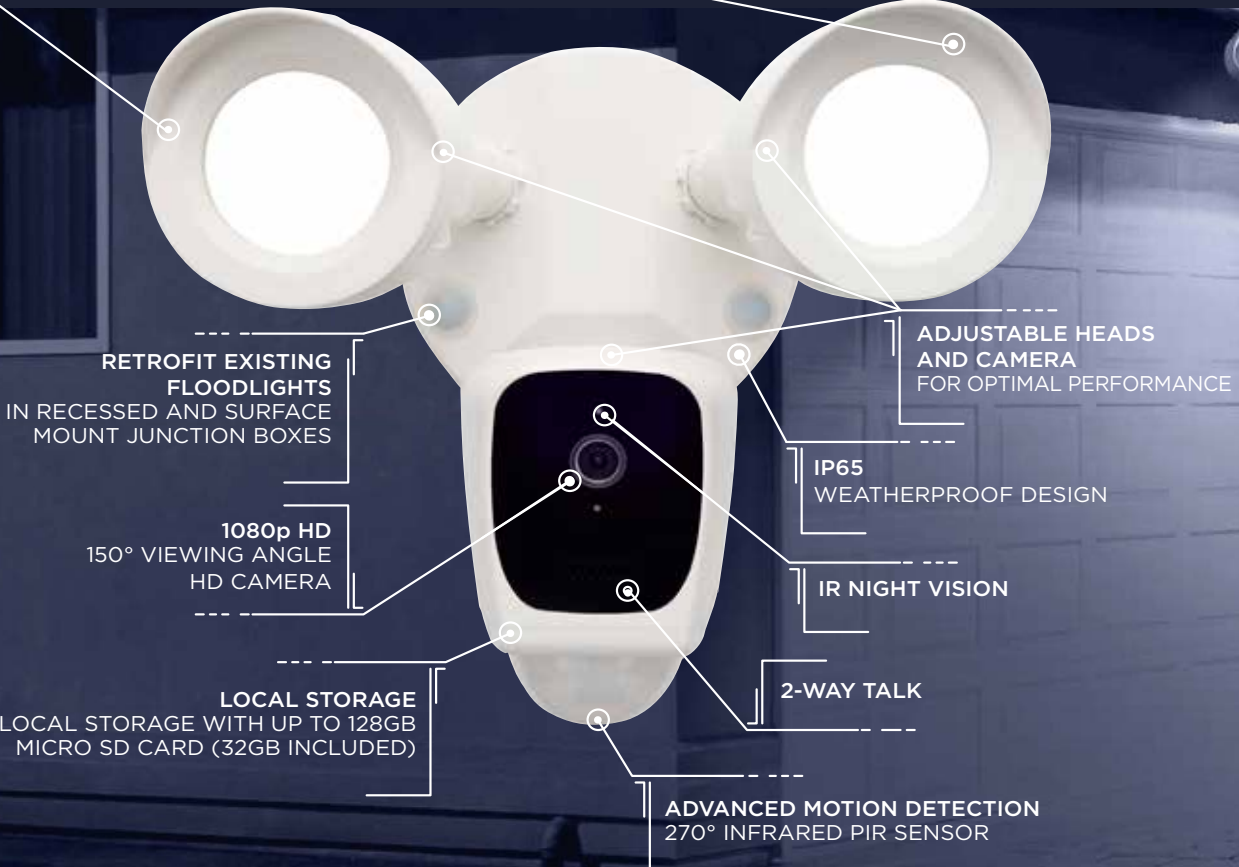

**RETROFIT EXISTING
 FLOODLIGHTS**
 IN RECESSED AND SURFACE
 MOUNT JUNCTION BOXES

**ADJUSTABLE HEADS
 AND CAMERA**
 FOR OPTIMAL PERFORMANCE

1080p HD
 150° VIEWING ANGLE
 HD CAMERA

IP65
 WEATHERPROOF DESIGN

IR NIGHT VISION

LOCAL STORAGE
 LOCAL STORAGE WITH UP TO 128GB
 MICRO SD CARD (32GB INCLUDED)

2-WAY TALK

ADVANCED MOTION DETECTION
 270° INFRARED PIR SENSOR



65/901
 Black

65/900
 White

65/902
 Brown



ITEM	DESCRIPTION	WATTS	V	DIMENSIONS
65-900	SECURITY LIGHT W/ CAMERA - WHITE	20W	120-240V	W 7.6 x H 10.04
65-901	SECURITY LIGHT W/ CAMERA - BLACK	20W	120-240V	W 7.6 x H 10.04
65-902	SECURITY LIGHT W/ CAMERA - BRONZE	20W	120-240V	W 7.6 x H 10.04



STARFISH™



COUNTERQUICK™

LED SMART RGBTW

LINKABLE UNDER CABINET FIXTURES

RGB COLOR-CHANGING &
WARM-TO-COOL TUNABLE WHITE

DIMMABLE VIA APP

WI-FI ENABLED NO HUB REQUIRED

EASY INSTALLATION

HARDWIRE OR PLUG-IN

CONCEALED DIRECT
MOUNT HARDWARE

KEYHOLE MOUNTING OPTION



DOWNLOAD THE
STARFISH APP



AVAILABLE IN 11", 14", 22", 28", AND 34" LENGTHS



ITEM	DESCRIPTION	WATTS	LUMENS	VOLTAGE	DIMENSIONS L x W x H	CONNECTION QTY
63-551	11" LED RGB SMART	6.5	450	120	11" x 3.5" x 1"	up to 72
63-552	14" LED RGB SMART	9	650	120	14" x 3.5" x 1"	up to 48
63-553	22" LED RGB SMART	13	920	120	22" x 3.5" x 1"	up to 36
63-554	28" LED RGB SMART	17	1350	120	28" x 3.5" x 1"	up to 22
63-555	34" LED RGB SMART	20	1500	120	34" x 3.5" x 1"	up to 18



COUNTERQUICK™

LED CCT SELECTABLE

LINKABLE UNDER CABINET FIXTURES

CCT SELECTABLE
3000K/4000K/5000K

EASY INSTALLATION
HARDWIRE OR PLUG-IN

CONCEALED DIRECT
MOUNT HARDWARE

KEYHOLE MOUNTING OPTION

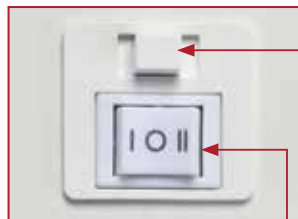

CCT Select Switch

High/Low Switch



ColorQuick™

Selectable Color Technology



AVAILABLE IN 8", 11", 14", 22", 28", AND 34" LENGTHS



ITEM	DESCRIPTION	WATTS	LUMENS	VOLTAGE	DIMENSIONS L x W x H	CONNECTION QTY
63-500	8" LED CCT SELECT	5	325-366	120	8" x 3.5" x 1"	up to 96
63-501	11" LED CCT SELECT	6.5	408-456	120	11" x 3.5" x 1"	up to 72
63-502	14" LED CCT SELECT	9	577-647	120	14" x 3.5" x 1"	up to 48
63-503	22" LED CCT SELECT	13	859-956	120	22" x 3.5" x 1"	up to 36
63-504	28" LED CCT SELECT	17	1216-1366	120	28" x 3.5" x 1"	up to 22
63-505	34" LED CCT SELECT	20	1500	120	34" x 3.5" x 1"	up to 18

Packing: 12/Master

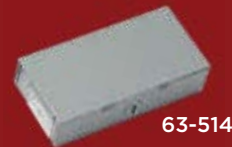

COUNTERQUICK STARFISH RGBTW AND CCT SELECTABLE ACCESSORIES

ITEM	DESCRIPTION	DIMENSIONS	MASTER	PACKAGE
63-510	POWER CORD	60" LENGTH	96	POLYBAG
63-511*	END-TO-END CONNECTOR (INCLUDED)	1" LENGTH	96	POLYBAG
63-512	3/8" WIRE CONNECTOR (ATTACHED TO JUNCTION BOX)	1.5" X 0.67" X 0.35"	96	POLYBAG
63-513	JUNCTION BOX - PLASTIC	4" X 2" X 1"	48	BOX
63-514	JUNCTION BOX - METAL	4" X 2" X 1"	48	BOX
63-515	LINK CABLE 6"	6" LENGTH	96	POLYBAG
63-516	LINK CABLE 12"	12" LENGTH	96	POLYBAG
63-517	LINK CABLE 24"	24" LENGTH	96	POLYBAG
63-518	CABLE LINK CONNECTOR	3" LENGTH	96	POLYBAG

*Included End-to-End Connector can be reordered if needed

FUNCTIONAL

Commercial Lighting Solutions

SATCO offers an end-to-end lighting solution for today's commercial and industrial spaces with products that include superior LED fixtures and high efficiency lamps built to effectively and efficiently illuminate with both quality and maintenance satisfaction.

SATCO is here to help! We can provide assistance with lighting layouts and offer tools such as our ROI utility rebates calculator to help economize projects. All commercial/functional fixtures are either DLC or ENERGY STAR certified.

Advanced features in our functional luminaries may include:

- Flicker Free drivers to reduce eye strain/fatigue
- CCT & Wattage Selectable features
- Integrated & Add On EM, PIR and MW Sensors
- Optional add-ons that meet NFPA Life Safety Codes
- Hi lumen and connectable options
- Adjustable features for fast and easy installation
- Multiple accessories for post install adjustment
- Broad wattage ranges, from 15W to 300W
- Multiple mounting options
- Accent, general, landscape lighting and more!

From indoors to out, offices to warehouses, malls to municipal buildings, auditoriums to arenas, SATCO|NUVO'S offering accommodates the space, budget and operating necessity.

Satco has your solutions.



LED AREA LIGHTS

- 120-277V, 120-347V AND 277-480V OPTIONS
- BRONZE POWDER COATED FINISH FOR ALL WEATHER DURABILITY
- 3" SLIP-FITTER MOUNT INCLUDED
- TYPE III LIGHT DISTRIBUTION
- 0-10V DIMMING
- BUILT-IN 4KV SURGE PROTECTION
- OPERATING TEMPERATURE: -40°C TO 45°C (-40°F TO 113°F)
- IP65 RATED
- MULTIPLE MOUNTING OPTIONS AND ADD-ON SENSORS AVAILABLE
- LONG LIFE-50,000 HOURS
- 5 YEAR WARRANTY



**LED AREA LIGHTS
CONTINUED...**

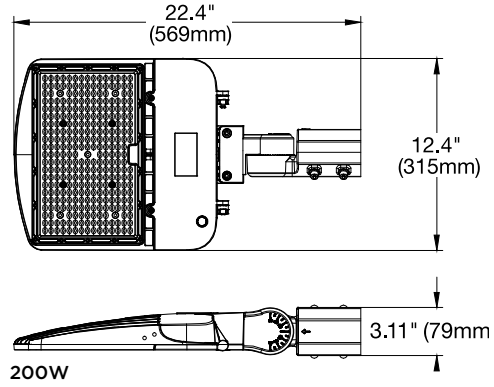
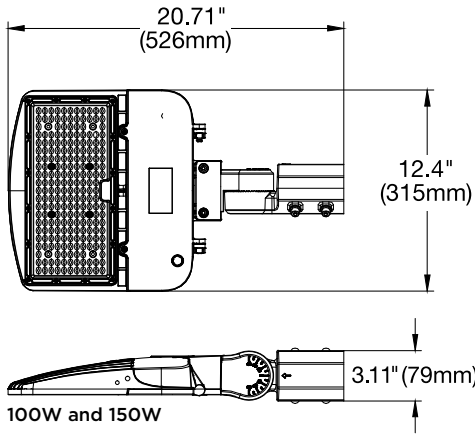

ACCESSORIES

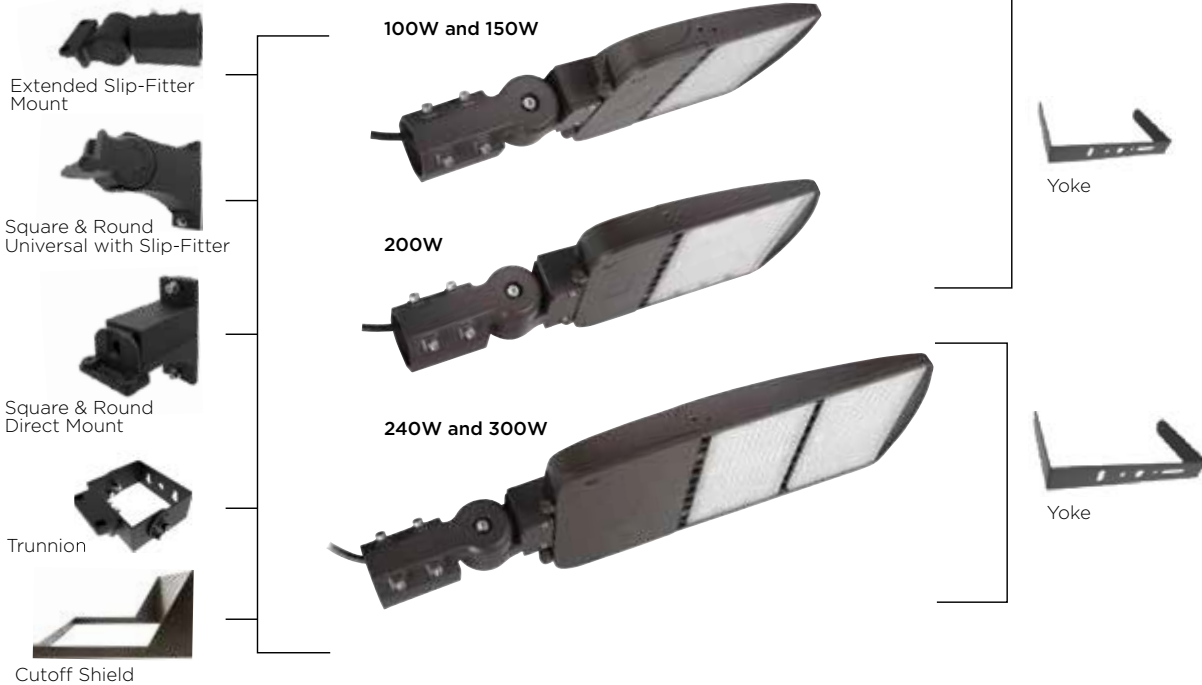

ITEM	DESCRIPTION	FEATURE	PK
65-870	UNIVERSAL MOUNT	DIRECT & SLIP-FITTER MNT BRZ	8
65-871	DIRECT MOUNT	SQUARE/ROUND POLE MOUNT BRZ	8
65-872	TRUNNION MOUNT	BRONZE FINISH	8
65-873	YOKE MOUNT	100W/150W/200W BRONZE	8
65-874	YOKE MOUNT	240W/300W BRONZE	8
65-875	EXT SLIP-FITTER	WITH SENSOR KNOCKOUTS BRONZE	8
65-876	FIXED ARM MOUNT	WITH SENSOR KNOCKOUTS BRONZE	8
65-877	CUTOFF SHIELD	BRONZE FINISH	8
65-878	CUTOFF SHIELD	BRONZE-ONLY FOR 200W FIXTURE	8
86-221	PHOTOCELL/SOCKET	100-277V FOR 100W/200W	50
86-222	PHOTOCELL/SOCKET	100-277V FOR 240W/300W	50
86-223	PHOTOCELL/SOCKET	277-480V	50
86-224	SURGE SUPPRESSOR	10KV-100-277V	50
86-225	SURGE SUPPRESSOR	10KV-277-480V	50
86-226	12-24V PIR SENSOR	277-480V	50
86-227	PIR SENSOR	100-277V	50
86-228	MICROWAVE SENSOR	100-277V	50

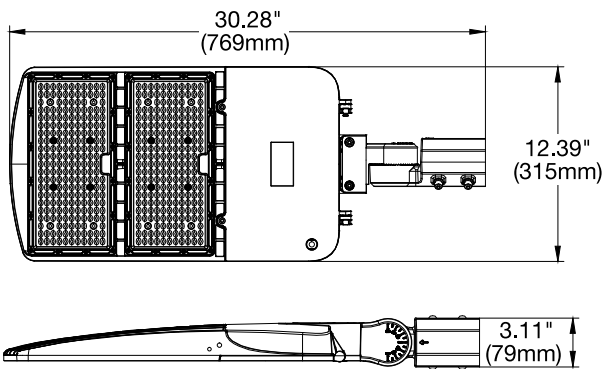

240W and 300W



LED AREA LIGHTS

ITEM	DESCRIPTION	W	V	CCT	LM	PK
65-840	100W LED AREA LIGHT TYPE III	100	100-277	4000K	13793	1
65-841	100W LED AREA LIGHT TYPE III	100	100-277	5000K	13793	1
65-842	150W LED AREA LIGHT TYPE III	150	100-277	4000K	19507	1
65-843	150W LED AREA LIGHT TYPE III	150	100-277	5000K	19736	1
65-844	200W LED AREA LIGHT TYPE III	200	100-277	4000K	26051	1
65-845	200W LED AREA LIGHT TYPE III	200	100-277	5000K	26536	1
65-846	240W LED AREA LIGHT TYPE III	240	100-277	4000K	31481	1
65-847	240W LED AREA LIGHT TYPE III	240	100-277	5000K	32585	1
65-848	300W LED AREA LIGHT TYPE III	300	100-277	4000K	39815	1
65-849	300W LED AREA LIGHT TYPE III	300	100-277	5000K	38988	1
65-850	100W LED AREA LIGHT TYPE III	100	100-347	4000K	13793	1
65-851	100W LED AREA LIGHT TYPE III	100	100-347	5000K	13793	1
65-852	150W LED AREA LIGHT TYPE III	150	100-347	4000K	19507	1
65-853	150W LED AREA LIGHT TYPE III	150	100-347	5000K	19736	1
65-854	200W LED AREA LIGHT TYPE III	200	100-347	4000K	26051	1
65-855	200W LED AREA LIGHT TYPE III	200	100-347	5000K	26536	1
65-856	240W LED AREA LIGHT TYPE III	240	100-347	4000K	31481	1
65-857	240W LED AREA LIGHT TYPE III	240	100-347	5000K	32585	1
65-858	300W LED AREA LIGHT TYPE III	300	100-347	4000K	39815	1
65-859	300W LED AREA LIGHT TYPE III	300	100-347	5000K	38988	1
65-860	100W LED AREA LIGHT TYPE III	100	277-480	4000K	13793	1
65-861	100W LED AREA LIGHT TYPE III	100	277-480	5000K	13793	1
65-862	150W LED AREA LIGHT TYPE III	150	277-480	4000K	19507	1
65-863	150W LED AREA LIGHT TYPE III	150	277-480	5000K	19736	1
65-864	200W LED AREA LIGHT TYPE III	200	277-480	4000K	26051	1
65-865	200W LED AREA LIGHT TYPE III	200	277-480	5000K	26536	1
65-866	240W LED AREA LIGHT TYPE III	240	277-480	4000K	31481	1
65-867	240W LED AREA LIGHT TYPE III	240	277-480	5000K	32585	1
65-868	300W LED AREA LIGHT TYPE III	300	277-480	4000K	39815	1
65-869	300W LED AREA LIGHT TYPE III	300	277-480	5000K	38988	1



LED TEMPERED GLASS FLOODS



WATTAGE SELECTABLE

**3000K/4000K/5000K
SELECTABLE**

120-347V

TEMPERED GLASS LENS

IP65—RUGGED & DURABLE

0-10V DIMMABLE

150 BEAM ANGLE°

50,000 HOUR LIFE



Trunnion Mount



Yoke Mount



Slipfitter Mount

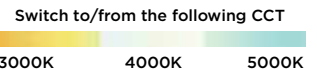

ITEM	DESCRIPTION	WATTAGE SELECTABLE	VOLTAGE	CCT SELECTABLE	LM
65-541	LED WATT/CCT SELECTABLE FLOOD	15W/25W/35W	120-347V	3000/4000/5000K	1800-4900
65-542	LED WATT/CCT SELECTABLE FLOOD	45W/60W/80W	120-347V	3000/4000/5000K	5400-11120
65-543	LED WATT/CCT SELECTABLE FLOOD	100W/125W/150W	120-347V	3000/4000/5000K	12000-21000
ACCESSORIES					
65-544	TRUNNION MOUNT ACCESSORY				
65-545	TRUNNION MOUNT ACCESSORY				
65-546	YOKE MNT SM TEMPERED GL FLOOD				
65-547	YOKE MNT MD TEMPERED GL FLOODS				
65-548	YOKE MNT MD TEMPERED GL FLOODS				
65-549	SLIP-FITTER TEMPERED GL FLOODS				



Semi-Cutoff Full Footprint

CCT & WATTAGE WALL PACKS SELECTABLE

- POWER QUICK™ TECHNOLOGY
3 SELECTABLE WATTAGES
- COLOR QUICK™ TECHNOLOGY
3 SELECTABLE CCTS
- IP65 RUGGED,
ALL WEATHER DURABILITY
- INTEGRATED EMERGENCY
BATTERY BACKUP VERSIONS
- INTEGRATED BY-PASSABLE
PHOTOCELL
- DLC PREMIUM
- 50,000 HOURS LONG LIFE

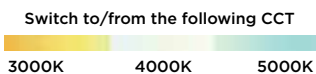

ITEM	DESCRIPTION	W	V	CCT	LM	PK
LED WALL PACK CCT & WATTAGE ADJUSTABLE						
65-754	LED WALL PACK CCT & WATT ADJ WITH INTEGRATED EM	29W/40W/60W	120-277	3000/4000/5000K	4060-8640	1
65-755	LED WALL PACK CCT & WATT ADJ	29W/40W/60W	120-277	3000/4000/5000K	4060-8640	1
65-756	LED WALL PACK CCT & WATT ADJ	80W/100W/120W	120-277	3000/4000/5000K	11200-17280	1
65-757	LED WALL PACK CCT & WATT ADJ	29W/40W/60W	120-347	3000/4000/5000K	4118-8700	1
65-758	LED WALL PACK CCT & WATT ADJ	80W/100W/120W	120-347	3000/4000/5000K	11360-17400	1
LED SEMI-CUTOFF WALL PACK CCT & WATTAGE ADJUSTABLE						
65-760	LED SEMI-CUTOFF WALL PACK CCT&WATT	29W/40W/60W	120-277	3000/4000/5000K	3915-8400	1
65-761	LED SEMI-CUTOFF WALL PACK CCT&WATT	80W/100W/120W	120-277	3000/4000/5000K	10800-15600	1
65-762	LED SEMI-CUTOFF WALL PACK CCT&WATT ADJ WITH INTEGRATED EM	29W/40W/60W	120-277	3000/4000/5000K	3915-8400	1



LED CCT SELECTABLE SMALL RECTANGULAR WALL PACKS

3000K/4000K/5000K
SELECTABLE

INTEGRATED PHOTOCELL
(BY-PASSABLE)

COMPACT DESIGN WITH
MULTIPLE 1/2" NPT
KNOCKOUTS

BLACK, BRONZE OR
WHITE FINISHES

0-10V DIMMABLE

WET LOCATION, IP65



ColorQuick™

Selectable Color Technology

Switch to/from the following CCT



20 WATTS
120-277V
ColorQuick
0-10V DIMMING
50,000 HOURS
80 CRI
100-150W EQUIVALENT
FC
RoHS COMPLIANT
UL LISTED
US
DLC LISTED

ITEM	DESCRIPTION	FINISH	CCT SELECTABLE	LM	PACK
65-747	LED SMALL 20W WALL PACK	BLACK	3000/4000/5000K	2608-2920	10
65-748	LED SMALL 20W WALL PACK	BRONZE	3000/4000/5000K	2608-2920	10
65-749	LED SMALL 20W WALL PACK	WHITE	3000/4000/5000K	2608-2920	10



Lamps not included

LED T8 LAMP READY FIXTURES

LED READY
USE WITH LED TYPE B
LINEAR LAMPS
2, 3, & 4 FOOT LENGTHS
RUGGED ALL STEEL BODY
WHITE FINISH
DAMP LOCATION RATED



Add-on reflector



Suspension Kit



Cambered Protective Cage



ITEM	DESCRIPTION	VOLTAGE	FINISH	PK
65-910	2' DOUBLE LAMP READY	120-277V	White	9
65-911	3' DOUBLE LAMP READY	20-277V	White	9
65-912	4' DOUBLE LAMP READY	20-277V	White	6
ACCESSORIES				
65-913	2' ADD-ON REFLECTOR		White	20
65-914	3' ADD-ON REFLECTOR		White	20
65-915	4' ADD-ON REFLECTOR		White	20
65-916	2' CAMBERED PROTECTIVE CAGE		Steel	50
65-917	3' CAMBERED PROTECTIVE CAGE		Steel	50
65-918	4' CAMBERED PROTECTIVE CAGE		Steel	50
65-919	3' CAMBERED PROTECTIVE CAGE			100

NEW STATE-OF-THE-ART SOUTHEAST DISTRIBUTION CENTER

SATCO is excited to announce the newly opened state-of-the-art 100,000 sq. ft. distribution center in Miami Gardens, FL earlier this month.

The new location more than doubles the inventory capacity from their original Miami location, which has serviced the Southeast market since 1976. Bill Gildin, President of SATCO notes, “We have enjoyed continuous growth in the Southeast and Caribbean territory for more than four decades from our prior location, and we thank our loyal customers for their support. Our new facility will deliver a new level of service and product availability to this market. Satco’s commitment to product innovation and customer support will be further enhanced by the capabilities of our new Miami Gardens, Florida distribution center”.

The new distribution center also encompasses a substantial increase in office space for our local sales and support team as well as a conference center and showroom for future customer training and events. Local distributors will appreciate the facilities central proximity as the location boasts easy access to all major roadways. Alan Karen, SVP Global Sales states, “We thank our loyal and dedicated staff for all they have accomplished in making this move a reality. This is just one more step which shows SATCO’s dedication to enhancing our business and delivering on our promise of being the single resource for all lighting needs”.

**SATCO|NUVO’s distribution center is located at:
1694 NW 215th Street, Miami Gardens, FL 33056**

NEW OFFICE SPACE AND TRAINING CENTER





LOADING DOCKS



100,000 SQ. FT. WAREHOUSE





LED SQUARE, LOW PROFILE CANOPY FIXTURES



28W, 40W, 60W AND 70W
OPTIONS

4000K & 5000K OPTIONS

8.5" & 10" SIZES

CEILING OR
PENDANT MOUNTING

IP65

OPTIONAL MICROWAVE
SENSOR, PHOTOCELL &
ADD-ON EM AVAILABLE



Add on Emergency
Backup Battery for LED
Square Canopy Light



ITEM	DESCRIPTION	W	CCT	LM	PACK
65-138	8.5" SQUARE CANOPY - BRONZE	28	4000K	3360	6
65-139	8.5" SQUARE CANOPY - BRONZE	28	5000K	3360	6
65-140	8.5" SQUARE CANOPY - BRONZE	40	4000K	4800	6
65-141	8.5" SQUARE CANOPY - BRONZE	40	5000K	4800	6
65-142	10" SQUARE CANOPY - BRONZE	28	4000K	3360	4
65-143	10" SQUARE CANOPY - BRONZE	28	5000K	3360	4
65-144	10" SQUARE CANOPY - BRONZE	40	4000K	4800	4
65-145	10" SQUARE CANOPY - BRONZE	40	5000K	4800	4
65-146	10" SQUARE CANOPY - BRONZE	60	4000K	7200	4
65-147	10" SQUARE CANOPY - BRONZE	60	5000K	7200	4
65-148	10" SQUARE CANOPY - BRONZE	70	4000K	8400	4
65-149	10" SQUARE CANOPY - BRONZE	70	5000K	8400	4
ACCESSORIES					
65-150	ADD-ON EMERGENCY BATTERY BACKUP				10
86-203	ADD-ON MICROWAVE SENSOR				100
86-204	ADD-ON PHOTOCELL				100



COLOR SELECTABLE ROUND CANOPY FIXTURES

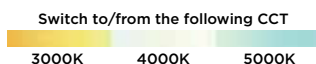

Add on Emergency Backup Battery for LED Round Canopy Light

**CCT SELECTABLE
3000K/4000K/5000K
DLC PREMIUM CERTIFIED
5 WATTAGE OPTIONS
1-10V DIMMING
150° BEAM ANGLE
IP65**

**CEILING OR PENDANT MOUNTING
OPTIONAL MICROWAVE SENSOR,
& ADD-ON EM AVAILABLE**



ITEM	DESCRIPTION	W	FINISH	CCT	LM	LIFE/HRS	PK
65-623	25W LED CANOPY LIGHT	25	White	3000/4000/5000K	2800-3322	50K	4
65-624	25W LED CANOPY LIGHT	25	Bronze	3000/4000/5000K	2800-3322	50K	4
65-625	40W LED CANOPY LIGHT	40	White	3000/4000/5000K	4425-5293	50K	4
65-626	40W LED CANOPY LIGHT	40	Bronze	3000/4000/5000K	4425-5293	50K	4
65-627	55W LED CANOPY LIGHT	55	White	3000/4000/5000K	6297-7546	50K	4
65-628	55W LED CANOPY LIGHT	55	Bronze	3000/4000/5000K	6297-7546	50K	4
65-629	75W LED CANOPY LIGHT	75	White	3000/4000/5000K	8876-10485	50K	2
65-630	75W LED CANOPY LIGHT	75	Bronze	3000/4000/5000K	8876-10485	50K	2
65-631	100W LED CANOPY LIGHT	100	White	3000/4000/5000K	11946-13999	50K	2
65-632	100W LED CANOPY LIGHT	100	Bronze	3000/4000/5000K	11946-13999	50K	2
ACCESSORIES							
65-622	ADD-ON EMERGENCY BATTERY BACKUP						5
86-213	ADD-ON MICROWAVE SENSOR		White				50



ADJUSTABLE GOOSENECK FIXTURES

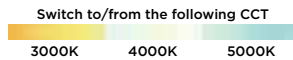

CCT SELECTABLE
3000K/4000K/5000K

30W/40W/50W
SELECTABLE

INTEGRATED PHOTOCELL
WITH ON/OFF SWITCH

0-10V DIMMING

2KV SURGE PROTECTION

DIE CAST ALUMINUM
WITH UV POWDER
COATED FINISH

IP65 RATED
50,000 HOURS



65-660
White
includes 16" mounting arm



65-661
Black
includes 16" mounting arm



65-662
Bronze
includes 16" mounting arm



ITEM	DESCRIPTION	WATTAGE SELECTABLE	CCT SELECTABLE	LM	PACK
65-660	LED GOOSENECK WHITE FINISH	30W/40W/50W	3000/4000/5000K	3300 - 5500	1
65-661	LED GOOSENECK BLACK FINISH	30W/40W/50W	3000/4000/5000K	3300 - 5500	1
65-662	LED GOOSENECK BRONZE FINISH	30W/40W/50W	3000/4000/5000K	3300 - 5500	1
65-657	24" ACCESSORY ARM WHITE FINISH	--	--	--	15
65-658	24" ACCESSORY ARM BLACK FINISH	--	--	--	15
65-659	24" ACCESSORY ARM BRONZE FINISH	--	--	--	15



LED ADJUSTABLE VAPOR TIGHT FIXTURES

90° ADJUSTABLE ARM

RED/GREEN/BLUE SELECTABLE VERSION

3000K/4000K/5000K SELECTABLE VERSION

WALL OR CEILING MOUNT

DURABLE DIE-CAST ALUMINUM BODY AND PROTECTIVE CAGE

GRAY FINISH/FROSTED GLASS

IP65

ENERGY STAR

Select the CCT setting (Model 65-550) or the RGB setting (Model 65-551).

Red/Green/Blue selectable
Red: 500 Lumens
Green: 1000 Lumens
Blue: 200 Lumens



CCT

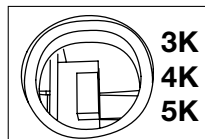

RGB

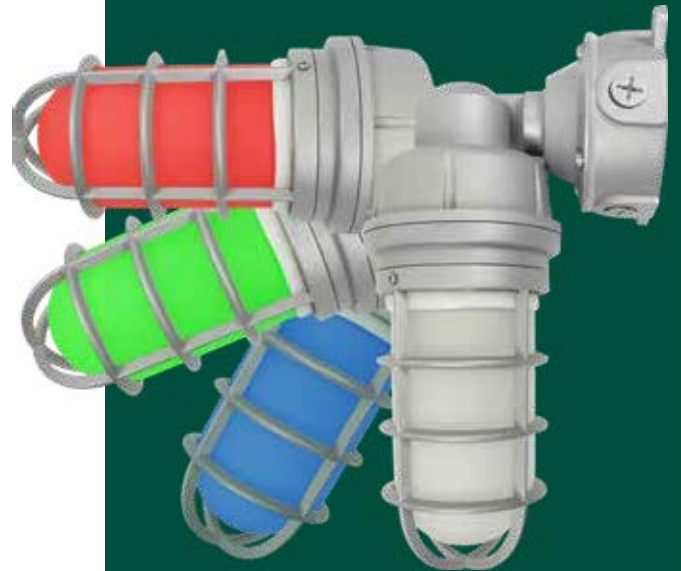
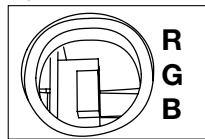

FIXTURE ADJUSTS A FULL 90° IN MULTIPLE INCREMENTS.



ITEM	DESCRIPTION	W	CCT/RGB	LM	PK
65-550*	GRAY/20W-3K/4K/5K SELECTABLE	20	3000/4000/5000K	1700-2000	6
65-551	GRAY/20W-RGB SELECTABLE	20	Red/Green/Blue	Red: 500lms/Green: 1000lms/ Blue: 200lms	6



ColorQuick™

Selectable Color Technology

Switch to/from the following CCT

3000K 4000K 5000K



BACKLIT FLAT PANEL CCT & WATTAGE SELECTABLE



Available in
Sizes: 2'x2', 1'x4' & 2'x4'

- BACKLIT LED TECHNOLOGY
- 0-10V DIMMING
- 80 CRI
- 100-277V/100-347V
- INTEGRATED EM OPTIONS
- DLC CERTIFIED
- DAMP LOCATION
- 50,000 HOURS



ColorQuick™

Selectable Color Technology

Switch to/from the following CCT



PowerQuick™
Wattage Selectable

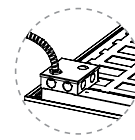
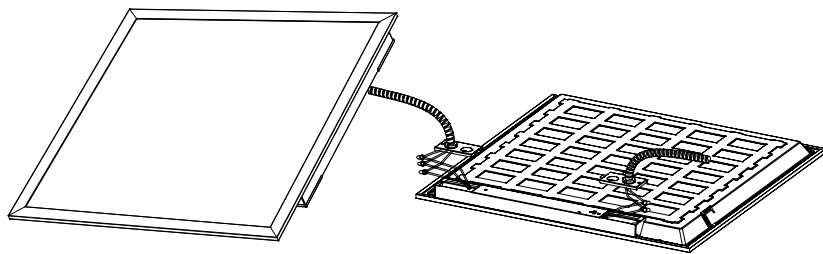

Optional junction box for excess wire, available separately.

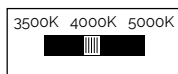

Selectable CCT
3500K, 4000K, 5000K

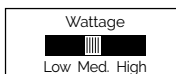

Wattage
Selectable



ITEM	DESCRIPTION	WATTS	VOLTAGE	CRI	CCT SELECTABLE	LM	LIFE/HRS.	PACK
LED BACK-LIT FLAT PANEL WITH COLORQUICK TECHNOLOGY								
65-571R1	2'x2' LED BACKLIT	20/30/40W	100-277V	>80	3500/4000/5000K	2200L-4600	50K	1
65-572R1	2'x4' LED BACKLIT	30/40/50W	100-277V	>80	3500/4000/5000K	3300L-5750	50K	1
65-573R1	1'x4' LED BACKLIT	20/30/40W	100-277V	>80	3500/4000/5000K	2200L-4600	50K	1
65-575R1	2'x2' LED EM BACKLIT	20/30/40W	100-347V	>80	3500/4000/5000K	2200L-4600	50K	1
65-576R1	2'x4' LED EM BACKLIT	30/40/50W	100-347V	>80	3500/4000/5000K	3300L-5750	50K	1
65-577R1	1'x4' LED EM BACKLIT	20/30/40W	100-277V	>80	3500/4000/5000K	2200L-4600	50K	1
65-581R1	2'x2' LED BACKLIT	20/30/40W	100-277V	>80	3500/4000/5000K	2200L-4600	50K	1
65-582R1	2'x4' LED BACKLIT	30/40/50W	100-277V	>80	3500/4000/5000K	2200L-4600	50K	1
65-583R1	1'x4' LED BACKLIT	220/30/40W	100V-347V	>80	3500/4000/5000K	2200L-4600	50K	1
65-585R1	2'x2' LED EM BACKLIT	20/30/40W	100-347V	>80	33500/4000/5000K	3300L-5750	50K	1
65-586R1	2'x4' LED EM BACKLIT	30/40/50W	100-347V	>80	33500/4000/5000K	2200L-4600	50K	1
65-587R1	1'x4' LED EM BACKLIT	20/30/40W	100-347V	>80	33500/4000/5000K	4200L-4400	50K	1

ITEM	DESCRIPTION	DIMENSIONS	FINISH	PACK
------	-------------	------------	--------	------

LED FLAT PANELS ACCESSORIES

LED Back-lit suspension kit — includes all necessary mounting hardware and 4' of airplane cable

65-591	2'x2' SUSPENSION KIT			30/1
65-592	1'x4' SUSPENSION KIT			30/1
65-593	2'x4' SUSPENSION KIT			30/1

LED Back-lit surface mount frame kit — includes all necessary hardware — use with EM Panels

65-595	1'x4' FRAME KIT	48"L x 12 11/16"W x 4 5/16"D	White	10/1
65-596	2'x2' FRAME KIT	24 1/16"L x 24 9/16"W x 4 5/16"D	White	10/1
65-597	2'x4' FRAME KIT	48"L x 24 9/16"W x 4 5/16"D	White	10/1

LED Back-lit recessed flange kit — includes all necessary hardware - EM Version

65-588	1'x4' RECESSED FLANGE KIT	49 3/16"L x 13 1/4"W x 1 1/4"D	White	10/1
65-589	2'x2' RECESSED FLANGE KIT	25 3/16"L x 25 3/16"W x 1 1/2"D	White	10/1
65-590	2'x4' RECESSED FLANGE KIT	49 3/16"L x 25 3/16"W x 1 1/2"D	White	10/1

Add-on junction box (increases flexibility for branch circuit wiring)

65-594	Add-On Junction Box			20/1
--------	---------------------	--	--	------

Add-on frame kits — Slim

65-598	1'X4' Backlit Panel Frame Kit	48"L x 12"W x 2 1/2"H	White	10
65-599	2'X4' Backlit Panel Frame Kit	48"L x 12"W x 2 1/2"H	White	10
65-600	2'X2' Backlit Panel Frame Kit	24"L x 24"W x 2 1/2"H	White	10



SELECTABLE STRIPS WITH INTEGRATED EM MICROWAVE SENSOR

INTEGRATED MW SENSOR HAS ON/OFF AND BI-LEVEL DIMMING CAPABILITIES DOWN TO 30%

NEW 2' & 4' VERSION

CCT SELECTABLE
3500K/4000K/5000K

SELECTABLE WATTAGE
30W/40W/50W (65-699)

0-10V DIMMING

65-698 - EM MODE:
4W/90 MIN. RUN TIME

65-699 - EM MODE:
8W/90 MIN. RUN TIME

2KV SURGE PROTECTION



ColorQuick™

Selectable Color Technology



PowerQuick™

Wattage Selectable

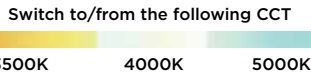

Optional
Suspension Kits
Available



ITEM	DESCRIPTION	WATTAGE SELECTABLE	VOLTAGE	CCT SELECTABLE	LM	CRI	PACK	
65-698	2' LINEAR STRIP W/ EM & SENSOR	20W	100-277V	3500/4000/5000K	2735-2830	80	8	
*65-699	4' LINEAR STRIP W/ EM & SENSOR	30W/40W/50W	100-277V	3500/4000/5000K	3900-6750	80	6	
Accessories								
65-706	2' & 4' SUSPENSION KIT — 59" SUSPENSION LENGTH — Includes All Necessary Mounting Hardware							50



2' & 4' LED DOUBLE STRIP LIGHTS

HIGH LUMEN OUTPUT
110 LPW
DAMP LOCATION RATED
2KV SURGE PROTECTION
50,000 HOURS
5 YEAR WARRANTY
ENERGY STAR CERTIFIED



Easy Installation



86-211 PIR Sensor



ITEM	DESCRIPTION	W	CCT	LM	PACK
65-1070	2' LED DOUBLE LIGHT STRIP	20	4000K	2200	12
65-1071	4' LED DOUBLE LIGHT STRIP	43	4000K	4750	8
Accessories					
86-211	PIR SENSOR - WHITE				20



4" LED SURFACE MOUNT FIXTURES

CCT SELECTABLE
3000K/4000K/5000K*

DIMMABLE
MOUNTS TO
4" JUNCTION BOXES

ENERGY STAR
WET LOCATION

AVAILABLE IN WHITE,
BRUSHED NICKEL, BRONZE
OR BLACK FINISH

3000K & 5000K VERSIONS
AVAILABLE IN CONTRACTOR
6-PACKS

5 YEAR WARRANTY



ColorQuick™

Selectable Color Technology

Switch to/from the following CCT



Color temperature selection switch

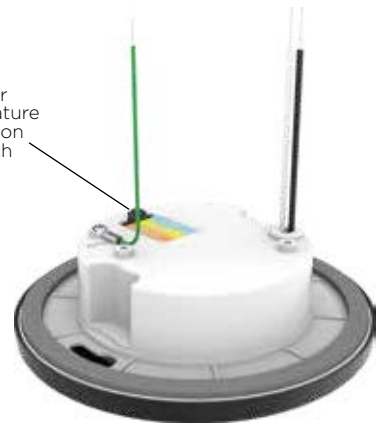

ITEM	DESCRIPTION	CCT	LM	PACK
62-1580	4" LED - WHITE - CONTRACTOR 6-PACK	3000K	650	4
62-1590	4" LED - WHITE - CONTRACTOR 6-PACK	5000K	680	4
62-1581*	4" LED - WHITE	3000/4000/5000K	680-720	16
62-1582*	4" LED - BRUSHED NICKEL	3000/4000/5000K	680-720	16
62-1583*	4" LED - BRONZE	3000/4000/5000K	680-720	16
62-1584*	4" LED - BLACK	33000/4000/5000K	680-720	16



11" & 14" SQUARE & 19" ROUND LED CLOUD FIXTURES



**CCT SELECTABLE
3000K/4000K/5000K**

**11" & 14" SQUARE
19" ROUND**

**PMMA
NON-YELLOWING LENS**

**AVAILABLE WITH OR
WITHOUT ON/OFF
MICROWAVE SENSOR**

DAMP LOCATION

ENERGY STAR®



ColorQuick™

Selectable Color Technology

Switch to/from the following CCT



ITEM	DESCRIPTION	W	V	CCT	LM	HEIGHT (IN)	PACK
62-1214*	11" SQUARE ACRYLIC LED FLUSH	16	120	3000/4000/5000K	990-1100	3.25	6
62-1215	11" SQUARE ACRYLIC LED FLUSH w/SENSOR	16.5	120	3000/4000/5000K	990-1100	3.25	6
62-1216*	14" SQUARE ACRYLIC LED FLUSH	20	120	3000/4000/5000K	1230-1330	3.25	4
62-1217	14" SQUARE ACRYLIC LED FLUSH w/SENSOR	20.5	120	3000/4000/5000K	1230-1330	3.25	4
62-1218*	19" ACRYLIC LED FLUSH FIXTURE	32	120	3000/4000/5000K	2527-2732	4.75	2
62-1219	19" ACRYLIC LED FLUSH FIXTURE w/SENSOR	32.5	120	3000/4000/5000K	2527-2732	4.75	2



INTRODUCING “SHOTGUN” – SUPERIOR ILLUMINATION FOR HIGH DEMAND APPLICATIONS

SLEEK DESIGN, RUGGED
CONSTRUCTION

AVAILABLE IN BLACK OR
WHITE TEXTURED FINISH

10W/20W/30W VERSIONS

HIGH CRI & R9 VALUES

MULTIPLE LUMEN AND
BEAM ANGLE OPTIONS

DIMMABLE



10 WATT ELONGATED CYLINDER



20 WATT ELONGATED CYLINDER



30 WATT ELONGATED CYLINDER



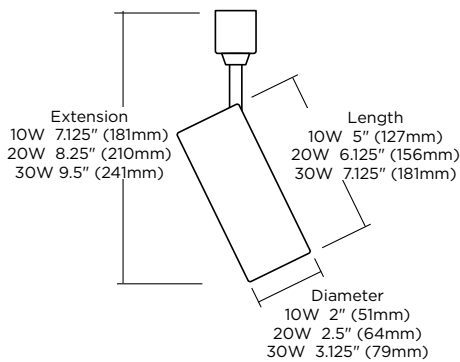

For use with Satco "H" type track systems



ITEM	DESCRIPTION	W	FINISH	LM	BEAM ANGLE	PACK
TH601	PRO SERIES - 10W - WHITE - 24°	10W	WHITE	600	24°	12
TH602	PRO SERIES - 10W - BLACK - 24°	10W	BLACK	600	24°	12
TH603	PRO SERIES - 10W - WHITE - 36°	10W	WHITE	600	36°	12
TH604	PRO SERIES - 10W - BLACK - 36°	10W	BLACK	600	36°	12
TH611	PRO SERIES - 20W - WHITE - 24°	20W	WHITE	1200	24°	12
TH612	PRO SERIES - 20W - BLACK - 24°	20W	BLACK	1200	24°	12
TH613	PRO SERIES - 20W - WHITE - 36°	20W	WHITE	1200	36°	12
TH614	PRO SERIES - 20W - BLACK - 36°	20W	BLACK	1200	36°	12
TH621	PRO SERIES - 30W - WHITE - 24°	30W	WHITE	2000	24°	12
TH622	PRO SERIES - 30W - BLACK - 24°	30W	BLACK	2000	24°	12
TH623	PRO SERIES - 30W - WHITE - 36°	30W	WHITE	2000	36°	12
TH624	PRO SERIES - 30W - BLACK - 36°	30W	BLACK	2000	36°	12

93 CRI	3000 K	120V
DIMMABLE	50,000 HOURS	5 Year Warranty
ETL LISTED	FC	
Efficiency Standards		
JAB T24	California Title 24 Residential and Non-Residential Compliant	



MOTIVATION®

MOTIVATION® IS HERE! NOW YOU CAN MERCHANDISE YOUR PRODUCTS IN MULTIPLE WAYS.

SATCO's motivation program allows you to build and create your own gridwall, tower or gondola display from one, two, or four-fixture panels.

It is well known that product placement can have a direct impact on sales. Our Motivation program has been designed to help you choose the best merchandising option to highlight the products most valuable features and to provide your customer with the opportunity to interact with products prior to purchase.

Engage customer interest, maximize product exposure, and increase profits with a complete line of showcasing displays that cover a variety of merchandising needs. Make the most out of your sales space with a SATCO Motivation display fixture today!

CONTACT YOUR SATCO SALES REP FOR MORE INFORMATION



GRIDWALL DISPLAY

GONDOLA DISPLAY

TOWER DISPLAY

SLATWALL MOUNTED MERCHANDISER

Present a number of LED assortments with matching descriptive graphics. Created for easy installation, this merchandiser was designed with a lightweight styrene backer that mounts directly to your slatwall. Easily mount an interchangeable header graphic to help advertise new product!



SA1333

Interchangeable graphics

Individual On/Off switches

Available Product Demonstrator

See product sheet SA2813 for more details.



DOWNLOAD THE PRODUCT SHEET TO LEARN MORE!



RESIDENTIAL & COMMERCIAL HIGH LUMEN FILAMENT LAMPS

REPLACES UP TO 200W INCANDESCENT

IMPROVED LUMENS PER WATT—HIGHER EFFICIENCY

LED FILAMENT AND GLASS ENVELOPE CONSTRUCTION

DIMMABLE*

WET LOCATION

T20 COMPLIANT†

3 YEAR WARRANTY



ITEM	DESCRIPTION	W	V	CCT	BASE TYPE	LM	CRI	LIFE/HRS.	MOL (IN.)	PACK
125W EQUIVALENT										
S12444**	17A21/FR/LED/E26/930/120V	17	120V	3000K	E26	2000	90	15,000	5.2	24
S12445**	17A21/FR/LED/E26/940/120V	17	120V	4000K	E26	2000	90	15,000	5.2	24
S12446**	17A21/FR/LED/E26/950/120V	17	120V	5000K	E26	2000	90	15,000	5.2	24
150W EQUIVALENT										
S12447*	18.5A21/FR/LED/E26/830/120V	18.5	120V	3000K	E26	2610	80	15,000	5.2	24
S12448*	18.5A21/FR/LED/E26/840/120V	18.5	120V	4000K	E26	2610	80	15,000	5.2	24
S12449*	18.5A21/FR/LED/E26/850/120V	18.5	120V	5000K	E26	2610	80	15,000	5.2	24
200W EQUIVALENT										
S12450	21A23/FR/LED/E26/830/120V/ND	21	120V	3000K	E26	2900	80	15,000	5.6	24
S12451	21A23/FR/LED/E26/840/120V/ND	21	120V	4000K	E26	2900	80	15,000	5.6	24
S12452	21A23/FR/LED/E26/850/120V/ND	21	120V	5000K	E26	2900	80	15,000	5.6	24



HIGH LUMEN A25 LED LAMPS FOR LARGER RESIDENTIAL & COMMERCIAL SPACES

HIGH EFFICIENCY LED'S -
USES ONLY 30W TO REPLACE
300W TRADITIONAL
INCANDESCENT BULBS
15,000 HRS, 3 YR WARRANTY
SHATTERPROOF PLASTIC LENS
AVAILABLE IN 3 COLOR
TEMPERATURES,
3000K, 4000K, 5000K
STANDARD E26 BASE
DAMP LOCATION RATED



ITEM	DESCRIPTION	W	V	CCT	BASE TYPE	LM	CRI	LIFE/HRS.	MOL (IN.)	PACK
300W A25 REPLACEMENT										
S11465	30A25/LED/830/120V/ND	30	120V	3000K	E26	3750	80	15,000	7.32	24
S11466	30A25/LED/840/120V/ND	30	120V	4000K	E26	3750	80	15,000	7.32	24
S11467	30A25/LED/850/120V/ND	30	120V	5000K	E26	3750	80	15,000	7.32	24

FEATURED PRODUCT CASE STUDY

As a leading supplier of commercial lighting, SATCO® provides excellent customer service and sales experience needed in today's market. Installing samples for our customer to demo, quality of the fixtures, and a competitive price point, were the deciding factors for the client. Illuminating a 600,000 sq. ft. facility is no easy feat, however, with sufficient tools to assist in the process, and terrific availability and shipping time, Satco is unprecedented.



CLEAN DESIGN THROUGH AN LED SOLUTION



65-797R1

LED UFO HighBay



A lighting layout tool featured on the website provided a photometric drawing, getting this project off the ground and completed quickly. The LED UFO Highbay with its 240-watt output did not only meet the requirements, it exceeded them. At the time of purchase, most of the fixtures were available with the remaining to follow in just a few weeks. Competitors were anywhere from 12 weeks to 6 months out. Installing a new LED lighting solution provided a clean design and will reduce future maintenance and repairs.

**SCAN THE QR CODE TO CHECK
OUT THE LIGHTING LAYOUT TOOL!**



CCT AND WATTAGE SELECTABLE HI-PRO LED LAMPS



- CCT SELECTABLE
- WATTAGE SELECTABLE
- IMPROVED LUMENS PER WATT — HIGHER EFFICIENCY
- REDUCED JACKET SIZE
- ENCLOSED FIXTURE RATED
- DAMP LOCATION
- BUILT IN SURGE PROTECTION
- 50,000 HOURS

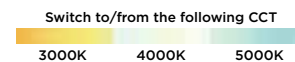

ITEM	DESCRIPTION	W	V	BASE TYPE	CCT SELECTABLE	LUMENS @ 5K 100% PWR 50% PWR	CRI	LIFE HRS.	M.O.L. (IN.)	PACK
S13160	20W/AP23/LED/CCT/100-277V/E26	20	100-277	E26	3000/4000/5000K	2600 N/A	80	50K	5.12	24
S13161	25W/AP23/LED/CCT/100-277V/E26	25	100-277	E26	3000/4000/5000K	3250 N/A	80	50K	5.12	24
S13162	35W/AP28/LED/CCT/100-277V/E26	35/17	100-277	E26	3000/4000/5000K	4550 2380	80	50K	6.26	12
S13163**	35W/AP28/LED/CCT/100-277V/EX39	35/17	100-277	EX39	3000/4000/5000K	4550 2380	80	50K	6.54	12
S13164	45W/AP32/LED/CCT/100-277V/E26	45/22	100-277	E26	3000/4000/5000K	5850 3060	80	50K	7.05	12
S13165**	45W/AP32/LED/CCT/100-277V/EX39	45/22	100-277	EX39	3000/4000/5000K	5850 3060	80	50K	7.32	12
S13166	65W/AP37/LED/CCT/100-277V/E26	65/32	100-277	E26	3000/4000/5000K	8450 4420	80	50K	7.76	12
S13167**	65W/AP37/LED/CCT/100-277V/EX39	65/32	100-277	EX39	3000/4000/5000K	8450 4420	80	50K	8.03	12



CCT & WATTAGE SELECTABLE HI-PRO LAMPS FOR LARGE SCALE LIGHTING APPLICATIONS

- CCT SELECTABLE
3000K/4000K/5000K
- WATTAGE SELECTABLE
- ENCLOSED FIXTURE RATED
- ADVANCED THERMAL MANAGEMENT
- DAMP LOCATION
- 4KV BUILT IN SURGE PROTECTION
- 50,000 HOURS



ColorQuick™
Selectable Color Technology

Switch to/from the following CCT



PowerQuick™
Wattage Selectable

Wide Variety of Wattage Options





ITEM	DESCRIPTION	WATTAGE SELECTABLE	CCT SELECTABLE	LM/WATTAGE HIGH/MED/LOW	CRI	M.O.L. (IN)	PACK
S23146	18W/LED/HID/CCT/E26	18/16/12	3000/4000/5000	2520/2240/1680	80	6.29	24
S23147	22W/LED/HID/CCT/E26	22/18/16	3000/4000/5000	3080/2520/2240	80	6.89	24
S23148	27W/LED/HID/CCT/E26	27/22/18	3000/4000/5000	3780/3080/2520	80	6.89	24
S23151	27W/LED/HID/CCT/EX39	27/22/18	3000/4000/5000	3780/3080/2520	80	7.48	24
S23149	36W/LED/HID/CC T/E26	36/27/18	3000/4000/5000	5040/3780/2520	80	8.27	24
S23152	36W/LED/HID/CCT/EX39	36/27/18	3000/4000/5000	5040/3780/2520	80	8.50	24
S23140	45W/LED/HID/CCT/E26	45/36/27	3000/4000/5000	6300/5040/3780	80	9.45	12
S23141	45W/LED/HID/CCT/EX39	45/36/27	3000/4000/5000	6300/5040/3780	80	9.69	12
S23142	54W/LED/HID/CCT/EX39	54/45/36	3000/4000/5000	7560/6300/5040	80	9.69	12
S23150	63W/LED/HID/CCT/EX39	63/54/45	3000/4000/5000	8820/7560/6300	80	10.28	12
S23143	80W/LED/HID/CCT/EX39	80/63/54	3000/4000/5000	11200/8820/7560	80	9.96	4
S23144	100W/LED/HID/CCT/EX39	100/80/63	3000/4000/5000	14000/11200/8820	80	10.55	4
S23145	120W/LED/HID/CCT/EX39	120/100/80	3000/4000/5000	16800/14000/11200	80	11.33	4



Color
temperature
selection switch

Intelligent
sensor port,
277-480V
lamps only

HI-PRO CCT SELECTABLE HIGH VOLTAGE LED LAMPS

CCT SELECTABLE
3000K/4000K/5000K

277-347V &
277-480V OPTIONS

SENSOR PORT ON ALL
277-480 VOLT VERSIONS

ENCLOSED FIXTURE
RATED

ADVANCED THERMAL
MANAGEMENT

DAMP LOCATION

4KV BUILT IN SURGE
PROTECTION

50,000 HOURS



ColorQuick™

Selectable Color Technology

Switch to/from the following CCT





80-954
Hi-Pro WiFi
Module†



80-955
Hi-Pro Motion
Sensor / Infra-Red



80-956
Hi-Pro
Photocell



80-957
Hi-Pro Motion
Sensor/Microwave



ITEM	DESCRIPTION	W	V	BASE TYPE	LM LOW/HIGH/MED	CRI	LIFE/HRS.	M.O.L. (IN.)	PACK
S23160	18W/LED/HID/CCT/E26	18	277-347	E26	2340-2520-2430	80	50K	6.3	24
S23161	27W/LED/HID/CCT/E26	27	277-347	E26	3510-3780-3645	80	50K	6.89	24
S23162	36W/LED/HID/CCT/E26	36	277-480	E26	4680-5040-4860	80	50K	7.73	12
S23163	45W/LED/HID/CCT/E26	45	277-480	E26	5850-6300-6075	80	50K	8.91	12
S23164	36W/LED/HID/CCT/EX39	36	277-480	EX39	4680-5040-4860	80	50K	8.35	12
S23165	45W/LED/HID/CCT/EX39	45	277-480	EX39	5850-6300-6075	80	50K	9.53	12
S23166	54W/LED/HID/CCT/EX39	54	277-480	EX39	7020-7560-7290	80	50K	9.53	12
S23167	80W/LED/HID/CCT/EX39	80	277-480	EX39	10400-11200-10800	80	50K	9.88	4
S23168	100W/LED/HID/CCT/EX39	100	277-480	EX39	13000-14000-13500	80	50K	10.46	4

ITEM	DESCRIPTION
80-954	Hi-Pro Wi-Fi Module - (Satco STARFISH in the App store)
80-955	Hi-Pro Motion Sensor - Infra-Red - Standby bi-level dimming
80-956	Hi-Pro Motion Sensor - Infra-Red - Standby bi-level dimming
80-957	Hi-Pro Microwave motion sensor - On/Off with standby dimming option



Night light detail

LED RETROFIT WITH NIGHT LIGHT

Night light ring.
Switch off and back on to active nightlight mode. Switch off, then back on to reactivate downlight.

Night light
2200K / 100Lumens



Color selection switch:
Warm white 2700K
Soft White 3000K
Neutral White 3500K
Bright White 4000K
Daylight 5000K



ColorQuick

Selectable Color Technology

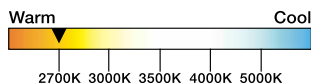

- CCT SELECTABLE
- EASY TO OPERATE
- NIGHT LIGHT MODE
- MOUNTS TO 5/6" RECESSED HOUSINGS
- DIMMABLE
- WET LOCATION
- T20, T24 COMPLIANT
- 50,000 HOURS
- ENERGY STAR CERTIFIED



ITEM	DESCRIPTION	W	V	BULB TYPE	FINISH	CCT SELECTABLE	LM	BEAM ANGLE	PACK
S11846	9WLED/NL/RDL/5-6/CCT-SEL/120V	9	120	RetroFit	White	27/30/35/40/50K	800	90°	8

CLOSET CODE YOU SHOULD KNOW



SATCO|NUVO FIXTURES WITH ZERO CLEARANCE RATING

Not Permitted

- Open or partially open fixtures including pendants

Permitted 12" from storage material -

No Certification

- Surface mounted incandescent, fluorescent or LED with a completely enclosed light source installed on wall above the door or on the ceiling

Permitted 6" from storage material -

No Certification

- Surface mounted fluorescent luminaires installed on the wall above the door or on the ceiling
- Recessed incandescent or LED luminaires with a completely enclosed light source installed in the ceiling
- Recessed fluorescent luminaires installed on the ceiling

Permitted Zero Clearance from storage material - Need UL1598 Closet



"Complies with NEC 410.16, A3, (C)(5)" and or UL 1598 suitable for closet installation/use will be on the fixture

SATCO-NUVO NOW HAS 120+ PRODUCTS THAT MEET NEC 410.16, A3, (C)(5) AND GROWING!

ZERO CLEARANCE RATED FIXTURES REDUCE CONCERNS ON THE DISTANCE A LIGHTING FIXTURE IS FROM OBJECTS IN A CLOSET.



LED CCT SELECTABLE GIMBAL DOWNLIGHTS WITH NEW TRIM FINISHES

- 5 SELECTABLE CCT SETTINGS
- 3 NEW TRIM FINISHES—BLACK, BRONZE AND BRUSHED NICKEL
- 2 SIZES—4" AND 5/6"
- STANDARD RECESSED HOUSING
- IC RATED
- DAMP LOCATION
- 50,000 HOURS
- ENERGY STAR CERTIFIED

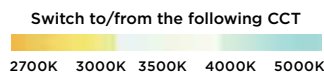

Color changeable - 5 color temperature settings



* **120 VOLT** **90 CRI** **50,000 HOURS**

ITEM	DESCRIPTION	W	FINISH	LM	BEAM ANGLE	M.O.L. (INCHES)	PACK
4"							
S11854	7.5WLED/DIR/4/60/CCT-SEL/120V/BL	7.5	BLACK	600	60°	3.54	8
S11855	7.5WLED/DIR/4/60/CCT-SEL/120V/BN	7.5	BRUSHED NICKEL	600	60°	3.54	8
S11856	7.5WLED/DIR/4/60/CCT-SEL/120V/BZ	7.5	BRONZE	600	60°	3.54	8
5-6"							
S11857	10.5WLED/DIR/5-6/CCT-SEL/120V/BL	10.5	BLACK	800	90°	3.9	8
S11858	10.5WLED/DIR/5-6/CCT-SEL/120V/BN	10.5	BRUSHED NICKEL	800	90°	3.9	8
S11859	10.5WLED/DIR/5-6/CCT-SEL/120V/BZ	10.5	BRONZE	800	90°	3.9	8

*Consult Satco or visit www.satco.com for an up to date dimmer compatibility list.



LED DEEP BAFFLE RECESSED RETROFITS

CCT SELECTABLE
2700K/3000K/3500K/
4000K/5000K

REPLACES 45 AND 65 WATT
REFLECTORS

REDUCED GLARE WITH
SUBTLE, PLEASING LIGHT
DISTRIBUTION

DIMMABLE
WET LOCATION

90 CRI

T20, T24 COMPLIANT

50,000 HOURS

ENERGY STAR CERTIFIED



Deep baffle for reduced glare,
architectural effect and subtle,
pleasing light distribution



ColorQuick™

Selectable Color Technology

Switch to/from the following CCT



Color selection switch:
Warm white 2700K
Soft White 3000K
Neutral White 3500K
Bright White 4000K
Daylight 5000K



ITEM	DESCRIPTION	W	V	BULB TYPE	FINISH	LM	BEAM ANGLE	PACK
S11844	7WLED/DB/4/CCT-SEL	7	120	RETROFIT	WHITE	600	80°	16
S11845	9WLED/DB/6/CCT-SEL	9	120	RETROFIT	WHITE	800	80°	8

*Visit www.satco.com for an up to date dimmer compatibility list



LED REMOTE DRIVER GIMBAL DOWNLIGHTS



CCT SELECTABLE
2700K/ 3000K/
3500K/4000K/5000K
360° ROTATION, 0° TO 80°
AIMING ANGLE
4" ROUND OR SQUARE, BLACK
OR WHITE FINISH
DAMP LOCATION
LONG LIFE—50,000 HOURS
ENERGY STAR

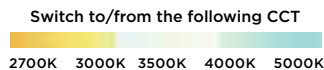
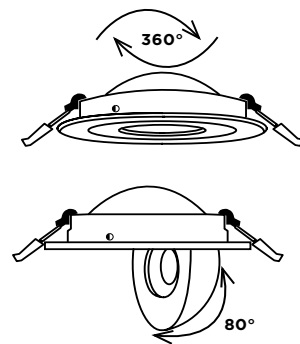

ITEM	DESCRIPTION	W	V	CRI	BEAM	LM	MOL (IN.)	MOD. (IN.)	LIFE/ HRS.	PACK
ROUND										
S11840	9WLED/GBL/4/CCT/RND/WH	9	120	90	36°	650-750	1.02	4.92	50K	1/12
S11842	9WLED/GBL/4/CCT/RND/BLK	9	120	90	36°	650-750	1.02	4.92	50K	1/12
SQUARE										
S11841	9WLED/GBL/4/CCT/SQ/WH	9	120	90	36°	650-750	1.02	4.92	50K	1/12
S11843	9WLED/GBL/4/CCT/SQ/BLK	9	120	90	36°	650-750	1.02	4.92	50K	1/12
ACCESSORIES										
80-943	ROUGH-IN PLATE / BARS 4" RD									1/12
80-946	GOOF RING 4" - DIRECT WIRE DL - 6" OUTSIDE DIAMETER									1/12
80-985	REMOTE DRIVER 6' EXTENSION CABLE									1/12



COMMERCIAL LED DOWNLIGHTS



Rough-In Plate

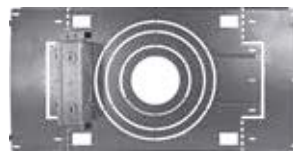

New construction is easy with these available accessories

CCT SELECTABLE
2700K/3000K/
3500K/4000K/5000K
0-10V DIMMING
80 CRI
WET LOCATION
ENERGY STAR CERTIFIED
5 YEAR WARRANTY



ColorQuick™

Selectable Color Technology

Switch to/from the following CCT
 2700K 3000K 3500K 4000K 5000K



ITEM	DESCRIPTION	W	V	LM	CRI	MOL (in.)	FINISH	LIFE HRS.	PACK
S11850	12WLED/CDL/4/CCT/120-277	12	120-277	1200	80	3.16	White	50K	8
S11851	15WLED/CDL/6/CCT/120-277	15	120-277	1600	80	3.46	White	50K	8
S11852	22WLED/CDL/8/CCT/120-277	22	120-277	2200	80	3.97	White	50K	4
S11853	30WLED/CDL/10/CCT/120-277	30	120-277	3500	80	4.49	White	50K	4
ACCESSORIES									
80-946	GOOF RING 4" - DIRECT WIRE DL - 6" OUTSIDE DIAMETER								12
80-947	GOOF RING 6" - DIRECT WIRE DL - 8" OUTSIDE DIAMETER								12
80-948	GOOF RING 8" - DIRECT WIRE DL - 10½" OUTSIDE DIAMETER								12
80-970	GOOF RING 10" - DIRECT WIRE DL - 13¼" OUTSIDE DIAMETER								12
80-959	ROUGH-IN PLATE/CDL 4/6/8/10								12



Attractive, informative 2-packs



COLOR QUICK™ LED TUBES

CCT SELECTABLE
BALLAST BYPASS
REPLACES 4' T8 & T12
BALLAST COMPATIBLE
REPLACES T8 ON
ELECTRONIC IS & RS
BALLASTS
SINGLE SLEEVE OR
RETAIL-READY 2-PACK
ALL GLASS TUBE
5 YEAR WARRANTY

CCT Selectable
4000K, 5000K, 6500K



ColorQuick™

Selectable Color Technology

Switch to/from the following CCT

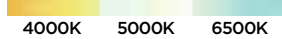

ITEM	DESCRIPTION	CCT	LM	PACK
DIRECT REPLACEMENT - BALLAST COMPATIBLE				
S11918*	10T8/LED/48/CCT-SEL/DR/2PK	4000/5000/6500K	1800	10-2 pks
S11928*	10T8/LED/48/CCT-SEL/DR	4000/5000/6500K	1800	25 pk
S11968*	10T8/LED/48/CCT-SEL/DR	3000/3500/4000K	1800	25 pk

*Visit satco.com for ballast compatibility list.



ITEM	DESCRIPTION	CCT	LM	PK
DIRECT WIRE - BALLAST BYPASS				
S11919**	12.5T8/LED/48/CCT-SEL/BP/2PK	4000/5000/6500K	1800	10-2 pks
S11929**	12.5T8/LED/48/CCT-SEL/BP	4000/5000/6500K	1800	25 pk
S11969**	12.5T8/LED/48/CCT-SEL/BP	3000/3500/4000K	1800	25 pk

**120-277V direct wire. Visit satco.com for installation & wiring instructions.

2', 3', & 4' LED T8 BAA COMPLIANT BALLAST BYPASS LAMPS



BUY AMERICAN ACT (BAA)
 LINEAR BALLAST BYPASS LED T8 LAMPS
 SINGLE OR DOUBLE
 ENDED WIRING OPTIONS
 SINGLE OR DOUBLE ENDED WIRING*
 ALL-GLASS TUBES
 DIRECT WIRE 120-277V LINE VOLTAGE
 SUITABLE FOR DAMP LOCATIONS
 DLC 5.1
 LONG LIFE—50,000 HOURS



ITEM	DESCRIPTION	CCT	LM	PACK
2' LED T8				
S11980	9T8/LED/24-830/BP/USA	3000K	1100	25
S11981	9T8/LED/24-835/BP/USA	3500K	1100	25
S11982	9T8/LED/24-840/BP/USA	4000K	1150	25
S11983	9T8/LED/24-850/BP/USA	5000K	1150	25
3' LED T8				
S11984	12T8/LED/36-830/BP/USA	3000K	1400	25
S11985	12T8/LED/36-835/BP/USA	3500K	1400	25
S11986	12T8/LED/36-840/BP/USA	4000K	1450	25
S11987	12T8/LED/36-850/BP/USA	5000K	1450	25
4' LED T8				
S11988	10.5T8/LED/48-830/BP/USA	3000K	1700	25
S11989	10.5T8/LED/48-835/BP/USA	3500K	1700	25
S11990	10.5T8/LED/48-840/BP/USA	4000K	1700	25
S11991	10.5T8/LED/48-850/BP/USA	5000K	1700	25
S11992	14T8/LED/48-830/BP/USA	3000K	1700	25
S11993	14T8/LED/48-835/BP/USA	3500K	1700	25
S11994	14T8/LED/48-840/BP/USA	4000K	1800	25
S11995	14T8/LED/48-850/BP/USA	5000K	1800	25
S11996	17T8/LED/48-830/BP/USA	3000K	2100	25
S11997	17T8/LED/48-835/BP/USA	3500K	2100	25
S11998	17T8/LED/48-840/BP/USA	4000K	2200	25
S11999	17T8/LED/48-850/BP/USA	5000K	2200	25

*Single ended wiring requires non-shunted sockets.





REMOTE CONTROLLED LED INDOOR/OUTDOOR STRING LIGHTS

COLOR CHANGING

12-15 COLOR CHANGING
LED BULBS INCLUDED

CHANGE COLORS WITH 9 FUNCTION
INFRARED WIRELESS REMOTE

NO WIFI NEEDED

CHANGEABLE COLORS: RED, GREEN,
BLUE, YELLOW, PURPLE,
LIGHT BLUE, ORANGE, WHITE
AND MANY MORE

ENERGY EFFICIENT

CONNECT UP TO 144 FT.,
3 SETS MAX. USING 1W LED BULBS

FOR RESIDENTIAL
AND COMMERCIAL USE

HEAVY DUTY 18 GAUGE WIRE

EASY INSTALLATION

3 YEAR WARRANTY



SATCO® | NUVO®



Wireless remote
No WIFI needed

INFRARED WIRELESS
REMOTE CONTROLLED

COLOR CHANGEABLE

**REMOTE CONTROLLED LED
INDOOR/OUTDOOR STRING LIGHTS**



ITEM	DESCRIPTION	BULBS		FIXTURES					
		# INCL.	WATTS PER BULB	CONNECTIBLE UNITS	CCT	W	V	FINISH	M/CASE QTY.
S8031	24FT/LED/SL/S14/IRR/RGBW/12V	12	1	3	2700-5000K	12	120	Black	4
S8033+	48FT/LED/SL/S14/IRR/RGBW/12V	15	1	3	2700-5000K	15	120	Black	4



LED INDOOR/OUTDOOR STRING LIGHTS

24' INCLUDES 12 BULBS
 60' INCLUDES 24 BULBS
 WARM WHITE 2200K-2700K
 ENERGY EFFICIENT
 FOR RESIDENTIAL AND
 COMMERCIAL USE
 HEAVY DUTY 18 GAUGE WIRE
 EASY INSTALLATION
 3 YEAR WARRANTY



WARM WHITE
 BLANCO CÁLIDO / BLANC CHAUD

STANDARD PLUG IN
 ON AND OFF ONLY



S8020
 24FT set with 12, 1W
 LED S14 bulbs, 2700K



S8030
 24FT set with 12, 1W
 LED S14 bulbs, 2200K



S8032
 60FT set with 24, 1W
 LED S14 bulbs, 2200K



S8034
 24FT set with 12, 1W
 LED G25 bulbs, 2200K



S8036
 24FT set with 12, 2W LED
 ST19 vintage style bulbs,
 2200K



S8037
 24FT set (Two pack) with
 24, 1W LED S14 bulbs,
 2200K



S8038
 24FT set with 24, 1W LED
 S14 bulbs and white cord,
 2200K

LED INDOOR/OUTDOOR STRING LIGHTS



ITEM	DESCRIPTION	BULBS		Type	FIXTURES				
		# INCL.	WATTS PER BULB		CONNECTIBLE UNITS	CCT	W	FINISH	PK.
S8020	24FT/LED/SL/S14/827K/120V	12	1	S14	30	2700K	12	Black	4
S8030	24FT/LED/SL/S14/822K/120V	12	1	S14	10	2200K	12	Black	4
S8032	60FT/LED/SL/S14/822K/120V	24	1	S14	5	2200K	24	Black	4
S8034	24FT/LED/SL/G25/822K/120V	12	2	G25	7	2200K	24	Black	4
S8036	24FT/VINT/SL/ST19/120V	12	2	ST19	7	2200K	24	Black	4
S8037	24FT/LED/SL/S14/822K/2PK/120V	24	2	S14	7	2200K	24	Black	4
S8038	24FT/LED/SL/S14/822K/WH/120V	12	1	S14	10	2200K	24	White	4



INCANDESCENT INDOOR/ OUTDOOR STRING LIGHTS

INCLUDES 12
INCANDESCENT S14 BULBS
CONNECT UP TO 72 FEET,
3 SETS MAX. USING 11 WATT
INCANDESCENT BULBS
WARM WHITE 2850K
FOR RESIDENTIAL AND
COMMERCIAL USE
HEAVY DUTY 18 GAUGE WIRE
EASY INSTALLATION
3 YEAR WARRANTY



WARM WHITE
BLANCO CÁLIDO / BLANC CHAUD

STANDARD PLUG IN
ON AND OFF ONLY

INCANDESCENT INDOOR/OUTDOOR STRING LIGHTS



ITEM	DESCRIPTION	BULBS		FIXTURES					
		# INCL.	WATTS PER BULB	CONNECTIBLE UNITS	CCT	W	FINISH	LIFE/HRS.	PK.
S8035	24FT/INCD/SL/S14/120V	12	11	3	2850K	132	Black	2500	4

Not for use with dimmers. Mounting hardware not included.

STRING LIGHTS - LAMPS NOT INCLUDED

STANDARD PLUG IN
ON AND OFF ONLY



S8035
24FT set with 12, 11W
incandescent S14 bulbs,
2850K

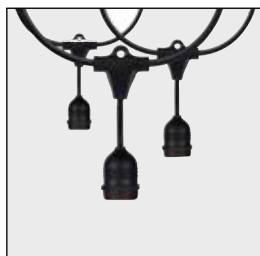

S8039
24FT, 12 socket cord
and plug only



STRING LIGHTS - LAMPS NOT INCLUDED

ITEM	DESCRIPTION	W	FINISH	PACK
S8039	24FT/SL/E26/BL/120V / 12 SOCKET CORD & PLUG ONLY	120	Black	4



PowerQuick™
Wattage Selectable

60W	80W	100W
7200 Lumens	9200 Lumens	11000 Lumens



ITEM	DESCRIPTION	W	V	BULB TYPE	BASE TYPE	FINISH	CCT	LM	CRI	MOL (IN.)	LIFE/ HRS.	PK
S13159	100W/LED/HID/TEMP/IP65	60/80/100	120-277	LED	PLUG	Yellow	5000	7200/9200/1100	80	14.1	50K	4



NEW! HI-PRO LED 120-277V WET LOCATION TEMPORARY WORK LIGHT

60W/80W/100W SELECTABLE
DURABLE, LIGHTWEIGHT
CONSTRUCTION OF HIGH RESISTANCE
PC MATERIAL
ENHANCED, PASSIVE
HEAT SINK DESIGN
EASY INSTALLATION;
PORTABLE, FLEXIBLE
HIGH LUMEN,
EFFICIENT LED LIGHTING
OMNI-DIRECTIONAL
360° BEAM ANGLE
HEAVY DUTY MOUNTING HOOK
25' POWER CORD INCLUDED
WET LOCATION
IP65
50,000 HOUR LIFE
5 YEAR WARRANTY



Power select:
60W/80W/100W Selectable



IP65



High resistance PC
material to protect the top
and bottom of the cage



Enhanced passive
heat sink design

#16/3 Ga. SJTW-3 Orange Outdoor Extension Cords

Satco carries a full line of #16/3 Ga. outdoor extension cords, rugged enough for any job site. See catalog SA1700 or go to www.satco.com for details.

ITEM	Length
93-5034	8 ft.
93-5035	15 ft.
93-5005	25 ft.
93-5006	50 ft.
93-5007	100 ft.



**PUTTING
POWER WHERE
YOU NEED IT**



OUTDOOR



**ORANGE OUTDOOR
LIGHT DUTY
EXTENSION CORDS**
16-3 SJTW-3 Orange Cord

- 93-5034 - 8 FT.
13A/125V - 1625W
- 93-5035 - 15 FT.
13A/125V - 1625W
- 93-5005 - 25 FT.
13A/125V - 1625W
- 93-5006 - 50 FT.
13A/125V - 1625W
- 93-5007 - 100 FT.
10A/125V - 1250W

**3 OUTLET OUTDOOR
EXTENSION CORDS**
12/3 GA. STW Orange Cord

- 93-5030 - 2 FT.
15A/125V - 1875W

**HEAVY DUTY
GREEN OUTDOOR
EXTENSION CORDS**
16-3 SJTW Green Cord

- 93-5024 - 25 FT.
13A/125V - 1625W
- 93-5025 - 50 FT.
13A/125V - 1625W
- 93-5026 - 80 FT.
10A/125V - 1250W

3 OUTLET INDOOR EXTENSION CORDS

16/2 SPT2
13A / 125V / 1625W

INDOOR USE ONLY

93-192	6 FT. WHITE
93-193	6 FT. BROWN
93-5020	6 FT. GREEN
93-194	9 FT. WHITE
93-195	9 FT. BROWN
93-5021	9 FT. GREEN
93-196	12 FT. WHITE
93-197	12 FT. BROWN
93-5022	12 FT. GREEN
93-198	15 FT. WHITE
93-199	15 FT. BROWN
93-5023	15 FT. GREEN

3 OUTLET INDOOR EXTENSION CORDS

16/3 SJT
13A / 125V / 1625W

- 3 Grounded Outlets
- 16/3 SJT Round Wire
- 3 Prong Plug
- Super Flexible
- Durable Plastic

93-5044	6 FT. BROWN
93-5045	6 FT. WHITE
93-5046	9 FT. BROWN
93-5047	9 FT. WHITE
93-5048	12 FT. BROWN
93-5049	12 FT. WHITE

LED PLASTIC FLOOD LITE WITH STAKE FOR OUTDOOR USE

18/2 SJTW

- 3.5 Watts
- 6 Ft. Green Cord
- Moulded Plug
- 200 Lumens
- 180° Rotation
- High Brightness LEDs

93-5058

HIDE-A-CORD

40" LENGTH - WHITE
S70-826



INDOOR

POWER STRIP SOLUTIONS

6 OUTLET SUPERIOR SURGE STRIP

91-221
 4' CORD - 14/3 SJTS
 6 OUTLET SUPERIOR SURGE STRIP
 540 JOULES RATING
 ON/OFF SWITCH WITH BUILT-IN RESETTABLE CIRCUIT BREAKER AND INDICATOR LIGHT
 15A-120V, 1800W
 PACKING: 12/MASTER



6 OUTLET PROFESSIONAL METAL SURGE STRIP

91-222
 4' CORD - 14/3 SJT
 6 OUTLET PROFESSIONAL METAL SURGE STRIP
 540 JOULES RATING
 ON/OFF SWITCH WITH BUILT-IN RESETTABLE CIRCUIT BREAKER AND INDICATOR LIGHT
 15A-120V, 1800W
 PACKING: 12/MASTER



6 OUTLET METAL SURGE POWER STRIP 300 JOULES



INDOOR USE
 15A-120V-1875W
 STRAIGHT PLUG
 LIGHTED ON-OFF W/BUILT-IN CIRCUIT BREAKER
 SURGE INDICATOR LIGHT
 1 ADAPTER RECEPTABLE



ITEM	WIRE TYPE	JOULES	COLOR	LENGTH
91-232	14/3 SJT	300	BEIGE	6 FT.



6 OUTLET METAL SURGE PROTECTOR

INDOOR USE ONLY

91-235

- BEIGE 6 OUTLET SURGE STRIP
- 6 FT. 14/3 SJT WITH STRAIGHT PLUG
- LIGHTED ON-OFF SWITCH W/CIRCUIT BREAKER
- SURGE INDICATOR LIGHT
- 1 ADAPTER RECEPTACLE
- 1200 JOULES
- 15A-120V
- 1875W



FLAT PLUG

6 OUTLET SURGE PROTECTOR

INDOOR USE ONLY

91-220 3' Cord - 14/3 SJT
91-229 6' Cord - 14/3 SJT

- WHITE 6 OUTLET SURGE STRIP
- ON-OFF SWITCH W/BUILT-IN-RESETTABLE CIRCUIT BREAKER
- 245 JOULES
- 15A-125V
- 1875W



6 OUTLET SURGE WALL TAP

INDOOR USE ONLY

91-223

- 6 OUTLET SURGE WALL TAP
- 540 JOULES RATING
- 15A-120V
- 1800W



SATCO'S LIBRARY

Satco|Nuvo catalogs, available in online and in print, provide a comprehensive guide to all of our current product.



SATCO LED LAMP REFERENCE GUIDE (SA2000-4)



SATCO LED FIXTURE REFERENCE GUIDE (NU1600)



SATCO LAMP SPECIFICATION GUIDE (SA2100-2)



SATCO STARFISH SMART LIGHTING CATALOG (SA2750)



COUNTERQUICK LED UNDERCABINET CATALOG (NU1759)



NUVO LIGHTING "IMAGINE" CATALOG (NU1550)



NUVO LIGHTING 2019 CATALOG (NU4050)



NUVO LIGHTING INSPIRATIONS SUPPLEMENT (NU1400)



NUVO LIGHTING REFLECTIONS SUPPLEMENT (NU1450)



NUVO LIGHTING "VISIONS" 2019 CATALOG (NU1700)

TRAINING WITH BOB

SATCO|NUVO offers lighting solutions that answer various challenges across a wide range of projects and market segments. Our product lines are constantly evolving to incorporate the newest technology, integrate controls, meet energy codes, field needs and much more.



SATCO's education director, Bob Nigrello takes you through several training videos to help guide you through everything from lighting basics to fixture layouts. These videos can be viewed on our youtube page in our "Training with Bob" playlist section.



SCAN TO
WATCH
TRAINING
WITH BOB!



SATCO Training With Bob: Lighting Basics Lesson 1

SHARE SAVE DESCRIPTION ...



SATCO PRODUCTS / NUVO LIGHTING

SUBSCRIBED



TRENDING SOLUTIONS FOR COLLECTIVE BUILDS

Multi-Family Lighting for Today

NUVO lighting, a division of SATCO, is one of the largest decorative lighting brands in America. It evolved from Satco's venerable understanding of the light source, how it sets the mood and helps creates the space.

With quality, value and style, NUVO provides beautiful, on-trend fixtures to the market at a competitive price.

Growing our business on our solid reputation for over 17 years, NUVO has one of the largest decorative fixture offerings in the lighting industry, with a vast selection of style and designs for nearly every application. This years decorative lines cover styles from mid-century modern to transitional designs and timeless classics.



60-7692



60-7811



60-7375



60-7468

NUVO®

MODERN CLASSIC STYLES

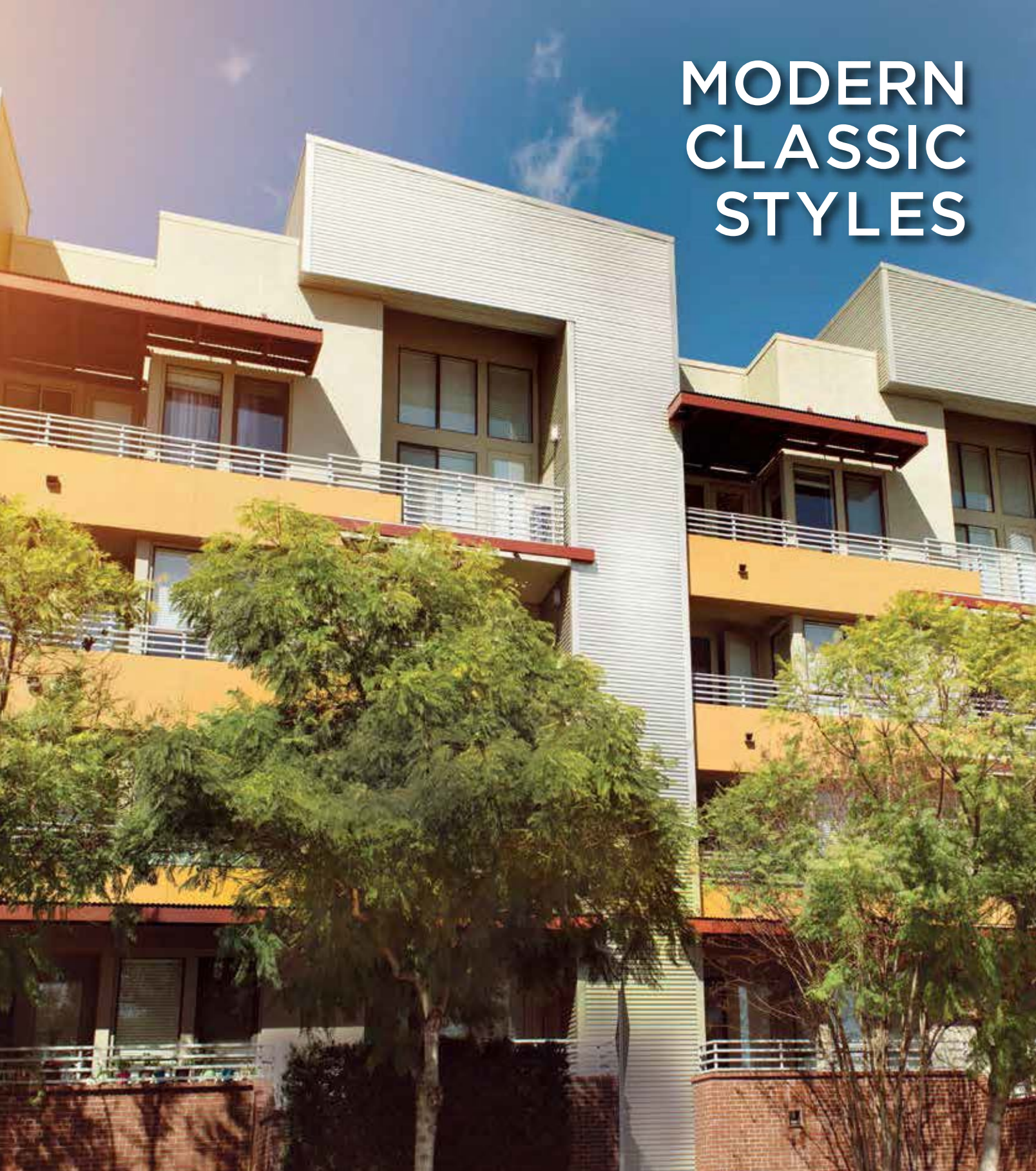

NEW STYLES AVAILABLE

Other Styles & Sizes Available at SATCO.com



1 LT MED. PENDANT
W:11" H:16¼"
60-7664
MATTE WHITE,
NATURAL BRASS/
OPAL WHITE GLASS

1 LT LG. PENDANT
W:16" H:21⅝"
60-7665
MATTE WHITE,
NATURAL BRASS/
OPAL WHITE GLASS



60-7665
Pendant



60-7663
SEMI-FLUSH

1 LT SEMI-FLUSH
W:11" H:12"
60-7663
MATTE WHITE,
NATURAL BRASS/
OPAL WHITE GLASS

1 LT SEMI-FLUSH
W:11" H:12"
60-7673
MATTE BLACK/
CLEAR SEEDED GLASS



LINCOLN

PENDANT, FLUSH AND SEMI FLUSH

This striking collection is inspired by an armillary sphere, which is fashioned around astronomically important details. Choose from a matte white finish with opal glass for a more ethereal style or matte black with clear seeded glass for a black tie, elegant look.



60-7672
FLUSH

2 LT MED. FLUSH
W:14 $\frac{3}{4}$ " H:6"
60-7662
MATTE WHITE,
NATURAL BRASS/
OPAL WHITE GLASS

2 LT LARGE FLUSH
W:14 $\frac{3}{4}$ " H:6"
60-7672
MATTE BLACK/
CLEAR SEEDED GLASS



1 LT MED. PENDANT
W:11" H:16 $\frac{1}{4}$ "
60-7674
MATTE BLACK/
CLEAR SEEDED GLASS

1 LT LG. PENDANT
W:16 $\frac{4}{8}$ " H:21 $\frac{1}{8}$ "
60-7675
MATTE BLACK/
CLEAR SEEDED GLASS

60-7674
Pendant

FINISH

Matte White/
Natural Brass,
Opal White Glass



Matte Black/
Clear Seeded
Brass



 **SATCO**® | **NUVO**®

HALTER

PENDANT

Minimalism at it's finest, renew your lighting with these stunning, modern farmhouse drum pendants. Offered in matte black or brass with a white shade or go for the natural brass shade and matte black finish, the choice is yours.

4 LT. PENDANT
60-7691
NATURAL BRASS/
WHITE FABRIC SHADE

4 LT. PENDANT
60-7692
MATTE BLACK/
WHITE FABRIC SHADE

4 LT. PENDANT
60-7693
MATTE BLACK/
NATURAL BRASS METAL SHADE

DIMENSIONS:
W:22 $\frac{5}{8}$ " H:21 $\frac{1}{8}$ "



60-7693



60-7691



60-7692

FINISH

Natural Brass
White Fabric
Shade



Matte Black
White Fabric
Shade



Matte Black
Natural Brass
Metal Shade



FLYNN

PENDANT

A streamlined design suited to today's no-nonsense style. A textured shade and matte black finish provide this charismatic design with its natural flair.

3 LT. PENDANT
60-7678
BLACK/WHITE TEXTILE
FABRIC SHADE

DIMENSIONS:
W: 22" H:21¾"

FINISH

Black/
White Textile
Fabric Shade

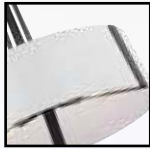

60-7678

SEE MORE DESIGNS
LIKE THESE AT
SATCO.COM

GLACIER

FLUSH AND VANITY

Crafted with striking attention-to-detail, this series brings a whole new level of contemporary style to your home's lighting. Refresh your bathroom with beautiful, iced glass displayed against a matte black finish.



60-7810



60-7811

2 LT FLUSH
W:13" H:13" EXT. 5 $\frac{5}{8}$ "
60-7810
MATTE BLACK/
ICED GLASS

1 LT VANITY
W:4 $\frac{3}{8}$ " H:10 $\frac{5}{8}$ "
60-7811
MATTE BLACK/
ICED GLASS

2 LT VANITY
W:22" H:4 $\frac{3}{8}$ " EXT. 4 $\frac{7}{8}$ "
60-7812
MATTE BLACK/
ICED GLASS

3 LT VANITY
W:34" H:4 $\frac{3}{8}$ " EXT. 4 $\frac{7}{8}$ "
60-7813
MATTE BLACK/
ICED GLASS

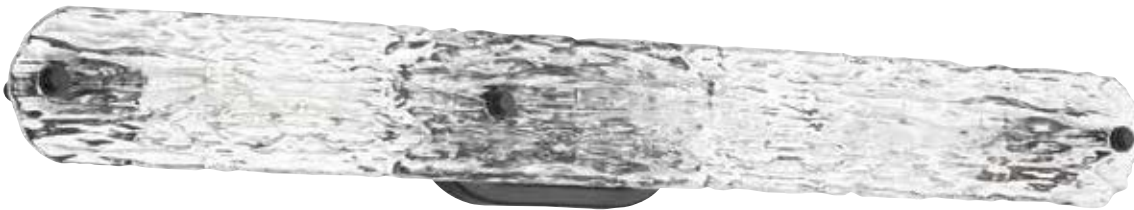

60-7813



60-7812

FINISH

Matte Black
Iced Glass

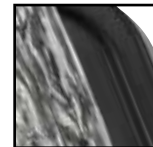

NLB TRUSTED WARRANTY EVALUATION PROGRAM

SATCO | NUVO has been approved by the National Lighting Bureau's Trusted Warranty Program.

This program awards certificates to lighting and lighting component companies that meet the NLB's objective quality standards and practices for warranty administration.



The National Lighting Bureau assesses companies based on five criteria:

- Formal Warranty Process
- Warranty Language
- Length of Business/Warranty Insurance
- Technical Evaluation
- Claims Review Evaluation

In demonstrating quality and reliability across these 5 categories, companies give industry stakeholders confidence in their manufacturers warranty policy.

Mary Beth Gotti, NLB Chair stated, "We are excited SATCO|NUVO is now certified for the Trusted Warranty Evaluation Program. The TWEP is an independent validator for their warranty program."

ABOUT THE NATIONAL LIGHTING BUREAU

The National Lighting Bureau is an independent, IRS-recognized not-for-profit, educational foundation that has served as a trusted lighting-information source since 1976. The NLB is focused on Promoting Lighting Excellence™ and helping the lighting industry solve its business problems. The NLB exists to create demand for High Benefit Lighting®—efficient lighting designed to optimize human performance, health, safety, and commerce by educating and acknowledging those who make and influence decisions about lighting. The Bureau provides its services to the public free of charge, thanks to the generous funding of the organization's sponsors: professional societies, trade associations, labor unions, manufacturers, and agencies of the U.S. government.

RAVEN

OUTDOOR SCONCE

Lighting that brings bold style and understated design, all in a modern package. A streamlined silhouette, LED technology, and a versatile finish combined to provide decorative illumination at its finest.

10" SCONCE6
8W/660 LUMENS
3000K/90CRI
W:4¾" H:10"
62-1425
MATTE BLACK

18" SCONCE
15W/1180 LUMENS
3000K/90CRI
W:4¾" H:18"
62-1426
MATTE BLACK

FINISH
Matte Black



LED Light Source



62-1425

62-1426

AUSTEN

POST, HANGING AND WALL

Austen lighting series features a classic design that brings a romantic charm to the outdoors with its transitional style. An elongated metal structure is finished in a versatile matte black to coordinate with existing finishes. The rippling water glass provides glimpses of the bulb while allowing for superior illumination through the clear panels. Conveying a sense of classic style allows this collection to shine bright on your home's exterior.



60-5995



60-5997



60-5996

FINISH

Matte Black
Clear Water Glass



1 LT POST LANTERN
W:7¾" H:20½"
60-5995
MATTE BLACK/
CLEAR WATER GLASS

1 LT HANGING LANTERN
W:7¾" H:17¼"
60-5996
MATTE BLACK/
CLEAR WATER GLASS

1 LT SM. WALL LANTERN
W:6" H:13¼" Ext. 7¾"
60-5997
MATTE BLACK/
CLEAR WATER GLASS

1 LT LG. WALL LANTERN
W:7¾" H:17½" Ext. 10"
60-5998
MATTE BLACK/
CLEAR WATER GLASS

MODERN
CONTEMPORARY

STILLWELL

POST, HANGING AND WALL

A lantern-style approach to its design makes the Stillwell outdoor series a bonafide hit. The translucent, water glass obscures the bulb while still providing plenty of light to go around. Its elongated structure is finished in matte black making it quite versatile to match with existing fixtures and home exteriors. A stunning collection ideally suited to bring grace and style to your homes landscape.



60-5959

MODERN CONTEMPORARY



60-5957



60-5958

FINISH
Matte Black
Water Glass



1 LT POST LANTERN
W:6½" H:17⅓"
60-5957
MATTE BLACK
WATER GLASS

1 LT HANGING LANTERN
W:6½" H:13⅓"
60-5958
MATTE BLACK
WATER GLASS

1 LT WALL LANTERN
W:6½" H:13⅓" Ext. 8¼"
60-5959
MATTE BLACK
WATER GLASS

JASPER

POST, HANGING AND WALL

Styled with a transitional approach, the Jasper outdoor collection features clean lines, and a structured silhouette with subtle hints of Asian-inspired influence. Finished in matte black, it will complement existing finishes and provide curb appeal to your walkway, driveway, and rich landscaping. The clear glass ensures maximum output, bringing light to even the most difficult areas to illuminate



60-5745



60-5746



60-5747

FINISH

Matte Black
Clear Glass



1 LT POST LANTERN
W:7½" H:14"
60-5745
MATTE BLACK/
CLEAR GLASS

1 LT HANGING LANTERN
W:7½" H:12¾"
60-5746
MATTE BLACK/
CLEAR GLASS
60-5747

1 LT WALL LANTERN
W:7½" H:11¼" Ext. 8⅝"
60-5747
MATTE BLACK/
CLEAR GLASS

SULLIVAN

POST, HANGING AND WALL

Sullivan combines clean lines and minimal details in one versatile design. The seeded clear glass provides subtle diffusion of light and is perfect for lighting the way into your home. The black finish works well with existing fixtures, bringing a stylish yet versatile appeal to your home's exterior.

FINISH

Matte Black
Clear Seeded Glass

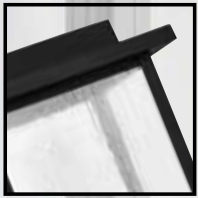

60-7375



60-7376

1 LT MED. WALL LANTERN
W:7½" H:12½" Ext. 6¼"
60-7375
MATTE BLACK/
CLEAR SEEDED GLASS

1 LT LG. WALL LANTERN
W:9¼" H:15½" Ext. 8"
60-7376
MATTE BLACK/
CLEAR SEEDED GLASS



60-7377

1 LT HANGING LANTERN
W:9" H:16 $\frac{5}{8}$ " Ext. :16 $\frac{5}{8}$ "
60-7377
MATTE BLACK/
CLEAR SEEDED GLASS



60-7378

1 LT POST FIXTURE
LANTERN
W:9" H:17 $\frac{1}{8}$ " Ext. :16 $\frac{5}{8}$ "
60-7378
MATTE BLACK/
CLEAR SEEDED GLASS

**SEE MORE DESIGNS
LIKE THESE AT
SATCO.COM**

OVERTOP LED

MATTE BLACK / SILVER SHADE

OUTDOOR - INTEGRATED LED

The fashionable, cylindrical silver metal and inner frosted shades support the LED light source of the Overtop wall lantern. Presented by an elegant single arm that extends from a broad back plate, Overtop is simplicity with a touch of glam.



1 LT MED. WALL
LANTERN
10W/900 LUMENS
3000K/90CRI
W:6" H:15" Ext. 6¾"
62-1607
MATTE BLACK/
SILVER

1 LT LG. WALL
LANTERN
10W/900 LUMENS
3000K/90CRI
W:8½" H:21½" Ext. 9½"
62-1608
MATTE BLACK/
SILVER

SATCO SHINING STAR!

Wilfredo Lopez began his career as a product specialist with SATCO six years ago, bringing with him unparalleled experience in electrical and lighting controls. Some may call him a hero, others may call him a friend, here at SATCO we call him our go-to guru.

When asked what first drew Wilfredo to consider working at SATCO he responds, “The people. My relationship with SATCO started years ago as a customer and I always loved that SATCO was a privately-owned business, with great values.” He says, “From legacy HID lamps to smart devices, there is always something new to learn and I appreciate that as well as all the support available from the Product Managers, and their teams.”

Wilfredo is a person who goes above and beyond to help customers. He goes out of his way to find solutions. Wearing many hats, Wilfredo handles quality control, technical support, customer service and, on occasion, has been known to pose as a model for some of our marketing needs!



WE ARE LIGHTING.

A SINGLE AND TOTAL RESOURCE.

Finding the quality, wide selection and company that makes it easy to do business is what being a total resource is all about.

Whatever your space, industry or business, if it needs lights, we have the solution.

MULTI-FAMILY SOLUTIONS



RETAIL



MULTI-FAMILY



OFFICE



COMMERCIAL



RESIDENTIAL



HOSPITALITY

DISTRIBUTION CENTERS

New York (Headquarters)

110 Heartland Blvd., Brentwood, NY 11717

Tel. 631-243-2022, Fax: 631-243-2027

Texas

2000 Valwood Parkway, Farmers Branch, TX 75234

Tel. 972-247-2437, Fax: 972-247-5408

Florida

1694 NW 215th Street, Miami Gardens, FL 33056

Tel. 305-624-2044, Fax: 305-623-0286

California

31288 San Benito Street, Hayward, CA 94544

Tel. 510-487-4822, Fax: 510-487-8955

Washington

4710 116th S.W., Mukilteo, WA 98275

Tel. 425-789-3300, Fax: 425-789-3310

Puerto Rico

Campeche Street. 23 Julio

N. Matos Industrial Park, Carolina, PR 00984

Tel. 787-757-3510, Fax: 787-757-3540

Canada & Mexico

Internationalsales@satco.com/631-243-2022 EXT315

National Toll Free

1-800-437-2826