

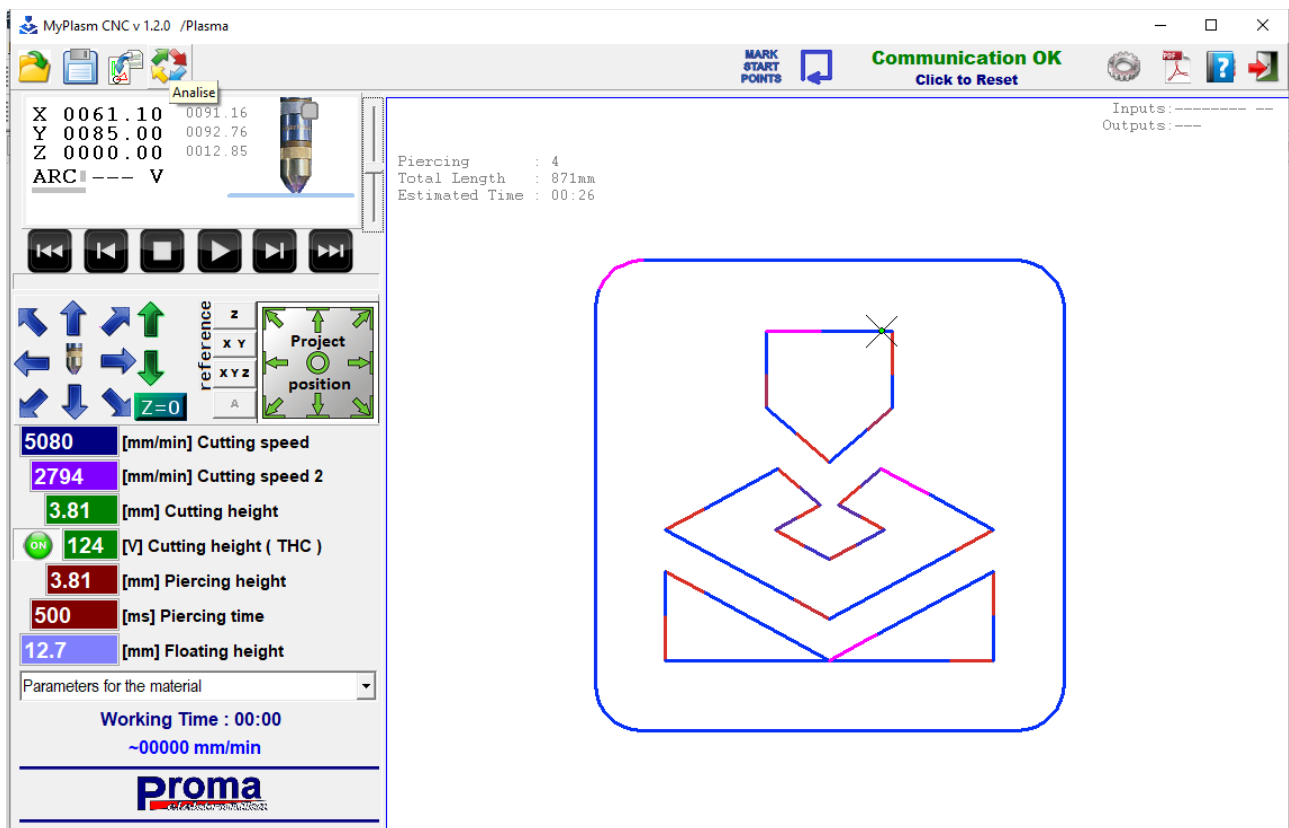

MyPlasm CNC System



Software user manual*

v1.2.soft.

Lukasz Prokop

**This manual does not constitute an assembly, installation and commissioning manual, which can be downloaded from proma-elektronika.com.*

Table of contents

Spis treści

<u>1.0 Introduction.....</u>	<u>3</u>
<u>2.0 Safety.....</u>	<u>3</u>
<u>3.0 Start-up / Main software window.....</u>	<u>4</u>
<u>3.1 Project/Paths preview window.....</u>	<u>6</u>
<u>3.2 Paths analysis.....</u>	<u>7</u>
<u>3.3 Orientation of machine/coordinates.....</u>	<u>8</u>
<u>4.0 Reference / Homing of machine.....</u>	<u>9</u>
<u>4.1 Automatic homing (If the machine is equipped with limit switches).....</u>	<u>9</u>
<u>4.2 Manual Homing (If the machine has no limit switches).....</u>	<u>10</u>
<u>5.0 Setting the cutting parameters.....</u>	<u>11</u>
<u>5.1 Programme algorithm.....</u>	<u>11</u>
<u>6.0 Manual operation mode.....</u>	<u>13</u>
<u>6.1 Manual movement distance.....</u>	<u>14</u>
<u>6.2 Manual cutting.....</u>	<u>14</u>
<u>6.3 Semi-automatic cutting.....</u>	<u>16</u>
<u>6.4 Game Controller.....</u>	<u>17</u>
<u>7.0 Automatic operation mode.....</u>	<u>18</u>
<u>7.1 Project positioning.....</u>	<u>18</u>
<u>7.2 Determination of material height - Z-axis coordinates zeroing.....</u>	<u>20</u>
<u>7.3 Simulated cutting.....</u>	<u>21</u>
<u>7.4 Path selection.....</u>	<u>21</u>
<u>7.5 Cutting.....</u>	<u>22</u>
<u>7.6 Resuming cutting.....</u>	<u>23</u>
<u>8.0 Project / Paths preparation.....</u>	<u>24</u>
<u>8.1 Drawing import window.....</u>	<u>25</u>
<u>8.2 Importing a drawing / configuring the import.....</u>	<u>29</u>
<u>8.3 Select objects / tracks.....</u>	<u>30</u>
<u>9.0 MyMiniCAM - path generation.....</u>	<u>34</u>
<u>9.1 Offset.....</u>	<u>34</u>
<u>9.2 Lead in / Lead out.....</u>	<u>35</u>
<u>9.3 Path direction.....</u>	<u>37</u>
<u>9.4 Path sequence.....</u>	<u>37</u>
<u>9.5 CAM Tips.....</u>	<u>39</u>
<u>10.0 Additional options.....</u>	<u>41</u>
<u>10.1 Reduction in cutting speed for holes.....</u>	<u>41</u>
<u>10.2 Pointing of holes.....</u>	<u>41</u>
<u>10.3 Parking.....</u>	<u>42</u>
<u>10.5 Gas cutting / oxygen mode.....</u>	<u>43</u>
<u>10.6 Milling / drilling.....</u>	<u>43</u>
<u>10.7 Engraving / marking.....</u>	<u>44</u>
<u>10.8 Marking/pointing of punctures.....</u>	<u>46</u>
<u>10.9 Laser crosshair.....</u>	<u>46</u>
<u>11.0 Rotary/rotary axis.....</u>	<u>46</u>
<u>12.0 Keyboard shortcuts.....</u>	<u>47</u>
<u>12.1 Shortcuts : The main program window:.....</u>	<u>47</u>
<u>12.2 Shortcuts : Import window:.....</u>	<u>48</u>
<u>13.0 Troubleshooting.....</u>	<u>49</u>

1.0 Introduction.

The main focus of the MyPlasm CNC system is simplicity of installation, commissioning and operation. It is not a professional system and has severely limited functionality to only the most essential aspects of plasma cutting which it was designed for. The software is based directly on vector drawings and does not support G-Codes, which makes it ideal not only for users who appreciate minimalism, but also for unskilled CNC operators, as only a few clicks are required to operate the machine.

The operation of some functions may differ from those shown in the manual depending on the hardware configuration and optional machine components.

This manual **does not cover the** assembly, installation and configuration of the MyPlasm CNC System. It assumes that the system has been commissioned in accordance with the manual available at proma-elektronika.com direct link (click to download):

[Instruction \[PDF \] : Installation and commissioning](#)

2.0 Safety.



Plasma sources generate dangerous voltages for health and life as well as create risk of damage to electronic equipment. It is forbidden to use the machine without correctly executed earthing / safety switches / if the cables and/or control components are found to be damaged.



**In the event of an emergency or breakdown
Use safety switch immediately.**

3.0 Start-up / Main software window.

The order in which the equipment is switched on is not essential for the operation of the system. It is advisable to switch on the plasma source immediately before starting the cut, which eliminates the risk of it being started accidentally.

After starting the software, the main programme window appears:

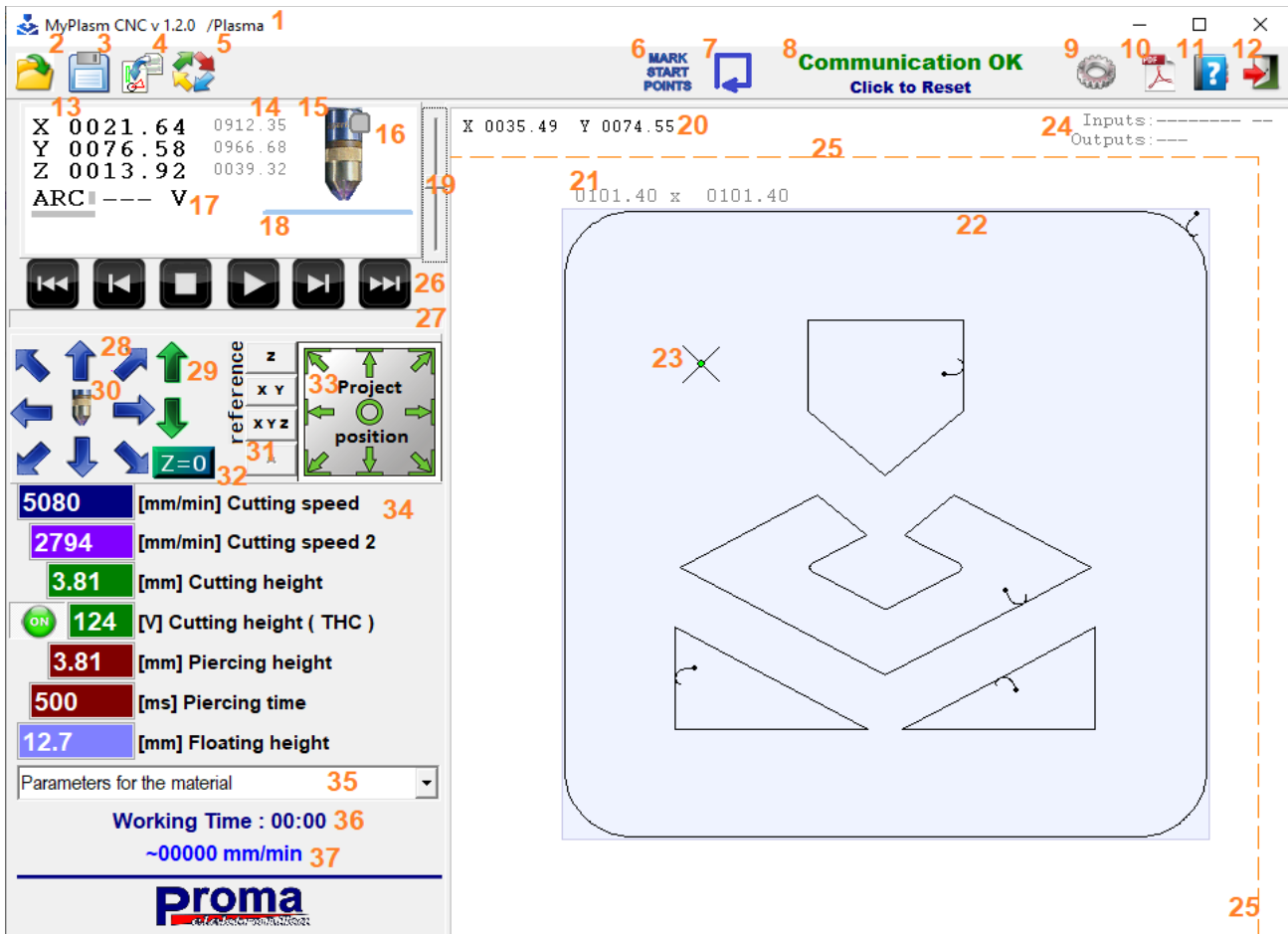

1. Software version / Current profile.
2. Open / Save MyPlasm project.
4. Import vector graphic files (MyMiniCAM module).
- 5 Analysis of paths.
6. Marking of piercing points function.
7. Driving along the outline of the project..
- 8 Communication status with CNC controller.
9. Software / system configuration window.
10. This manual.
- 11,12 Version info / Program exit.

13. Material coordinates (position relative to [0,0] material).
14. Machine coordinates (position relative to machine reference points).
15. Graphical representation of vertical Z-axis position.
16. Floating head sensor indicator.
17. Arc voltage measured by plasma interface
18. Graphical display of material surface position (height)
19. Zoom in / zoom out view (= mouse wheel).
20. Material coordinates indicated by mouse pointer.
21. X / Y dimension of tracks.
22. Loaded project.
23. Current torch position.
24. Status of controller inputs / outputs.
25. Operation range of the machine (SoftLimit).
26. Automatic operation buttons / initial path selection.
27. Progress / paths scrolling indicator.
28. X/Y manual movement keys (= keyboard arrow keys).
29. Z manual movement keys (= PgUp / PgDown keys).
30. Plasma turn on button (= spacebar key).
31. Homing / reference buttons.
32. Reset button for material coordinate Z (= material height determination).
33. project/paths positioning on material.
- 34,35 Cutting parameters / material database of cutting parameters.
- 36,37. Automatic operating time / Current feed rate.

The current connection status with the controller is displayed in the top right corner of the screen. Communication can be restarted (disconnected / connected) by clicking the left mouse button:



Communication OK - Communication correct (WORKING MODE).

No USB device : Controller not connected or Windows driver problem.

Communication error : Device installed and connected correctly but communication error occurred. Controller power supply problems or incompatible firmware version.

For disconnected comm. the software is running in SIMULATION mode)

3.1 Project/Paths preview window

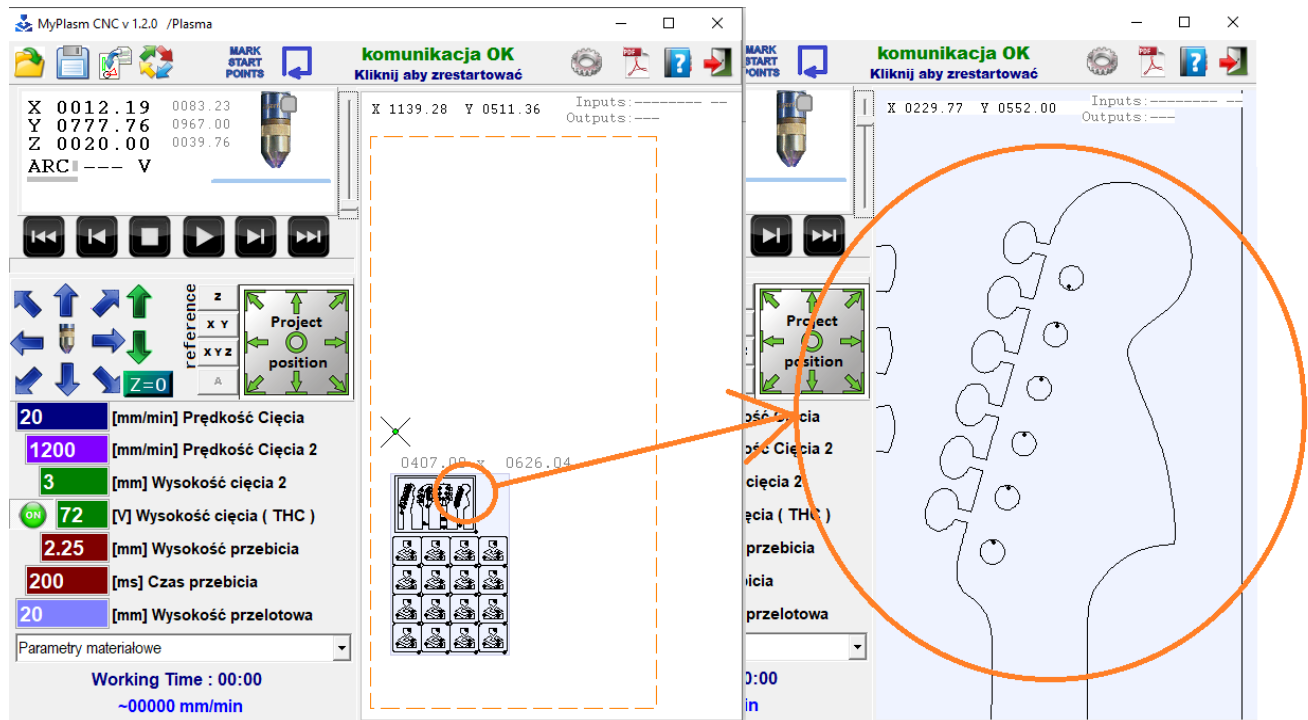

Using the mouse wheel, you can zoom in/out the elements. The element currently pointed to with the mouse pointer is brought closer. By holding down the mouse wheel it is possible to move the view.

Double-clicking with the left mouse button resets the view (adjusts the magnification to the size of the project).

The right mouse button calls up a function window, the functions of which will be described later.

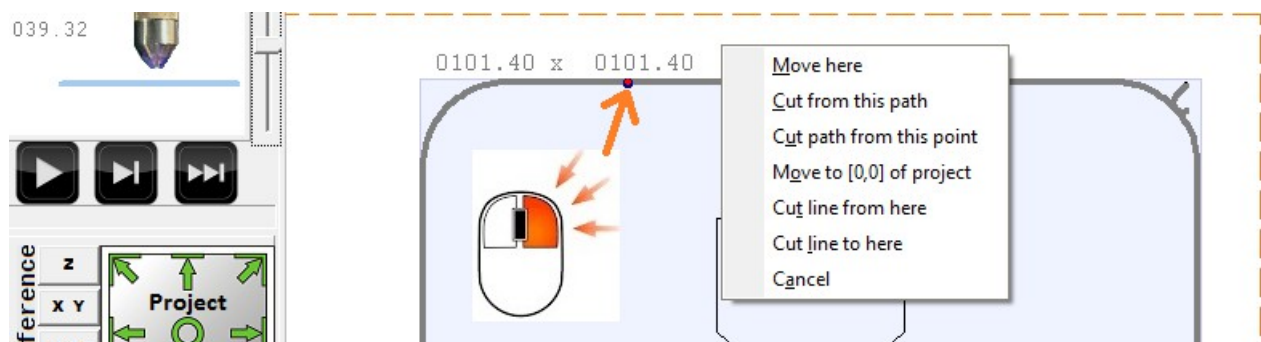

3.2 Paths analysis

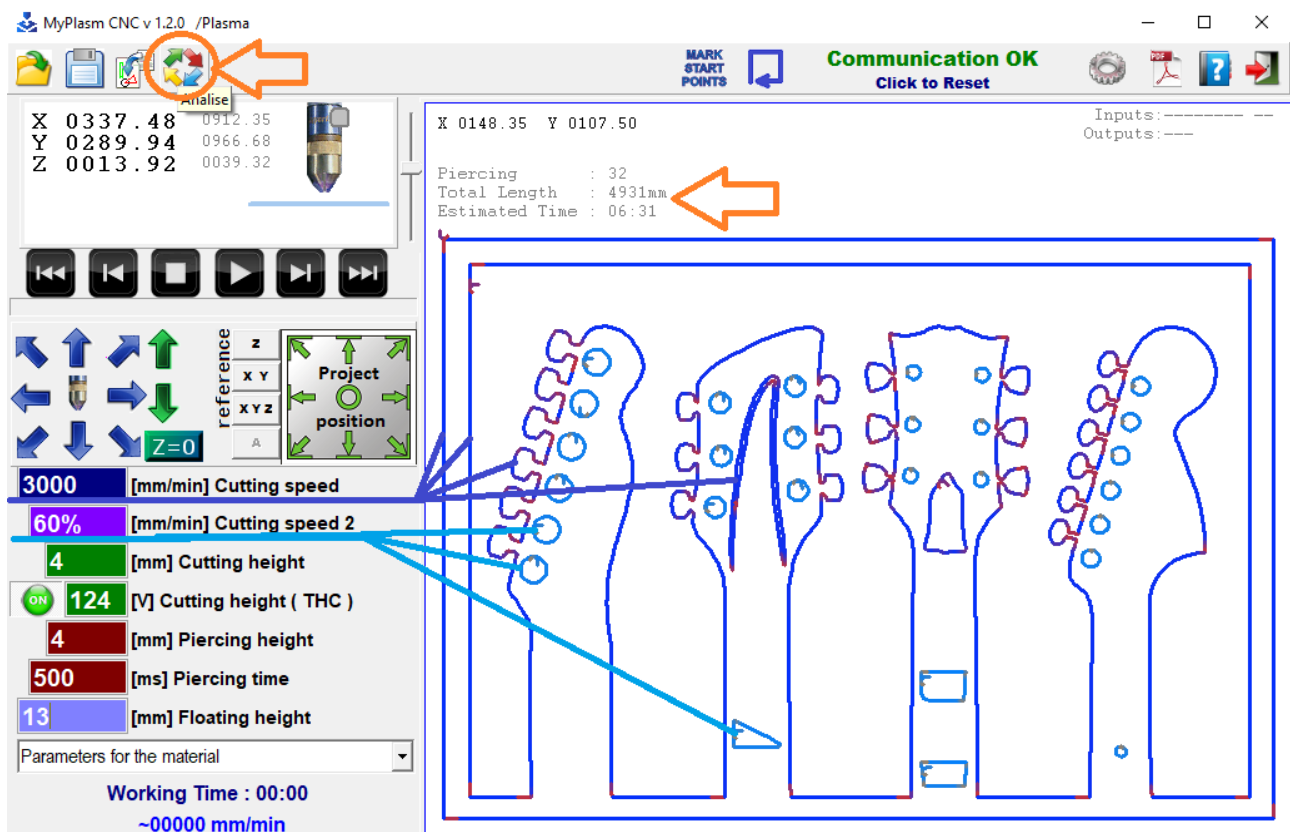

The button displays the analysed tracks in terms of their ability to maintain the set cutting speed. The **dark blue** colour shows the tracks that will be cut at the "main" **Cutting speed**. **Light blue** shows the tracks cut at **cutting speed 2** and with the THC controller switched off. The proportional change to **red** indicates that the speed will be reduced at these locations (limited machine dynamics parameters). The THC function is also switched off at these points (This prevents the torch from diving when the feed is slowed down). It also shows some information such as the number of piercings, the length of cut and the estimated cutting time.

Green crosses show where the holes are pointing (if activated).

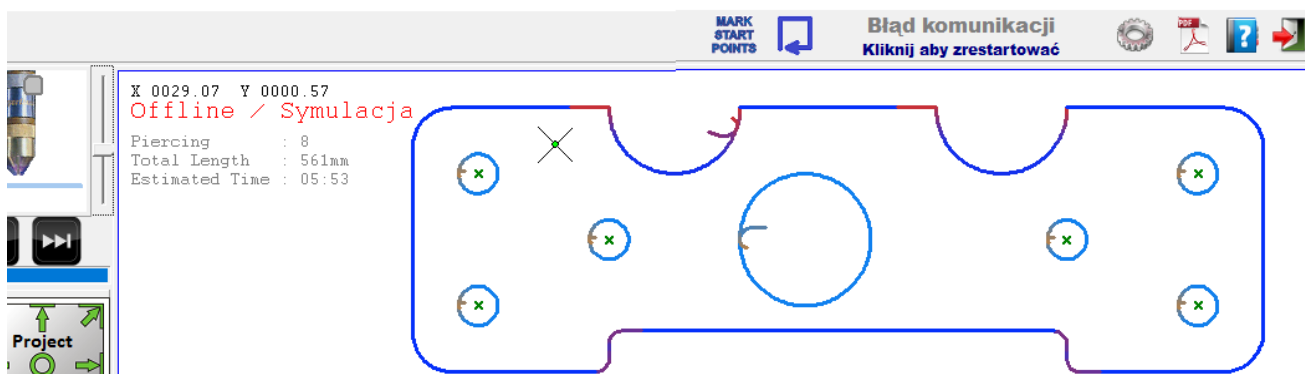

3.3 Orientation of machine/coordinates

The system is based on 2D drawings and therefore the orientation on the flat material is fixed according to the 2D coordinate system. The vertical torch axis is the Z axis.

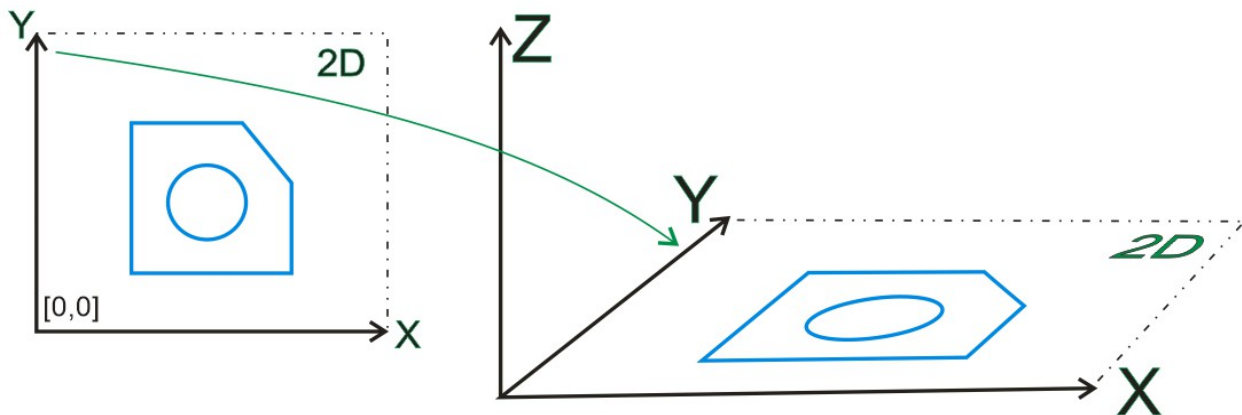

The control station (PC) should be positioned in accordance with the configuration of the machine, i.e. so that the right arrow moves the X axis to the right etc. Otherwise, operation of the machine will be significantly hampered.

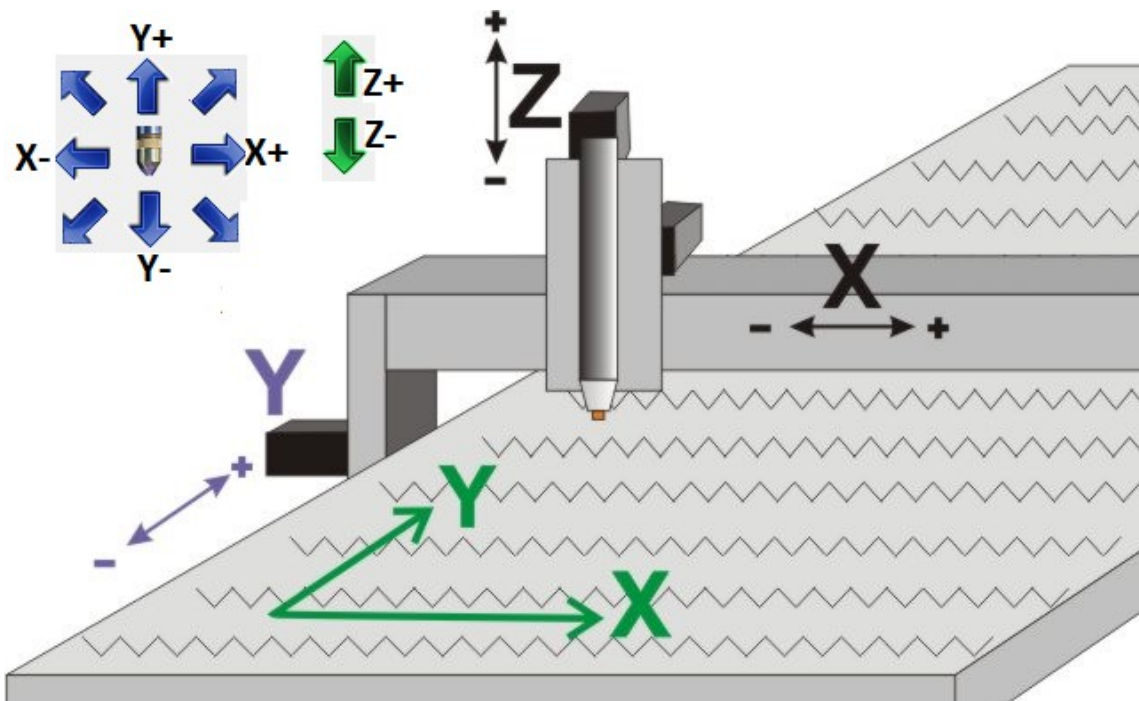

4.0 Reference / Homing of machine

By Homing (setting axis reference points), the system can determine the position of the tool. While the power is off, the drives become unlocked and can therefore be moved:

It is recommended to carry out the basing always after the power is switched on

This lets the user avoid problems associated with out-of-range operation; in addition, if basing is automatic (to limit sensors), it greatly facilitates precise continuation of operation after a fault has occurred (e.g. power failure, lost steps).

The system allows operation immediately after power-up without basing the machine, but the above-mentioned consequences must be taken into account.

4.1 Automatic homing (If the machine is equipped with limit switches)

It is simply a matter of clicking on the reference travel button and the axes will automatically arrive at the limit sensors, assigning the corresponding machine values to the axes (ZERO or maximum / SoftLimit depending on the axis datum direction). The Z-axis is always homing to the max.upper position and the X,Y-axis is homing by default to the lower left corner of the machine $X Y = [0,0]^*$.

If the gantry is driven on both sides, any skew will automatically be compensated for.

Example of a homing sensor arrangement on a machine with bilateral Y-axis drive ($Y + Y'$).

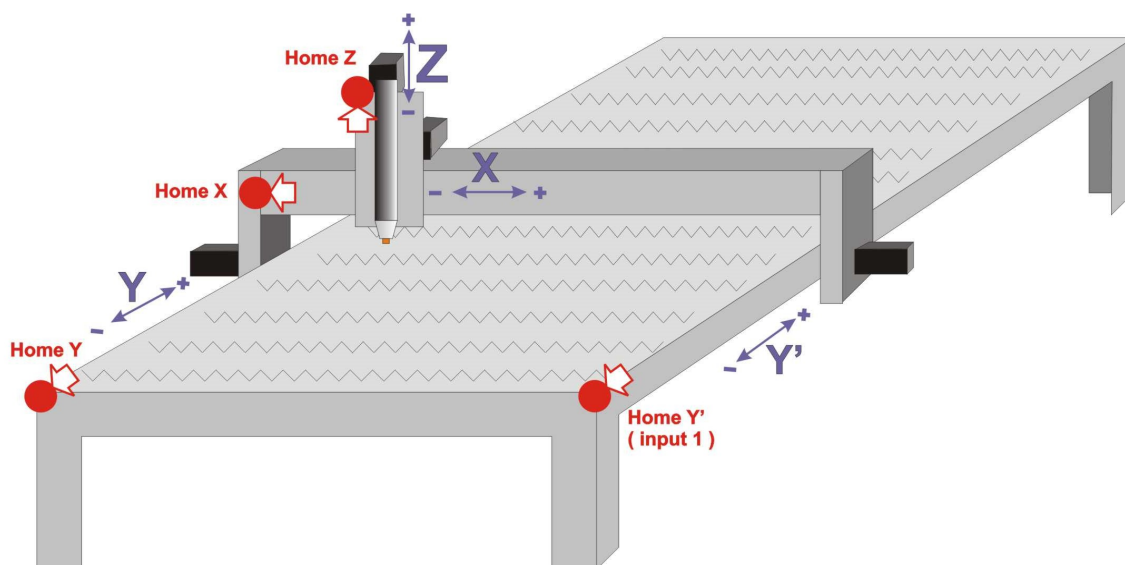

*possible homing on the other side of the X and/or Y axis (MAX).

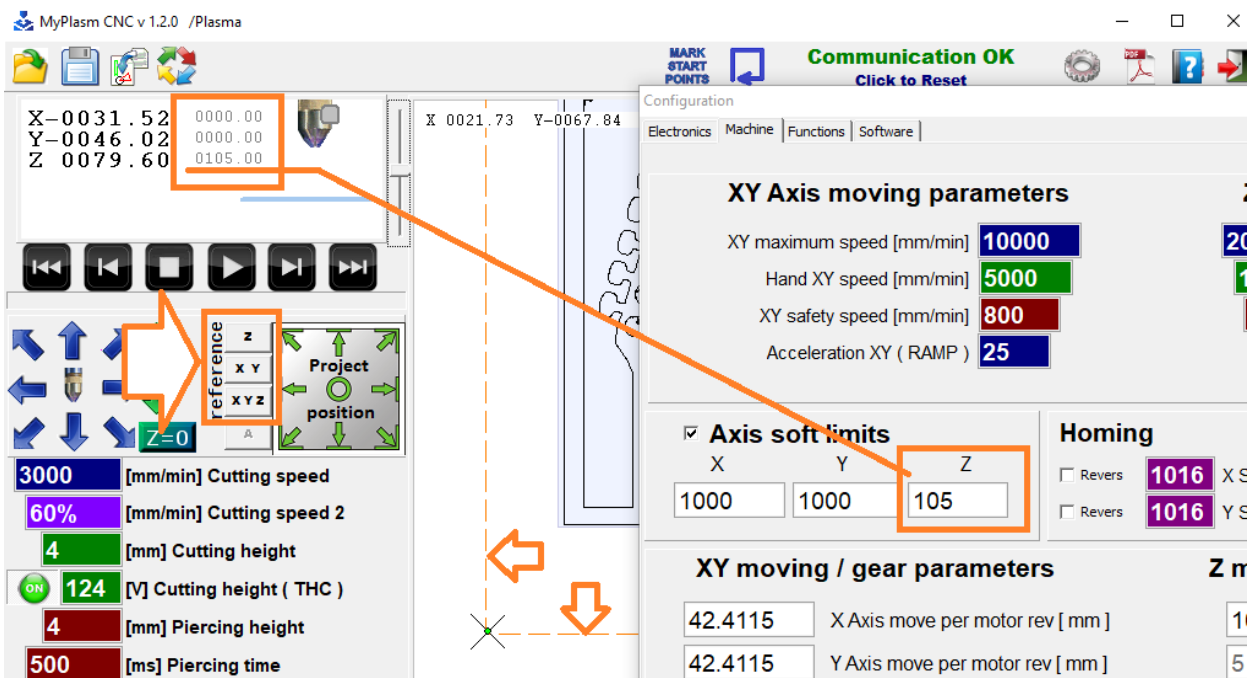

4.2 Manual Homing (If the machine has no limit switches)

To homing the machine manually, move the Z axis as far up as possible, the X axis as far to the left as possible and the Y axis as far down as possible (towards each other). If movement is restricted by software limits, use the right mouse button to ignore the limits. Once the machine is positioned at the reference points, click the reference button [X Y Z] which will assign a LimitZ value to the machine coordinate Z and [0, 0] for X, Y, identical to automatic basing.

5.0 Setting the cutting parameters

5.1 Programme algorithm

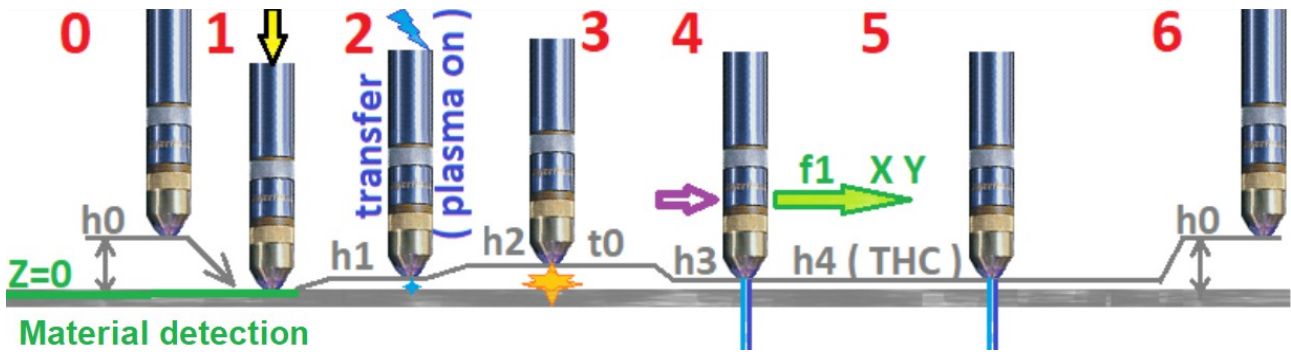

- 0** - starting position - torch at h_0 (**floating height**), travelling at maximum speed over the pierce point of the selected path
- 1** - Material height detection
- 2** - Position torch at transfer height h_1 or **piercing height** h_2 if lower than h_1 , start plasma source (plasma on)
- 3** - after detection of the main arc, setting the torch at h_2 (**piercing height**) for time t_0 (**piercing time**)
- 4** - position the torch at height h_3 (**Cutting height 2**) and start the X Y feed at speed f_1 (**Cutting speed**) or (**Cutting speed 2**) for small objects.
- 5** - When the preset speed f_1 (**Cutting Speed**) is reached, control of height maintenance (h_4) is taken over by the **THC** - Torch High Controller (if active) based on the ARC plasma arc voltage reading and the specified arc voltage [V] (**THC cutting height**)
- 6** - end of path-switching off plasma source and raising torch to h_0 (Through height)

6000	[mm/min] Cutting speed	f1
1270	[mm/min] Cutting speed 2	
2.54	[mm] Cutting height	h3
ON 123	[V] Cutting height (THC)	h4
5.08	[mm] Piercing height	h2
500	[ms] Piercing time	t0
12.7	[mm] Floating height	h0

Parametry materiałowe MyPlasm CNC v1.07a

- Cutting speed** - preset cutting speed
- Cutting Speed 2** - preset cutting speed for small objects/holes.
- Cutting height** - set cutting height for the switched-off THC function
- THC Cutting Height** - Determination of arc voltage for THC height adjuster - Higher voltage = Higher cutting height
- Piercing height** - height at which it is pierced material at the beginning of the path active for time >250ms - if the time is shorter the piercing at cut height 2.
- Piercing time** - The time to wait after firing the torch until the material is melted.
- Pass-through height** - the height at which the torch quickly moves between paths.

Determining the correct parameters has a key impact on the quality of the cut. Unfortunately, the parameters are individual for different plasma sources, so it is not possible to give a ready-made solution. The parameters should be selected according to the recommendations of the plasma cutter manufacturer.

For a specific material, the key factors are: gas pressure, current, cutting speed and cutting height. If the THC controller is switched on, the cutting height is determined by the arc voltage and specified in V. Otherwise cutting height 2 is maintained - e.g. in the case of hole cutting where the THC function is switched off automatically.

Below is an example from the **Hypertherm PowerMax 65** manual:

Powermax65/85 Operator Manual (806650 revision 4) 94 / 154 146%

**65A Unshielded
Mild Steel**

Air flow rate - slpm/scfh

Hot	160 / 340
Cold	220 / 470

Metric

Material Thickness	Torch-to-Work Distance	Initial Pierce Height		Pierce Delay Time	Best Quality Settings		Production Settings	
					Cut Speed	Voltage	Cut Speed	Voltage
mm	mm	mm	%	seconds	(mm/min)	Volts	(mm/min)	Volts
3				0.2	5200	118	6330	118
4					4950	118	5950	118

5.2 Cutting parameters database :

If the quality of the cut is satisfactory, it is a good idea to save the Parameter Group to a database for future use - to do this, enter any name for the Parameter Group and click **CTRL + S (Save)**.

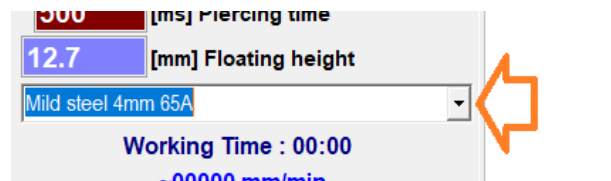

To delete the current item from the database, click **CTRL + D (Delete)**.

Reading of previously stored parameters is automatic when selected from the list.

6.0 Manual operation mode.

Manual movements of the machine can be performed with the arrows in the main program window or with the Keyboard - Left-Right arrows handle the X-axis, Up-Down the Y-axis and PageUp / PageDown buttons are assigned to the Z-axis.

The GameKontroller can also be used (described later in this manual).

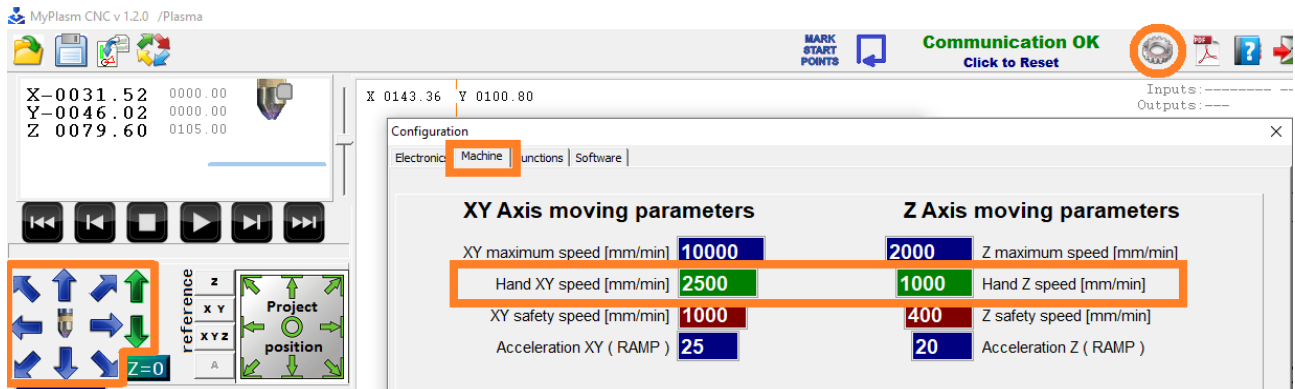

By default, movements are made at the speed defined in the settings / configuration → "Machine" tab .

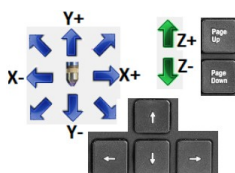

When pressed, the **SHIFT** key forces movements at maximum speed and the **CTRL** key forces precise movements (10% of the preset speed).

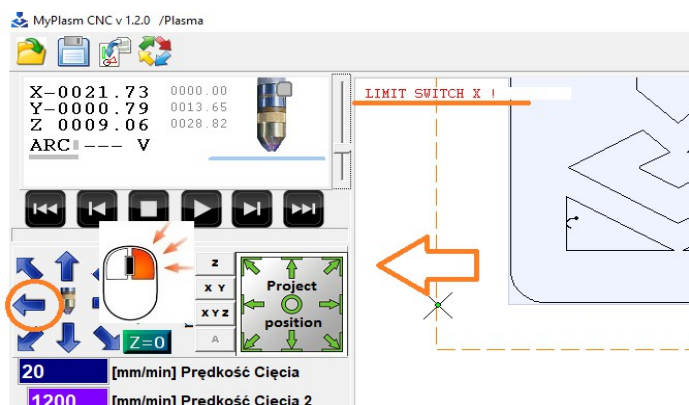

The range of movements is limited by software stops and limits. If these need to be ignored, use the right mouse button.

6.1 Manual movement distance

It is also possible to determine the distance of manual movements of the XY axis.

To do this, right-click in the coordinates box, which will display additional options :

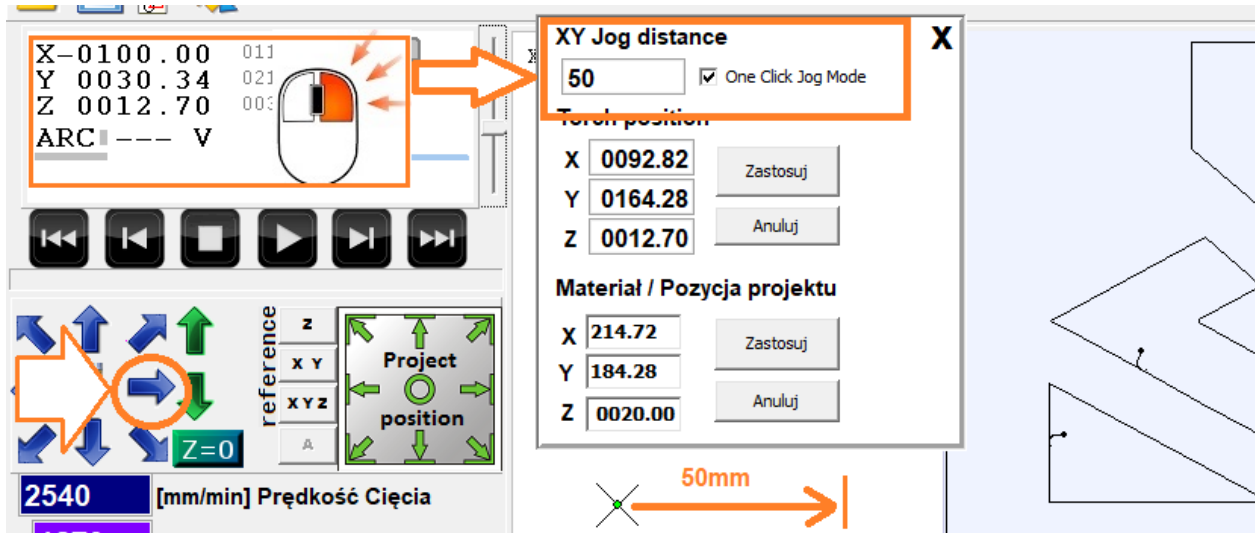

XY Jog distance : The distance of movement of the axis (**0 = no limit**)

One click jog mode : Enables "one click" mode (the axis moves by a the preset distance without having to hold the arrow)

6.2 Manual cutting

The above steps can be used for manual straight cuts without any design drafting. A useful function if you want to separate material or test/adjust cutting parameters. Parameters must be specified.

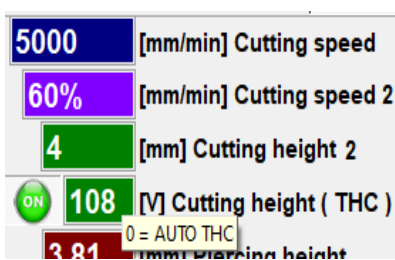

Cutting speed - Cutting feed speed

Cutting speed 2 - not for manual cutting

Cutting height 2 - not applicable to manual cutting

Cutting height (THC) - Preset arc voltage (to maintain constant height above material during cutting) Higher value = higher height above material. If the corresponding THC voltage value is not known, **0 [V]** can be entered, which forces the THC to Automatic mode (not recommended if you know the correct value). Relevant source parameters such as pressure, current must also be set.

MAKE SURE THAT THE CLAMP IS IN GOOD CONTACT WITH THE MATERIAL.

Be ready for an emergency stop of the machine at any time



Position the torch at the material breakthrough height (or at the cutting height for Automatic THC mode), switch on the plasma with the **SPACE KEY** and start the feed with one of the arrows (screen or keyboard) of the X/Y manual operation (Up / Down / Left / Right).

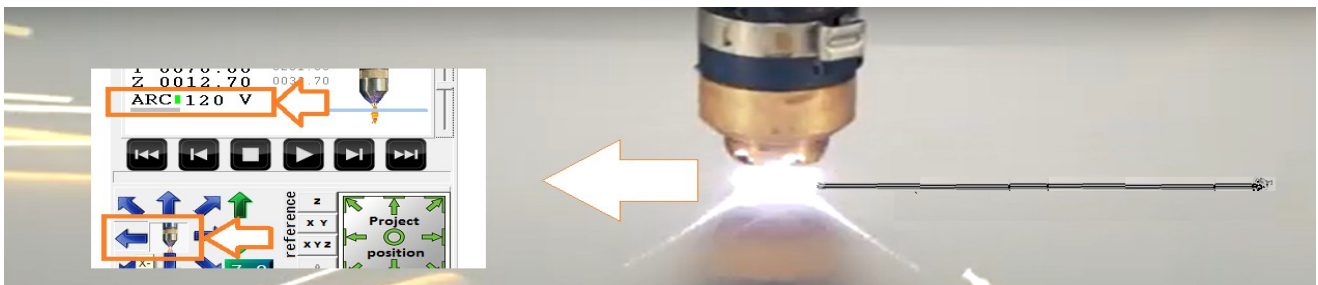

It is worth observing the displayed arc voltage value (ARC), which can be the basis for entering this value for the material in question, as AUTO mode can be unreliable due to the possibility of an incorrect reading.

The plasma arc will automatically be switched off when the feed is stopped.

6.3 Semi-automatic cutting.

In order to make a semi-automatic cut between two points, it is necessary to ensure if the preliminary height setting works correctly.

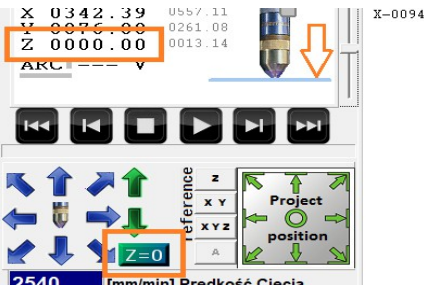

To do this, reset the initial height position of the material by touching it with the torch and click [**Z = 0**] with the **LEFT MOUSE BUTTON**.

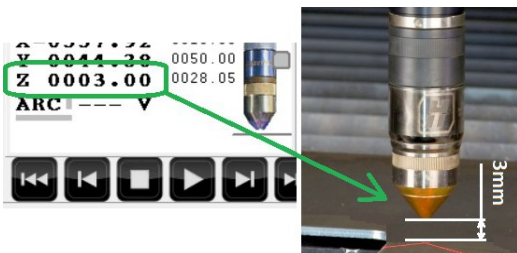

Then, using the **RIGHT MOUSE BUTTON**, clicking [**Z = 0**] (**F7 key**) (activates the material height detection function - if the machine has one) the torch should position itself at the puncture height.

As with manual cutting, the cutting parameters must be set for the material.

To define the points between which you want to make a cut, click on them on the screen with the **right mouse button** (physically pointing with the torch or laser pointer on the machine) and select from the options:

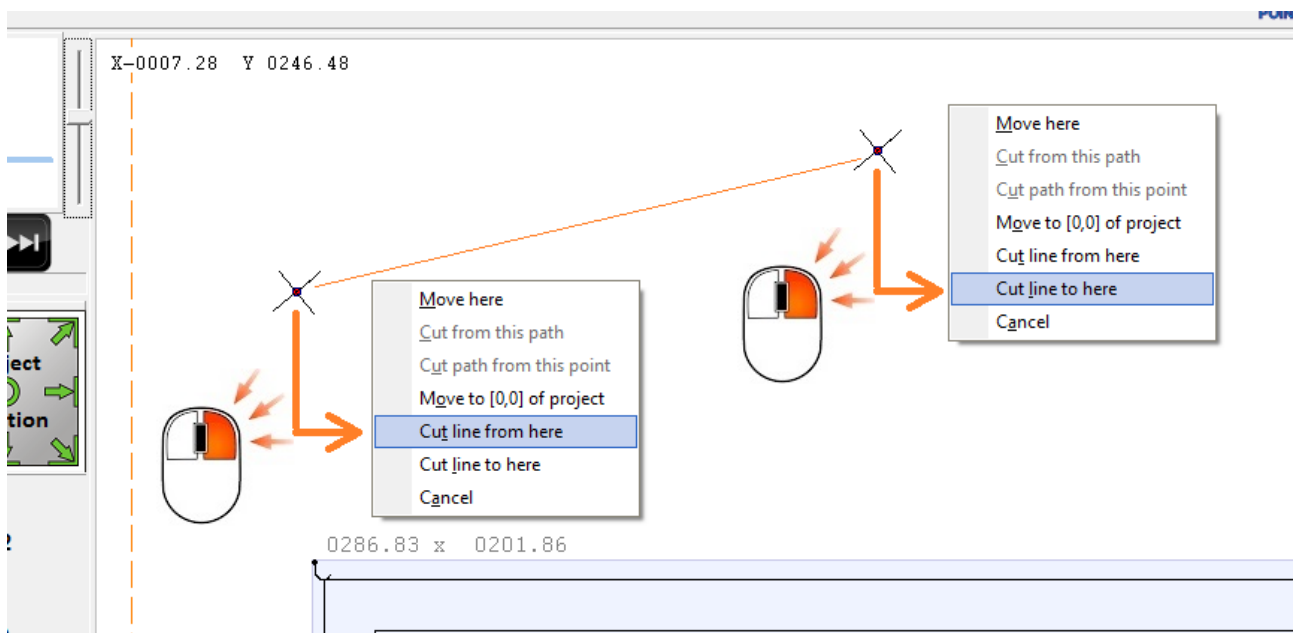

The cut between the points will be made automatically.

During cutting, it is possible to change the speed with the **+/- keys** as well as the cutting height with the **PgUp / PgDown** keys.

6.4 Game Controller.

Any Windows-compatible controller (Wireless) can be used for convenient positioning. Once connected and detected by Windows, the controller is ready for use. Please pay attention to the operating mode (controller operating manual) because there are often multiple modes for different platforms.

If the controller has been correctly detected / installed , in the configuration tab "electronics" you can check the correct reading of the buttons (they will be highlighted in green when you click them) :



Left stick is used to control the XY axes,

Right stick - Raise/lower Z axis.

SELECT - Zeroing of X,Y material coordinates (positioning)

START - holding 2s starts automatic operation, short press - **STOP**

Rear left buttons - upper **L1** - activates the plasma. Lower **L2** : **Z = 0**

Rear right buttons - upper **R1** - max speed, lower **R2** - 10% hand speed.

7.0 Automatic operation mode.

Automatic operation consists of guiding the tool (torch) along a defined paths, the method of preparing the paths / project is described later in the manual.

First of all, the cutting parameters should be established (see point 5) - in order to confirm the correctness of the parameters, it is advisable to carry out manual cutting tests on the material in question (see points 6.2 , 6.3).

It is advisable to set the reference point of the machine (see point 4).

7.1 Project positioning.

Positioning the paths can be done in several ways. The quickest and easiest way is to physically point with the torch (or laser pointer*) the position in which you want to place the design on the material e.g. any corner/edge of the design. And then click the appropriate positioning arrow of the design. Below is an example of positioning relative to the bottom left corner of the project / material .

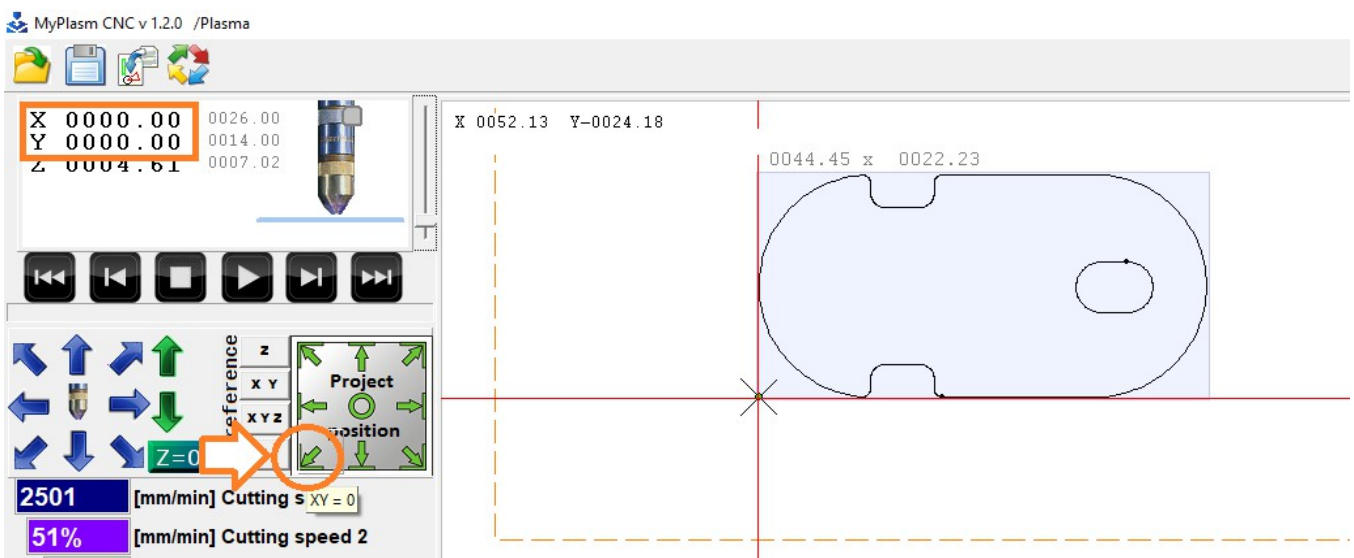
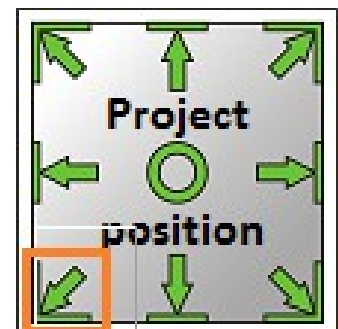
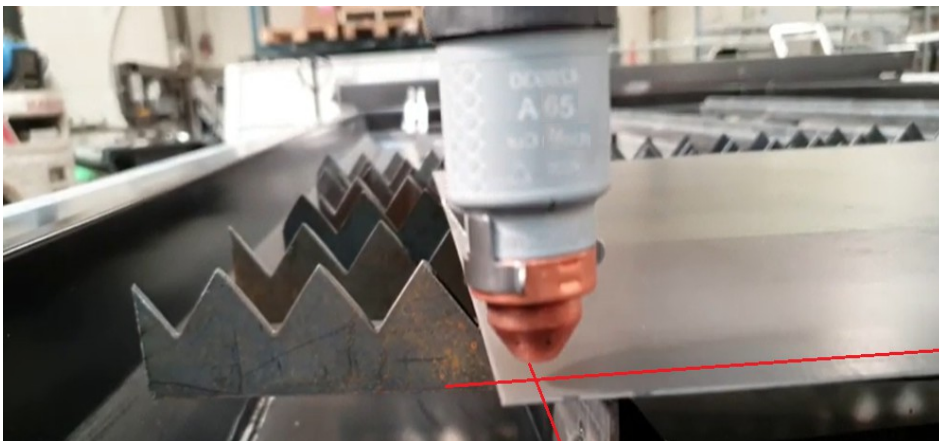

By clicking with the right mouse button on the coordinate box, the position of the design in relation to the reference points can be determined precisely:

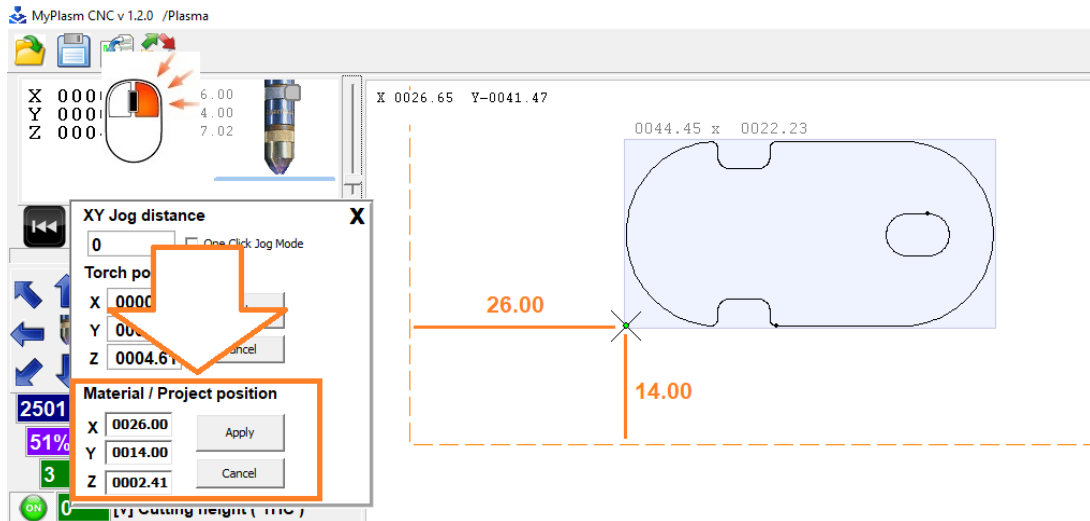

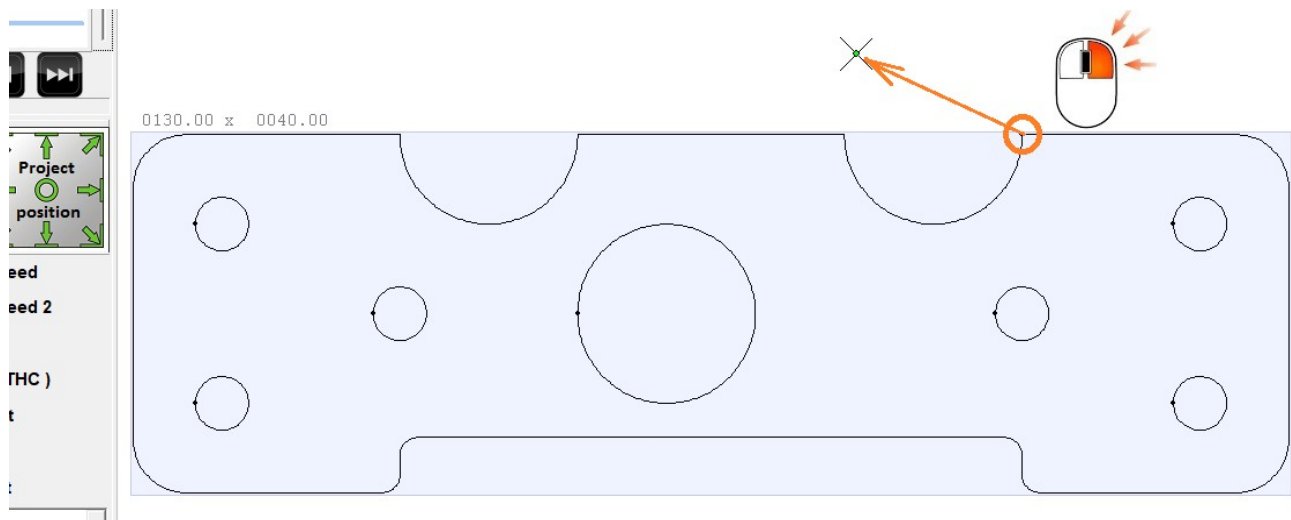

The third way allows the design to be placed completely freely anywhere by moving it with the right mouse button. For example, by sliding the design point of interest "under the current position indicated by the torch".

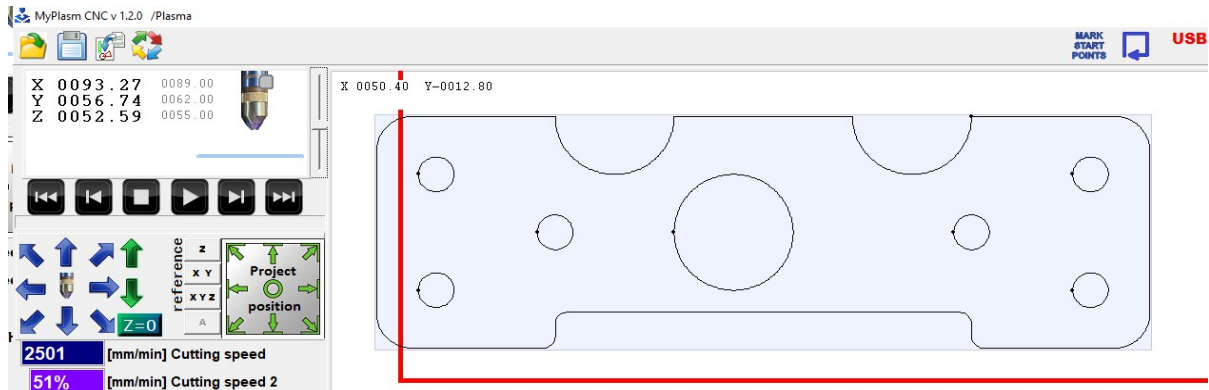

CTRL + Z undoes the operation in the event of an accidental shift.

If the design is not positioned correctly (outside the working range of the Soft Limits machine), the working area is marked with a red line and automatic operation is not possible.



The  button starts the movement of the torch in the X Y axis (at manual speed) along the rectangular outline of the design, which makes it possible to determine whether the design is correctly positioned on the material.

7.2 Determination of material height - Z-axis coordinates zeroing.

Positioning of the material in the Z-axis is carried out by zeroing the Z-coordinate when the torch touches the material. Before starting the cut, it is advisable to zero the height even if the machine has an OHMIC / Floating head automatic detection system.

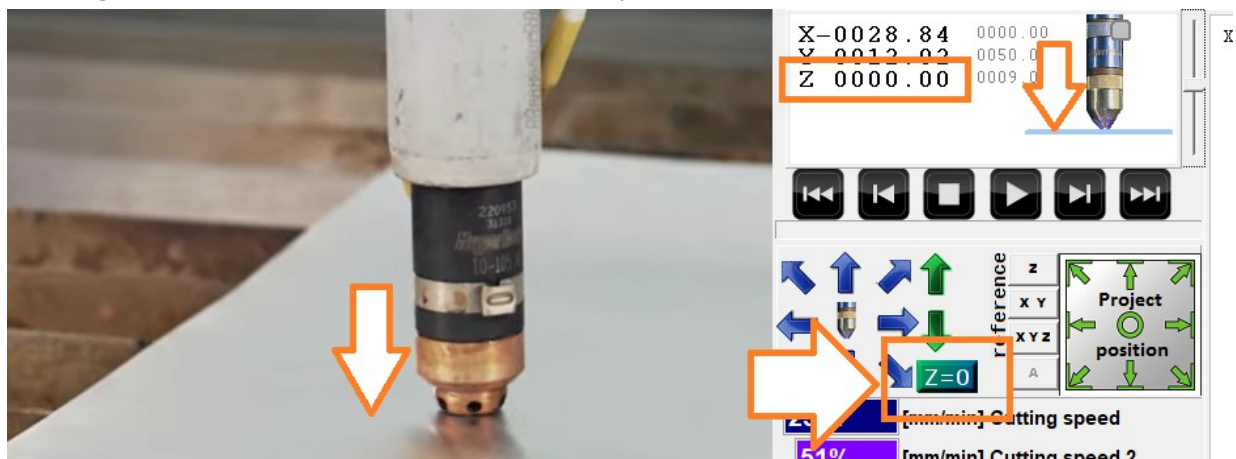

7.3 Simulated cutting.

Before starting the actual cut, it is advisable to carry out a simulated cut (without switching on the plasma source). Apart from the lack of height adjustment of the THC (simulation is carried out at **cutting height 2**) this process is identical to the actual cutting.

To start the simulated cut, hold down the **SHIFT** key before clicking the start button (alternatively **SHIFT + F5**).



7.4 Path selection.



The navigation keys allow you to select the track you want to start from.

1 : First path (beginning)

2 : Previous path (backward)

5 : The next path (forward)

6 : Last path

7 : progress indicator / fast forward of tracks (with mouse pointer)

The currently selected path is highlighted in **dark blue**

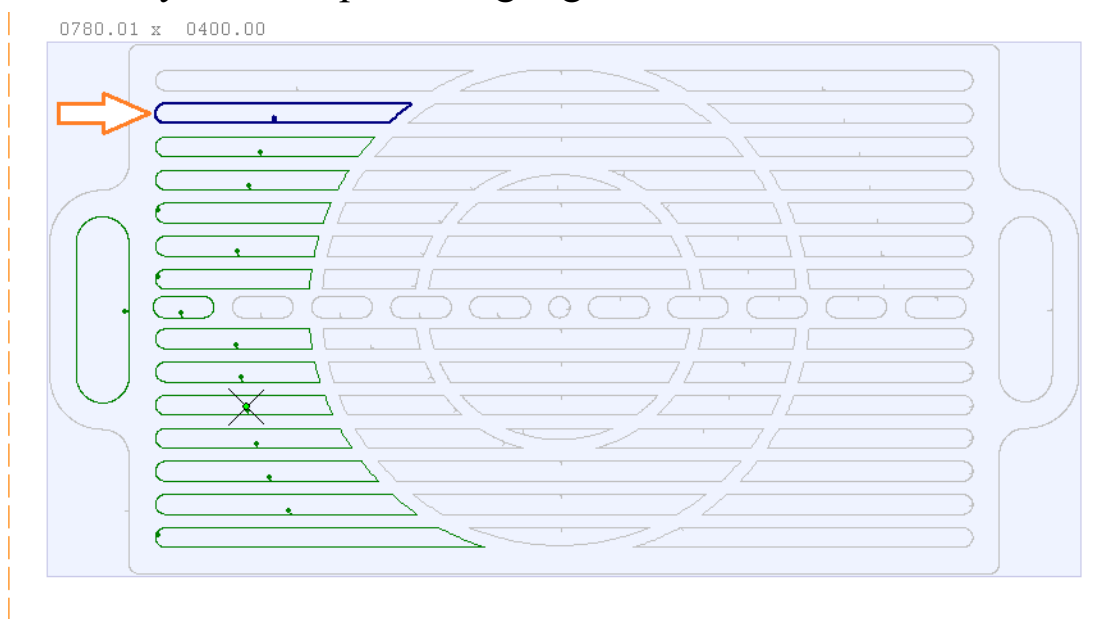

7.5 Cutting.

If the previous points show no abnormalities the proper cut can be started. Before starting the cut make sure that :

- 1 : the machine is properly set up with reference coordinated (point 4.0)
- 2 : Parameters are appropriate for the material (point 5.0)
- 3 : Paths is correctly positioned in XY,Z axes (point 7.1 , 7.2)
- 4 : Paths size is correct
- 5 : Material detection function works correctly (point 6.3)
- 6 : Initial path selected (point 7.4)
- 7 : Source parameters are adequate (current, pressure, operating elements)

MAKE SURE THAT THE CLAMP IS IN GOOD CONTACT WITH THE MATERIAL.

Be ready for an emergency stop of the machine at any time

Starting the cut is a matter of clicking the **START** button (**F5**)

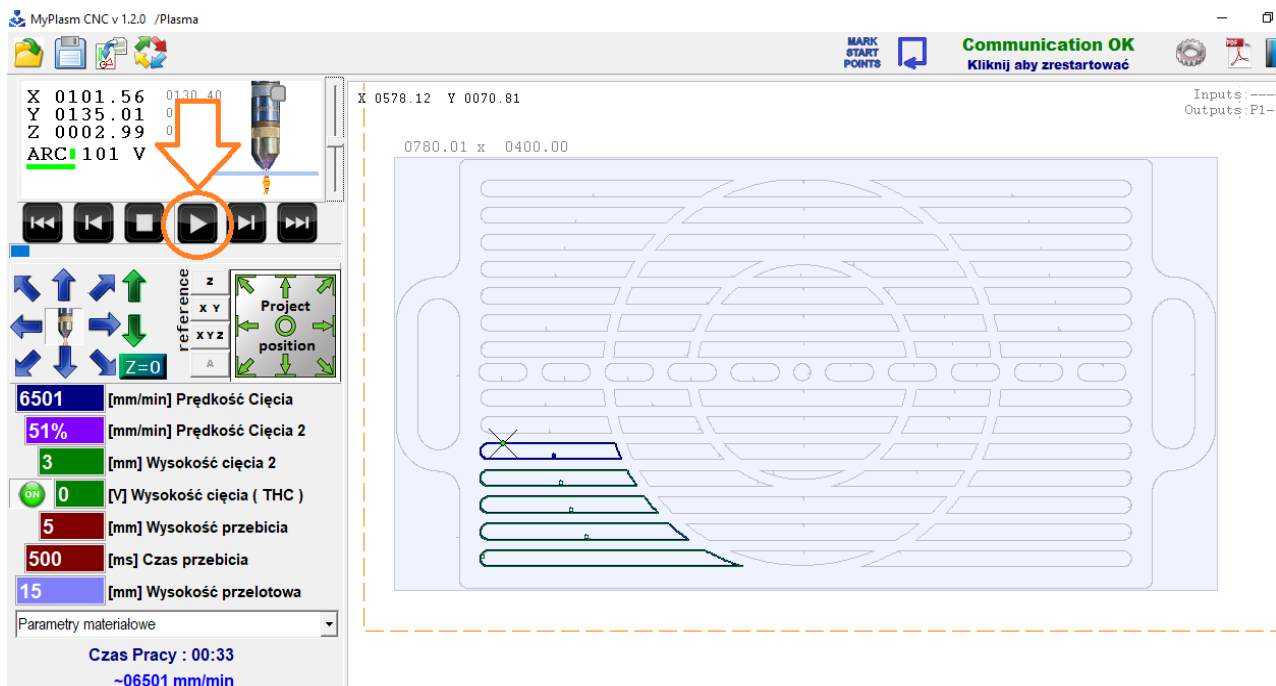

During cutting, it is possible to correct the speed with the +/- keys and the cutting height with the **PgUp** / **PgDown** keys.

7.6 Resuming cutting.

Depending on the circumstances of the interruption, the work can be resumed in several ways. In the case of a simple stop with the **STOP [ESC] BETWEEN TRACKS** key (**recommended**), simply click **START [F5]** and the system will automatically resume from next path.

When you have stopped working **UNDER CUTTING a track**, the **START [F5]** button will start cutting it from the beginning. In order to start from the stopping point, click **START with the Right Mouse Button** or the **[F6]** key.

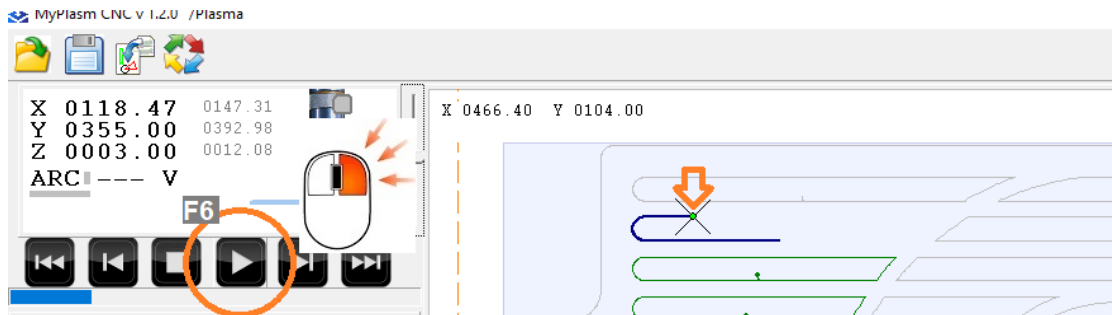

It is possible to start cutting from **ANY POINT** by simply pointing to it with the **right mouse button** and selecting " Start track from this point " from the menu.

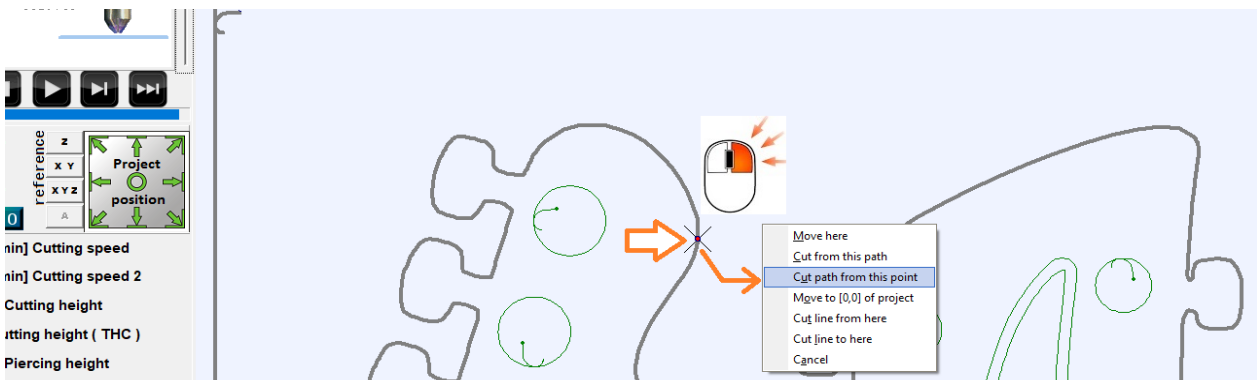

If a track is not cut enough, it is possible to start cutting it in the opposite direction which will allow it to be cut "from the end". To do this, select the one of tracks and click **START** with the **CTRL** key held down.

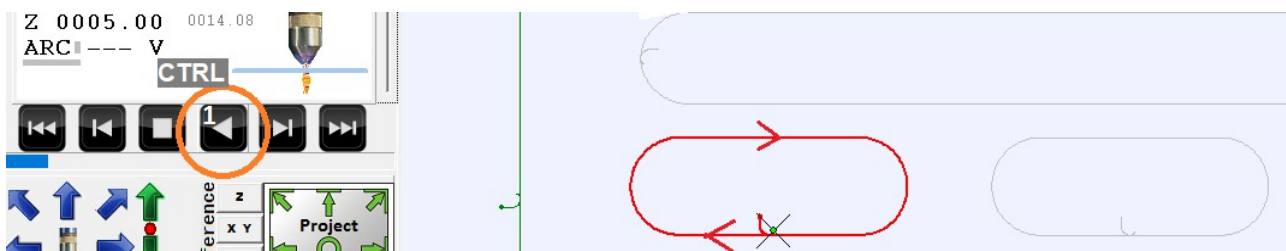

8.0 Project / Paths preparation.

General note : In order for plasma cutting to run correctly and smoothly, the design must be prepared carefully (drawing of the workpiece in **DXF** or **HPGL (PLT)** format). Otherwise, some of the programme's functions may not work correctly.

The most common errors in designs are:

1. unconnected detail lines.

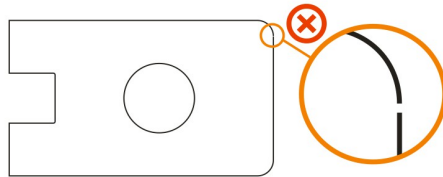

The outline of the detail should be one closed continuous line.

The welding/joining/closing functions of objects when drawing in CAD allow such errors to be corrected.

Tip : A good way to do this is to use the sum/difference/object operations and the ready-made rounding/cutting corner functions. The object created in this way is always a correct - consistent element.

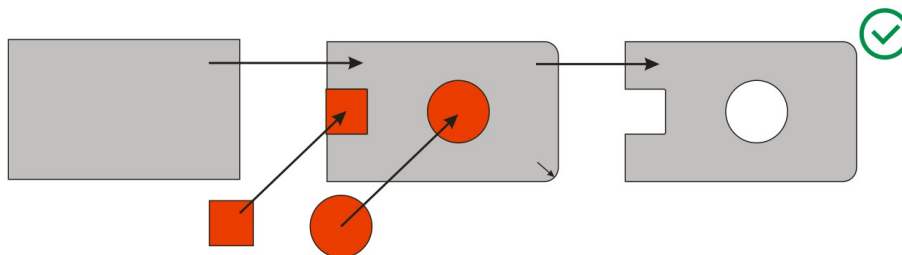

2. "Frayed" lines - small kinks cause the movement to slow down (to change the direction of the axis) which negatively affects the quality of the cut / overheating of the material as well as the culture of the machine.



3. superimposed lines/objects on top of each other.

4. all objects (especially TEXT), should be converted to curves before exporting to DXF file.

5. Units used in CAD (also during DXF export) [mm / inch] should be compatible with the MyPlasm CNC settings in use.

8.1 Drawing import window.

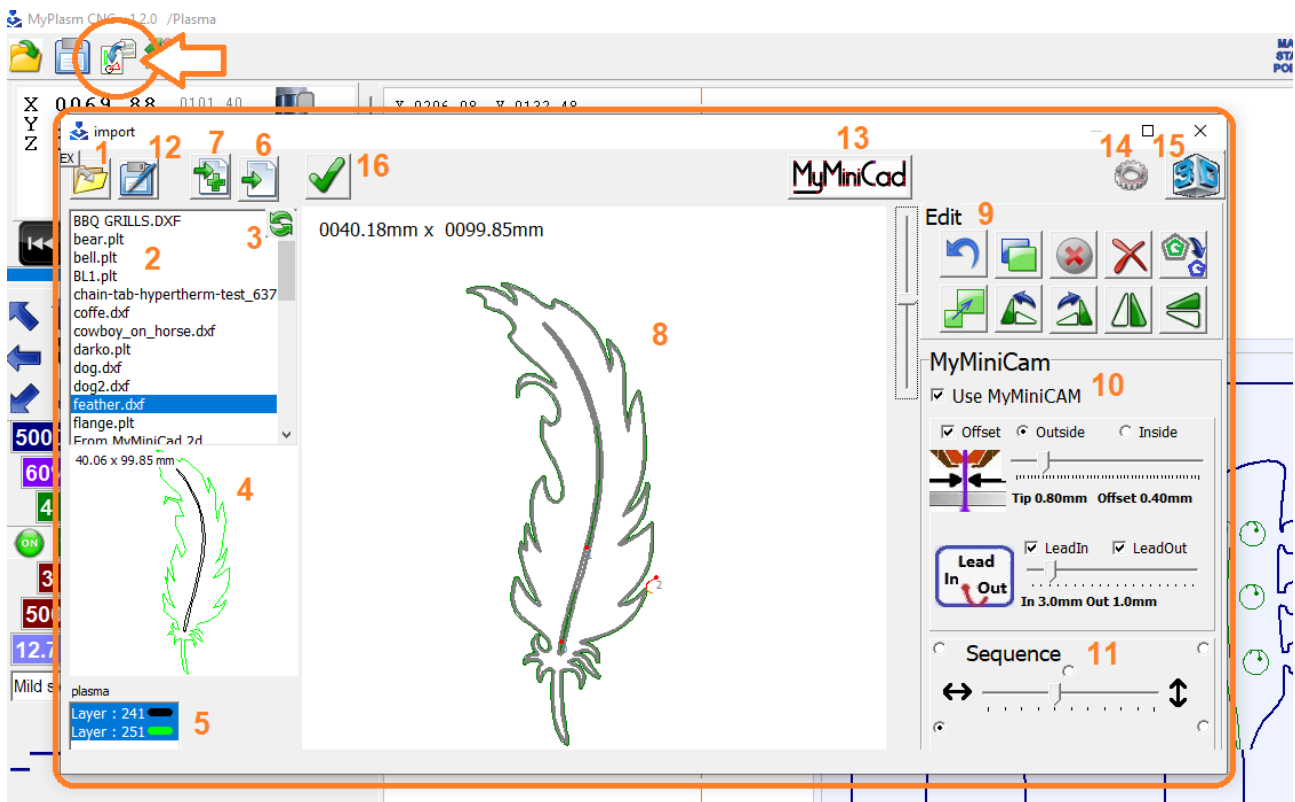

- 1 : Indicate the folder from which the files will be loaded. **EX:** examples.
- 2 : list of files, 3 : refresh the list.
- 4 : Quick preview of the selected file,
- 5 : selection of the active colour / layer.
- 6 : Loading the selected file
- 7 : Adding another file
- 8 : Main preview window (mouse wheel to zoom in/out, pressed mouse wheel to move the view, double-click to reset the view).
- 9 : Editing tools
- 10 : **MyMiniCAM** paths generation module
- 11 : Options for determining the cutting order
- 12 : Save details or paths for later use
- 13 : **MyMiniCAD** module for drawing simple details
- 14 : Configuration of file import options
- 15 : 3D preview of loaded details.
- 16 : Approval of paths / transfer to control programme window.

The **MyMiniCAD** module has some basic graphic tools and allows you to draw simple details directly in the system which makes your work much easier and faster. If the available tools are insufficient, use an external professional **CAD** programme (**AutoCad etc...**).

Running the MyMiniCAD module directly from the system allows the drawing to be transferred directly to the import window by clicking on the Export button :

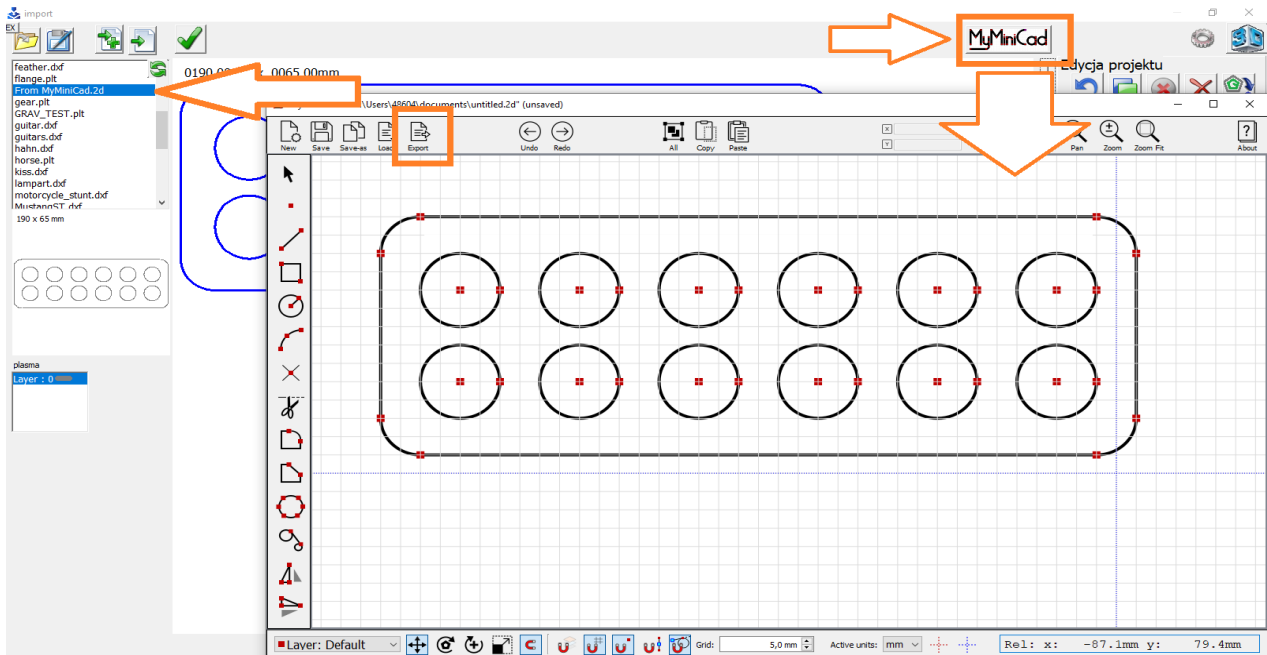

A separate and detailed instruction manual for the **MyMiniCAD** software/module is available for download from proma-elektronika.com.

Direct link to PDF manual:

<https://www.proma-elektronika.com/download/MyPlasm/MyMiniCADen.pdf>

And to the VIDEO manual :



<https://youtu.be/Q8ME9e3jM0M>

A 3D preview of the workpiece is generated from the loaded drawing.



The thickness of the workpiece (material) displayed in the 3D preview can be defined in the configuration window :

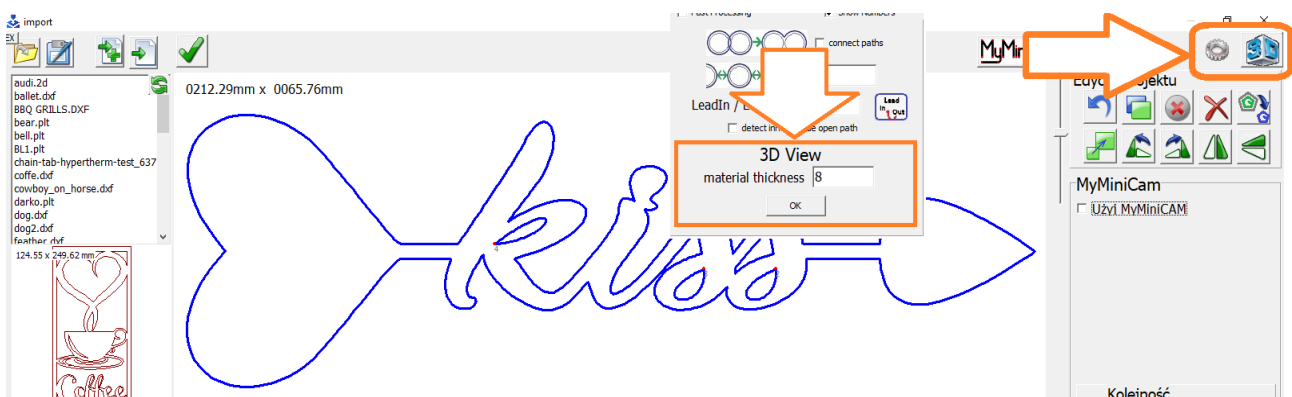

Depending on whether the **MyMiniCAM** module and its options are active or not, the lines are presented in different colours:

All of MyMiniCAM functions active (creation of a toolpaths based on the workpiece):

GREY : outline of the workpiece and inactive lines (not involved in cutting).

GREEN : tool path (offsetted).

RED : LeadIn path.

ORANGE : LeadOut path

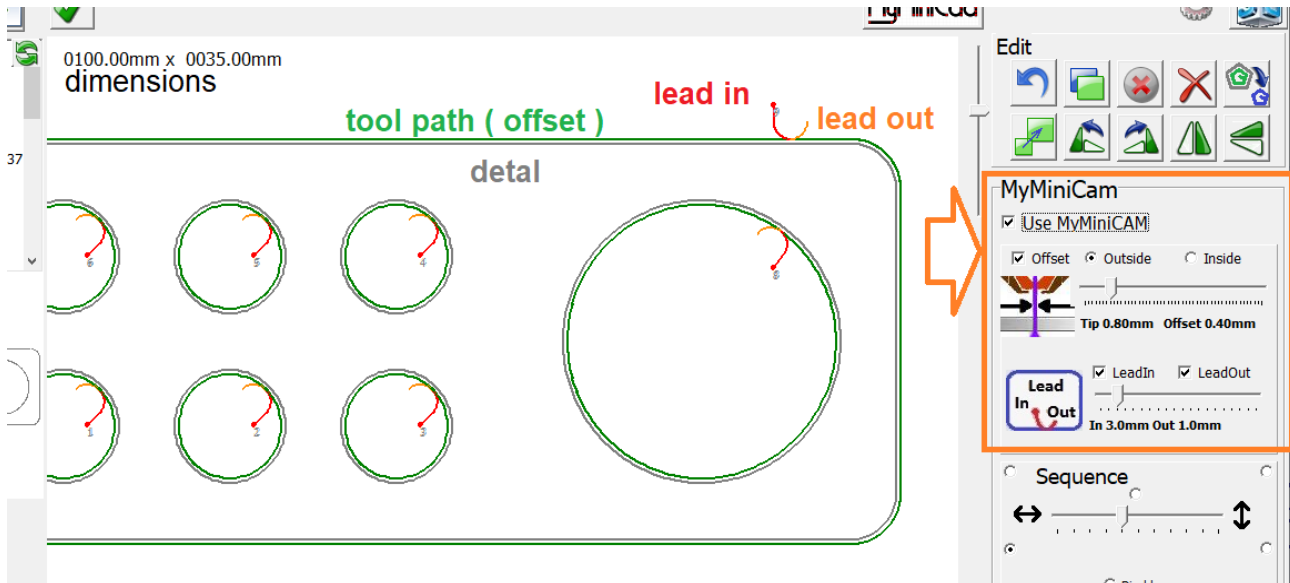

Inactive **MyMiniCAM** module, displays unprocessed 'raw' drawings / tracks in blue. Mode used when tracks are generated in external CAM Softwares (g-codes) or to duplicate pre-generated tracks from the MyMiniCAM module extracted with the  button

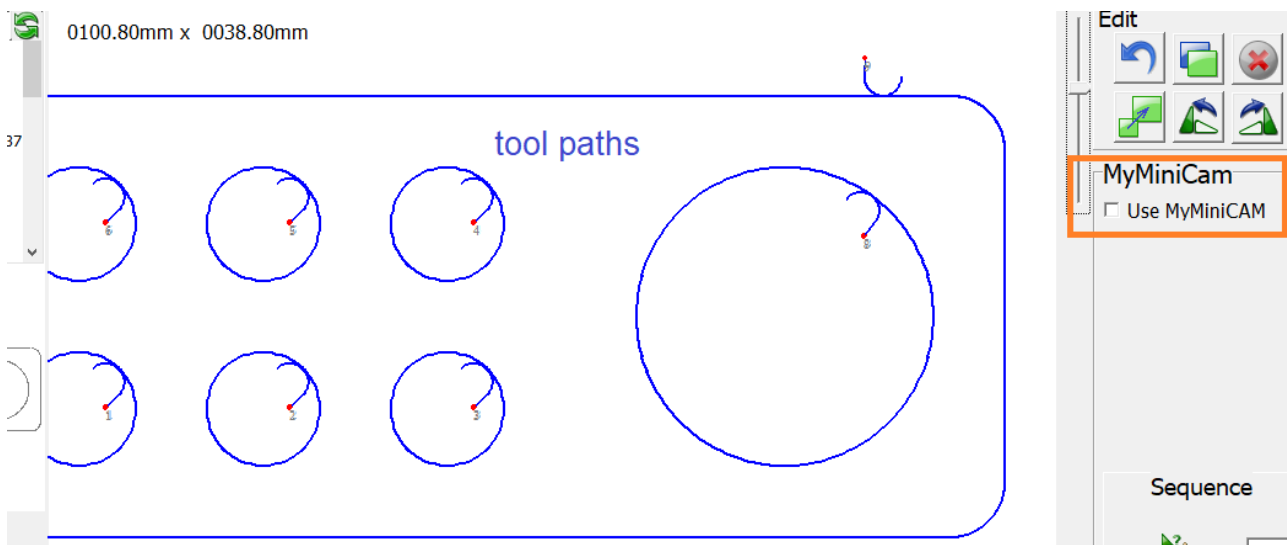

8.2 Importing a drawing / configuring the import

From the list of files, select the **DXF** or **HPGL** file of interest (detail drawing) - if the file has been correctly exported from **CAD**, the size displayed in the preview window should match the design.



If the size does not agree here (it usually deviates significantly from the expected size by incorrectly interpreted units), force the use of metric or imperial units in the import options, or change/adjust the import scale (default is 1):

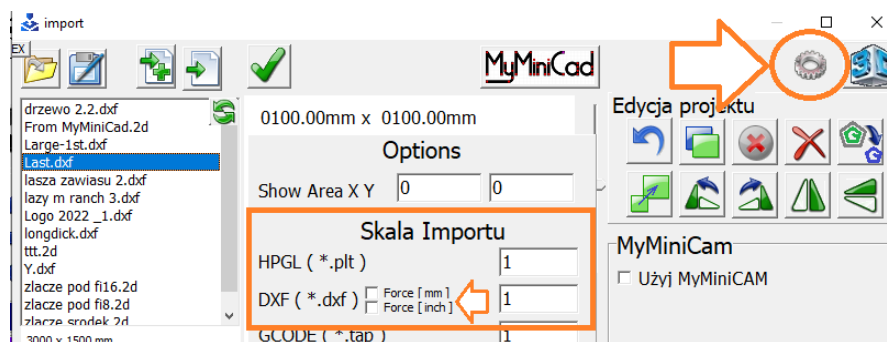

Loading a drawing into the import window is done by clicking the button  beforehand to indicate which layer colour is the 'active' one.

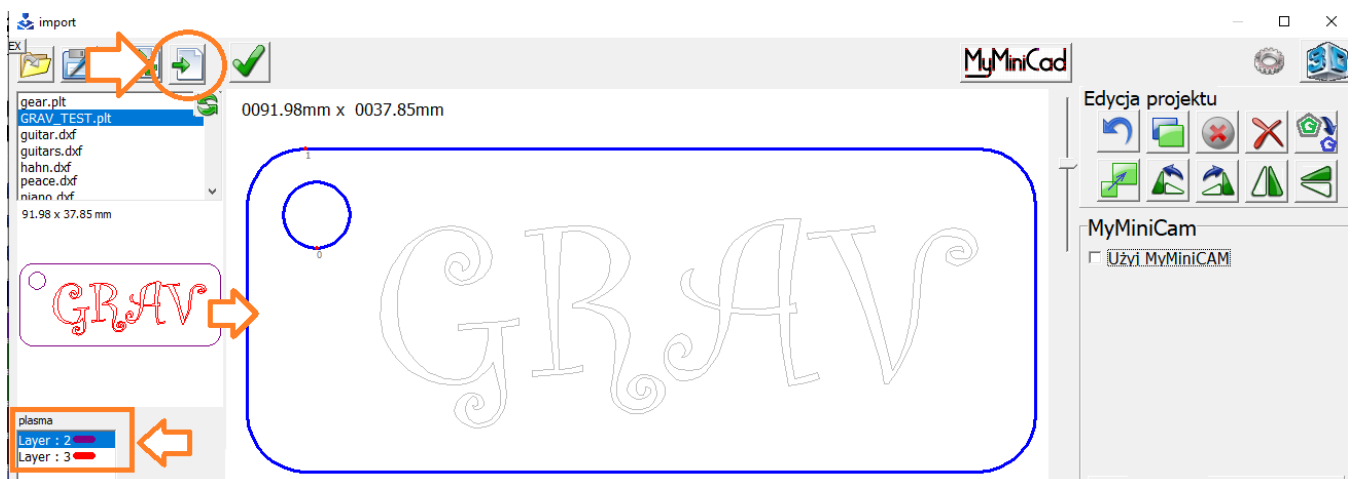

The button allows you to add further drawings. The left mouse button adds horizontally and the right mouse button adds vertically (to up).

8.3 Select objects / tracks

To select a single drawing element, click on it with the left mouse button. It is possible to select elements by surrounding them with a rectangular area "stretched" with the left mouse button.

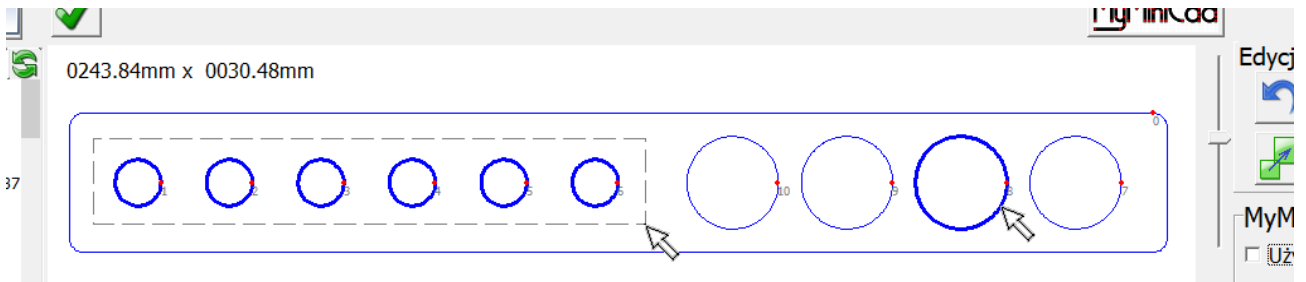

To select / deselect several items, hold down the **CTRL** key.

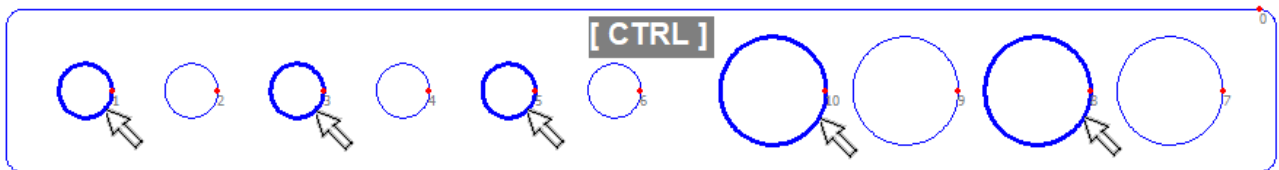

CTRL + A - selects ALL

Clicking on a workpiece outline with the **SHIFT** key held down also selects all elements inside the outline.

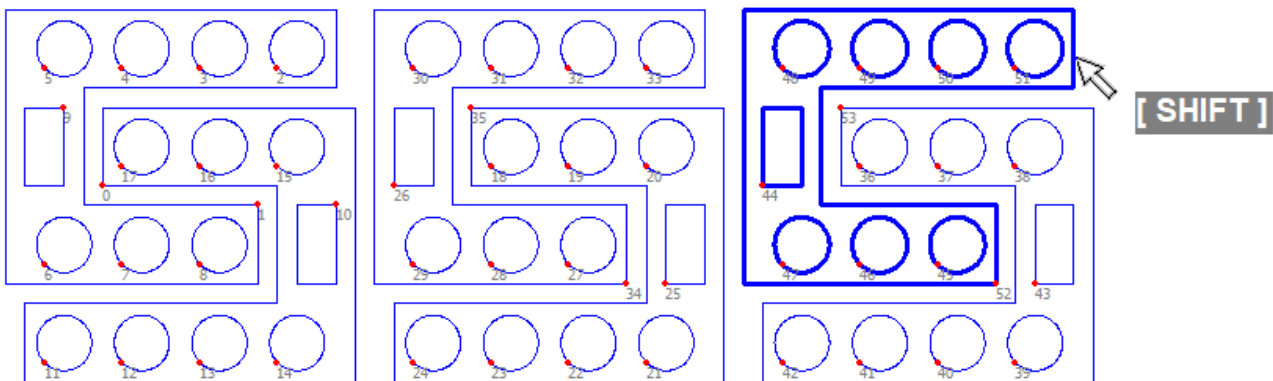

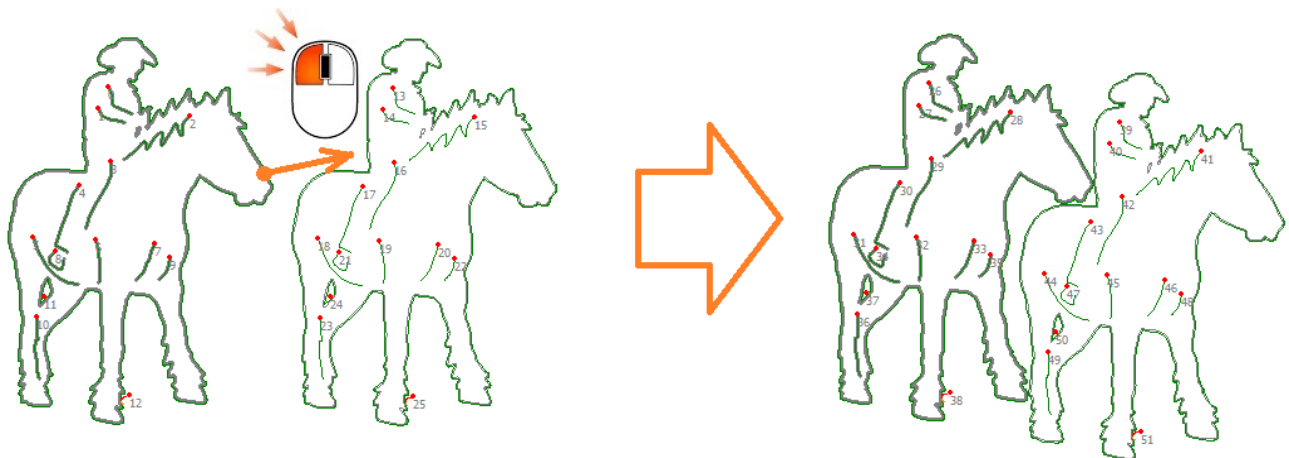

The selected Elements can be moved with the mouse for manual positioning.



8.4 Editing tools



 Undoing the last operation [**CTRL + Z**]

 Duplicate objects / tracks (copy/paste) [**CTRL + C**] [**CTRL + V**]
The distance between duplicated elements can be set in the configuration, whereby "0" means **AUTO match** : three times the width of the slot set with the slider "offset" of the MyMiniCAM module.

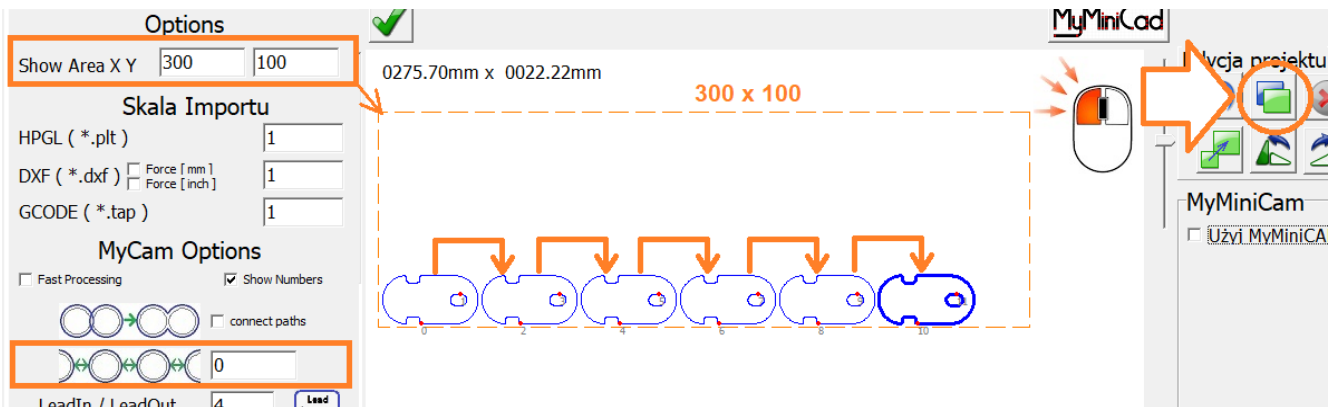

In order to make it easier to replicate the item, it is also possible to define an auxiliary area displayed with an orange dotted line (e.g. showing the size of the material.).

Using the left mouse button duplicates the selected objects horizontally (to the right), using the right mouse button duplicates the selected elements vertically (upwards).

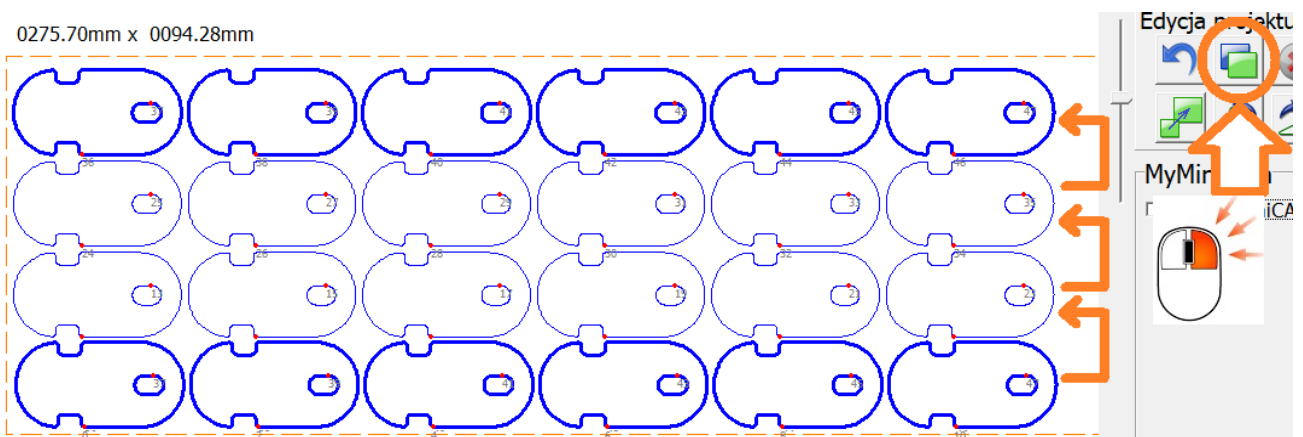

 Deactivation of the track, it will be displayed but not cut, e.g. outline material

 Deletion [**Delete**]

 Convert the result of the **MyMiniCAM** module (**if active**) into tracks.

 Rotate objects, Left Mouse Button : 90 degrees,

 Right mouse button : 3 degrees, Held [**CTRL**] key : 0.25 degrees.

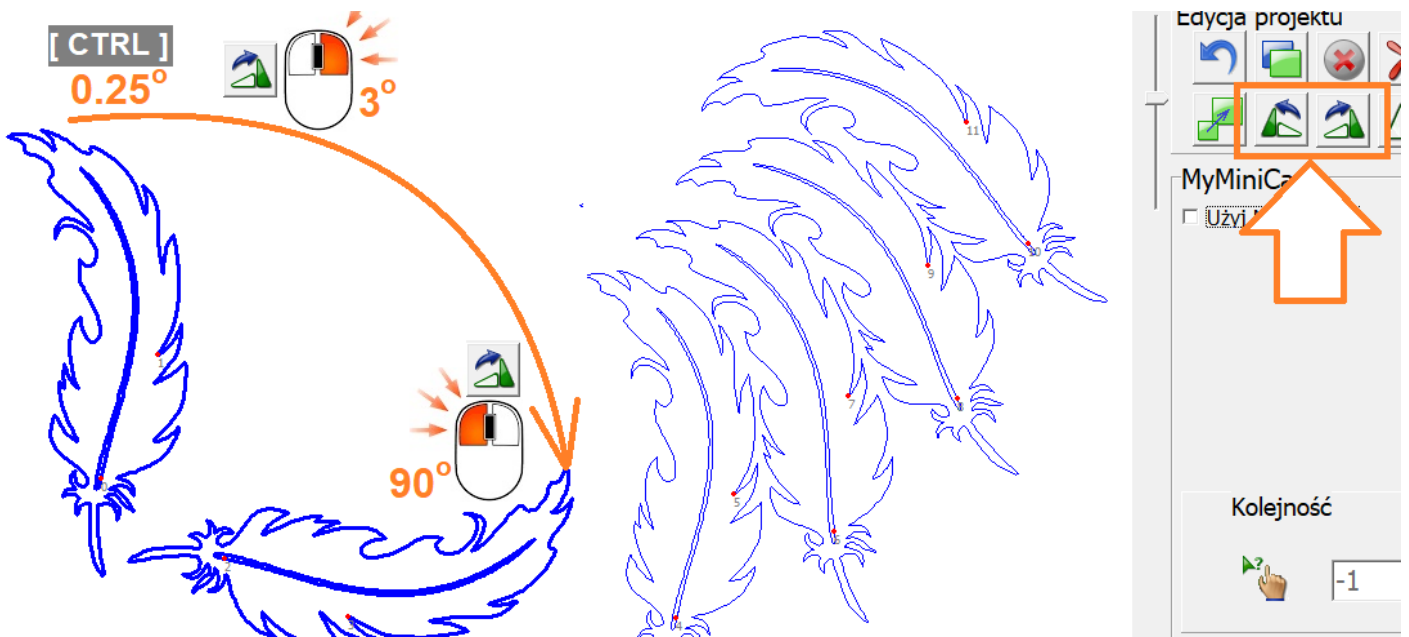

 Vertical / horizontal mirroring

 The object scaling tool can be used in several ways.

 It is possible to introduce a scale, e.g. 0.5 will reduce the dimensions twice.

It is also possible to enter the desired dimension in the X or Y axis, with the tool retaining the proportions for the other axis as standard.

0150.00mm x 0150.00mm

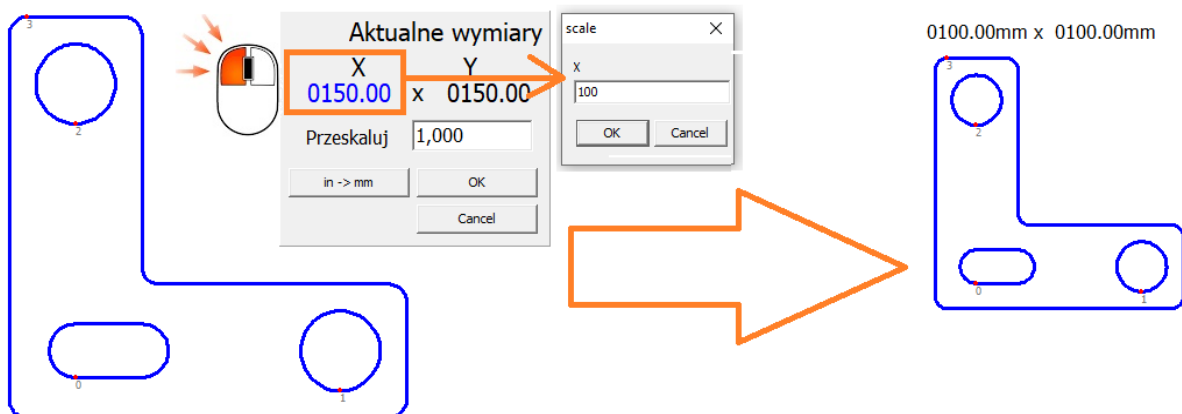

To scale in one axis only, right-click the dimension to be changed (X or Y):

0124.55mm x 0249.62mm

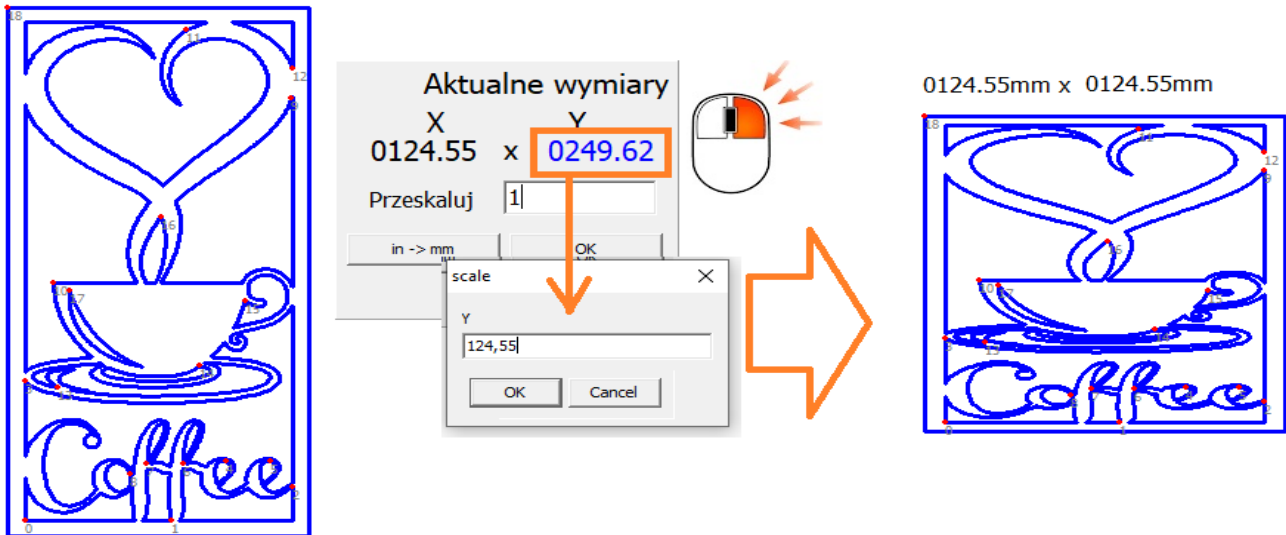

Right-clicking on the scaling tool forces the selected objects to scale individually.

A useful tool, for example, for resizing multiple identical holes.

0190.00mm x 0065.00mm

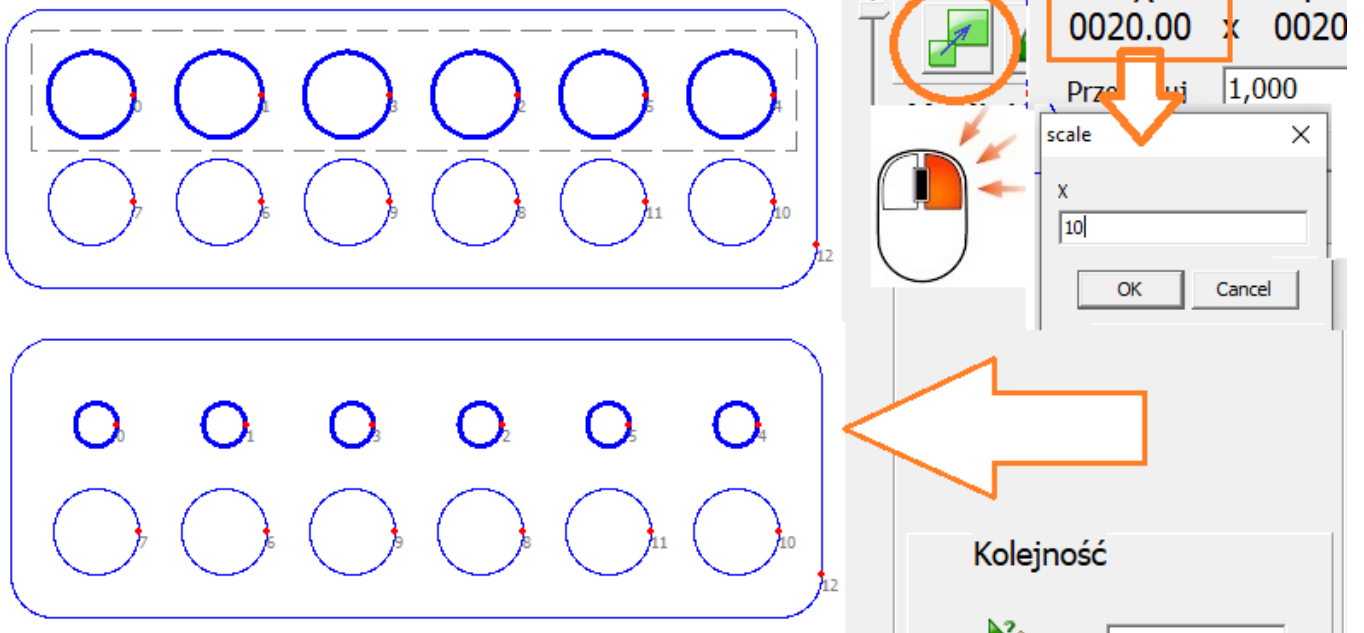

9.0 MyMiniCAM - path generation.

The toolpath is the "track to be travelled by the tool (plasma torch)", which is generated from the drawing of the workpiece and parameters such as path offset and entry/exit tracks. CAM programs are used to create toolpath.

For the simplest operations, the simple built-in **MyMiniCAM** module can be used, which creates the paths automatically with virtually no user input. For demanding designs, the use of professional external CAM programs (e.g. **SheetCam**) is recommended.

9.1 Offset

The basic operation of any **CAM** module is offset - that is, moving the track away from the workpiece to take into account the width of the gap created by the cut (nozzle diameter). The offset tool offsets the toolpath by half the slot width.

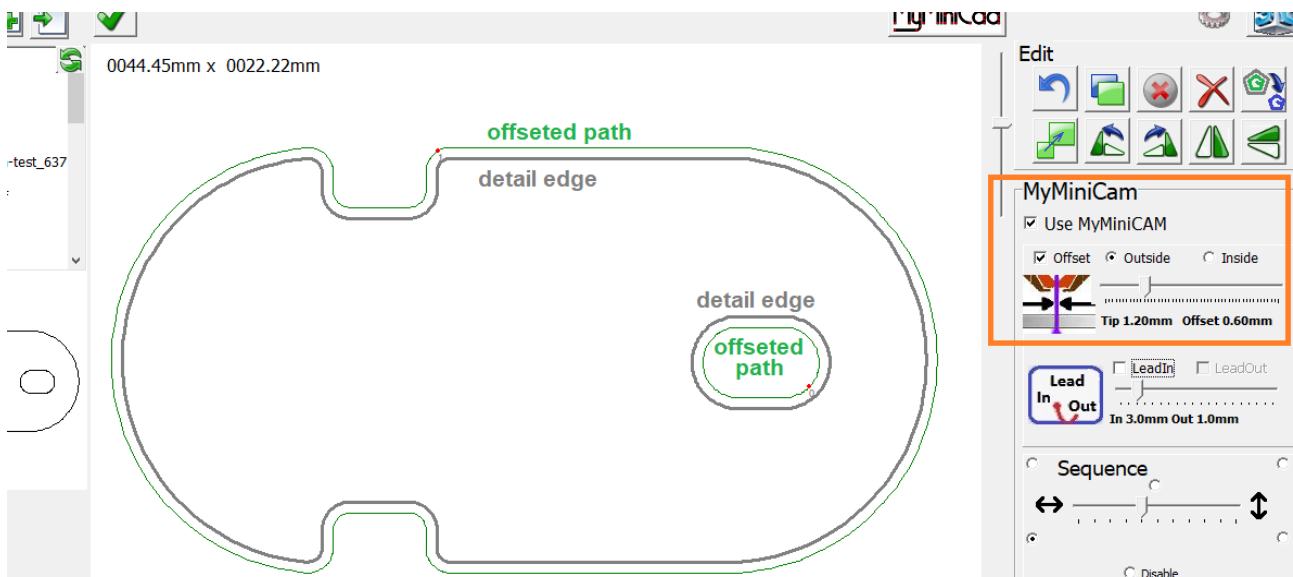
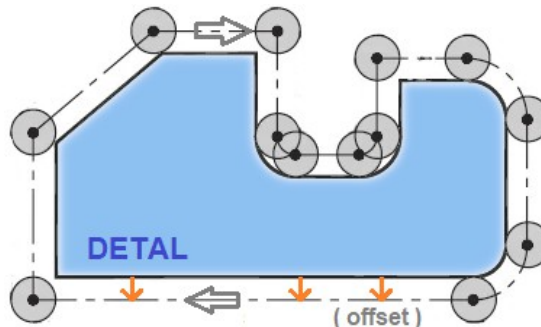

The offset tool automatically recognises whether the offset should be outside (for component outlines) or inside (for holes).

ATTENTION ! Offset only for closed objects. For open paths (notches or incorrect/unclosed detail) the offset will not be applied.

For an individual component, specify whether the offset is to be outside (for the detail drawing proper) or inside (hole).

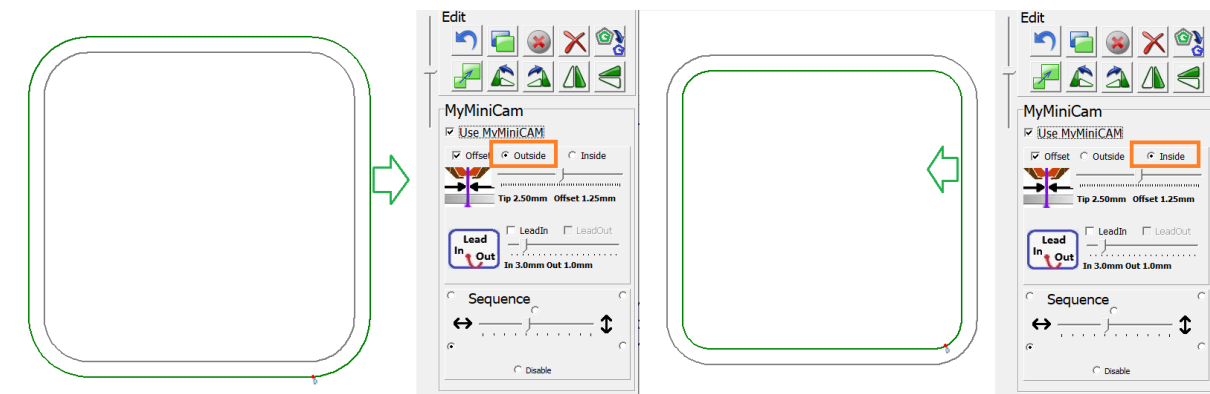

The offset value can be set with the slider, or entered manually at the click of a button.

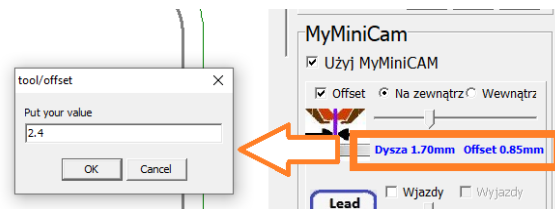

9.2 Lead in / Lead out

The plasma torch creates a "crater" when piercing the material, which damages the edge of the workpiece. Thanks to the lead-in track, the crater is moved at a safe distance from the edge of the workpiece so that it is not damaged (piercing in the debris instead of on the actual path). After the material has been pierced, the workpiece is led out to the actual cutting track. The lead-in method (straight or curved) can be changed by double clicking on the **Lead-In** symbol, the length of the **lead-in** can be determined with the slider or entered manually:

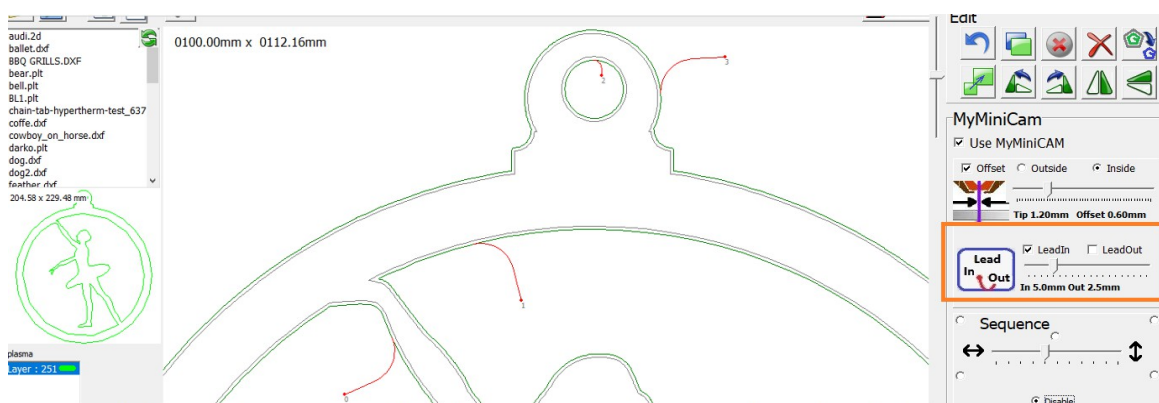

In some cases, the software may shorten or disable the lead-in track if the Piercing point is too close to another workpiece edge.

The lead-out path is used to cut thick materials because when the torch is guided over the material, the arc at the bottom of the material is retarded so that the end of the cut at the end of the actual path leads to undercutting of the bottom of the thick material.

The length of the lead-out path is set in proportion to the length of the lead-in path - the proportion can be set in the configuration window, e.g. a LeadIn / LeadOut ratio = 3 means that the exit path is 3 times shorter than the entry path.

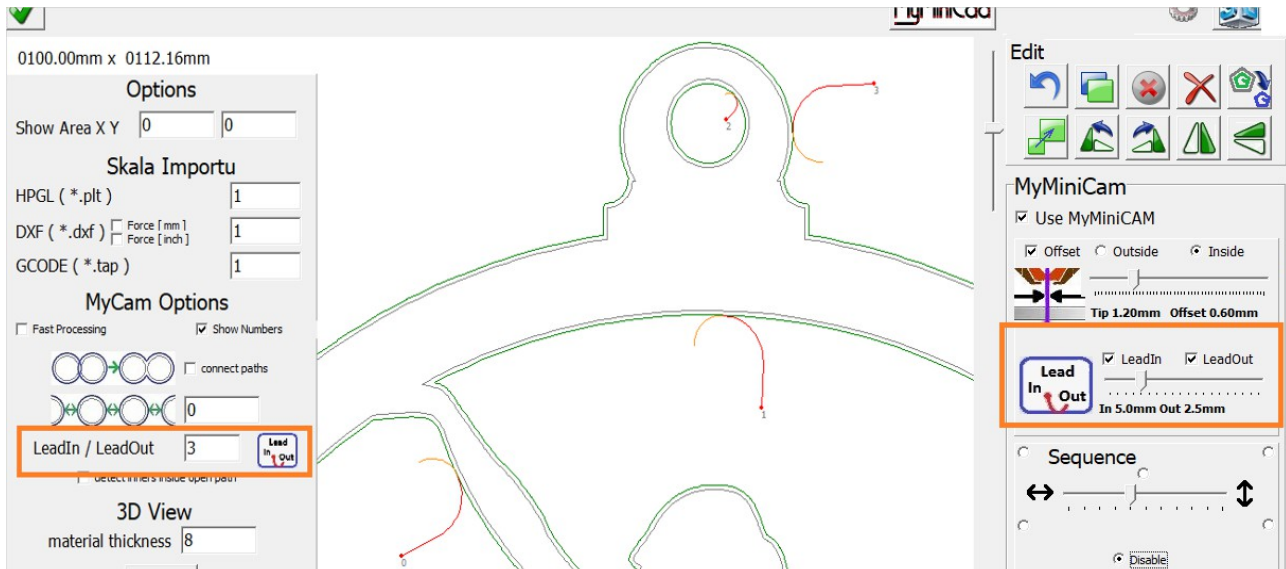

The type of lead-out (along a curve or along a path) can be determined by double-clicking on the **Lead In/Out** symbol:

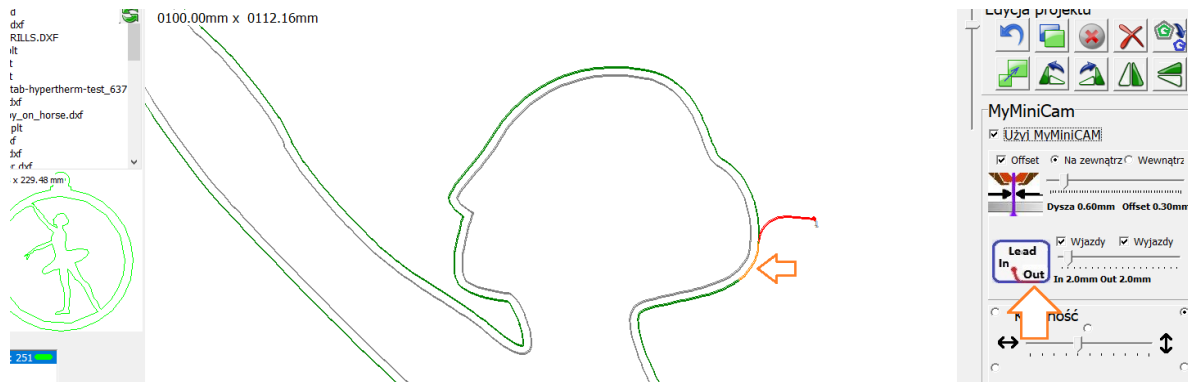

By clicking with the **Right Mouse** on the outline, you can select the LeadIn location:

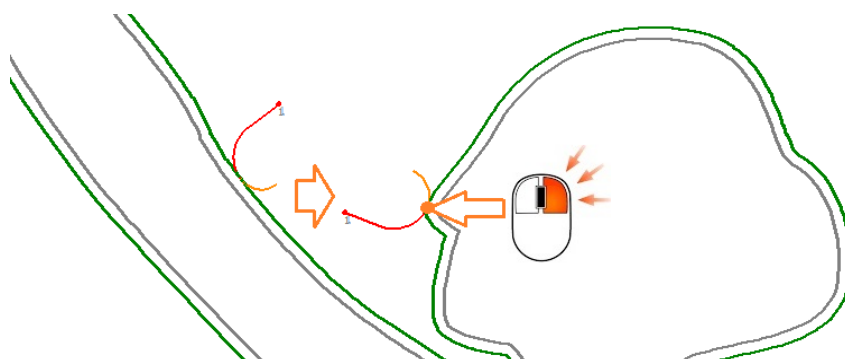

9.3 Path direction

Plasma torches are designed (air turbulence) in such a way that when cutting from its right side, the best possible cutting quality is obtained at the expense of the cutting quality from the left side. Therefore, all external contours should be cut in the CW direction (clockwise) and the holes in the CCW direction (counterclockwise).

The direction for closed tracks is set automatically. The direction of an open track (notch) can be changed with the right mouse button.

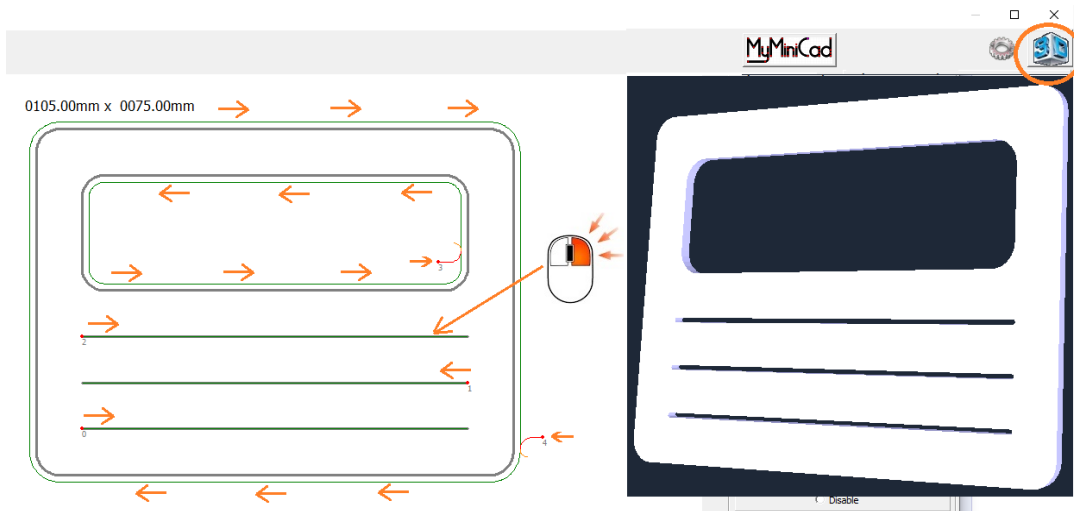

9.4 Path sequence

The cutting out sequence is determined automatically (if " Disabled " is not selected) taking into account the vertical / horizontal override settings and which area to start with. Priority is ALWAYS given to cutting out holes before cutting out the outline.

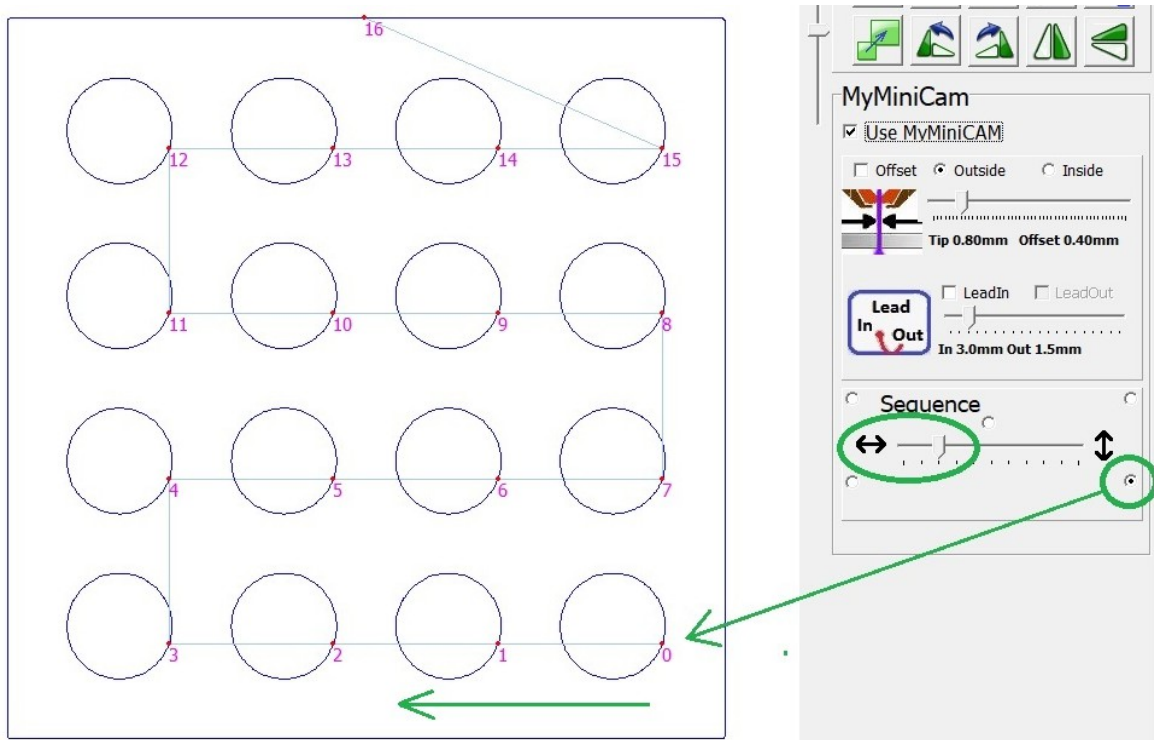

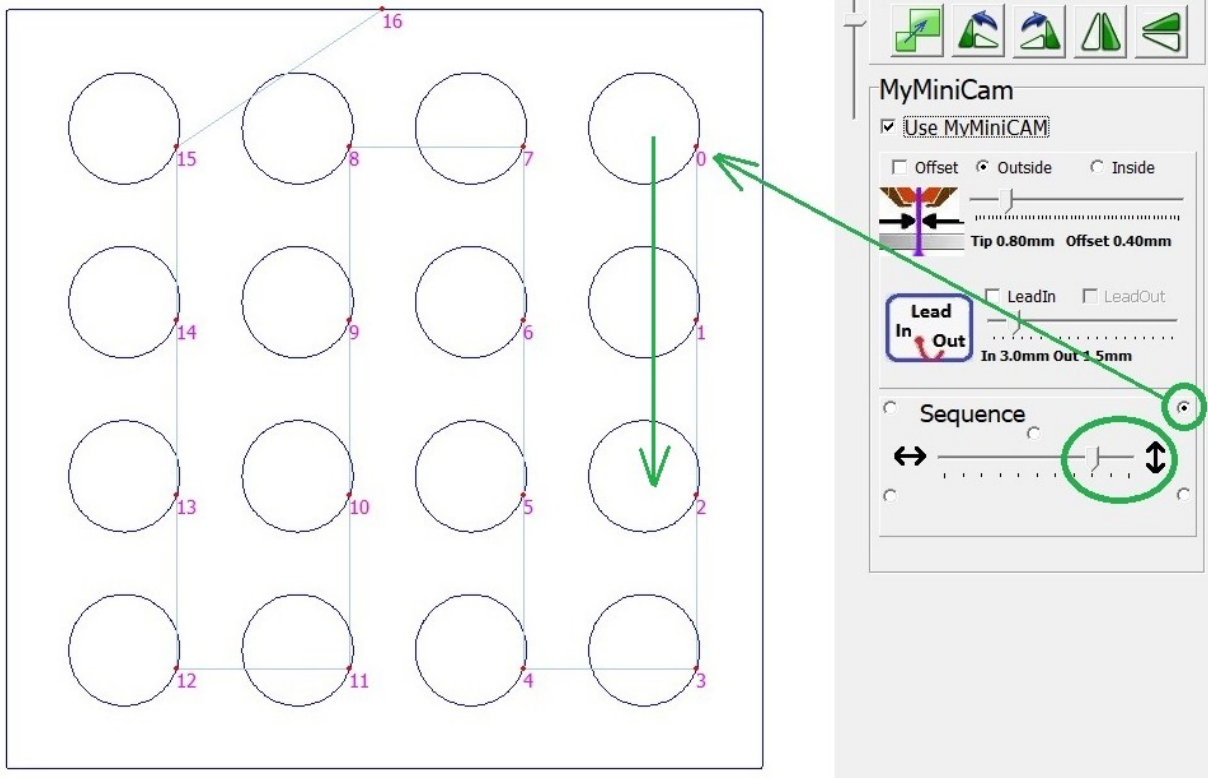

When the **MyMiniCAM** module is inactive, it is possible to manually determine the order of the paths. If you need to use the **MyMiniCAM module** and your own order, you can convert the **MyMiniCAM** result into raw tracks.

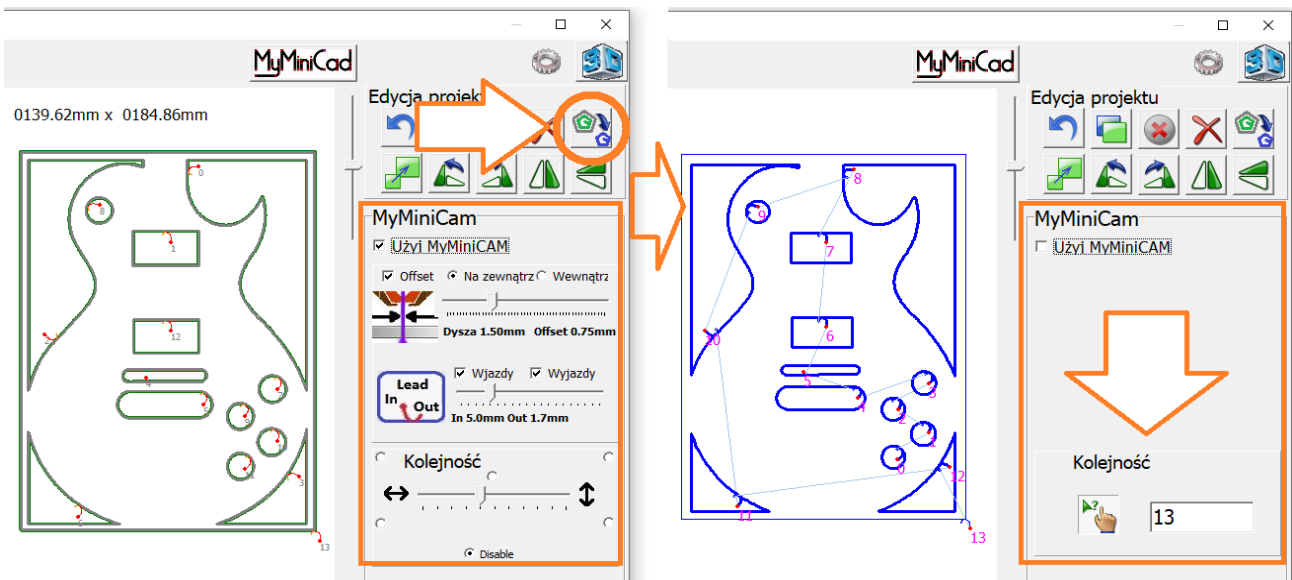

After selecting the manual sequencing tool, click the paths according to the required order. The number indicates the path number, which can be set individually.

9.5 CAM Tips

The Cam module performs operations in a specific sequence :

1. Analysis and correction on the loaded drawing ("Auto-welding" of unconnected lines, removal of minor defects in the drawing, etc.).
2. Detection of internal (holes) and external components
3. Generation of tool paths (offset)
4. Path analysis / collision analysis / removal of uncut paths, merging of paths etc.
5. Determining the optimal cutting direction of the paths
6. Addition of lead in/out paths in the waste material
7. determining the sequence the paths are cut

It should be borne in mind that every change in the details (editing or adding an element) starts the processing procedures from the beginning ... also, e.g. a change of offset forces the generation of a new paths, which is analysed anew, the LeadIn/LeadOut paths are generated again, etc.

It is recommended that the steps are carried out in the above order, otherwise, for example, once you have established your own insertion point, it will be modified after editing the element or offset (newly generated paths).

EXAMPLE: Before duplicating and placing components, it is a good idea to generate tracks for individual details (or groups of details) beforehand and only after generating the target paths perform the duplication.

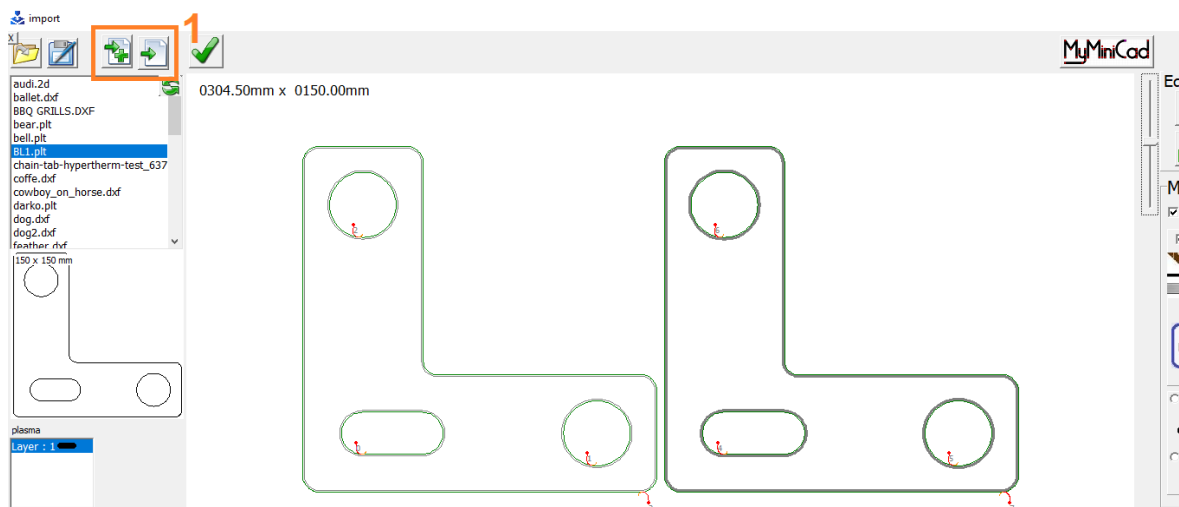

0203.59mm x 0150.18mm

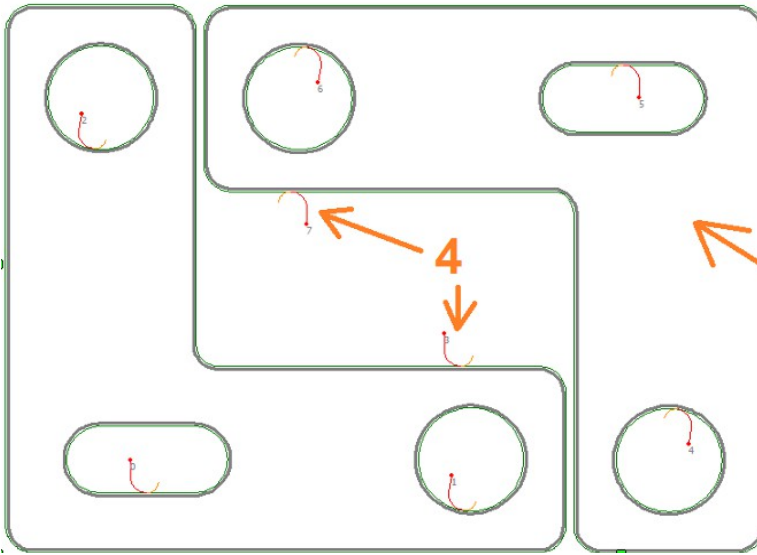

Edit

2

3

MyMiniCam

Use MyMiniCAM

Offset Outside Inside

Tip 1.20mm Offset 0.60mm

Lead In Out

LeadIn LeadOut

In 5.0mm Out 2.5mm

Sequence

← →

Disable

0203.59mm x 0150.18mm

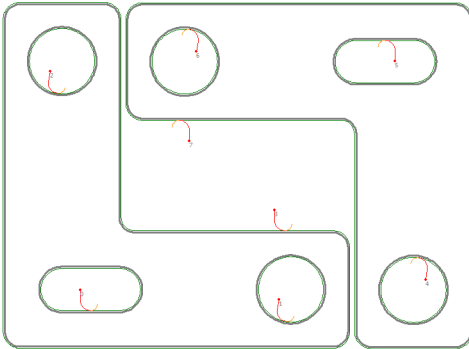

0205.09mm x 0151.68mm

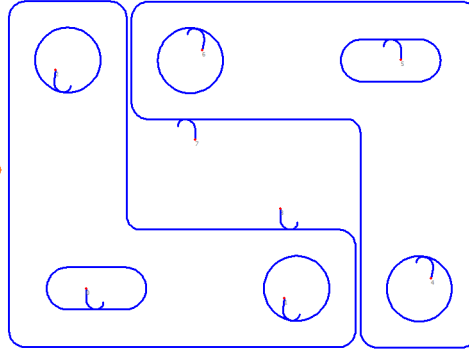

Edycja projektu

MyMiniCam

Użyj MyMiniCAM

Kolejność

0

043.45mm x 0620.22mm

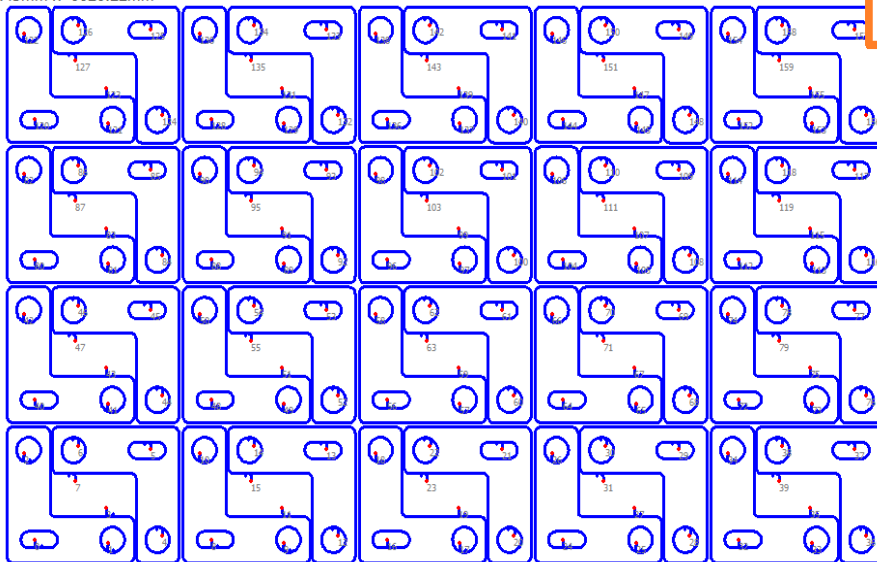

MyMiniCad

Edycja projektu

6

MyMiniCam

Użyj MyMiniCAM

Kolejność

0

10.0 Additional options

10.1 Reduction in cutting speed for holes

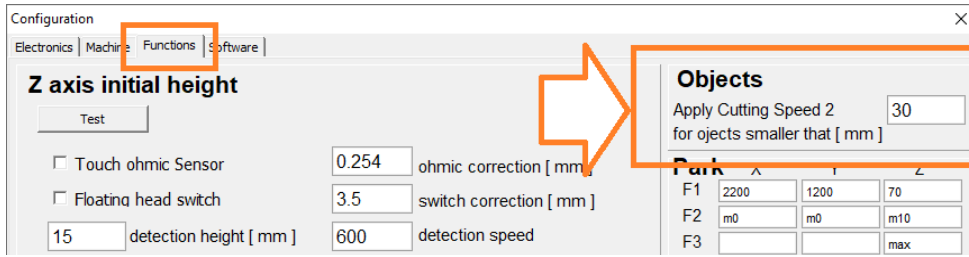

The function forces the use of speed 2 to cut holes (smaller than the declared value) Speed 2 can be specified directly or as a percentage (proportional to the set cutting speed). For these objects, the THC height adjustment function is deactivated and the cut is made at cut height 2.

By clicking on the design analysis button, the objects are light blue.

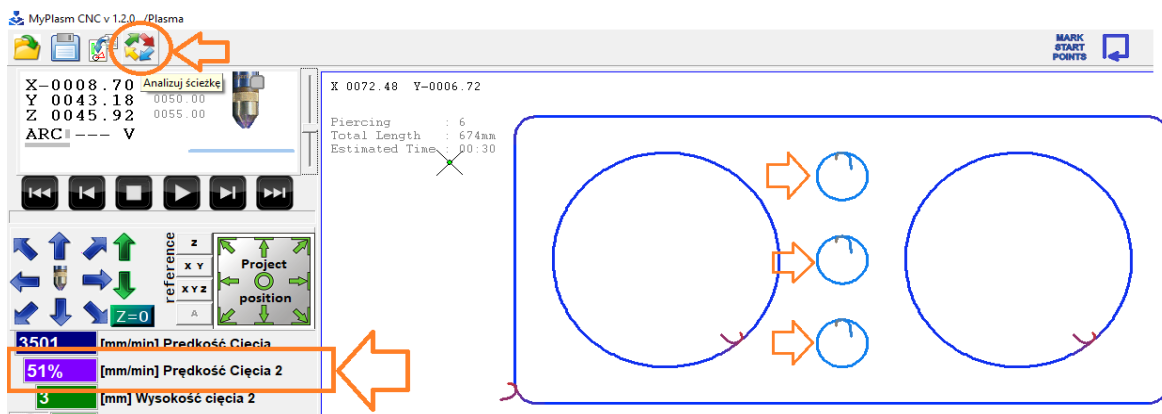

10.2 Pointing of holes

The scoring function forces the plasma to be switched on for a fraction of a second at the centre of the hole instead of cutting it to mark the drilling point. In the special functions, it is possible to define the time in milliseconds and the maximum hole diameter [mm] to be pointing centrally.

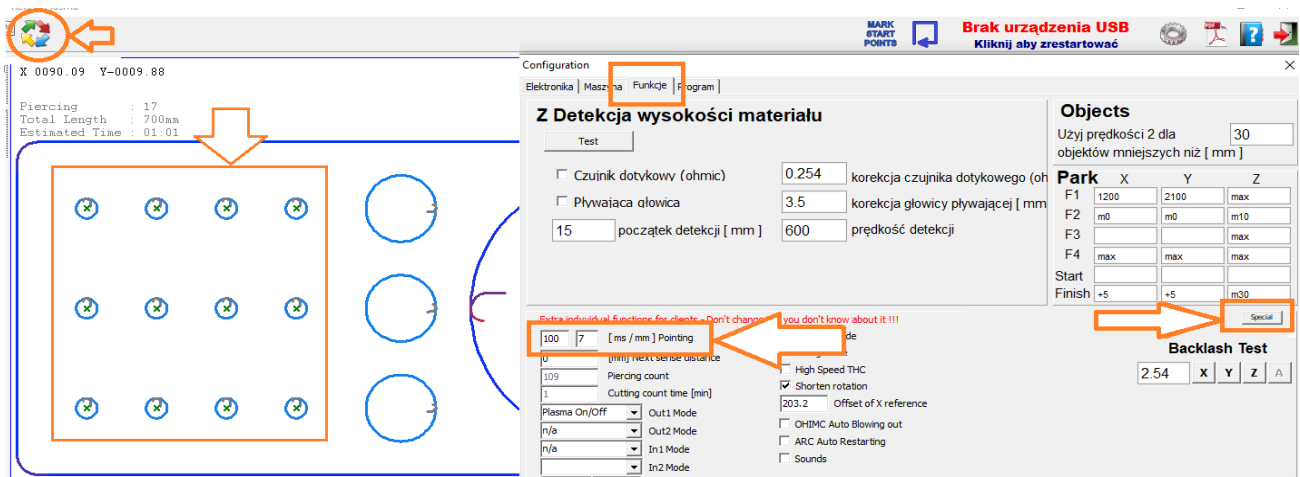

10.3 Parking

The park function allows the user to assign any 4 coordinates to which a movement can be triggered with the **F1 - F4** keys and, in addition, coordinates before [start] or / and after [finish] work. The coordinates can be entered relative to the machine reference points, relative to the material zero point or relative to the current torch position.

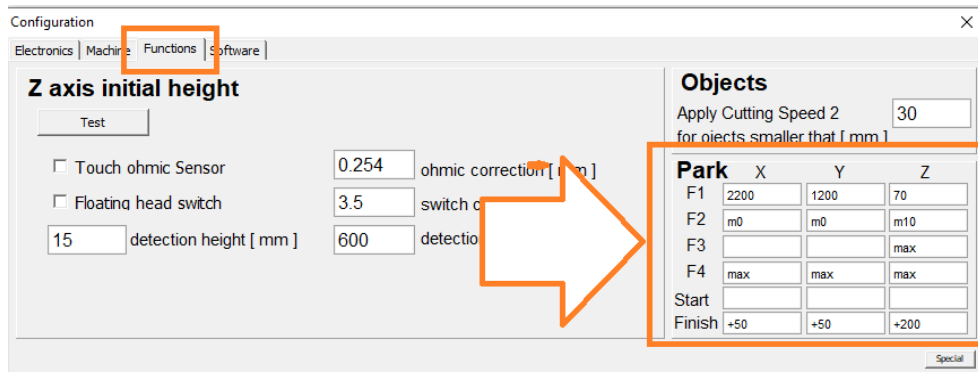

There are several options available that can be used as a parameter.

[XXXX] Absolute machine coordinates

e.g. Defining **1200 2600 100** will result in a Z axis position of [100mm] relative to the table and an XY displacement of [1200,2600] relative to the lower left corner of the machine. **NOTE:** The use of absolute coordinates requires the machine to be correctly hommed!

[mXXXX] Material Coordinates : similar to above but the coordinates are related to the position of the material/design. e.g. defining m0 m0 m5 will move the torch to the lower left corner of the design [X=0, Y=0] positioning the torch 5mm above the material.

[+XX / -XX] Relative displacement relative to current position. e.g. Defining the "Finish" parking as +10 +10 +20 will raise the torch by 20mm and move the X,Y axes by 10mm at the end of the cut - a useful function e.g. for descending the slot to prevent splashing of the water table at the end of the cut.

[max] - specifies the maximum absolute value defined in the Program Limits . e.g. defining the Z-axis parking as the "max" value will be raised to the maximum.

By leaving the box empty, the axis in question is not taken into account (it remains in its current position).

It is possible to quickly assign the current torch position to the window by clicking [CTRL + F1][CTRL + F4] once the desired torch position has been established.

10.5 Gas cutting / oxygen mode

The gas cutting option (**OXYGEN**) activates two additional parameters :

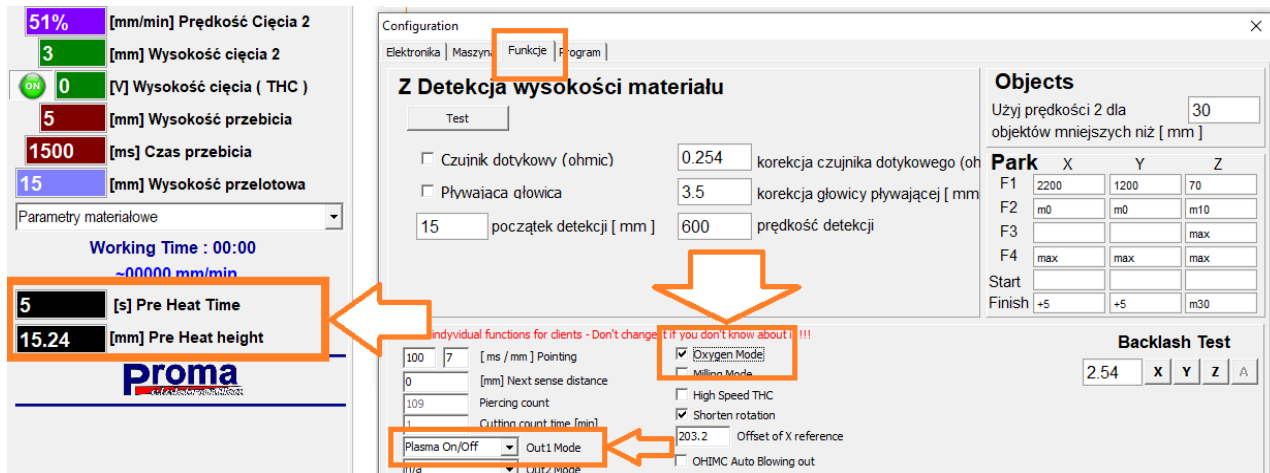

Pre Heat Time - the time it takes for the material to heat up (pond formation) before the cutting gas valve is pierced/activated. Timing can be skipped/shortened during heating by pressing **ENTER**.

Pre Heat height [mm] - the height at which preheating will be performed.

See the installer's manual for the connection of the solenoid valve to the Out1/Out2 output.

If the software/machine is used for plasma and gas cutting, it is most convenient to create two programme profiles (two separate configurations) - see the installer's manual.

Apart from the aforementioned parameters, gas cutting is identical to plasma cutting.

10.6 Milling / drilling

A simple 2D cutting/milling function (**MILLING MODE**) activates two additional parameters :

Milling depth : target milling depth.

Partial depth : depth per one passage.

For example, Milling Depth = 12 [mm], Partial Depth = 3 [mm]. The milling of each path will take place in 4 passes of 3mm.

In combination with the pointing function (**point 10.2**), this is the drilling function.

In the milling/drilling function, Cutting Speed 2 is the plunge speed **Z**.

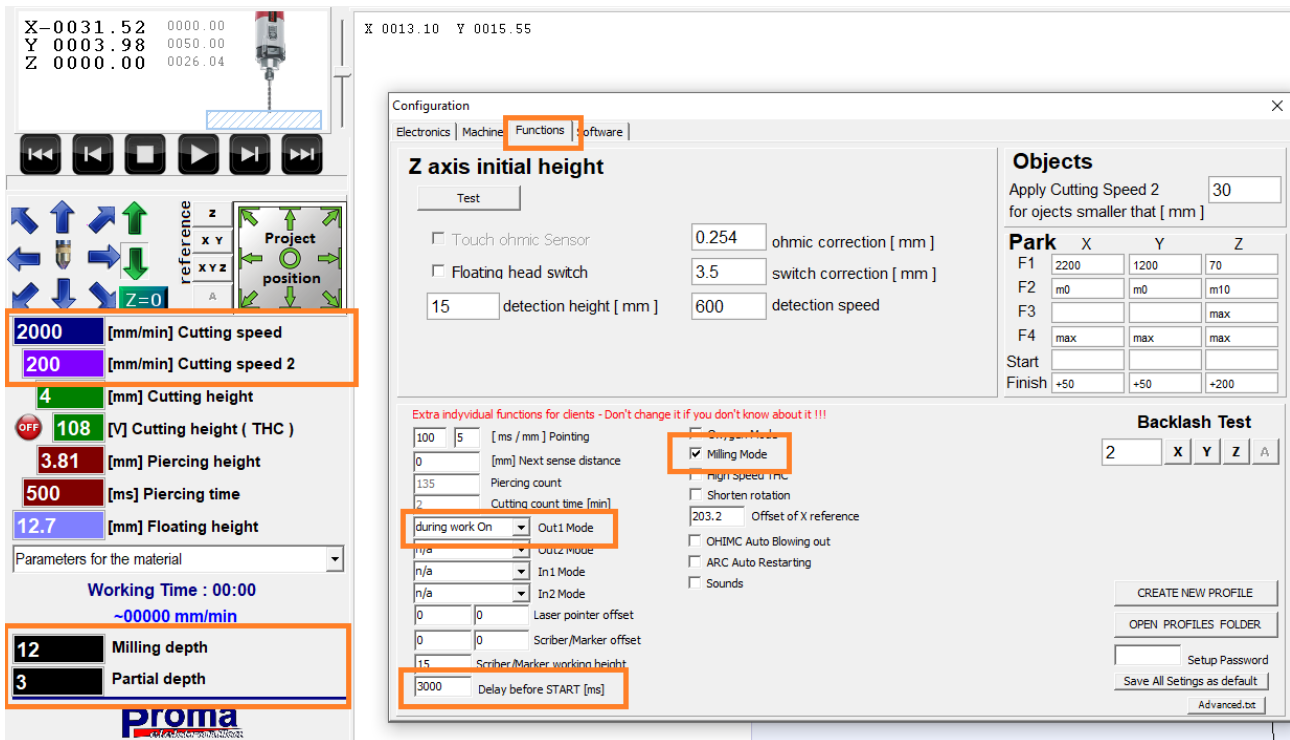

The **Out1** output can be used to start the spindle (configured as "**during work On**" and the parameter **Delay before START [ms]** to delay the start of the machine before the spindle has spun up.

For the connection of an external relay to **OUT 1** for spindle start , see the installer's manual.

If the software/machine is used for plasma cutting and milling, it is most convenient to create two programme profiles (two separate configurations) - see the installer's manual.

10.7 Engraving / marking

The engraving function (**Scriber**) allows a marking tool (e.g. pneumatic scriber / marker) to be mounted on the machine for scribing before plasma cutting. To do this, configure the output **Out1** or **Out2** in the special functions as "**scriber / marker**" and enter the offset (offset of the mounting) in the X and Y axes relative to the plasma torch and specify the height of the **Z** axis to be set during marking.

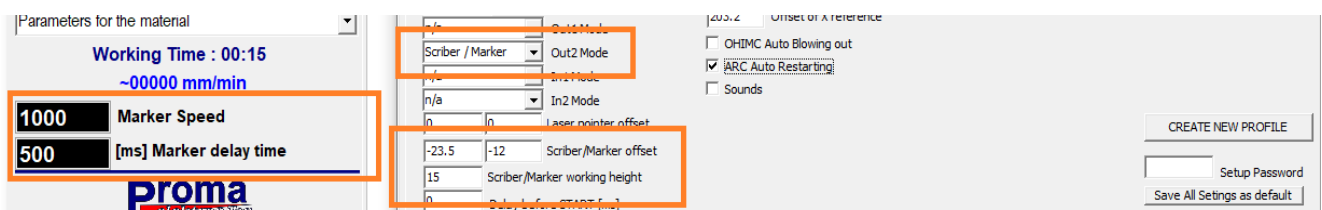

When preparing the design, use different colours (layers) for the scribber/engraving/marking option and for plasma cutting.

An option will appear in the import window to assign a colour to the operation :



In the main window you can see the position indicator of the markup tool :

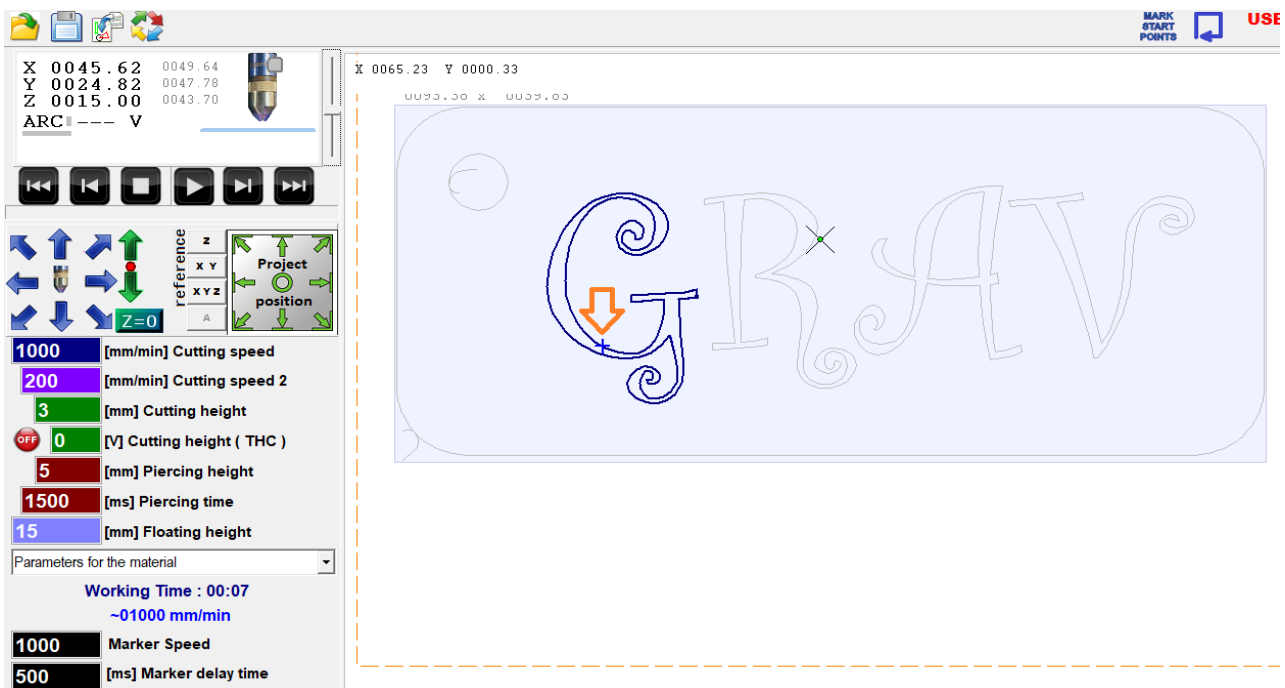

Marker Speed - the feed speed of the marking tool.

Marker delay time - Delay of movement when the output is switched on.

NOTE !!! : Arranging the design within the working range of the plasma torch does not guarantee that the marking tool is also within its path.

10.8 Marking/pointing of punctures

This function makes it possible to mark (or piercing) the puncture points in thick materials in order to drill them or make punctures with, for example, a low-quality nozzle before the actual cutting process, thus reducing the cost of torch consumables.

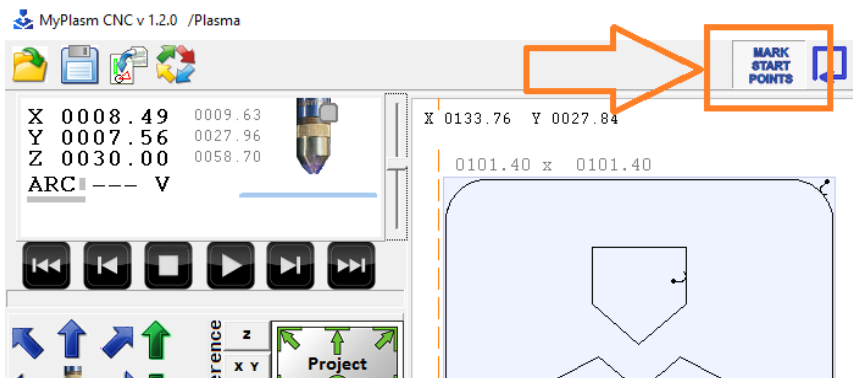

10.9 Laser crosshair

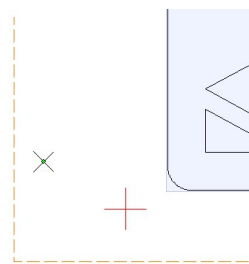
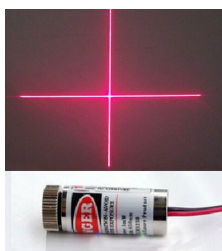

If a laser pointer / crosshair is mounted on the machine and its offset is specified, the material positioning options (Material Position) are performed relative to it and not to the plasma torch.

11.0 Rotary/rotary axis

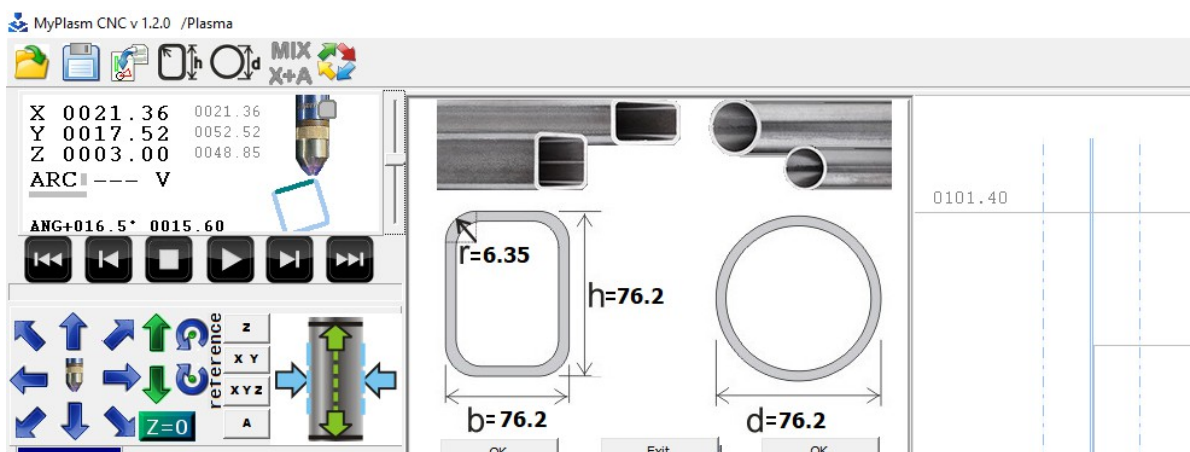

At the time of writing the manual, the rotary axis support is under development, available as test (BETA). The description / instructions can be found at :

<https://proma-elektronika.com/instructions/myplasm-cnc-system-rotary-axis/>

12.0 Keyboard shortcuts

12.1 Shortcuts : The main program window:

ESC : STOP

SPACE : torch start-up

Keyboard arrows : XY axis control

PageUp / Page Down : Z-axis control

SHIFT : force manual speed max.

CTRL : manual speed 10% of setpoint

F1 - F4 : Parking (10.3)

CTRL+F1 CTRL+F4 : Assign parking coordinates

F5 : Start automatic operation

SHIFT + F5 : start of simulated operation

CTRL + F5 : cut the selected path in the opposite direction (from the end)

F6 : resume cutting at the breaking point

F7 : material detection

F8 : $Z = 0$

F9 : $XY = 0$

F12 : driving along the project outline

CTRL + Z : undo material positioning operation

CTRL + S : save cutting parameters to base (5.2)

CTRL + D : remove parameters from the base (5.2)

12.2 Shortcuts : Import window:

CTRL : allows you to select multiple items with the mouse

SHIFT : Selects all elements inside the outline selected with the mouse.

CTRL + A : Select everything

CTRL + C : copy (to clipboard) the selected items

CTRL + V : paste (from the clipboard) previously copied items

CTRL + Z : undo the last operation

DELETE : remove the selected items

CTRL + Q : converts **CAM** result to raw tracks / disables **MyMiniCam**.

CTRL + E : Export item/path as HPGL.

While holding down the CTRL key :

- **Rotation tool** : force **rotation** in 0.25 degree increments
- **Scaling tool** : "serial" scaling of holes (8.4).

13.0 Troubleshooting.

13.1 Program startup problem

If the program does not start and standard procedures such as Restart Windows, do not help, you should reinstall the program (you may need to uninstall / delete the previous version) possibly manually restore from a copy. The description can be found in the installation manual.

13.2 Software operation problem

If the program has stopped working properly, you can try to restore its state to when it was working properly, to do this, in the "Program" tab, click Restore from backup and select from the list the copy file with the date when everything was working properly.

The file named **LastGood.fms** is the file created when a cut of a correctly processed file is completed without problems. If such exists in the list, it is probably the "best" safety backup.

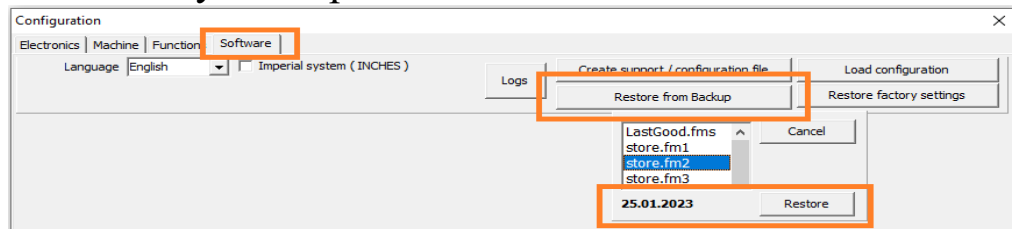

13.3 USB Controller Communication Problem with Computer



Communication problem may be caused by incorrect power supply voltage, damaged or incorrect USB cable, incorrect driver installation, incompatible version of PC Software and Controller Firmware and in the case of communication interruption during plasma arc startup, incorrect grounding and/or shielding may be the problem. See the installer's manual for details.

13.4 Plasma interface communication problem

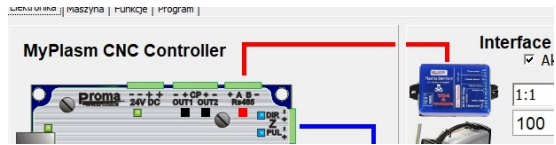

In case of this message, turn off the power and check the **RS485** connection cable between the modules. If the electrical connection is correct, it means that the plasma interface or RS485 communication modules in the controller and/or plasma interface have been damaged.

Do not turn on the power supply - please contact the manufacturer Proma-Elektronika.

Due to the high voltage and current present during plasma arc ignition, inaccurate grounding, poor insulation, shielding, ground loops, lack of grounding of the plasma interface, and/or poor contact between the ground clamp and the material being cut may result in damage to the electronics (see the installer's manual).

13.5 Problem with maintaining cutting height / THC

First of all, check the correctness of the cut with a rigid and even material and the THC turned off. Pay attention to the correct cutting height (cutting height 2) and whether the read ARC voltage is correct (70-170V). If the cutting height is incorrect, it means the material detection is not configured correctly. Incorrect voltage reading can be caused by incorrect configuration/connection of plasma interface (see installer's manual) , by worn consumables (nozzle, electrode), incorrect air pressure/flow or by **WRONG CONTACT OF GROUND CLAMP TERMINAL WITH CUT MATERIAL.**

If the cutting height is correct and the voltage is correct, the cause may be that the THC cutting height (voltage) is not set correctly. See item **6.2**.

13.6 ARC OK main arc detection problem

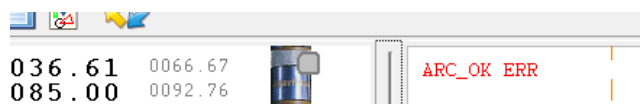

The main arc detection problem is caused by an incorrect reading of the plasma arc voltage (refer to the installer's manual), too long material piercing time (the material under the torch is burned out before the XY movement starts), worn consumables (nozzle, electrode) or incorrect air pressure/flow.

13.7 DXF file import problem

In order for DXF files to be imported correctly by the system they should be saved in R14 DXF version. Before export/save, all fonts (preferably select the whole project) should be converted to curves (e.g. EXPLODE function in AutoCad).

13.8 Cutting quality problem

Many factors affect the quality of cutting. First of all, it is necessary to recognize where the problem originated: in the control system, mechanics or plasma source / torch.

It is a good idea to try to draw the element instead of cutting it out.

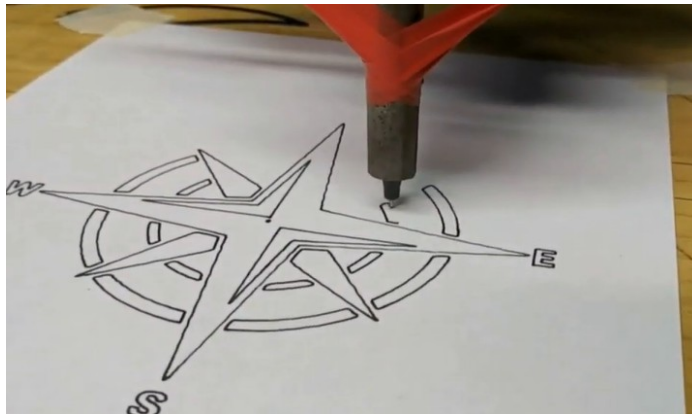

Popular problems are :

- Beveling : mainly depends on the cutting parameters such as cutting speed, cutting height, air pressure and wear of consumables (nozzle, electrode), if the beveling occurs only in one axis (e.g. X) then turn the torch 90 degrees to diagnose if the problem is the torch.
- Distorted holes, failure to keep dimension: this is usually a backlash problem on the X or Y axis. The backlash test can be carried out in special functions (the motor turns gently but the axis does not move). The backlash should be located and eliminated.

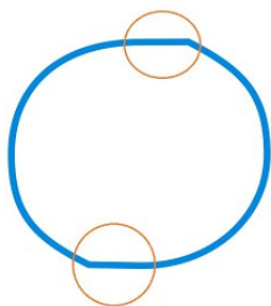

Backlash in Y axis



- Vibration of the machine when changing direction dynamically - for machines with too little stiffness, the torch can fall into resonance with sudden changes in direction - the dynamics of the machine should be reduced, or the structure should be stiffened.

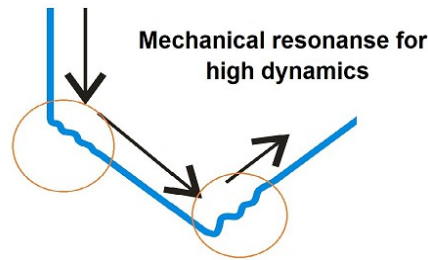

- in case the quality is bad even when drawing and not cutting, the user should check under high magnification whether the imported drawing has minor defects :



13.9 Inputs - Problems - Stopping the machine

Inputs like E-Stop or Home X Y Z (Limits) stop the machine even if there is a very short signal on their input which can be caused to stop by too high interference etc. in order to make sure if this is the cause of the problem you can unplug the input plugs before starting work.

In order to verify the correct operation of the sensors, check the input lights in the electronics tab to see if they are consistent with the activation of the sensors.

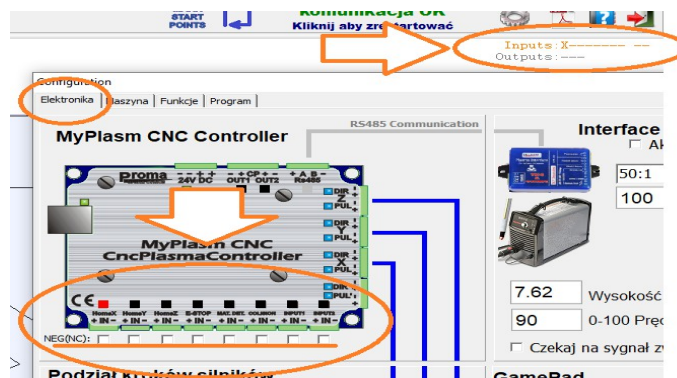

For problems beyond those described in the operating and assembly/installation manuals, contact the system manufacturer

<http://Proma-Elektronika.com> email: kontakt@proma-elektronika.pl

Recommended WhatsApp technical support contact : +48 604 247 648