

Class D & E Driver's Guide



LOUISIANA OFFICE OF MOTOR VEHICLES

Message from the Commissioner

“Welcome to driving in Louisiana.”

I am pleased to present the Louisiana Driver’s Guide to our new and current drivers.

This guide is designed to provide you with the rules of the road, knowledge to assist you in making better driving decisions and valuable information on safety and sharing the road with others. It is incumbent upon you, the driver, to respect all traffic laws and other drivers as well.

Driving is a vital part of life. It provides you with a means of attaining the necessities of daily living as well as providing you with the added convenience to move about at leisure. The driving experience, however, is a privilege and comes with great responsibilities.

Please strive to become a safe and dependable driver to ensure that this privilege is not lost.

Driving, the same as life is a constant learning experience. The information contained in this guide, along with your experience and responsive actions while driving will assist in protecting you, your family, and other drivers.

This guide is not intended to be an official legal reference to the Louisiana traffic laws. It only highlights those laws, driving practices and procedures that you will use most often. It should be noted that the material in this guide is subject to change to comply with amended State and Federal legislations.

Remember to buckle up. Safety belts save lives.

Let’s work together to make Louisiana a safer place for all.

Karen G. St. Germain

Karen G. St. Germain
Commissioner



CHAPTER 1	1
GETTING A DRIVER'S LICENSE	1
WHO MUST HAVE A DRIVER'S LICENSE?	1
CLASSES OF LICENSE	1
IDENTIFICATION REQUIREMENTS	2
GRADUATED LICENSING PROGRAM.....	6
DRIVER'S LICENSE TESTS	8
REVOCAION OF YOUR LICENSE	12
CHAPTER 2.....	17
HIGHWAY TRANSPORTATION SYSTEM.....	17
MAKE UP OF A COMPLEX SYSTEM.....	17
THREE MAIN COMPONENTS.....	17
NUMBER AND TYPES OF HIGHWAYS	20
CHAPTER 3.....	22
SIGNS, TRAFFIC LIGHTS, AND PAVEMENT MARKINGS.....	22
TRAFFIC SIGNS.....	22
TRAFFIC SIGNALS.....	33
LANE MARKINGS.....	34
CHAPTER 4	38
BASIC DRIVING AND SAFETY	38
USE OF SAFETY BELTS.....	39
PREPARING TO DRIVE	44
DRIVING HABITS.....	47
STEERING METHODS	49
SEASONAL CHANGES AND HOW THEY AFFECT DRIVING	51
CHAPTER 5.....	54
SAFE DRIVING HABITS	54
DEFENSIVE DRIVING TECHNIQUES.....	55
ILLNESS AND DRIVING.....	58
AGGRESSIVE DRIVING/ROAD RAGE	59
LOOKING AND SCANNING AHEAD	61
FOLLOWING DISTANCES.....	65
SAFETY TIPS ON PASSING	71

NIGHT DRIVING.....	73
SHARING THE ROAD WITH BICYCLES.....	78
SHARING THE ROAD WITH MOTORCYCLES.....	80
SHARING THE ROAD WITH BIG TRUCKS.....	81
CHAPTER 6.....	85
TRAFFIC LAWS AND REGULATIONS.....	85
RAILROAD GRADE CROSSING.....	94
OTHER LAWS YOU SHOULD KNOW.....	97
AUTOMOBILE INSURANCE FRAUD.....	100
TIPS TO PREVENT VEHICLE REPAIR FRAUD.....	100
TIPS TO AVOID BECOMING A VICTIM OF A STAGED AUTOMOBILE ACCIDENT.....	100
TIPS TO PREVENT AUTOMOBILE THEFT – “PARK SMART”.....	101
CHAPTER 7.....	102
INTERSTATE DRIVING AND RURAL ROADS.....	102
GENERAL INTERSTATE DRIVING.....	102
RURAL ROADS.....	105
SLOW MOVING VEHICLES.....	107
TRIP PLANNING.....	110
CHAPTER 8.....	112
DRIVING HAZARDS AND EMERGENCIES.....	112
DISTRACTED DRIVING.....	112
AVOIDING COLLISIONS.....	114
PROTECTING YOURSELF IN A CRASH.....	116
OTHER VEHICLE EMERGENCIES.....	117
DRIVING IN ADVERSE WEATHER.....	121
CHAPTER 9.....	124
DRIVING OFFENSES.....	124
ALCOHOL.....	124
LOSING YOUR DRIVING PRIVILEGES.....	129
CHAPTER 10.....	130
GENERAL INFORMATION FOR CLASS D “CHAUFFEUR’S” LICENSE.....	130
USING THE AIR BRAKES.....	134
CHAPTER 10–A.....	135

TRAILER SAFETY	135
CHAPTER 11.....	137
MOTOR VEHICLE REGISTRATION AND TITLE	137
NEW VEHICLES.....	137
USED VEHICLES.....	137
NEW RESIDENTS	138
PROOF OF INSURANCE.....	138
RENEWALS	138
MOTOR VEHICLE INSPECTION STICKER.....	139
FEES.....	139

CHAPTER 1

GETTING A DRIVER'S LICENSE

Driving is a privilege, not a right! You must earn that privilege and work to keep it. Your driver's license carries with it a great responsibility to be courteous to other drivers on the roadways and to follow state and federal motoring laws. When you slide behind the wheel of a motor vehicle, you take responsibility for the lives of people around you. There are many laws that govern a driver's responsibility. You must become familiar with these laws and obey and respect them to keep your license. For many, driving may seem almost automatic.

This assumption is incorrect. Driving is a complex activity mastered over time that should not be taken for granted.



WHO MUST HAVE A DRIVER'S LICENSE?

You must have a Louisiana driver's license if you are a resident of Louisiana and want to drive a motor vehicle on public streets and highways. Always carry your license with you when driving. You are required to show your license to any law enforcement officer or any officer who may ask to see it. New residents have 30 days from the time residency is established to obtain a Louisiana license.

Exceptions:

The following people are NOT required to obtain a Louisiana driver's license:

- Non-residents who possess a valid license issued by another state. You are permitted to drive in this state for a period of 90 days.
- Non-resident students who possess both a valid driver's license issued by their home state and a current student ID card.
- Anyone operating a farm tractor, farm implements, or road machinery temporarily on the highway.
- Members of the Armed Forces driving a U.S. government vehicle while on official duty.
- Resident members of the Armed Forces or resident military dependents possessing a valid driver's license from their home state.

CLASSES OF LICENSE

The class of driver's license you will need depends on the type of vehicle you plan to drive and if you are employed for the principal purpose of driving. This manual applies only to class "D" and "E" drivers' licenses.

CLASSES "A", "B", and "C" - Commercial Drivers' Licenses (CDL) are generally required for drivers of large cargo trucks, commercial passenger vehicles or for the commercial transportation of hazardous materials. To determine if you need a class "A", "B", or "C" license, please refer to the Commercial Driver's License manual for more information.

CLASS "D" - Permits the operation of any single vehicle used in commerce having a gross vehicle weight rating of 10,001 pounds or more but less than 26,001 pounds or any such vehicle towing a vehicle not in excess of 10,000 pounds gross vehicle weight rating, and not utilized for the transportation of hazardous materials. NOTE: As long as the combined gross vehicle weight rating (truck and trailer) is less than 26,001 pounds, you can operate with Class "D". A class "D" license may be used for transportation of passengers for hire or fee provided the usage thereof

does not fall within the definition of vehicles in classes “A”, “B”, or “C”. A class “D” allows for operation of those vehicles in the class “E” category.

CLASS “E” - Permits the operation of any single motor vehicle under 10,001 pounds, recreational vehicles and certain farm use vehicles not defined as commercial vehicle.

Note: If you are driving interstate commerce, you must also meet Department of Transportation (DOT) physical standards. This matter should be discussed with your employer.

FEES FOR DRIVER'S LICENSE AND IDENTIFICATION CARD (R.S. 32: 412, 412-1)					
Type:	Fee	Handling Fee	Service Fee	Total	Term
Class E	\$20.25	\$12.00	\$0 - 6	\$32.25	6 Years
Class E (70+)	\$6.75	\$12.00	\$0 - 6	\$18.75	6 Years
Class D	\$42.75	\$12.00	\$0 - 6	\$54.75	6 Years
Class D (Orleans)	\$54.00	\$12.00	\$0 - 6	\$66.00	6 Years
Class D (70+)	\$22.13	\$12.00	\$0 - 6	\$34.13	6 Years
Class D (70+) (Orleans)	\$27.75	\$12.00	\$0 - 6	\$39.75	6 Years
Learners Permit	\$20.25	\$12.00	\$0 - 6	\$32.25	6 Years
Motorcycle Endorsement	\$12.00	\$12.00	\$0 - 6	\$20.00	Maintain current expiration
Duplicate License	\$5.00	\$12.00	\$0 - 6	\$17.00	Maintain current expiration
Delinquent Fee	\$15.00			\$15.00	
Delinquent Fee (70+)	\$0.00			\$0.00	
ID Card	\$10.00	\$12.00	\$0 - 6	\$22.00	4 Years
ID Card (60+)	\$0.00	\$0.00	\$0 - 6	\$0.00	Lifetime
ID Card (≤ 15)	\$3.00/\$5.00	\$8.00	\$0 - 6	\$11.00 /13.00	2 Years /4 Years
Duplicate ID Card	\$5.00	\$8.00	\$0 - 6	\$16.00	

Some offices charge an additional service fee ranging from \$.50 to \$6.00. There is a \$12.00 handling fee, (except for identification cards and duplicate identification cards for applicants 60 and older). You may view our web-site (www.expresslane.org) or call 225-925-6146 to verify fees.

IDENTIFICATION REQUIREMENTS

All Louisiana driver's license and identification cards must be issued in the applicant's full legal name. All documents must be original or certified copies from the department of record. Photocopies are not acceptable whether notarized or not.

FIRST TIME APPLICANTS

Applicants will be required to provide one of the following combinations:

- One primary and two secondary documents OR
- Two primary documents OR
- If an applicant has a Louisiana identification card with a photo which clearly identifies the applicant and the Social Security Number is part of the file, additional identification is not required.

ADDITIONAL REQUIREMENTS FOR APPLICANTS SEVENTEEN AND UNDER

- The signature of the custodial parent or legal guardian is required for the issuance of any

license (including first time applications, duplicates and changing restrictions).

- Identification must be presented by the minor and the parent or guardian.
- Only the domiciliary parent may sign if joint custody has been awarded.
- Custodial documents must also be presented.

OUT-OF-STATE TRANSFERS

All applicants for a Louisiana driver's license are required to pass a vision exam administered by the Office of Motor Vehicles personnel at the time of application. New residents have 30 days from the time residency is established to obtain a Louisiana license. In order to make application, you must have a valid Louisiana address.

If you have a valid/expired out-of-state picture license, you must:

- ✓ surrender the out-of-state picture license. It is unlawful in Louisiana to have more than one driver's license.
- ✓ provide one primary and one secondary document.
- ✓ provide your social security number.
- ✓ provide proof of insurance on any personal vehicle you may have registered in Louisiana.

If you are not in possession of your out-of-state picture license, you must submit either a letter of clearance or an official driving record from your last state of license. This letter must include your personal information (name, date of birth, social security number, if applicable) as well as your driver's license number for that state. You must also meet all identification and social security requirements.

SOCIAL SECURITY REQUIREMENT

All applicants eligible for a social security number must provide the assigned number when applying for a driver's license. Although the social security number will not be displayed on the face of the license, that number must be entered in the department's internal records. If you do not have an assigned social security number, you must provide an official letter from the Social Security Administration specifying that no number has been assigned or that you are not eligible for issuance of a social security number.

In order to comply with the Military Selective Service Act, R.S. 32:40:1321(D)(1), the Social Security Number is required from all male US citizens or immigrants age 15 to 26 who apply for a driver's license or ID card. Failure to provide the number will result in the denial of issuance.

DRIVER EDUCATION

All applicants applying for their first driver's license issuance must furnish proof of driver education training as required by law. This driver education course may be taken at a public or private institution. Depending upon the age of the applicant, the requirements of the driver education course differ. The driver education course must be completed before making application for the driver's license.

SCHOOL ENROLLMENT FORM

All applicants applying for a driver's license or learner's permit, ages 15-17, must furnish proof of school enrollment. The enrollment form is obtained from the school the applicant is currently enrolled in and cannot be more than 90 days old.

IMMIGRANT ALIENS

In certain instances, the following documents may be substituted as primary and/or secondary documents depending on your immigration status. For more information, please contact your nearest Office of Motor Vehicles.

- I-551, if issued after 7/97 considered a primary document, social security verification (see social security requirement) and one secondary document **OR**
- I-551, if issued prior to 7/97 considered a secondary document), one primary document and social security verification (see social security requirement) **OR**
- the foreign passport stamped showing the I-94 has been surrendered for processing of an I-551, social security verification (see social security requirement) and I-688B, (work authorization card). If the stamp date in the passport is less than 9 months old, you are eligible for issuance of a driver's license. If the stamp date is older than 9 months, you are not eligible for issuance **OR**
- I-485, application for adjustment of status to lawful permanent resident, Social Security verification (see social security requirement) and one secondary document.

NOTE: I-151 resident alien cards are no longer acceptable for identification or status.

REFUGEES

You must present the Form I-94 indicating the refugee status and two secondary documents (see pages 6 & 7). If you have a passport, it should be presented along with your Employment Authorization Card. An original "Refugee Resettlement Program" letter with a color photo is valid for a period of 15 days from the date of issue.

NON-IMMIGRANT ALIENS

You will be required to provide the following:

- Foreign passport with I-94 stamped showing status with USCIS
- Social security verification (see social security requirement)
- Secondary document

Student non-immigrants (F-1, J-1, and M-1) must present the I-20 (lists the school, length of the program, a contact person and phone number of the student representative at the school). Some non-immigrant aliens or refugees may be denied issuance of a driver's license or identification card based on USCIS status and duration of status. In order to be issued a driver's license or identification card, there must be AT LEAST 180 DAYS remaining on your VISA/I-94 to be considered for issuance. If there are fewer than 180 days remaining, you will be denied. If you are not a Louisiana resident, you are not eligible for a driver's license or identification card.

AGE REQUIREMENT (R.S. 32:408)

Class D - Minimum seventeen (17) years of age.

Class E - Minimum fifteen (15) years of age for a learner's permit; must complete all stages of the Graduated Licensing Program.

Class A, B or C - Minimum age eighteen (18) (travel intra-state only, no hauling of hazardous materials); minimum age twenty-one (21) to travel interstate or obtain a hazardous material endorsement.

ACCEPTABLE PRIMARY DOCUMENTS (ONLY ORIGINAL DOCUMENTS ARE ACCEPTED):

Birth Certificate

- Original certificate of birth
- Certified copy of birth certificate (long form) and Birth Card (short form) does not require a seal
- Birth registration card or certificate issued by a state or county Bureau of Vital Statistics
- Certificate of Birth Abroad issued by the US Department of State.
- Certificate of Naturalization
- Native American tribal document

Passport

- US Passport book or Passport Card
- Applicants 17 and under must also present a certified birth certificate or documentation proving custody/legal guardianship
 - Foreign Passport (Must be appropriately stamped and accompanied by proper immigration documents)

Immigrants / non-immigrants

- Permanent Resident Card (I-551)
- Department of Homeland Security Refugee travel document (I-571)
- Department of Homeland Security Permit to reenter the United States (I-327)

Military

- Current US ID card
- Dependent ID card
- Draft record
- DD-214
- Selective Service Notification
- US Coast Guard Merchant Mariner Card

SECONDARY DOCUMENTS

NOTE: Name on secondary documents should coincide with name on primary documents.

Out-of-state driver's license / identification card

- DL or ID card issued by a state motor vehicle department with a photo that clearly identifies the individual.
- An official driving record from the last state of issuance is required if the applicant has lost his out-of-state license.
- A foreign driver's license must be accompanied by proper immigration documents.

Social Security Number verification

- Social security card
- Official verification of the social security number from the Social Security Administration or verbal verification

Identification Card (with photo)

- Louisiana college or university
- Louisiana middle or high school
- Law enforcement officer's ID
- Employment ID card (major corporations, hospitals, governmental agencies)
- ID cards issued by federal, state, local governmental agencies
- LA Department of Public Safety & Corrections prison or parish ID card
- TWIC (Transportation Worker Identification Credential)
- Employment Authorization Document I-766 issued by DHS
- Original Refugee Resettlement Program letter. This document will include the agency director's signature with a raised seal and is valid for 15 days from issuance.

Educational diploma / certificate / license

- High school, college or university
- High school yearbook photo
- School records or at least 2 report cards from separate years
- Original or certified professional degree or license
- Driver Education Certificate

Medical

- Medicare / Medicaid card
- Medical eligibility card.
- CDL Medical form / card

Miscellaneous documents

- Original adoption papers
- Baptismal certificate
- Official deed or title to property in Louisiana, including burial plots
- Vehicle registration or certificate of title of vehicle in applicant's name
- Motor vehicle lien instrument
- Local utility statements showing name and address of the applicant or a receipt indicating utilities have been turned on
- Insurance policy (health, home, life, auto)
- One-payroll stub (printed)
- W-2 forms for 2 years
- Prison release documents or letter from probation officer
- Letter of verification / introduction from another state agency responsible for placement of deprived / impaired individuals (i.e., Blind Services)
- CDL driver's log book

GRADUATED LICENSING PROGRAM

In 1996, Florida became the first state to implement the Graduated Licensing Program. On January 1, 1998, Louisiana followed by implementing a graduated licensing program as well. It is known as the R.Y.A.N ACT (Reduce Youth Accidents Now) and was named for a fifteen year old, Ryan Lee, who lost his life in a traffic accident a few months after being licensed. All states in the U.S. now have a version of the Graduated Licensing Program. Statistics indicate this program for teenage drivers has served to decrease the number of traffic deaths and injuries in the teenage driving group.

While teen driver crashes and casualties have decreased in the past decade, and in spite of attention to the issue, teens are still considered high risk drivers. Unfortunately, motor vehicle crashes remain the number one cause of death among teens in the United States. Per mile driven, teenage drivers

ages 16-19 are four times more likely to crash than older drivers. These high crash rates for teens, particularly 16-year-olds are related to driver inexperience and driver immaturity.

Driving experience must be built up sooner or later regardless of when a person starts to drive. But, initial driving experience can be limited to lower risk situations (e.g., daylight and limiting the number of teen passengers) under a Graduated Licensing Program which has three stages of licensure:

1. A learner's permit that allows the holder to drive only while supervised by a fully licensed driver.
2. An intermediate license that allows unsupervised driving under certain restrictions.
3. A full license.

STAGE 1: LEARNER'S PERMIT

1. Must be a minimum of fifteen (15) years of age.
2. Must complete thirty (30) hours classroom instruction and eight (8) hours behind-the-wheel driving instruction.
3. Must pass vision exam and knowledge exam with at least 80% accuracy.
4. Is authorized to drive only with a licensed adult at least twenty-one (21) years of age or sibling at least eighteen (18) years of age.
5. Must maintain learner's license for a minimum of one hundred eighty (180) days and cannot advance to intermediate stage until attainment of sixteenth (16th) birthday.

Note: Upgrading from Permit to Intermediate (age 16):

Effective January 1, 2011, no applicant shall be issued a Class "E" intermediate license unless a signed statement by the parent or legal guardian is provided to the department attesting that the applicant has a minimum of fifty (50) hours of behind-the-wheel driving experience with a licensed parent, guardian, or adult at least twenty-one (21) years of age. At least fifteen (15) of these hours must be night time driving.

STAGE 2: INTERMEDIATE LICENSE

1. Must have completed STAGE 1.
2. Must be a minimum of sixteen (16) years of age.
3. Must pass the road skills driving test with at least 80% accuracy.
4. Is prohibited from driving between the hours of 11:00 p.m. and 5:00 a.m., unless accompanied by a licensed adult at least twenty-one (21) years of age or sibling at least eighteen (18) years of age. Additionally, between the hours of 6:00 p.m. and 5:00 a.m., an intermediate licensee may not transport more than one passenger under the age of twenty-one (21) years of age that is not a member of the immediate family.
5. Must be maintained until seventeenth (17th) birthday.

STAGE 3: FULL LICENSE

1. Must successfully complete STAGES 1 **AND** 2 **OR**
2. Must be at least seventeen (17) years of age prior to application for first license.

NOTE: Effective 08/01/2012, applicants eighteen (18) years of age or above who have not entered the graduated licensing program may apply for full Class E license or a learner's permit upon completion of a thirty-eight (38) hour driver's education course or a six (6) hour pre-licensing course and an eight hour behind-the-wheel course. An out-of-state applicant, sixteen (16) years of age who has had a license or permit for a minimum of one hundred eighty (180) days may be eligible to bypass the learner's permit stage and be issued an intermediate license.

PROOF OF INSURANCE

Any vehicle used upon the highways of Louisiana must be insured by liability insurance or other allowable substitute. You must submit such proof for vehicles you own at the time of license issuance. In order for your insurance proof to be acceptable by law enforcement and the Office of Motor Vehicles it must contain the name of the company, the policy number, the effective dates, the vehicle description, the name of the insured party, and the NAIC number. (The NAIC number indicates to law enforcement the company is authorized to conduct business in Louisiana.) By law, your insurance card must be in the vehicle at all times as evidence of insurance.

DRIVER'S LICENSE TESTS

The following tests may be given when you apply for a driver's license:

- Vision (eye exam)
- Knowledge of traffic laws, signs, and signals
- Road skills (outside driving test)

VISION TEST

Your eyes will be screened when you apply for or renew your driver's license or learner's permit. The vision screening is not a medical exam. Because seeing well is so critical to safe driving, you should have your eyes checked regularly. The screening will determine if your vision meets minimum standards (20/40) for safe driving. If you fail the eye exam, you will be given a vision report which is to be completed by a vision specialist of your choice. If you need corrective lenses in order to pass the vision exam, your license will indicate that you are required to wear them while driving. Your license will display an "01" for this restriction. This restriction removed after having laser surgery to correct your vision. You must visit an OMV office and pass the vision screening without wearing glasses or contact lenses.

KNOWLEDGE TEST

All first time applicants must successfully pass the knowledge test confirming your understanding of traffic signs and signals, as well as safe driving practices and Louisiana laws relative to driving. The test contains multiple choice questions that are taken from the information contained in this manual. The exam is given on a computer in most offices and you must correctly answer 80 percent of these questions to receive a passing score. Proper identification is required each time the test is taken.

Tips To Pass The Written Test:

Read through the driver's manual at least three times. Focus on memorizing any numeric information in the manual: lengths, distances, measurements, etc. Trust your gut instinct. Go with the "safest sounding" answer. Read through the full question and every possible answer before choosing your answer. Arrive at the licensing office for your test at least an hour prior to the time the last test can be given. Be sure to arrive in the office to give sufficient time for you to concentrate on each question and answer.



ROAD SKILLS (DRIVING) TEST

The road skills test is available through the Office of Motor Vehicles or certified Third Party Tester providers. All Third Party Testers are certified through the Office of Motor Vehicles. A fee will be assessed when using the Third Party Testers for the skills test. View our web-site (www.expresslane.org) for a list of certified providers in your area. For road skills (driving) tests administered at the Office of Motor Vehicles, you will be required to provide the vehicle used in testing. The vehicle must be in safe driving condition, pass a safety inspection, and have a valid inspection sticker, current license plate and registration document.

THE EXAMINER CANNOT GIVE THE DRIVING TEST UNLESS YOUR VEHICLE IS SAFETY INSPECTED AND IS LEGALLY EQUIPPED

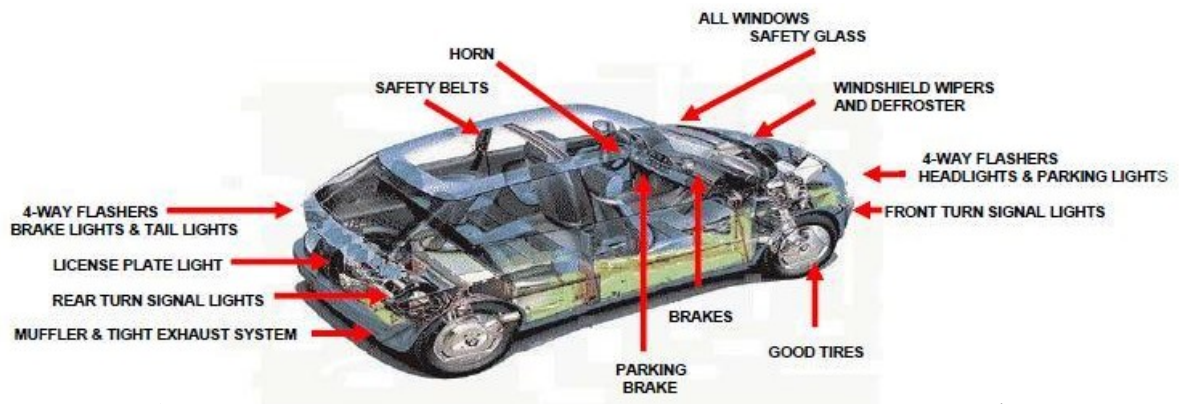

NOTE: SPEEDOMETER MUST BE OPERATIONAL.

All vehicles manufactured after 1964 must be equipped with functional seat belts.

For a fee, Third Party Testers may provide a vehicle for the road skills test. Contact the Third Party Tester for information regarding the vehicle utilized for the test. If you will be using your own vehicle, you will be asked to perform a safety equipment check of your vehicle before you can begin the road test. It must have all the necessary equipment and be in safe working condition. In addition, you must present proof of liability insurance on the vehicle being used for the test. Only the applicant, the OMV staffer, and the interpreter (if applicable) are permitted in the vehicle during the road skills test. Loose objects that could break or cause injury must be removed from the vehicle prior to the road test.

The road skills test consists of your ability to control the vehicle and a driving performance test. You will be tested on the rules of the road and your ability to drive a motor vehicle safely under normal traffic conditions. The examiner will evaluate your awareness of risks and your reaction to them. You will be evaluated on your observation skills at intersections, when changing lanes, and in other situations. You will not be asked to do anything illegal during the test.

The following driving skills are most important as they will demonstrate your ability to safely operate your vehicle in ordinary traffic conditions. You will be graded on:

Backing	Yielding right of way	Approach to Corner
Keeping in Lane	Parking between cars	Use of Signals
Following others	Attention	Turning
Response to Signs and Signals		

The examiner will direct you to make certain stops, starts, turns and other maneuvers during the test. You will not be asked to do anything contrary to motor vehicle laws or safe driving practices.

The examiner will not try to trick you into making an error. Points will be deducted for driving errors made during the test.

You will fail the skills test for any of the following:

- A violation of any traffic law
- Any dangerous action/incident
- Lack of cooperation or refusal to follow instructions
- Collision
- Cumulative minor mistakes

Upon completion of the road skills (driving) test, you will be advised of your errors and what maneuvers you need to improve, if any. If you fail the test and you don't currently have a permit, you may be issued one so you can practice. You can return at a later date to re-test.

NOTE: If you are a minor making application for a license, a custodial or domiciliary parent; tutor; or legal guardian must accompany you and present his identification, sign your application, and provide proof that the vehicle to be used for the road skills (driving) test is insured.

REMEMBER, road skills (driving) tests administered at the Office of Motor Vehicles are suspended during inclement weather.

LICENSE RENEWALS

Your driver's license will expire six years from your nearest birthday. Licenses may be renewed anytime within 180 days before the expiration date. You must pass the vision exam before your license is renewed. Once your license is issued, please verify your information is correct before leaving. If you do not receive a mail-in renewal invitation, you must visit the local office for renewal issuance.

The expiration date for immigrants/non-immigrants/refugees may vary in accordance with INS status. The Louisiana driver's license of members of the armed forces/peace corps and their dependents who serve outside the state of Louisiana shall remain valid for sixty (60) days after discharge, provided the license was valid (not expired, suspended or revoked) upon entrance to service. The license will be considered expired/delinquent on the 61st day after discharge. The last license issued and proof of discharge will be accepted to renew the license.

RENEWAL BY MAIL OR INTERNET

If you are a Louisiana resident under the age of seventy (70) with a class "D" or "E" license, you may be selected to renew your license by mail or internet. If you are selected, you will receive a renewal invitation and application with instructions. If you choose to renew by mail or internet, a reconstructed driver's license will be mailed to your address. You will not receive an invitation to renew by mail or internet two consecutive renewal cycles. You still have the option to visit your local Office of Motor Vehicles and renew your license in person.

CHANGE OF ADDRESS

Louisiana law requires you to correct the address on your license within 10 days after a move. Please visit your local motor vehicle office to have the corrected license issued at no charge. Failure to change your address may result in a violation if you are stopped by law enforcement.

CHANGE OF NAME

You may change your name on your license by presenting to the Office of Motor Vehicles a certified copy of a state approved marriage license, certified birth certificate (if you wish to go back to your birth name), or a certified copy of a court order authorizing a name change. Additional documentation may be required in a given situation. If you change your name between license renewals, a duplicate license fee will be charged.

DUPLICATE LICENSE

If your license is lost, stolen or destroyed, you may apply for a duplicate at any motor vehicle office. You must apply in person. Proof of identification may be required. A minor applying for a duplicate must have a custodial or domiciliary parent, tutor, or legal guardian physically appear with proper identification and custodial documents to sign the application. In the case of joint custody, only the domiciliary parent may sign for the minor child. Proof of current liability insurance is required on any registered vehicle.

LICENSE RESTRICTIONS

The Office of Motor Vehicles and/or the Court is authorized to impose restrictions on licenses. Any restrictions placed on you to operate a motor vehicle will appear on your driver's license. A violation of a restriction is a violation of the law and may result in the suspension of your driving privileges.

MEDICAL REPORTS REQUIRED

Every physically impaired person and persons over the age of 60 applying for a license for the first time must submit a detailed report from a physician and/or vision specialist. The required form must be obtained from the Office of Motor Vehicles. The report will state the severity of any visual or physical condition which might impair your ability to safely operate a motor vehicle. The Office of Motor Vehicles may require anyone to submit a medical and/or visual report. You may also be subject to written and/or road skills testing.

YOUR DRIVING RECORD

The Office of Motor Vehicles keeps a public record of all your traffic convictions and collisions for five years. Convictions for DWI are maintained for 10 years. This includes traffic convictions received in other states.

PERSONAL IDENTIFICATION CARDS

Any Louisiana resident may apply for an identification card. It is widely accepted as proof of identity, but does not give you the privilege to drive. To get a personal ID card, you must meet the identification requirements (see pages 5-6) and have a valid Louisiana residence address.

PERSONS NOT ELIGIBLE FOR A LICENSE

- License is revoked
- Have not passed driver's education course or pre-licensing course
- Have not successfully passed the written and/or skills test
- Under the age of 15

REVOCATION OF YOUR LICENSE

In order to keep your driver license and not have it revoked, you must remain a safe and responsible driver. You must drive safely at all times. You can lose your driving privilege for the following:

- Using a wireless/cellular communication device while operating a motor vehicle if the driver holds a Class 'E' learners or intermediate operator's license, or is under the age of 18, or has been issued a first time operator's license that is within one year from the original issue date, excluding out of state transfers.
 - Using a text messaging communication device while operating a motor vehicle.
 - Altering information on the license.
 - Unlawful use of a driver's license.
 - Making a false statement or concealing a material fact on an application for a driver's license.
 - Failure to stop and render assistance at a collision in which you were involved that results in the injury or death of a person.
 - Conviction of driving while intoxicated (DWI).
 - Refusal to take an alcohol analysis test when arrested for DWI, or after submitting to the test
 - In which the results show a BAC level of 0.08% or more for those 21 years of age or older or 0.02 % or more for those younger than 21 years of age.
 - Failure to stop for a school bus loading or unloading children.
 - Manslaughter or negligent homicide resulting from the operation of a motor vehicle.
 - Any felony committed while operating a motor vehicle.
 - Three convictions of reckless driving committed within a 12 month period.
 - Failure to answer a traffic law charge.
 - Driving in violation of a driver's license restriction.
 - Failure to comply with the financial responsibility law when required.
 - Committing an offense in another state which, if committed in this state, would be grounds for suspension or revocation.
 - Driving with a suspended driver's license.
 - Failure to pay child support
 - Failure to pay state income taxes
 - Withdrawing from school prior to graduation if you are 15 but less than 18 years of age or have been determined to be habitually absent or tardy.
-

Don't put it down



Keep Louisiana Beautiful



KeepLouisianaBeautiful.org

LITTER LAW AND STATS

Louisiana spends more than \$40 million a year to clean up our highways. In 2004 alone, state and sheriff cleanup crews picked up an estimated 450,000 bags (20,000 miles) of trash in our state.

LITTERING

Whether accidental or deliberate, littering is against the law. Depending on the nature and severity of the littering, you can face either civil or criminal prosecution. According to Louisiana R.S.30:2531-2531.3, penalties for conviction range from a \$50 fine plus 8 hours community service picking up litter to a \$5,000 fine, one year driver's license suspension, 30 days in jail AND 100 hours of community service. The driver is responsible for all litter coming from the vehicle's interior or truck bed, and the driver can be cited for littering committed by the passengers in his/her vehicle. Along roadways, motorists and pedestrians are the biggest contributors to litter.

Tobacco products, mostly cigarette butts, are the most littered item along Louisiana roadways. Many individuals believe that cigarette butts are biodegradable. **This is incorrect.** While some parts of the cigarette usually decompose in one year, other parts never do because the filter is made of a type of acetate that never fully breaks down. Worst yet, the cigarette butt that is thrown on the ground will eventually find its way into the ocean or some other body of water. A recent cleanup of coastal shorelines by volunteers found that 80% of the collected litter was washed from land into the water. Cigarettes and cigarette butts accounted for a whopping 25% of the total collected. Cigarettes and cigarette butts also contain many harmful chemicals which leak into the environment. To many people, a cigarette butt may seem like a small thing, but with several trillion butts discarded every year, toxic chemicals add up, and the damage to the environment is multiplied many times over.

Another problem often seen is the litter from packaging and beverage containers. This includes fast food, snacks, tobacco, or other product packaging, and soft drink and beer containers.

Storm drains are a trap for litter that collects from streets and sidewalks. These are located in gutters and are designed to drain excess rainfall from paved streets and parking lots. Because storm drains eventually lead to waterways, litter near storm drains can potentially contaminate our water. This causes litter to first be a problem on land and then later in our water.

The presence of litter in a community takes its toll on the quality of life, property values, and housing prices. Besides the environmental impact that litter imposes, there are also economic consequences. Businesses pay about 80% of the cost to clean up litter with the government funding the remainder. Many communities depend on volunteers to clean up litter. Research studies have shown that heavily littered areas are more likely to be targeted for crime and vandalism. Individuals are more likely to litter in a littered area. Once there, litter attracts more litter. This cycle continues unless and until we change our minds about the way we think about litter.

Individual attitudes can change the way we think about litter. On average, one in every five individuals is a litterer with most of the behavior being a conscious act. This includes dropping the item, flicking or flinging it away, or just leaving it in on the ground, table, bench or ledge. Studies also show that age, and not gender, is a significant factor in littering. Those under 30 are more likely to litter than those who are older.

A clean community discourages litter and improves overall community quality of life. It is the responsibility of every individual to care about his neighborhood, park, roadway, or other public space. Don't just believe that someone will pick up after you when you litter. Start with these actions:

- ✓ Choose not to litter. Make the commitment now to join with others not to spread litter.
- ✓ Remind others not to litter and explain why.
- ✓ Get a litter bag for your car or portable ash receptacles to share.
- ✓ Volunteer in your community. Help prevent and clean up litter-from cigarette butts to illegal dumps.
- ✓ If you see litter, pick it up.
- ✓ Become part of "Keep Louisiana Beautiful." With all of us working together, we can make a difference.

Citizens may report litterers by calling 1-888-LITRBUG, 24 hours a day, 7 days a week. This hotline is maintained by the Louisiana Department of Wildlife and Fisheries. Cingular Wireless customers in south Louisiana area may call *LITTER. The offender will receive a letter from DEQ reminding him/her that littering is illegal and asking for help in keeping Louisiana clean. You can also post information regarding acts of litter at Litter-Bug.org.



For more information concerning Louisiana's litter abatement programs, visit the websites:

www.keeplouisianabeautiful.org and www.deq.state.la.us/assistance/litter/index/htm

ORGAN DONATION



Thousands of people are waiting for a lifesaving or life enhancing organ, tissue or cornea transplant. When you apply for a driver's permit, driver's license, or state ID card, you will be asked whether or not you wish to register as an organ, eye and tissue donor. Your designation will be marked on the front of your license or ID card with a red heart.

If you register through the OMV in person, your wishes will be indicated in the registry. You may also register online at DonatelifeLA.org. Either method is legal documentation of your desire to save lives.

Louisiana's registry allows citizens to make legally binding decisions to be donors. Family consent is required only for minors. This makes it especially important for you to have a discussion with your family about your wishes regarding donation.

Organs and tissues that can be donated include heart, lungs, liver, kidney, pancreas, intestines, skin, heart valves, bone and connective tissue. For eye donation, the whole eye or

the cornea can be donated. Organs are distributed for transplantation on a patient-based, fair, equitable system. Donors are treated with the greatest care and dignity throughout the donation process.

Here is some information to help you make an informed decision:

- ♥ Louisiana's registry allows citizens to make legally binding decisions to become donors. Drivers under the age of 17 can participate in this program and register their intent.
- ♥ **Anyone** can be a potential donor regardless of age, race, or medical history.
- ♥ You have the ability to **save 9 lives** and heal the lives of up to **50** additional people through tissue donation.
- ♥ The level of medical care you receive in any hospital is **not affected** by your choice to register as an organ, eye and tissue donor. The recovery team is only called in after all attempts have been made to save your life.
- ♥ **All major religions approve** of organ, eye, and tissue donation and see it as an unselfish act of charity.
- ♥ There is no change in the appearance of the body after donation and no interference in funeral plans, including an open casket.
- ♥ There is **no cost** or payment to your family or your estate when you become a donor.
- ♥ It is **illegal to buy or sell organs** in the United States.
- ♥ All patients on the waiting list throughout the country are registered with the United Network for Organ Sharing (UNOS) computer network. Organs are placed based on blood type, size, weight, severity of illness, time on the waiting list, and geography. **It is illegal to allocate organs based on fame, wealth, citizenship or political power.**
- ♥ Transplantation is a medically accepted treatment and is not experimental. **Organ donation is not a search for the cure – it is the cure!**

Today there are nearly 117,000 patients waiting for this life saving gift; over 1,800 here in Louisiana. Every day 18 people die waiting for an organ, and every 13 minutes another name is added to the national waiting list. Choose to be an organ and tissue donor and tell your family about your decision.

For more information visit DonateLifeLA.org.



VOTER REGISTRATION PROGRAM

The National Voter Registration Act of 1993 (NVRA), also known as **The Motor Voter Act**, was signed into effect by President Bill Clinton in 1993. This legislation requires state governments to allow for registration by qualifying voters whenever they apply for or renew their driver's license, thereby consolidating the driver's application and voter registration processes. Simply make it known to personnel at the Office of Motor Vehicles that you wish to register to voter when you apply for a license or a renewal of your driver's license.

You may also pick up a mail-in voter's registration form from your local OMV. Please verify the form for accuracy and sign it in the space provided before it is turned in or mailed.

If you choose to register to vote while at the OMV, your application will be submitted electronically to the Louisiana Secretary of State. If you do not receive confirmation within two (2) weeks, please contact your local Voter Registrar's Office.



For more information concerning your right to vote and the procedures for becoming a registered voter contact your nearest Voter Registrar's Office or visit the website of the Louisiana Secretary of State at www.sos.la.gov.



CHAPTER 2

HIGHWAY TRANSPORTATION SYSTEM

MAKE UP OF A COMPLEX SYSTEM

Today's society has become very mobile. The Highway Transportation System (HTS), a vast network of highways, streets and roads, has been built to accommodate the public and private vehicles that provide this mobility. The HTS is only about 100 years old. In 1902, only about 2300 cars were on the road and there was only about 150 miles of paved road. However, there were more than 17 million horses using the roadways. Now, there are about 230 million registered vehicles with 4 million miles of paved roads and horse travel has become a leisure activity. The goal of the HTS is to provide safe, rapid and efficient transportation of persons and goods to a desired destination, in an environmentally safe and sound fashion. From pedestrians to the largest transport vehicles, this system is shared by all. A multitude of safety professionals at the local, regional, and national levels are involved in legislating and providing a safe and efficient transportation environment. Each individual road user is the core of the safe and efficient operation of the HTS. The responsibility of each individual is to respect the rules of the system and cooperate with others.

As a nation, we rely on our vehicles for our daily needs. We spend at least half as much time stuck in traffic each year as we do going on an annual vacations. No matter where you live, commutes to school or work are getting longer and more snarled with traffic. Roadways have become the number one choice of moving people and goods. Trucks deliver food and other items to stores for us to buy and use. Sixty percent of freight is transported on the roads. Emergency vehicles such as fire trucks and police cars respond to emergencies by way of roads. Yet for all the advantages of motorized transportation, there is a big price to pay. Motor vehicle crashes are the leading cause of death among people ages 1-34 and the leading cause of injury for all age groups (in the US). And through it all, Americans love their cars and the freedom they offer.

America's system is one of the largest systems in the world with four million miles of public roads and roughly 594,000 bridges. Transit systems operate approximately 226,400 directional route miles, of which 216,620 are non-rail and 9,800 are rail route miles. Local governments own 75 percent of the nearly four million-mile roadway network, about half of the nation's bridges and manage 90 percent of the transit systems. Seventy-five percent of highway miles are in rural areas. The Highway Transportation System exists to provide a safe and efficient mechanism to move people and goods from one location to another. It is a complex system with many diverse elements.

THREE MAIN COMPONENTS

The Highway Transportation System consists of three major components:

- ❖ People – This consists of several different groups, including the drivers and passengers in the vehicles, pedestrians, construction workers, police officers, emergency personnel and children at play.
- ❖ Vehicles - Many types of vehicles utilize the HTS including; cars, trucks, vans, SUVs, large commercial trucks, buses, recreational vehicles, motorcycles, mopeds, farm vehicles, emergency vehicles, construction vehicles, bicycles, military vehicles, and

- pedestrians.
- ❖ Roads - Many types of roads make up the HTS including, interstates, U.S. highways, state highways, county roads, toll roads and parkways.

The Highway Transportation System is an IMPORTANT system to our way of life and to our economy in allowing:

- * personal and individual transportation
- * freedom to come and go as we wish
- * going to work, to shop, to school
- * social and recreation activities
- * choice and length of vacations

The HTS is important to the economy of our nation due relative to:

- ✓ manufacture of motor vehicles
- ✓ building and maintenance of highways
- ✓ motor carriers as transporters of goods, gasoline and tire industries
- ✓ travel and recreation industry
- ✓ automobile maintenance and repair industry

MANAGEMENT OF THE HIGHWAY TRANSPORTATION SYSTEM

There are six means of management of the Highway Transportation System:

1. The Department of Motor Vehicles regulates drivers licenses, truck weights and operators, license plates, fees registration, taxes, and titles to name a few of the items this branch of government controls.
2. Law enforcement agencies such as local city police, the highway patrol, and sheriff's departments as well as other enforcement agencies work together to help maintain safe travel.
3. The traffic courts located in various locals in the country help to assure proper enforcement of the law.
4. Engineering works in two ways. Highway engineering works to make our HTS the safest system in the world and vehicle engineering works to make vehicles safer and easier to operate.
5. The emergency response system and trauma centers in the U.S. work to reduce the losses causes by collisions both at the time of the crash and afterwards.
6. By educating the public with the use of public service announcements, high school driver education programs, truck driving schools, substance abuse instruction, and private driver education schools individuals can be better prepared and informed regarding the HTS. The goal of educating the public is to impart knowledge of the rules of the road; the basic skills involved in vehicle operation, and instill and reinforce attitudes consistent with safe driving. An educated and informed public will produce safer drivers and measurably lower crash rates.

TRAFFIC COLLISION COSTS

Vehicular collisions lead to tremendous social and economic costs. When someone is killed in a car crash, a whole range of people from family members to friends and acquaintances feel the terrible loss. Economically, in addition to lost wages, crash injuries contribute to expenses for medical care, emergency services, nursing-home care, rehabilitation, home modifications, insurance administration and property damage that amount to billions of dollars each year.

However, the biggest price society pays for transportation collisions is personal. Lives can change in an instant. Just imagine how parents feel when they get a phone call telling them that their child

has been injured or killed in a vehicle collision. Traffic collisions have become the number one cause of teenage deaths. In traffic, we judge ourselves by how safe the system is by the number of collisions and deaths per 100 million miles traveled. We are currently near 1.6 deaths per 100 million miles traveled. This is down from 4.7 deaths, 40 years ago. Most of this decrease is due to seat belts, airbags, and improved safety features in vehicles. Loosely translated this means that about 44,000 people die on our highway system each year. Millions more are injured and we spend hundreds of billions on this issue. The current statistics indicate that traffic collisions have become an epidemic. If automobile crashes were an illness, the CDC would be trying to figure out a cure.

- In 2011, there were more than 32,367 highway fatalities nationally. On a positive note, this number of traffic fatalities was down to the lowest since 1949 despite the fact that the number of miles driven by Americans has gone up.
- More than 2.3 million drivers and passengers were treated in emergency rooms as the result of being injured in motor vehicle crashes in 2009.
- The total economic cost of motor vehicle crashes in 2000 was \$231 billion. This is equal to \$820 for every person living in the U.S. Lost market productivity accounted for \$61 billion, while property damage accounted for \$59 billion. Medical expenses totaled \$33 billion and travel delay accounted for \$26 billion.

The Louisiana Department of Public Safety and Corrections has identified the five leading causes of motor vehicles crashes in Louisiana (2010) as:

1. Careless, and/or Reckless Operation
2. Failure to Yield
3. Following Too Closely
4. Speeding
5. Unknown/Unspecified

In 2010 fatalities, injuries, and property damage in Louisiana as a result of motor vehicle crashes cost on average each licensed driver in Louisiana \$1855.00. Each year, the current statistics can be obtained from <http://datareports.lsu.edu/>.

The HTS is often crowded. In the U.S., 88% of the population has a driver's license which translates to approximately 202 million drivers. At times 194 million drivers are on the roads in addition to 55 million pedestrians and bicyclists using the HTS. Add to this, no two users will be the same and the amount of variables is staggering. Each driver, pedestrian and bicyclist will all have different perspectives, needs and emotions as they operate on the roadways and use this system. With all of this traffic, it is inevitable for drivers and pedestrians to make mistakes and drive recklessly. That is why it is important to be able to anticipate and learn to cope with unsafe practices of others.

As you utilize the Highway Transportation System you will notice a wide variety of vehicles upon the roadways. Each of these vehicles has different handling, braking, speed control and performance capabilities. Another factor in how the vehicle performs is the condition of the vehicle. The equipment it has, the age of the vehicle and whether or not regular maintenance has been performed on the vehicle all affect its handling.

The drivers of each of these vehicles want safe, rapid and efficient use of the system. The size and speed of these vehicles sharing the same system can create real problems. All of these factors can affect the way you drive. Understanding the difference in the types of vehicles and how each performs is important to you as a driver. While you may never drive a large commercial

truck or a motorcycle, understanding other vehicles' capabilities is as important to you as knowing the traffic laws.

People who drive at unsafe speeds are a major hazard, particularly on freeways and expressways. This does not necessarily mean that these people are driving too fast. They may be driving under the posted speed limit, yet still too fast for existing weather, traffic conditions, or even their own physical health.

NUMBER AND TYPES OF HIGHWAYS

There are many different types of highways throughout the highway transportation system. The design of the highway is based on the anticipated volume and composition of the traffic utilizing the highway. This includes the lane width, shoulder width and type and width of the median area.

- **Parish Road:** A parish road is a road that is regulated and maintained by a certain parish.
- **State Highway:** A highway that is regulated by the state. Example - LA 1.
- **U.S. Highway:** A nationally regulated highway that is a predecessor to the Interstate Highway program that was adopted in 1926. Highways like US 1 and US 6 are examples.
- **Interstate Highways:** These highways were created by Dwight D. Eisenhower in the 50's. These are expressways that crisscross the country that carry large volumes of traffic. **EVEN** numbered highways go East and West. **ODD** numbered highways go North and South.
- **Expressways:** A national term that high volume roads are called. They are divided highways with at least 4 lanes; most in the country are commissioned as Interstates.
- **Freeways:** Same as expressways. This term is used out west, especially in California.
- **Toll ways:** A highway that collects tolls. Usually from tollbooths a couple miles apart on a highway.
- **Turnpikes:** Another type of a toll way. The main difference is that these roads collect tolls using a ticket system. You get a ticket when you get on the highway and you pay the ticket when you get off. The Pennsylvania Turnpike is the first modern turnpike in the country. Other examples are the Massachusetts turnpike, and the now defunct Connecticut Turnpike.
- **Parkway:** A divided highway that has lots of trees and plants around, usually very beautiful and scenic highways.
- **Divided Highways:** Highways with lanes going in the opposite directions divided by a median or some sort of barrier between them.
- **Other names for Divided Highways:** Skyways, Bee Lines, and Toll Roads
- **Limited Access Highway:** A highway where access is limited to signed exits.
- **Partial Access Highways:** A highway that allows access at other streets, probably at a stop light, though driveways and other forms of access are not allowed.
- **Full Access Highways:** Any road that is divided has driveways and any other type of access allowed.

Early American roads were built along trails. Most were designed with little or no thought for the future. Now engineers are carefully designing and thinking of routes that best fit everyone. The need for better and safer roads is a challenge for highway engineers. The engineers must design roads using scientific principles and standards. They have a large responsibility to ensure the safety of vehicles on the highways. Newer highways are designed with wider shoulders, gentle curves and grades in an effort to reduce the number of crashes. Reduction of roadside obstacles is necessary to reduce the severity of the injury if a vehicle leaves the highway.

IMPACT OF ROAD CONDITIONS ON DRIVING

Road conditions play a major role in the safe operation of vehicles. Good pavement conditions are important for traction and stopping quickly. When roadways are well-maintained drivers have a better chance of staying on the roadway. Swerving to avoid potholes, staying out of ruts and watching for shoulder drop offs are all hazards drivers face on poorly maintained roadways.

Weather can also impact the road conditions. Rain, even a drizzle, can cause a vehicle's tires to lose traction. Too much water on the road can cause a vehicle's tires to start skimming on the surface of the water instead of gripping the road. This condition is called hydroplaning. To help eliminate this hazard engineers design roadways to carry the water away quickly and construct the face of the pavement with grooves and rough texture to help tires maintain better traction and avoid skids.

Another recent innovation is electronic signs that post warnings about hazardous conditions such as fog, high winds or ice storms. In areas of the country where snow is common, engineers are designing roads that have areas beside them for snow storage. The snowplow comes through and pushes the snow to the curb or edge of the road.

The Federal Highway Administration (FHWA) is a federal agency that has the chief responsibility of improving roadway safety. The FHWA makes efforts to educate the public about roadway safety and find ways to reduce the number of fatalities on the highway.

To drive safely on the HTS you must follow many rules and laws. As you observe these rules you must know what traffic lights and signs mean. Traffic lights, signs and "right of way" devices and rules tell you what to do or when to stop at an intersection. These devices can be defined by color, shape, and information contained in them. You should always pay attention to traffic regulation devices used in the HTS as they are an important aspect of driving. Safety features have been added to the highways in an effort to reduce collisions. Retro reflective signs and pavement markings help nighttime drivers. Forgiving roadside hardware such as breakaway poles and guard rails, skid resistant pavement and all weather pavement markings also help minimize the severity of collisions. Rumble strips alert the driver that he is veering off the road or heading into a different lane. Intersections are a hazard to drivers. About 40 percent of all crashes occur at intersections. Efforts to improve intersections include exclusive turn lanes, roundabouts and synchronized traffic signals.

Remember that as a driver you are part of the HTS. As part of the system you have driving responsibilities to protect yourself and your passengers. You also have a responsibility towards other drivers, pedestrians, and personal property. Safely sharing the roadway is essential for avoiding crashes. The most important factor in the regulation of the highway transportation system is the driver who obeys traffic laws and follows the "golden rule" of driving to treat others the way you would want to be treated.

CHAPTER 3

SIGNS, TRAFFIC LIGHTS, AND PAVEMENT MARKINGS

Traffic control devices include traffic signals, signs and pavement markings. These devices are necessary to regulate and control traffic. You must be able to recognize them immediately, and in the case of regulatory signs, obey them.

Traffic control also can be provided by law enforcement, highway personnel or school crossing guards. You must obey directions from these persons.

TRAFFIC SIGNS

A sign's shape can tell you something about what it means before you are close enough to read it. You must know the following shapes and what they mean.

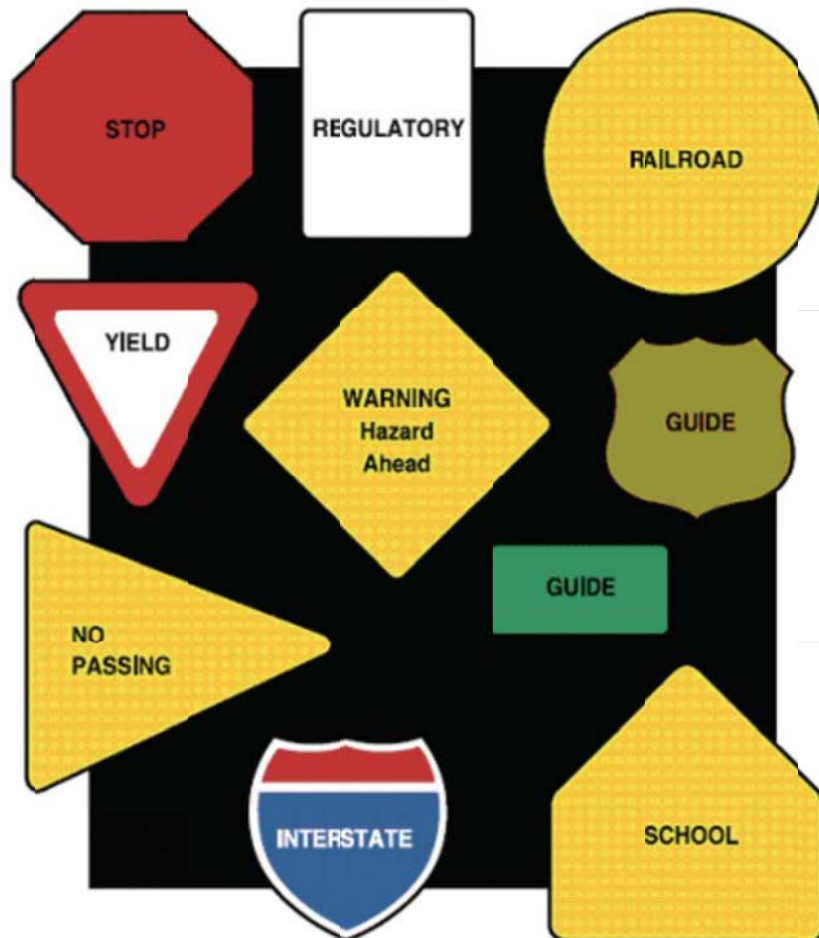

If you are familiar with the shape and color of the signs and their use, you will know that you should adjust your speed and driving manner before you can read the wording as you approach the signs.



The octagon shape sign is used exclusively for stop signs. Slow down and come to a complete stop.



The rectangle shape is used for regulatory signs, which include speed limit, school zones, parking and loading zones.



The diamond shaped sign is used for warning and approaching hazard signs. A diamond shaped sign that is orange in color is used in construction zones. Slow down and proceed with caution. Yellow diamond shaped signs advise you of approaching conditions such as curves, approaching side roads and traffic flow.



The triangle shaped sign with the point down is used exclusively for yield signs. Slow down and watch for oncoming traffic. Be prepared to stop if the traffic flow requires it.

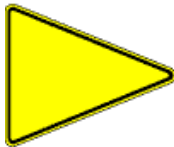

The triangle shaped sign with the point sideways is used to indicate no passing zones.

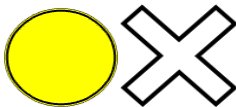

These two sign shapes are used exclusively for railroad advance warning signs.



The rectangle shaped sign with the longer dimension going horizontal is used for guide signs, some warning signs and temporary traffic control signs.

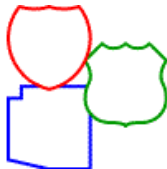

Other shaped signs are typically used for route marker signs.

Understanding what the colors represent is important.



Red – Used for Stop and Yield signs, DO NOT ENTER and WRONG WAY signs Means “Stop” or “Do Not” anytime you see this color



Orange – Used as background color for temporary traffic control signs
Means: Construction zone ahead

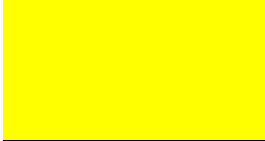

Yellow - Used as background color for warning signs and school signs
Means: Caution, be alert, prepare to slow down

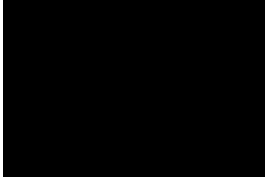

Black – Used as background color for ONE WAY, night speed limit, and truck regulatory signs, and as the color of the wording on signs with white, yellow, orange, florescent pink, and fluorescent yellow-green backgrounds

White – Used as background color for most regulatory signs and some route markers, and as legend color on signs with red, green, blue, brown and black backgrounds



Blue – Used as background color for traveler services, information signs, emergency evacuation route signs, and as part of interstate and some state route markers.



Green – used as background color for guide and information signs, and for legend on permissive regulation and parking signs.



Fluorescent Yellow-Green – used as background color for pedestrian, bicycle and school warning signs.



Brown – Used as background color for guide and information signs related to points of recreational or cultural interest.



Fluorescent Pink – Used as background color for incident management signs such as hurricane or a road closure due to a crash.

Traffic signs tell you about traffic rules, hazards, roadway location, roadway directions and the location of roadway services. The shape, color, symbols, and words of these signs give clues to the type of information they provide.

Warning Signs - These signs tell a driver of possible danger that might be ahead, such as warning you to slow down and be prepared to stop if necessary, or a hazard or special situation on the roadway that is ahead. These signs are usually yellow with black lettering or symbols and are diamond shaped. Some warning signs may be fluorescent yellow, such as school zones, school crossing and pedestrian crossing. Some common warning signs are shown below.



Cross Road Ahead



Side Road Ahead



T-Intersection Ahead



Y-Intersection Ahead



Curvy Road Ahead



Right Curve



Sharp Right Turn



Series of Turns



Winding Road



Divided Highway Begins



Divided Highway Ends



Lane Ends



Merging Traffic



Road Entering Curve



Angled Side Road



Added Lane



School Crossing



School



Pedestrians Crossing Ahead



Pedestrian Crossing



Slippery When Wet



Narrow Bridge or Underpass



Sharp Curve Ahead



Share the Road with Bicycles



Bicycle Crossing



Deer Crossing



Emergency Vehicle Crossing



Uneven Grade Crossing



Traffic Signal Ahead



Yield Sign Ahead



Stop Sign Ahead



No Passing Zone



Advisory Speed Around Curve



Advisory Speed for Ramp



Advisory Speed for Exit



Low Clearance

Regulatory Signs – These signs tell you about specific laws that you must obey, such as rules for traffic direction, lane use, turning, speed, parking and other special situations. These signs are square, rectangular, or have a special shape and are white with black, red or green letters or symbols.

Some regulatory signs have a red circle with a red slash over a symbol. These signs prohibit certain actions.



No Left Turn



No Right Turn



No U-Turn



Common types of regulatory signs are:

Speed Limit Signs - These black and white signs indicate the maximum legal speed allowed or the minimum legal speed required. The maximum limit should be driven only in ideal driving conditions and you must reduce your speed when weather or traffic conditions require it. For example, you should reduce your speed when the roadway is slippery, during rain, snow, icy conditions, foggy conditions, and anytime it is difficult to see the roadway clearly. Some high-speed roads have minimum speed limits and you are legally required to travel at least this fast so as not to be a hazard to other drivers.



School Speed Limit When Flashing Sign – This sign is posted before a school to indicate a reduced speed limit in a school zone. The speed limit is required only when flashing; otherwise obey the roadways speed limit.

Lane Use Control Signs - These black and white signs tell you where you can go, where you can turn and often use an arrow symbol. These signs can be located on the side of the road or hanging over the lane of travel. Sometimes arrows may be painted on the road as a supplement to the signs.



Straight



Left Turn Only



Right Turn Only



Straight or Turn Right



Stop Sign - A stop sign has eight sides and is red with white letters. You must stop behind the stop line or crosswalk, if one is present. Look for crossing vehicles and pedestrians in all directions and yield the right-of-way. When it is safe to do so, you may enter the intersection. A 4-WAY sign may be added to the stop sign at intersections where all approaching traffic has a stop sign. You may also see 3-WAY, 5-WAY or ALL-WAY signs.



Yield Sign - A yield sign is a red and white downward pointing triangle with red letters. It means you must slow down and allow traffic that has the right-of-way to cross before entering.



Shared Center Lane Left Turn Only – This sign tells you where a lane is reserved for the use of left turning vehicles from either direction and is not to be used for through traffic or passing other vehicles.



No Turn on Red – When you see this sign posted, it means that you may not turn right or left during the red light. You must wait for the traffic signal to turn green before turning.



Stop Here on Red – This sign tells you where you must stop if the traffic light is red. If there is not a “NO TURN ON RED” sign at the traffic light, after stopping at the stop line and checking for traffic and pedestrians, you may turn right on red.



Do Not Block Intersection – This sign tells you not to stop, stand or park at any time in the intersection. You must not enter an intersection if traffic conditions do not permit you to clear the intersection completely. You must not block traffic entering into the intersection from any other direction.



Left Turn Yield on Green – This sign tells you that a left turn is permitted, but you must yield to oncoming traffic.



One-Way Street – These signs tell you that traffic flows only in the direction of the arrow. Do not turn in the opposite direction of the arrow. Never drive the wrong way on a one-way street.



Do Not Pass – This sign tells you where you cannot pass another vehicle. Passing areas are based on how far you can see ahead. They consider unseen hazards such as hills and curves, intersections, driveways and other places a vehicle or pedestrian may enter the roadway.



Pass With Care – This sign tells you that you are at the end of a no passing zone. You may pass only when it is safe to do so.



Keep Right – These signs indicate when traffic must stay to the right of a roadway feature or obstruction, such as an upcoming median, island or lane divider.



Slower Traffic Keep Right – This sign is posted on a multilane highway for those driving slower than the normal speed of traffic. It tells the slow driver to stay in the right lane.



Do Not Enter – A square sign with a white horizontal line inside a red circle means you cannot enter. This sign is visible at roadway openings that you may not enter such as exit ramps where you would be going in the wrong direction, in crossovers on divided roadways and at numerous locations on one-way streets.



Wrong Way – This sign tells you that your vehicle is moving in the wrong direction. You will see this sign on expressway ramps a short distance past the “DO NOT ENTER” sign. You also will see this sign if you turn the wrong way onto a one-way street, alley or driveway.



Highway Evacuation Route - this highway is an emergency evacuation route.

Guide Signs – These signs are square and rectangular and are green, brown, or blue. They give information on intersecting roads, help direct you to cities and towns, and show points of interest along the highway. Guide signs can also help you find hospitals, service stations, restaurants and hotels.

Common types of guide signs are:

Destination Signs - These green or brown signs are square or rectangular shaped with white lettering or symbols. They show direction and distance to various locations such as cities, airports, and state and parish/county lines. If the word “Exit” is written on the left side of an exit sign, the exit lane or ramp is to the left and if the word “Exit” is written on the right side of an exit sign, the exit lane or ramp is to the right.



Signs may also designate special areas such as national parks, historical areas, or museums.



Service Signs - These blue signs are square or rectangular shaped with white lettering or symbols. They show the location of various services such as rest areas, gas stations, hotels or hospitals.



Hospital



Food



Lodging



Telephone



Fuel

Route Number Signs - The shape and color of route number signs indicate the type of roadway: interstate, U.S., state, city, county, or local road. When planning a trip, use a road map or GPS to determine the route. During the trip, follow the route signs to prevent you from getting lost in an unfamiliar area.



Interstate Route



U.S. Route



State Route

Incident Signs - These signs are temporary and let you know when you should be prepared to stop or when roadways are closed or detoured due to a road user incident, natural disaster, hazardous material spill, or other unplanned incident. These signs are fluorescent pink with black lettering.



Be Prepared to Stop



Lane Ends



Center Lane Closed Ahead



Exit Closed



Detour



Detour

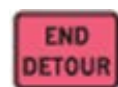

End Detour

SIGNS IN CONSTRUCTION AREAS

Orange warning signs tell you that workers, machinery and barricades are just ahead. You may need to slow down, stop, or change lanes.





CONSTRUCTION AND MAINTENANCE DEVICES

Various traffic control devices are used in construction and maintenance work areas to direct drivers or pedestrians safely through the work zone and to provide for the safety of the highway workers. The most commonly used traffic control devices are signs, barricades, drums, and cones, tubes, flashing arrow panels and flag persons. Orange is the basic color for these devices.

CONSTRUCTION AND MAINTENANCE SIGNS

Construction and maintenance signs are used to notify drivers of unusual or potentially dangerous conditions in or near work areas. Most signs in work areas are diamond shaped. A few signs are rectangular.

		
Flagger Ahead	Workers Ahead	Low Shoulder
Indicates a flag-person is ahead to control traffic. Slow down and be prepared to stop.	Indicates workers are performing maintenance on the roadway. Reduce speed and adjust lane position away from workers.	Indicates sharp drop from the pavement edge to the shoulder. If you must leave the pavement, slow down and steer firmly.

HIGHWAY WORK ZONES

Design engineers must ensure work zones are safe for both workers and motorists. Every road construction job includes plans for the protection of traffic. Engineers must decide how best to keep the traffic flowing while protecting the safety of the workers. Different traffic channeling devices such as barrels, barricades and cones are used to guide the traffic. Reduced speed limits are set to protect the drivers and workers. In Louisiana, traffic fines are double for construction zones. Sometimes drivers can become



confused in a construction area, even when it is well designed. Slower speeds allow drivers more time to make good decisions. Do not become oblivious to work zone signs when the work is long term or widespread and be aware that traffic patterns in work zones can change daily including lane shifts or alternating lane closures.



CHANNELIZING DEVICES

Barricades, vertical panels, drums, cones and tubes are the most commonly used devices to alert drivers of unusual or potentially dangerous conditions in highway and street work areas and to guide drivers safely through the work zone. At night they are often equipped with flashing or steady burning lights.

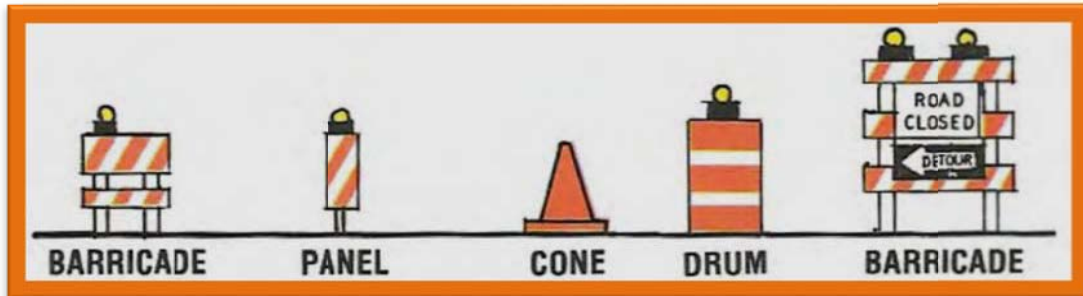

The diagonal stripes on the barricade or vertical panel guide the driver toward the direction in which traffic should pass. Stripes sloping downward to the right mean the driver should bear to the right. Conversely, stripes sloping downward to the left mean bear to the left.



FLASHING ARROW PANELS

Large flashing or sequential arrow panels may be used in work zones both day and night to guide drivers into certain traffic lanes and to inform them that part of the road or street ahead is closed.

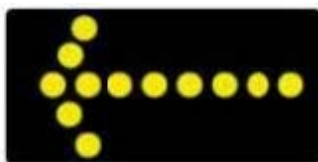

Move left

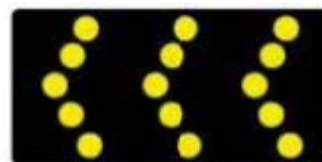

Lane closed

FLAG PERSONS

Flag persons are often provided in highway and street work zones to stop, slow down or guide traffic safely through the area. Flag persons wear orange vests, shirts or jackets and use red flags or stop/slow paddles to direct the traffic through work zone.

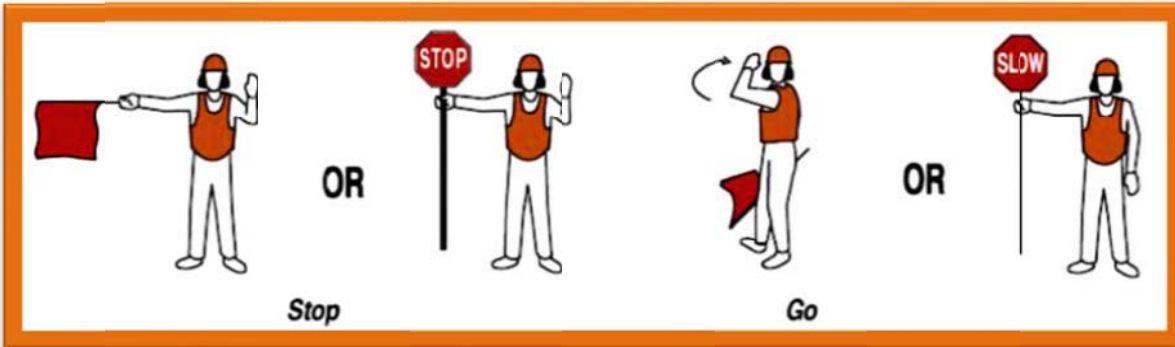

TRAFFIC SIGNALS

Traffic signals are lights that tell you when or where you should stop and go. Traffic lights are usually at intersections and are red, yellow and green from top to bottom, when on the same signal. There are some intersections and other locations where there are single green, yellow or red lights. In some metropolitan areas, traffic lights are horizontal, instead of vertical, where the red light is on the left, the yellow light is in the middle and the green light is on the right.



Steady GREEN Traffic Light – This means you can go through the intersection if it is clear to do so. You must yield to emergency vehicles and other roadway users as required by law. If you are stopped at the intersection and the light turns green, you must allow crossing traffic to clear the intersection before you go ahead. Turning left at a steady green traffic light means you may turn but only when the intersection is clear to do so. You should always yield to the oncoming traffic flow and pedestrians.

GREEN Arrow – This means you can safely turn in the direction of the arrow, if the intersection is clear of other roadway users. When the arrow is green, oncoming or crossing traffic should yield to your turning action, but be careful of others making a right turn on red from the other side of the intersection. Be alert for signs that prohibit turns at intersections. When turning at intersections, always watch for pedestrians crossing in front or from the side of your vehicle.

Steady YELLOW Traffic Light – This means the traffic light is about to change to red. You should slow down and come to a complete stop, if traffic flow to the rear allows. If you are already in the intersection when the yellow light comes on, you may continue safely through the intersection.

Flashing YELLOW Traffic Light – This means slow down, look for any traffic entering the intersection and proceed with caution. If traffic is in the intersection, stop and let the traffic pass before proceeding.

YELLOW Arrow – This means that the green arrow is ending; you should prepare to stop and yield the right-of-way to oncoming traffic or pedestrians.

Steady RED Traffic Light – This means stop behind the stop line, crosswalk, or intersection until the traffic light turns green. When turning right at an intersection, if there is no sign prohibiting a right turn on a red light, you may turn after stopping and yielding to traffic and pedestrians. Some left turns may be permitted on red when moving from a one-way street onto another one-way street. You must yield to all traffic and pedestrians crossing in front or to the side of your vehicle when turning left on red, where permitted

Flashing RED Traffic Light – This means you must stop behind a stop line, crosswalk, or intersection before entering and use the same procedure as you would at a stop sign, by coming to a complete stop, looking both ways before entering the intersection and yielding right-of-way.

RED Arrow – This means you must stop and you may not go in the direction of the arrow until the green arrow or light returns on the signal.

LANE MARKINGS

CENTER LINES

Yellow center lines are used to separate traffic in opposite directions.

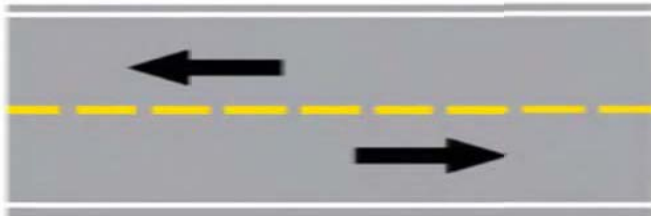

A Single Broken Yellow line is used to mark the centerline where there are only two lanes of traffic. You must drive to the right of the centerline. When it is safe, you may cross this line to turn or pass another vehicle.

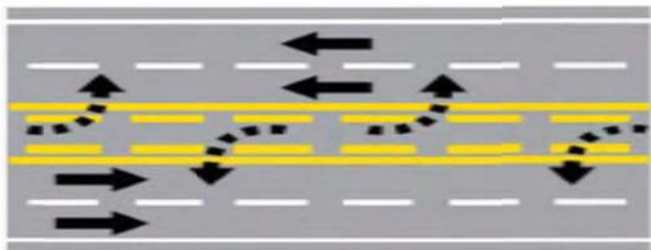

Double Solid Yellow lines are used to mark the center of the roadway when there are four or more lanes of traffic. You may not cross these lines to pass. You may cross these lines to make a turn.

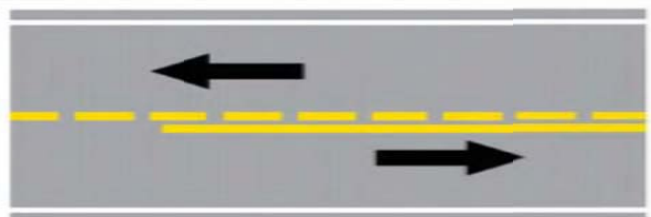

A No Passing Line is a single solid yellow line used on two-lane roads to indicate zones where passing is prohibited. You may cross this line to make a turn.

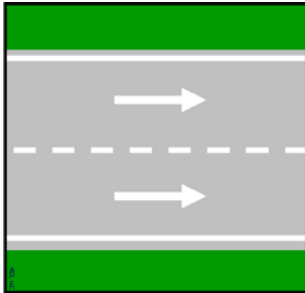

White lines separate lanes of traffic moving in the same direction. You are required to drive between these lane lines. Louisiana law states that all vehicles should travel in the right hand lane unless, preparing for a left turn, passing another vehicle or when right hand lanes are congested. No vehicle driven in the left hand lane shall be driven at speeds slower than vehicles traveling to its right. Any vehicle traveling at a speed less than the normal speed of traffic shall travel in the right lane only.

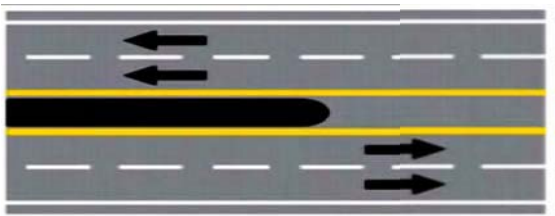

Single Solid White lines indicate movement from lane to lane is hazardous. The wider the line, the greater the hazard. You may cross a solid white line **only with great care**.

Single Dashed White Lane Lines may be crossed only when you can do so safely.

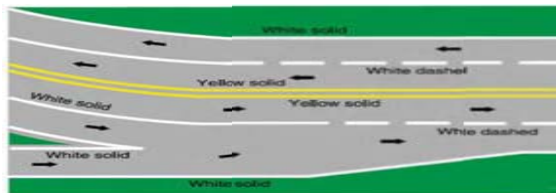

White edge lines are used along the right edge of the roadway. Yellow edge lines may be along the left edge of the roadway on divided streets and highways.



Double solid white lines separate two lanes of traffic going in the same direction. Crossing a double solid line is prohibited. Most commonly seen on interstates.



Red Pavement Marking or reflectors indicate a roadway that must not be entered.

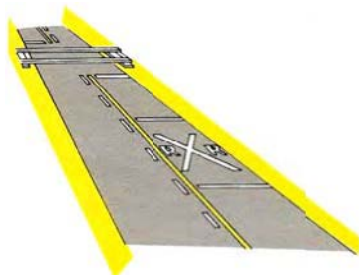

Railroad Crossing markings are white markings painted in the traffic lane before railroad crossings. The pavement is marked with a large "X" and two "R's". A solid yellow center line extends the entire distance to prevent passing, and a white stop line is painted across the traffic lane.

Two-Way Left Turn Channelization markings are a combination of solid yellow and dashed yellow lines in the center of a roadway. The designated center lane may be used by vehicles traveling in either direction. For left turn maneuvers ONLY. The lane must NEVER be used for passing.

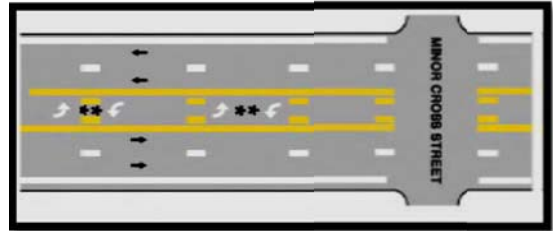

Stop Lines are solid white lines painted across the traffic lanes at intersections and pedestrian crosswalks indicating the exact place at which to stop.

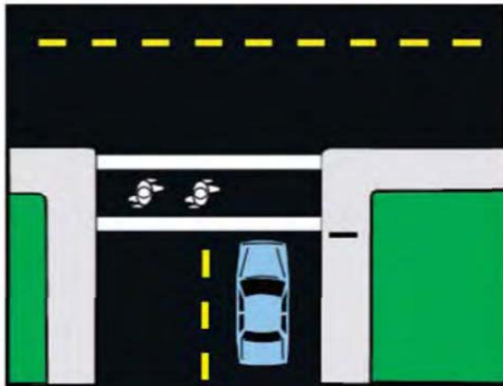

Crosswalk lines are normally two solid white lines painted across the traffic lanes. However, diagonal or longitudinal lines are sometimes added for increased visibility. When pedestrians are in these crosswalks, they have the right of way over motor vehicles. **You must stop for pedestrians in crosswalks.** Crosswalks are sometimes located in the middle of the block. In this case a pedestrian crossing sign may also be used.

Directional Markings are white arrows or words painted in the traffic lane to indicate the direction in which you must go. You must move only in the direction indicated by the arrow. Where arrows indicate more than one direction, you may choose any direction

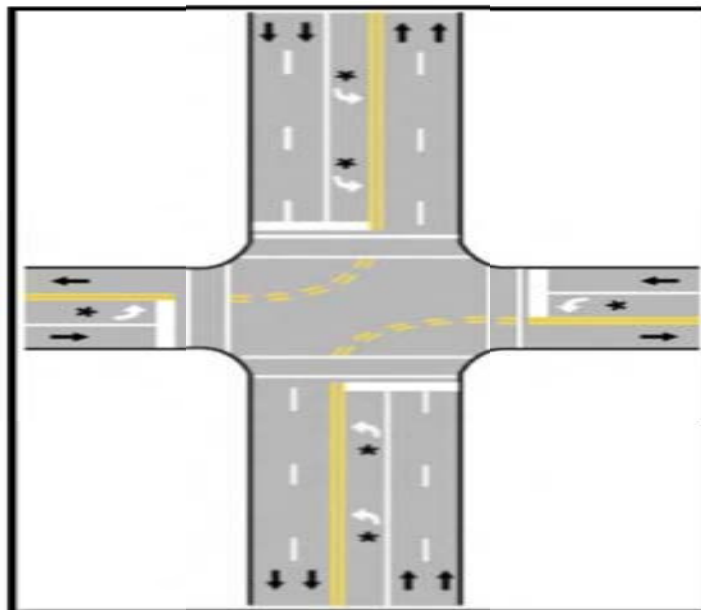

If you discover that you are in a lane that requires you to turn, and you wish to go straight ahead, keep in mind:

- Other drivers will not expect you to suddenly change lanes.
- Drivers behind you will not expect a sudden stop.
- If you stop and wait for a chance to change lanes you are blocking traffic. You must go ahead and make the turn.

Drive around the block and return to the street you want. Then continue your trip safely without creating a hazardous situation.

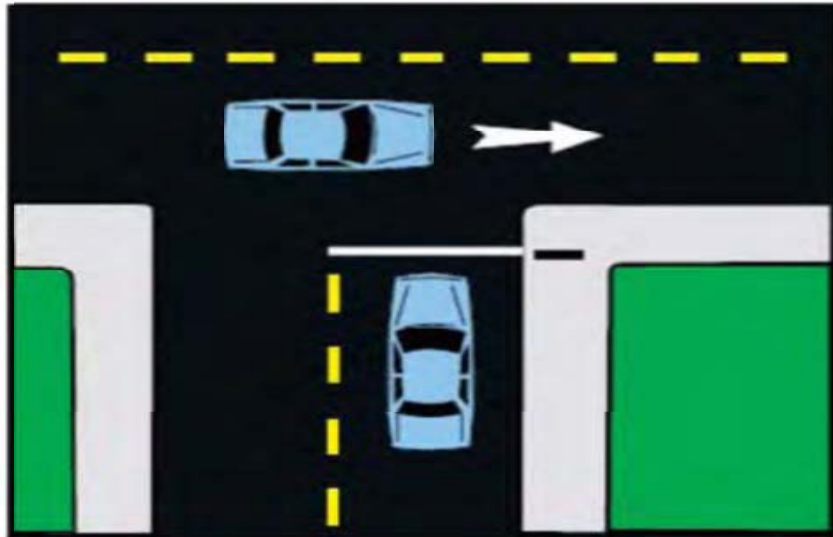

ROUNDABOUTS

Roundabouts are circular intersections. Roundabouts reduce traffic congestion and conflicts that are often the cause of crashes at traditional intersections. In a roundabout, traffic yields to the circulation traffic.



CHAPTER 4

BASIC DRIVING AND SAFETY

There are an increasing number of new drivers and vehicles on the road. Add to that statistic, the “baby boomer” population is aging causing larger number of older drivers to be on the road. The combination of these two factors creates a continuing need for defensive driving training across all age groups.

Vehicle accidents cause damage, injuries and deaths because of the force imposed on people and property beyond their breaking points. More than 2.3 million adult drivers and passengers were treated in emergency departments as the result of being injured in motor vehicle crashes in 2009. By managing the force – the sudden transfer of energy in a crash – and by controlling the time and areas it affects, damage and injuries can be reduced. Vehicle occupants can withstand a great deal of force when they are properly restrained.

The National Highway Traffic Safety Administration (NHTSA) establishes and enforces safety performance standards for vehicle manufacturers. NHTSA conducts tests on new vehicle lines using crash test dummies. The dummies are used to evaluate the damage that can occur to the human body during impact. The use of these dummies has resulted in safer vehicles being manufactured today.



Anatomy of a crash

Hopefully you'll never be involved in a crash because here's what happens:

- Your car hits something. It might be another car or truck, a tree or a telephone pole. Even at 30 mph, your car is badly damaged. It will absorb some of the force of the crash, but not all.
- You hit the car. After your car stops, the force of the crash has to go somewhere. Next, it hits you and anybody else in the car. If you are not wearing a safety belt, your body will be thrown forward until you're stopped by something, like the windshield, the dashboard, or the steering wheel. You get the idea. The human body will absorb more of the force of the crash. But it is still not over.
- Your internal organs crash too. Once your body has come to a stop against some part of the car, the force of the crash goes on inside you. Your brain slams against your skull. Your lungs hit your rib cage. Your kidneys and other organs may also smash into your bones. It is this part of the crash that causes many internal injuries.

Crashes can be life-altering or life-ending experiences. That's why your best protection is to properly buckle up every time and to always drive safely. Every day, individuals break laws while driving. The most common traffic violation is speeding. Other traffic laws commonly broken are careless driving, failure to yield, and following too closely.

There are some laws associated with driving however, that simply can't be broken and those are the laws of physics.

- Newton's 1st law of motion states that a body at rest remains at rest unless acted upon by an external force, and a body in motion continues to move at a constant speed in a straight line unless it is acted upon by an external force.
- Newton's 2nd law of motion states that if you wish to stop or start a body in motion you must apply force to it to. Momentum is equal to mass times velocity. A moving object has a large momentum if it has a large mass, a large velocity, or both. A marble can be stopped more easily than a bowling ball. Both balls have momentum. The bowling ball has more

momentum because of its mass. Changing the velocity of the bowling ball requires much more force than changing the velocity of the marble.

- Newton's 3rd law of motion tells us that for every action, there is an equal and opposite reaction. So, the forces between two crashing cars are equal in opposite directions. Each car experiences the same force during the collision, but the change in velocity will be much greater on the lighter of two vehicles. This will result in greater damage to the lighter car and possibly greater injury to its occupants.

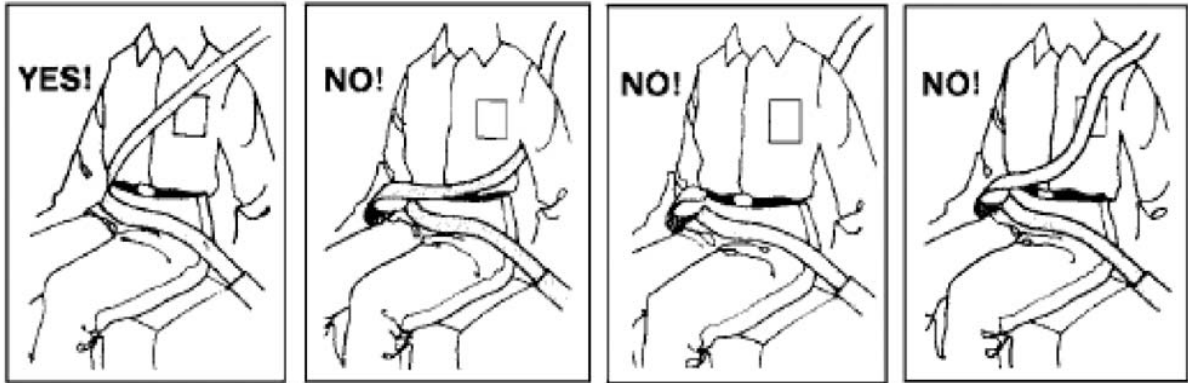

USE OF SAFETY BELTS "BUCKLE UP, IT'S LOUISIANA LAW!"

Louisiana has a mandatory safety belt use law which requires all passengers in cars, vans and pickup trucks to be properly buckled. The three-point safety belt saves more lives than any other automotive safety device. Use of safety belts is the most effective method of preventing serious injuries and reducing fatalities in crashes. People who wear safety belts reduce their risk of serious injury by 50 percent and also reduce the risk of fatalities by 50 percent. The chance of an occupant being killed is five times greater if he is thrown from the vehicle. According to the National Highway Traffic Safety Administration if all occupants in vehicles ages 5 and older would have worn safety belts in 2009, 16,401 lives could have been saved. While safety belt use has been increasing and polls indicate that the national average of those using safety belts is 88 percent there are still those less likely to wear safety belts: teens, commercial drivers, males in rural areas, pick-up truck drivers, individuals driving at night, and people who have been drinking.

A safety belt can protect you only if it is worn and worn correctly. Your safety belt should fit snugly across your hips. Your hip bones are strong and can absorb more of the impact than your abdominal region. The shoulder strap should slide over the shoulder and securely across the chest.

Keep in mind these reasons for wearing safety belts:

- * They keep you from being thrown from your car. Your chances of surviving a crash are 3 to 4 times greater if you remain in the car when the collision occurs.
- * There is much less chance of being knocked unconscious or seriously injured. If there is danger from fire or water, you can get out quickly.
- * Safety belts keep you in a position so you can control the car. The first impact in a crash frequently throws the driver from behind the wheel and the vehicle is out of control.



Crash Impact

- If you are pregnant, you and your unborn child are much safer if you wear a lap and shoulder belt. By protecting yourself from injury, you protect your unborn child.
- Properly buckled safety belts prevent you and your passengers from being thrown about inside the car. This reduces the chance of serious injury and death by 60% to 80%.
- A seat belt is your best defense against a drunk driver.

SAFETY BELTS SAVE LIVES

It's as simple as that. Wearing your seat belt is the smartest move you can make to prevent injury or death. Just look at the facts:

- ◆ 80% of deaths occur in cars traveling less than 40 miles an hour.
- ◆ 75% of crashes occur within 25 miles of home.
- ◆ Your chances of being killed are 25 times greater if you're thrown from the car.
- ◆ Non-belted fatalities have been recorded at speeds as low as 12 mph.
- ◆ Once every ten years, each of us can expect to be in a car crash.
- ◆ There's less than one-half of one percent chance of being trapped in a burning or submerged car.
- ◆ The force of impact at 10 mph is equal to the force of a 200 pound bag of cement dropped from a first story window.
- ◆ If everyone that was in a crash was wearing their seatbelt at the time of the crash, 60% more lives could have been saved.



While the percentage of adult safety belt use has increased and statistics indicate using safety belts reduces serious injuries and deaths in crashes by about 50%, 1 in 7 adults still choose not to buckle up. There is no good reason not to use your safety belt. From infants to adults, everyone in your vehicle needs to be secured. Lap belts should be buckled snugly across your hips and lower part of your abdomen. The shoulder belt should not be quite so tight.

Young Children - Louisiana Child Passenger Restraint law requires that all children must be properly restrained and secured in an age- or size-appropriate passenger restraint system which meets the applicable federal motor vehicle safety standards in effect.

The law requiring safety seat belts for children is determined by weight and age as follows:

- A child 6 years or younger or under 60 lbs. may not be transported in the front seat of a vehicle with an active airbag.
- Birth or less than 20 lbs. at any age - rear facing, federally approved car seat
- 1-4 years, at least 20 lbs. but less than 40 lbs. - forward facing, federally approved car seat
- 4-6 years, at least 40 lbs. but less than 60 lbs. - booster seat with restraints
- 6 years, more than 60 lbs. - booster seat with restraints or seat belts
- Booster seats are an appropriate option for a child of any age.

- A child that falls into more than one category for age or weight must choose the more protective category.

Motor vehicle injuries are the leading cause of death among children in the United States. Many of these deaths can be prevented by placing children in appropriate age- and size-car seats.

NEVER HOLD A CHILD ON YOUR LAP OR BUCKLE YOURSELF AND A CHILD INTO A SINGLE SAFETY BELT. YOU ARE NOT STRONG ENOUGH TO HOLD ONTO EVEN A SMALL CHILD IN CRASHES OR SUDDEN STOPS. NEVER ALLOW A CHILD TO RIDE STANDING ON A SEAT.

As a parent or a caregiver, use a seat belt on every trip, no matter how short. This sets a good example. Have all children under the age of 13 sit in the back seat. The middle of the back seat in a passenger car is safer than the front seat. For more information on safety-approved child restraint devices, contact your local Safety Council, hospital, doctor's office, State Police Troop or Louisiana Highway Safety Council (www.dps.state.la.us/tiger).



AIR BAGS

An airbag is a flexible membrane that inflates rapidly with air or another gas during a head on or nearly head on collision. Side and front air bags have been proven to be an effective safety device. Air bags do not replace safety belts. They supplement the safety provided by reducing the chance of the vehicle occupant sustaining a head or upper body injury from encounters with the vehicle's interior equipment. The recommendation for the 10 and 2 hand positions went out when air bags came in. The reason is that the air bag, when it deploys, comes out at speeds of 150 to 200 miles per hour. If your hands are on the upper part of the wheel (the traditional 10 and 2 position), your hands can be thrown into your head causing a serious head injury or your wrist or forearm can be broken. Thumbs have been severed because of the speed at which the seams of the air bag cuts across the hand. The recommended positions are 9 and 3 or 8 and 4.

Most vehicles without rear seats or with small rear seats, such as pickup trucks or sports cars have a passenger air bag on-off switch as standard equipment. The purpose of the switch in the off position is to disable the front passenger air bag to transport a child age 12 or under in the right front passenger seat.

Vehicles now equipped with air bags require drivers to do the following:

1. Sit at least 10 inches away from the steering wheel equipped with an air bag - otherwise the bag can explode into you, causing serious harm.
2. Use the 9 and 3 position or 8 and 4 hand position.
3. If you have a tilt function on the steering wheel, make sure the wheel is tilted away from the head (preferably toward the chest).
4. Older, frail persons and children 12 and under should sit in the back seat. Front seat airbags have killed children and older people.



Air bags do not deploy when you are rear-ended by another car. Remember, air bags are a "Supplementary Restraint System". Your safety belt is your **primary restraint** and, for you to get the best protection with your air bags, you need to use your safety belt properly.

OTHER VEHICLE SAFETY FEATURES

Headrests protect vehicle occupants from whiplash. Adjusting your headrest is an important step before driving. Steering wheels are being designed to absorb the impact of the driver being thrown against it rather than remaining rigid. Newer model vehicles are designed with non-projecting knobs for interior equipment, padding on the dash and front ends that crumple during an accident, further protecting the vehicle occupants.



Improvements in vehicle safety are added yearly to new vehicle models. Side impact air bags and roll-over curtains are now available on many vehicle models. Some models now offer:

- Cross path detection to let you know when someone is crossing your path when you are backing out
- Lane departure detection
- Accident avoidance – applying the brakes when you don't stop in time before hitting an object in front of you.

The terms "active safety" and "passive safety" are simple but important terms in the world of automotive safety. "Active safety" refers to technology assisting in the prevention of a crash and "passive safety" refers to components of the vehicle (primarily airbags, seatbelts and the physical structure of the vehicle) that help to protect occupants during a crash.

Crash avoidance

Crash avoidance systems and devices help the driver to avoid a collision. This category includes:

- The vehicle's headlamps, reflectors, and other lights and signals
- The vehicle's mirrors
- The vehicle's brakes, steering, and suspension systems

Driver assistance

A subset of crash avoidance is driver assistance systems, which help the driver to detect ordinarily-hidden obstacles and to control the vehicle. Driver assistance systems include:

- Automatic Braking Systems to prevent or reduce the severity of collision.
- Infrared night vision systems to increase seeing distance beyond headlamp range
- Adaptive headlamps control the direction and range of the headlight beams to light the driver's way through curves and maximize seeing distance without glaring other drivers
- Reverse backup sensors, which alert drivers to difficult-to-see objects in their path when reversing
- Backup camera
- Adaptive cruise control which maintains a safe distance from the vehicle in front
- Lane departure warning systems to alert the driver of an unintended departure from the intended lane of travel
- Tire pressure monitoring systems

- Traction control systems which restore traction if driven wheels begin to spin
- Electronic Stability Control, which intervenes to avert an impending loss of control
- Anti-lock braking systems
- Electronic brake force distribution systems
- Emergency brake assist systems
- Cornering Brake Control systems
- Pre-crash system
- Automated parking system

Crashworthy systems and devices prevent or reduce the severity of injuries when a crash is imminent or actually happening. Crashworthiness is measured by a structure's ability to protect its occupants or users during an impact. Much of this research is carried out using crash test dummies.

- Seatbelts limit the forward motion of an occupant, stretch to slow down the occupant's deceleration in a crash, and prevent occupants being ejected from the vehicle.
- Airbags inflate to cushion the impact of a vehicle occupant with various parts of the vehicle's interior.
- Laminated windshields remain in one piece when impacted, preventing passage of unbelted occupants' heads and maintaining a minimal but adequate transparency for control of the car immediately following a collision. Tempered glass side and rear windows break into granules with minimally sharp edges, rather than splintering into jagged fragments as ordinary glass does.
- Crumple zones absorb and dissipate the force of a collision, displacing and diverting it away from the passenger compartment and reducing the impact force on the vehicle occupants. Vehicles will include a front, rear and sometimes side crumple zones too.
- Side impact protection beams.
- Collapsible universally jointed steering columns, (with the steering system mounted behind the front axle -not in the front crumple zone); reduce the risk and severity of driver impalement on the column in a frontal crash.
- Padding of the instrument panel and other interior parts of the vehicle likely to be struck by the occupants during a crash.
- Cargo barriers are sometimes fitted to provide a physical barrier between passenger and cargo compartments in vehicles such as SUVs, station wagons and vans. These help prevent injuries caused by occupants being struck by unsecured cargo. They can also help prevent collapse of the roof in the event of a vehicle rollover.

Other Factors

Vehicles are equipped with a variety of lights and reflectors to mark their presence, position, width, length and direction of travel as well as to convey the driver's intent and actions to other drivers. These include the vehicle's headlamps, front and rear position lamps, side marker lights and reflectors, turn signals, brake lamps, and reversing lamps.

School buses and semi-trailer trucks in North America are required to bear retro reflective strips outlining their side and rear perimeters for greater visibility at night.

Some studies indicate that color may be a factor in determining safety. Lighter color cars seem to be involved in fewer accidents than darker colors.

VEHICLE CONDITION

Any defect which may affect the safe operation of the vehicle should be corrected as soon as possible. If the engine coolant, engine oil, battery water, tire pressure and condition, and vehicle lamps have not been checked in the previous week, you should check them or have them checked at an automotive repair center.

You may check your vehicle on a pre-trip inspection and find that it needs some minor repair. If you change the oil or battery, check with your local regulations regarding disposals of these items. It is not environmentally safe to just discard these items. There are many facilities located throughout the state that will take used batteries or motor oil. There are also several agencies that will take your old car for donation and you may receive a tax credit. Do not simply abandon your vehicle if it stops running. Your old car could still benefit someone else.

PREPARING TO DRIVE

You should always conduct a “pre-trip” inspection of your vehicle before driving. This will ensure that not only is your vehicle well maintained, but also that it is safer to drive.

Suggested Weekly Checks (During fill up at gas station or make it a weekend project):

- Check tire pressure to ensure it is within the pressure range listed on the tire.
- Ensure tires have adequate tread – at least 1/16 of an inch depth between all treads.
- Ensure tire wear is even on all tires and check for dry rot (cracking), bumps, bulges and separation of the tread from the tire.
- Make sure oil level is within the vehicle’s operating range listed on the dipstick.
- Check battery for corrosion on terminals or leakage.
- Check engine compartment for fluid leaks.
- Make sure the radiator level is within operating level on the overflow tank.
- Make sure there are no cracks in lenses for headlights, tail lights and turn signals and make sure they are operating properly.
- Make sure the horn operates properly.
- Make sure fuel cap is present and fits properly.
- Inspect seat belts for unusual wear or malfunctioning parts.

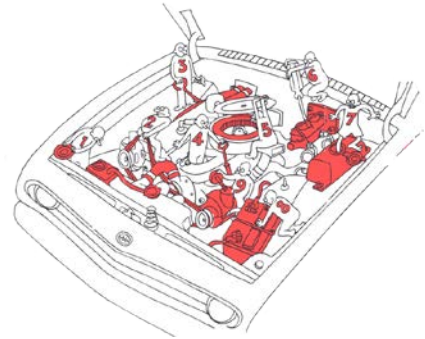

Suggested Monthly Checks

(Start or end of-the-month project):

- Check mirrors and windows for cracks and check windshield for cracks in the wiper operating area.
- Check condition of license plate for readability and reflective properties, and damage or scratches, which would affect the appearance of the plate.
- Ensure brake lights and emergency flashers are working.
- Ensure wiper blades are not streaking and are cleaning the windshield properly.
- Check the spare tire, jack and emergency equipment for serviceability.

- Ensure power steering, brake, transmission, engine oil and battery (if applicable) fluid levels are within operating ranges. Check the vehicle owner's manual for their location and proper levels.

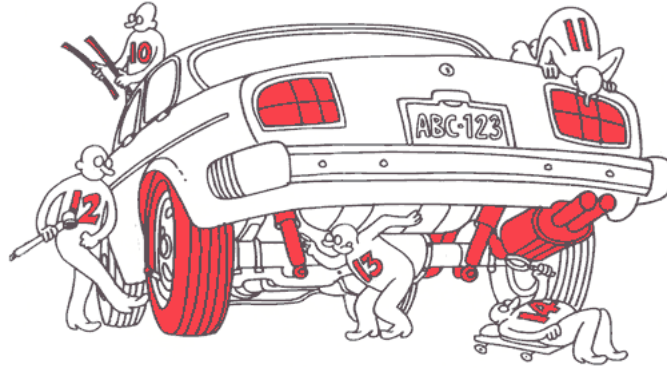

NOTE: As with all projects, think safety first. Make sure your vehicle's engine has cooled down before checking under the hood and ensure the parking brake is applied while making all suggested checks.

You've checked your vehicle to be certain it is roadworthy and safe. You are now ready to get into the vehicle and start the engine.

ENTERING AND STARTING YOUR VEHICLE

Before entering your vehicle:

- Check your tires. Make sure they are not low or flat and that tread is not worn away.
- Make certain there are no leaks under the car.
- Make certain the mirrors, directional signals, head, tail and brake lights are clean and not broken.
- Check around for any obstacle that might interfere with safe driving. Look in the front, under and behind, scanning for any objects in your travel path. Walk around your vehicle. You may need to move a child's tricycle or some other object.
- Notice if there are children standing or playing near your vehicle.
- **Never drive impaired.**

GETTING READY TO DRIVE

You are now in the car. Before starting your engine:

- Make sure all windows are clean. Remove anything blocking your view.
- Adjust the seat so you can reach the pedals and controls safely.
- Adjust the seat and head restraint for comfort.
- Adjust the inside and outside rear view mirrors.
- Make sure all doors are fully closed and locked.
- Make sure your car is in park or neutral gear.
- Make sure you and passenger(s) are correctly belted.
- Check gauges to assure they work and accurately reflect engine conditions.
- Make sure the windshield wipers work and that there is sufficient cleaning fluid in the reservoir.
- Make sure you are mentally and physically ready to drive.

Once you are in the car you may want to reposition the driver's seat. Proper seating position maximizes your visibility and your ability to react quickly to emergency situations. In addition to avoiding distractions and driving defensively, being seated comfortably is a key to driving well and driving safely.

Follow these three easy steps to adjust your driver's seat, but remember, always adjust it before you drive.

1. Check your headrest. The headrest should be positioned so that it will fully support your head when you lean back.
2. Pay attention to your arms and elbows. In your normal driving position, your elbows should always be slightly bent when you're holding the steering wheel. This will prevent your arms from becoming overextended during turns so that they don't tire as quickly. Slightly bent elbows also give your airbag enough room to expand in the event of a crash. Remember to sit at least 10 inches away from steering wheels equipped with air bags.
3. Bend your knees and plant your heels. (As you press on the gas or brake pedal, your knees should always be slightly bent to prevent an injury in case of an accident. Your right heel should also be firmly planted on the floor so that you can shift your foot between the gas and brake pedal without lifting your whole foot.)

STARTING AND STOPPING

As you put your key into the ignition switch, turn the key smoothly and slowly. Some cars today are equipped with push button or remote start. Once you hear the engine engage, release the key. Move your right foot over the accelerator pedal and gently but firmly press on the accelerator pedal causing gas to be supplied to the engine. Do not stomp on the gas pedal or "race" the engine but aim for a smooth acceleration of the vehicle. Use the ball of your foot and toes, not the whole foot when accelerating. As you are driving, you want to maintain a safe, steady speed. Periodically, check your speedometer while driving. As you are slowing down or decelerating, do so smoothly. Do not brake suddenly so that you jar yourself or your passengers. Ease up on the accelerator and slowly apply pressure to the brake pedal. Always stop far enough away from the vehicle in front of you so that you can see the bottom of the tires.

Never move your car until you have looked around for pedestrians and oncoming traffic. Then signal and move into traffic when safe.

When you back up, turn your head and look back. Don't just look into the rear view mirror. Check to make sure your mirror is in the correct position. The proper angle can change from morning to evening, especially if you are tired.

NOTE: Never turn your vehicle's ignition to the "lock" position while it is still in motion. This will cause the steering to lock if you try to turn the steering wheel and you will lose control of your vehicle.

SKILLS IN DRIVING

While advancements in vehicle safety technology are being made, it is still the driver's skills that control the vehicle. There are three basic skills of the driving task.

1. Physical skill. The person's coordination with the vehicle.
2. Social skill. The social interaction with others on the highways. Unfortunately, we are not always very social people. Drivers are often inconsiderate. Road rage is on the rise and much of that has to do with our unsociable behavior while driving.

3. Mental skill. Driving is a mental skill that involves decision making every second we are behind the wheel. Most everyone can physically drive a vehicle. However, being a defensive driver involves mental awareness of not only our actions but the actions of all other drivers on the road.

DRIVING HABITS

Driving habits are formed because the same physical actions are required over and over again. Your tendency to reduce these repetitive actions results in the formation of “bad” driving habits. The following topics may not be in the Highway Regulatory Law, but they can help improve your driving skills. Remember, being a safe and defensive driver is not just a good habit, it is a skill. This skill could save your life or the life of someone you know.

Driving habits of poor efficiency can be divided into three categories: Strategic decisions, which include engine tuning, tire pressure, and motor oil use; tactical decisions, which include route selection, traffic congestion and load weight; and operational decisions, which include idling, speed, aggressive driving, and cruise control and air conditioner use. Of these factors, route selection, speed, and engine tuning are indicators they have the highest potential to sap fuel economy.

Items such as tire inflation to road selection can add up to transform even the most fuel-efficient automobiles into gas guzzlers. For instance, the owner of an EPA-rated 30-mpg vehicle with poor eco-driving practices could see his average fuel economy drop as low as 17 mpg.



The government-mandated Corporate Average Fuel Economy for cars was 27.5 mpg in 2011, but those numbers are determined by EPA testing and not by the actual driving experience of automobile owners. The greatest factor in determining automobile transportation efficiency is vehicle occupancy. Since 1960, vehicle occupancy in the United States has fallen 30 percent, causing the average energy intensity of driving to rise by about 30 percent in turn. Hence, there are more cars on the road with only one occupant, the driver.

While which car you drive can make all the difference in the world, it certainly isn't the only factor in determining fuel economy. The simplest, most cost-effective ways to increase fuel economy is not in the hands of manufactures but drivers themselves. In theory, a combination of good car maintenance, smart driving and whenever possible, carpooling, can be just as powerful a fuel-saver as buying a green car.

Tips for More Efficient Driving and Improving Fuel Economy-Sensible Driving

Keep your engine properly tuned
Keep your tires properly inflated
Use the recommended grade of motor oil
Keep a log of miles driven and fill ups
Observe the speed limit
Remove excess weight

If possible, don't drive during peak traffic
Use cruise control on highway driving
Avoid "stop and go" driving
Avoid excessive idling
Combine errands
Park in the shade

Being practical when it comes to driving makes sense. It saves time and money. Being more economical while driving reduces gas emissions and air pollution. It also reduces the need to spend more money at the gas pumps.

TIRES

As a driver, you cannot neglect the fact that you need to learn about car tires. Keeping your tires properly inflated can improve your gas mileage by as much as 3.3 percent. Properly inflated tires are also safer and last longer. The correct tire pressure for your vehicle is usually found on a sticker located on the driver side door jam. You can also check your owner's manual.

The first type of tire is the all season or standard tire. This type of tire is suitable for all types of usage and it works regardless of wet or dry condition. The tread on the tire is designed to minimize the noise and provide more grip in a wet condition. However, this is not always the best tire to use for icy road conditions.

The second type of tire is the performance tire which is used for faster cars. This type of tire is durable in dry weather but not suitable for wet weather. Use this type only if you live in a dry area with little rain throughout the year.

The third type of tire is the winter tire, which is extremely durable against extreme weather such as snow and ice. This tire is not to be used in dry conditions as it will get damaged on the road.

STEERING

Steering is unbelievably important in so many regards, both for speed and safety. A well designed car does not suddenly break into a skid. As the tire approach the traction limits, it tends to slip sideways across the road. The angle between the tires' actual path and its natural path is called its slip angle. This gives the driver advance warning that the front/rear of the car is in danger of losing traction and starting to skid.

If the rear tires approach their traction limit more rapidly than the front, the rear of the car will steer a wider path than the front wheels. This rotates the car more than the driver intended and, if nothing is done, leads to the car turning a smaller radius corner. When this occurs, the car is said to oversteer. Oversteer is when the car turns more than expected. It is a phenomenon whereby the rear tires lose its traction before the front wheel during cornering. This causes the rear of the vehicle to slide towards the outside of the corner, thereby creating a feeling that the car is trying to spin.

Rear wheel drive vehicles are more prone to oversteer. This is because the rear tires must handle both the lateral cornering force and engine torque, resulting in the rear tires approaching their

traction limit more rapidly. Over steer can be quite dangerous as it can land the car in a spin. Many drivers instinctively slam on the brakes when the vehicle begins to over steer. Slamming the brakes will only aggravate the situation, causing the rear tires to lose more traction. The correct reaction is to reduce the steering angle gently and ease off the accelerator.

If the front tire approaches the traction limit more rapidly, the effect is that the front of the car takes a wider radius curve than the driver intended. The car is said to under steer. Under steer is safer than over steer. If the car under steers and no correction is made, the result is a wider corner than intended. The car remains stable. If the car over steers, the turn made has smaller radius than intended. The smaller radius produces higher cornering forces, bringing the required traction even closer to the limit of the rear wheels, thus causing even more over steer. The situation will worsen until the rear wheels lose total grip; the car spins and all directional control is lost. Under steer is when the car turns lesser than expected. It is a phenomenon whereby the front tires lose its traction before the rear tires during cornering. Front wheel drive vehicles are more prone to under steer. This is because the front tires must handle both the lateral cornering force and engine torque. This results in the front tires approaching their traction limit more rapidly. Many drivers instinctively increase the steering angle when their vehicles under steer. Increasing the steering angle increases the cornering force, making the front tires lose traction completely. The correct reaction is to lift off the accelerator and apply the brakes. By doing that, more weight is transferred to the front tires to give them grip.

STEERING METHODS

There are four methods of steering, which can be used when turning at intersections, moving through curves, changing lanes, evasive actions, off-road recovery, operating vehicle controls, parking, turnabouts and backing. When performed properly, each can provide smooth, continuous steering control for specific vehicle control activities.

Hand-to-hand steering – Use hand-to-hand steering, commonly called push/pull steering, when turning the wheel during normal driving activity going forward above 10-15 mph. When using hand-to-hand steering your left hand grasps the wheel between 7 and 8 o'clock and your right hand grasps the wheel between 4 and 5 o'clock. Depending on the direction of the turn, your right or left hand pushes the wheel up and the opposite hand slides up, grasps the wheel and pulls down to continue the turn. While the pulling hand moves down, the hand that initially pushed up slides back toward its original position to make adjustments as needed. You should use the area on the wheel between 11 and 8 o'clock with the left hand and the area on the wheel between 1 and 8 o'clock with the right hand regardless of the direction of the turn. Simply reverse the hand-to-hand process to bring the vehicle into your intended path. Since your hands and arms never cross over the steering wheel, there is less chance of injury to the face, hands and arms in the event of a frontal crash when a vehicle is equipped with a driver side air bag. This is the preferred method of steering, the 2 and 10 o'clock position is not recommended because it can be dangerous in vehicles equipped with air bags.



Hand-over-hand steering – Use hand-over-hand steering when turning the wheel at low speeds, such as at an intersection or when parking the vehicle. When using hand-over hand steering, your left hand grasps the steering wheel between 8 and 9 o'clock and your right hand grasps the wheel between 3 and 4 o'clock. Depending on the direction of the turn, use the right top third of the steering wheel to move the wheel to the right and use the left top third of the wheel to move the wheel to the left. This process is repeated as necessary. Simply reverse the hand-over-hand process to bring the vehicle into your intended path.

Evasive action steering – When anti-lock brakes are engaged (if equipped) and steering inputs are required to avoid a hazard or the vehicle is forced off the roadway, it may be necessary to limit the steering input to avoid moving out of the intended lane of travel and across other lanes of travel. As speeds increase much less steering input is needed to move the vehicle one lane space to the left or right. Modern vehicles only take 45 to 90 degrees of steering to move a vehicle back on the road after an off-road encounter. It is critical to limit the steering to not more than 180 degrees of steering when trying to evade a problem on the roadway. When more than 180 degrees of input is used, traction loss occurs and the vehicle often moves across the roadway in the path of oncoming vehicles.

One hand steering – Use one hand steering only when backing or operating vehicle controls (wipers, flashers, lights, etc.) that require a temporary reach from the steering wheel. When the driver is required to reach for an operating control, it is important to keep the other hand in the normal vehicle operating position of 8-9 o'clock or 3-4 o'clock, depending on the steering wheel design. The only time that 12 o'clock is recommended is when backing a vehicle to the left or right and the driver has to turn in the seat in order to see the path of travel.

CORNERING

Every corner is made of three parts; the entry, the apex, and the exit. The entry is where turning begins. The apex is the point where the car reaches the furthest point on the inside of the turn. The exit is when the car is driving straight again.

This **10-point plan** explains how to get cornering right.

1. Both hands on the wheel, at nine and three o'clock. You can neither safely nor correctly steer a car one-handed, or with your hands in the wrong positions. It's that simple. And there is very little, if any, need to reposition your hands during 99.9 per cent of open-road driving in a reasonably modern car.
2. Look as far around the bend as possible. Eyes are the main thing that steers a car, not hands. Look where you want to go – as far ahead as possible. You'll get more time to react if there's an obstacle ahead, and the process will be much smoother. Look through the side mirror if necessary. Don't stop at the border of the windshield if the bend is tight. If there is vegetation, try to see as far ahead as possible.
3. Judgment. The open road is not your wide screen television. There are real risks, such as oncoming traffic and roadside obstacles. Be conservative, and employ safety margins, no matter how good you think you are. Always be prepared for the unexpected.
4. Speed matters. The right speed is very hard to judge in cornering. Why? This is because cornering load (or force) depends on speed squared. That means doubling the speed generates four times the cornering force. Fifty per cent more speed in a corner generates well over double the cornering load. It's easy to exceed the available grip under the tires, because small changes in speed make relatively big changes to cornering load, and that makes the right speed hard to judge. (Unfortunately, advisory speed signs are notoriously inconsistent.)
5. Slow in. The most efficient, smoothest way around a bend is to enter it a little on the slow side. Entering too fast may cause a loss of control. Slower in means smoother on the way through, and faster out – a safer, more efficient way to travel.

6. Smooth is safe. Rough driving is a great way to lose control. If you find yourself pushing the wheel aggressively, giving the car too much gas or braking on the way around a bend, you're in dangerous territory. And you're showing how little you really know about driving. Slow down a notch, drive smoothly. Be gentle on the controls – all three of them, wheels, brakes and steering.
7. Entry. Ease off the gas as you turn in. This causes a little weight to transfer forwards, adding weight to the front wheels and helping the steering grip the road. Don't go over the center line when making a right turn. Keep out wide to maintain a safety margin against wayward oncoming drivers. Steering and acceleration work together. Lifting off the accelerator and turning in with the steering is a natural combination that helps the car do what you want.
8. Mid-corner. Add a little acceleration, not very much – just enough to balance the car up, and keep looking around the bend on your intended travel path. If you start to run a little wide, ease off the accelerator and add some steering. You shouldn't have to move your hands very much in the middle phase of most corners.
9. Exit. The opposite strategy to entry. As you see the corner open up and some straight road ahead, add some acceleration (gently) and start unwinding the steering. The car should transition smoothly from cornering to straight ahead if you get it right. Remember, cornering is about subtle control inputs, not gross ones.
10. Planning. Most people get into trouble in corners because they get into them before they sort them out mentally. Then the cornering process drives them, not the other way around. So don't get distracted. Keep ahead of the game mentally, and pay particular attention to balancing the car's entry speed to the corner's severity.

SEASONAL CHANGES AND HOW THEY AFFECT DRIVING

The change of seasons brings new and different driving conditions. Each season of the year presents its own driving challenges—from wet and icy road conditions, to vehicle maintenance, to awareness of pedestrians and others using the roadways. Understanding how to drive safely in all conditions can protect you, your passengers, and your vehicle—no matter what the weather.

Many drivers can't wait to get out on the roads after the winter thaw. But with spring there is rain, warmer weather, and more activity on the roadways. In spring, the after-effects of winter weather— potholes and uneven pavement—make road conditions rough.

Keep these driving tips in mind before you travel:

1. **Spring showers bring May flowers—and wet driving conditions.** Slow down on slick roads, and increase your following distance even when mist begins to fall. Just a small amount of water can mix with oil and grease on the road to create slippery conditions.
2. **Share the road.** Warm weather brings motorcyclists, bicyclists, and pedestrians out on the roads.
3. **Understand the impact of medications on driving.** Keep in mind that new spring growth often causes seasonal allergies, and over-the-counter allergy drugs can have side effects or interact with other medications to diminish your driving ability.
4. **If possible, go around potholes.** They can throw your car's front end out of alignment.
5. **Avoid driving through large puddles,** which can impair your brakes, dirty your windshield, or cause you to hydroplane.
6. **Keep your tires properly inflated.** Doing so can reduce damage from potholes and other road hazards.



Summer usually means vacation time and hot weather conditions. To keep yourself safe and cool on the roads, follow these summer driving-safety tips:

1. **The summer sun can create dangerously hot temperatures in your vehicle.** Be sure to check that your air-conditioning system is functioning properly before traveling. Do not leave pets or children waiting in a car.
2. **Summer temperatures can wreak havoc on your vehicle.** Before you head out on the road, be sure to have your car serviced and inspected for safety.
3. **Check your fluid levels.** This includes oil, transmission, coolant, brake, power-steering, and windshield.
4. **If planning a road trip, get up-to-date maps from a reliable source.** Share your itinerary with family.
5. **When packing up for a trip, make sure not to exceed your car's payload capacity.** This is the maximum weight of all cargo and passengers that the vehicle can safely carry.
6. **Make sure your tires are properly inflated.** In hot summer months, for every 10-degree Fahrenheit increase in air temperature, tire pressure increases approximately one pound.
7. **Warmer weather signals the start of many road-construction projects.** To safely navigate through construction zones, obey all signs and watch for construction workers and their vehicles.
8. **When parked, use a sun shield underneath the windshield.** In summer months it is important to keep heat to a minimum and to protect your vehicle's interior.
9. **The end of summer signals the start of school.** Be familiar with school zones, and get into the habit of noticing where school zones and crosswalks are on roads you generally travel.

When people think of the arrival of fall, they think of colorful fall foliage, and crisp, clear days. But along with the changing leaves come changing driving conditions. Fall driving can be unpredictable because of weather changes and the end of daylight saving time. To be safe and aware on the roads this fall, follow these guidelines:

1. **Watch out for falling leaves.** Once leaves become wet, they can present slippery and dangerous driving conditions. Be sure to watch for patches of wet leaves on the road or on road lines. Dry leaves can also present a problem to your vehicle. Avoid parking your vehicle near leaf piles to prevent fires that could start from your vehicle's catalytic converter.
2. **Stay alert on the road.** The end of daylight saving time means reduced visibility on the roads, which can create unfamiliar driving conditions. Even on familiar roads, it is important that motorists use additional caution and adjust their driving habits to watch for pedestrians, cyclists, and other roadway users who will be less visible.
3. **Check your tire pressure.** With frequent weather and temperature changes, tires can expand and contract, causing them to lose air pressure. Make sure tires are properly inflated and have plenty of tread.
4. **Avoid sun glare.** With the change in time, you may need to adjust to the different morning or late afternoon glare from the sun. It can cause reflections off car windows and hoods and decrease your visibility. Have a good pair of sunglasses readily available to counter daytime glare, and consider lenses with anti-reflective coating to reduce glare when night driving cannot be avoided.
5. **Plan ahead for wet conditions.** Fall often brings rainfall, which can decrease visibility and cause hydroplaning. Make sure your windshield wipers are in good working condition. If driving on a road with excess water, slow down and avoid sudden movements with the steering wheel or brake pedal. If you feel like you are floating, steer straight and gently release the gas pedal until you feel the tires make contact with the road surface. In an especially heavy downpour, you may want to pull off the road until it's safe to continue.

Severe winter weather causes dangerous driving conditions. Whether dealing with snow, ice, or heavy rain and fog, drivers should be extra cautious in adverse winter weather. On rainy, snowy or foggy days, it is sometimes hard for other drivers to see your vehicle. In these conditions,

headlights make your vehicle easier to see. Avoid driving in bad winter weather whenever you can do so. If you must, though, remember that a reliable vehicle is essential. To keep yourself safe on the road in wintertime, follow these driving tips:

1. **Winterize your vehicle.** When cooler temperature become a factor, make sure your brakes, wipers, defroster, headlights, and heater are all working properly.
2. **Stop gently to avoid skidding.** If your wheels start to lock up, ease off the brake.
3. **Turn on your headlights to increase your visibility.** Keep your lights clean and free of ice or debris.
4. **In unfavorable driving conditions, reduce your speed.** Allow the distance to increase between your car and the one in front of you. Remember that it takes more time to stop on icy roads.
5. **Stay alert.** Look ahead to give yourself enough time to react safely to situations without suddenly braking or skidding.
6. **Before driving, clear ice and snow from your vehicle's hood, windows and roof.**
7. **Use snow or all-season tires or chains for better traction and smoother stopping.** No snow tires allow you to drive on snow or ice at normal speeds.
8. **Take extra precautions on bridges, overpasses and shaded areas, which can freeze first, and remain icy longer than roadways.** A road on which ice and snow are completely frozen is pretty slippery, even though it provides more traction than a road with melting ice.
9. **In wet driving conditions, do not drive faster than the windshield wipers can clear water from the windshield.** Make sure your wiper blades are in good shape and replace them yearly.
10. **Equip your car with emergency supplies.** Should you become stranded due to weather conditions, do not leave your vehicle. Items such as blankets, food, water, spare fuses, and a flashlight with batteries, an ice scraper, flares and a first-aid kit could become vital necessities.

As always, remember that each and every time you drive your vehicle upon the road you must pay attention to your surroundings whatever the time of year. Challenges are presented to you every time you drive. The most important safety feature of the automobile is the driver.



CHAPTER 5

SAFE DRIVING HABITS

DRIVING BEHAVIOR

There are many factors which determine an individual's attitude towards driving.

- Demographic – age, sex, employment background, education, where they live
- Personality – tolerance, aggressiveness, risk taking, susceptibility to peer pressure
- Developmental – physical, emotional, social, behavioral
- Environment – community involvement, risk perception, entertainment, parent's influence, peers behavior, spouse/partner behavior
- Driving Environment – daylight or dark, weather and road conditions, vehicle type, passengers
- Driving ability – knowledge, skill, experience

All of these factors combine and help to determine if a driver will be courteous, safe and law abiding or a tailgating, speeding and discourteous individual that fails to use his safety belt.

DEFENSIVE DRIVING

Most of us would like to believe we not only know what it takes to be a good driver and that we put that knowledge into practice every time we are behind the wheel. Unfortunately, most of us never get past the basics. Defensive driving involves a proactive attitude behind the wheel and anticipating potential hazards instead of simply reacting to them. You should know the limitations of both yourself and your vehicle and how to handle both in a hazard situation. Driving defensively means not only taking responsibility for yourself and your actions, but also keeping an eye on “the other guy.” The National Safety Council suggests the following guidelines to help reduce your risks on the road:

- Don't start the engine without securing each passenger in the car, including children and pets.
- Safety belts save thousands of lives each year!
- Lock all doors.
- Remember that driving too fast or too slow can increase the likelihood of collisions.
- If you plan to drink, designate a driver who won't drink. Alcohol is a factor in almost half of all fatal motor vehicle crashes.
- Be alert! If you notice that a car is straddling the center line, weaving, making wide turns, stopping abruptly or responding slowly to traffic signals, the driver may be impaired.
- Avoid an impaired driver by turning right at the nearest corner or exiting at the nearest exit.
- If it appears that an oncoming car is crossing into your lane, pull over to the roadside, sound the horn and flash your lights.
- Notify the police immediately after seeing a motorist who is driving suspiciously or recklessly.
- Follow the rules of the road. Don't contest the “right of way” or try to race another car during a merge. Be respectful of other motorists.

DEFENSIVE DRIVING TECHNIQUES

The SIPDE effectively teaches how to drive defensively.

SIPDE

S -Sweep, Search, and Scan (keep your eyes moving at all times to effectively see imminent danger)

I - Identify hazards, Identify what's happening (road-way features) (take notice of things that could cause trouble)

P - Predict which hazards could potentially come into conflict with you; predict 2 things 1-worst case scenario and 2-actions

D - Decide on a safe action (decide on something to do should the dog run across the road)

E - Execute a move to avoid conflict (braking, accelerating, turning, etc.)

Defensive driving not only ensures road safety. It also saves fuel, lowers the cost of insurance premiums, and increase the overall life of the vehicle.

DEFENSIVE DRIVING CHARACTERISTICS

While there are many characteristics of a defensive these four are essential to the driving task:

Alertness

A defensive driver will try to predict possible danger and be prepared to act accordingly. Good defensive drivers are alert to what is going on around them. They are well rested and would never take any drugs or alcohol that could affect their concentration before driving. You must always pay attention to details happening around you as you drive and if you are impaired in any way, you will not be able to do that properly.

Anticipation

Defensive drivers maintain a safe following distance. Defensive drivers anticipate what may or may not happen, and they take action to avoid many problems. Tailgating and following too closely does not allow for the needed seconds to avoid a possible crash. You must anticipate potential hazards from other drivers, motorists, pedestrians, weather and equipment and take steps to minimize the risk.

Judgment

Make sure you do not exceed the posted speed limit. In poor weather conditions, slow down so you are able to control your vehicle. Good defensive drivers do not make risky maneuvers like trying to beat red lights or trains. They don't try to pass unless it's safe and they look for alternatives to any traffic situation.

Skill

Good defensive drivers have the skills to operate a vehicle safely through traffic without endangering anyone else on the road. A defensive driver is aware of the blind spot of the vehicle in front of them. A good defensive driver will scan the road ahead, avoid being distracted, and maintain road discipline.

A careful, responsible driver that obeys the laws and regulations of the road will do more to lower the nation's accident rate than any safety feature of a car.

DRIVING UNDER STRESS

Any stress situation can affect your driving. Even mild emotional feelings can affect your driving ability. Emotions are hard to control and they can make you temporarily accident prone. Driving in traffic routinely involves events and incidents. Events are normal sequential maneuvers such as stopping for the light, changing lanes, or putting on the brakes. Incidents are frequent but unpredictable events. Some of these are dangerous and frightening, like near-misses, while others are merely annoying or depressing, like missing your turn or being insulted by another motorist. Driving events and incidents are sources of psychological forces capable of producing powerful feelings and irrational thought sequences.



Driving is a highly dramatic activity that millions of people perform routinely on a daily basis. The drama stems from high risk and unpredictability. Driving has two structural components that conflict with each other--predictability and unpredictability. Both are present all of the time. Predictability, like maintaining steady speed in one's lane creates safety, security and escape from disaster. Unpredictability, like impulsive lane changes without signaling, creates danger, stress and crashes.

For many people, driving is linked to the value of freedom of being able to go wherever they want whenever they want. On the one hand, an individual is able to get into an automobile and drive wherever they please, the symbol of freedom and independence. But on the other hand, as they begin to drive on the open road, they encounter restrictions and constrictions, preventing them from driving as they wish due to regulations and congestion.

If you are worried, nervous, angry, frustrated or depressed, let someone else drive. You may become impulsive and aggressive and take risks you normally wouldn't. You should avoid driving when you are not emotionally prepared to handle the additional stress that driving can cause.

DRIVER FATIGUE

Driving is work. It is tiring. It takes a person in good physical, mental and emotional condition to actively prevent crashes. When you are tired, you don't drive as well as you do when you are rested.

Driver fatigue can kill. Just like alcohol and drugs, it impairs your vision and judgment. Drivers should not push themselves to the point of not being physically and mentally alert at all times. A driver should rest every two hours and not drive longer than six or eight hours a day.

Fatigue can affect you in several ways. It slows your reaction time. There is a loss in your concentration and attention. Extreme fatigue may lead to moments of dozing behind the wheel. Driving under these conditions may lead to collisions. You have many ways of fighting fatigue. Take a break (at a rest area if on the interstate). Have a cup of coffee. Chew gum. Listen to the radio. Let some fresh air into your car.

Boredom is common to motorists on long trips, especially when driving on an interstate highway. It can lead to what is called "highway hypnosis." That is, your senses become dulled, your eyes become fixed on the road and you are not alert to traffic situations around you. To keep from getting tired on a long trip:

- ✓ Be well rested before you start.
- ✓ Don't take any drugs that can make you drowsy.
- ✓ Try not to drive late at night when you are used to sleeping.
- ✓ Take regular rest stops, even if you are not tired.
- ✓ Keep moving your eyes. Look at objects near and far, left and right.
- ✓ Open the window and get some fresh air.
- ✓ Keep your car's interior cool.

If nothing seems to help you stay awake, get off the highway and take a short nap. This could save your life.

DROWSY DRIVING

According to recent statistics, drowsy driving causes more than 56,000 crashes every year. The National Highway and Traffic Safety Administration suggest there may be some common factors involving these crashes.

- The crash occurs late at night or early in the morning
- The crash is likely to be serious
- The crash involves a single vehicle which leaves the roadway
- The crash occurs on a high-speed road
- The driver does not attempt to avoid the crash
- The driver is alone in the vehicle



HOW TO PREVENT DROWSY DRIVING

- Begin your journey well rested.
- Avoid driving late night and early morning hours, which are the body's natural sleep times.
- Set realistic travel goals about the time it will take to reach your destination.
- Eat healthy meals. Avoid foods high in fat and sugar, which can contribute to fatigue.
- Avoid using alcohol or drugs.
- Share the driving. Switch drivers every two hours, even if you don't feel tired.
- Take regular breaks. Stop every two hours to stretch.
- Drink water, juice, or a soft drink low in sugar and caffeine. Sugar and caffeine promote short-term alertness but may increase drowsiness over longer periods of time.
- Keep the inside of your vehicle at a cool temperature.
- Listen to radio talk shows rather than music. The discussion format will help keep you alert.
- Try to limit driving between midnight and 6 a.m.

Warning Signs of Drowsy Driving

- ◆ Inability to recall the last few miles traveled
- ◆ Having difficulty focusing or keeping your eyes open
- ◆ Drifting from the lane in which you are driving
- ◆ Having disconnected or wandering thoughts
- ◆ Feeling as though your head is very heavy
- ◆ Missing traffic signs
- ◆ Yawning repeatedly
- ◆ Tailgating other vehicles

Young males between the ages of 16 and 29 seem to be more at risk. Individuals that work shift work and have their sleep patterns disrupted also face higher risk for drowsy driving.

ILLNESS AND DRIVING

Certain health conditions can affect your ability to be a safe driver. Some of these conditions may be short term, such as the anesthesia given during a surgical procedure. The doctor may advise you not to drive for a certain length of time. Some conditions may be permanent. There are many other drugs that can affect your ability to drive safely. These drugs can have effects like those of alcohol, or even worse. This is true of many prescription drugs, and even many of the drugs you can buy over-the-counter without a prescription.

Over-the-Counter Drugs

Over-the-counter drugs taken for headaches, colds, hay fever or other allergies or those to calm nerves can make you drowsy and affect your driving. Pep pills, “uppers” and diet pills can make you feel nervous, dizzy, unable to concentrate, and they can affect your vision. Check the label on the product before you take an over-the-counter drug for warnings about its effect. If you are not sure if it is safe to take the drug and drive, ask your doctor or pharmacist about any side effects.

Prescription Drugs

Some prescription drugs can impact driving and can affect your reflexes, judgment, vision, and alertness in ways similar to alcohol. Prescription drugs, such as antidepressants, pain reducers, sleep aids and sedatives will have an impact on driving safely. Check the label on the prescription and packaging before you take a drug for warnings about its effect. If you are not sure if it is safe to take the drug and drive, ask your doctor or pharmacist about any side effects.

Various health conditions which may affect your ability to drive safely could be:

Blackouts or fainting	Vision Problems	Heart Disease
Epilepsy	Sleep Disorders	Diabetes
Psychiatric disorders	Neurological disorders	Age-related decline

If you become aware of a health issue in a family member or yourself you should not hesitate to talk with someone. Having any of these conditions does not necessarily mean that you will be unable to continue driving. But you may need to visit your doctor more often. You may also need to restrict driving to daylight driving only, wearing corrective lenses when driving, or only driving on familiar streets and roads. Everyone has a responsibility to be certain they are fit to drive. At the time of any driver's license issuance you are asked three questions pertaining to your mental and physical health. You should honestly disclose any information that may affect your driving.



If you drive a commercial vehicle or need your license to earn a livelihood, you will be subject to higher medical standards than an individual that only drives a passenger vehicle. Please consult the Louisiana Commercial Driver's License manual for reference.

If for some reason you must give up your driving privileges, a Louisiana identification card is available at your local Motor Vehicle office.

DON'T BE A TAILGATOR!



AGGRESSIVE DRIVING/ROAD RAGE

Aggressive driving is a traffic offense or combination of offenses such as following too closely, speeding, unsafe lane changes, failure to signal intent to change lanes and other forms of negligent or inconsiderate driving. Aggressive drivers can be dangerous drivers. Drivers who do not follow the rules of the road are a hazard to all motorists, bicyclists, and pedestrians on the roadway. They put themselves and others at risk with their unsafe driving.

Speeding, running red lights and stop signs, pulling in front of trucks too quickly when passing and making frequent lane changes, especially in the blind spots of trucks, can create dangerous and potentially fatal situations on the road. These situations can lead to road rage not only for the aggressive driver, but also for others sharing the road.

To keep control of your driving, you should.....

- Allow plenty of time for trips.
- Understand that you cannot control traffic, only react to it.
- Be polite and courteous.
- Alter schedule to avoid driving during peak roadway congestion periods.
- If running late, call ahead so you can relax.
- Avoid driving when angry, upset, or overly tired.
- Give others the benefit of the doubt.
- Relax and remain aware of your posture.
- Sit back in your seat and don't clench your teeth.
- Driving is not a contest. It is not about winning.

When confronted by an aggressive driver, you should.....

- Avoid eye contact and steer clear, giving drivers plenty of room.
- Stay calm and relaxed. Be a cautious and courteous driver.
- Make every attempt to get out of the way safely. Don't escalate the situation.
- Put your pride in the back seat. Do not challenge an aggressive driver by speeding up or attempting to hold your position in the traffic lane.
- Ignore gestures and refuse to return them.
- Keep anger from building by not letting other drivers or situations upset you.
- Emotionally and mentally disconnect from the situation.
- Whenever possible, put as much distance between you and the aggressive driver.
- Don't tailgate and don't use the horn to "punish" the other driver.

If the aggressive driver persists:

Do not stop and try to solve it on the side of the road. Drive to a police station or a public place where witnesses are readily available. Most people don't want to cause trouble when others can see them. Above all, don't drive home if someone is following you. Road rage is a criminal offense. This occurs when a traffic incident escalates into a far more serious situation. For example, a person becomes so angry about an aggressive driving incident that he overreacts and responds with some type of violence. The violent act(s) may range from a physical confrontation to an assault with a motor vehicle or possibly a weapon.



Feelings of anger experienced by people driving in difficult conditions may lead to violent behavior. Driving is the most dangerous thing we do on a routine basis. It is emotionally challenging because unexpected things happen constantly. Emotional intelligence is a critical factor in safe driving.

Actions Associated With Road Rage

- ◆ **Blowing the horn**
- ◆ **Pursuing another vehicle**
- ◆ **Flashing head lights**
- ◆ **Forcing a car off the road**
- ◆ **Forcing a car to pull over**
- ◆ **Verbal abuse and/or "sign" language**
- ◆ **Bumping into another car**
- ◆ **Tailgating**
- ◆ **Threatening another driver**
- ◆ **Braking or slowing suddenly**
- ◆ **Damaging another vehicle intentionally**
- ◆ **Deliberate obstruction**
- ◆ **Physically assaulting another driver**
- ◆ **Cutting off or swerving in front of another vehicle**

How to Avoid Road Rage

- ❖ **Be calm**
- ❖ **Keep a good distance**
- ❖ **Stay alert**
- ❖ **Behave cooperatively in traffic situations**
- ❖ **Create a relaxing and comfortable environment in your car**
- ❖ **Don't speed**
- ❖ **Allow adequate time for your trip**
- ❖ **Avoid tailgating**

If someone cuts you off by mistake, be calm. Always stay alert. Keep your eyes open for other drivers and stay away from aggressive motorists instead of irritating them even more. Keep a good distance between your car and the one in front of you.

If you witness aggressive driving, contact law enforcement as soon as possible.

Tailgating is a very common cause of crashes and can be avoided by simply moving to the right lane and letting the faster driver pass. Try to avoid following other cars closely because you never know when the driver in front of you will slam on the brakes and stop.

Don't speed. Respect the speed limits. Driving fast will only get you to your destination a mere few minutes earlier. Driving at more controlled speeds will provide you with longer reaction time to change lanes, exit or stop your vehicle.

LOOKING AND SCANNING AHEAD

In order to avoid last second moves, a driver needs to look far enough ahead to see things early. Your line of sight is the visible path of travel from your vehicle to the area you are looking at further down the road. A common mistake drivers make is looking right in front of the car instead of down the road. Looking 10 to 15 seconds ahead will allow time to prepare for traffic conditions. It also makes it easier to keep your car on a steady path. If your view is blocked due to a curve, a hill, or another vehicle, you must slow down and be ready to make adjustments to your path of travel.

Look ahead –In order to avoid emergency braking or steering, you should look well down the roadway to the end of the travel path. By looking well ahead you can operate a vehicle more safely, save on fuel, help keep traffic moving at a steady pace and allow yourself time to see better around your vehicle and along the side of the road. Looking well down the travel path will also help you to steer with less weaving.

In the city, you should look at least two blocks or two traffic signals ahead. In an urban area, you should look at least three blocks or three traffic signals ahead. On the highway, you should look at least a quarter of a mile ahead.



When looking well ahead look for vehicles coming onto the roadway, into your lane, or turning. Watch for brake lights from slowing vehicles. By seeing these things far enough ahead, you can change your speed, or change lanes if necessary to avoid a problem. If you see a traffic light that has been green for a long time, it may change to red before you get there. Therefore, you should start slowing down and be ready to stop.

By seeing problems ahead early, you can drive more safely, which also helps drivers behind you drive more safely too. Making driving changes well ahead of time gives drivers behind you more time to react. The earlier you act, the less often someone behind you has to react quickly to your vehicle

Scanning Well Ahead in the Travel Path

You can calculate how far ahead to search by:

1. Finding a stationary object like a sign or telephone pole near the road as far ahead as you can see.
2. Start counting: one-thousand-one, one-thousand-two, one-thousand-three, etc., until you reach the object.
3. The number of seconds you have counted is the number of seconds ahead that you were looking.

To identify potential problems in the travel path you need a visual lead. A visual lead is an area 20 to 30 seconds ahead from the front of the vehicle. Having a good visual lead and using good searching skills helps you see changes in your travel path and identify alternative paths of travel. If something is in your vehicle's travel path that requires a speed reduction, it is critical to see the problem with time to stop or steer around it.

It takes much longer and further to stop than many drivers realize. Even if your vehicle has good tires, brakes, and the pavement is dry:

- At 60 mph, it can take about 4 to 5 seconds or 359 feet to react to a problem and bring the vehicle to a stop.
- At 30 mph, it can take about 2 to 3 seconds or 123 feet to react to a problem and bring the vehicle to a stop.

At 60 mph, if you cannot see at least 400 feet ahead, you are driving too fast for your visibility. At 30 mph, if you cannot see at least 150 feet ahead, you may not be driving safely. Without an adequate visual lead by the time you see an object in your travel path, it may be too late to stop without hitting the object.

Look to the sides – At any time other vehicles or pedestrians may cross or enter your travel path. You should search to make sure other roadway users will not cross your travel path. This is especially true at intersections and highway-railroad grade crossings.

Intersections – Intersections are any place where traffic flow merges or crosses. Intersections may include cross streets, side streets, driveways, shopping center lanes or parking lot entrances. When approaching an intersection check for oncoming and cross traffic, other roadway users, traffic control devices, areas of limited visibility and the condition of the roadway. Before entering an intersection, look to the front, left and right for approaching vehicles and/or crossing pedestrians. If stopped, look left, right and left again before entering the intersection.

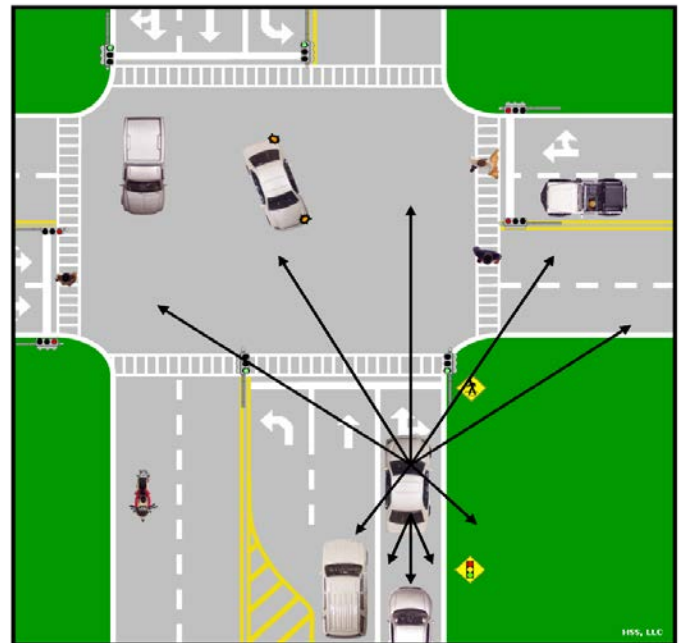

Crossing an Intersection – Do not rely on traffic signals or signs to tell you that no one will be crossing in front of you. Some drivers may not obey traffic signals or signs or may not see them. At intersections, look to the front, left and right, even if other traffic has a red light or a stop sign. This searching technique is especially important just after the light has turned green. People on the cross street are most likely to hurry through the intersection before the light changes to red. Make sure the travel path is clear all the way through the intersection and you can clearly see crossing traffic before entering an intersection so you will not block the intersection if you have to stop. If you are stopped and your view of traffic or a cross street is blocked, edge forward slowly until you can see. By moving forward slowly, crossing drivers can see the front of your vehicle before you can see them. This gives them a chance to slow down and warn you if needed.

Whenever there is a lot of activity along the side of the road, there is a good chance that someone will cross or enter the road. Therefore, it is very important to look to the sides when you are near shopping centers and parking lots, construction areas, busy sidewalks, playgrounds and schoolyards.

Turning Left – When turning left at an intersection, pull into the intersection to be ready to turn left. Before turning left across oncoming traffic, look for a safe gap in the traffic. You must yield to oncoming vehicles going straight ahead or turning right. Prior to turning, search to be sure that there are no vehicles or pedestrians in the travel path that could leave your vehicle stranded in the path of oncoming traffic. Be sure you turn into the appropriate lane.

Turning Right – Before turning right, make sure that there is no traffic approaching from your left and no oncoming traffic turning left into your path. Do not begin turning without searching for pedestrians crossing.

Highway-railroad grade crossings – Approach any highway-railroad grade crossing by slowing down at the round warning sign and looking in each direction prior to the tracks to make sure a train or railroad maintenance equipment is not coming.

Look to the rear – Besides watching traffic ahead of you, you must check traffic flow to the rear. You need to check to the rear more often when traffic is heavy. This is the only way you will know if someone is following too closely or coming up too fast. The searching process will give you time to change speed or change lanes avoiding any potential problems. It is very important to look for vehicles to the rear prior to changing lanes, slowing down, entering traffic from the side of a street or driving down a long or steep hill.

When changing lanes – Prior to changing lanes, you must check for traffic in the lane you want to enter and behind your vehicle. Changing lanes may include: changing from one travel lane to another, merging onto a roadway from an entrance ramp, moving onto a roadway from a yield intersection, or entering the roadway from the curb or shoulder. When changing lanes, you should:

- Maintain a safe following distance and look in your rearview and side mirrors to make sure there are no vehicles in the lane or entering the lane you want to enter and no driver is about to pass.
- Check your “blind spots” by turning your head and looking over your shoulder in the direction you plan to move. Blind spots are areas around your vehicle that you cannot see with your mirrors. Be sure no one is near the rear corners of your vehicle.
- Traffic ahead of you could stop suddenly while you are checking traffic to the sides, rear or over your shoulder. Do not have to look too long at any one time.
- Identify a 4 to 5 second gap in traffic, signal and look again in the direction of the lane change. Adjust speed and steer into lane. Cancel turn signal.

When you slow down – Use your mirrors to check behind your vehicle whenever you slow down. This is very important to check when you slow down quickly or at points where a following driver would not expect you to slow down, such as private driveways or parking spaces.

When going down a long or steep hill – Check your mirrors for vehicles approaching quickly when you are going down hills or mountains. Vehicles often build up speed going down a steep grade. Be alert for large trucks and buses that may be going too fast.

When driving we must practice active attention. We must remain guided by alertness, concentration, and interest. This involves effort on the part of the driver.

REAR VIEW MIRRORS AND BLIND SPOTS

In 1995, the Society of Automotive Engineers (SAE) published a research paper that recommended how we should adjust our side and windshield rearview mirrors to eliminate blind spots. That research showed that you should adjust the side mirrors as far outward as you can so that the viewing angle of the side mirrors just overlaps the view of the center rearview mirror. In this manner, you use the center rearview mirror to see what is coming up from behind, while the outside mirrors reflect the area outside the view of the center rearview mirror.

To adjust your mirrors properly:

1. First, adjust your rearview mirror so that it frames the rear window. You should be able to see traffic flow to the rear of the vehicle with the rearview mirror.
2. Place your head against the driver's side window and adjust the driver's side mirror so you can barely see the driver's side of your car.

Enhanced Mirror Settings

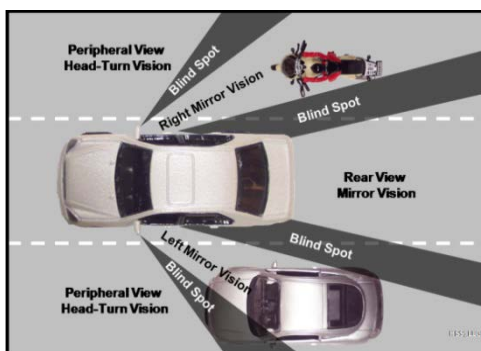

Traditional Mirror Settings

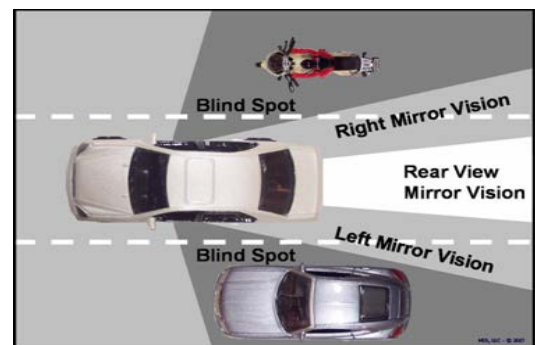

3. Move your head as close to the center of the car as possible and adjust the passenger's side mirror so you can barely see the passenger's side of your car.
4. To test your adjustments, watch a car pass you in the next lane. The passing car should be seen in your side mirror before it fully leaves the center rearview mirror. You should also detect the passing car in your peripheral vision before it leaves the outside rearview mirror.

Always remember that the center inside rearview mirror is the primary mirror. Although it may take time to get used to not seeing the sides of your car in the side mirrors, it is very important for your rear view mirrors to be in the correct position so that you can see as much as possible of the traffic behind you as well as those that might be in your blind spot.

STOPPING DISTANCES

Perception distance is how far your vehicle travels in ideal conditions; from the time your eyes see a hazard until your brain recognizes it. Keep in mind certain mental and physical conditions can affect your perception distance. It can be affected greatly depending on visibility and the hazard itself. The average perception time for an alert driver is $\frac{3}{4}$ second to 1 second.

Reaction distance is how far you will continue to travel, in ideal conditions, before you physically hit the brakes, in response to a hazard seen ahead. The average driver has a reaction time of $\frac{3}{4}$ second to 1 second. At 50 mph this accounts for 55 feet traveled.

Braking distance is how far your vehicle will travel, in ideal conditions, while you are braking. At 50 mph on dry pavement with good brakes, it can take about 158 feet.

Total stopping distance is the total minimum distance your vehicle has traveled, in ideal conditions; with everything considered, including perception distance, reaction distance and braking distance,

until you can bring your vehicle to a complete stop. At 50 mph, your vehicle will travel a minimum of 268 feet.





The faster you drive the greater the impact or striking power of your vehicle. When you double your speed from 20 to 40 mph the impact is 4 times greater. The braking distance is also 4 times longer. Triple the speed from 20 to 60 mph and the impact and braking distance is 9 times greater. At 60 mph, your stopping distance is greater than that of a football field. Increase the speed to 80 mph and the impact and braking distance are 16 times greater than at 20 mph. High speeds greatly increase the severity of crashes and stopping distances. By slowing down, you can reduce braking distance.

There is no simple way to tell exactly how long it will take you to stop at a certain speed. Your stopping distance depends on:

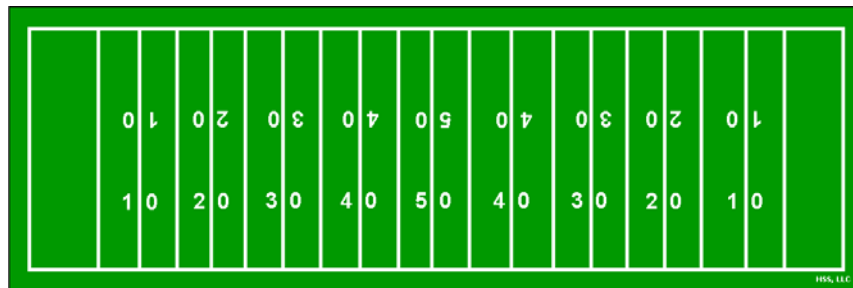
- Your own reaction time
- Weather and road conditions
- The weight of the vehicle
- The condition of the brakes
- The type and condition of the tires

The chart below and a familiar comparison give an estimated number of feet your car will travel on dry pavement from the time you see danger until you come to a stop.



20	22 ft	22 ft	25 ft		69 feet total
30	33 feet	33 feet	57 feet		123 feet total
40	44 feet	44 feet	101 feet		189 feet total
50	55 feet	55 feet	158 feet		268 feet total
60	66 feet	66 feet	227 feet		359 feet total
MPH	Perception Distance	Reaction Distance	Braking Distance		

FOLLOWING DISTANCES

Since most people have trouble judging distances, the “3-second rule” makes it easier for you. You can use it at any speed.

How to use the “three second “rule:

- Choose some object ahead of the vehicle in front of you, such as a sign, pole or a tree.
- As the vehicle in front passes the object, begin counting three (3) seconds (one-one-thousand, two- one-thousand, three-one-thousand)
- If it takes less than three (3) seconds for your car to pass the checkpoint, you are following too closely.
- If so, drop back and then count again at another spot to check the new following distance.
- Repeat until you are following no closer than “three seconds.”

There are situations where you need more space in front of your vehicle. In the following situations, you may need a four-second following distance to be safe. Increase the following rule (above) to four (4) seconds during bad weather or when driving on wet pavement. If another vehicle moves into the space between your car and the one ahead, drop back to a safe following distance.

When to use the “four-second” rule:

- **Slippery roads** – You need more distance to stop your vehicle on slippery roads and should leave more space in front of you vehicle. If the vehicle ahead suddenly stops, you will need the extra distance to stop safely.
- **The driver behind you wants to pass** – Slow down to allow room in front of your vehicle. Slowing down will also allow the pass to be completed sooner.
- **Following motorcycles** – If the motorcycle and its’ rider should fall; you need extra distance to avoid the obstacle. The chances of a fall by a motor cycle rider is greatest on wet and icy roads, gravel roads and metal surfaces such as bridges, grating and streetcar or railroad tracks.
- **Following drivers who cannot see you** – The drivers of trucks, buses, vans or vehicles pulling campers or trailers may not be able to see you when you are directly behind them. They could stop suddenly without knowing you are there. Large vehicles also block your view of the road ahead. Falling back allows you more room to see ahead.
- **You are being followed closely** – If you are being followed closely, pull to the right and allow the vehicle behind you to pass.
- **Pulling a trailer** – The combined weight of a vehicle and trailer increases the stopping distance.
- **Low visibility** – When it is hard for you to see ahead because darkness or bad weather, you need to increase you following distance.
- **Following emergency vehicles** – Police vehicles, ambulances, and fire trucks need more room to operate.
- **Railroad crossings** – Leave extra room for vehicles required to stop at railroad crossings, including transit buses, school buses, and vehicles carrying hazardous materials.
- **Stooped on a hill or incline** – Leave extra space when stopped on a hill or incline. The vehicle may roll back when it starts up.

TURNING AROUND ON NARROW STREET

Try to avoid turning around on a busy street. It is better to circle an entire city block. However, if you are on a narrow street when traffic conditions are light, and you find it necessary to turn around, here are the steps you should follow:

- Stop close to the right edge of the pavement.
- Look over your left shoulder and check traffic behind you. Do not depend on your rear view mirror alone; be sure that the street is clear both ahead and behind.
- Signal for a left turn. Then, follow the steps in the drawing.

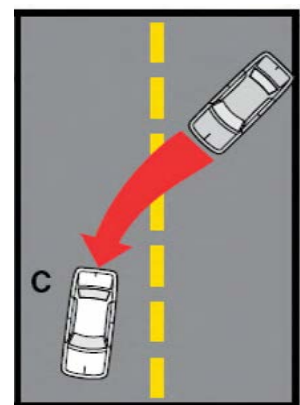
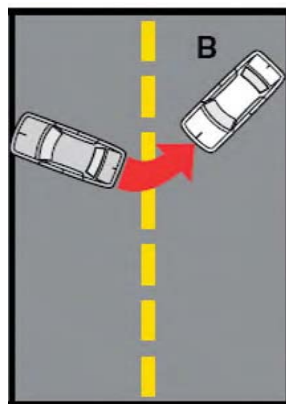
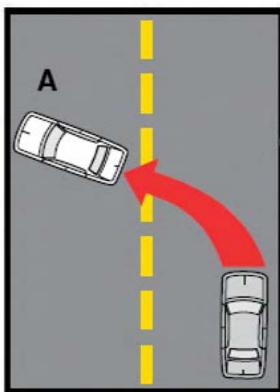

Three-Point Turnabout – This is the most difficult and dangerous way to perform a turnabout. Use it only when the road or street is too narrow to make a U-turn and you cannot go around the block. This type of turn should only be used on a two-lane roadway. To perform a three-point turnabout:

- Check the mirrors and activate your right turn signal to communicate your intention to pull off to the right side of the road. Stop on the right side of the road.
- Activate your left turn signal, check traffic and check blind spot by looking over your left shoulder. When traffic is clear, turn hard left to the other side of the road and stop once you have reached the other side.
- Place the vehicle in reverse, check traffic and check blind spots to both sides by looking over your shoulder. When traffic is clear, turn hard right to the other side of the road and stop.
- Place the vehicle in drive, activate the left turn signal, and check traffic and blind spots. When traffic is clear, turn hard left and drive forward into the right lane of traffic heading in the new direction. Check traffic and make sure your turn signal has cancelled. Continue driving straight in the new direction of travel.

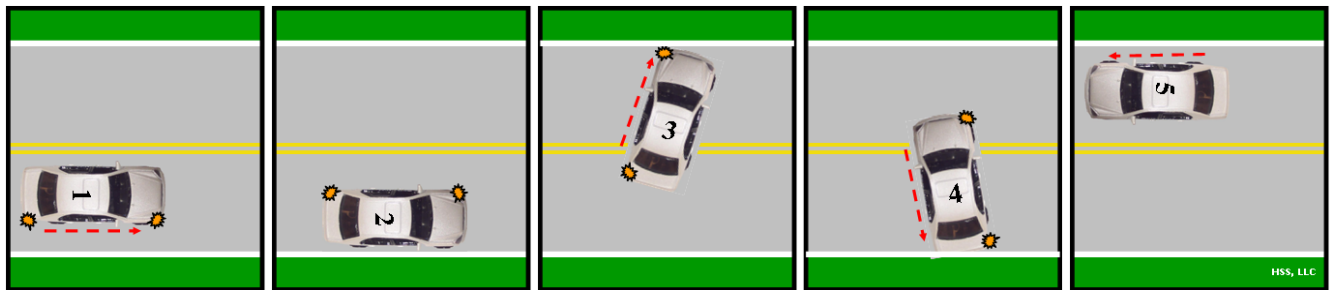

PARKING BRAKE

The parking brake is called the parking brake for a reason: you should use it when you park your car. Many people think you only need to use your parking brake (also called the emergency brake) when parking on a hill or if your car has a manual transmission.

This is incorrect. Whether your car is a manual or automatic, the terrain is hilly or flat, you should use your parking brake every time you park.

A car is held in “park” by a device inside the transmission called a **parking pawl**. The parking pawl can break or become dislodged and the car will roll away. Granted, there is a small probability that this will occur, but there is a chance nonetheless.

The parking brake will hold the car in place while it is parked and will help protect the transaxle, constant velocity (CV) joints and transmission. A parking brake is capable of a stronger hold than only putting the car in “park”. Of course, you still need to put the car in “park”. Additionally, if your car was hit while parked, the parking brake would provide further stability, lessening the risk of your car rolling away. You should set the parking brake while your foot is still on the brake pedal and before shifting into “park”. This action reduces the strain on the parking pawl.

Most parking brakes are hand-operated levers located in the center console. To set the parking brake, pull up on the lever. To release the parking brake, press the button on the end of the brake handle and lower the lever. In some vehicles, the parking brake will be a foot pedal located on the far left side of the driver’s pedal area. To set the brake, push firmly on the pedal.

Depending on your vehicle, there are two ways to release the parking brake. In some vehicles, the

pedal is pushed down until you hear a click. In other vehicles, you must pull on a brake release lever located near the parking brake pedal.

Lastly, don't forget to disengage the parking brake before driving again. Trying to drive with the parking brake on does not sound good and it is not good for your car either. Setting the parking brake when you park and disengaging the parking brake before you drive should become habit, so you should never forget to do either part.

PARKING ON HILLS

When parking on a hill, you must make sure your car does not roll into traffic if the brakes do not hold. Always set the emergency brake. Shift to park, reverse, or low gear. If you park where there is a curb:

- Facing downhill, turn your wheels toward the curb and shift into reverse or park.
- Facing uphill, turn your wheels away from the curb and shift into low gear or park.

If there are no curbs, turn your wheels toward the edge of the road, whether facing uphill or downhill.

The above diagram indicates three parking situations. You should turn your wheels in a different way for each one, for safety's sake. Study the position of the wheels and notice where your car will roll if the brakes should give away.

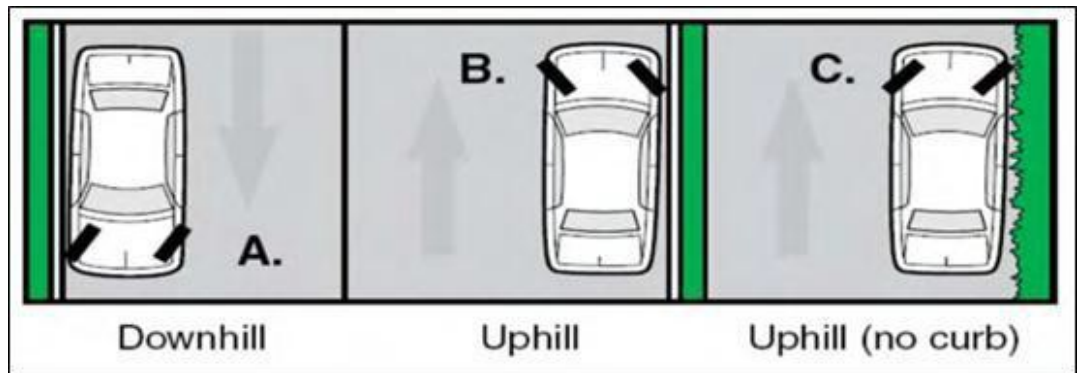

ANGLE PARKING

Keep safe clearance. Drive forward into space, with equal space on each side between lines.

Angle parking is often used in parking lots, shopping centers, and sometimes at curbs. When you enter an angle parking space:

- Watch for traffic both ahead and behind.
- Signal and begin slowing down.
- Make sure the rear of your car will clear any parked car.
- Steer sharply into the parking space. Then straighten the wheels, centering your car in the parking space.
- Shift to park or reverse and apply the parking brake.

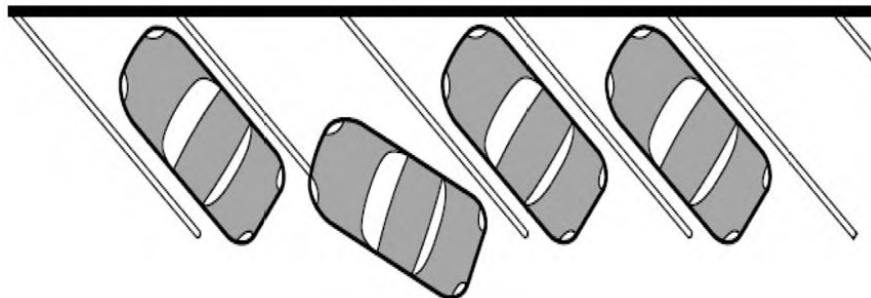

Before backing out of an angle parking space:

- Walk around to make sure nothing is blocking the space.
- Move your car back slowly because it is hard to see oncoming traffic. Be sure traffic is clear in the lane where you are backing.
- When you can see past the tops of the cars parked next to you, stop and look again. Look back and to each side for other drivers.
- Remember that the front of your car will swing opposite to the direction of your turn.
- Back slowly while turning until your left front wheel passes the rear bumper of the car parked on your left.
- Straighten the wheels as your car comes back into the lane of traffic.

Exiting a Perpendicular or Angle Parking Space:

- When exiting the parking space start the engine, check for traffic in all directions, place your foot on the brake, shift to reverse and signal in the direction you are turning. Continue to check traffic and move straight back until your front bumper clears the vehicle parked beside you, opposite of the way you are turning.
- Turn the steering wheel sharply in the direction that the rear of your vehicle should move.
- When the vehicle clears the parking area and centers in lane, stop and shift to drive.
- Accelerate smoothly, steering as needed to straighten wheels.

PARALLEL PARKING

- Signal, stop parallel to the front car (about 18 inches from it), with rear bumpers even.
- Back slowly, turning steering wheel sharply to the right until your car is about a 45 degree angle with the street. Straighten front wheels and back slowly.
- When front bumper is even with other car's back bumper, turn wheels sharply and rapidly to left. You should back slowly to the car behind you without touching or making contact.
- Turn steering wheel sharply to the right and slowly pull forward. Center the car in the parking space. Front and rear bumpers should not be closer than two feet from the other vehicles when in parked position unless the street is otherwise marked.
- Always park in a designated area as required.
- When parking along the roadway, park your vehicle as far away from traffic as possible. If there is a curb, park as close to it as possible.

PASSING PARKED CARS

When driving past parked cars, watch for cars turning out in front of you. Look for clues such as:

- Smoke coming from tail pipe
- Red brake lights on, turning signal flashing, or white backing lights on
- At parallel parking areas, front wheels turning out

Always watch for a car door being opened in front of you. If anyone is sitting in a car, expect them to open the door. Watch for pedestrians or bicycles trying to cross the road between parked cars. Be especially watchful for children.

PARKING

When parallel parked, the vehicle's right wheels must be within 18 inches of the right-hand curb of the street. When parking and leaving a vehicle unattended, stop the motor, remove the key, lock the ignition, and set the brake.

Getting out of your car on the street side can be dangerous. Always look carefully for other vehicles (especially bicycles) that might be passing. The driver may not see the door opening in time to prevent an accident.

It is against the law to park:

- On a sidewalk
- In front of a driveway
- In an intersection
- Within 15 feet of a fire hydrant or within 50 feet of a railroad crossing
- Within 20 feet of a crosswalk at an intersection
- Within 20 feet of a fire station driveway on the same side of the street, or within 75 feet of the driveway on the other side of the street
- Beside a parallel parked vehicle (double parking)
- On a bridge, overpass or in any tunnel
- At any place where official signs prohibit parking
- In a construction area if you will block traffic
- More than 2 feet from the curb
- In a space marked for handicapped, unless you have a handicap license plate, sticker, or tag
- Within 30 feet of a traffic signal, stop sign or yield sign



Painted curbs indicate other parking restrictions:

- **White** - indicates that only short stops are permitted
- **Yellow** - indicates a loading zone or some other restriction
- **Blue** – indicates a handicap restriction
- **Red** – indicates fire zone restrictions

PASSING ON THE LEFT

Pass only when you won't interfere with oncoming traffic or the vehicle being passed. You must not cause another driver to slow down or pull over in order for you to complete your pass. You might complete a passing maneuver before coming within 100 feet of any vehicle approaching from the opposite direction. It is against the law to pass another vehicle when:

- your view is blocked by a hill or a curve.
- there is a solid yellow line in your lane.
- you are within one hundred feet of an intersection or a railroad crossing.
- you are within one hundred feet of a bridge or tunnel.

PASSING ON THE RIGHT

You may pass to the right of another vehicle if there are two or more lanes of traffic moving in the same direction. You may never pass to the right of another vehicle by driving off the roadway onto the shoulder of the road. Remember, passing on the right can be dangerous if the other driver does not see you and decides to change lanes.

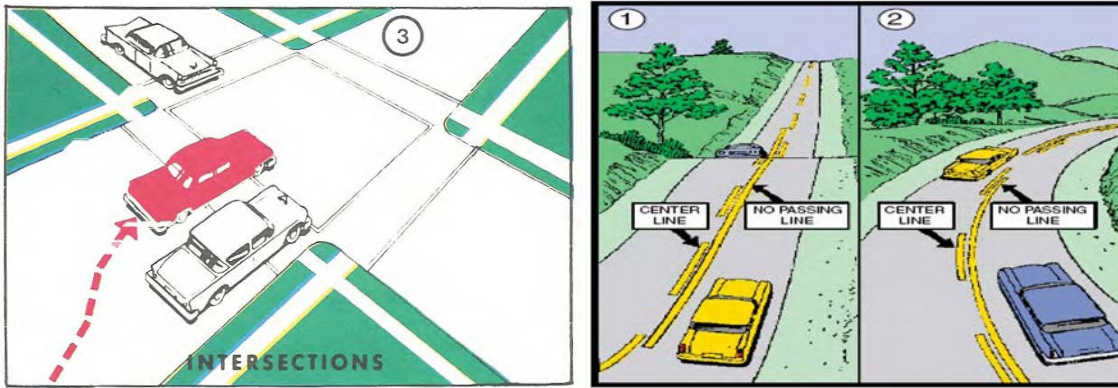

DO NOT PASS IN THESE SITUATIONS!!!

SAFETY TIPS ON PASSING

On multi-lane roads, the left-most lane is intended to be used for passing slower vehicles. When passing on the right, the other driver may have difficulty seeing you and might suddenly change lanes. Never pass on the shoulder, whether it is paved or not. It is dangerous. Other drivers may pull off the road without looking for your vehicle.

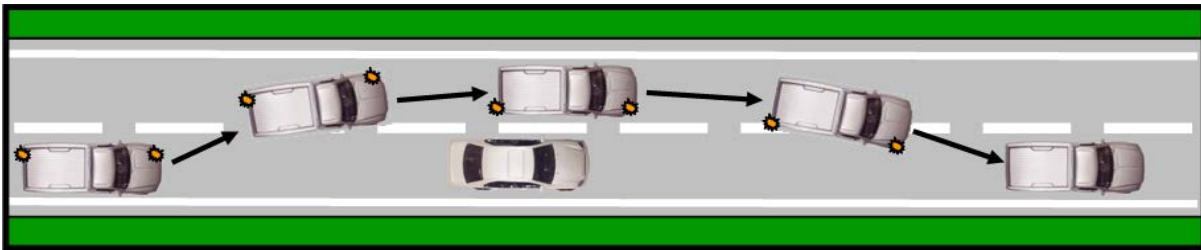

Do not pull up closely behind the vehicle you intend to pass (especially a large truck or bus). Your vision may be obstructed.

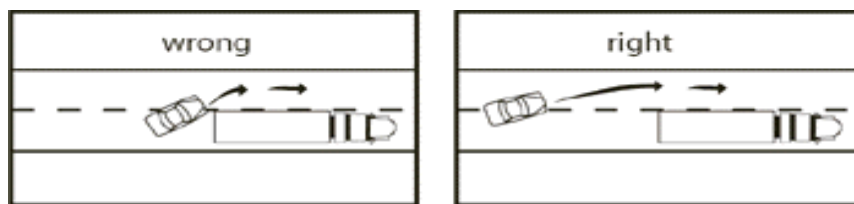

Following distance before passing

Follow at a safe distance until you can see far enough ahead to insure safe passing. If you can see an oncoming vehicle, do not attempt to pass. It is difficult to determine the speed of oncoming vehicles, even for experienced drivers. Oncoming vehicles do not seem to be coming as fast as they really are in relation to your vehicle. An oncoming vehicle that is more than 25 seconds from your vehicle generally appears to be standing still. In fact, if you can actually see the oncoming vehicle coming closer, it is probably closer than 25 seconds. Make certain no car is passing you; check your left or right rear "blind spot." Signal your intention to pass to the vehicle following you. It is safe practice to tap the horn lightly to avoid surprising the overtaken driver. After passing and before returning to the proper lane, be sure there is ample clearance. An accepted rule is to wait until you see the other car in your rear view mirror.

When you are about to be overtaken and passed, make it as safe and easy as possible for the other driver. Slow your speed a little and, if on a two-lane highway, move over to the right as far as you can safely.

When passing another vehicle, pass the vehicle as quickly and safely as possible. The longer your vehicle stays alongside the other vehicle, the longer you are in danger of the other vehicle moving toward your lane. To pass:

- Check for oncoming vehicles, vehicles or other roadway users about to enter the roadway from side streets or driveways or vehicles slowing in the travel path ahead. Check your mirrors and over your shoulder for following or passing vehicles. Signal your intentions when it is safe to pass. Pass from at least two seconds (behind the vehicle to be passed) to avoid striking the rear side of the vehicle. Steer smoothly into the passing lane. Maintain or adjust speed as necessary. Search the roadway ahead and check mirrors. Do not allow your vehicle to drift toward the vehicle being passed.
- Continue to pass until the complete front of the passed vehicle is visible in your rearview mirror. Signal your intention to return back to the lane. Steer smoothly into the lane, maintain or adjust speed as appropriate.

BACKING

Check behind your vehicle before backing. Do not depend on your mirrors. Turn your head and body so you can see where you are backing. Place your hand at the top of the steering wheel and back slowly. Always be prepared to stop.

Backing straight or to the right

To start:

- Have your hand on top of the wheel.
- Turn your body as indicated by diagram.
- Turn steering wheel in the direction of the turn.



Backing to the left

To start:

- Have your hand on top of the wheel.
- Turn your body as indicated by diagram.
- Turn steering wheel in the direction of the turn.

The best way to increase visibility when backing up is to:

- Turn your head and look out the rear window.
- Do not depend on your mirrors.
- Before backing, it is a good idea to walk around the car to make sure a child, pet, object, etc. is not in the way.



DRIVING ON WET PAVEMENT

Road surfaces are most slippery immediately after the rain begins to fall. This is because the oil and grease on the pavement have not yet been washed away. Driving on a road covered with oil and water can be like driving on ice. You should reduce your speed, use extra caution and allow twice the normal following distance.

Losing control of your car on wet pavement is a frightening experience. Unfortunately, it can happen unless you take preventive measures.

You can prevent skids by driving slowly and carefully, especially on curves. If you find yourself in a skid, remain calm, ease your foot off the gas and carefully steer in the direction you want the front of the car to go. For cars without anti-lock brakes, avoid using your brakes. This procedure, known as “steering into the skid,” will bring the back end of your car in line with the front. If your car has an anti-lock brake system (ABS), brake firmly as you “steer into the skid.” Be ready to look and steer in the direction you want to go. Be prepared to counter-steer after the initial correction is made.

HYDROPLANING

Prolonged or heavy rain will cause a layer of water on the road surface. At speeds up to 35 miles per hour, tires with good tread will “wipe” the water from the road surface much like a windshield wiper cleans the windshield. As speed increases, the water cannot be removed fast enough and the tires start to ride up on the layer of water much like water skis. This is called “hydroplaning.”

Partial hydroplaning starts at about 35 miles per hour, and increases with speed until (at 55 M.P.H.) the tires may lose all contact with the pavement. When this happens, you lose traction, and you cannot brake, accelerate or turn. To recover, keep your wheels straight and reduce your speed. This will allow the tires and the road to regain contact.

How to prevent hydroplaning:

- Reduce speed and drive slowly on wet roadways.
- Have tires inflated to recommended air pressure.
- Be sure you have good tire tread, which helps water escape quickly through the grooves of the tire
- All-weather tires are good.
- Steer around water when possible.
- If you hear a sloshing sound from the tires, especially when changing directions, slow down.

STEERING WHEEL LOCKING DEVICES

Be cautious with vehicles with steering-lock devices.

Never turn your ignition key to the lock position while the vehicle is in motion. That will cause the steering to lock and, quite possibly, loss of control of the vehicle.

Steering Lock Operation

The Transmission Park System - Shift the transmission into the "park" position. Turn key to LOCK and remove.

The Two-Hand Button System - This system requires two hands. Depress button below the steering column. Turn key to LOCK and remove.

The Lever System - Depress lever located near the ignition. Turn key to LOCK and remove.

The One-Hand Button System - Depress button located near the ignition. Turn the key to LOCK and remove.

The Push-in System - Turn key to OFF, push in. Turn key to LOCK and remove.

The Turn and Remove System - Park. Turn key to LOCK and remove.

NIGHT DRIVING

No one can see as well at night as they can in the daylight. The glare of oncoming headlights can reduce your vision to near zero. A dirty windshield increases glare and obscures the road, signs

and other motorists. When driving at night, you must be able to stop within the distance you can see ahead with your headlights. Your lower beam headlights will let you see clearly about 150 to 200 feet ahead. Driving at a speed that allows you to stop within this distance is about 45 mph. Your high beam headlights will let you see clearly about 350 to 400 feet ahead. Driving at a speed that allows you to stop within this distance is about 65 mph. You need to increase your following distance by adding at least one additional second for night driving conditions and at least two additional seconds for driving on unfamiliar roadways at night. Keep in mind that headlights limit your visual skills. Reducing speed based on headlight distance is critical to avoiding night driving collisions.

Louisiana law requires that your headlights (not just parking lights) be on between sunset and sunrise. You are required by law to use lower headlight beams, not your “bright lights”, when approaching within 500 feet of or following within 200 feet of another vehicle. In addition, headlights are required when moisture in the air or precipitation necessitates the use of windshield wipers and when weather conditions are unfavorable.

The law further requires that your headlights be on when driving in weather conditions that make it difficult for other people to see your vehicle clearly from a distance of 500 feet.



Some vehicles have front fog lights and these may be used under hazardous weather conditions. Front fog lights have a distinct flat, low reach yet wide beam pattern designed to show up the edges of a roadway more efficiently than low beam is able to achieve alone. Other vehicles have rear fog lights. A rear fog light is red due to the higher luminance level of this light; your vehicle can be recognized sooner. A rear fog light must only be used in a dense fog or similar hazardous condition that results in seriously reduced visibility. You should switch off the fog lights when the visibility improves.

Driving at night can be made safest if you follow these rules:

- Keep your windshield and windows clean, inside and out.
- Be certain that all lights on the vehicles are operating properly.
- Reduce your speed so that you can stop within the distance you can see ahead.
- Use lower beam when approaching other cars so you won't blind the other driver.
- If a stubborn driver refuses to dim the lights, look to the right edge of the road as a guide and slow down.

PEDESTRIAN SAFETY

As soon as you step out of your vehicle, you become a pedestrian. As a pedestrian, you should know your rights and responsibilities. As a driver, you should know the law when pedestrians are around.

PEDESTRIAN SIGNALS--types of traffic signals used only to control pedestrian movements.



DON'T WALK. A steady signal means the pedestrians must not enter the roadway towards the signal. Flashing "DON'T WALK" signals means that pedestrians may not start to cross the roadway but those already crossing may continue to the nearest sidewalk, traffic island or safety zone.

WALK. A steady signal means that pedestrians may cross the roadway towards the signal. A flashing "WALK" signal is sometimes used to indicate that there is a possible conflict between pedestrians and vehicles.

Pedestrians occasionally use highways to walk along or cross. Pedestrians have the right of way when they are in a marked crosswalk, when crossing an intersection with a green traffic signal or walk signal, and over a vehicle making a right turn on red. You should always be careful of pedestrians crossing the roadway and give them space. You must yield to pedestrians at all times. Even if they are not in a crosswalk and crossing the street where they should not be (also known as jaywalking), which is illegal, you must stop for them.

If you come too close to a pedestrian, you may block the vision of the next driver from seeing the pedestrian as he is crossing the roadway. You should not pass a vehicle stopped at a crosswalk. Use caution when approaching a stopped vehicle and be prepared to stop for pedestrians who are walking in the marked or unmarked crosswalks.

Pedestrians should always walk facing traffic when possible and should never enter a roadway without checking for oncoming traffic. You should cross the street at an intersection or a crosswalk. Always look left, right and left again before crossing the street and continue to check traffic while crossing.

Many pedestrians, especially young children, do not follow the law or use safe crossing practices. When you see people walking or standing along a road, or children playing near a roadway, you should slow down. Always allow pedestrians as much room as safely possible, and be alert for sudden movement by pedestrians into the path of your vehicle.

The faster a vehicle is traveling, the less likely it is that a driver can stop in time to avoid hitting a pedestrian. The majority of pedestrian crashes occur at locations other than intersections, where vehicle speeds are not enforced.

VISUALLY IMPAIRED PEDESTRIANS

Pedestrians using guide dogs or white canes with or without a red tip must be given the right of way at all times. These pedestrians are partially or totally blind, so be especially careful when turning corners or backing up.



Here are some suggestions for helping visually impaired pedestrians:

- Don't stop your car more than five feet from the crosswalk. The pedestrian uses the sound of your engine as a guide, so drive up to the crosswalk to allow the person to hear you.
- Don't give the pedestrian verbal directions. He listens to all traffic sounds before deciding to cross the street.
- Don't wait too long for the pedestrian to cross the street. If the person takes a step back and pulls in his cane, that's a definite sign that you should go.
- Don't turn right on red without looking first. Look for any pedestrian or other traffic first before starting your turn.
- Stop at all crosswalks where pedestrians are waiting.
- Don't stop in the middle of a crosswalk. This forces the pedestrian to go around your car and into traffic outside of the crosswalk.
- Don't block any sidewalk.
- Don't honk at the pedestrian. He has no idea who you are honking at and may be startled by the noise.

CELLULAR PHONES

The increased use of cell phones while driving is becoming a hazard on our highways. Drivers who use their cell phones while operating a motor vehicle pose a serious threat to themselves and other drivers. Currently, there are 39 states that have a ban on texting while driving and 10 states that prohibit hand held types of cell phone use while driving. Using a cell phone while driving involves all three types of distraction: visual, taking your eyes off the road, manual, taking your hands off the wheel, and cognitive by taking your mind and focus off your driving.

- Use your cell phone only in emergencies. If possible, have a passenger make the call.
- If you must make a call, pull safely off the road and stop before making the call.
- Do not take notes or look up telephone numbers while driving.
- Let your voice mail answer incoming calls.
- If you must use your cell telephone, keep your conversations short.
Get a model with voice- activated controls and hands-free operation.

Texting while driving is extremely dangerous. Texting causes a driver to look away from the road for 4.6 seconds. At a speed of 55 mph, the vehicle travels the length of a football field in that time frame. A lot can happen on a football field. According to DISTRACTION.GOV, if you text while driving you are 8 to 23 times more likely to be involved in a car crash.



Louisiana law prohibits anyone 17 years of age and under from using any type of wireless communication device while operating a motor vehicle and prohibits anyone of any age from texting while driving.

PEER PRESSURE

Teens are not the only ones who are faced with peer pressure. If asked, adults will tell of the pressure to have a bigger house, a better car or a job that pays more money. Parents are sometimes pressured by other parents to let their teen drive even when they know their teen is not ready. Every teen confronts peer pressure. Peers can pressure you into doing something you are not comfortable with. Taking a risk when driving can have a serious outcome. Most people would be shocked to discover that the biggest single cause of a teen death as a result of an auto accident is another teen, usually a friend. Many teens will admit they have been influenced to take a higher driving risk as a result of another teen's suggestion. At the root of this problem is the teen's need to impress his peers.

The statistics are not very comforting.

- 44% of teens said they drive more safely without friends in the car.
- 67% of teens said they have felt unsafe when someone else was driving.
- Only 45% said they would speak up if someone was driving in a way that scared them.
- 37% said they would ride with one or more friends who speed in the coming year.

A young inexperienced driver may:

- push the physical limits, especially with speed and curves
- perform illegal maneuvers, such as running lights
- steer carelessly, including swerving to the music or taking both hands off the wheel
- treat the car as a toy and public roads as a playground
- race other vehicles, use the car aggressively and shout abuse at other drivers
- fill the car with other teens, often in a party mood
- play around in the car, with low attention to their driving
- turn around to talk to passengers
- stare at their phone due to the rising addiction to social networking (text, email, Twitter, Facebook, etc.)
- drive when affected by alcohol or drugs, or without a safety belt.

Engaging in any of these risky behaviors is more likely due to the young driver's lack of experience behind the wheel. But peer pressure can have a positive influence. Peers can offer encouragement to each other. They can offer advice on a problem or tell you when you are about to make a mistake. Finding the courage to not "follow the crowd" can be difficult but it is not impossible. Trust your instincts. Choose your friends wisely. Having a friend who will "have your back" always helps when situations get tough. You have more power than you might think. Doing the right thing will not only improve your self-worth but may also be a positive influence on others and may save lives.





OLDER DRIVERS

In 2009, there were 33 million licensed drivers ages 65 and older in the U.S. On the positive side, driving is beneficial for older adults. On the negative, the risk for a fatal crash starts increasing at age 75. This is due largely to increased susceptibility to injury.

Older adults suffer from some types of impairments due to age, loss of vision, a lessening of cognitive ability, and decreased motor function. But an older adult can protect himself by using safety belts and driving when the environmental conditions are the safest. Older drivers are also less likely to drink and drive.

Older adults can take steps to stay safe on the road.

- Exercise regularly.
- Ask your doctor or pharmacist to review medications-both prescribed and OTC-to reduce side effects that may possibly interfere with driving ability.
- Have eyes checked at least once a year. Always wear your glasses or contacts if they are required.
- As much as possible, drive during daylight hours and good weather.
- Have your hearing checked.
- Look for the safest route with lighted streets, intersections with left turn signals, and easy parking.
- Plan your route before your drive and know where you are going.
- Leave a large following distance behind the car in front of you.
- Avoid distractions in your car such as changing stations on the radio, talking on your cell phone, eating and drinking.
- Know and understand your limitations.
- Take a refresher course and update your driving skills.
- If needed, consider an alternative to driving. Ride with a friend or use public transportation to get you where you need to go.

While these steps may be suggestions for older drivers, they are also good recommendations for drivers of any age group to follow.

SHARING THE ROAD WITH BICYCLES

Louisiana Revised Statute 32:199 states that “all children under the age of 12, when operating a bicycle or is a passenger on a bicycle, must wear an approved helmet with head straps when on a public highway, bicycle path or other public right-of-way.”

Bicycling is a healthy form of recreation for many people, while for others it is a form of transportation. As a result of rising auto, gas, and insurance costs, many individuals are turning to bicycles as an alternative method of transportation. There are currently 90,000,000 cyclists in the US. Bicycles have the same rights to use public roads as automobiles and must follow the same traffic laws as other vehicles. Many drivers find it hard to know how to react to bicyclists riding in

the street. In any given year there are 800-1000 bicyclists that die on the roadways and some 500,000 will be treated for injuries. For the safety of both drivers and bicyclists, the following precautions should be taken while driving and bicycling.

Driving Safely Near Bicyclists

Approaching and passing bicyclists:

- You must yield to bicyclists in intersections as you would for pedestrians and other vehicles.
- Increase following distances behind bicyclists because bicycle-stopping distances are shorter than automobiles.
- Be aware that bicyclists not traveling in the extreme right of the lane may be trying to avoid gravel, debris, bad pavement, sewer grates and other obstacles.
- Be cautious of bicyclists moving legally into the center of the lane because of road hazards or into the left lane because of a left turn.
- Avoid passing between a bicyclist and an oncoming vehicle on a two-way road. Slow down and allow the on-coming vehicle to pass. Then move to the left to allow plenty of room to safely pass the bicyclist.
- A three foot distance must be present between the passing automobile and slower traveling bicyclists.
- Give bicyclists the entire lane when they are passing parked cars. They need the space to avoid opening doors.
- Use caution when passing bicyclists because the air current created by a passing vehicle may cause bicyclists to have an accident.
- If you are pulling a trailer, allow for extra passing room when passing bicyclists.
- Extra caution should be used when motorists are near bicyclists in wet, windy, or icy weather.
- Reduce speed when encountering bicyclists and never tailgate.
- Do not blow your horn when near bicyclists.



Turning near bicyclists:

- Drivers who are turning left must wait until oncoming bicyclists pass. Accidents occur when turning drivers do not notice the bicyclists in the flow of traffic or misjudge their speed.
- Do not swing in front of a bicyclist to make a right turn. Making a right turn after overtaking a bicyclist is also a cause of accidents. Drivers should slow down and stay behind the bicyclist, or look once, then again. Make sure you see the bicycle and know its speed before you turn.
- Speeds of bicycles are hard to judge. They can vary from under 10 mph to over 35 mph. Good communication and eye contact between drivers and bicyclists are needed to prevent accidents.

Watch for bicyclists and use caution in hazardous conditions:

- When opening your car door into traffic, look first for bicyclists. This collision is the driver's fault.
- Railroad crossings can cause bicyclists to slow down and possible zigzag in order to cross the tracks.
- Metal or grated surfaces may cause a bicycle to be less stable than a car. Bicyclists should slow down and move to the center of the lane to allow room for handling the uneven surface. Drivers should be prepared for the reaction of a bicyclist who may be less experienced and may swerve to correct for the new surface.
- Trucks creating windblasts can move a bicyclist out of his path of travel on long open highways and bridges.
- Children on bicycles may not be aware of their surroundings. Drivers should be aware that

the children may make sudden movements or change direction. Don't expect children to know traffic laws.

- Inclement weather conditions create high winds and slippery surfaces that can cause extreme problems for bicyclists. Because these conditions create stability problems for all vehicles, drivers should allow more following distance for bicyclists.

Bicycling Safety:

- Always wear a helmet.
- Use hand signals and eye contact to communicate your actions with other drivers.
- Obey the instructions of official traffic control signals and signs just like a motor vehicle.
- Ride on the right hand side of the road with traffic. If you are making a left hand turn, ride on the left side of the turn lane. You may ride in the center of the lane to avoid hazards.
- Be predictable by riding in a straight line and following traffic laws.
- Yield to pedestrians on crosswalks and on sidewalks.
- When riding at night, bicycles must have a white front light and a red rear light or reflector visible from the rear.
- Carry no more persons than the number for which the bicycle is designed and equipped.
- Two cyclists may ride side-by-side, but it is safer to ride single file.
- Attach a rear view mirror so you can check traffic over your shoulder.



SHARING THE ROAD WITH MOTORCYCLES

As the price of gasoline increases more of your friends, relatives, and neighbors are becoming motorcycle riders. However, many drivers still have not adjusted to motorcycles appearing in traffic. Traveling by motorcycle is appealing to some people; they are fuel and space efficient and can be just plain fun to ride.

But there is a flip side. Motorcyclists are more vulnerable to injury than a driver of a larger vehicle if involved in a crash. Research shows that over two-thirds of the car/motorcycle collisions are the results of the other driver turning in front of a motorcyclist. Motorcyclists and cars/trucks need to mix in traffic without causing harm to each other. Motorcycles present a narrow silhouette and are usually much shorter in length than an automobile. The small profile of the motorcycle may make it appear farther away and traveling slower than it actually is. Remember that motorcyclists are often hidden in a vehicle's blind spot or missed in a quick look due to their smaller size. Because it is difficult to judge the motorcycle's distance and speed, car drivers need to take a second look, and then a third. Its small size also makes it more difficult to spot in traffic than another car. Some motorcyclists take advantage of their small size and maneuverability. They may cut between cars and put themselves in places where drivers cannot see them.



Be alert for a motorcycle to appear unexpectedly.

Due to a motorcycle's size, its position within a lane of traffic will change as traffic conditions change. The motorcyclist should position himself in the lane to see and be seen. This often means riding in the left portion of the traffic lane to allow a better view of traffic and road situations. It also makes the motorcycle more visible to other traffic. However, as traffic and road conditions change, the rider may move. This move could be to the center of the lane or even to the right side to avoid traffic or to be seen by others on the road.

Most drivers take for granted the ability of their vehicles to handle minor road hazards such as potholes, strong winds or railroad tracks. Minor problems for the four-wheeled vehicle can be major problems for motorcycles. The cyclist will change position within the lane to increase the distance from potential hazards. These lateral movements sometimes occur suddenly. Motorists need to be alert for these sudden changes in position and direction, and drive accordingly. Respect the vehicle space of a motorcycle and its position in traffic. Motorcycles are allowed the full width of a lane in which to maneuver. Refrain from sharing a lane with a motorcycle. It restricts the rider's ability to avoid hazardous situations.

Because a motorcycle has the right to a full traffic lane, pass it just as you would another vehicle. Don't pass too fast or too close. The wind blast of large, fast moving vehicles can blow a motorcycle out of control.

Intersections are the most likely place for car/motorcycle collisions to occur. This usually is the result of a car driver NOT SEEING the motorcycle and turning into the motorcycle's path. Misinterpreting a cyclist's intentions can also lead to problems. A cyclist will change lane position to prepare for upcoming traffic conditions. The cyclist will move to one side of the lane in preparation for a turn or possibly to move away from a hazard unseen by other motorists. Do not assume the cyclist's intention until the maneuver is unmistakably started, such as a turn into an intersection or driveway. Also, turn signals may not automatically shut off on a motorcycle and cyclists occasionally forget to cancel them after a turn is completed. Make sure you know what the cyclist is going to do before you move into the motorcycle's path.

When driving behind a motorcycle, allow at least a four (4)-second following distance. This provides the cyclist enough room to maneuver or stop in an emergency. Due to its vulnerable nature and the difficulty motorists have in judging a motorcycle's speed and distance, space between the two vehicles should be increased to avoid sudden braking. Both cyclists and drivers are more likely to make incorrect decisions if there is not enough stopping distance or ability to see and react to conditions. This leads to collisions. A cyclist's chances of injury are greater if forced to avoid obstacles ahead, as well as a driver following too closely. Remember that tailgating a motorcycle in your car is comparable to an 18-wheeler tailgating you!

The single headlight and single tail light of a motorcycle can blend into the lights of other vehicles. This can cause you to misjudge distance. Always dim your headlights for a motorcycle just as required for other vehicles.

SHARING THE ROAD WITH BIG TRUCKS

It takes special driving skills and knowledge to drive safely around big trucks. You cannot drive around a big truck the way you drive around other vehicles. The most important tip is to give a wide clearance (berth) to the big truck. Collisions between large trucks and lighter vehicles frequently result in death in the driver or occupants of the "other vehicles."

Big trucks are different because they have a much longer stopping distance than other vehicles,

and longer still on wet roads. The ability of the truck driver to control the truck during emergency braking is very limited. A tractor trailer loaded with freight, safe-rated tire, and properly adjusted brakes traveling at 55 miles per hour on a clear, dry roadway requires a minimum of 290 feet to come to a complete stop. Also, truck drivers cannot see you nearly as well as you can see the truck, and if there is a crash, YOU LOSE. In crashes involving large trucks and automobiles, the occupants of the cars sustain 78% of the fatalities. In more than 70% of these fatal crashes involving cars and commercial vehicles, police report that the car driver contributed to the cause of the crash.

Drivers of smaller vehicles need to practice the following safety tips:

- As a general rule, keep as much space as possible between your vehicle and big trucks.
- Do not cut in front of a truck just because you see open space there. That space is the truck's cushion of safety because of its longer stopping distance. If you have to stop suddenly, it will be very difficult for the truck to avoid hitting you. Also, if the truck has a long hood, the driver may not be able to see you at all.
- Do not linger alongside a truck; you may be in the trucker's blind spot. The size and configuration of many trucks, especially those with trailers, create large blind spots for the truck driver. If you cannot see a truck driver's face in one of his mirrors, the driver cannot see you and probably does not know you are there.
- If you are following a truck and cannot see the truck's side mirrors, you are driving too close. The driver cannot see you, so back off.
- Always give trucks plenty of room when they are turning. The relationship between the cab, mirrors, and trailer change constantly during a turn, creating varying blind spots. Also, trucks need extra space to turn because of their size.
- If a truck is stopped on a hill, it will roll backwards when it begins to accelerate. If you find yourself traveling behind a truck on a hill, leave extra space as a precaution.
- Avoid driving in the right lane, if possible, when traveling up or down hills, as well as near truck weigh stations, where large vehicles will be attempting to re-enter faster-moving traffic. By avoiding the right lane in these areas, you will reduce the possibility of a crash with a large vehicle.
- On windy days, never drive alongside a truck for longer than you need to pass it. Turbulence from a truck on a windy day can cause a vehicle to swerve on the road or even spin out of control if the weather conditions are bad enough. To minimize this, stay to the outer edge of the lane away from the truck and hold the wheel tightly with both hands.

Remember, trucks don't drive like cars. Generally speaking, the bigger the truck is:

- The bigger its blind spots.
- The more room it needs to maneuver.
- The longer it takes to stop.
- The longer it takes to pass it.
- The longer it takes to accelerate.
- The more room it takes to turn.
- The more likely you're going to be the loser in a collision.



Following trucks

In good road and weather conditions you should leave a gap of at least four to five (4-5) seconds between your vehicle and the truck in front of you, and an even longer gap when conditions are poor. This will prevent road spray picked up by the truck's wheels from affecting your visibility. The truck may also block your view of the road ahead, so hanging back will increase your field of vision and give you more stopping distance if the truck brakes suddenly to avoid a hazard you can't see.

Because of the size of trucks, another driver's view of you may be restricted. At intersections and in slow traffic, ensure you stay far enough away for other drivers to see you. When following at night, keep your headlights on low beam. The truck's many side mirrors will reflect high beam lights right into the driver's eyes.

If you are traveling behind or beside a truck during rainy weather you will need to watch out for splash and spray created by the truck. Splash and spray from the road, wind, and rain can make it difficult for you to see clearly. While trucks are equipped with mud flaps or mudguards to reduce the amount of debris thrown out from under their wheels, this does not completely prevent spray being thrown out from the sides and rear of the truck.

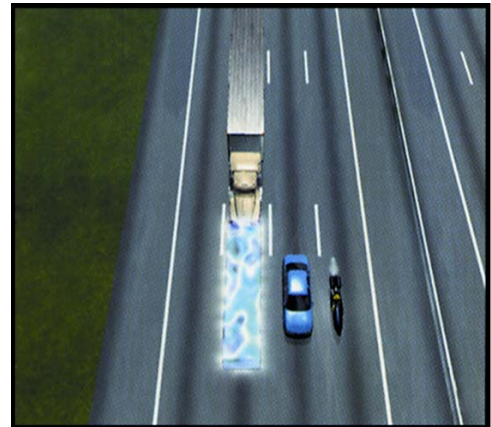

To maximize your safety when traveling alongside a truck in wet conditions:

- Keep your windshield clean and windshield wipers in good condition. a clear view. This will help ensure you have the necessary field of vision.
- If you are approaching an oncoming truck, turn on your wipers before it passes you. This will ensure your windshield is cleaned as soon as any spray is thrown onto it. This will reduce the time your visibility will be obscured and reduced.
- Don't pull out to pass a truck unless you can clearly see your way forward.
- Slow down so the distance between you and the truck increases. This will get you further away from the spray.
- Avoid the **NO-ZONE**. Just like automobiles, the first rule of safety with trucks is SEE AND BE SEEN. Large trucks have blind spots, or **No-Zones**, around the front, back and sides of the truck. Watch out! A truck could even turn into you, because these No-Zones make it difficult for the driver to see. So, don't hang out in the **No-Zones**. Remember, if you can't see the truck driver in the truck's mirror, the truck driver can't see you.

STAY OUT OF THE “NO ZONE.”

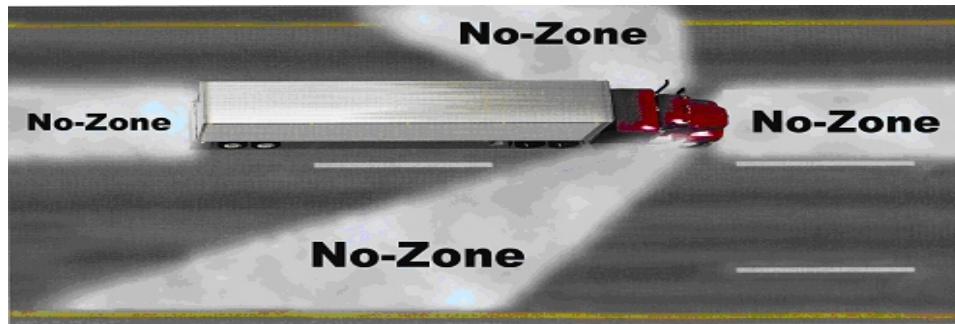

Passing

If you are passing a truck, always pass on the left side and make sure to allow plenty of room before cutting back in front of the truck. Keep a firm control on the steering wheel to counter the effect of air turbulence. Look for the whole front of the vehicle in your rear-view mirror before pulling in front and maintaining speed.

Merging Courtesy

When traveling in the right lane, courtesy dictates that you move over to allow a truck to merge. Be careful when pulling behind a truck which has just entered the highway; it takes a lot longer for a large truck to get up to speed.

Avoid Squeeze Play

Pay close attention to large vehicles turn signals and give them plenty of room to maneuver. When a truck (or bus) needs to make a right turn, it will sometimes swing wide to the left in order to safely turn right and clear the corner of a curb or other obstruction. Sometimes space from other lanes is used to clear corners. If you try to get in between the truck (or bus) and the curb, you will be squeezed in between them and could suffer a serious crash. To avoid a crash, do not turn until the truck (or bus) has completed its turn.



CHAPTER 6

TRAFFIC LAWS AND REGULATIONS

GENERAL

You are required to obey all traffic laws when driving a vehicle upon a street or highway.

POLICE OFFICERS

You must obey all lawful orders and directions of a police officer. Here are some ways to improve your traffic stop experience:

Invoke the “Golden Rule” and treat the officer the way you would like to be treated.

- ✓ Remember that you are required to cooperate with all reasonable requests that law enforcement personnel make.
- ✓ If an officer signals for you to stop, remain calm and safely pull over.
- ✓ Be prepared to produce your driver’s license, vehicle registration certificate, and current proof of insurance.
- ✓ Remain in the vehicle unless the officer tells you otherwise.
- ✓ Keep your hands visible.
- ✓ If you are stopped by a non-uniformed officer in an unmarked vehicle, you can ask the officer for identification.
- ✓ If you believe the reason for the stop is vague or unclear, you can ask the officer for details.
- ✓ If you are uncomfortable stopping in an area that is deserted or not well-lit, explain this to the officer and ask if you can proceed to a more populated or better illuminated area.
- ✓ Procedural questions and complaints about an officer’s treatment of you can be forwarded to the officer’s supervisor.



TRAFFIC CONTROL

You must operate your vehicle as indicated by traffic signs and signals and pavement markings.

When a traffic-control signal is not functioning at an intersection, the intersection shall revert to an all-way or four-way stop.

CONTROL OF VEHICLES

It is unlawful to negligently fail to maintain reasonable and proper control of your vehicle.

SPEED

Excessive speed is often the factor that turns a minor incident into a fatal crash. The laws of physics tell us that crash severity increases disproportionately with vehicle speed. A frontal impact at 35 mph, for example, is one-third more violent than one at 30 mph. When driving at 75 mph, you have little chance of living through a crash. Driving at such a speed during bad weather or at night means you are over driving your headlights. Since your stopping distance is greater than your visibility, you’re gambling that you can stop quickly in an emergency. You can’t.

Speed limit signs are based on traffic congestion, intersections, and roadway conditions, are designed for the safety of all drivers and roadway users and should be followed carefully. You may be cited for traveling too fast for conditions when above the legal limitations. Driving 55 mph in a snow storm is not recognized as an acceptable speed for a snowy roadway, even if the posted

speed limit allows for 55 mph. Remember that speed limits are posted for ideal conditions, so if the roadway is wet or icy, if you cannot see well, or if traffic is heavy, then you must reduce speed to enable your vehicle to stop and steer as needed. Use good judgment to determine the safest speed for the driving conditions.

The best way to avoid speeding is to check your speedometer frequently. You may not be very good at judging how fast you are going without checking the speedometer, so it is easy to be traveling much faster than perceived. This is especially true when switching from high speed multiple-lane roadways to lower speed single-lane roadways.

The General Speed Law is that you must not drive at a speed greater than is reasonable. You must drive at a safe, appropriate speed depending on the area in which you are driving, the road and traffic conditions, light and weather conditions.

SPEED LIMITS

- You must not drive faster than the posted maximum limit.
- You must not drive slower than the posted minimum limit.
- While driving within the posted speed limit, you must not drive so slowly that you impede other traffic.
- Reduced speed limits are required in the following areas:
 - On streets near schools and playgrounds and at locations marked with a “school crossing” sign when children are present.
 - On streets in residential or business areas.

While excessive speed is a main factor in crashes, driving too slowly is also dangerous. Drivers tend to get impatient with another driver who is driving too slowly and take unnecessary chances to get around him. Minimum speeds are posted for our interstates.

DRAG RACING

It is unlawful to participate in any race, speed contest or speed exhibition of any public street or road in this state. Drag racing is defined as the operation of two or more vehicles from a point side by side at accelerating speeds in a competitive attempt to outdo each other.

DRIVING ON DIVIDED HIGHWAYS

When a highway is divided into two roadways by a median or barrier, you must not drive across the median or barrier except when an approved cross-over is provided. You cannot cross the painted continuous centerline of any multiple lane highways except for the purpose of making a turn.

LANE CHANGING

Never move from one lane to another until you are certain that you can do so safely. Proper lane changing rules are:

- Check your rear view and side mirrors.
- Look over your shoulder to make sure no one is in your blind spot.
- Check for other drivers who may also be moving into the same lane.
- Signal your intention to other drivers.

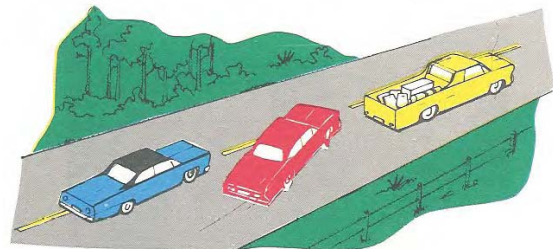

Before changing lanes, look carefully behind you - someone may be passing you. Also, if you can't see at least a quarter mile ahead, don't attempt to pass. So, if there's fog or any other kind of obstruction blocking your view, stay put! The best scenario for attempting this pass is a clear, sunny day on a long, flat, and clear stretch of road.

Delaying or adjusting a lane change

There may be an instance when you need to delay or adjust your lane change. Even if you are about to miss your exit or turn, you should never make a hurried or unsafe lane change. You can always take the next exit and turn around.

If there is a car in your blind spot in the lane that you want to move into, speed up or slow down until there is enough space for you to change lanes. This is when you need to use your mirrors multiple times before make the lane change. During heavier traffic or when cars are following each other too closely, there might not be enough space for you to make a lane change. Speed up or slow down if there is enough space either in front of the cars or behind them. If you have to speed up or slow down so much that it puts you or others in danger, wait to change lanes.

Never force your way into a lane. This maneuver is dangerous for both you and other drivers. Hopefully, another driver will notice your signal and will make space for you. If there is a car in the lane you want to move into that is approaching at a faster speed than you are traveling, simply wait for the car to pass and then make the lane change. Do not get in front of the car. Not only will it make the driver angry, but more severely, the driver might not have enough time to slow down behind you.

Do not change lanes while you are driving through an intersection or approaching an intersection as this is dangerous and illegal. Wait until you pass through the intersection to change lanes. There is already enough danger at intersections without the added threat of cars changing lanes. These locations often include controlled intersections, uncontrolled intersections and multiple shopping center entrances.

STOPPED SCHOOL BUSES

You must stop at least thirty feet from a stopped school bus that is loading or unloading children. All 50 states have a law that makes it illegal to pass a school bus that is loading or unloading children. Always be prepared to stop when lights are flashing. Bus drivers will activate the flashing yellow lights of the bus at least 100 feet but no more than 500 feet before the school bus stop. As the bus comes to a complete stop, the flashing red lights and stop signs will activate. Wait for the vehicle to move and scan before starting to drive again. This is required by law whether you are meeting the bus or traveling behind it.

You do not have to stop when the bus is stopped in a loading zone completely off the roadway and where the pedestrians are not allowed to cross the roadway. If you are following a bus, increase your following distance in order to get a better view. Anticipate the bus stopping at its' pickup and drop off points. Never pass a bus with its red lights flashing on the right or on the left. Buses typically travel at lower rates of speed and make frequent stops. During the school year school buses are most likely to be on the road during a three hour period in the morning and a three hour period in the afternoon.

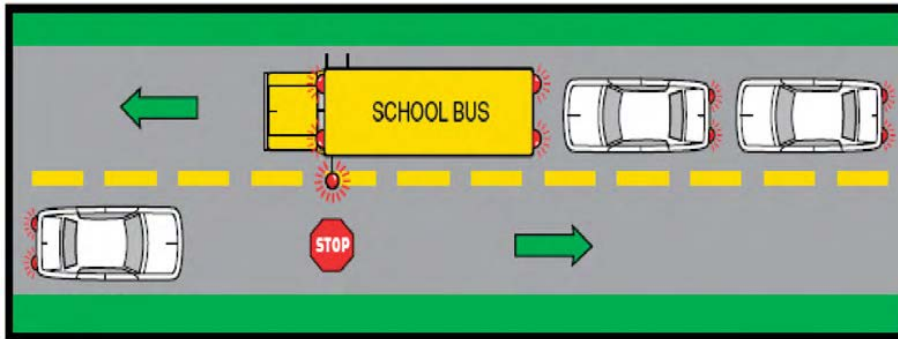

When a school bus is stopped in opposite lanes on a roadway separated by a ditch, grassy median, elevated concrete barrier or any obstacle that prevents traffic from driving thereon, you are not required to stop. Drivers are also not required to stop for a stopped school bus when traveling on four lane or five lane roadways which are separated by a dedicated two-way left turn lane. Drivers must stop on a four lane roadway when it is not separated by a barrier.

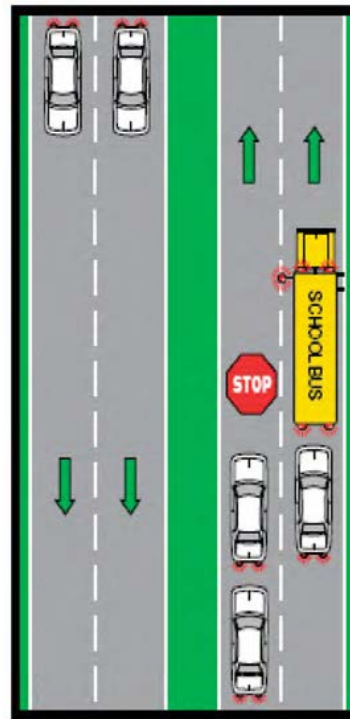
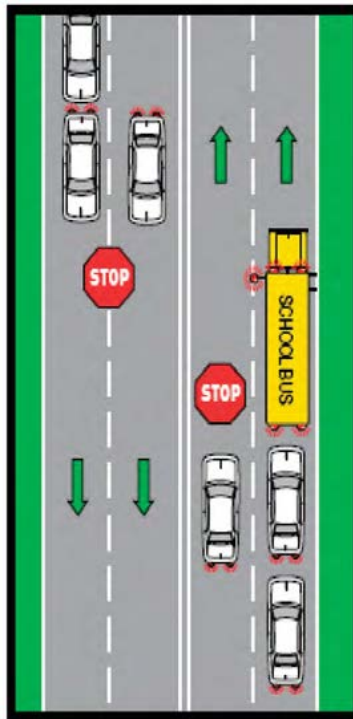

INTERSECTIONS

One of the most dangerous areas on any road is the intersection. Cross traffic, turning vehicles, bicyclists, and pedestrians can make getting across an intersection a challenge, and in heavy traffic, even dangerous. Many intersection collisions occur when drivers fail to use their turn signals or don't know the right-of-way laws. You should know who has the right of way and always use your signal indicator. Slow down and be prepared to stop if necessary. Having the right of way does not guarantee your safety. Aggressive drivers will try to beat the red light and speed dangerously through an intersection.



RULES FOR TURNING

The steps for making safe, courteous and legal turns are as follows:

1. Prepare for the turn well in advance.
2. Scan ahead and around you to see where other vehicles (or pedestrians) are and be sure it is safe to turn.
3. Signal first and then move into the proper lane. The law requires that you signal and get into the proper lane at least 100 feet before making a turn.
4. Slow down before making turns and always finish your turn in the proper lane.

RIGHT TURN

Steps 1 through 4 give the proper method for making a **right turn**.

1. Avoid swinging left before making the turn.
2. Always turn right from the right most lane or when lane markings indicate multiple lanes can be used for a right turn at the same time.
3. Signal first and then move into the proper lane. The law requires that you signal and get into the proper lane at least 100 feet before making a turn.
4. Slow down before making turns and always finish your turn in the proper lane.

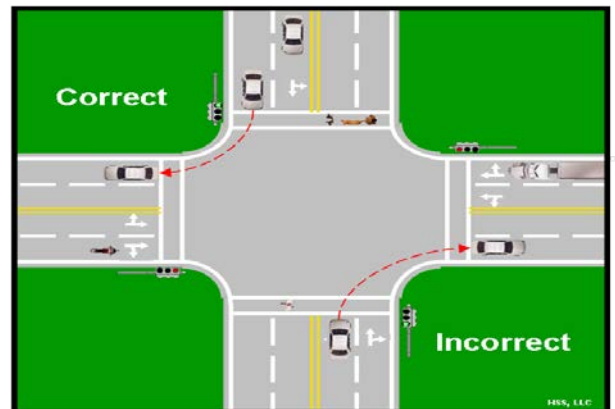

LEFT TURN

Steps 1 through 4 give the proper method for making a **left turn**.

1. Prepare for the turn in advance
2. Signal first and then move into the proper lane. Louisiana law requires that you signal at least 100 feet before making a turn.
3. Keep your wheels straight while waiting to turn. This will prevent you from being pushed into traffic, if you are hit from behind.
4. Brake prior to beginning the turn and use the appropriate lanes for turning.
5. Avoid cutting the corner so sharply that your vehicle is in front of someone approaching from the left.

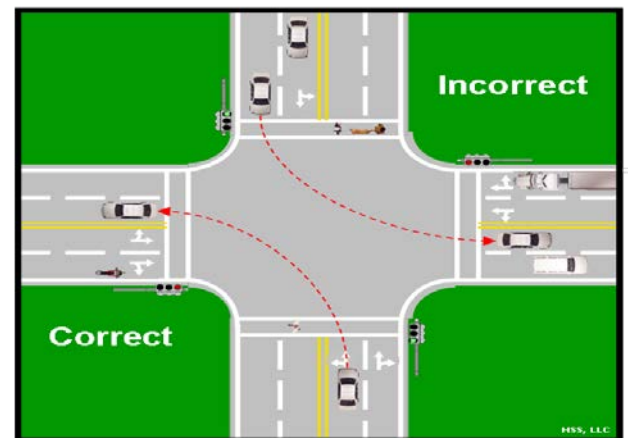

LEFT TURN - TWO VEHICLES

If you meet another driver at an intersection and both of you signal left turns, be extra careful. When safe, each driver should turn to the left of the center of the intersection. If you must stop before making a left turn, keep your wheels straight so that if you are struck from the rear, you won't be shoved into the oncoming traffic lane.

At 4-way intersections, some lanes are marked as left turn lanes. When such a lane is marked, you may



ONLY turn left from this lane. More than one lane may be designated as “left turn only” lanes.

YOU MAY NOT TURN AROUND

Do not attempt to turn around while on a hill or in a curve where your vehicle cannot be seen by other drivers approaching from either direction within 500 feet.

SHARED CENTER LEFT TURN LANE

On many streets where it is difficult to safely make a left turn, there is a shared left turn lane located in the middle of the roadway. The solid yellow centerline means you cannot use the center lane for passing. The broken yellow centerlines show that vehicles traveling in either direction may use the center lane only to make left turns. Louisiana law prohibits traveling in this lane for more than 200 feet. Do not move into the lane too soon. The longer you stay in the lane, the more likely you will meet someone coming in the opposite direction. Watch for vehicles pulling out of entrances and side streets and do not use a shared left turn lane for anything but turning left. When using a shared center left turn lane you must check for vehicles ahead, check mirrors, signal left and check your left blind spot by looking over your shoulder. Steer smoothly into the shared center left turn lane and choose an appropriate gap in oncoming traffic to make the left turn.

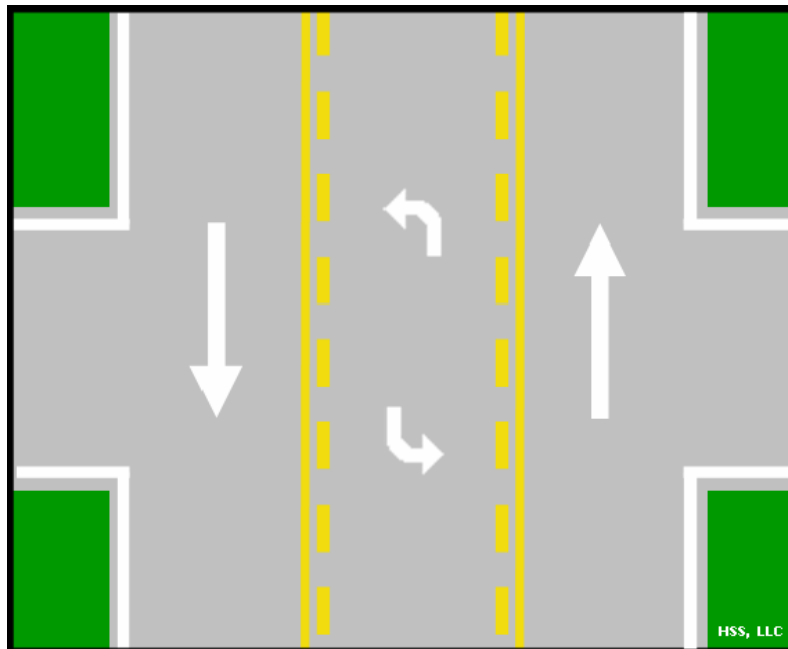

ROUNDBABOUTS AND TRAFFIC CIRCLES

These are found in some areas to help ensure safe passage of traffic through an intersection without necessarily stopping the flow of traffic. A roundabout or traffic circle is a circular intersection with design features that promote safe and efficient traffic flow. Vehicles travel counterclockwise around a raised center island, with entering traffic yielding the right-of-way to circulating traffic. When entering the roundabout or traffic circle you must negotiate a sharp curve. Slow your speed to about 15 to 20 mph. Once in the roundabout, proceed to the appropriate exit, following the guidance provided by traffic signs and pavement markings. If there is more than one lane going in the same direction, make sure you know where you want to go and are in the proper lane before entering and do not change lanes or pass any vehicles.

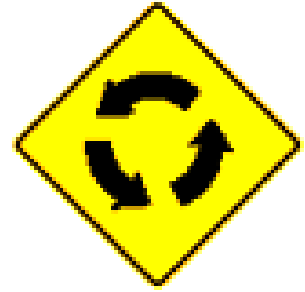

When using roundabouts or traffic circles:

- Slow down as you approach the circle. A sign, like the one shown, warns of a roundabout or traffic circle.
- Yield to any traffic in the circle. If another vehicle arrives at the traffic circle at the same time as you do, yield to the vehicle if it is on your right. Also, yield to pedestrians and bicyclists in the traffic circle or roundabout.
- Enter a traffic circle to the right, but steer to the left (in a counterclockwise direction).

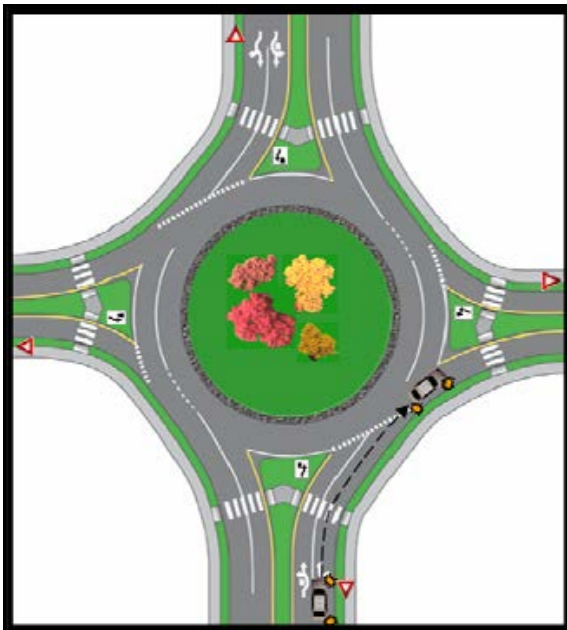

Be courteous and signal your intentions as you approach and drive through a traffic circle or roundabout.

- If you intend to turn right, signal “right” while approaching and until you have exited the traffic circle or roundabout.
- If you are going straight through, no signal is needed while approaching.
- If you intend to turn left, signal “left” on the approach to the traffic circle or roundabout. Once you have traveled three quarters of the way around the traffic circle or roundabout, signal “right” to take the exit.

Do not drive alongside large vehicles, such as trucks and buses in a traffic circle or roundabout. This sign shown below warns to keep away from large vehicles in a traffic circle or roundabout.

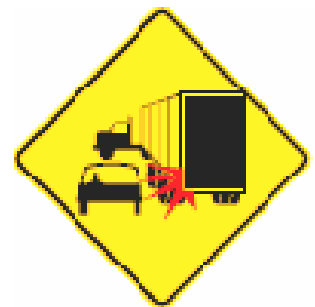

CORNERING

Every corner is made of three parts; the entry, the apex, and the exit. The entry is where turning begins. The apex is the point where the car reaches the furthest point on the inside of the turn. The exit is when the car is driving straight again.

This **10-point plan** explains how to get cornering right.

1. Both hands on the wheel, at nine and three o'clock. You can neither safely nor correctly steer a car one-handed, or with your hands in the wrong positions, it's that simple. And there is very little, if any, need to reposition your hands during 99.9 per cent of open-road driving in a reasonably modern car.
2. Look as far around the bend as possible. Eyes are the main thing that steers a car, not hands. Look where you want to go – as far ahead as possible. You'll get more time to react if there's an obstacle ahead, and the process will be much smoother. Look through the side mirror if necessary. Don't stop at the border of the windshield if the bend is tight. If there is vegetation, try to see as far ahead as possible.
3. Judgment. The open road is not your wide screen television. There are real risks, such as oncoming traffic and roadside obstacles. Be conservative, and employ safety margins, no matter how good you think you are. Always be prepared for the unexpected.
4. Speed matters. The right speed is very hard to judge in cornering. Why? This is because cornering load (or force) depends on speed squared. That means doubling the speed generates four times the cornering force. Fifty per cent more speed in a corner generates well over double the cornering load. It's easy to exceed the available grip under the tires, because small changes in speed make relatively big changes to cornering load, and that makes the right speed hard to judge. (Unfortunately, advisory speed signs are notoriously inconsistent.)
5. Slow in. The most efficient, smoothest way around a bend is to enter it little on the slow side. Entering too fast may cause a loss of control. Slower in means smoother on the way through, and faster out – a safer, more efficient way to travel.
6. Smooth is safe. Rough driving is a great way to lose control. If you find yourself pushing the wheel aggressively, giving the car too much gas or braking on the way around a bend, you're in dangerous territory. And you're showing how little you really know about driving. Slow down a notch, drive smoothly. Be gentle on the controls – all three of them, wheels, brakes and steering.
7. Entry. Ease off the gas as you turn in. This causes a little weight to transfer forwards, adding weight to the front wheels and helping the steering grip the road. Don't go over the center line on right hand turns. Keep out wide to maintain a safety margin against wayward oncoming drivers. Steering and control work together. Lifting off the accelerator and turning in with the steering is a natural combination that helps the car do what you want.
8. Mid-corner. Add a little acceleration, not very much – just enough to balance the car up, and keep looking around the bend on your intended travel path. If you start to run a little wide, ease off the accelerator and add some steering. You shouldn't have to move your hands very much in the middle phase of most corners.
9. Exit. The opposite strategy to entry. As you see the corner open up and some straight road ahead, add some acceleration (gently) and start unwinding the steering. The car should transition smoothly from cornering to straight ahead if you get it right. Remember, cornering is about subtle control inputs, not gross ones.
10. Planning. Most people get into trouble in corners because they get into them before they sort them out mentally. Then the cornering process drives them, not the other way around. So don't get distracted. Keep ahead of the game mentally, and pay particular attention to balancing the car's entry speed to the corner's severity.

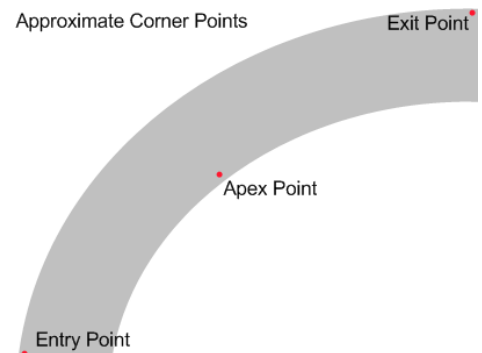

SIGNALING

Crashes often happen because one driver does not see another driver, or when one driver does something the other driver does not expect. It is important that you let other roadway users know where you are and what you plan to do.

If you do not signal your intention, other drivers will not be prepared for your move. Some drivers do not always pay attention to what is going on around them. You must always give a signal to other drivers when you plan to turn, change lanes, slow down or stop.

- You can use either mechanical signal lights or the left arm.
- A right or left turn signal must be given continuously for not less than 100 feet before making the turn. A greater distance is suggested when driving at faster speeds or in heavy traffic.
- The left turn signal should always be used when driving from a curbside parallel parking space into the flow of traffic or moving to the left lane to pass.
- It is illegal to flash your turn signals on just one side of a parked or disabled vehicle OR as a signal to another vehicle to pass you.

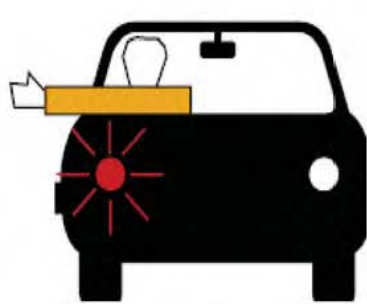

Left Turn

Arm straight is for a left turn

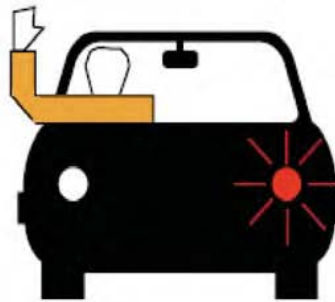

Right Turn

Arm bent up is for a right turn

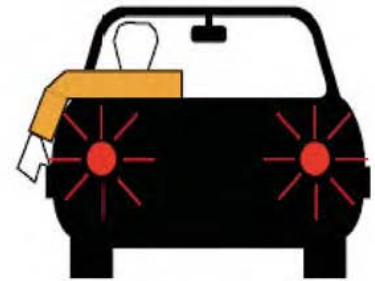

Stop Or Slow

Arm bent downward is for slowing or stopping

RIGHT OF WAY

The following right-of-way rules are an aid to safe and smooth traffic flow. The law says who must yield the right-of-way to another roadway user; **it does not give anyone the right-of-way**. The rules apply to all users of the road, including bicyclists, but you should never insist on taking the right-of-way. If other drivers or pedestrians are not following the rules, let them have the right-of-way even if it belongs to you.

- At yield sign intersections - slow down to a reasonable speed and stop if required. Proceed ahead only when you can do so without interfering with approaching traffic.
- Left turns - the driver making a left turn must yield the right-of-way to oncoming traffic, including bicyclists. You must yield the right-of-way:
- To emergency vehicles that are sounding a siren and flashing warning lights. Pull over to the right edge of the roadway clear of intersections and stop until the emergency vehicle has passed. Watch for other emergency vehicles. This applies to traffic in both directions.
- To pedestrians legally crossing the roadway on which you are driving (marked or unmarked crosswalks).
- To persons using a guide dog for the visually impaired;
- To persons using a white cane with or without a red tip;
- At uncontrolled intersections where vehicles are already in the intersection;
- At "T" intersections where you must yield to vehicles on the through road;

- When driving on an unpaved road that intersects with a paved road;
- When returning to the roadway after the car is parked.
- When entering a road from a driveway, alley or roadside you must yield to vehicles already on the main road.
- At controlled intersections and 4-way stop intersections - (Remember, if a traffic light has malfunctioned, the intersection becomes a 4-way stop intersection.) When two vehicles approach an intersection at the same time, the driver on the left must yield the right-of-way to the vehicle on the right.

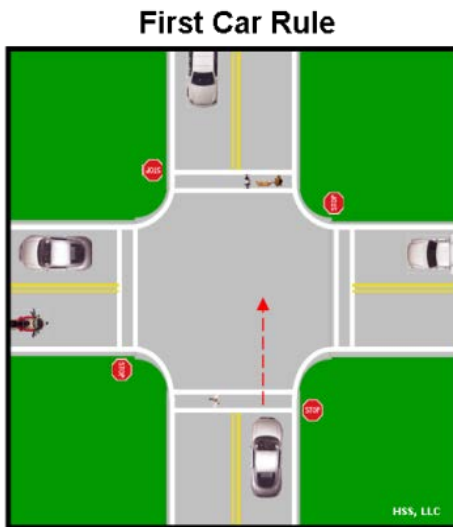

RAILROAD GRADE CROSSING

Louisiana law requires that the driver of any motor vehicle must stop within 50 feet but no less than 15 feet from the nearest rail of a railroad crossing when:

- A signal device is flashing and a train is approaching.
- A crossing gate is lowered.
- A train gives a warning signal and is an immediate hazard due to its speed or proximity to the crossing.
- A train is approaching so close as to create an immediate hazard.

After stopping, the driver shall not proceed to cross the tracks until he can do so safely. Railroad grade crossings are marked with warning devices for your protection. Watch for and respect these devices.



Louisiana law prohibits any driver from stopping a vehicle on railroad tracks. Never get trapped on a crossing. If your vehicle is in a line of vehicles approaching a railroad grade crossing, you should not attempt to cross the tracks unless you are certain that your vehicle can safely cross to the other side of the tracks. If your vehicle becomes pinned between two vehicles or stalls in the path of an oncoming train, get out and move in the direction toward the approaching train away from the tracks.

Advanced warning signs tell you to look, listen and slow down. You may have to stop. Watch for vehicles that must stop at railroad crossings. Drivers of vehicles carrying passengers for hire, school buses or trucks, or any vehicle carrying explosives or flammable liquids must stop at railroad crossings. **DO NOT PASS THEM** unless it is legal to do so and there are no unsafe conditions. You should have a clear view of the tracks.

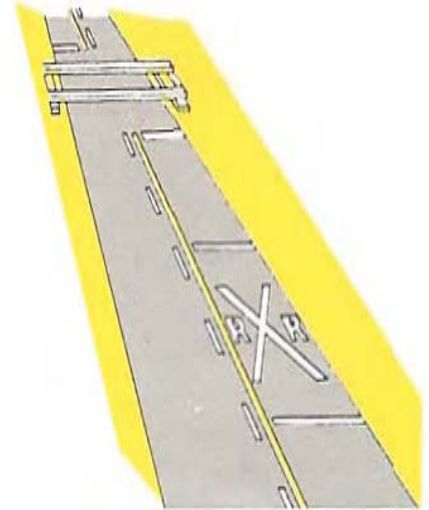

Railroad cross markings are white markings painted in the traffic lane before railroad crossings. The pavement is marked with a large "X" and two "R's". This is a no passing zone.



Railroad cross buck signs will be found at most crossings.

The driver should slow down and be prepared to stop upon seeing a train. If there is more than one track, a sign below the cross buck indicates the number of tracks.

Flashing light signals are used with cross buck signs at many railroad crossings. Always stop when the lights are flashing because a train is coming from the other direction. Always look both ways as you approach a railroad crossing, even if the warning lights are not flashing. They may not be working. Never shift gears on the crossing. If your vehicle has a manual transmission, shift before reaching the tracks and do not change gears while crossing the tracks.

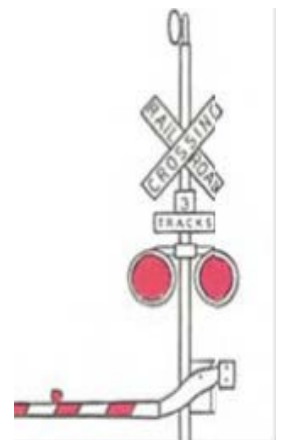

Gates are used with flashing signals at certain crossings. Stop when the light begins flashing and before the gates are lowered. Remain stopped until the gates are raised. Never drive around the gates. It's against the law to drive through or around any crossing gate at a railroad crossing. Expect a train on any track at any time. Be cautious at a railroad crossing any time of day or night. Freight trains do not travel at fixed times and schedules. Be especially careful when visibility is low, or when the tracks may be hidden from view by trees, hills, buildings, etc. Do not cross tracks until you are sure no train is coming.

Stay alert around railroad tracks. Do not use cell phones, headphones, or other distractions that would prevent you from hearing an approaching train. Do not mix rails and recreation.

TRACK FACTS:

Fact #1: You cannot judge the distance and speed of an oncoming train.

Fact #2: Railroad tracks, trestles, bridges and railroad yards are private property

Fact #3: A train can appear on any track at any time.

Fact #4: Trains have the right of way 100% of the time over emergency vehicles, cars, the police and pedestrians.

The weight ratio of a train to a car is like that of a car to a soda can. Try driving over a soda can with a car and observe what happens. When a 3000 pound car and a train weighing several tons meet, tragedy always occurs. According to the US Department of Transportation, there are about 5800 vehicle train crashes each year. These accidents kill 600 people and injure about 2300 others. Don't try to beat a train. A 100 car freight train traveling at 55 miles per hour requires more than a mile to stop. That's the length of 18 football fields.



OTHER LAWS YOU SHOULD KNOW

Backing up is not permitted on the shoulder or roadway of any controlled-access highway. It is also prohibited at any other place unless it can be done safely without interfering with traffic.

It is against the law for **more than three persons** to occupy the front seat of a moving vehicle.

You **must not drive a vehicle that is overloaded** with passengers or any other thing that will obstruct your view in any direction or interfere with your control of the vehicle.

No person(s) **under the age of twelve years** shall be permitted to be a passenger in the open bed of a truck. No person(s) of any age is permitted to be a passenger in the open bed of a truck when the truck is moving upon an interstate highway of this state.

Having non-transparent material affixed to the front windshield or front side-windows is illegal, unless prescribed by a physician.

Riding in a house trailer is not allowed while it is being moved upon a highway in this state.

Funeral processions require all operators of motor vehicles to yield the right-of-way to the vehicles participating in a funeral procession. While participating in a funeral procession each driver shall have the headlights of the vehicle lighted and the emergency lights flashing.

Following emergency vehicles responding to call closer than 500 feet is unlawful. You must not follow into and park within the block where the emergency vehicle has stopped.

Do not cross any unprotected fire department hoses unless consent is given by an official of the fire department.

Wearing headphones (headset, headphone, or listening device other than a hearing aid) in both ears is prohibited. Wearing headphones (headset, headphone, or listening device) in one ear alone is allowed.

It is illegal to lend your driver's license to another person, to alter your driver's license in any manner, to provide false information in obtaining your driver's license, to have more than one driver's license in your possession, to fail or refuse to surrender your driver's license to the department if demanded, and to permit any unlawful use of driver's license issued.

Theft of motor vehicle fuel is a crime punishable by fine, loss of license, and possible jail time.



Louisiana's "**Move It, Move It, Move It - Steer It Clear**" campaign is an attempt to make the public aware of your responsibility to remove vehicles from the roadway to the nearest soft shoulder. In accordance with Louisiana law, no person driving or in charge of any motor vehicle shall permit it to stand unattended without first stopping the motor, locking the ignition, removing the key, and effectively setting the brake. Removal of vehicles from the roadway will play a great role in reducing traffic congestion and reduce the chances of secondary crashes.



Louisiana law requires you have your **headlights on** (low beam) when your windshield wipers are required.

Operators below age 17 are prohibited from driving between the hours of 11:00 p.m. and 5:00 a.m., unless accompanied by a licensed parent, guardian, or adult at least 21 years of age or sibling 18 years of age.

Traffic laws apply to persons riding bicycles. Every person riding a bicycle is given the same rights and must follow the same rules and regulations that are given to those driving an automobile.

Riding on bicycles—When riding a bicycle, the rider must ride upon a seat that is attached to the bicycle. The number of people on the bicycle shall not be greater than the intended number of people the bicycle is designed to carry. The person controlling the bicycle must have at least one hand on the handlebars at all times.

Clinging to vehicles—No person riding a bicycle shall attach himself or the bicycle to any vehicle while on public roadways.

Riding on roadways and bicycle paths—All bicyclists must ride as near to the right side of the roadway as safely possible while exercising caution when passing stationary vehicles or vehicles traveling in the same direction. Bicyclists must not ride more than two abreast except on roadways set aside for exclusive bicycle use.



Bicycle seats and restraining seats—Children under the age of twelve must wear approved helmets when operating a bicycle or riding as a passenger. A child’s helmet must fit properly and be fastened securely on the child’s head with the straps of the helmet. Children who weigh less than forty pounds or are less than forty inches in height must be properly seated and secured in an approved restraining seat to be a passenger upon a bicycle.

Please note the INTERNATIONAL SYMBOLS FOR THE DISABLED. These symbols mean that a parking space is especially reserved for a person(s) who is disabled. Practice driving courtesy. Give disabled citizens a break. Never use one of these spaces unless you are lawfully entitled to it.



AUTOMOBILE INSURANCE FRAUD

The five most common types of automobile insurance fraud are fictional theft, repair shop rip-offs, uncompleted repairs, deceptive claims, and staged accidents. A fictional theft occurs when a policyholder files a phony insurance claim for a "stolen" vehicle that he knows is simply in "storage." A repair shop rip-off occurs when the owner of an auto repair shop or glass shop offers to inflate a policyholder's damage estimate as a favor to cover the deductible. You will see an occurrence of an uncompleted repair when the owner of an auto repair shop routinely does not replace parts that are required to complete the repair. A deceptive claim is when an accident victim files a claim for repairs that had been previously claimed.

TIPS TO PREVENT VEHICLE REPAIR FRAUD

There are many types of collision repair fraud scams, ranging from airbag fraud, to chop shops that dismantle and resell stolen vehicle parts, to shops that inflate vehicle damage estimates.

- Use reputable collision repair shops that employ ASE-certified mechanics.
- Obtain a shop recommendation from your insurance company, a family member, or a friend.
- Select a facility that is clean and orderly, with updated equipment.
- Choose a shop that uses a written damage report instead of written estimate of cost/price of repair. A damage report is a "blueprint" for your repairs. Damage reports also contain more details about the repairs than written estimates.
- Ask for a written warranty on installed collision repair parts and paint work.

TIPS TO AVOID BECOMING A VICTIM OF A STAGED AUTOMOBILE ACCIDENT

- Avoid tailgating. Always give yourself plenty of space between you and the vehicle in front of you.
- If you find yourself in an accident, call the police immediately and obtain an item number for the official accident report. Exchange contact information with the drivers of other vehicles. Make sure you use a current driver's license to obtain valid information. If the other drivers refuse, ask the police officer to provide you with the contact information of all parties involved.
- Carry a camera or cell phone with a camera feature to document the damages to vehicles involved in the accident and to document the number of passengers in each vehicle at the time of the accident.
- Avoid people at the scene of the accident who are not involved, especially if they are attempting to obtain information regarding whether you have a lawyer or a doctor.
- If your vehicle requires towing assistance and you have road assistance, make your own arrangements. Avoid tow trucks that happen to show up at the scene offering assistance. If you choose to use a towing service that arrives at the scene of the accident, make sure you have a

designated repair shop available to receive your vehicle. Do not allow the tow truck operator to recommend a repair shop that you have not heard of and did not make prior arrangements with.

- Contact your insurance company or producer as soon as possible to report the accident and to open a claim. Having a copy of the police report or police item number will help expedite the process. Once you have contacted your producer, refer any calls regarding the accident to the person handling your claim.

Report insurance fraud to the Louisiana Department of Insurance Fraud Division online at www.lidi.la.gov (Click on “Report Insurance Fraud”) or by phone at 225-342-4956.

TIPS TO PREVENT AUTOMOBILE THEFT – “PARK SMART”

Professional thieves can steal any car. Park Smart to avoid becoming a victim. To prevent vehicle theft, the LDI/Louisiana Automobile Theft and Insurance Fraud Prevention Authority (LATIFPA) recommends the following tips to consumers to prevent automobile theft:

- Lock your doors.
- Close windows.
- Park in well-lighted areas.
- Put valuables in the trunk.
- Use vehicle immobilizers.
- Use theft deterrents.

DON'T do these things:

- **Don't** leave your keys in the ignition while warming up or cooling off your car, while pumping gas, while running into a convenience store, or while dropping the kids off at day-care.
- **Don't** leave personal possessions (purse, laptop, packages from the store, cell phone, GPS, etc.) in your car where they can be seen.
- **Don't** hide a key in or on your car.
- **Don't** hide a firearm in your vehicle.

The Louisiana Automobile Theft and Insurance Fraud Prevention Authority (LATIFPA), a public agency within the Louisiana Department of Insurance, conducts an auto theft awareness education program designed to educate middle and high school students in Louisiana about the consequences of auto theft and how not to become a victim of automobile theft. LATIFPA also offers an online training course for “parking smart.” **For more information on the prevention of auto theft and insurance fraud, contact LATIFPA at 225-219-0452 or www.lidi.la.gov/latifpa.**

CHAPTER 7

INTERSTATE DRIVING AND RURAL ROADS

Traffic on an interstate normally moves safely and smoothly because there are fewer places for the type of problems that could cause crashes. However, the crashes that do happen are usually serious. Vehicles traveling the interstate are usually travelling at a higher rate of speed. When crashes do occur, they are usually more severe. As a driver, you need to know and follow some basic rules and practices to make interstate driving as safe as possible.

PLANNING AHEAD

Since interstate entrances and exits may be far apart, you should plan your route in advance. Use a map and know exactly where you will enter and exit the interstate. Also, make sure your vehicle is in good working condition. Since there are few service stations along some remote stretches along interstate highways, you may find yourself in serious trouble if you run out of gas or have a breakdown. Before you leave, check your gas, water, oil and tires. Don't forget to check your spare tire.

GENERAL INTERSTATE DRIVING

Be ready for changes in traffic conditions. Watch for signals from other drivers. Expect merging vehicles at on ramps and interchanges. Be prepared for rapid changes in road conditions and traffic flow. As you look ahead, think about what will (or might) happen on the road. Be alert for vehicles on either side, to the front and to the rear. Use your mirrors. Leave enough space between you and the vehicle ahead for safe stops. Always leave yourself an out. Mistakes cause crashes. To protect yourself, know which lanes are clear so you can use them if you need to.

ENTERING

Whenever you enter traffic, signal and be sure you have enough space to enter safely. You have to share space with traffic already on the road and must know how much space you need to merge with traffic and pass other cars.

Enter the interstate at or near the speed of traffic. Remember that the *maximum* speed allowed is 70 miles per hour unless otherwise posted. You should not drive slower than the posted minimum speed on the interstate unless the weather or road conditions demand slower speed. Always try to drive at a steady speed.

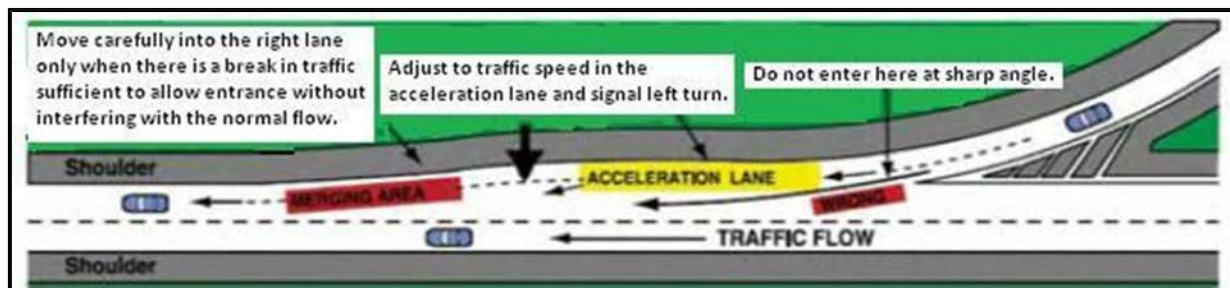

Begin checking traffic while on the entrance ramp. Do not move slowly to the end of the entrance ramp and stop. Start your turn signal to warn other drivers. Look for a gap in the approaching traffic. Then, adjust your speed to meet that gap. As you merge, make sure you are traveling the same speed as other traffic. Do not stop before merging with interstate traffic unless it is absolutely necessary. Interstate traffic has the right of way. You can't always count on other drivers either seeing you or moving over to give you space to enter.

SPACE TO MERGE

When you merge into traffic, you need a gap of four seconds. That will give both you and the car you merge in front of a two-second following distance. Don't try to squeeze into a gap that is too small. Leave yourself a big enough space cushion. Watch for vehicles around you. Use your mirrors and turn signals. Turn your head to look quickly to the side before changing lanes. It is a good idea to leave three seconds of space between you and the vehicle ahead. Make sure you can stop safely if you must.

At some interstate entrances, there is a short acceleration lane. With heavy traffic you are more likely to see cars stopped and waiting for large enough gaps in traffic. This situation is dangerous because of the risk of rear-end collisions and the need for fast acceleration to enter traffic. To enter traffic from a full stop, you will need about a full block to get up to the speed of the other vehicles on the interstate highway.

RIGHT-HAND LANE

Avoid unnecessary lane changing. Stay in the right-hand lane unless overtaking and passing, making an exit to the left, or letting another vehicle enter. However, you may drive in any lane of an interstate having three or more lanes in one direction with each lane having a specific function. The right hand lane is used for exiting and entering. The middle is often used as the "travel" lane and the far left lane is for passing.

When you approach most entrance points, you will see a "merge" sign. This sign warns you to be ready to adjust your speed or to move into the left lane, if possible. This will let other drivers enter traffic smoothly and safely.

The right-hand lane is also a place where some drivers slow down for an exit. This is dangerous. When you see an exit sign, be alert for drivers who suddenly slow or who swerve into an exit lane at the last second. Don't follow the vehicle in front of you too closely. Always keep at least a four seconds space cushion between you and the vehicle ahead. When the weather is bad or the pavement is slick, you should double that time. Rear-end collisions are the most frequent type of crashes on the interstates.

KEEPING A SPACE CUSHION

A cushion of space ahead, behind and to the sides gives you some distance to avoid the mistakes of other drivers. Rear-end crashes usually occur because of drivers following too closely. If your rear view mirror shows another vehicle is too close to you, realize you are dealing with an unsafe driver. You should still keep a safe following distance behind the vehicle ahead of you. In case of a rear-end crash, this may prevent you from being pushed into the vehicle ahead.

If you are being followed too closely (tailgated), slow down and encourage the driver behind you to pass. If this fails, pull over, stop and let the tailgater pass. Keep your doors locked. Keep a space cushion to the side to have room to react to sudden moves toward you by other vehicles.

- Avoid driving alongside other cars on multi-lane streets.
- Drive in the center of your lane to keep space between you and oncoming cars.
- Make room for vehicles entering interstate highways. If there is no one next to you, move over a lane.

SPACE MANAGEMENT

Always leave for your destination on time so that you do not need to rush while driving. To be a safe and defensive driver you must be aware of and manage the road space around your car.

There are three basic elements to space management:

1. Speed control
2. Lane position
3. Communication

Using these three tools, you can manage your space and be positioned to see and process information to make decisions. Your most important goal in managing your road space is to achieve a balance of these three tools at all times.

EXITING

One of the main reasons for planning ahead is to know exactly where you want to leave the interstate. Look ahead for signs telling you about the exit you want and the lane you must use. Approximately a mile before your exit, check to make sure you are in the correct lane to make the exit. Change lanes one at a time until you are in the proper lane to safely make the exit. Signal your intention for approximately five seconds and make sure you are at the proper speed for leaving the traffic lane - not too fast so you won't lose control and not too slow so the flow of traffic can still move freely.

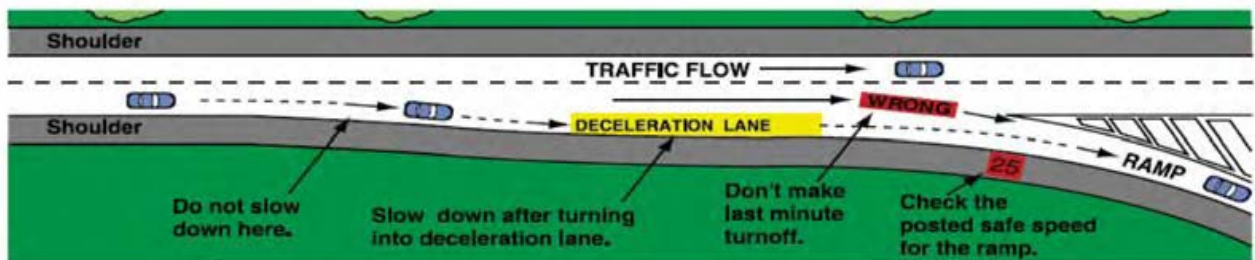

If you miss your exit, do not stop; do not back up! It is against the law and is one of the most dangerous things you can do on an interstate highway. Go on to the next exit, get back on the interstate and return to the exit you want.

Most interstate exits have a special lane for you to use to slow down before you reach the exit. Never slow down on the interstate itself. Wait until you are fully in the deceleration lane, and then reduce your speed to the posted ramp speed. Be aware of two-way traffic ahead after your exit from the interstate.

RURAL ROADS

Sometimes you may leave the urban areas of the city for less trafficked roads. Whether you're visiting or you normally drive in rural areas these roads have unique challenges. Driving on empty rural highways can be just as dangerous as driving in heavy city traffic. It is easy to relax your attention and suddenly come upon something dangerous. Stay alert, watch for warning signs and slow down. Some road conditions and driving hazards are unique to rural roads when compared to a paved interstate or city street. Rural roads consist of paved, gravel and dirt roads.

It is important to understand the different types of hazard that are common on rural roads.

- *Gravel or Dirt* – Vehicles do not have as much traction on gravel or dirt roads as they do on concrete or asphalt roads. When driving on gravel or dirt, you must reduce your speed and increase your following distance, since it will take much longer to stop due to loss of traction. Skidding can occur when traction is lost. Gravel or dirt roads can become rough and rippled from where a series of potholes has formed and can affect steering and vehicle control.
- *Dust* – During dry periods of the year, gravel roads can become extremely dusty. Vision can be reduced. It is recommended that you use low beam headlights to make your vehicle more visible to others, slow down and increase your following distance.
- *Narrow bridges and roads* – Gravel or dirt roads can be narrow and have little to no shoulder, which can be hazardous. Ditches can be close to the road, very steep and dangerous. You should look for narrow bridge signs and be prepared to stop for oncoming traffic. These roadways may have sharp dips or unexpected turns; therefore, you should slow down and increase your following distance.
- *Open Bridge Gratings or Steel Bridges* – Reduce speed, as traction for braking and steering is reduced. Due to the reduced traction, keep a firm grip on the steering wheel and increase your following distance.
- *Vision limitations* – Blind corners created by wooded areas, corn fields or other tall crops can create vision limitations.
- *Steep hills and curves* – Hills and curves on rural roads are often steeper and sharper than on highways. Before reaching the crest of a hill or before entering a curve, slow down, move to the right side of the road and watch for oncoming vehicles.
- *Highway-railroad grade crossings* – Many highway-railroad grade crossings on rural roads are marked only with a warning sign and a white X-shaped railroad crossing sign and typically do not have lights or crossing gates, therefore, you should always slow down, look both ways and be prepared to stop for a train before crossing the tracks.
- *Uncontrolled intersections* – Some intersections on rural roads are not



controlled by yield or stop signs. These intersections can be very dangerous if you do not approach them with caution. When approaching an uncontrolled rural intersection slow down and be prepared to stop for crossing or oncoming traffic.

Expect:

- Other road users and animals coming out of hidden junctions and driveways
- People working, walking or cycling on the road
- Farm machinery and slow-moving vehicles
- School buses picking up/ dropping off students

ANIMALS

Sometimes animals also pose a risk for drivers. There is an estimated 1.5 million deer-vehicle collisions annually in the United States, causing more than 150 fatalities and \$1.1 billion in property damage. Use caution when approaching deer-crossing warning signs. The signs are there for a reason.

Keep your speed down at night. If you see one animal, expect there is another nearby. Know which seasons and times are worse than others. Wildlife is more active at dusk and dawn. This is also it is hardest for our eyes to adjust as it is neither completely dark nor completely light. When traveling in a wildlife area, actively scan both sides of the roads as your drive.

Sometimes a domesticated animal such as a horse or cow may wander into the roadway. Sound your horn and brake in a controlled manner. Don't scare the animal so that it runs into the path of another vehicle or swerve around the animal causing it to panic. Usually sounding the horn is enough for the natural instincts of an animal to take over. Remain calm. When it is safe notify the local authorities of the problem so that the animal does not cause an accident or injury.

If Wild Animals are on the road:

- Slow down or stop
- Do not use the horn or rev the engine
 - Pass as far away from the animals as possible

There may be times when an animal suddenly runs in front of your vehicle. Do not swerve into oncoming traffic or off the roadway to avoid hitting the animal. Big game animals, mostly deer, are large enough to cause damage to a motor vehicle. The size of the animal may cause you to take drastic action to prevent a collision. This may result in a more serious crash than if the vehicle collided with an animal. Regretfully, the safest alternative may be hitting the animal. Concentrate on regaining control of the vehicle before, during, and after the collision with the animal.



You can use these precautions to reduce your chances of colliding with an animal:

- Use caution when driving at dawn and dusk and between the months of October through December, when animals are most active.
- Use caution and be alert when driving on roadways marked with deer crossing signs. These signs are placed in areas that have had a large number of deer/vehicle collisions.
- Look well down the road and far off to each side. Scan the sides of the road to watch for the reflection of your vehicle headlights in the eyes of animals, especially at night and near woods and water.

- Slow down and use caution when approaching animals that are standing near the roadway, they may bolt or change direction at the last minute and there may be other deer following since they travel in groups.
- Use flashers or a headlight signal to warn other drivers when animals are spotted on or near the road.
- If you think you have time to avoid hitting an animal, reduce your speed, tap your brakes to warn other drivers and sound your horn. Deer tend to fixate on headlights so flashing them may cause the animal to freeze in the road. If there are no vehicles close behind you, brake hard, but do not lock wheels causing a skid.
- Pets, such as dogs may also run out on the roadway. Dogs that chase vehicles tend to approach in a straight line. Slow down until the dog is near your vehicle then accelerate away from the dog as it approaches. Dogs are likely to be seen in residential, rural or farm areas.

If an accident with an animal is inevitable, here are some suggestions for lessening the impact:

- do not swerve to avoid the animal; your risk of personal injury may be greater if you do. Keep your vehicle under control and on the roadway when you hit the animal.
- Steer your vehicle towards the area the animal came from. This may take you away from the animal and it is more likely to keep moving forward rather than backtracking. This will only work if there is one animal and not a group such as a herd of deer.
- Shift your line of eyesight to that spot as well - don't look at the animal or you'll steer that way.
- Try to skim rather than fully impact the animal.
- Brake firmly, angle the vehicle and take your foot off the brake as you impact. The release of the brake will cause slight lift of the vehicle and this may be enough to stop the animal from rising into your windshield if your vehicle is tall enough.
- Report the crash to the police if it involves a large animal such as a deer or farm animal. If the animal is a domestic pet and homes are nearby try to notify the pet's owner, if possible. Do not go inside someone's home.

SLOW MOVING VEHICLES

Be alert for slow moving vehicles, especially in rural areas. A fluorescent or reflective orange and red triangle displayed on the rear of vehicles drawn by animals, farm equipment or construction equipment means the vehicle is traveling less than 25 mph. Use caution when approaching a slow moving vehicle and be sure it is safe before you pass.

- **Farm machinery** – Watch for tractors, combines and other farm equipment moving across the road and traveling on state highways in rural areas. Farm machinery can be very large and wide enough to take up more than one traffic lane. Farm machinery usually does not have turn signals and to make a right turn, operators of farm machinery may pull wide to the left and then turn to the right. In most cases, these vehicles will be traveling at less than 25 mph. Pass with caution and remember the operator of the farm machinery cannot hear approaching vehicles.
- **Animal drawn vehicles** – In some rural areas, you may be sharing the road with animal drawn vehicles. They have the same rights to use the road as a motor vehicle and must follow the same rules of the road. They are subject to heavy damage and injury to the occupants if hit by a vehicle. Normal speeds for animal drawn vehicles range between 5 and 8 miles per hour. They may be even slower when pulling large farm equipment or when crossing intersections.



Another hazard to consider is restricted vision from the driver of the animal drawn vehicle. When pulling large loads of hay or other equipment, drivers may not be able to see vehicles behind them; therefore, you need to be extra cautious when passing animal drawn vehicles. Pass with caution and do not use your horn or “rev” the engine because this may scare the horse and cause a crash. To avoid other possible collisions, you should anticipate left turns made by animal drawn vehicles into fields and driveways. Warning signs will be posted in areas where you are likely to find animal drawn vehicles so be alert.

- **Horseback riders** – Horseback riders are subject to and protected by the rules of the road. They must ride single file near the right curb or road edge, or on a usable right shoulder, lane or path. Use caution when approaching a horse being ridden or led along a road. Areas where horseback riding is common will usually be marked with an advisory sign. You must drive at a reasonable speed and at a reasonable distance away from the horse. Do not sound your horn or “rev” your engine loudly when approaching or passing a horse. It could scare the horse and cause a crash.



Driving Slow Moving Vehicles

If you are driving a slow moving vehicle and you have to drive so slowly that other vehicles have to reduce speed to the rear, pull to the side of the roadway when safe to do so and let the other vehicles pass. Many states have “turnout” areas on some two-way, single lane roadways that must be used when you are causing vehicles to the rear to slow down significantly. Other two-way, single lane roadways sometimes have selective “passing lanes” to reduce congestion to the rear of slower vehicles.



SAFE AND RESPONSIBLE HANDLING OF THE VEHICLE UNDER VARIOUS CONDITIONS

It's important to know as much as you can about your vehicle's weight, especially if you plan to haul a lot of cargo or pull a trailer or moving van. For example, if you attach a small moving trailer and don't know the weight of your vehicle, you can overload it, which affects safety. If the vehicle is overloaded it can cause harm to your brakes making it hard for you to stop or slow down and can damage your suspension. Error on the side of caution whenever hauling large amounts of cargo. If you're pulling a trailer, you should know how much the gross combined weight rating will be. If renting a moving trailer, ask how much the trailer weighs when empty and how much weight it can hold to help you determine total weight. You can find your gross vehicle weight (GVR) and your gross vehicle weight rating (GVWR) in your owner's manual as well as other ratings to ensure your safety on the road. It should also appear on your title and registration documents.

WEATHER CHANGES

A sudden change in the weather calls for a change in driving. For your safety, it is important that you adjust your speed to the weather conditions. When driving in a heavy downpour or in fog, slow down and turn on your low beam headlights. If the fog is so dense that it impairs your vision, you should not drive at all. If you must drive, slow down and drive to the nearest place where it is possible for you to get off the highway and stop. You are risking your life by creeping along at 10 to 20 miles per hour on the highway.

Be prepared for an emergency stop. Red tail-lights may be a vehicle that is stopped on the roadway or just barely moving. Be aware that vehicles coming up behind you may be driving too fast. Tap your brakes to make these drivers aware of your vehicle.

AT NIGHT

Night driving creates a different set of problems for drivers. Driving at night is more hazardous and more difficult than daytime driving. You cannot see nearly as much with your headlights as you see in the daytime. Headlights limit your range of visibility. Here are some things you can do that will help you to see better at night:

- Use your high beams whenever there are no oncoming vehicles. High beams let you see twice as far as low beams.
- Dim your high beams whenever you come within about a one-block distance of an oncoming vehicle. If a vehicle comes toward you with their high beams on, flash your headlights once quickly. If the driver fails to dim their lights, look toward the right side of the road to keep from being blinded by their headlights. Do not try to “get back” at the other driver by keeping your bright lights on. If you do, both of you may be blinded, possibly causing a crash.



Use your low beams when following another vehicle, in heavy traffic, in fog, or when it is snowing or raining hard.

- Light from high beams will reflect back, causing glare and making it more difficult to see ahead. Some vehicles have fog lights that you can use in fog, snow or rain.
- Avoid looking directly into oncoming headlights as this can cause momentary blindness from the glare.
- Develop the ability to glance well ahead of your headlight beams, looking for dark shapes on the roadway.
- Glance occasionally to the right and left to determine the location of the edge of the pavement and hazards that may come from the sides.
- Do not wear sunglasses or colored glasses when driving at night or on dark days. Colored lenses cause your eyes to adjust even more slowly and can reduce your vision.

In the country or in more rural areas, it's easy to out-drive your headlights. You should be able to stop within the distance lit by your headlights. Increase your following distance to at least four seconds.

A clean windshield can make a big difference to visibility.

Whether you drive in urban, rural, or interstate there are three types of conditions you encounter on the road:

1. Open Conditions -This means that you have a space or a larger area in which to drive that is without restrictions. You see only wide, open spaces on the road ahead, with no restrictions around your car. You are free to move forward or to change lanes without conflict.
2. Closed Conditions -A closed zone means that it is not available for your car's path of travel, that there is a restriction to the driver's view or that space is unavailable in a particular zone. You will encounter this type of conditions driving in moderate to heavy traffic.
3. Changing Conditions- This often occurs when the driving situation changes from an open to a closed zone. Changing conditions can include speed limits, roadway or weather conditions, lane width, environmental conditions, visibility, traffic flow, time of day, traffic controls, etc. Each of these conditions should have an influence on what speed is appropriate, the path of travel, and what type of communication is used.

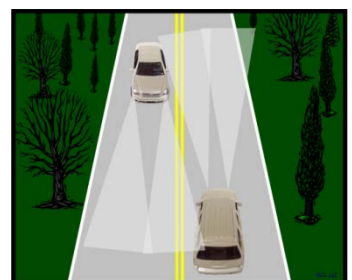

The urban driving environment is typically more challenging to the novice driver because there are more stimuli to be sorted and react to. Reducing speed allows more time to see details of the urban driving environment such as pedestrians, road hazards, and traffic flow. It also allows time to analyze what you see and predict what might happen, react to any hazards that might require quick reflexes, and execute decisions to safely change directions and avoid hazardous situations



TRIP PLANNING

There are ways you can help reduce your driving costs. First, determine your overall transportation needs. For each trip, determine if it is necessary. If so, there may be times you do not need to drive yourself. You might ride with someone else or you could take public transportation if it is available. The best way to extend the life of your vehicle and save on fuel is to use it as little as possible.

To help cut down on your driving and make trip planning easier:

- Take public transportation when it is available.
- Avoid driving during heavy traffic. It causes extra wear and tear on you and the vehicle.
- Use carpools or share rides whenever possible.
- Plan, and then combine your trips. Make a list of the things you need and the places you need to go. Go to as many places as possible on any one trip.
- Call ahead to make sure that they have what you need or that what you are picking up is ready.

By doing these things you can help cut down on the amount of traffic on the road, cut your travel costs and save yourself time and effort.

To prepare a vehicle for any trip be sure to check the important mechanical components such as windshields and windows, lights, tires, all fluid levels, belts, hoses and brakes. Get a good night's sleep the night before the start of the trip.

Before going on a trip, consider the time of day to avoid congestion in city areas. Have a plan for the route including the route number, entrance and exit numbers of the final destination. Consider rest stops, fuel stops, food stops and potential construction areas. Take a map with routes highlighted or a description of a route written on paper as a reference.



Determine the number of miles to be traveled daily. The average number of miles driven on major highways is 100 to 110 miles every two hours with 10 to 15 minute breaks every 2 to 3 hours and 1 hour stops for meals. When traveling on secondary roads, which go through towns and cities or traveling through mountains, it will take longer to get to your destination.

If one person will be doing all of the driving, 6 to 8 hours of driving in any one day should be considered the limit. When two or more persons can share the driving, total driving time should not exceed 10 to 11 hours. Avoid driving after dark when visibility is limited and particularly after 11 p.m. when you are more apt to fall asleep while driving.

Be prepared when going on any trip. Remember to take:

- An extra set of keys in case you lock your keys in the vehicle or lose them
- Insurance information in case you are in a crash
- Money for expected and unexpected travel expenses
- Vehicle owner's manual in case your vehicle breaks down
- Maps of local areas in case you get lost

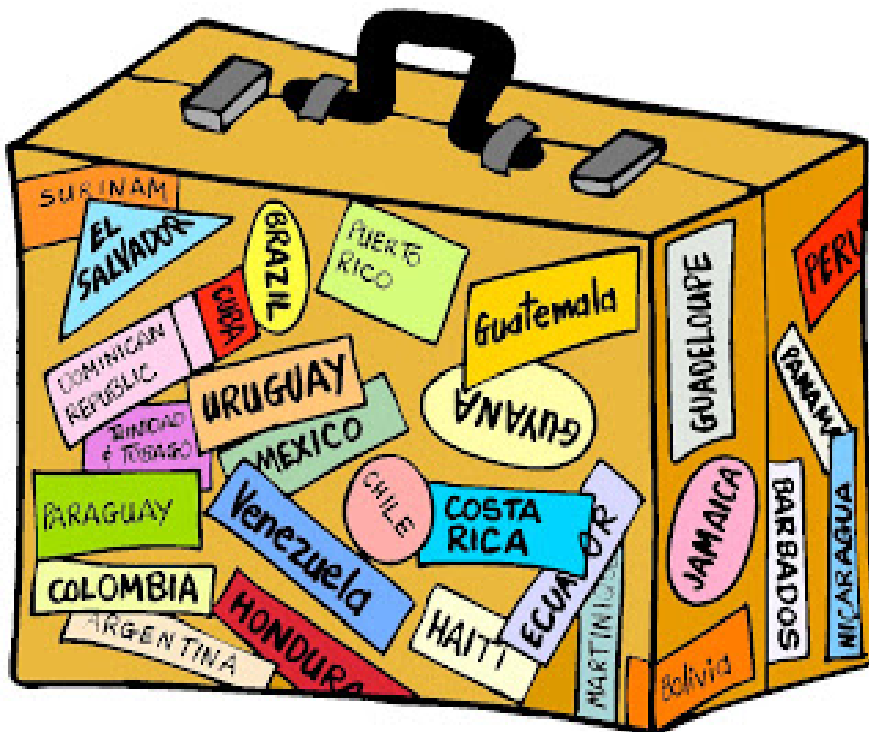

CHAPTER 8

DRIVING HAZARDS AND EMERGENCIES

When you are driving a vehicle, things can happen very fast. You may have very little time to react, so you must know how to handle emergencies when they happen. The worst hazards to safe driving are cell phone usage, weather, alcohol, drowsiness, aggressive behavior, unintended acceleration, eating and/or drinking while driving. There is no way to eliminate all potential hazards when driving. But you can better prepare yourself to handle the emergency should it present itself.

Before you start your engine, always remember:

- Never drive impaired.
- When approaching your parked vehicle, look in front, under and behind, scanning for any objects in your travel path.
- Adjust your seat cushions and mirrors.
- Verify that all occupants are wearing seat belts.
- Eliminate distractions prior to driving.

DISTRACTED DRIVING

Distracted driving is any non-driving activity a person engages in that has the potential to distract him from the primary and complicated task of driving and increase the risk of crashing. Drivers are frequently distracted, perhaps as much as half the time.

Three main types of distraction:

- Visual — taking your eyes off the road to look at something else
- Manual — taking your hands off the wheel to do something (i.e., adjusting the radio)
- Cognitive — taking your mind off what you're doing

While all distractions can endanger a driver's safety, texting is the most alarming because it involves all three types of distraction.

Other distracting activities include:

- Using a cell phone
- Eating and drinking
- Talking to passengers
- Grooming
- Reading, including maps
- Using a PDA or navigation system
- Watching a video
- Changing the radio station, CD, or Mp3 player



5 Things to Remember About Distractions:

All distractions are not the same as each has different levels of risk and crash involvement.

Cognitive distraction is real. Using a hands free device may keep your hands on the wheel but not necessarily your mind on your driving. It's not just where your hands are, it's also where your head is. Laws that ban only handheld use likely will not be effective in reducing risks or crashes because the cognitive distraction still exists with hands-free phone.

Texting is very high risk and teens are the highest risk group. Louisiana has laws against texting by any age group.

The number one driver distraction that is involved in most of the crashes is cell phone use.

Concentrating on the act of driving is vital to driving safely. The driver's seat is no place for daydreaming, intense conversation, or absentmindedly looking at scenery. There have been too many crashes after which the driver said "I don't know what happened."

These are some suggestions to avoid distractions:

1. Turn off your cell phone or set it to silent before you get in the car. If you can't hear it you won't be tempted to answer it or look at it.
2. Leave a message on the phone that lets others know you can't take the call.
3. If you must make a call pull over to a safe location.
4. Have a passenger make the call for you.
5. Never, ever text or surf the web while driving. Do not read your emails while driving.
6. Prepare for your trip whether it is long or short. If you are going to an area you are not familiar with study maps or get driving directions before you start to drive.
7. If you are driving with pets, secure them properly before you begin.
8. If a situation should arise with a child, pull over to a safe location before you handle it. Teach children the importance of good behavior in cars.
9. Ask a passenger to serve as your 'co-pilot.'
10. Do personal grooming at home.
11. Do not try to retrieve items that fall on the floor or elsewhere in the car.

Most important of all is to **focus on your driving**. Refrain from smoking, eating, drinking, reading, or any other activity that may take your attention and eyes off the road.

RISKS AND TEENAGE DRIVERS

Teens are at a greater risk for accidents, including fatalities, than any other age group of drivers. Teens are 50% more likely to have an accident in the first month of driving alone without parental supervision.

The contributing factors are driving inexperience, risk-taking behaviors, immaturity and greater risk exposure. The late night lifestyle of teens adds to the risk of an accident occurring due to drowsiness. Teens are more likely to make a poor decision due to peer pressure. Teens, more than any other age group are likely to be involved in a single vehicle crash. One in three deaths for this age group is due to a



motor vehicle crash. Most teenage deaths (due to a motor vehicle accident) occur on weekends as 53% of all teen accidents occur on the weekend. When teens were asked what they felt were the leading causes of unsafe behavior while driving, the use of alcohol and texting were listed highest. However, the top factors for fatal crashes involving teens are unsafe speeds and non-use of seat belts.

- ✚ Over two-thirds of teens admit to a near miss that could have ended in a crash. Of those two-thirds, there will be at least one half that will have multiple near-misses. Unfortunately many teens do not make the connection between bad driving habits and close calls. Teenagers are quick learners and will often master the fundamentals of driving quickly. However, the biggest challenge a teen will face is concentrating and remaining focused on the task of driving. Teens are easily distracted while driving by the radio station, the mp3 player or other teens in the car.
- ✚ Too often teens do not have good role models to follow in safe driving habits. Only one in five teens can admit to parents talking to them regarding safe driving habits and taking an active role in the development of safe driving habits. Parents will also exhibit unsafe driving behavior while teens are in the car.
- ✚ Young people ages 15-24 make up 14% of the population in the U.S and 6% of the licensed drivers. However, they account for 30% (19 billion) of the total cost of motor vehicle injuries among males and 28% (7 billion) of the total costs of motor vehicle injuries among females. 19% of fatalities in the U.S. involved young drivers.
- ✚ The risk of a teen driver being killed or injured in accidents becomes greater if there is a teenage passenger involved. The risk increases exponentially with each additional passenger. Eighty-one percent of teenage motor vehicle crash deaths in 2008 were passenger vehicle occupants. Of that 81%, 55% were not buckled up.
- ✚ In 2009, about 3,000 teens in the U.S. ages 15 -19 were killed and more than 350,000 were treated in emergency rooms for injuries suffered in motor vehicle crashes. While this is down from 6,100 in 2002, it is still too high. Today, drivers ages 16 to 19 have a fatality rate four times as high as that of drivers 25 to 29.

Teenagers not only have a higher crash rate than other age groups, their crashes are different. The combination of inexperience behind the wheel and immaturity produces a pattern of fatal crashes among 16-year-old drivers that includes the highest percentage of crashes involving speeding, single- vehicle crashes, crashes due to driver (teenager) error and occupancy. According to statistics, teenage drivers lack maturity and experience in driving. Teenagers are more willing to take risks and less likely to use safety belts. They are more likely to underestimate the dangers associated with hazardous situations and less able to cope with such dangers. With these things in mind, all states and several other countries have developed a Graduated Licensing Program (GLP) in an effort to reduce teenage deaths on the highway.

AVOIDING COLLISIONS

There are four factors that contribute to the majority of the collisions in the U.S. They are:

1. Equipment Failure - brakes, unsafe tires, steering, and suspension.



2. Roadway Design – traffic control devices, roadway surfaces, weather, road hazards, and traffic flow.
3. Poor roadway maintenance – debris on the highway, potholes, and construction.
4. Driver Behavior – speeding, tailgating, aggressive driving, unsafe lane changing, failure to signal, and failure to give the right of way.
5. In 95% of motor vehicle accidents there was some factor of driver behavior combined with one of the other three factors that caused the accident to happen. Even with the best defensive driving behavior, unfortunately, there are some occasions that an accident cannot be avoided. In a few seconds that you have before a possible crash, try not to panic. Reacting properly and quickly can avoid crashes or at least minimize the damage.

To prevent some injuries that commonly occur in a collision you should put loose items in the trunk whenever possible. Have an “accident kit” in your glove compartment. Your kit should include paper, pen, insurance information, medical information if needed, and emergency supplies.

Know your vehicle and its braking system! If you have a manual (disc) brake system, do not brake hard and hold. This locks the wheels and puts the car into a skid. To stop quickly in an emergency, you should:

1. Pump the brake.
2. Push the brake pedal hard.
3. As the car begins to skid, quickly let up on the brake.
4. Then quickly push down again. Use this quick pumping action until the car is stopped.

If you have an anti-lock braking system (ABS), when the brakes are pressed hard, the ABS pumps the brakes up to 30 times/sec. According to NHTSA, the ABS works with your regular braking system by automatically pumping them. If your vehicle is not equipped with ABS, the driver has to manually pump the brakes to prevent wheel lockup. In the ABS, this system helps you maintain control and stops the car in a straight line rather than spinning out of control. Focus on where you want the car to go. ABS does not stop the car faster. It enables you to stop it where you want to by allowing you to concentrate on steering the car to safety.

To determine if your vehicle has ABS check your owner’s manual. You can also determine if you have ABS by checking your instrument panel. When you start your vehicle the ABS light will illuminate and then dim. If you see an ABS indicator light then you have ABS. If the light stays lit the ABS is not working correctly.

Turning quickly may be your only chance of avoiding a front end crash. If a crash looks probable, turn away from it even if it means leaving the road. Drive (rather than skid) off the road. Choose to hit something that will give way (such as brush or shrubs) rather than something hard. If you have to hit anything, try to make it a glancing blow. A sideswipe, for example, is better than a head-on crash. Never cross over into the oncoming traffic lane. The other driver may swerve back into his own lane.

Sometimes you may need to **speed up quickly** to avoid a crash. This may be the case when another car is about to hit you from the side or from behind. If your car has a manual shift, shift quickly into a lower gear and push the gas pedal to the floor. In any case, you may have only seconds to decide and act.

Oncoming car in your lane:

If you see a car coming toward you in your lane:

1. Blow your horn and flash your lights to warn the other driver, if you have time.
2. Brake fast, but don't lock your wheels and lose control.
3. If the other driver keeps coming and a crash is probable, steer off the road to the **right** shoulder or ditch. **Do not drive into the left lane.**

Overtaking vehicle in danger:

If another vehicle is attempting to overtake and pass you but cannot complete passing because of oncoming traffic, you must act quickly to help avoid a crash.

1. If the passing vehicle continues to attempt to pass, you can help by slowing your vehicle and moving as far to the right as you can safely.
2. If the other driver definitely cannot complete the pass and must drop back, increase your speed so that he can move in behind you.
3. If the right shoulder is safe and a crash is almost certain, move quickly onto the shoulder to allow the passing car to move into your lane. (In either case, be certain of the intentions of the driver of the passing vehicle before you change your speed.)

PROTECTING YOURSELF IN A CRASH

You may not always be able to avoid a crash. If you are about to be hit, here are some tips on how to protect yourself. The best protection before a crash is to always buckle your seat belt and shoulder harness before you start any trip in your vehicle no matter how short your journey will be.

Rear Collisions:

If you are about to be hit from the rear:

1. Be ready to apply your brake so you won't be pushed into the car ahead.
2. Brace yourself between the steering wheel and the seat back.
3. Press the back of your head firmly against the head rest.

Side Collisions:

If you are about to be hit from the side:

1. Keep a tight grip on the steering wheel. This may keep you from being thrown against the side of the car.
2. Get ready to steer quickly so that if you spin around you can try to regain control of the car.

Head-on Collision:

If you are about to be hit from the front:

1. Use your arms and hands to protect your face if you are wearing your seat belt and shoulder strap.
2. If you are not using your shoulder strap, throw yourself across the seat to keep from hitting the steering wheel or windshield.

Rollovers

Rollovers are much more likely than most other types of crashes to result in serious injury or death. Even though only about one of every forty vehicles involved in a police reported crash has rolled

over, one of every three passenger vehicle occupant deaths occur in rollovers. This illustrates the seriousness of rollover crashes.

The majority of rollovers occur during ordinary driving situations. Many rollovers occur when a driver suddenly swerves to avoid an obstacle such as a stopped vehicle in the road or when a driver accidentally veers off the road. When you lose control of your vehicle and it begins to slide sideways something can “trip” the vehicle and cause it to roll over. This tripping object could be a curb, guardrail, tree stump, or soft, uneven ground on the side of the roadway. If you are speeding or you turn the wheel too sharply, the friction between the tires and the road can cause the vehicle to trip and then roll over. Rollover crashes are more common for sport utility vehicles (SUVs), vans, pickups and small trucks than for passenger vehicles due to their higher centers of gravity, which makes them top heavy and more likely to tip over. Whenever the height of a vehicle rises, the center of gravity also rises. Additional cargo and passengers can also increase the chances of a rollover.

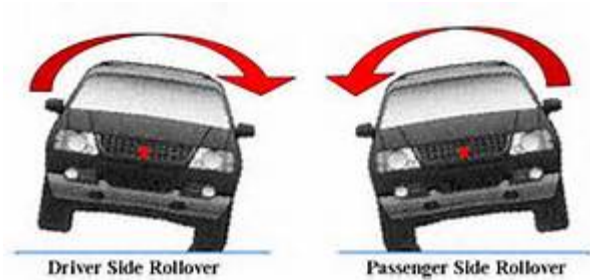

You can reduce the likelihood of having a rollover crash simply by making some smart choices:

- Speed is an important factor that contributes to rollover crashes and one factor that you can control. The faster you drive, the less time you have to react to any emergency that suddenly arises in the road ahead of you, which means you will probably end up steering more sharply and/or braking harder. Simply obeying the posted speed limit and using extra caution in bad weather can reduce your chances of having a rollover crash.
- Many rollovers occur when drivers overcorrect their steering in response to unexpected situations, such as encountering a stopped vehicle in their lane or accidentally driving off the pavement. Sudden steering maneuvers at high speeds or on soft surfaces can lead to rollovers. If your vehicle leaves the paved road surface, slow down gradually, but do not jerk the steering wheel to get the vehicle back on the pavement.
- The most effective way to reduce the risk of injury or death in a rollover is to use your safety belt. Without safety belts, occupants in vehicles that roll can be thrown from the vehicle, greatly increasing the risk of serious injury or death.
- Air bags play an important part in reducing injury. Side airbags triggered by rollover sensors can prevent the upper body from being exposed to contacts with the ground or even complete occupant ejection.

OTHER VEHICLE EMERGENCIES

Skids:

Most skids happen when you try to turn or stop suddenly on slippery pavement. If the rear of your car starts to slide, don't use your brakes. Steer in the direction in which the rear end of your car is skidding.



To steer out of a skid:

1. Take your foot off the gas pedal.
2. Turn your front wheels only enough to keep them going straight down the road. If the rear of your car is skidding to the right, turn the front wheels to the right. Turn left for a skid to the left.
3. Be careful not to over steer. Your car may start to skid the other way. Again, turn your wheels in the direction of the skid. You can feel when the car is back under control. Then, straighten the wheels.

Taking these simple tips into account can save your life:

1. You can prevent skids by driving slowly and carefully, especially on curves. Steer and brake with a light touch. When you need to stop or slow, do not brake hard or lock the wheels and risk a skid. Maintain mild pressure on the brake pedal.
2. If you do find yourself in a skid, remain calm, ease your foot off the gas, and carefully steer in the direction you want the front of the car to go. You must be prepared to turn the steering wheel again and again until the front of the vehicle is traveling in a straight line. For cars without anti-lock brakes, avoid using your brakes. If your car has ABS, brake firmly as you steer into the skid.
3. Avoid hydroplaning by keeping your tires inflated correctly. Maintain good tire tread. Don't put off replacing worn tires. Slow down when roads are wet, and stay away from puddles. Try to drive in the tire tracks left by the cars in front of you.
4. If you find yourself hydroplaning, do not brake or turn suddenly. This could throw your car into a skid. Ease your foot off the gas until the car slows and you can feel the road again. If you need to brake, do it gently with light pumping actions. If your car has anti-lock brakes, then brake normally. The car's computer will automatically pump the brakes much more effectively than a person can do.
5. A defensive driver adjusts his or her speed to the wet road conditions in time to avoid having to use any of these measures

Caution:

Different types of braking and steering systems and vehicles with 4-wheel drive or front-wheel drive respond in different ways. If your car begins to skid due to wet or icy conditions:

- Let off the gas
- Do not brake!
- Simply look and steer in the direction you want to go.
- Be prepared to counter steer after making the initial steering corrections.
- Try not to use your brakes during a side skid. If necessary, pump them lightly.

ESP stands for Electronic Stability Program. Many vehicles today come equipped with an esp that works in conjunction with ABS brake system. The ESP computer continually monitors the traction available. ESP electronically compares where a driver is steering the vehicle and where the vehicle is actually going. When ESP senses traction problems between the two, it selectively applies any one of the vehicle brakes to reduce the possibility of a skid and helps the driver to maintain control and stability of the vehicle. In traction loss, with ESP you should steer the vehicle toward the direction you are looking and avoid abrupt steering. The ESP will electronically adjust the vehicle, reducing the traction loss and allowing you to steer the vehicle toward the travel path.

Wheels roll off the pavement:

If your wheels should slip off the edge of the road, do not try to turn back onto the pavement right away. This could cause you to swerve into the lane of oncoming traffic. You should stay on the shoulder:

1. Slow down by gently using your brakes.
2. If there is no drop-off from the pavement, gently steer back onto the road.
3. If the shoulder is much lower than the pavement:
 - a. Slow to a very slow speed (10 mph)
 - b. Look for traffic coming in both directions
 - c. Turn your wheels sharply back onto the pavement

Stalled on railroad tracks:

If your vehicle is stalled on a railroad track and there is immediate danger of an approaching train, don't try any last minute heroics to make it. Get all passengers and yourself out and walk quickly alongside the tracks in the direction toward the approaching train so that you will not be struck by debris when your vehicle is hit. If danger is not immediate, and you are certain there is time, you may move your vehicle off the tracks.

Tire blowout:

The most important rule is - don't panic and don't slam on the brakes. You should:

1. Hold the steering wheel firmly and keep your car in the same lane. There may be a strong pull to the right or left.
2. Let your car slow down. Don't use the brakes until you have slowed to a safer speed, (around 30 mph).
3. Then brake gently and pull off the road into a safe area.

Gas pedal sticks:

If your gas pedal sticks, keep your eyes on the road:

1. Put the gear shift in neutral.
2. Try to free the pedal with your foot. Have your passenger try to free it if you can't.
3. Turn the ignition off. (Use care not to lock the steering wheel locking mechanism. Vehicle with power steering and brakes will require much more effort to control)
4. Put on the brakes. Pull off the road into a safe area.

Brakes fail:

At the first sign of trouble, try not to panic. Do not put your parking brake on suddenly. This could cause you to lose control of your vehicle! Instead, work your vehicle into the right lane and then toward the shoulder or, if possible, toward an exit. If it is necessary to change lanes, do so smoothly and carefully, watching your mirrors and the traffic around you.

1. Let the car slow down gradually by taking your foot off the gas pedal. Simply steer your vehicle as it slows and shift the car into a lower gear to let the engine help slow the car.
2. Shift into neutral and gradually apply the hand brake until the vehicle stops. If that brake has also failed, direct the car onto a soft shoulder or rub the wheel against a curb which will help the car slow down.
3. Do not attempt to drive your vehicle, no matter how slowly, without brakes! Call for help.

Loss of a wheel:

This is a rather uncommon emergency, but if it should happen, uses the same procedure as for a tire blowout. The warning signs are a thumping noise and/or pulling to one side. Once stopped, you will be unable to move the vehicle; it must be towed.

Overheating:

If steam begins to come from under the hood, your cooling system is boiling. You should pull to the side of the road and turn off the engine. Do not open the radiator cap. Wait for the engine to cool.

Fire:

Most vehicle fires occur as a result of an overheated engine, an electrical short, a fuel leak or an oil leak. Any burning odor should be immediately investigated. If smoke comes from under the hood:

1. Drive off the road clear of traffic and stop.
2. Turn off the engine and all electrical switches.
3. Get all passengers out of and away from the vehicle. Poisonous fumes may fill the vehicle.
4. If the fire is small, use a chemical fire extinguisher, dirt, mud, sand or clothing to smother the fire. Do not use water on gasoline, oil or an electrical fire.
5. If a large gasoline or oil fire develops, you may not be able to fight it. Don't try; seek assistance.

Dead Battery:

If your car has a dead battery, be very careful if you "jump start" it from another car's battery. Either battery could possibly explode and cause you injury. Here are some helpful hints:

1. Take off the vent caps from both batteries. Put a cloth over the open vent wells.
2. Turn off lights, heater or air conditioning and radio.
3. Connect the positive post of the **dead** battery to the positive post of the **live** battery.
4. Then connect the negative post of the **live** battery to the negative post of the **dead** battery or to the engine block or frame.

Make sure the two cars are not touching. Then, start the car giving the jump. After letting it run a few minutes, start the other car. Take off the cables in the opposite order and put the vent caps back on. Safely discard the cloth used to cover the vent wells.

- If you get battery acid on your skin, eyes, or car, wash it off immediately with water.
- NEVER light a match or smoke a cigarette near a battery. The fumes from the battery can cause an explosion.

Breakdowns:

At the first sign of car trouble, gently and smoothly take your foot off the accelerator. Do not brake hard or suddenly. Carefully work your vehicle toward the side of the road. If you are on an interstate, try to reach an exit. Signal your intentions to drivers behind you. If it is necessary to change lanes, watch your mirrors and the traffic around you closely.



Once off the road, make your car visible. Put reflectorized triangles behind your vehicle to alert other drivers or use your emergency flashers. If it is dark, turn on the interior dome light, or, if you have flares, put them at least 100 feet behind your car.

Do not try to flag down other vehicles. Raise your hood and tie a white cloth to the radio antenna or hang it out a window so enforcement officers or tow truck operators will know you need help.

Don't stand behind or next to your vehicle. If the car is in the roadway, stand away from the vehicle and wait for help to arrive.

If your car is safely out of traffic, wait inside the vehicle with the doors locked. Use your cellular phone to call for help. If someone stops and offers to help, open the window slightly and ask them to call for assistance.

Watch for a uniformed police officer or other emergency personnel. All interstate highways and major roads are patrolled regularly. Also, some highways have special "call-boxes" for roadside assistance.

It is unadvisable to walk on an interstate, especially during inclement weather. However, if you can reach a source of help on foot without jeopardizing your physical or personal safety, try the direct approach by walking, but keep as far away from traffic as possible.

Carbon Monoxide Poisoning:

Carbon monoxide poisoning can be deadly. Carbon monoxide is gas given off from a vehicle's exhaust system. It can seep into a car if there are holes in the exhaust system. Your car may take in this gas from cars in traffic jams. It may build up when the engine is running in a closed space such as a garage. Because carbon monoxide does not have an odor, you can be affected without knowing it. It can make you sleepy. Early symptoms include: yawning, dizziness and upset stomach. If any of these occur, suspect carbon monoxide poisoning and get fresh air immediately.

DRIVING IN ADVERSE WEATHER

Flooded Roadways

Flooding can occur when streams and rivers flow over their banks, when dams or levees break, when there is run-off from deep snow or any time there is rainfall. Floodwaters can be found on roads, bridges and low areas. Flash floods can come rapidly and unexpectedly. They can occur within a few minutes or hours of excessive rainfall. Be cautious, especially at night, during storm seasons, or any time that flooding is common in your area.

- Do not drive through flooded areas. If you see a flooded roadway ahead, turn around and find another route to get to your destination.
- Remember, 6 inches of water will reach the bottom of most passenger cars, causing loss of control or possible stalling and 2 feet of rushing water can carry away most vehicles.
- Even if the water appears shallow enough to cross, do not attempt to cross a flooded road. Water can hide dips, or worse, floodwaters can damage roadways by washing away the underlying road surface.
- If there is no other route, proceed to higher ground and wait for the waters to subside.



BECOMING SUBMERGED IN WATER

Sometimes the unthinkable does happen. An estimated 400 people die each year when their car becomes submerged in water and they are unable to escape. Whether due to flooding or if you are in a crash and your vehicle enters a pond, lake, river or other body of water you should remain calm and assess the situation.



If your vehicle enters water, it will only float on the surface for 30 to 60 seconds so make every attempt to get out of the vehicle immediately. Do not stay and wait for the car to fill with water. **Immediately** unbuckle your seat belt and roll the window down. Even the electronic windows keep working for some seconds if the key remains in the ignition and the engine is engaged.

Once the window is down, climb on top of the vehicle if the car is not fully submerged. Before trying to swim away, assess the current of the water.

If the vehicle is sinking quickly and you cannot get the door or window open you will have to wait for the pressure to equalize. Take off heavy clothing that will cause you to sink, but keep your shoes on in case you have to kick the window to escape. Kick out a side window. Do not try to break or kick out the windshield. Windshields are now designed with glass that does not shatter. When the water along the window is to your shoulder, try to open the door. If you are able to, there will still be a rush of water coming into the vehicle. Don't panic. Continue to work your way out of the vehicle. If you cannot open the door or window, there will be a small air pocket near the part of the vehicle which is highest in the water. If you can't get a side window open, take a breath and kick the window out or use a tool to break the window. Go to the air pocket for one more breath and then escape.

If there are passengers in the car they may have to escape out the front as some cars have passenger windows that are not designed to roll down completely. If there are children in the car, unbuckle the oldest child first and then the smaller younger ones. The older children should require less assistance to safety than the smaller ones. Don't panic and stay calm.

Memorize this acronym to help you and remember you will have only seconds to save yourself and your passengers.

P – Pop the seat belt open.

O – Open windows by breaking or rolling them down. There are tools designed for this for sale at hardware stores.

G- Get

O –Out. Do not stay in the car and wait for help.

TRAFFIC CRASHES

One in every eight drivers will be involved in a motor vehicle crash this year, according to the National Safety Council.

Collision:

If you are involved in a traffic crash resulting in injury, death or property damage, you are required to:

1. Stop your vehicle immediately if it is clear and safe. Do not leave the scene of the crash without identifying yourself. Have someone warn approaching traffic to prevent further damage. Make sure to turn off the ignitions of the vehicles involved.

2. Make a first aid check of all persons involved in the crash.
Call the police and ask for an ambulance if needed. If in doubt, assume that an ambulance is needed.
3. Gather the names of all persons in the motor vehicles and people who witnessed the crash. Drivers must give their name; address and vehicle license number and if requested, display their driver's license to any person involved in the accident.
4. If you damage an unattended vehicle or property, you must notify the police and attempt to locate the owner. Leave your name, address and telephone number on a note where the owner will be sure to see it.
5. Make a quick diagram of where the vehicle occupants were seated and indicate the vehicle's direction of travel and lane. Also note the date, time and weather conditions.
6. Notify your insurance company as soon as practical. Give complete information about the accident. See your doctor as soon as possible if you are injured.
7. If you are not trained in first aid, remember that there are only a few things that you can do.
8. Summon help. Try to help the injured where they lie in order of their needs. Keep them warm.



To stop bleeding, place a clean cloth over the wound.

- If a person has stopped breathing, give first aid if you know how.
- Do not move the injured person unless there is immediate life threatening danger. Movement could cause more injury.
- Ask a walking injured person to sit or lie down on his back. If the person is bleeding from the lower part of the face or jaw, turn him on his side. Do not give fluids.
- You should not try to take an injured person to the hospital yourself unless there is no other way to get help. With serious injuries, improper movement may be harmful.

Unattended motor vehicles:

Louisiana's "Move It, Move It, Move It - Steer It Clear" campaign is an attempt to make you aware of your responsibility to remove vehicles from the roadway to the nearest soft shoulder. In accordance with Louisiana law, no person driving or in charge of any motor vehicle shall permit it to stand unattended without first stopping the motor, locking the ignition, removing the key, and effectively setting the brake. Removal of vehicles from the roadway will play a great role in reducing traffic congestion and reduce the chances of secondary crashes.

APPROACH OF AN AUTHORIZED EMERGENCY VEHICLE

If you are approached by an authorized emergency vehicle (police car, ambulance, fire truck, etc.) making use of audible or visual signals, you will always yield the right-of-way and immediately drive to a position parallel to the right-hand edge or curb and remain stopped until that vehicle has passed.

When driving on an interstate highway or other highway with two or more lanes traveling in the same direction, yield the right-of-way by making a lane change into a lane not adjacent to the parked vehicle, if possible with due regard to safety and traffic conditions. If a lane change is not possible, the driver shall slow to a reasonably safe speed.

When driving on a two-lane road, maintain a safe speed for road conditions, if unable or unsafe to change lanes, or driving on a two-lane road or highway.

CHAPTER 9

DRIVING OFFENSES

Driving under the influence of alcohol or certain drugs is a crime. According to the National Safety Council, every 33 minutes someone dies in an alcohol-related crash. Drunk driving will cost every adult in this country almost \$500 per year. Drunk driving is the leading single cause of death among young people in the age range from 16 to 24. Statistics indicated that US drivers drank too much and got behind the wheel about 112 million times in 2010.



ALCOHOL

When alcohol enters your stomach, it goes into your bloodstream and to all parts of your body. It reaches your brain in about 20 minutes. In your brain, alcohol affects those parts that control your judgment and skill. Here are some things you should know about alcohol:

- Alcohol is a depressant, not a stimulant. It has anesthetic effects on the brain which “goes to sleep.”
- Alcohol slows normal reflexes, interferes with judgment, reduces alertness and impairs vision. If you feel stimulated after drinking, it is simply because your inhibitions are lowered, causing loss of caution and self-control. In large enough quantities, acute alcohol poisoning can result in a coma or death.
- It doesn't matter whether you drink beer, wine, whiskey or any other alcoholic beverage; it's the amount of alcohol that enters your blood that causes the problem.
- Alcohol can affect you differently at different times. A small amount on an empty stomach will affect you more rapidly than it would if you had recently eaten. Many other factors affect the rate at which alcohol is absorbed into the bloodstream: alcohol content, potency and type of beverage, rate of consumption, gender, physical fitness, emotional state and rate of metabolism and elimination.
- Once the alcohol enters your blood, there is nothing you can do to lessen the effect. Black coffee, exercise or a cold shower will not sober you up. Alcohol is metabolized by your liver and eliminated from your body through your kidneys and lungs. This process takes time.

If you have been drinking alcoholic beverages, you are in no condition to drive. You have placed yourself in a position where you might injure or kill yourself or some innocent person(s).

Remember that alcohol:

- Reduces the ability to judge speeds, distances and angles.
- Encourages the driver to take foolish risks and break laws.
- Impairs concentration. You may forget to fasten a seatbelt, turn on headlights, use turn signals, observe stop signs, etc.
- Slows reaction time in stopping and turning.
- Limits vision; eyes become blurred and can't focus.
- Reduces ability to judge one's own condition.
- Causes sleepiness.
- Increases anger towards other drivers.

If you know someone has been drinking, do not allow them to drive. Even one drink can inhibit response time. The brain is most dramatically affected by alcohol. Initially, you may become more relaxed and less concerned with a minor irritation - one of the positive effects of alcohol for many people. Physically, a feeling of warmth can be caused by the dilation of capillaries beneath the surface of the skin, resulting in a feeling termed "flushed." This is caused by internal heat moving to the surface, but actually, the body's temperature is being lowered. Blood is being transferred from the vital organs to the extremities, which makes alcohol dangerous for a snake bite, shock or overexposure to cold. In hot weather, the result could be a heat stroke.

As the level of intoxication increases, coordination and vision become impaired. The ability to think and learn is altered because of effects on cells in the outer layer of the brain. An unsteadiness or inability to stand or walk can follow. In small amounts, alcohol can have a tranquilizing effect, but in large amounts it can depress the highly-developed brain centers which store learned behavior. The ability to think in relation to the overall picture is reduced. Alcohol can disturb sleep patterns. An alcoholic blackout occurs when information is not stored properly in the brain, causing a complete memory loss the next morning.

BLOOD ALCOHOL CONCENTRATION

What does blood alcohol concentration (BAC) measure? BAC describes the concentration of alcohol in a person's blood expressed as weight per unit of volume. For example, at 0.10% BAC, there is a concentration of 100 mg of alcohol per 100 ml of blood. For most legal purposes, however, a blood sample is not necessary to determine a person's BAC. It can be measured much more simply by analyzing exhaled breath (such as using a breathalyzer). It takes about an hour for the body to get rid of one normal drink from the circulatory system. Therefore, if someone has had four normal drinks, they should wait four hours or more before they drive.

In Louisiana the legal limit of blood alcohol concentration is:

- .04 if you are operating a commercial motor vehicle
- .08 if you are 21 years of age or older
- .02 if you are 20 years of age and younger

The body can process 0.015% of alcohol per hour. If your blood alcohol content (BAC) is 0.20% at 2:00 a.m., it will be more than 0.10% at 8:00 a.m. and still 0.05% at noon the following day!

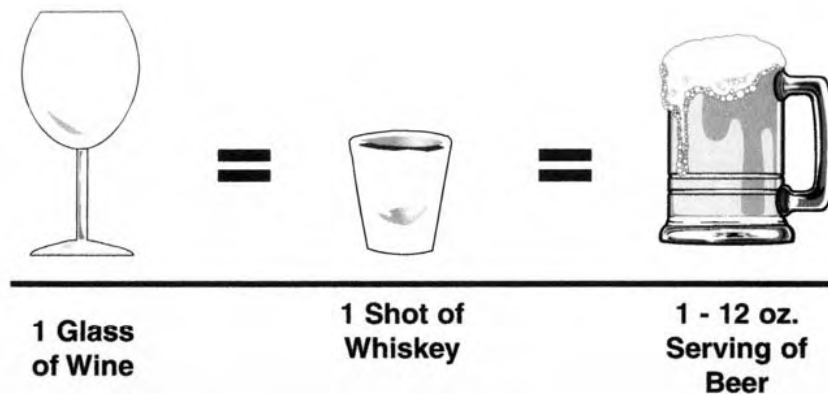

You cannot hide drunk driving. Keep in mind that “sober” means that no alcohol or other impairing drugs are in the circulatory system of the body. Impairment starts with the first drink. Even one drink of alcohol can affect a person’s ability to operate a motor vehicle. With one or more drinks in the bloodstream, a person is visibly impaired and could be arrested for driving under the influence of alcohol or other drugs, a trained police officer will notice a driver who has been drinking. Some tell-tale signs are:

- Speeding - A drinking driver often thinks he can drive safely at high speeds.
- Weaving - Even though a driver may stay in his lane, he may have trouble steering straight.
- Slow driving - A drinking driver may be overly cautious and drive slower than normal traffic.
- Jerking motion - A drinking driver often may have short mental lapses and not keep a steady speed on a clear road.
- Quick stop - A drinking driver may make sudden stops at a traffic sign or light rather than easing up to it.



Louisiana has a law against an open container of alcohol in the vehicle. This law prohibits both the possession of any open alcoholic beverage container and consumption

of any alcohol beverage in a vehicle. Even if you are not consuming alcoholic beverages, the fact that it is the vehicle puts you, the driver, at risk for fines and penalties.

PENALTY FOR DRIVING WHILE INTOXICATED (DWI):

Your first conviction could cost you \$4,500 (court costs, fines, lawyer fees, etc.)

1st DWI conviction - MAXIMUM Penalties

- A criminal record
- Six months in jail
- \$1,000 fine plus court costs
- Loss of driver’s license for 365 days

2nd DWI conviction - MAXIMUM Penalties

- A criminal record
- Six months in jail with 48 hours mandatory jail time
- \$1,000 fine plus court costs
- Loss of driver’s license for two years

3rd DWI conviction - MAXIMUM Penalties (R.S. 14.98)

- A felony criminal record
- 1-5 years in prison with 30 days mandatory jail time
- \$2,000 fine plus court costs
- Loss of driver’s license for three years
- Vehicle may be seized and sold
- Six weeks inpatient and 12 months outpatient substance abuse treatment
- Home incarceration for remainder of sentence

4th DWI conviction - MAXIMUM Penalties (R.S. 14:98)

- A felony criminal record
- 30 years in prison with 30 days mandatory jail time
- \$5,000 fine plus court costs
- Loss of driver’s license for three years

- Auto may be seized and sold
- Six weeks inpatient and 12 months outpatient substance abuse treatment
- Five years home incarceration

NOTE: With a felony record, you can't vote. You may be restricted from pursuing a career in the military, dentistry, engineering, insurance, law, medicine, and public accounting. Some insurance companies will not sell you auto insurance.

In addition to the penalties listed, proof of future financial responsibility must be filed and maintained for three years from the date of conviction. The court also has the authority to require participation in community service work, driver improvement programs, and substance abuse treatment - all at your expense.

If you are driving while intoxicated and cause a crash which results in the death of another person, your conviction can result in a jail term of up to 30 years. You'll lose your driver's license, a great deal of money, and the privileges of citizenship. You'll face being sued by the deceased person's relatives for amounts that could easily exceed your insurance coverage. Most importantly, you'll have to live the rest of your life knowing that you killed another human being.

If you see a drunk driver you should:

- ✓ Stay as far away from the other vehicle as possible.
- ✓ Do not signal the driver to pull over. This may result in a collision.
- ✓ Make a note of the license plate number and the details of the vehicle. Do not compromise your safety while trying to obtain this information.
- ✓ Pull over and call 911. Give a complete description of the vehicle and its' exact location. Then leave the rest to the police and let them do their work.

DRUGS

Driving while/or after using drugs (e.g., amphetamines, tranquilizers and barbiturates) can be hazardous (and possibly lethal) because of drowsiness, reduced coordination and poor judgment or risk taking. It can take hours to wear off, and if the drugs are combined with alcohol, the effects can be exaggerated and increased dramatically. Louisiana law provides the same penalty for driving under the influence of drugs as it does for alcohol. This includes over-the-counter (OTC) and prescribed medication. It is important to pay attention to the labels on medications as they may interfere with your driving ability.

MARIJUANA

Whereas the effects of a single drink will diminish over an hour, it takes five to six hours for the effects of smoking one marijuana cigarette to wear off, making the combination of marijuana and alcohol especially dangerous. It can affect your eyesight, and with some users, marijuana interferes with the ability to judge time, speed and distance. Marijuana use can cause increased heart rate and make some user paranoid and anxious. In young people, it impairs the ability to concentrate and retain information. Short term effects of marijuana use are the interference with memory and learning. It can make the simplest task seem hopelessly confusing.

VEHICULAR HOMICIDE

Under R.S. 14:32.1, vehicular homicide is the fatal injury of a human by an operator of any motor vehicle, aircraft, watercraft, or other means of conveyance, whether or not there is any intent to cause death or great bodily harm. Penalties include fines of not less than \$2,000 nor more than \$15,000 and imprisonment for not less than five years or more than 30 years. At least one year jail time will be mandatory.

VEHICLE NEGLIGENT INJURY

Under R.S. 14:39.1, vehicle negligent injury is inflicting any injury by an operator of any motor vehicle, aircraft, water-craft, or other means of conveyance when the offender is under the influence of alcohol or drugs and/or the offender's blood alcohol concentration is 0.08% or more. Penalties include fines of not more than \$1,000 or imprisonment for not more than six months, or both.

FIRST DEGREE VEHICLE NEGLIGENT INJURY

Under R.S. 14:39.2, first degree vehicle negligent injury is inflicting of serious bodily injury by an operator of any motor vehicle, aircraft, water-craft, or other means of conveyance when the offender is under the influence of alcohol or drugs and/or the offender's blood alcohol concentration is 0.08% or more.

Penalties include fines of not more than \$2,000 or imprisonment for not more than five years, or both.

RECKLESS DRIVING

If you operate a vehicle in a criminally negligent or reckless manner, you are committing a crime punishable by a fine and jail.

HIT AND RUN DRIVING

If you are involved in or cause an accident, you are required by law to stop, identify yourself and render reasonable aid. Failure to do so may result in a fine and time in jail.

FLIGHT FROM AN OFFICER

A motor vehicle driver, who refuses to stop, knowing a law enforcement officer has given a signal for him to stop, has committed a crime punishable by a fine and time in jail.

ADMINISTRATIVE PER SE (SUBMIT OR REFUSE ALCOHOL ANALYSIS TEST)

Louisiana law states that when you drive a motor vehicle upon the highways of this state, you are deemed to have given your consent to a test for the purpose of determining the alcoholic content of your blood and the presence of any abused or illegal controlled dangerous substance. This is known as implied consent. You may be asked to perform a field sobriety test or consent to a blood, urine, or breathe test to determine your blood-alcohol level. The test will be administered at the discretion of a law enforcement officer who has reason to believe you were driving under the influence of alcohol or drugs. At the time, the officer will advise you of both your criminal and civil rights as they relate to your arrest and to the chemical test.

If you refuse to submit to the test, your driving privileges will be suspended for 365 days on your first offense. If it is a second or subsequent offense, your driving privileges will be suspended for 730 days. In addition, before you can have your driving privileges reinstated, you must file proof of future financial responsibility by submitting an SR-22, which is high risk insurance, or \$30,000.00 in cash or security. You will be required by law to maintain an SR-22 for three (3) years from the date of conviction.

If you submit to the test and you are 21 years of age or older, and the test results show a BAC level of 0.08% to 0.19%, your driving privileges will be suspended for 90 days. If your BAC level is 0.20% or greater, your driving privileges will be suspended for two (2) years. If you submit to the test and you are under 21 years of age, and the test results show a BAC level of 0.02% or more, your driving privileges will be suspended for 180 days. These are the specified penalties for first offense. If it is a second or subsequent offense, your driving privileges will be suspended for 365 days.

LOSING YOUR DRIVING PRIVILEGES

The following is a list of various violations for which your driving privileges will be suspended:

- Conviction of driving while intoxicated (DWI).
- Failure to stop for a school bus loading or unloading children.
- Manslaughter or negligent homicide resulting from the operation of a motor vehicle.
- Any felony committed while operating a motor vehicle.
- Failure to stop and render assistance at an accident, in which you were involved, that results in the injury or death of a person.
- Three convictions of reckless driving committed within a 12 month period.
- Unlawful use of a driver's license.
- Making a false statement or concealing a material fact on an application for a driver's license.
- Failure to answer a traffic law charge.
- Driving in violation of a driver's license restriction.
- Refusal to take alcohol analysis test when arrested for DWI, or after submitting to the test where the results show a BAC level of 0.08% or more for those 21 years of age or older or 0.02 % or more for those younger than 21 years of age.
- Failure to comply with the financial responsibility law when required.
- Committing an offense in another state which, if committed in this state, would be grounds for suspension or revocation.
- Altering information on the license.
- Driving with a suspended driver's license.
- Text messaging while operating a motor vehicle.
- Using a wireless/cellular communication device while operating a school bus.
- Using a wireless/cellular communication device while operating a motor vehicle if the driver holds a Class 'E' learners or intermediate operator's license, or is under the age of 18, or has been issued a first time operator's license that is within one year from the original issue date, excluding out-of-state transfers.

The surrender of an individual's actual driver's license will not be required to begin the period of suspension and/or disqualification. The suspension and/or disqualification dates can be given upon receipt of the individual's most current operator's license (in-state or out-of-state), upon expiration of the operator's license, on the date a statement of non-possession is received, after the expiration date of the prior suspension or disqualification, or 30 days after the date of the notice of suspension, depending upon the individual record.

EACH conviction of driving under suspension will cause your suspension period to be extended for one year. Driving while your license is suspended will be cause for arrest, a court fine and/or time in jail. Upon expiration of any suspension period, a reinstatement fee will be required before your driving privileges can be reinstated.

CHAPTER 10

GENERAL INFORMATION FOR CLASS D “CHAUFFEUR’S” LICENSE

Class “D” Chauffeur’s Driver’s License permits the operation of any single vehicle used in commerce if the vehicle has a gross vehicle weight rating of 10,001 or more pounds but less than 26,001, or any combination of vehicles if the vehicles have a combined gross weight rating of 10,001, or more pounds but less than 26,001 pounds inclusive of a towed unit with a gross vehicle weight rating of more than 10,000 pounds and not utilized in the transportation of hazardous materials. A class “D” license may be used for transportation of passengers for hire or fee provided the usage thereof does not fall within the definition of vehicles in classes “A”, “B”, or “C”. A class “D” license allows for operation of those vehicles in the class “E” category. You must be at least 17 years of age to obtain a Class “D” license.

VEHICLE SIZE

Maximum width:

- 8 feet for most vehicles. The load will not project more than 6 inches beyond the width of the body.
- 8 feet 6 inches for buses.

Maximum height:

- 13 feet 6 inches for all vehicles. (Some overpasses or other structures have clearance of less than 13’6”.)

Maximum length:

- 40 feet for any single vehicle (including the load).
- 65 feet for truck-tractor and trailer combination
-

These limits do not apply to auto carriers, trailers hauling poles or pilings, or trailers hauling logs when operating during daylight hours.

LOADS

Securing loads:

- Contents must not be allowed to drop, shift, leak or otherwise escape.
- The load must be securely fastened so the covering or load does not come loose, or in any manner become a hazard to other motorists.

A load must not extend more than 4 feet to the front of the vehicle or more than 8 feet beyond the rear of the vehicle except poles, pilings and logs may project 15 feet beyond the rearmost part of the trailer. If a load extends four or more feet past the bed or body of any vehicle, a red flag 12 inches square must be attached to the extreme rear of the load during daylight hours. The entire area of the flag must be visible. At night, a red light must be attached to the extreme rear of the load and visible for at least 500 feet to the sides and rear.

DRIVING

Maximum speed for any vehicle in Louisiana is 70 mph except:

- When pulling or towing another motor vehicle the speed limit is 45 mph.
- School buses are limited to 35 mph when frequently stopping to load or unload children.
- Where a lower speed limit is posted.

- On portions of I-49, the speed limit is 75

FOLLOWING DISTANCE

On rural highways, outside residential areas or business districts, drivers of motor trucks must not follow within 400 feet of one another except to pass.

Also, high beam headlights must be dimmed no less than 500 feet from oncoming traffic and 200 feet of a vehicle being followed.

COASTING

You must not let your vehicle coast downhill with the clutch disengaged or the gear in neutral.

RAILROAD STOPS

You must stop within 50 feet but not closer than 15 feet from the nearest rail. You may not change gears until you have completely crossed over the tracks. This does apply to street-rail crossings within a business or residential district.

EQUIPMENT

Fire Extinguisher: Vehicles transporting passengers for hire must be equipped with at least a type 2-BC fire extinguisher, completely filled and in working condition.

Tow trucks must be equipped with at least one 4-BC fire extinguisher capable of extinguishing flammable liquid fires, completely filled and in working condition.

Motor vehicles transporting explosives must be equipped with at least one fire extinguisher with a rating of at least 10-BC, completely filled and in working condition.

Fenders and Mudguards: Every truck must have a device ("mud flap") to minimize the spray or splash of water or mud or loose road surface material to the rear.

Warning equipment: Freight carrying vehicles and passenger buses must carry:

- Three (3) flares, three (3) electric red lanterns OR three (3) red portable reflectors.
- Two (2) 12-inch square red cloth flags with standards.

Trucks carrying explosives, flammable liquids, compressed gases, or using compressed gas as a fuel must use red electric lanterns or red emergency reflectors only. Flares or fuses are not allowed. This equipment must be used immediately any time the vehicle breaks down. One signal must be placed 100 feet behind the vehicle and 100 feet forward of the vehicle. Each of these signals must be in the center of the lane or shoulder. A third signal must be on the traffic side of the truck 10 feet to the front or rear.

TRAILERS AND TOWED VEHICLES

When towing another vehicle, the draw bar or other connection must of sufficient strength to pull all towed weight and must not exceed 15 feet. Exception: Distance can exceed 15 feet when transporting poles, pipes, machinery or other objects which cannot be readily dismembered.

MIRRORS

A rear view mirror must reflect a view of the highway for a distance of 200 feet to the rear, regardless of the load of the vehicle.

LIGHTS

Any motor vehicle shall not be driven when any of the required lamps or reflectors is obscured by the tailboard, by any part of the load, by dirt or otherwise.

BRAKES

All trailers or semi-trailers with a gross vehicle weight rating of 3,000 pounds or more must be equipped with brakes adequate to stop and hold it.

Care should be used to avoid excessive use of brakes on long downgrades. Drivers should use engine compression as the principal means of controlling speed on long grades. If your brakes should fail on a level road, you should downshift and use engine compression to slow down.

AIR BRAKES

Air brakes use compressed air to make the brakes work. You can apply all the braking force you need to each of the wheels of a heavy vehicle. Air brakes are a safe way of stopping large vehicles if the brakes are well maintained and used properly. Air brake systems are three braking systems combined: the service brake system, the parking brake system, and the emergency brake system.

- The service brake system applies and releases the brakes when you use the brake pedal during normal driving.
- The parking brake system applies and releases the parking brakes when you use the parking brake control.
- The emergency brake system uses part of the service and parking brake's system to stop the vehicle in the event of a brake system failure.

PARTS OF AN AIR BRAKE SYSTEM

Air Compressor: Pumps air into the air storage tanks (reservoirs).

Air Compressor Governor: Controls when the air compressor will pump air into the air storage tanks.

Air Storage Tanks: Used to hold compressed air.

Air Tank Drains (two types):

1. Manual - operated by turning a quarter turn or by pulling a cable. You must drain the tanks yourself at the end of each day of driving.
2. Automatic - the water and oil is automatically expelled. They may be equipped for manual draining as well.

Safety Valve: Protects the tank and the rest of the system from too much pressure. The valve is usually set to open at 150 psi. If the safety valve releases air, something is wrong.

Brake Pedal: You put on the brakes by pushing down the brake pedal. Pushing the pedal down harder applies more air pressure. Letting up on the brake pedal reduces the air pressure and releases the brakes. Pressing and releasing the pedal unnecessarily can let air out faster than the compressor can replace it. If the pressure gets too low the brakes won't work.

Supply Pressure Gauges: All vehicles equipped with air brakes have a pressure gauge connected to the air tank. These gauges tell you how much pressure is in the air tanks.

Application Pressure Gauge: This gauge shows how much air pressure you are applying to the brakes. (This gauge is not on all vehicles.)

Low Air Pressure Warning: A low air pressure warning signal is required on vehicles with air brakes. A warning signal you can see must come on before the air pressure in the tanks falls below 60 psi. (Or one half the compressor governor cutout pressure on older vehicles). The warning is usually a visible red light. A buzzer may also come on.

Spring Brakes: All trucks must be equipped with emergency brakes and parking brakes. They must be held on by mechanical force. Spring brakes are usually used to meet these needs. When driving, powerful springs are held back by air pressure. If the air pressure is removed, the springs put on the brakes.

Parking Brake Controls: In newer vehicles with air brakes, you engage the parking brakes using a **diamond shaped, yellow, push-pull control knob**. You pull the knob out to put the parking brakes (spring brakes) on, and push it in to release them. On older vehicles, the parking brakes may be controlled by a lever. Use the parking brakes whenever you park. **NEVER PUSH THE BRAKE PEDAL DOWN WHEN THE SPRING BRAKES ARE ON.** If you do, the brakes could be damaged.

INSPECTING THE AIR BRAKE SYSTEM

The following three part air brake check must be performed:

Step 1: With the engine running, build the air pressure to governed cut-out (100-125 psi). Shut off the engine, chock your wheels, if necessary, release the tractor protection valve and/or parking brake (push in), fully apply the foot brake and hold it for one minute. Check the air gauge to see if the air pressure drops more than three (3) pounds in one minute (single vehicle).

Step 2: Turn the key to the “on” position (without starting the engine). Begin fanning off the air pressure by rapidly applying and releasing the foot brake. Low air warning devices (buzzer, light, and flag) should activate before air pressure drops below 60 psi.

Step 3: Continue to fan off the air pressure. At approximately 20-40 psi, the parking brake valve should close (pop out).

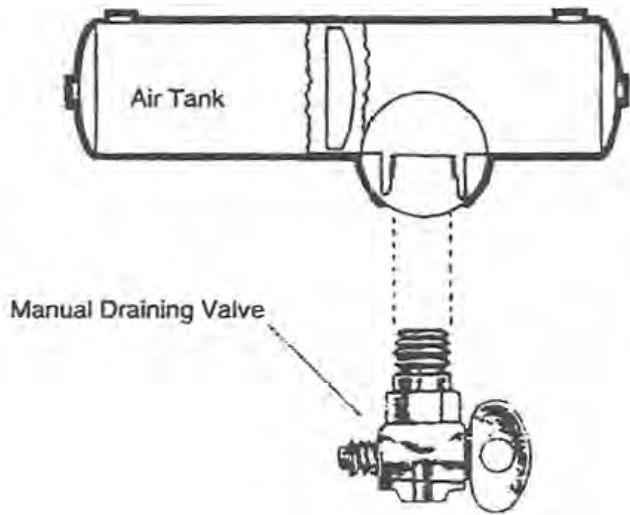

In addition to the three part air brake check, the following items must be inspected prior to operating a vehicle equipped with air brakes:

- Air compressor drive belt (if compressor is belt driven)
- Manual slack adjusters on S-cam brakes
- Brake drums (or discs), linings, and hoses
- Rate of air pressure buildup (with engine at operating RPM, the pressure should build from 85 to 100 psi within 45 seconds or manufacturer's specifications)
- Air compressor governor cut-in and cut-out pressures
- Test parking brake
- Test service brakes

USING THE AIR BRAKES

Emergency Stops: You should brake so you can steer and so your vehicle stays in a straight line. Use one of the following two methods:

1. Controlled braking - Put on the brakes as hard as you can **without** locking the wheels (do not turn the steering wheel while doing this).

2. Stab braking - a) Press the brake pedal as hard as you can. b) Release the brakes when the wheels lock up. c) As soon as the wheels start rolling, put on the brakes fully again.

Stopping Distance: With hydraulic brakes (used on cars and light/medium trucks), the brakes work instantly. With air brakes, it takes a little time (one half second or more) for the air to flow through the lines to the brakes. Thus, the total stopping distance for vehicles with air brake systems is made up of **four** different factors.

Perception Distance
+ Reaction Distance
+ Brake Lag Distance
+ Effective Braking Distance
= Total Stopping Distance

Example: The air brake lag distance at 55 mph on dry pavement adds about 32 feet. So at 55mph for an average driver under **good** traction and a brake condition, the total stopping distance is over 300 feet. This is longer than a football field.

Low Air Pressure Warning: If the low air pressure warning comes on, **stop and safely park your vehicle as soon as possible.**

Brake Fading or Failure: Brakes can fade or fail from excessive heat caused by using them too much and not relying on the engine braking effect or improper adjustment.

Parking Brakes: Any time you park, use the parking brakes unless:

1. The brakes are very hot (from having come down a steep grade).
2. The brakes are very wet in freezing temperatures.

Note: For more complete and detailed information about air brakes, please refer to the Louisiana Driver's Manual for Commercial Vehicle Driver Licensing.



CHAPTER 10–A

TRAILER SAFETY

Most SUVs, pickup trucks, vans, minivans, and passenger cars can be equipped to tow a trailer. Check the vehicle's owner's manual to ensure your vehicle is properly equipped to tow your trailer.



Hitching Systems

The most common type of hitch is the ball and coupler. It is important to make sure that the size of the ball and coupler match to prevent separation of the towed vehicle during transport.

Make sure the hitch has provisions for the connection of safety chains or other approved safety devices. The safety chains or other approved safety device shall be securely attached your vehicle and shall be of sufficient strength to hold the trailer behind your vehicle in case the connection between the two vehicles detaches. When connected, safety chains should have some slack to permit sharp turns but should not drag on the road. In addition, they should cross under the trailer tongue to help prevent the tongue from dropping to the road in the event the trailer separates from your vehicle.

Braking Systems

All trailers with a gross weight of 3,000 pounds or more are required to be equipped with brakes. Brakes shall be designed to be applied by the driver of the towing motor vehicle from its cab, and said brakes shall be so designed and connected that in case of an accidental breakaway of the towed vehicle the brakes shall be automatically applied.

Lighting

Trailers are required to have taillights, brake lights, side marker lights, turn signals, and side and rear reflectors. You must ensure that the electrical connector on your vehicle matches the electrical connector of the trailer. Be sure to check the electrical connection between your vehicle and the

trailer to ensure it is not dragging the ground and has enough slack to allow for sharp turns. Always make sure the lights on your trailer are functioning properly before towing.

Tires

All your trailer tires should be the same type, size, and construction; do not mix bias-belted and radial tires. In selecting tires for your trailer, buy the size, type, and load range found on the trailer's certification label or in the owner's manual. Keep in mind that tires have a load rating that indicates the amount of weight they can carry safely. As with your vehicle, always maintain proper tire pressure and replace worn tires. Remember, your vehicle's tires may require a higher tire pressure for towing, especially heavy loads.

Loading and Weight Distribution

Your ability to handle and control your vehicle and trailer is greatly improved when the cargo is properly loaded and distributed. Refer to your vehicle and trailer owner's manual to find out how to:

- Balance weight from side to side
- Distribute cargo weight evenly along the length of the trailer
- Secure and brace all items to prevent them from moving or fall off during travel
- Adjust the height of the tow vehicle/trailer connection
- Apply load leveling (weight distributing hitch bars)



CHAPTER 11

MOTOR VEHICLE REGISTRATION AND TITLE

Louisiana law requires that motor vehicles be titled and registered. You can apply for the title, registration and license plate at any Motor Vehicle Office or a licensed Public Tag Agent. Services provided by Public Tag Agents (PTA) are subject to additional fees. Public Tag Agents are located in the links section on our website at www.expresslane.org.



NEW VEHICLES

When you buy a new vehicle from a Louisiana dealer, the dealer will provide an assigned Certificate of Origin and notarized invoice. In most cases, the dealer will collect the taxes and fees and submit them with the proper documents to obtain your title and license. The dealer will issue a 60-day temporary cardboard plate which must be clearly visible from the rear of your car.

USED VEHICLES

If you buy a used vehicle, the certificate of title must be assigned to you by the previous owner or dealer. The seller is required by law to deliver a properly assigned certificate of title to the buyer at the time of sale or delivery of the vehicle. If a lien is shown on the certificate of title, be certain that it has been released by an authorized agent of the lien holder.

You have five days from the date of sale to apply for a title in your name. You need to present the following:

- Previous owner's title assigned to you and notarized.
- Notarized bill of sale. If the title has a place to enter the selling price of the vehicle, a separate bill of sale is not required.
- A declaration of liability insurance.
- Sales tax, title and license transfer fees.
- Federal Odometer statement, if vehicle is less than 10 years old (required by Federal Government).
 - Note: Most titles have the odometer statement incorporated in the assignment of the title.
- Mortgage document, if applicable.

REGISTRATION CERTIFICATE

You will receive a registration certificate along with your license plate. This registration is proof of ownership of the vehicle. It must be kept in the vehicle at all times and must be presented when requested by law enforcement. If your registration is lost, a duplicate registration can be purchased at any Motor Vehicle Office or any public tag agent.

NEW RESIDENTS

If you are a new Louisiana resident, you must transfer the title and registration for any vehicles brought with you during the move.

You can register your vehicle at the local Motor Vehicle Office or public tag agent. Bring your out-of-state title and registration certificate and proof of insurance. If your title is held by an out-of-state lien holder, a photocopy of the title must be presented.

Fees to transfer your vehicle to Louisiana are based on the current book value of the vehicle. Bring your tax receipt or other documentation showing the out-of-state taxes paid.

Credit is allowed for the percentage of taxes paid to other states which allow similar credit to Louisiana. Louisiana state tax is 4%. City and parish tax rates vary.

CHANGE OF ADDRESS

Louisiana law requires you to correct the address on your registration within 10 days after a move. Visit your local motor vehicle office to have the corrected registration issued at no charge. In order to receive an updated copy, you must bring your previous registration of all vehicles with you. Failure to change your address may result in non-receipt of your renewal invitation, as well as, a violation ticket, if you are stopped by law enforcement.

PROOF OF INSURANCE

Any vehicle used upon the highways of Louisiana must be insured. When you apply for a license plate, you must have proof of the required liability insurance or other allowable substitute.

Louisiana has implied consent laws. A part of these laws is that proof of insurance must be maintained in the vehicle when the vehicle is operational and must be presented any time a law enforcement officer requests that proof be provided

If you are stopped by a law enforcement officer and you are unable to provide the proof of insurance, the vehicle's license plate will be seized and the vehicle may be impounded. You will have three (3) calendar days, excluding Saturdays, Sundays and legal holidays, to provide the proof at a Motor Vehicle office.

The office location at which you may retrieve your seized license plate will be identified on the notice of violation issued to you by the law enforcement officer. If you do not provide the office with proof of insurance within a three (3) calendar day period, your license plate will be destroyed and you will be required to pay all necessary fees to have your vehicle re-registered.

If you provide false information about your insurance coverage, your vehicle registration may be suspended. You may also be fined by the court and jailed.

If you decide to no longer drive a vehicle on the highways, you should remove the license plate and surrender it to the Office of Motor Vehicles before the insurance is canceled. Penalties will be assessed if the license plate is not surrendered **prior** to the insurance cancellation.

RENEWALS

Your vehicle license plate expires on the last day of the month in the year indicated on your registration certificate. You may renew your license plate in person 60 days prior to the expiration date.

Registration renewal applications are mailed to your last recorded address. You can mail your renewal application and avoid waiting in line. Make your check or money order payable to the Department of Public Safety for the amount shown and mail it in with your renewal form.

You may be eligible to renew your registration by internet or phone. If you are eligible, instructions will be printed on the renewal invitation.

Any errors you find on the application or any change of an address should be reported to the Office of Motor Vehicles.

Renewal notices are sent out as a courtesy. It is the owner's responsibility to maintain current registration.

MOTOR VEHICLE INSPECTION STICKER

Every automobile, truck, trailer, boat trailer and motorcycle operated on the highways of this state must have a current motor vehicle inspection sticker. Authorized motor vehicle inspection stations display an orange colored sign with the words - "LOUISIANA MOTOR VEHICLE INSPECTION STATION".

The City of New Orleans, the City of Kenner and the City of Westwego operate their own inspection program. If you are a resident in one of these areas, you must obtain an inspection sticker from that city.

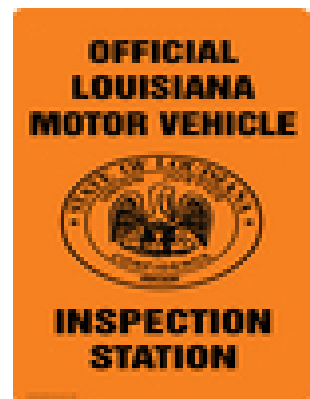

FEES

Automobile license plates are based on one percent of the original selling price of the vehicle. Vehicles with a value of \$10,000 or less are \$10.00 a year. Automobile plates are issued for a 2-year period.

The license plate fee for private minimum-use pickup trucks (6000 lbs. or less) is \$10.00 per year. Truck plates are issued for a 4-year period. Larger trucks (over 6001 lbs.) are based on the weight.

For specific fee information on commercial vehicles, motorcycles, special license plates, license plate transfers, etc., contact your local Office of Motor Vehicles or visit our web-site at www.expresslane.org.

The fee to issue a title is \$18.50. Most transactions are subject to a handling fee of \$8.00. Some offices have an additional service fee ranging from \$2.00 to \$3.00.

VISIT OUR WEB SITES

Louisiana Department of Public Safety

www.dps.la.gov

Office of Motor Vehicles

www.expresslane.org
1-225-925-6146