

WIR-3110



DIALOG®

IR Setting Unit User Manual

Contents

Infrared Setting Unit

Description and Function of IR Setting Unit	3
Description and Function of LCD	4
Setting a Switch	5
Setting a Dimmer Switch	6
Setting a 8-Contact Input Unit	7
Setting a Occupany Sensor	9
Setting a Photo Sensor	10

Description & Function

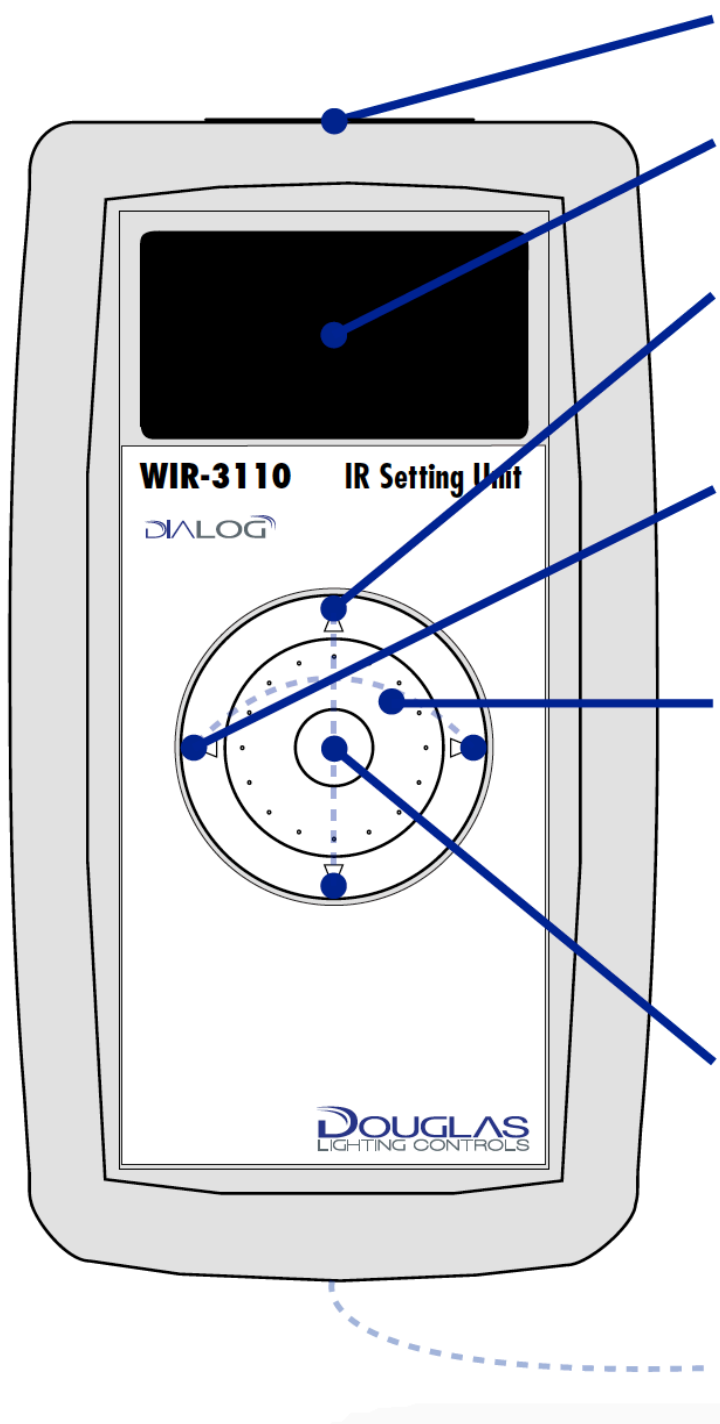

Infrared Receptor

Liquid Crystal Display Panel (LCD)

UP / DOWN Buttons

Toggles Up or Down through option fields

LEFT / RIGHT Buttons

Selects the input component number to be programmed (Left for previous, Right for next)

Scroll Wheel

Scrolls through all options associated with a particular field (clockwise forward, counter-clockwise backward)

Center Wheel

Sets and enters the field highlighted by the cursor

Power Supply

2 AA standard alkaline or rechargeable NiMH batteries

Description & Function

Liquid Crystal Display Panel (LCD)

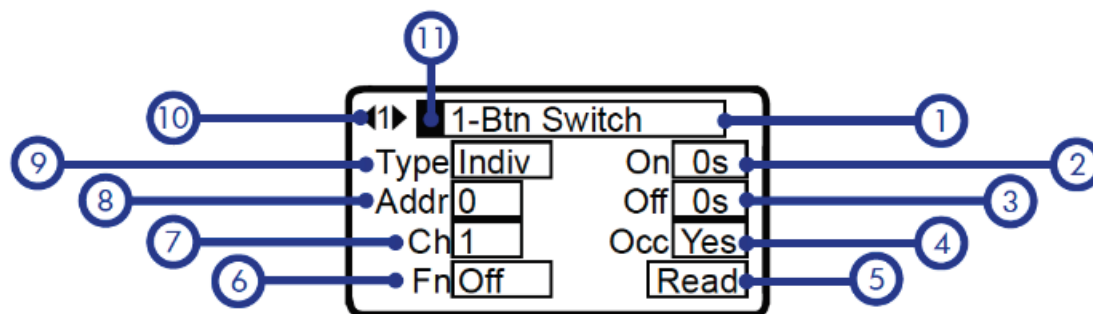

1. Device Name

The device that you are programming. Available devices are: 1-4 Button Switch, 8 Button Switch, Dimmer Switch, 8-Contact Input, Key Switch, PIR Occupancy Sensor and Photo Sensor.

2. Delay ON Time

Number of seconds an ON command is delayed after being activated. Minimum 0 Seconds - Maximum 40 minutes.

When 'Occupancy PIR' is the device selected, this field will indicate the level of sensitivity to apply (from 0-10).

3. Delay OFF Time

Number of seconds an OFF command is delayed after being activated. Minimum 0 Seconds - Maximum 40 minutes.

4. Occupancy

Indicates whether occupancy sensor connected will use default manufacturer settings for time delay (NO) or time delay as set by the IR Setting Unit (YES) *for 8-Contact Input Unit only*.

5. Action

The action to be performed by the IR Setting Unit. READ (Reads current settings from a particular device), WRITE (Writes the current settings on the LCD screen to a particular device), CLEAR (Clears all settings associated with a device), OFF (Turns the IR Setting Unit Off).

6. Function of Selected Device

Sets a switch's function. Options are: ON only, OFF only, Toggle (ON and OFF), Dim Up, Dim Down. Sets the Contact Input Units function to correspond to the Contact-type that is connected to its terminals.

7. Channel Number

Output channel to be programmed.

8. Address

Sets the Address for the device being programmed.

9. Input Type

Input to target: Individual, Group, Local Preset, Global Preset, Individual Dim, Group Dim.

10. Input Component Number

The input component of a device being programmed (multiple button switch or 8-Contact Input Unit).

11. Cursor

Indicates a selected item.

Setting a Switch

Setting a Switch

Step 1 - Switch Configuration

Using the UP/DOWN buttons, move the cursor until it highlights the '#-Button Switch' field. Select the switch configuration that matches the switch that you are programming by rotating the scroll wheel clockwise or counterclockwise. **Instructions apply for a Key Switch as well*

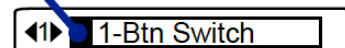

Step 2 - Input Type

Using the UP/DOWN buttons, move the cursor until it highlights the 'Type' field. Select the switch input type to apply to the switch that you are programming by rotating the scroll wheel clockwise or counterclockwise.

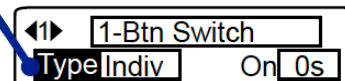

Step 3 - Assigning an Address

Using the UP/DOWN buttons, move the cursor until it highlights the 'Addr' field. Select the address you wish to assign the switch by rotating the scroll wheel clockwise or counterclockwise.

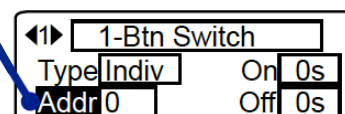

Step 4 - Assigning an Output Channel

Using the UP/DOWN buttons, move the cursor until it highlights the 'Addr' field. Select the address you wish to assign the switch by rotating the scroll wheel clockwise or counterclockwise.

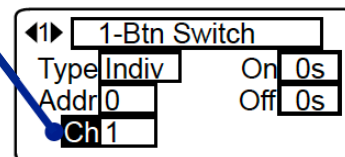

Step 5 - Assigning a Function

Using the UP/DOWN buttons, move the cursor until it highlights the 'Fn' field. Select the function you wish to assign the switch by rotating the scroll wheel clockwise or counterclockwise.

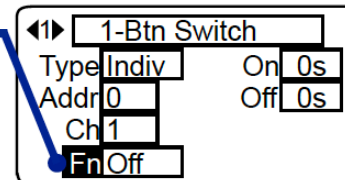

Step 6 - Delay ON

Using the UP/DOWN buttons, move the cursor until it highlights the 'On' field. Select the amount of time you wish to delay an ON command after it is initiated. The time can be adjusted from 0 seconds to 40 minutes by rotating the scroll wheel clockwise.

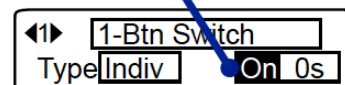

Step 7 - Delay OFF

Using the UP/DOWN buttons, move the cursor until it highlights the 'Off' field. Select the amount of time you wish to delay an OFF command after it is initiated. The time can be adjusted from 0 seconds to 40 minutes by rotating the scroll wheel clockwise or counterclockwise.

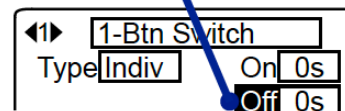

Step 8 - Writing Programming to a Switch

Using the UP/DOWN buttons, move the cursor until it highlights the bottom right field. Rotate the center scroll wheel until 'Write' is highlighted. Point the Infrared transmitter approximately 0.5" away from the IR lens of the switch being programmed and press the center button of the IR Setting Unit. You will hear a single solid beep sound indicating that the switch was successfully programmed.

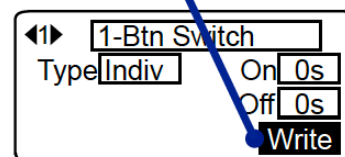

Setting a Dimmer Switch

Setting a Dimmer Switch

Step 1 - Switch Configuration

Using the UP/DOWN buttons, move the cursor until it highlights the 'Dimmer Switch' field.

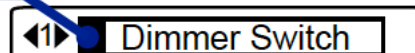

Step 2 - Dimming Type

Using the UP/DOWN buttons, move the cursor until it highlights the 'Type' field. Select the dimming type (Dim an individual output channel or Dim a group) to apply to the switch that you are programming by rotating the scroll wheel clockwise or counterclockwise.

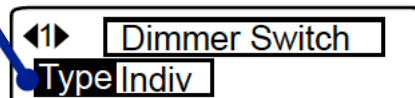

Step 3 - Assigning an Address

Using the UP/DOWN buttons, move the cursor until it highlights the 'Addr' field. Select the address you wish to assign the switch by rotating the scroll wheel clockwise or counterclockwise.

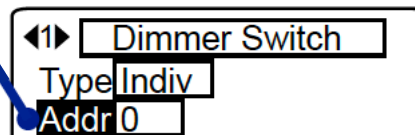

Step 4 - Assigning an Output Channel

**Applicable only when programming an individual dimmer*

Using the UP/DOWN buttons, move the cursor until it highlights the 'Ch' field. Select the output channel you wish to assign the switch by rotating the scroll wheel clockwise or counterclockwise.

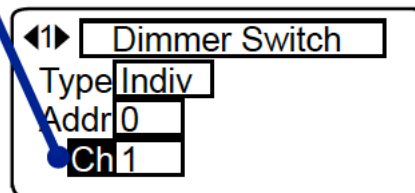

Step 5 - Writing Programming to a Switch

Using the UP/DOWN buttons, move the cursor until it highlights the bottom right field. Rotate the center scroll wheel until 'Write' is highlighted. Point the Infrared transmitter approximately 0.5" away from the IR lens of the switch being programmed and press the center button of the IR Setting Unit. You will hear a single solid beep sound indicating that the switch was successfully programmed.

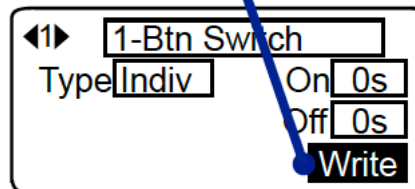

Setting a 8-Contact Input Unit

Setting a 8-Contact Input Unit

Step 1 - Selecting a 8-Contact Input Unit

Using the UP/DOWN buttons, move the cursor until it highlights the '8-Contact Input' field. Select the 8-Contact Input Unit from the list of options by rotating the scroll wheel clockwise or counterclockwise.

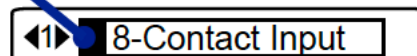

Step 2 - Input Type

Using the UP/DOWN buttons, move the cursor until it highlights the 'Type' field. Select the input type to apply to the Contact Input Unit that you are programming by rotating the scroll wheel clockwise or counterclockwise.

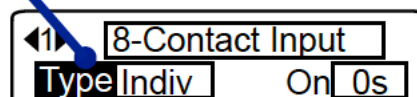

Step 3 - Assigning an Address

Using the UP/DOWN buttons, move the cursor until it highlights the 'Addr' field. Select the address you wish to assign the Contact Input Unit by rotating the scroll wheel clockwise or counterclockwise.

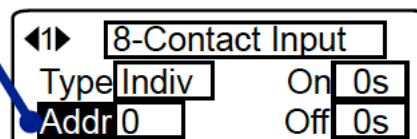

Step 4 - Assigning an Output Channel

Using the UP/DOWN buttons, move the cursor until it highlights the 'Ch' field. Select the output channel you wish to assign the Contact Input Unit by rotating the scroll wheel clockwise or counterclockwise.

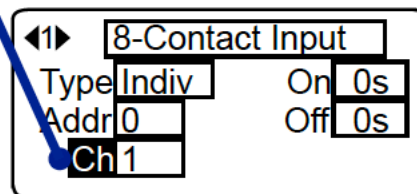

Step 5 - Assigning a Function

Using the UP/DOWN buttons, move the cursor until it highlights the 'Fn' field. Select the function you wish to assign the Contact Input Unit by rotating the scroll wheel clockwise or counterclockwise.

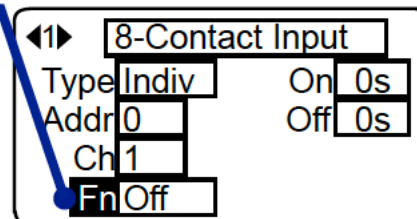

Available functions are:

Fn•NA°On	AC Maintained Contact - Closed = No Action Open = ON	Fn•DimUp	AC Maintained Contact - Closed = Dim Up
Fn•NA°Of	AC Maintained Contact - Closed = No Action Open = OFF	Fn°DimDn	AC Maintained Contact - Open = Down Down
Fn•DimDn	AC Maintained Contact - Closed = Dim Down	Fn°DimUp	AC Maintained Contact - Open = Dim Up
Fn•On°Of	AC Maintained Contact - Closed = ON Open = OFF	FnMomOff	AC Momentary Contact - OFF when switched
Fn•On°NA	AC Maintained Contact - Closed = ON Open = No Action	FnMomOn	AC Momentary Contact - ON when switched
Fn•Of°On	AC Maintained Contact - Closed = OFF Open = ON	FnMomTgl	AC Momentary Contact - Positive = ON Negative = OFF
Fn•Of°NA	AC Maintained Contact - Closed = OFF Open = No Action		

Setting a 8-Contact Input Unit

Setting a 8-Contact Input Unit

Step 6 - Delay ON

**If you are connecting an Occupancy Sensor By Others and wish to use the built in delay time, adjust the time directly on the sensor according to the manufacturers specifications and set the delay ON and OFF fields of the WIR-3110 to 0* Using the UP/DOWN buttons, move the cursor until it highlights the 'On' field. Select the amount of time you wish to delay an ON command after it is initiated. The time can be adjusted from 0 seconds to 40 minutes by rotating the scroll wheel clockwise or counterclockwise.

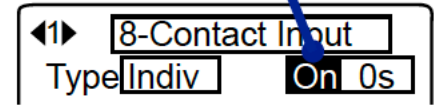

Step 7 - Input Type

**If you are connecting an Occupancy Sensor By Others and wish to use the built in delay time, adjust the time directly on the sensor according to the manufacturers specifications and set the delay ON and OFF fields of the WIR-3110 to 0* Using the UP/DOWN buttons, move the cursor until it highlights the 'Off' field. Select the amount of time you wish to delay an OFF command after it is initiated. The time can be adjusted from 0 seconds to 40 minutes by rotating the scroll wheel clockwise or counterclockwise.

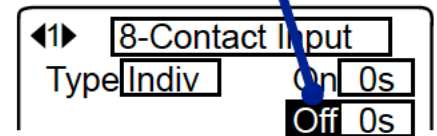

Step 8 - Assigning an Address

Using the UP/DOWN buttons, move the cursor until it highlights the 'Occ' field. Select either ON or OFF.

- select ON if you wish to use the delay settings on the IR Setting Unit. Ensure that the adjustable delay time directly on the sensor is set to the lowest setting possible.
- select OFF if you wish to use the delay settings provided by the manufacturer directly on the sensor. Using the UP/DOWN buttons, move the cursor until it highlights the 'Occ' field. Select either ON or OFF.

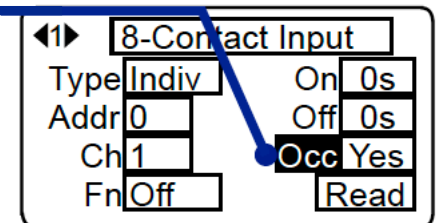

Step 9 - Assigning an Output Channel

Using the UP/DOWN buttons, move the cursor until it highlights the bottom right field. Rotate the center scroll wheel until 'Write' is highlighted. Point the Infrared transmitter approximately 0.5" away from the IR lens of the switch being programmed and press the center button of the IR Setting Unit. You will hear a single solid beep sound indicating that the switch was successfully programmed.

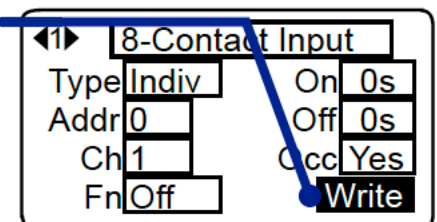

Setting a Occupancy Sensor

Setting a Occupancy Sensor

Step 1 - Delay ON

Using the UP/DOWN buttons, move the cursor until it highlights the 'Occupancy PIR' field.

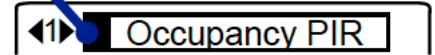

Step 2 - Input Type

Using the UP/DOWN buttons, move the cursor until it highlights the 'Type' field. Select the input type (Individual, Group, Preset Local, Preset Global) to apply to the sensor that you are programming by rotating the scroll wheel clockwise or counterclockwise.

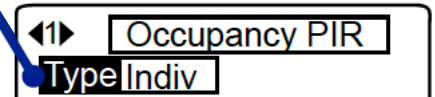

Step 3 - Assigning an Address

Using the UP/DOWN buttons, move the cursor until it highlights the 'Addr' field. Select the address you wish to assign the sensor by rotating the scroll wheel clockwise or counterclockwise.

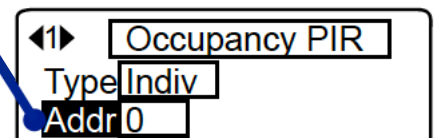

Step 4 - Assigning an Output Channel

Using the UP/DOWN buttons, move the cursor until it highlights the 'Ch' field. Select the output channel you wish to assign the Occupancy Sensor by rotating the scroll wheel clockwise or counterclockwise.

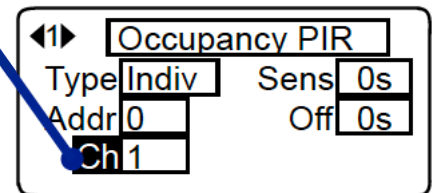

Step 5 - Input Type

Using the UP/DOWN buttons, move the cursor until it highlights the 'Sens' field. Select the level of sensitivity (1 - 10) you wish to apply to the Occupancy Sensor being programmed. A level of '1' being the least amount of sensitivity and a level of '10' being the greatest.

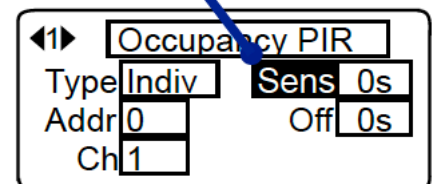

Step 6 - Assigning an Address

Using the UP/DOWN buttons, move the cursor until it highlights the 'Off' field. Select the amount of time you wish to delay an OFF command after it is initiated. The time can be adjusted from 0 seconds to 40 minutes by rotating the scroll wheel clockwise or counterclockwise.

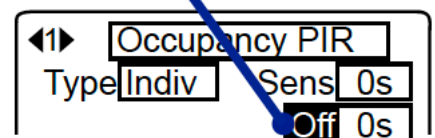

Step 7 - Assigning an Output Channel

Using the UP/DOWN buttons, move the cursor until it highlights the bottom right field. Rotate the center scroll wheel until 'Write' is highlighted. Point the Infrared transmitter approximately 0.5" away from the IR lens of the sensor being programmed and press the center button of the IR Setting Unit. You will hear a single solid beep sound indicating that the sensor was successfully programmed.

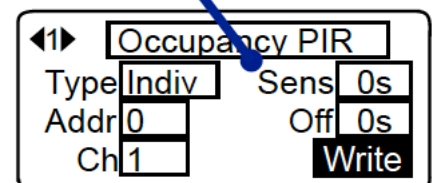

Setting a Photo Sensor

Setting a Photo Sensor

Step 1 - Photo Sensor Selection

Using the UP/DOWN buttons, move the cursor until it highlights the 'Photo Sensor' field.

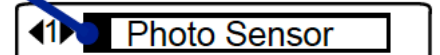

Step 2 - Photo Type

Using the UP/DOWN buttons, move the cursor until it highlights the 'Type' field. Select the input type (Local Photo and Global Photo) to apply to the sensor that you are programming by rotating the scroll wheel clockwise or counterclockwise.

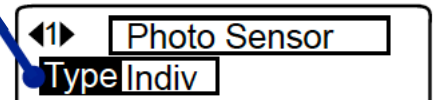

Step 3 - Assigning an Address

Using the UP/DOWN buttons, move the cursor until it highlights the 'Addr' field. Select the address you wish to assign the sensor by rotating the scroll wheel clockwise or counterclockwise.

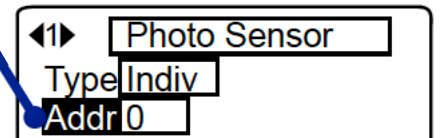

Step 4 - Writing Programming to a Photo Sensor

Using the UP/DOWN buttons, move the cursor until it highlights the bottom right field. Rotate the center scroll wheel until 'Write' is highlighted. Point the Infrared transmitter approximately 0.5" away from the IR lens of the sensor being programmed and press the center button of the IR Setting Unit. You will hear a single solid beep sound indicating that the switch was successfully programmed.

