

# Chapter 1

## Introduction to Flight Training

### PURPOSE OF FLIGHT TRAINING

The overall purpose of primary and intermediate flight training, as outlined in this handbook, is the acquisition and honing of **basic airmanship skills**. **Airmanship** can be defined as:

- A sound acquaintance with the principles of flight,
- The ability to operate an airplane with competence and precision both on the ground and in the air, and
- The exercise of sound judgment that results in optimal operational safety and efficiency.

Learning to fly an airplane has often been likened to learning to drive an automobile. This analogy is misleading. Since an airplane operates in a different environment, three dimensional, it requires a type of motor skill development that is more sensitive to this situation such as:

- **Coordination**—The ability to use the hands and feet together subconsciously and in the proper relationship to produce desired results in the airplane.
- **Timing**—The application of muscular coordination at the proper instant to make flight, and all maneuvers incident thereto, a constant smooth process.
- **Control touch**—The ability to sense the action of the airplane and its probable actions in the immediate future, with regard to attitude and speed variations, by the sensing and evaluation of varying pressures and resistance of the control surfaces transmitted through the cockpit flight controls.
- **Speed sense**—The ability to sense instantly and react to any reasonable variation of airspeed.

An airman becomes one with the airplane rather than a machine operator. An accomplished airman demonstrates the ability to assess a situation quickly and accurately and deduce the correct procedure to be followed under the circumstance; to analyze accurately the probable results of a given set of circumstances or of a proposed procedure; to exercise care and due regard for safety; to gauge accurately the performance of the airplane; and to recognize

personal limitations and limitations of the airplane and avoid approaching the critical points of each. The development of airmanship skills requires effort and dedication on the part of both the student pilot and the flight instructor, beginning with the very first training flight where proper habit formation begins with the student being introduced to good operating practices.

Every airplane has its own particular flight characteristics. The purpose of primary and intermediate flight training, however, is not to learn how to fly a particular make and model airplane. The underlying purpose of flight training is to develop skills and safe habits that are transferable to any airplane. Basic airmanship skills serve as a firm foundation for this. The pilot who has acquired necessary airmanship skills during training, and demonstrates these skills by flying training-type airplanes with precision and safe flying habits, will be able to easily transition to more complex and higher performance airplanes. It should also be remembered that the goal of flight training is a safe and competent pilot, and that passing required practical tests for pilot certification is only incidental to this goal.

### ROLE OF THE FAA

The Federal Aviation Administration (FAA) is empowered by the U.S. Congress to promote aviation safety by prescribing safety standards for civil aviation. This is accomplished through the Code of Federal Regulations (CFRs) formerly referred to as Federal Aviation Regulations (FARs).

Title 14 of the Code of Federal Regulations (14 CFR) part 61 pertains to the certification of pilots, flight instructors, and ground instructors. 14 CFR part 61 prescribes the eligibility, aeronautical knowledge, flight proficiency, and training and testing requirements for each type of pilot certificate issued.

14 CFR part 67 prescribes the medical standards and certification procedures for issuing medical certificates for airmen and for remaining eligible for a medical certificate.

14 CFR part 91 contains general operating and flight rules. The section is broad in scope and provides general guidance in the areas of general flight rules, visual flight rules (VFR), instrument flight rules (IFR), aircraft maintenance, and preventive maintenance and alterations.

Within the FAA, the Flight Standards Service sets the aviation standards for airmen and aircraft operations in the United States and for American airmen and aircraft around the world. The FAA Flight Standards Service is headquartered in Washington, D.C., and is broadly organized into divisions based on work function (Air Transportation, Aircraft Maintenance, Technical Programs, a Regulatory Support Division based in Oklahoma City, OK, and a General Aviation and Commercial Division). Regional Flight Standards division managers, one at each of the FAA's nine regional offices, coordinate Flight Standards activities within their respective regions.

The interface between the FAA Flight Standards Service and the aviation community/general public is the local Flight Standards District Office (FSDO). [Figure 1-1] The approximately 90 FSDOs are strategically located across the United States, each office having jurisdiction over a specific geographic area. The individual FSDO is responsible for all air activity occurring within its geographic boundaries. In addition to accident investigation and the enforcement of aviation regulations, the individual FSDO is responsible for the certification and surveillance of air carriers, air operators, flight schools/training centers, and airmen including pilots and flight instructors.

Each FSDO is staffed by aviation safety inspectors whose specialties include operations, maintenance, and avionics. General aviation operations inspectors are highly qualified and experienced aviators. Once accepted for the position, an inspector must satisfactorily complete a course of indoctrination training conducted at the FAA Academy, which includes airman evaluation and pilot testing techniques and procedures. Thereafter, the inspector must complete recurrent training on a regular basis. Among other duties, the FSDO inspector is responsible for administering FAA practical tests for pilot and flight



Figure 1-1. FAA FSDO.

instructor certificates and associated ratings. All questions concerning pilot certification (and/or requests for other aviation information or services) should be directed to the FSDO having jurisdiction in the particular geographic area. FSDO telephone numbers are listed in the blue pages of the telephone directory under United States Government offices, Department of Transportation, Federal Aviation Administration.

## ROLE OF THE PILOT EXAMINER

Pilot and flight instructor certificates are issued by the FAA upon satisfactory completion of required knowledge and practical tests. The administration of these tests is an FAA responsibility normally carried out at the FSDO level by FSDO inspectors. The FAA, however, being a U.S. government agency, has limited resources and must prioritize its responsibilities. The agency's highest priority is the surveillance of certificated air carriers, with the certification of airmen (including pilots and flight instructors) having a lower priority.

In order to satisfy the public need for pilot testing and certification services, the FAA delegates certain of these responsibilities, as the need arises, to private individuals who are not FAA employees. A designated pilot examiner (DPE) is a private citizen who is designated as a representative of the FAA Administrator to perform specific (but limited) pilot certification tasks on behalf of the FAA, and may charge a reasonable fee for doing so. Generally, a DPE's authority is limited to accepting applications and conducting practical tests leading to the issuance of specific pilot certificates and/or ratings. A DPE operates under the direct supervision of the FSDO that holds the examiner's designation file. A FSDO inspector is assigned to monitor the DPE's certification activities. Normally, the DPE is authorized to conduct these activities only within the designating FSDO's jurisdictional area.

The FAA selects only highly qualified individuals to be designated pilot examiners. These individuals must have good industry reputations for professionalism, high integrity, a demonstrated willingness to serve the public, and adhere to FAA policies and procedures in certification matters. A designated pilot examiner is expected to administer practical tests with the same degree of professionalism, using the same methods, procedures, and standards as an FAA aviation safety inspector. It should be remembered, however, that a DPE is not an FAA aviation safety inspector. A DPE cannot initiate enforcement action, investigate accidents, or perform surveillance activities on behalf of the FAA. However, the majority of FAA practical tests at the recreational, private, and commercial pilot level are administered by FAA designated pilot examiners.

## ROLE OF THE FLIGHT INSTRUCTOR

The flight instructor is the cornerstone of aviation safety. The FAA has adopted an operational training concept that places the full responsibility for student training on the authorized flight instructor. In this role, the instructor assumes the total responsibility for training the student pilot in all the knowledge areas and skills necessary to operate safely and competently as a certificated pilot in the National Airspace System. This training will include airmanship skills, pilot judgment and decision making, and accepted good operating practices.

An FAA certificated flight instructor has to meet broad flying experience requirements, pass rigid knowledge and practical tests, and demonstrate the ability to apply recommended teaching techniques before being certificated. In addition, the flight instructor's certificate must be renewed every 24 months by showing continued success in training pilots, or by satisfactorily completing a flight instructor's refresher course or a practical test designed to upgrade aeronautical knowledge, pilot proficiency, and teaching techniques.

A pilot training program is dependent on the quality of the ground and flight instruction the student pilot receives. A good flight instructor will have a thorough understanding of the learning process, knowledge of the fundamentals of teaching, and the ability to communicate effectively with the student pilot.

A good flight instructor will use a syllabus and insist on correct techniques and procedures from the beginning of training so that the student will develop proper habit patterns. The syllabus should embody the "building block" method of instruction, in which the student progresses from the known to the unknown. The course of instruction should be laid out so that each new maneuver embodies the principles involved in the performance of those previously undertaken. Consequently, through each new subject introduced, the student not only learns a new principle or technique, but broadens his/her application of those previously learned and has his/her deficiencies in the previous maneuvers emphasized and made obvious.

The flying habits of the flight instructor, both during flight instruction and as observed by students when conducting other pilot operations, have a vital effect on safety. Students consider their flight instructor to be a paragon of flying proficiency whose flying habits they, consciously or unconsciously, attempt to imitate. For this reason, a good flight instructor will meticulously observe the safety practices taught the students. Additionally, a good flight instructor will carefully

observe all regulations and recognized safety practices during all flight operations.

Generally, the student pilot who enrolls in a pilot training program is prepared to commit considerable time, effort, and expense in pursuit of a pilot certificate. The student may tend to judge the effectiveness of the flight instructor, and the overall success of the pilot training program, solely in terms of being able to pass the requisite FAA practical test. A good flight instructor, however, will be able to communicate to the student that evaluation through practical tests is a mere sampling of pilot ability that is compressed into a short period of time. The flight instructor's role, however, is to train the "total" pilot.

## SOURCES OF FLIGHT TRAINING

The major sources of flight training in the United States include FAA-approved pilot schools and training centers, non-certificated (14 CFR part 61) flying schools, and independent flight instructors. FAA "approved" schools are those flight schools certificated by the FAA as pilot schools under 14 CFR part 141. [Figure 1-2] Application for certification is voluntary, and the school must meet stringent requirements for personnel, equipment, maintenance, and facilities. The school must operate in accordance with an established curriculum, which includes a training course outline (TCO)



Figure 1-2. FAA-approved pilot school certificate.

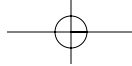

approved by the FAA. The TCO must contain student enrollment prerequisites, detailed description of each lesson including standards and objectives, expected accomplishments and standards for each stage of training, and a description of the checks and tests used to measure a student's accomplishments. FAA-approved pilot school certificates must be renewed every 2 years. Renewal is contingent upon proof of continued high quality instruction and a minimum level of instructional activity. Training at an FAA certificated pilot school is structured. Because of this structured environment, the CFRs allow graduates of these pilot schools to meet the certification experience requirements of 14 CFR part 61 with less flight time. Many FAA certificated pilot schools have designated pilot examiners (DPEs) on their staff to administer FAA practical tests. Some schools have been granted examining authority by the FAA. A school with examining authority for a particular course or courses has the authority to recommend its graduates for pilot certificates or ratings without further testing by the FAA. A list of FAA certificated pilot schools and their training courses can be found in Advisory Circular (AC) 140-2, *FAA Certificated Pilot School Directory*.

FAA-approved training centers are certificated under 14 CFR part 142. Training centers, like certificated pilot schools, operate in a structured environment with approved courses and curricula, and stringent standards for personnel, equipment, facilities, operating procedures and record keeping. Training centers certificated under 14 CFR part 142, however, specialize in the use of flight simulation (flight simulators and flight training devices) in their training courses.

The overwhelming majority of flying schools in the United States are not certificated by the FAA. These schools operate under the provisions of 14 CFR part 61. Many of these non-certificated flying schools offer excellent training, and meet or exceed the standards required of FAA-approved pilot schools. Flight instructors employed by non-certificated flying schools, as well as independent flight instructors, must meet the same basic 14 CFR part 61 flight instructor requirements for certification and renewal as those flight instructors employed by FAA certificated pilot schools. In the end, any training program is dependent upon the quality of the ground and flight instruction a student pilot receives.

## PRACTICAL TEST STANDARDS

Practical tests for FAA pilot certificates and associated ratings are administered by FAA inspectors and designated pilot examiners in accordance with FAA-developed practical test standards (PTS). [Figure 1-3] 14 CFR part 61 specifies the areas of operation in which knowledge and skill must be demonstrated by the applicant. The CFRs provide the flexibility to permit

the FAA to publish practical test standards containing the areas of operation and specific tasks in which competence must be demonstrated. The FAA requires that all practical tests be conducted in accordance with the appropriate practical test standards and the policies set forth in the Introduction section of the practical test standard book.

It must be emphasized that the practical test standards book is a testing document rather than a teaching document. An appropriately rated flight instructor is responsible for training a pilot applicant to acceptable standards in all subject matter areas, procedures, and maneuvers included in the tasks within each area of operation in the appropriate practical test standard. The pilot applicant should be familiar with this book and refer to the standards it contains during training. However, the practical test standard book is not intended to be used as a training syllabus. It contains the standards to which maneuvers/procedures on FAA practical tests must be performed and the FAA policies governing the administration of practical tests. Descriptions of tasks, and information on how to perform maneuvers and procedures are contained in reference and teaching documents such as this handbook. A list of reference documents is contained in the Introduction section of each practical test standard book.

Practical test standards may be downloaded from the Regulatory Support Division's, AFS-600, Web site at <http://afs600.faa.gov>. Printed copies of practical test standards can be purchased from the Superintendent of Documents, U.S. Government Printing Office, Washington, DC 20402. The official online bookstore Web site for the U.S. Government Printing Office is [www.access.gpo.gov](http://www.access.gpo.gov).

## FLIGHT SAFETY PRACTICES

In the interest of safety and good habit pattern formation, there are certain basic flight safety practices and procedures that must be emphasized by the flight instructor, and adhered to by both instructor and student, beginning with the very first dual instruction flight. These include, but are not limited to, collision avoidance procedures including proper scanning techniques and clearing procedures, runway incursion avoidance, stall awareness, positive transfer of controls, and cockpit workload management.

### COLLISION AVOIDANCE

All pilots must be alert to the potential for midair collision and near midair collisions. The general operating and flight rules in 14 CFR part 91 set forth the concept of "See and Avoid." This concept requires that vigilance shall be maintained at all times, by each person operating an aircraft regardless of whether the operation is conducted under instrument

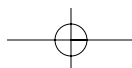

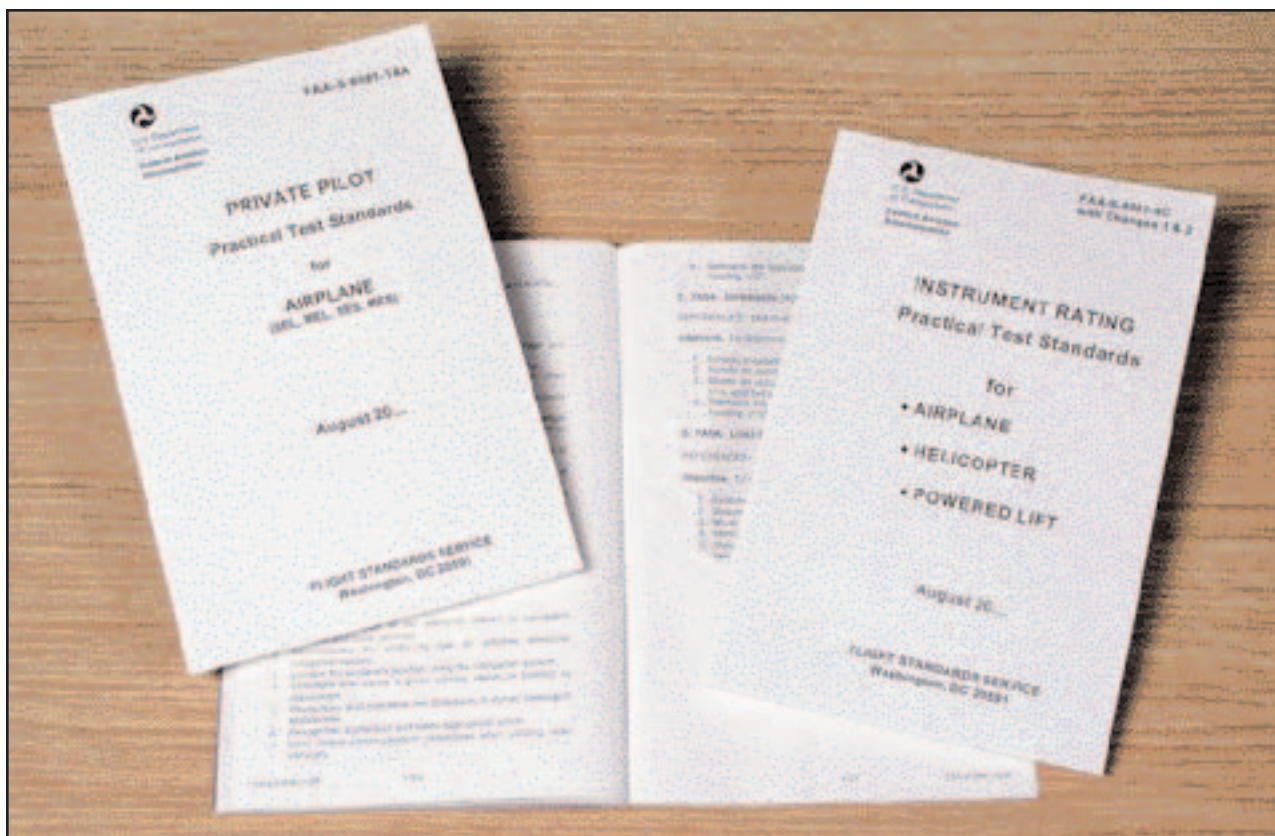

Figure 1-3. PTS books.

flight rules (IFR) or visual flight rules (VFR). Pilots should also keep in mind their responsibility for continuously maintaining a vigilant lookout regardless of the type of aircraft being flown and the purpose of the flight. Most midair collision accidents and reported near midair collision incidents occur in good VFR weather conditions and during the hours of daylight. Most of these accident/incidents occur within 5 miles of an airport and/or near navigation aids.

The “See and Avoid” concept relies on knowledge of the limitations of the human eye, and the use of proper visual scanning techniques to help compensate for these limitations. The importance of, and the proper techniques for, visual scanning should be taught to a student pilot at the very beginning of flight training. The competent flight instructor should be familiar with the visual scanning and collision avoidance information contained in Advisory Circular (AC) 90-48, *Pilots’ Role in Collision Avoidance*, and the *Aeronautical Information Manual* (AIM).

There are many different types of clearing procedures. Most are centered around the use of clearing turns. The essential idea of the clearing turn is to be certain that the next maneuver is not going to proceed into another airplane’s flightpath. Some pilot training programs have hard and fast rules, such as requiring two 90°

turns in opposite directions before executing any training maneuver. Other types of clearing procedures may be developed by individual flight instructors. Whatever the preferred method, the flight instructor should teach the beginning student an effective clearing procedure and insist on its use. The student pilot should execute the appropriate clearing procedure before all turns and before executing any training maneuver. Proper clearing procedures, combined with proper visual scanning techniques, are the most effective strategy for collision avoidance.

### RUNWAY INCURSION AVOIDANCE

A runway incursion is any occurrence at an airport involving an aircraft, vehicle, person, or object on the ground that creates a collision hazard or results in a loss of separation with an aircraft taking off, landing, or intending to land. The three major areas contributing to runway incursions are:

- Communications,
- Airport knowledge, and
- Cockpit procedures for maintaining orientation.

Taxi operations require constant vigilance by the entire flight crew, not just the pilot taxiing the airplane. This is especially true during flight training operations. Both the student pilot and the flight instructor need to be continually aware of the movement and location of

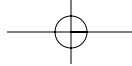

other aircraft and ground vehicles on the airport movement area. Many flight training activities are conducted at non-tower controlled airports. The absence of an operating airport control tower creates a need for increased vigilance on the part of pilots operating at those airports.

Planning, clear communications, and enhanced situational awareness during airport surface operations will reduce the potential for surface incidents. Safe aircraft operations can be accomplished and incidents eliminated if the pilot is properly trained early on and, throughout his/her flying career, accomplishes standard taxi operating procedures and practices. This requires the development of the formalized teaching of safe operating practices during taxi operations. The flight instructor is the key to this teaching. The flight instructor should instill in the student an awareness of the potential for runway incursion, and should emphasize the runway incursion avoidance procedures contained in Advisory Circular (AC) 91-73, Part 91 *Pilot and Flightcrew Procedures During Taxi Operations and Part 135 Single-Pilot Operations*.

### STALL AWARENESS

14 CFR part 61 requires that a student pilot receive and log flight training in stalls and stall recoveries prior to solo flight. During this training, the flight instructor should emphasize that the direct cause of every stall is an excessive angle of attack. The student pilot should fully understand that there are any number of flight maneuvers which may produce an increase in the wing's angle of attack, but the stall does not occur until the angle of attack becomes excessive. This "critical" angle of attack varies from 16 to 20° depending on the airplane design.

The flight instructor must emphasize that low speed is not necessary to produce a stall. The wing can be brought to an excessive angle of attack at any speed. High pitch attitude is not an absolute indication of proximity to a stall. Some airplanes are capable of vertical flight with a corresponding low angle of attack. Most airplanes are quite capable of stalling at a level or near level pitch attitude.

The key to stall awareness is the pilot's ability to visualize the wing's angle of attack in any particular circumstance, and thereby be able to estimate his/her margin of safety above stall. This is a learned skill that must be acquired early in flight training and carried through the pilot's entire flying career. The pilot must understand and appreciate factors such as airspeed, pitch attitude, load factor, relative wind, power setting, and aircraft configuration in order to develop a reasonably accurate mental picture of the wing's angle of attack at any particular time. It is

essential to flight safety that a pilot take into consideration this visualization of the wing's angle of attack prior to entering any flight maneuver.

### USE OF CHECKLISTS

Checklists have been the foundation of pilot standardization and cockpit safety for years. The checklist is an aid to the memory and helps to ensure that critical items necessary for the safe operation of aircraft are not overlooked or forgotten. However, checklists are of no value if the pilot is not committed to its use. Without discipline and dedication to using the checklist at the appropriate times, the odds are on the side of error. Pilots who fail to take the checklist seriously become complacent and the only thing they can rely on is memory.

The importance of consistent use of checklists cannot be overstated in pilot training. A major objective in primary flight training is to establish habit patterns that will serve pilots well throughout their entire flying career. The flight instructor must promote a positive attitude toward the use of checklists, and the student pilot must realize its importance. At a minimum, prepared checklists should be used for the following phases of flight.

- Preflight Inspection.
- Before Engine Start.
- Engine Starting.
- Before Taxiing.
- Before Takeoff.
- After Takeoff.
- Cruise.
- Descent.
- Before Landing.
- After Landing.
- Engine Shutdown and Securing.

### POSITIVE TRANSFER OF CONTROLS

During flight training, there must always be a clear understanding between the student and flight instructor of who has control of the aircraft. Prior to any dual training flight, a briefing should be conducted that includes the procedure for the exchange of flight controls. The following three-step process for the exchange of flight controls is highly recommended.

When a flight instructor wishes the student to take control of the aircraft, he/she should say to the student, "You have the flight controls." The student should acknowledge immediately by saying, "I have the flight controls." The flight instructor confirms by

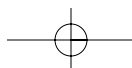

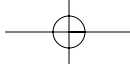

again saying, “You have the flight controls.” Part of the procedure should be a visual check to ensure that the other person actually has the flight controls. When returning the controls to the flight instructor, the student should follow the same procedure the instructor used when giving control to the student. The student should stay on the controls until the instructor says: “I have the flight controls.” There should never be

any doubt as to who is flying the airplane at any one time. Numerous accidents have occurred due to a lack of communication or misunderstanding as to who actually had control of the aircraft, particularly between students and flight instructors. Establishing the above procedure during initial training will ensure the formation of a very beneficial habit pattern.

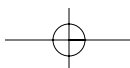

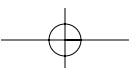
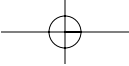



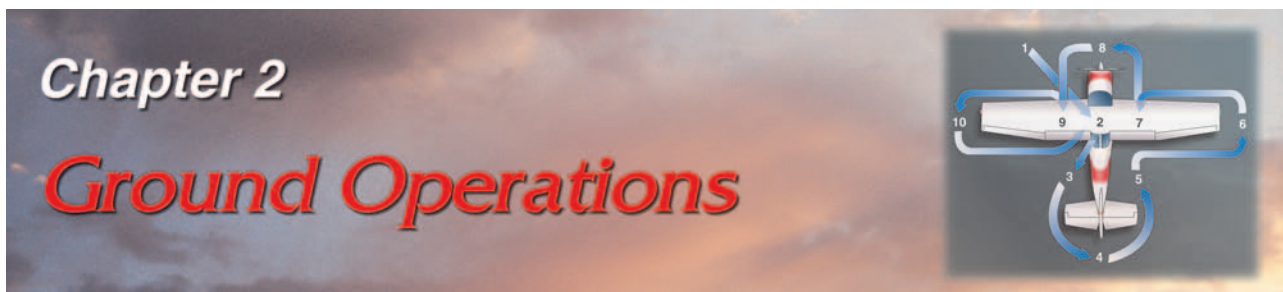
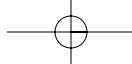

## VISUAL INSPECTION

The accomplishment of a safe flight begins with a careful visual inspection of the airplane. The purpose of the preflight visual inspection is twofold: to determine that the airplane is legally airworthy, and that it is in condition for safe flight. The airworthiness of the airplane is determined, in part, by the following certificates and documents, which must be on board the airplane when operated. [Figure 2-1]

- Airworthiness certificate.
- Registration certificate.
- FCC radio station license, if required by the type of operation.
- Airplane operating limitations, which may be in the form of an FAA-approved Airplane Flight Manual and/or Pilot's Operating Handbook (AFM/POH), placards, instrument markings, or any combination thereof.

Airplane logbooks are not required to be kept in the airplane when it is operated. However, they should be inspected prior to flight to show that the airplane has had required tests and inspections. Maintenance

records for the airframe and engine are required to be kept. There may also be additional propeller records.

At a minimum, there should be an annual inspection within the preceding 12-calendar months. In addition, the airplane may also be required to have a 100-hour inspection in accordance with Title 14 of the Code of Federal Regulations (14 CFR) part 91, section 91.409(b).

If a transponder is to be used, it is required to be inspected within the preceding 24-calendar months. If the airplane is operated under instrument flight rules (IFR) in controlled airspace, the pitot-static system is also required to be inspected within the preceding 24-calendar months.

The emergency locator transmitter (ELT) should also be checked. The ELT is battery powered, and the battery replacement or recharge date should not be exceeded.

Airworthiness Directives (ADs) have varying compliance intervals and are usually tracked in a separate area of the appropriate airframe, engine, or propeller record.

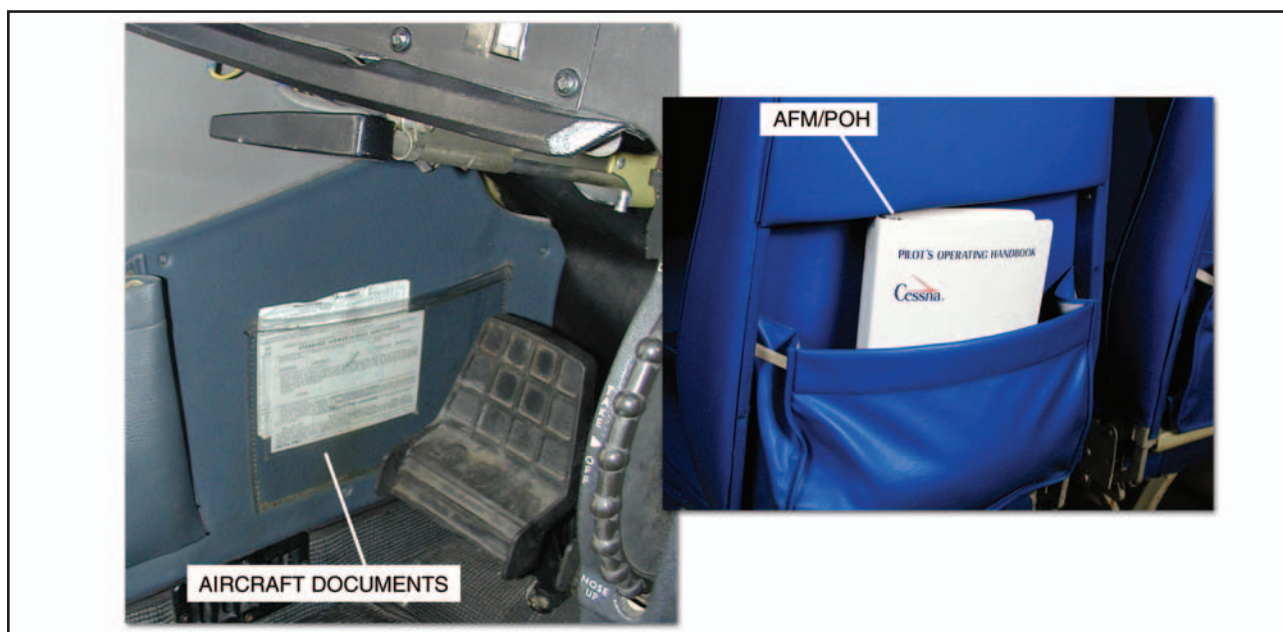
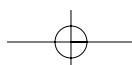

Figure 2-1. Aircraft documents and AFM/POH.



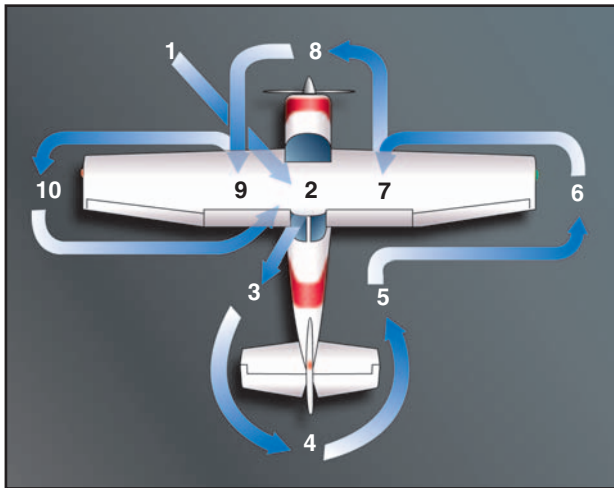
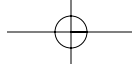

Figure 2-2. Preflight inspection.

The determination of whether the airplane is in a condition for safe flight is made by a preflight inspection of the airplane and its components. [Figure 2-2] The preflight inspection should be performed in accordance with a printed checklist provided by the airplane manufacturer for the specific make and model airplane. However, the following general areas are applicable to all airplanes.

The preflight inspection of the airplane should begin while approaching the airplane on the ramp. The pilot should make note of the general appearance of the airplane, looking for obvious discrepancies such as a landing gear out of alignment, structural distortion, skin damage, and dripping fuel or oil leaks. Upon reaching the airplane, all tiedowns, control locks, and chocks should be removed.

### INSIDE THE COCKPIT

The inspection should start with the cabin door. If the door is hard to open or close, or if the carpeting or seats are wet from a recent rain, there is a good chance that the door, fuselage, or both are misaligned. This may be a sign of structural damage.

The windshield and side windows should be examined for cracks and/or crazing. Crazing is the first stage of delamination of the plastic. Crazing decreases visibility, and a severely crazed window can result in near zero visibility due to light refraction at certain angles to the sun.

The pilot should check the seats, seat rails, and seat belt attach points for wear, cracks, and serviceability. The seat rail holes where the seat lock pins fit should



Figure 2-3. Inside the cockpit.

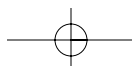

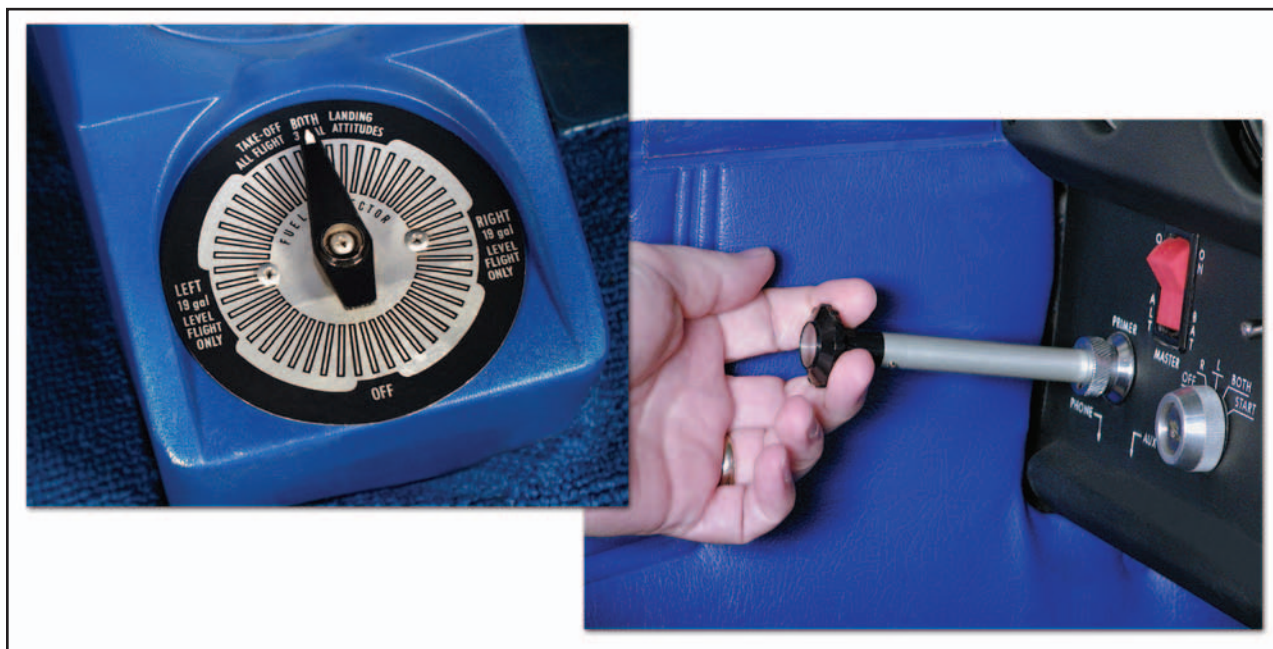

Figure 2-4. Fuel selector and primer.

also be inspected. The holes should be round and not oval. The pin and seat rail grips should also be checked for wear and serviceability.

Inside the cockpit, three key items to be checked are: (1) battery and ignition switches—off, (2) control column locks—*removed*, (3) landing gear control—*down and locked*. [Figure 2-3]

The fuel selectors should be checked for proper operation in all positions—including the OFF position. Stiff selectors, or ones where the tank position is hard to find, are unacceptable. The primer should also be exercised. The pilot should feel resistance when the primer is both pulled out and pushed in. The primer should also lock securely. Faulty primers can interfere with proper engine operation. [Figure 2-4] The engine controls should also be manipulated by slowly moving each through its full range to check for binding or stiffness.

The airspeed indicator should be properly marked, and the indicator needle should read zero. If it does not, the instrument may not be calibrated correctly. Similarly, the vertical speed indicator (VSI) should also read zero when the airplane is on the ground. If it does not, a small screwdriver can be used to zero the instrument. The VSI is the only flight instrument that a pilot has the prerogative to adjust. All others must be adjusted by an FAA certificated repairman or mechanic.

The magnetic compass is a required instrument for both VFR and IFR flight. It must be securely mounted, with a correction card in place. The instrument face must be clear and the instrument case full of fluid. A cloudy instrument face, bubbles in the fluid, or a partially filled case renders the instrument unusable. [Figure 2-5]

The gyro driven attitude indicator should be checked before being powered. A white haze on the inside of



Figure 2-5. Airspeed indicator, VSI, and magnetic compass.

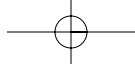

**Figure 2-6. Wing and tail section inspection.**

the glass face may be a sign that the seal has been breached, allowing moisture and dirt to be sucked into the instrument.

The altimeter should be checked against the ramp or field elevation after setting in the barometric pressure. If the variation between the known field elevation and the altimeter indication is more than 75 feet, its accuracy is questionable.

The pilot should turn on the battery master switch and make note of the fuel quantity gauge indications for comparison with an actual visual inspection of the fuel tanks during the exterior inspection.

### **OUTER WING SURFACES AND TAIL SECTION**

The pilot should inspect for any signs of deterioration, distortion, and loose or missing rivets or screws, especially in the area where the outer skin attaches to the airplane structure. [Figure 2-6] The pilot should look along the wing spar rivet line—from the wingtip to the fuselage—for skin distortion. Any ripples and/or waves may be an indication of internal damage or failure.

Loose or sheared aluminum rivets may be identified by the presence of black oxide which forms rapidly when

the rivet works free in its hole. Pressure applied to the skin adjacent to the rivet head will help verify the loosened condition of the rivet.

When examining the outer wing surface, it should be remembered that any damage, distortion, or malformation of the wing leading edge renders the airplane unairworthy. Serious dents in the leading edge, and disrepair of items such as stall strips, and deicer boots can cause the airplane to be aerodynamically unsound. Also, special care should be taken when examining the wingtips. Airplane wingtips are usually fiberglass. They are easily damaged and subject to cracking. The pilot should look at stop drilled cracks for evidence of crack progression, which can, under some circumstances, lead to in-flight failure of the wingtip.

The pilot should remember that fuel stains anywhere on the wing warrant further investigation—no matter how old the stains appear to be. Fuel stains are a sign of probable fuel leakage. On airplanes equipped with integral fuel tanks, evidence of fuel leakage can be found along rivet lines along the underside of the wing.

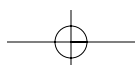

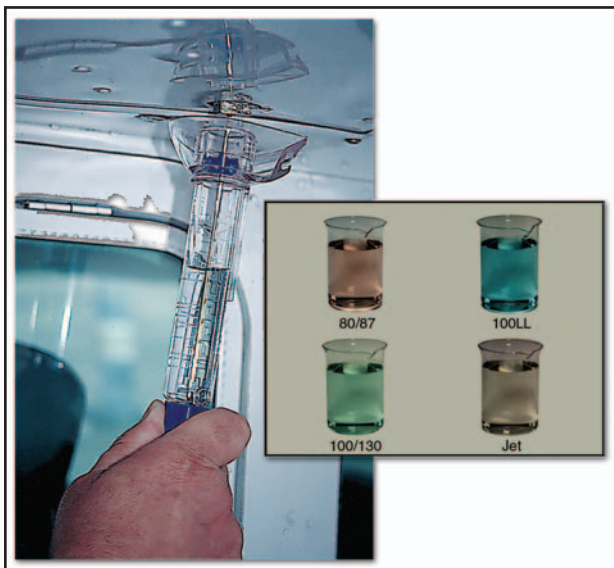

Figure 2-7. Aviation fuel types, grades, and colors.

## FUEL AND OIL

Particular attention should be paid to the fuel quantity, type and grade, and quality. [Figure 2-7] Many fuel tanks are very sensitive to airplane attitude when attempting to fuel for maximum capacity. Nosewheel strut extension, both high as well as low, can significantly alter the attitude, and therefore the fuel capacity. The airplane attitude can also be affected laterally by a ramp that slopes, leaving one wing slightly higher than another. Always confirm the fuel quantity indicated on the fuel gauges by visually inspecting the level of each tank.

The type, grade, and color of fuel are critical to safe operation. The only widely available aviation gasoline (AVGAS) grade in the United States is low-lead 100-octane, or 100LL. AVGAS is dyed for easy recognition of its grade and has a familiar gasoline scent. Jet-A, or jet fuel, is a kerosene-based fuel for turbine powered airplanes. It has disastrous consequences when inadvertently introduced into reciprocating airplane engines. The piston engine operating on jet fuel may start, run, and power the airplane, but will fail because the engine has been destroyed from detonation.

Jet fuel has a distinctive kerosene scent and is oily to the touch when rubbed between fingers. Jet fuel is clear or straw colored, although it may appear dyed when mixed in a tank containing AVGAS. When a few drops of AVGAS are placed upon white paper, they evaporate quickly and leave just a trace of dye. In comparison, jet fuel is slower to evaporate and leaves an oily smudge. Jet fuel refueling trucks and dispensing equipment are marked with JET-A placards in white letters on a black background. Prudent pilots will supervise fueling to ensure that the correct tanks are filled with the right quantity, type, and grade of

fuel. The pilot should always ensure that the fuel caps have been securely replaced following each fueling.

Engines certificated for grades 80/87 or 91/96 AVGAS will run satisfactorily on 100LL. The reverse is not true. Fuel of a lower grade/octane, if found, should never be substituted for a required higher grade. Detonation will severely damage the engine in a very short period of time.

Automotive gasoline is sometimes used as a substitute fuel in certain airplanes. Its use is acceptable only when the particular airplane has been issued a supplemental type certificate (STC) to both the airframe and engine allowing its use.

Checking for water and other sediment contamination is a key preflight element. Water tends to accumulate in fuel tanks from condensation, particularly in partially filled tanks. Because water is heavier than fuel, it tends to collect in the low points of the fuel system. Water can also be introduced into the fuel system from deteriorated gas cap seals exposed to rain, or from the supplier's storage tanks and delivery vehicles. Sediment contamination can arise from dust and dirt entering the tanks during refueling, or from deteriorating rubber fuel tanks or tank sealant.

The best preventive measure is to minimize the opportunity for water to condense in the tanks. If possible, the fuel tanks should be completely filled with the proper grade of fuel after each flight, or at least filled after the last flight of the day. The more fuel there is in the tanks, the less opportunity for condensation to occur. Keeping fuel tanks filled is also the best way to slow the aging of rubber fuel tanks and tank sealant.

Sufficient fuel should be drained from the fuel strainer quick drain and from each fuel tank sump to check for fuel grade/color, water, dirt, and smell. If water is present, it will usually be in bead-like droplets, different in color (usually clear, sometimes muddy), in the bottom of the sample. In extreme cases, do not overlook the possibility that the entire sample, particularly a small sample, is water. If water is found in the first fuel sample, further samples should be taken until no water appears. Significant and/or consistent water or sediment contamination are grounds for further investigation by qualified maintenance personnel. Each fuel tank sump should be drained during preflight and after refueling.

The fuel tank vent is an important part of a preflight inspection. Unless outside air is able to enter the tank as fuel is drawn out, the eventual result will be fuel gauge malfunction and/or fuel starvation. During the preflight inspection, the pilot should be alert for any

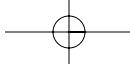

signs of vent tubing damage, as well as vent blockage. A functional check of the fuel vent system can be done simply by opening the fuel cap. If there is a rush of air when the fuel tank cap is cracked, there could be a serious problem with the vent system.

The oil level should be checked during each preflight and rechecked with each refueling. Reciprocating airplane engines can be expected to consume a small amount of oil during normal operation. If the consumption grows or suddenly changes, qualified maintenance personnel should investigate. If line service personnel add oil to the engine, the pilot should ensure that the oil cap has been securely replaced.

### LANDING GEAR, TIRES, AND BRAKES

Tires should be inspected for proper inflation, as well as cuts, bruises, wear, bulges, imbedded foreign object, and deterioration. As a general rule, tires with cord showing, and those with cracked sidewalls are considered unairworthy.

Brakes and brake systems should be checked for rust and corrosion, loose nuts/bolts, alignment, brake pad wear/cracks, signs of hydraulic fluid leakage, and hydraulic line security/abrasion.

An examination of the nose gear should include the shimmy damper, which is painted white, and the torque link, which is painted red, for proper servicing and general condition. All landing gear shock struts should also be checked for proper inflation.

### ENGINE AND PROPELLER

The pilot should make note of the condition of the engine cowling. [Figure 2-8] If the cowling rivet heads reveal aluminum oxide residue, and chipped paint surrounding and radiating away from the cowling rivet heads, it is a sign that the rivets have been rotating until the holes have been elongated. If allowed to continue,

the cowling may eventually separate from the airplane in flight.

Certain engine/propeller combinations require installation of a prop spinner for proper engine cooling. In these cases, the engine should not be operated unless the spinner is present and properly installed. The pilot should inspect the propeller spinner and spinner mounting plate for security of attachment, any signs of chafing of propeller blades, and defects such as cracking. A cracked spinner is unairworthy.

The propeller should be checked for nicks, cracks, pitting, corrosion, and security. The propeller hub should be checked for oil leaks, and the alternator/generator drive belt should be checked for proper tension and signs of wear.

When inspecting inside the cowling, the pilot should look for signs of fuel dye which may indicate a fuel leak. The pilot should check for oil leaks, deterioration of oil lines, and to make certain that the oil cap, filter, oil cooler and drain plug are secure. The exhaust system should be checked for white stains caused by exhaust leaks at the cylinder head or cracks in the stacks. The heat mufflers should also be checked for general condition and signs of cracks or leaks.

The air filter should be checked for condition and secure fit, as well as hydraulic lines for deterioration and/or leaks. The pilot should also check for loose or foreign objects inside the cowling such as bird nests, shop rags, and/or tools. All visible wires and lines should be checked for security and condition. And lastly, when the cowling is closed, the cowling fasteners should be checked for security.

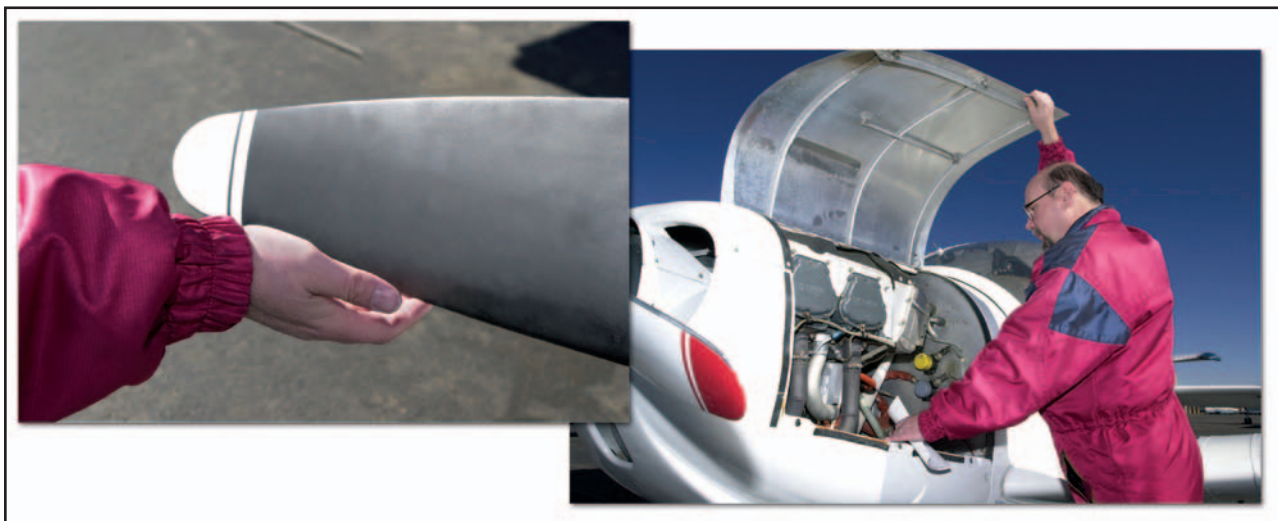
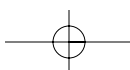

Figure 2-8. Check the propeller and inside the cowling.



## COCKPIT MANAGEMENT

After entering the airplane, the pilot should first ensure that all necessary equipment, documents, checklists, and navigation charts appropriate for the flight are on board. If a portable intercom, headsets, or a hand-held global positioning system (GPS) is used, the pilot is responsible for ensuring that the routing of wires and cables does not interfere with the motion or the operation of any control.

Regardless of what materials are to be used, they should be neatly arranged and organized in a manner that makes them readily available. The cockpit and cabin should be checked for articles that might be tossed about if turbulence is encountered. Loose items should be properly secured. All pilots should form the habit of good housekeeping.

The pilot must be able to see inside and outside references. If the range of motion of an adjustable seat is inadequate, cushions should be used to provide the proper seating position.

When the pilot is comfortably seated, the safety belt and shoulder harness (if installed) should be fastened and adjusted to a comfortably snug fit. The shoulder harness must be worn at least for the takeoff and landing, unless the pilot cannot reach or operate the controls with it fastened. The safety belt must be worn at all times when the pilot is seated at the controls.

If the seats are adjustable, it is important to ensure that the seat is locked in position. Accidents have occurred as the result of seat movement during acceleration or pitch attitude changes during takeoffs or landings. When the seat suddenly moves too close or too far away from the controls, the pilot may be unable to maintain control of the airplane.

14 CFR part 91 requires the pilot to ensure that each person on board is briefed on how to fasten and unfasten his/her safety belt and, if installed, shoulder harness. This should be accomplished before starting the engine, along with a passenger briefing on the proper use of safety equipment and exit information. Airplane manufacturers have printed briefing cards available, similar to those used by airlines, to supplement the pilot's briefing.

## GROUND OPERATIONS

It is important that a pilot operates an airplane safely on the ground. This includes being familiar with standard hand signals that are used by ramp personnel. [Figure 2-9]

## ENGINE STARTING

The specific procedures for engine starting will not be discussed here since there are as many different

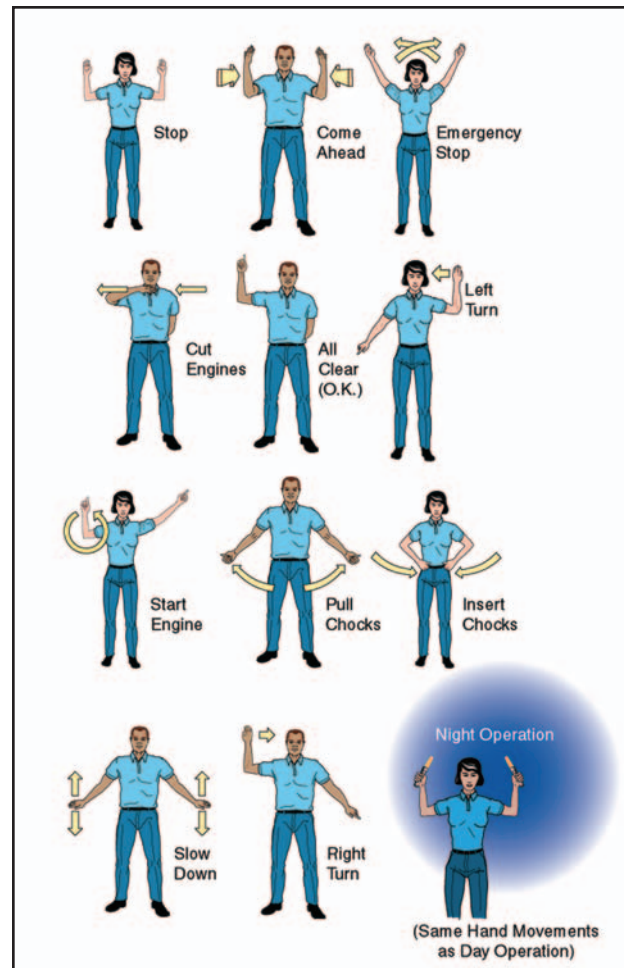

Figure 2-9. Standard hand signals.

methods as there are different engines, fuel systems, and starting conditions. The before engine starting and engine starting checklist procedures should be followed. There are, however, certain precautions that apply to all airplanes.

Some pilots have started the engine with the tail of the airplane pointed toward an open hangar door, parked automobiles, or a group of bystanders. This is not only discourteous, but may result in personal injury and damage to the property of others. Propeller blast can be surprisingly powerful.

When ready to start the engine, the pilot should look in all directions to be sure that nothing is or will be in the vicinity of the propeller. This includes nearby persons and aircraft that could be struck by the propeller blast or the debris it might pick up from the ground. The anticollision light should be turned on prior to engine start, even during daytime operations. At night, the position (navigation) lights should also be on.

The pilot should always call "CLEAR" out of the side window and wait for a response from persons who may be nearby before activating the starter.

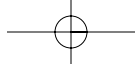

When activating the starter, one hand should be kept on the throttle. This allows prompt response if the engine falters during starting, and allows the pilot to rapidly retard the throttle if revolutions per minute (r.p.m.) are excessive after starting. A low r.p.m. setting (800 to 1,000) is recommended immediately following engine start. It is highly undesirable to allow the r.p.m. to race immediately after start, as there will be insufficient lubrication until the oil pressure rises. In freezing temperatures, the engine will also be exposed to potential mechanical distress until it warms and normal internal operating clearances are assumed.

As soon as the engine is operating smoothly, the oil pressure should be checked. If it does not rise to the manufacturer's specified value, the engine may not be receiving proper lubrication and should be shut down immediately to prevent serious damage.

Although quite rare, the starter motor may remain on and engaged after the engine starts. This can be detected by a continuous very high current draw on the ammeter. Some airplanes also have a starter engaged warning light specifically for this purpose. The engine should be shut down immediately should this occur.

Starters are small electric motors designed to draw large amounts of current for short periods of cranking. Should the engine fail to start readily, avoid continuous starter operation for periods longer than 30 seconds without a cool down period of at least 30 seconds to a minute (some AFM/POH specify even longer). Their service life is drastically shortened from high heat through overuse.

## HAND PROPPING

Even though most airplanes are equipped with electric starters, it is helpful if a pilot is familiar with the procedures and dangers involved in starting an engine by turning the propeller by hand (hand propping). Due to the associated hazards, this method of starting should be used only when absolutely necessary and when proper precautions have been taken.

An engine should not be hand propped unless two people, both familiar with the airplane and hand propping techniques, are available to perform the procedure. The person pulling the propeller blades through directs all activity and is in charge of the procedure. The other person, thoroughly familiar with the controls, must be seated in the airplane with the brakes set. As an additional precaution, chocks may be placed in front of the main wheels. If this is not feasible, the airplane's tail may be securely tied. Never allow a person unfamiliar with the controls to occupy the pilot's seat when hand propping. The procedure should never be attempted alone.

2-8

When hand propping is necessary, the ground surface near the propeller should be stable and free of debris. Unless a firm footing is available, consider relocating the airplane. Loose gravel, wet grass, mud, oil, ice, or snow might cause the person pulling the propeller through to slip into the rotating blades as the engine starts.

Both participants should discuss the procedure and agree on voice commands and expected action. To begin the procedure, the fuel system and engine controls (tank selector, primer, pump, throttle, and mixture) are set for a normal start. The ignition/magneto switch should be checked to be sure that it is OFF. Then the descending propeller blade should be rotated so that it assumes a position slightly above the horizontal. The person doing the hand propping should face the descending blade squarely and stand slightly less than one arm's length from the blade. If a stance too far away were assumed, it would be necessary to lean forward in an unbalanced condition to reach the blade. This may cause the person to fall forward into the rotating blades when the engine starts.

The procedure and commands for hand propping are:

- Person out front says, "GAS ON, SWITCH OFF, THROTTLE CLOSED, BRAKES SET."
- Pilot seat occupant, after making sure the fuel is ON, mixture is RICH, ignition/magneto switch is OFF, throttle is CLOSED, and brakes SET, says, "GAS ON, SWITCH OFF, THROTTLE CLOSED, BRAKES SET."
- Person out front, after pulling the propeller through to prime the engine says, "BRAKES AND CONTACT."
- Pilot seat occupant checks the brakes SET and turns the ignition switch ON, then says, "BRAKES AND CONTACT."

The propeller is swung by forcing the blade downward rapidly, pushing with the palms of both hands. If the blade is gripped tightly with the fingers, the person's body may be drawn into the propeller blades should the engine misfire and rotate momentarily in the opposite direction. As the blade is pushed down, the person should step backward, away from the propeller. If the engine does not start, the propeller should not be repositioned for another attempt until it is certain the ignition/magneto switch is turned OFF.

The words CONTACT (mags ON) and SWITCH OFF (mags OFF) are used because they are significantly different from each other. Under noisy conditions or high winds, the words CONTACT and SWITCH OFF

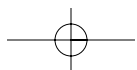



are less likely to be misunderstood than SWITCH ON and SWITCH OFF.

When removing the wheel chocks after the engine starts, it is essential that the pilot remember that the propeller is almost invisible. Incredible as it may seem, serious injuries and fatalities occur when people who have just started an engine walk or reach into the propeller arc to remove the chocks. Before the chocks are removed, the throttle should be set to idle and the chocks approached from the rear of the propeller. Never approach the chocks from the front or the side.

The procedures for hand propping should always be in accordance with the manufacturer's recommendations and checklist. Special starting procedures are used when the engine is already warm, very cold, or when flooded or vapor locked. There will also be a different starting procedure when an external power source is used.

## TAXIING

The following basic taxi information is applicable to both nosewheel and tailwheel airplanes.

Taxiing is the controlled movement of the airplane under its own power while on the ground. Since an airplane is moved under its own power between the parking area and the runway, the pilot must thoroughly understand and be proficient in taxi procedures.

An awareness of other aircraft that are taking off, landing, or taxiing, and consideration for the right-of-way of others is essential to safety. When taxiing, the pilot's eyes should be looking outside the airplane, to the sides, as well as the front. The pilot must be aware of the entire area around the airplane to ensure that the airplane will clear all obstructions and other aircraft. If at any time there is doubt about the clearance from an object, the pilot should stop the airplane and have someone check the clearance. It may be necessary to have the airplane towed or physically moved by a ground crew.

It is difficult to set any rule for a single, safe taxiing speed. What is reasonable and prudent under some conditions may be imprudent or hazardous under others. The primary requirements for safe taxiing are positive control, the ability to recognize potential hazards in time to avoid them, and the ability to stop or turn where and when desired, without undue reliance on the brakes. Pilots should proceed at a cautious speed on congested or busy ramps. Normally, the speed should be at the rate where movement of the airplane is dependent on the throttle. That is, slow enough so when the throttle is closed, the airplane can be stopped promptly. When yellow taxiway centerline stripes are provided, they should be observed unless necessary to clear airplanes or obstructions.

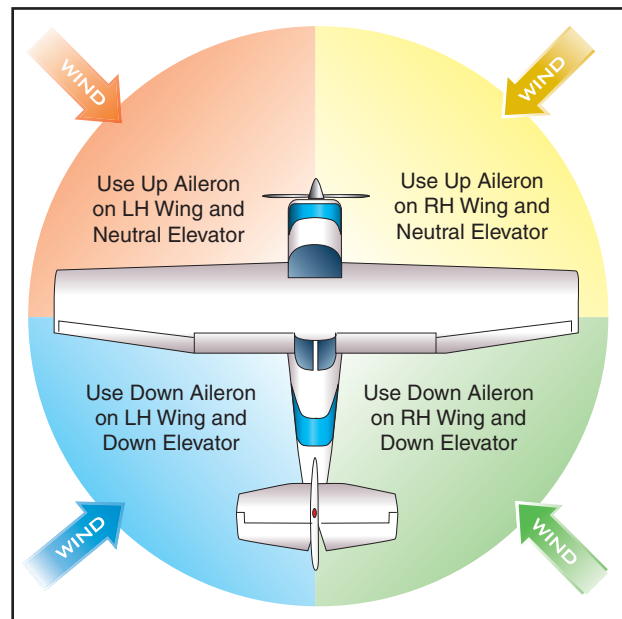

Figure 2-10. Flight control positions during taxi.

When taxiing, it is best to slow down before attempting a turn. Sharp, high-speed turns place undesirable side loads on the landing gear and may result in an uncontrollable swerve or a ground loop. This swerve is most likely to occur when turning from a downwind heading toward an upwind heading. In moderate to high-wind conditions, pilots will note the airplane's tendency to weathervane, or turn into the wind when the airplane is proceeding crosswind.

When taxiing at appropriate speeds in no-wind conditions, the aileron and elevator control surfaces have little or no effect on directional control of the airplane. The controls should not be considered steering devices and should be held in a neutral position. Their proper use while taxiing in windy conditions will be discussed later. [Figure 2-10]

Steering is accomplished with rudder pedals and brakes. To turn the airplane on the ground, the pilot should apply rudder in the desired direction of turn and use whatever power or brake that is necessary to control the taxi speed. The rudder pedal should be held in the direction of the turn until just short of the point where the turn is to be stopped. Rudder pressure is then released or opposite pressure is applied as needed.

More engine power may be required to start the airplane moving forward, or to start a turn, than is required to keep it moving in any given direction. When using additional power, the throttle should immediately be retarded once the airplane begins moving, to prevent excessive acceleration.

When first beginning to taxi, the brakes should be tested for proper operation as soon as the airplane is put in motion. Applying power to start the airplane

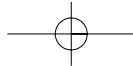

moving forward slowly, then retarding the throttle and simultaneously applying pressure smoothly to both brakes does this. If braking action is unsatisfactory, the engine should be shut down immediately.

The presence of moderate to strong headwinds and/or a strong propeller slipstream makes the use of the elevator necessary to maintain control of the pitch attitude while taxiing. This becomes apparent when considering the lifting action that may be created on the horizontal tail surfaces by either of those two factors. The elevator control in nosewheel-type airplanes should be held in the neutral position, while in tailwheel-type airplanes it should be held in the aft position to hold the tail down.

Downwind taxiing will usually require less engine power after the initial ground roll is begun, since the wind will be pushing the airplane forward. [Figure 2-11] To avoid overheating the brakes when taxiing downwind, keep engine power to a minimum. Rather than continuously riding the brakes to control speed, it is better to apply brakes only occasionally. Other than sharp turns at low speed, the throttle should always be at idle before the brakes are applied. It is a common student error to taxi with a power setting that requires controlling taxi speed with the brakes. This is the aeronautical equivalent of driving an automobile with both the accelerator and brake pedals depressed.

When taxiing with a quartering headwind, the wing on the upwind side will tend to be lifted by the wind unless the aileron control is held in that direction (upwind aileron UP). [Figure 2-12] Moving the aileron

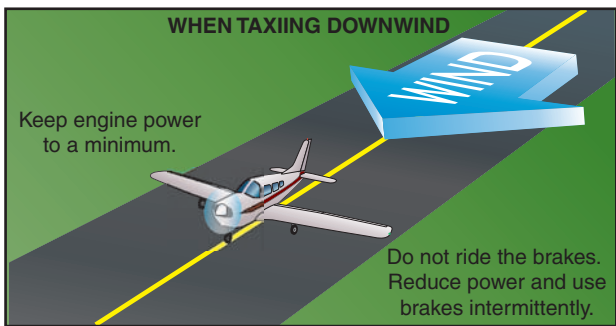

Figure 2-11. Downwind taxi.

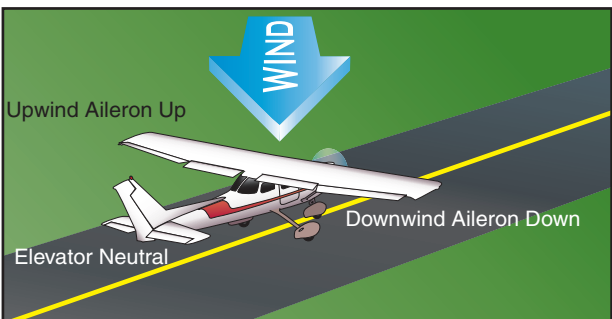

Figure 2-12. Quartering headwind.

into the UP position reduces the effect of the wind striking that wing, thus reducing the lifting action. This control movement will also cause the downwind aileron to be placed in the DOWN position, thus a small amount of lift and drag on the downwind wing, further reducing the tendency of the upwind wing to rise.

When taxiing with a quartering tailwind, the elevator should be held in the DOWN position, and the upwind aileron, DOWN. [Figure 2-13] Since the wind is striking the airplane from behind, these control positions reduce the tendency of the wind to get under the tail and the wing and to nose the airplane over.

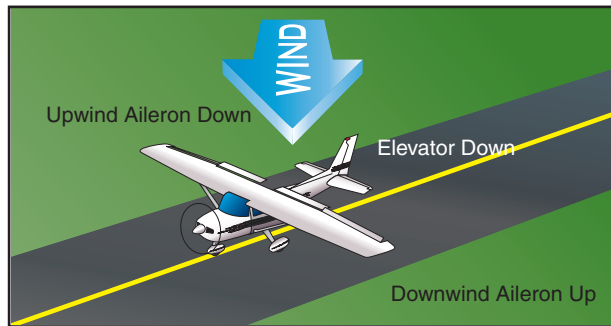

Figure 2-13. Quartering tailwind.

The application of these crosswind taxi corrections helps to minimize the weathervaning tendency and ultimately results in making the airplane easier to steer.

Normally, all turns should be started using the rudder pedal to steer the nosewheel. To tighten the turn after full pedal deflection is reached, the brake may be applied as needed. When stopping the airplane, it is advisable to always stop with the nosewheel straight ahead to relieve any side load on the nosewheel and to make it easier to start moving ahead.

During crosswind taxiing, even the nosewheel-type airplane has some tendency to weathervane. However,

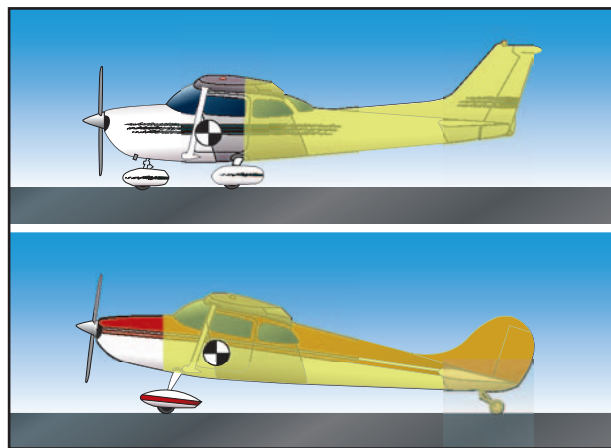
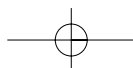
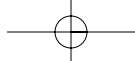

Figure 2-14. Surface area most affected by wind.





the weathervaning tendency is less than in tailwheel-type airplanes because the main wheels are located farther aft, and the nosewheel's ground friction helps to resist the tendency. [Figure 2-14] The nosewheel linkage from the rudder pedals provides adequate steering control for safe and efficient ground handling, and normally, only rudder pressure is necessary to correct for a crosswind.

## BEFORE TAKEOFF CHECK

The before takeoff check is the systematic procedure for making a check of the engine, controls, systems, instruments, and avionics prior to flight. Normally, it is performed after taxiing to a position near the takeoff end of the runway. Taxiing to that position usually allows sufficient time for the engine to warm up to at least minimum operating temperatures. This ensures adequate lubrication and internal engine clearances before being operated at high power settings. Many engines require that the oil temperature reach a minimum value as stated in the AFM/POH before high power is applied.

Air-cooled engines generally are closely cowled and equipped with pressure baffles that direct the flow of air to the engine in sufficient quantities for cooling in flight. On the ground, however, much less air is forced through the cowling and around the baffling. Prolonged ground operations may cause cylinder overheating long before there is an indication of rising oil temperature. Cowl flaps, if available, should be set according to the AFM/POH.

Before beginning the before takeoff check, the airplane should be positioned clear of other aircraft. There should not be anything behind the airplane that might be damaged by the prop blast. To minimize overheating during engine runup, it is recommended that the airplane be headed as nearly as possible into the wind. After the airplane is properly positioned for the runup, it should be allowed to roll forward slightly so that the nosewheel or tailwheel will be aligned fore and aft.

During the engine runup, the surface under the airplane should be firm (a smooth, paved, or turf surface if possible) and free of debris. Otherwise, the propeller may pick up pebbles, dirt, mud, sand, or other loose objects and hurl them backwards. This damages the propeller and may damage the tail of the airplane. Small chips in the leading edge of the propeller form stress risers, or lines of concentrated high stress. These are highly undesirable and may lead to cracks and possible propeller blade failure.

While performing the engine runup, the pilot must divide attention inside and outside the airplane. If the

parking brake slips, or if application of the toe brakes is inadequate for the amount of power applied, the airplane could move forward unnoticed if attention is fixed inside the airplane.

Each airplane has different features and equipment, and the before takeoff checklist provided by the airplane manufacturer or operator should be used to perform the runup.

## AFTER LANDING

During the after-landing roll, the airplane should be gradually slowed to normal taxi speed before turning off the landing runway. Any significant degree of turn at faster speeds could result in ground looping and subsequent damage to the airplane.

To give full attention to controlling the airplane during the landing roll, the after-landing check should be performed only after the airplane is brought to a complete stop clear of the active runway. There have been many cases of the pilot mistakenly grasping the wrong handle and retracting the landing gear, instead of the flaps, due to improper division of attention while the airplane was moving. However, this procedure may be modified if the manufacturer recommends that specific after-landing items be accomplished during landing rollout. For example, when performing a short-field landing, the manufacturer may recommend retracting the flaps on rollout to improve braking. In this situation, the pilot should make a positive identification of the flap control and retract the flaps.

## CLEAR OF RUNWAY

Because of different features and equipment in various airplanes, the after-landing checklist provided by the manufacturer should be used. Some of the items may include:

- Flaps . . . . . Identify and retract
- Cowl flaps . . . . . Open
- Propeller control . . . . . Full increase
- Trim tabs . . . . . Set

## PARKING

Unless parking in a designated, supervised area, the pilot should select a location and heading which will prevent the propeller or jet blast of other airplanes from striking the airplane broadside. Whenever possible, the airplane should be parked headed into the existing or forecast wind. After stopping on the desired heading, the airplane should be allowed to roll straight ahead enough to straighten the nosewheel or tailwheel.

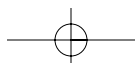

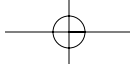

## ENGINE SHUTDOWN

Finally, the pilot should always use the procedures in the manufacturer's checklist for shutting down the engine and securing the airplane. Some of the important items include:

- Set the parking brakes ON.
- Set throttle to IDLE or 1,000 r.p.m. If turbocharged, observe the manufacturer's spool down procedure.
- Turn ignition switch OFF then ON at idle to check for proper operation of switch in the OFF position.
- Set propeller control (if equipped) to FULL INCREASE.
- Turn electrical units and radios OFF.
- Set mixture control to IDLE CUTOFF.

- Turn ignition switch to OFF when engine stops.
- Turn master electrical switch to OFF.
- Install control lock.

## POSTFLIGHT

A flight is never complete until the engine is shut down and the airplane is secured. A pilot should consider this an essential part of any flight.

## SECURING AND SERVICING

After engine shutdown and deplaning passengers, the pilot should accomplish a postflight inspection. This includes checking the general condition of the aircraft. For a departure, the oil should be checked and fuel added if required. If the aircraft is going to be inactive, it is a good operating practice to fill the tanks to the top to prevent water condensation from forming. When the flight is completed for the day, the aircraft should be hangared or tied down and the flight controls secured.

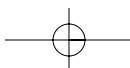

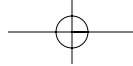

## THE FOUR FUNDAMENTALS

There are four fundamental basic flight maneuvers upon which all flying tasks are based: straight-and-level flight, turns, climbs, and descents. All controlled flight consists of either one, or a combination or more than one, of these basic maneuvers. If a student pilot is able to perform these maneuvers well, and the student's proficiency is based on accurate "feel" and control analysis rather than mechanical movements, the ability to perform any assigned maneuver will only be a matter of obtaining a clear visual and mental conception of it. The flight instructor must impart a good knowledge of these basic elements to the student, and must combine them and plan their practice so that perfect performance of each is instinctive without conscious effort. The importance of this to the success of flight training cannot be overemphasized. As the student progresses to more complex maneuvers, discounting any difficulties in visualizing the maneuvers, most student difficulties will be caused by a lack of training, practice, or understanding of the principles of one or more of these fundamentals.

## EFFECTS AND USE OF THE CONTROLS

In explaining the functions of the controls, the instructor should emphasize that the controls never change in the results produced in relation to the pilot. The pilot should always be considered the center of movement of the airplane, or the reference point from which the movements of the airplane are judged and described. The following will always be true, regardless of the airplane's attitude in relation to the Earth.

- When back pressure is applied to the elevator control, the airplane's nose rises in relation to the pilot.
- When forward pressure is applied to the elevator control, the airplane's nose lowers in relation to the pilot.
- When right pressure is applied to the aileron control, the airplane's right wing lowers in relation to the pilot.
- When left pressure is applied to the aileron control, the airplane's left wing lowers in relation to the pilot.
- When pressure is applied to the right rudder pedal, the airplane's nose moves (yaws) to the right in relation to the pilot.

- When pressure is applied to the left rudder pedal, the airplane's nose moves (yaws) to the left in relation to the pilot.

The preceding explanations should prevent the beginning pilot from thinking in terms of "up" or "down" in respect to the Earth, which is only a relative state to the pilot. It will also make understanding of the functions of the controls much easier, particularly when performing steep banked turns and the more advanced maneuvers. Consequently, the pilot must be able to properly determine the control application required to place the airplane in any attitude or flight condition that is desired.

The flight instructor should explain that the controls will have a natural "live pressure" while in flight and that they will remain in neutral position of their own accord, if the airplane is trimmed properly.

With this in mind, the pilot should be cautioned never to think of movement of the controls, but of exerting a force on them against this live pressure or resistance. Movement of the controls should not be emphasized; it is the duration and amount of the force exerted on them that effects the displacement of the control surfaces and maneuvers the airplane.

The amount of force the airflow exerts on a control surface is governed by the airspeed and the degree that the surface is moved out of its neutral or streamlined position. Since the airspeed will not be the same in all maneuvers, the actual amount the control surfaces are moved is of little importance; but it is important that the pilot maneuver the airplane by applying sufficient control *pressure* to obtain a desired result, regardless of how far the control surfaces are actually moved.

The controls should be held lightly, with the fingers, not grabbed and squeezed. Pressure should be exerted on the control yoke with the fingers. A common error in beginning pilots is a tendency to "choke the stick." This tendency should be avoided as it prevents the development of "feel," which is an important part of aircraft control.

The pilot's feet should rest comfortably against the rudder pedals. Both heels should support the weight of the feet on the cockpit floor with the ball of each foot touching the individual rudder pedals. The legs and feet should not be tense; they must be relaxed just as when driving an automobile.

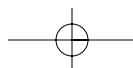

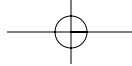

When using the rudder pedals, pressure should be applied smoothly and evenly by pressing with the ball of one foot. Since the rudder pedals are interconnected, and act in opposite directions, when pressure is applied to one pedal, pressure on the other must be relaxed proportionately. When the rudder pedal must be moved significantly, heavy pressure changes should be made by applying the pressure with the ball of the foot while the heels slide along the cockpit floor. Remember, the ball of each foot must rest comfortably on the rudder pedals so that even slight pressure changes can be felt.

In summary, during flight, it is the *pressure* the pilot exerts on the control yoke and rudder pedals that causes the airplane to move about its axes. When a control surface is moved out of its streamlined position (even slightly), the air flowing past it will exert a force against it and will try to return it to its streamlined position. It is this force that the pilot feels as pressure on the control yoke and the rudder pedals.

## FEEL OF THE AIRPLANE

The ability to sense a flight condition, without relying on cockpit instrumentation, is often called “feel of the airplane,” but senses in addition to “feel” are involved.

Sounds inherent to flight are an important sense in developing “feel.” The air that rushes past the modern light plane cockpit/cabin is often masked by soundproofing, but it can still be heard. When the level of sound increases, it indicates that airspeed is increasing. Also, the powerplant emits distinctive sound patterns in different conditions of flight. The sound of the engine in cruise flight may be different from that in a climb, and different again from that in a dive. When power is used in fixed-pitch propeller airplanes, the loss of r.p.m. is particularly noticeable. The amount of noise that can be heard will depend on how much the slipstream masks it out. But the relationship between slipstream noise and powerplant noise aids the pilot in estimating not only the present airspeed but the trend of the airspeed.

There are three sources of actual “feel” that are very important to the pilot. One is the pilot’s own body as it responds to forces of acceleration. The “G” loads imposed on the airframe are also felt by the pilot. Centripetal accelerations force the pilot down into the seat or raise the pilot against the seat belt. Radial accelerations, as they produce slips or skids of the airframe, shift the pilot from side to side in the seat. These forces need not be strong, only perceptible by the pilot to be useful. An accomplished pilot who has excellent “feel” for the airplane will be able to detect even the minutest change.

The response of the aileron and rudder controls to the pilot’s touch is another element of “feel,” and is one

that provides direct information concerning airspeed. As previously stated, control surfaces move in the airstream and meet resistance proportional to the speed of the airstream. When the airstream is fast, the controls are stiff and hard to move. When the airstream is slow, the controls move easily, but must be deflected a greater distance. The pressure that must be exerted on the controls to effect a desired result, and the lag between their movement and the response of the airplane, becomes greater as airspeed decreases.

Another type of “feel” comes to the pilot through the airframe. It consists mainly of vibration. An example is the aerodynamic buffeting and shaking that precedes a stall.

Kinesthesia, or the sensing of changes in direction or speed of motion, is one of the most important senses a pilot can develop. When properly developed, kinesthesia can warn the pilot of changes in speed and/or the beginning of a settling or **mushing** of the airplane.

The senses that contribute to “feel” of the airplane are inherent in every person. However, “feel” must be developed. The flight instructor should direct the beginning pilot to be attuned to these senses and teach an awareness of their meaning as it relates to various conditions of flight. To do this effectively, the flight instructor must fully understand the difference between perceiving something and merely noticing it. It is a well established fact that the pilot who develops a “feel” for the airplane early in flight training will have little difficulty with advanced flight maneuvers.

## ATTITUDE FLYING

In contact (VFR) flying, flying by attitude means visually establishing the airplane’s attitude with reference to the natural horizon. [Figure 3-1] Attitude is the angular difference measured between an airplane’s axis and the line of the Earth’s horizon. Pitch attitude is the angle formed by the longitudinal axis, and bank attitude is the angle formed by the lateral axis. Rotation about the airplane’s vertical axis (yaw) is termed an attitude relative to the airplane’s flightpath, but not relative to the natural horizon.

In attitude flying, airplane control is composed of four components: pitch control, bank control, power control, and trim.

- Pitch control is the control of the airplane about the lateral axis by using the elevator to raise and lower the nose in relation to the natural horizon.
- Bank control is control of the airplane about the longitudinal axis by use of the ailerons to attain a desired bank angle in relation to the natural horizon.

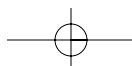

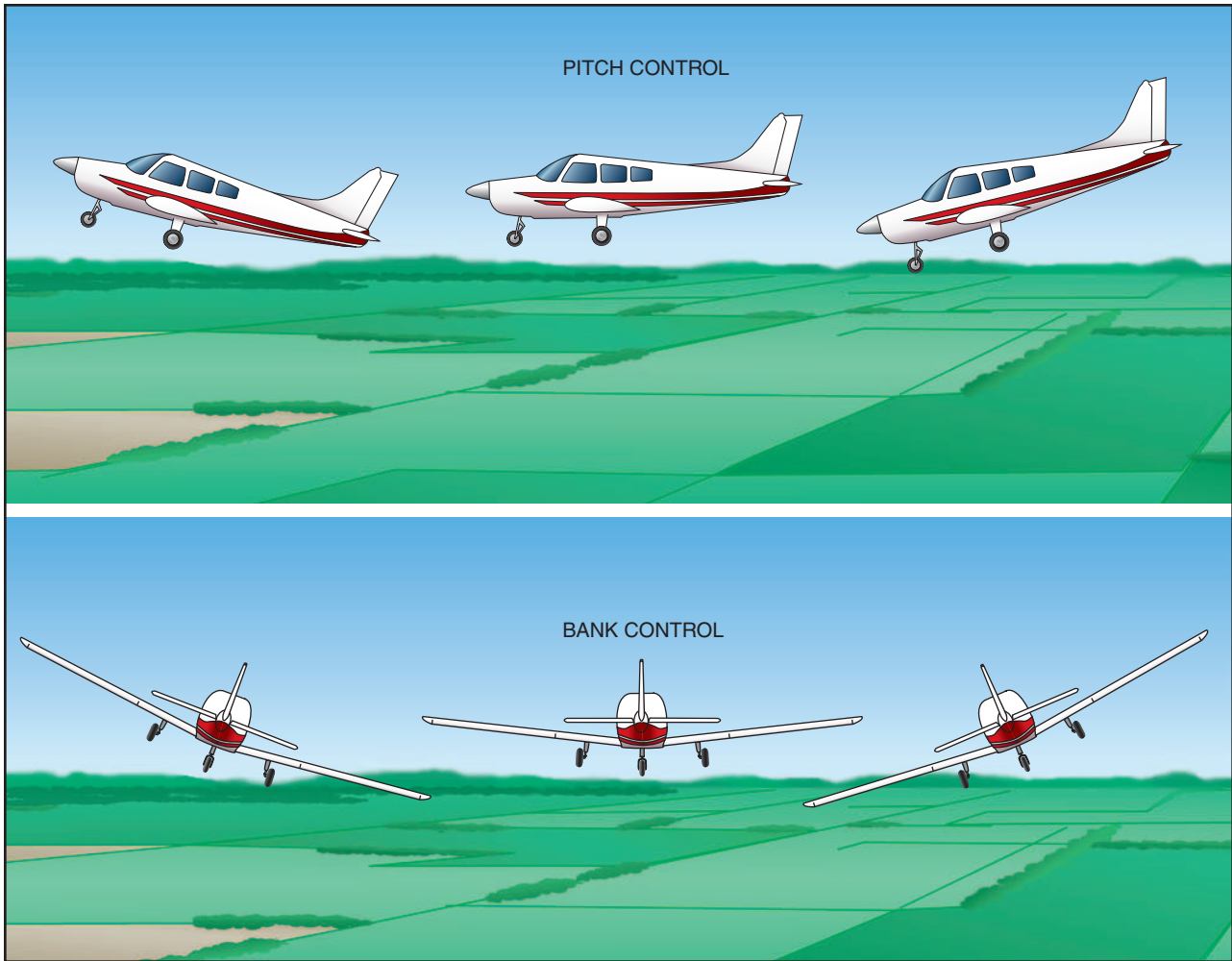
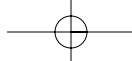

Figure 3-1. Airplane attitude is based on relative positions of the nose and wings on the natural horizon.

- Power control is used when the flight situation indicates a need for a change in thrust.
- Trim is used to relieve all possible control pressures held after a desired attitude has been attained.
- The airplane's attitude is established and maintained by positioning the airplane in relation to the natural horizon. At least 90 percent of the pilot's attention should be devoted to this end, along with

The primary rule of attitude flying is:

**ATTITUDE + POWER = PERFORMANCE**

### INTEGRATED FLIGHT INSTRUCTION

When introducing basic flight maneuvers to a beginning pilot, it is recommended that the "Integrated" or "Composite" method of flight instruction be used. This means the use of outside references and flight instruments to establish and maintain desired flight attitudes and airplane performance. [Figure 3-2] When beginning pilots use this technique, they achieve a more precise and competent overall piloting ability. Although this method of airplane control may become second nature with experience, the beginning pilot must make a determined effort to master the technique. The basic elements of which are as follows.

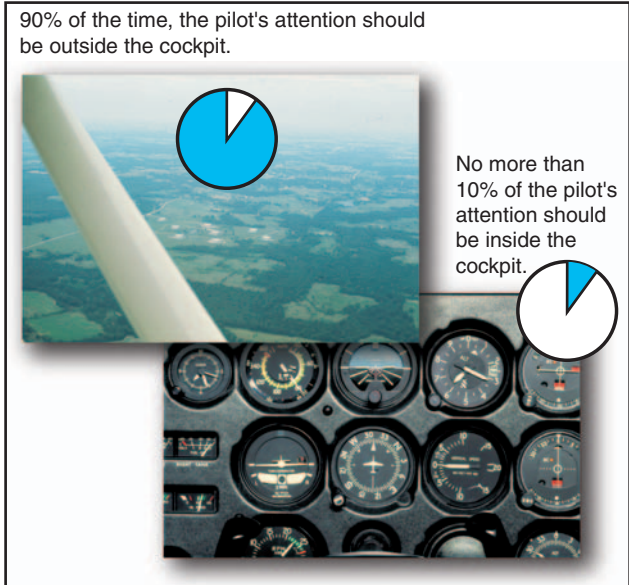
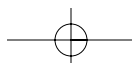
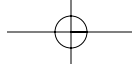

Figure 3-2. Integrated or composite method of flight instruction.





scanning for other airplanes. If, during a recheck of the pitch and/or bank, either or both are found to be other than desired, an immediate correction is made to return the airplane to the proper attitude. Continuous checks and immediate corrections will allow little chance for the airplane to deviate from the desired heading, altitude, and flightpath.

- The airplane's attitude is confirmed by referring to flight instruments, and its performance checked. If airplane performance, as indicated by flight instruments, indicates a need for correction, a specific amount of correction must be determined, then applied with reference to the natural horizon. The airplane's attitude and performance are then rechecked by referring to flight instruments. The pilot then maintains the corrected attitude by reference to the natural horizon.
- The pilot should monitor the airplane's performance by making numerous quick glances at the flight instruments. No more than 10 percent of the pilot's attention should be inside the cockpit. The pilot must develop the skill to instantly focus on the appropriate flight instrument, and then immediately return to outside reference to control the airplane's attitude.

The pilot should become familiar with the relationship between outside references to the natural horizon and the corresponding indications on flight instruments inside the cockpit. For example, a pitch attitude adjustment may require a movement of the pilot's reference point on the airplane of several inches in relation to the natural horizon, but correspond to a small fraction of an inch movement of the reference bar on the airplane's attitude indicator. Similarly, a deviation from desired bank, which is very obvious when referencing the wingtip's position relative to the natural horizon, may be nearly imperceptible on the airplane's attitude indicator to the beginning pilot.

The use of integrated flight instruction does not, and is not intended to prepare pilots for flight in instrument weather conditions. The most common error made by the beginning student is to make pitch or bank corrections while still looking inside the cockpit. Control pressure is applied, but the beginning pilot, not being familiar with the intricacies of flight by references to instruments, including such things as instrument lag and gyroscopic precession, will invariably make excessive attitude corrections and end up "chasing the instruments." Airplane attitude by reference to the natural horizon, however, is immediate in its indications, accurate, and presented many times larger than any instrument could be. Also, the beginning pilot must be made aware that anytime, for whatever reason, airplane attitude by reference to the natural horizon cannot be established and/or maintained, the situation should be considered a bona fide emergency.

## STRAIGHT-AND-LEVEL FLIGHT

It is impossible to emphasize too strongly the necessity for forming correct habits in flying straight and level. All other flight maneuvers are in essence a deviation from this fundamental flight maneuver. Many flight instructors and students are prone to believe that perfection in straight-and-level flight will come of itself, but such is not the case. It is not uncommon to find a pilot whose basic flying ability consistently falls just short of minimum expected standards, and upon analyzing the reasons for the shortcomings to discover that the cause is the inability to fly straight and level properly.

Straight-and-level flight is flight in which a constant heading and altitude are maintained. It is accomplished by making immediate and measured corrections for deviations in direction and altitude from unintentional slight turns, descents, and climbs. *Level flight*, at first, is a matter of consciously fixing the relationship of the position of some portion of the airplane, used as a reference point, with the horizon. In establishing the reference points, the instructor should place the airplane in the desired position and aid the student in selecting reference points. The instructor should be aware that no two pilots see this relationship exactly the same. The references will depend on where the pilot is sitting, the pilot's height (whether short or tall), and the pilot's manner of sitting. It is, therefore, important that during the fixing of this relationship, the pilot sit in a normal manner; otherwise the points will not be the same when the normal position is resumed.

In learning to control the airplane in level flight, it is important that the student be taught to maintain a light grip on the flight controls, and that the control forces desired be exerted lightly and just enough to produce the desired result. The student should learn to associate the apparent movement of the references with the forces which produce it. In this way, the student can develop the ability to regulate the change desired in the airplane's attitude by the amount and direction of forces applied to the controls without the necessity of referring to instrument or outside references for each minor correction.

The pitch attitude for *level flight* (constant altitude) is usually obtained by selecting some portion of the airplane's nose as a reference point, and then keeping that point in a fixed position relative to the horizon. [Figure 3-3] Using the principles of attitude flying, that position should be cross-checked occasionally against the altimeter to determine whether or not the pitch attitude is correct. If altitude is being gained or lost, the pitch attitude should be readjusted in relation to the horizon and then the altimeter rechecked to determine if altitude is now being maintained. The

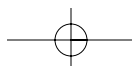



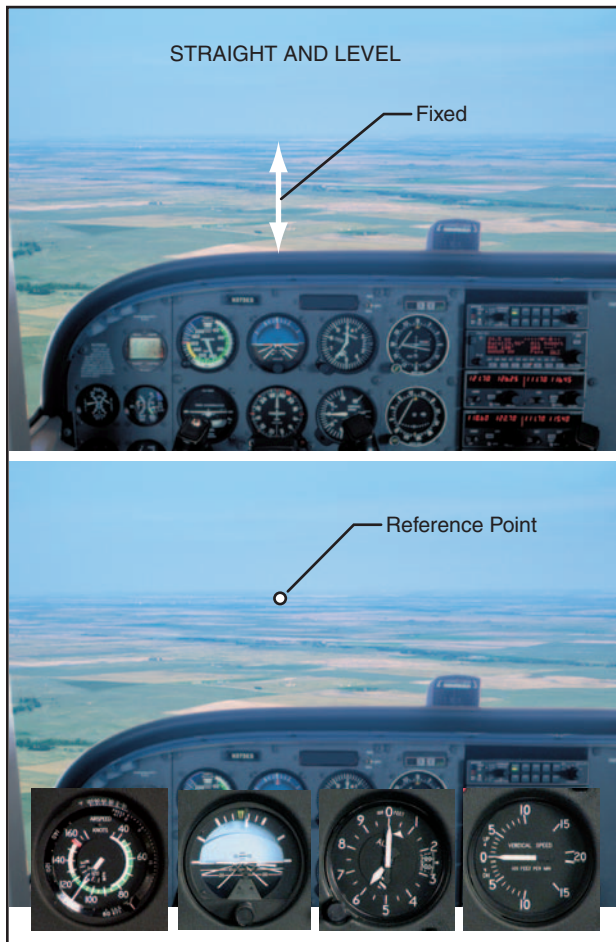
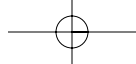

Figure 3-3. Nose reference for straight-and-level flight.

application of forward or back-elevator pressure is used to control this attitude.

The pitch information obtained from the attitude indicator also will show the position of the nose relative to the horizon and will indicate whether elevator pressure is necessary to change the pitch attitude to return to level flight. However, the primary reference source is the natural horizon.

In all normal maneuvers, the term “increase the pitch attitude” implies raising the nose in relation to the horizon; the term “decreasing the pitch attitude” means lowering the nose.

*Straight flight* (laterally level flight) is accomplished by visually checking the relationship of the airplane’s wingtips with the horizon. Both wingtips should be equidistant above or below the horizon (depending on whether the airplane is a high-wing or low-wing type), and any necessary adjustments should be made with the ailerons, noting the relationship of control pressure and the airplane’s attitude. [Figure 3-4] The student should understand that anytime the wings are banked, even though very slightly, the airplane will turn. The objective of straight-and-level flight is to detect small deviations from laterally level flight as soon as they occur, necessitating only small corrections. Reference to the heading indicator should be made to note any change in direction.



Figure 3-4. Wingtip reference for straight-and-level flight.

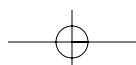

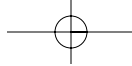

Continually observing the wingtips has advantages other than being the only positive check for leveling the wings. It also helps divert the pilot's attention from the airplane's nose, prevents a fixed stare, and automatically expands the pilot's area of vision by increasing the range necessary for the pilot's vision to cover. In practicing straight-and-level-flight, the wingtips can be used not only for establishing the airplane's laterally level attitude or bank, but to a lesser degree, its pitch attitude. This is noted only for assistance in learning straight-and-level flight, and is not a recommended practice in normal operations.

The scope of a student's vision is also very important, for if it is obscured the student will tend to look out to one side continually (usually the left) and consequently lean that way. This not only gives the student a biased angle from which to judge, but also causes the student to exert unconscious pressure on the controls in that direction, which results in dragging a wing.

With the wings approximately level, it is possible to maintain straight flight by simply exerting the necessary forces on the rudder in the desired direction. However, the instructor should point out that the practice of using rudder alone is not correct and may make precise control of the airplane difficult. Straight-and-level flight requires almost no application of control pressures if the airplane is properly trimmed and the air is smooth. For that reason, the student must not form the habit of constantly moving the controls unnecessarily. The student must learn to recognize when corrections are necessary, and then to make a measured response easily and naturally.

To obtain the proper conception of the forces required on the rudder during straight-and-level-flight, the airplane must be held level. One of the most common faults of beginning students is the tendency to concentrate on the nose of the airplane and attempting to hold the wings level by observing the curvature of the nose cowling. With this method, the reference line is very short and the deviation, particularly if very slight, can go unnoticed. Also, a very small deviation from level, by this short reference line, becomes considerable at the wingtips and results in an appreciable dragging of one wing. This attitude requires the use of additional rudder to maintain straight flight, giving a false conception of neutral control forces. The habit of dragging one wing, and compensating with rudder pressure, if allowed to develop is particularly hard to break, and if not corrected will result in considerable difficulty in mastering other flight maneuvers.

For all practical purposes, the airspeed will remain constant in straight-and-level flight with a constant power setting. Practice of intentional airspeed changes, by increasing or decreasing the power, will provide an

excellent means of developing proficiency in maintaining straight-and-level flight at various speeds. Significant changes in airspeed will, of course, require considerable changes in pitch attitude and pitch trim to maintain altitude. Pronounced changes in pitch attitude and trim will also be necessary as the flaps and landing gear are operated.

Common errors in the performance of straight-and-level flight are:

- Attempting to use improper reference points on the airplane to establish attitude.
- Forgetting the location of preselected reference points on subsequent flights.
- Attempting to establish or correct airplane attitude using flight instruments rather than outside visual reference.
- Attempting to maintain direction using only rudder control.
- Habitually flying with one wing low.
- "Chasing" the flight instruments rather than adhering to the principles of attitude flying.
- Too tight a grip on the flight controls resulting in overcontrol and lack of feel.
- Pushing or pulling on the flight controls rather than exerting pressure against the airstream.
- Improper scanning and/or devoting insufficient time to outside visual reference. (Head in the cockpit.)
- Fixation on the nose (pitch attitude) reference point.
- Unnecessary or inappropriate control inputs.
- Failure to make timely and measured control inputs when deviations from straight-and-level flight are detected.
- Inadequate attention to sensory inputs in developing feel for the airplane.

## TRIM CONTROL

The airplane is designed so that the primary flight controls (rudder, aileron, and elevator) are streamlined with the nonmovable airplane surfaces when the airplane is cruising straight-and-level at normal weight and loading. If the airplane is flying out of that basic balanced condition, one or more of the control surfaces is going to have to be held out of its streamlined position by continuous control input. The use of trim tabs relieves the pilot of this requirement. Proper trim technique is a very important and

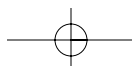

often overlooked basic flying skill. An improperly trimmed airplane requires constant control pressures, produces pilot tension and fatigue, distracts the pilot from scanning, and contributes to abrupt and erratic airplane attitude control.

Because of their relatively low power and speed, not all light airplanes have a complete set of trim tabs that are adjustable from the cockpit. In airplanes where rudder, aileron, and elevator trim are available, a definite sequence of trim application should be used. Elevator/stabilator should be trimmed first to relieve the need for control pressure to maintain constant airspeed/pitch attitude. Attempts to trim the rudder at varying airspeed are impractical in propeller driven airplanes because of the change in the torque correcting offset of the vertical fin. Once a constant airspeed/pitch attitude has been established, the pilot should hold the wings level with aileron pressure while rudder pressure is trimmed out. Aileron trim should then be adjusted to relieve any lateral control yoke pressure.

A common trim control error is the tendency to overcontrol the airplane with trim adjustments. To avoid this the pilot must learn to establish and hold the airplane in the desired attitude using the primary flight controls. The proper attitude should be established with reference to the horizon and then verified by reference to performance indications on the flight instruments. The pilot should then apply trim in the above sequence to relieve whatever hand and foot pressure had been required. The pilot must avoid using the trim to establish or correct airplane attitude. The airplane attitude must be established and held first, then control pressures trimmed out so that the airplane will maintain the desired attitude in “hands off” flight. Attempting to “fly the airplane with the trim tabs” is a common fault in basic flying technique even among experienced pilots.

A properly trimmed airplane is an indication of good piloting skills. Any control pressures the pilot feels should be a result of deliberate pilot control input during a planned change in airplane attitude, not a result of pressures being applied by the airplane because the pilot is allowing it to assume control.

## LEVEL TURNS

A turn is made by banking the wings in the direction of the desired turn. A specific angle of bank is selected by the pilot, control pressures applied to achieve the desired bank angle, and appropriate control pressures exerted to maintain the desired bank angle once it is established. [Figure 3-5]



Figure 3-5. Level turn to the left.

All four primary controls are used in close coordination when making turns. Their functions are as follows.

- The ailerons bank the wings and so determine the rate of turn at any given airspeed.
- The elevator moves the nose of the airplane up or down in relation to the pilot, and perpendicular to the wings. Doing that, it both sets the pitch attitude in the turn and “pulls” the nose of the airplane around the turn.
- The throttle provides thrust which may be used for airspeed to tighten the turn.
- The rudder offsets any yaw effects developed by the other controls. The rudder does not turn the airplane.

For purposes of this discussion, turns are divided into three classes: shallow turns, medium turns, and steep turns.

- Shallow turns are those in which the bank (less than approximately  $20^\circ$ ) is so shallow that the inherent lateral stability of the airplane is acting to level the wings unless some aileron is applied to maintain the bank.
- Medium turns are those resulting from a degree of bank (approximately  $20^\circ$  to  $45^\circ$ ) at which the airplane remains at a constant bank.

Steep turns are those resulting from a degree of bank ( $45^\circ$  or more) at which the “overbanking tendency” of an airplane overcomes stability, and the bank increases unless aileron is applied to prevent it.

Changing the direction of the wing’s lift toward one side or the other causes the airplane to be pulled in that direction. [Figure 3-6] Applying coordinated aileron and rudder to bank the airplane in the direction of the desired turn does this.

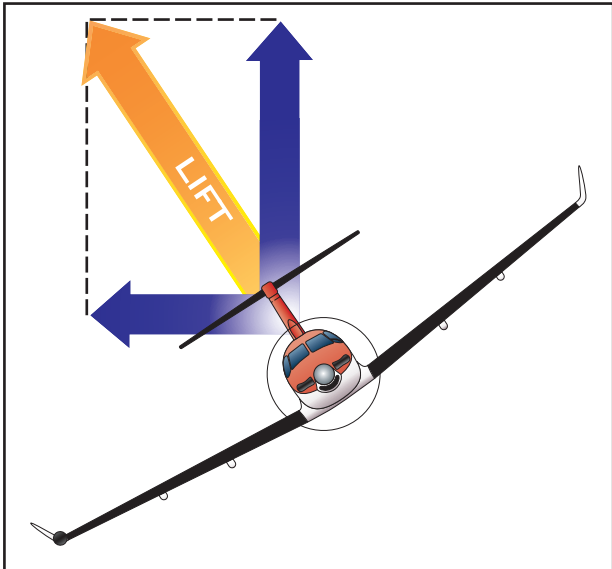

Figure 3-6. Change in lift causes airplane to turn.

When an airplane is flying straight and level, the total lift is acting perpendicular to the wings and to the Earth. As the airplane is banked into a turn, the lift then becomes the resultant of two components. One, the vertical lift component, continues to act perpendicular to the Earth and opposes gravity. Second, the horizontal lift component (centripetal) acts parallel to the Earth’s surface and opposes inertia (apparent centrifugal force). These two lift components act at right angles to each other, causing the resultant total lifting force to act perpendicular to the banked wing of the airplane. It is the horizontal lift component that actually turns the airplane—not the rudder. When applying aileron to bank the airplane, the lowered aileron (on the rising wing) produces a greater drag than the raised aileron (on the lowering wing). [Figure 3-7] This increased aileron yaws the airplane toward the rising wing, or opposite to the direction of turn. To counteract this adverse yawing moment, rudder pressure must be applied simultaneously with aileron in the desired direction of turn. This action is required to produce a coordinated turn.

After the bank has been established in a medium banked turn, all pressure applied to the aileron may be relaxed. The airplane will remain at the selected bank

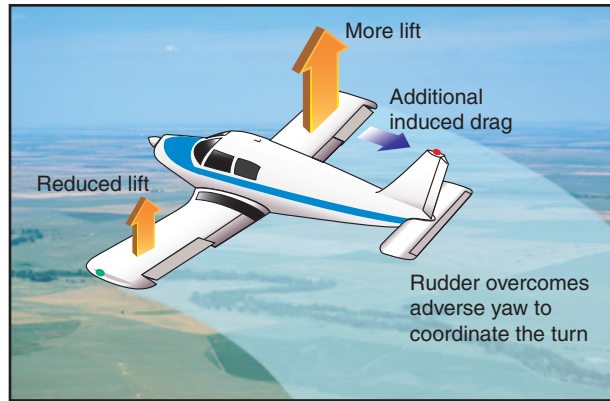

Figure 3-7. Forces during a turn.

with no further tendency to yaw since there is no longer a deflection of the ailerons. As a result, pressure may also be relaxed on the rudder pedals, and the rudder allowed to streamline itself with the direction of the slipstream. Rudder pressure maintained after the turn is established will cause the airplane to skid to the outside of the turn. If a definite effort is made to center the rudder rather than let it streamline itself to the turn, it is probable that some opposite rudder pressure will be exerted inadvertently. This will force the airplane to yaw opposite its turning path, causing the airplane to slip to the inside of the turn. The ball in the turn-and-slip indicator will be displaced off-center whenever the airplane is skidding or slipping sideways. [Figure 3-8] In proper coordinated flight, there is no skidding or slipping. An essential basic airmanship skill is the ability of the pilot to sense or “feel” any uncoordinated condition (slip or skid) without referring to instrument reference. During this stage of training, the flight instructor should stress the development of this ability and insist on its use to attain perfect coordination in all subsequent training.

In all constant altitude, constant airspeed turns, it is necessary to increase the angle of attack of the wing when rolling into the turn by applying up elevator. This is required because part of the vertical lift has been diverted to horizontal lift. Thus, the total lift must be increased to compensate for this loss.

To stop the turn, the wings are returned to level flight by the coordinated use of the ailerons and rudder applied in the opposite direction. To understand the relationship between airspeed, bank, and radius of turn, it should be noted that the rate of turn at any given true airspeed depends on the horizontal lift component. The horizontal lift component varies in proportion to the amount of bank. Therefore, the rate of turn at a given true airspeed increases as the angle of bank is increased. On the other hand, when a turn is made at a higher true airspeed at a given bank angle, the inertia is greater and the horizontal lift component required for the turn is greater, causing the turning rate

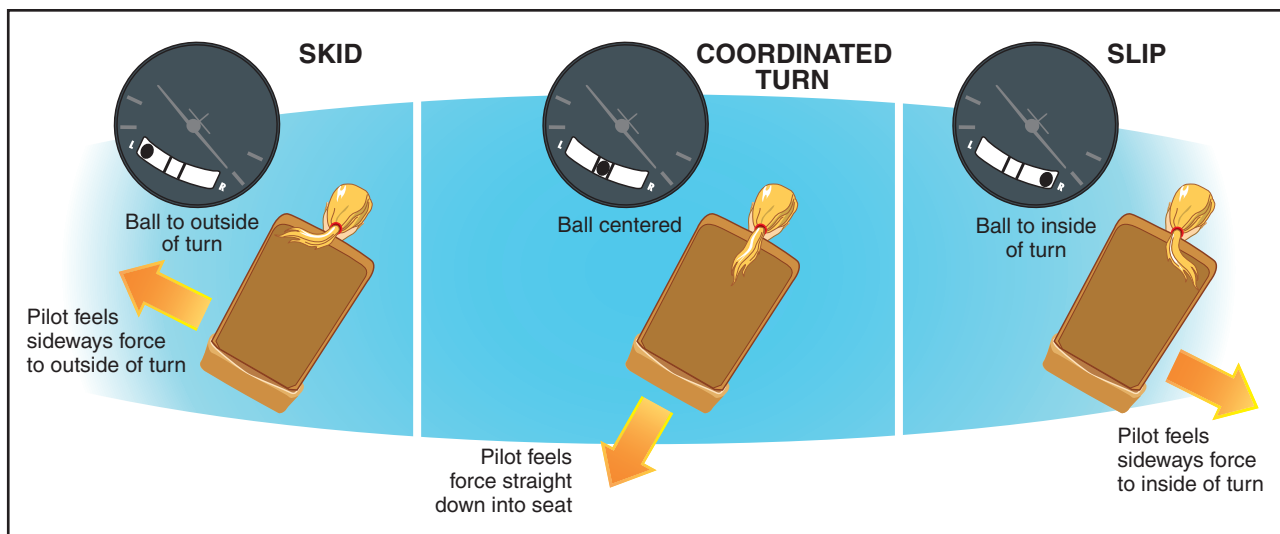

Figure 3-8. Indications of a slip and skid.

to become slower. [Figure 3-9 on next page] Therefore, at a given angle of bank, a higher true airspeed will make the radius of turn larger because the airplane will be turning at a slower rate.

When changing from a shallow bank to a medium bank, the airspeed of the wing on the outside of the turn increases in relation to the inside wing as the radius of turn decreases. The additional lift developed because of this increase in speed of the wing balances the inherent lateral stability of the airplane. At any given airspeed, aileron pressure is not required to maintain the bank. If the bank is allowed to increase from a medium to a steep bank, the radius of turn decreases further. The lift of the outside wing causes the bank to steepen and opposite aileron is necessary to keep the bank constant.

As the radius of the turn becomes smaller, a significant difference develops between the speed of the inside wing and the speed of the outside wing. The wing on the outside of the turn travels a longer circuit than the inside wing, yet both complete their respective circuits in the same length of time. Therefore, the outside wing travels faster than the inside wing, and as a result, it develops more lift. This creates an overbanking tendency that must be controlled by the use of the ailerons. [Figure 3-10] Because the outboard wing is developing more lift, it also has more induced drag. This causes a slight slip during steep turns that must be corrected by use of the rudder.

Sometimes during early training in steep turns, the nose may be allowed to get excessively low resulting in a significant loss in altitude. To recover, the pilot should first reduce the angle of bank with coordinated use of the rudder and aileron, then raise the nose of the airplane to level flight with the elevator. If recovery from an excessively nose-low steep bank condition is

attempted by use of the elevator only, it will cause a steepening of the bank and could result in overstressing the airplane. Normally, small corrections for pitch during steep turns are accomplished with the elevator, and the bank is held constant with the ailerons.

To establish the desired angle of bank, the pilot should use outside visual reference points, as well as the bank indicator on the attitude indicator.

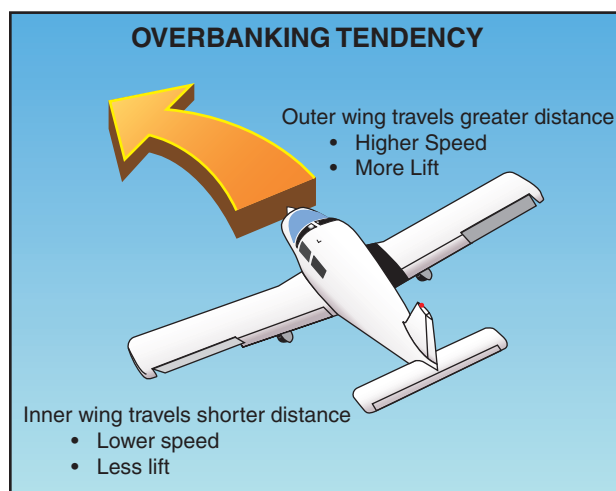

Figure 3-10. Overbanking tendency during a steep turn.

The best outside reference for establishing the degree of bank is the angle formed by the raised wing of low-wing airplanes (the lowered wing of high-wing airplanes) and the horizon, or the angle made by the top of the engine cowling and the horizon. [Figure 3-11 on page 3-11] Since on most light airplanes the engine cowling is fairly flat, its horizontal angle to the horizon will give some indication of the approximate degree of bank. Also, information obtained from the attitude indicator will show the angle of the wing in relation to the horizon. Information from the turn coordinator, however, will not.

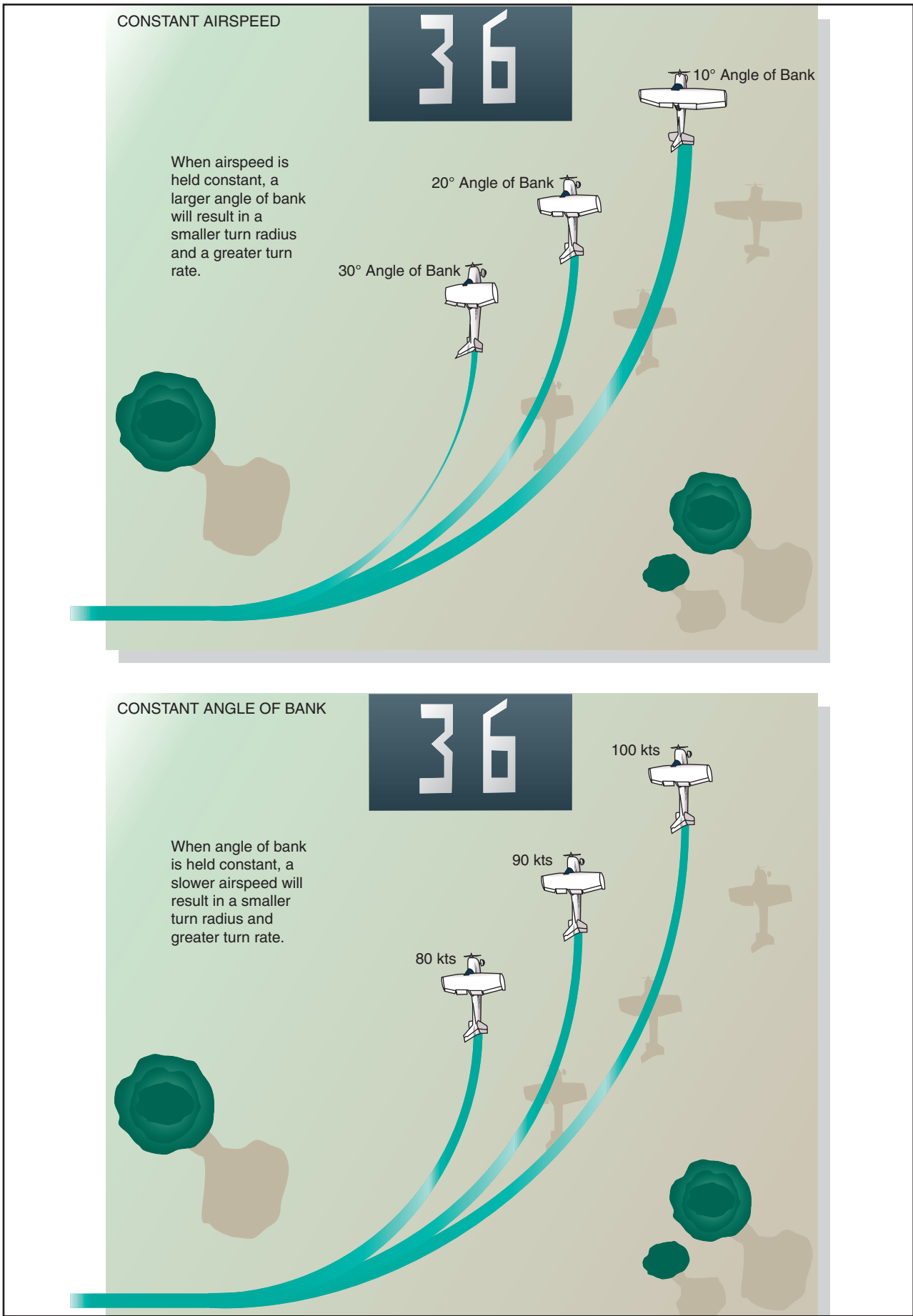
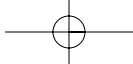

Figure 3-9. Angle of bank and airspeed regulate rate and radius of turn.

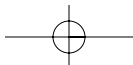



Figure 3-11. Visual reference for angle of bank.

The pilot's posture while seated in the airplane is very important, particularly during turns. It will affect the interpretation of outside visual references. At the beginning, the student may lean away from the turn in an attempt to remain upright in relation to the ground rather than ride with the airplane. This should be corrected immediately if the student is to properly learn to use visual references. [Figure 3-12]

Parallax error is common among students and experienced pilots. This error is a characteristic of airplanes that have side-by-side seats because the pilot is seated to one side of the longitudinal axis about which the airplane rolls. This makes the nose *appear* to rise when making a left turn and to descend when making right turns. [Figure 3-13]

Beginning students should not use large aileron and rudder applications because this produces a rapid roll rate and allows little time for corrections before the desired bank is reached. Slower (small control displacement) roll rates provide more time to make necessary pitch and bank corrections. As soon as the airplane rolls from the wings-level attitude, the nose should also start to move along the horizon, increasing its rate of travel proportionately as the bank is increased.

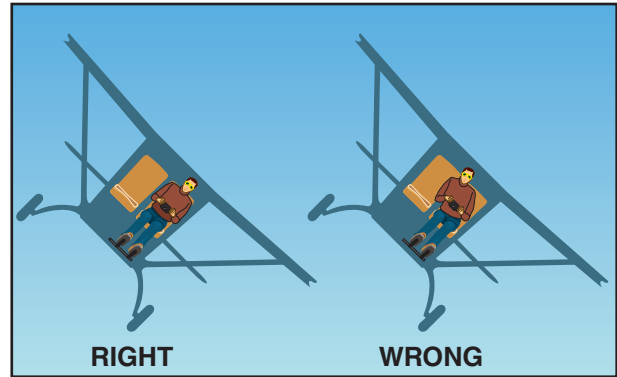

Figure 3-12. Right and wrong posture while seated in the airplane.

The following variations provide excellent guides.

- If the nose starts to move before the bank starts, rudder is being applied too soon.
- If the bank starts before the nose starts turning, or the nose moves in the opposite direction, the rudder is being applied too late.
- If the nose moves up or down when entering a bank, excessive or insufficient up elevator is being applied.

As the desired angle of bank is established, aileron and rudder pressures should be relaxed. This will stop the bank from increasing because the aileron and rudder control surfaces will be neutral in their streamlined position. The up-elevator pressure should not be relaxed, but should be held constant to maintain a constant altitude. Throughout the turn, the pilot should cross-check the airspeed indicator, and if the airspeed has decreased more than 5 knots, additional power should be used. The cross-check should also include outside references, altimeter, and vertical speed indicator (VSI), which can help determine whether or not the pitch attitude is correct. If gaining or losing altitude, the pitch attitude should be adjusted in relation to the horizon, and then the altimeter and VSI rechecked to determine if altitude is being maintained.



Figure 3-13. Parallax view.

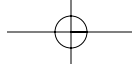

During all turns, the ailerons, rudder, and elevator are used to correct minor variations in pitch and bank just as they are in straight-and-level flight.

The rollout from a turn is similar to the roll-in except the flight controls are applied in the opposite direction. Aileron and rudder are applied in the direction of the rollout or toward the high wing. As the angle of bank decreases, the elevator pressure should be relaxed as necessary to maintain altitude.

Since the airplane will continue turning as long as there is any bank, the rollout must be started before reaching the desired heading. The amount of lead required to roll out on the desired heading will depend on the degree of bank used in the turn. Normally, the lead is one-half the degrees of bank. For example, if the bank is 30°, lead the rollout by 15°. As the wings become level, the control pressures should be smoothly relaxed so that the controls are neutralized as the airplane returns to straight-and-level flight. As the rollout is being completed, attention should be given to outside visual references, as well as the attitude and heading indicators to determine that the wings are being leveled and the turn stopped.

Instruction in level turns should begin with medium turns, so that the student has an opportunity to grasp the fundamentals of turning flight without having to deal with overbanking tendency, or the inherent stability of the airplane attempting to level the wings. The instructor should not ask the student to roll the airplane from bank to bank, but to change its attitude from level to bank, bank to level, and so on with a slight pause at the termination of each phase. This pause allows the airplane to free itself from the effects of any misuse of the controls and assures a correct start for the next turn. During these exercises, the idea of control forces, rather than movement, should be emphasized by pointing out the resistance of the controls to varying forces applied to them. The beginning student should be encouraged to use the rudder freely. Skidding in this phase indicates positive control use, and may be easily corrected later. The use of too little rudder, or rudder use in the wrong direction at this stage of training, on the other hand, indicates a lack of proper conception of coordination.

In practicing turns, the action of the airplane's nose will show any error in coordination of the controls. Often, during the entry or recovery from a bank, the nose will describe a vertical arc above or below the horizon, and then remain in proper position after the bank is established. This is the result of lack of timing and coordination of forces on the elevator and rudder controls during the entry and recovery. It indicates that the student has a knowledge of correct turns, but that entry and recovery techniques are in error.

3-12

Because the elevator and ailerons are on one control, and pressures on both are executed simultaneously, the beginning pilot is often apt to continue pressure on one of these unintentionally when force on the other only is intended. This is particularly true in left-hand turns, because the position of the hands makes correct movements slightly awkward at first. This is sometimes responsible for the habit of climbing slightly in right-hand turns and diving slightly in left-hand turns. This results from many factors, including the unequal rudder pressures required to the right and to the left when turning, due to the torque effect.

The tendency to climb in right-hand turns and descend in left-hand turns is also prevalent in airplanes having side-by-side cockpit seating. In this case, it is due to the pilot's being seated to one side of the longitudinal axis about which the airplane rolls. This makes the nose appear to rise during a correctly executed left turn and to descend during a correctly executed right turn. An attempt to keep the nose on the same apparent level will cause climbing in right turns and diving in left turns.

Excellent coordination and timing of all the controls in turning requires much practice. It is essential that this coordination be developed, because it is the very basis of this fundamental flight maneuver.

If the body is properly relaxed, it will act as a pendulum and may be swayed by any force acting on it. During a skid, it will be swayed away from the turn, and during a slip, toward the inside of the turn. The same effects will be noted in tendencies to slide on the seat. As the "feel" of flying develops, the properly directed student will become highly sensitive to this last tendency and will be able to detect the presence of, or even the approach of, a slip or skid long before any other indication is present.

Common errors in the performance of level turns are:

- Failure to adequately clear the area before beginning the turn.
- Attempting to execute the turn solely by instrument reference.
- Attempting to sit up straight, in relation to the ground, during a turn, rather than riding with the airplane.
- Insufficient feel for the airplane as evidenced by the inability to detect slips/skids without reference to flight instruments.
- Attempting to maintain a constant bank angle by referencing the "cant" of the airplane's nose.

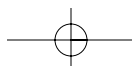





- Fixating on the nose reference while excluding wingtip reference.
- “Ground shyness”—making “flat turns” (skidding) while operating at low altitudes in a conscious or subconscious effort to avoid banking close to the ground.
- Holding rudder in the turn.
- Gaining proficiency in turns in only one direction (usually the left).
- Failure to coordinate the use of throttle with other controls.
- Altitude gain/loss during the turn.

## CLIMBS AND CLIMBING TURNS

When an airplane enters a climb, it changes its flightpath from level flight to an inclined plane or climb attitude. In a climb, weight no longer acts in a direction perpendicular to the flightpath. It acts in a rearward direction. This causes an increase in total drag requiring an increase in thrust (power) to balance the forces. An airplane can only sustain a climb angle when there is sufficient thrust to offset increased drag; therefore, climb is limited by the thrust available.

Like other maneuvers, climbs should be performed using outside visual references and flight instruments. It is important that the pilot know the engine power settings and pitch attitudes that will produce the following conditions of climb.

**NORMAL CLIMB**—Normal climb is performed at an airspeed recommended by the airplane manufacturer. Normal climb speed is generally somewhat higher than the airplane’s best rate of climb. The additional airspeed provides better engine cooling, easier control, and better visibility over the nose. Normal

climb is sometimes referred to as “cruise climb.” Complex or high performance airplanes may have a specified cruise climb in addition to normal climb.

**BEST RATE OF CLIMB**—Best rate of climb ( $V_Y$ ) is performed at an airspeed where the most excess *power* is available over that required for level flight. This condition of climb will produce the most gain in altitude in the least amount of time (maximum rate of climb in feet per minute). The best rate of climb made at full allowable power is a maximum climb. It must be fully understood that attempts to obtain more climb performance than the airplane is capable of by increasing pitch attitude will result in a *decrease* in the rate of altitude gain.

**BEST ANGLE OF CLIMB**—Best angle of climb ( $V_X$ ) is performed at an airspeed that will produce the most altitude gain in a given *distance*. Best angle-of-climb airspeed ( $V_X$ ) is considerably lower than best rate of climb ( $V_Y$ ), and is the airspeed where the most excess *thrust* is available over that required for level flight. The best angle of climb will result in a steeper climb *path*, although the airplane will take longer to reach the same altitude than it would at best rate of climb. The best angle of climb, therefore, is used in clearing obstacles after takeoff. [Figure 3-14]

It should be noted that, as altitude increases, the speed for best angle of climb increases, and the speed for best rate of climb decreases. The point at which these two speeds meet is the absolute ceiling of the airplane. [Figure 3-15 on next page]

A straight climb is entered by gently increasing pitch attitude to a predetermined level using back-elevator pressure, and simultaneously increasing engine power to the climb power setting. Due to an increase in downwash over the horizontal stabilizer as power is applied, the airplane’s nose will tend to immediately begin to rise of its own accord to an attitude higher than

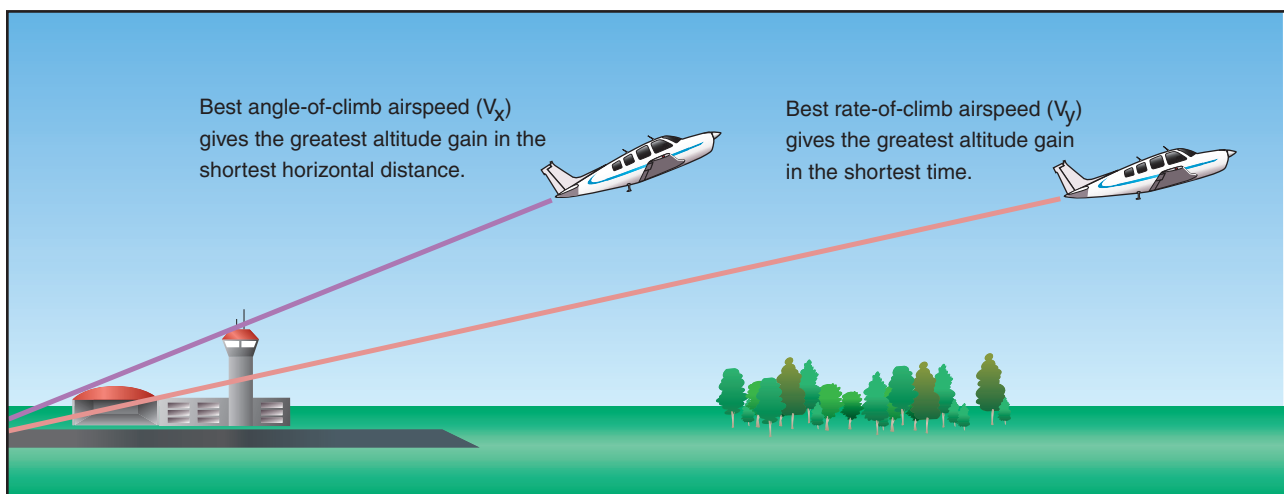
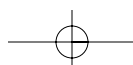

Figure 3-14. Best angle of climb vs. best rate of climb.



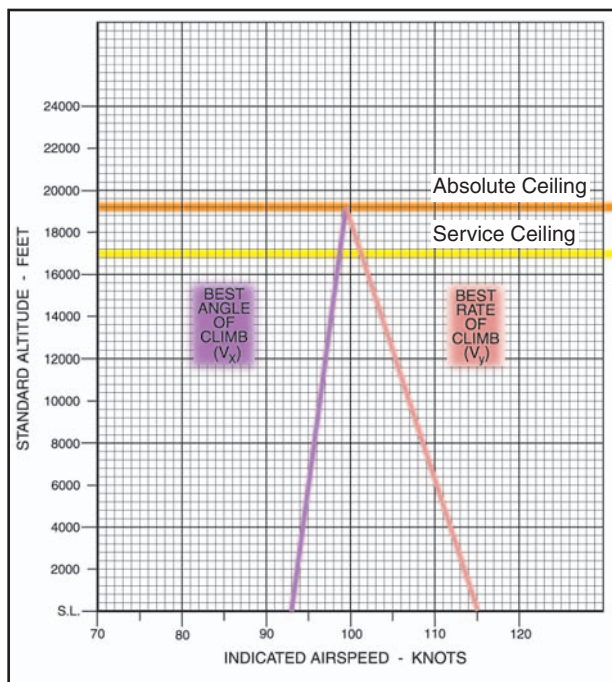

Figure 3-15. Absolute ceiling.

that at which it would stabilize. The pilot must be prepared for this.

As a climb is started, the airspeed will gradually diminish. This reduction in airspeed is gradual because of the initial momentum of the airplane. The thrust required to maintain straight-and-level flight at a given airspeed is not sufficient to maintain the same airspeed in a climb. Climbing flight requires more power than flying level because of the increased drag caused by gravity acting rearward. Therefore, power must be advanced to a higher power setting to offset the increased drag.

The propeller effects at climb power are a primary factor. This is because airspeed is significantly slower than at cruising speed, and the airplane's angle of attack is significantly greater. Under these conditions, torque and asymmetrical loading of the propeller will cause the airplane to roll and yaw to the left. To counteract this, the right rudder must be used.

During the early practice of climbs and climbing turns, this may make coordination of the controls seem awkward (left climbing turn holding right rudder), but after a little practice this correction for propeller effects will become instinctive.

Trim is also a very important consideration during a climb. After the climb has been established, the airplane should be trimmed to relieve all pressures from the flight controls. If changes are made in the pitch attitude, power, or airspeed, the airplane should be retrimmed in order to relieve control pressures.

When performing a climb, the power should be advanced to the climb power recommended by the manufacturer. If the airplane is equipped with a controllable-pitch propeller, it will have not only an engine tachometer, but also a manifold pressure gauge. Normally, the flaps and landing gear (if retractable) should be in the retracted position to reduce drag.

As the airplane gains altitude during a climb, the manifold pressure gauge (if equipped) will indicate a loss in manifold pressure (power). This is because the same volume of air going into the engine's induction system gradually decreases in density as altitude increases. When the volume of air in the manifold decreases, it causes a loss of power. This will occur at the rate of approximately 1-inch of manifold pressure for each 1,000-foot gain in altitude. During prolonged climbs, the throttle must be continually advanced, if constant power is to be maintained.

To enter the climb, simultaneously advance the throttle and apply back-elevator pressure to raise the nose of the airplane to the proper position in relation to the horizon. As power is increased, the airplane's nose will rise due to increased download on the stabilizer. This is caused by increased slipstream. As the pitch attitude increases and the airspeed decreases, progressively more right rudder must be applied to compensate for propeller effects and to hold a constant heading.

After the climb is established, back-elevator pressure must be maintained to keep the pitch attitude constant. As the airspeed decreases, the elevators will try to return to their neutral or streamlined position, and the airplane's nose will tend to lower. Nose-up elevator trim should be used to compensate for this so that the pitch attitude can be maintained without holding back-elevator pressure. Throughout the climb, since the power is fixed at the climb power setting, the airspeed is controlled by the use of elevator.

A cross-check of the airspeed indicator, attitude indicator, and the position of the airplane's nose in relation to the horizon will determine if the pitch attitude is correct. At the same time, a constant heading should be held with the wings level if a straight climb is being performed, or a constant angle of bank and rate of turn if a climbing turn is being performed. [Figure 3-16]

To return to straight-and-level flight from a climb, it is necessary to initiate the level-off at approximately 10 percent of the rate of climb. For example, if the airplane is climbing at 500 feet per minute (f.p.m.), leveling off should start 50 feet below the desired altitude. The nose must be lowered gradually because a loss of altitude will result if the pitch attitude is changed to the level flight position without allowing the airspeed to increase proportionately.



Figure 3-16. Climb indications.

After the airplane is established in level flight at a constant altitude, climb power should be retained temporarily so that the airplane will accelerate to the cruise airspeed more rapidly. When the speed reaches the desired cruise speed, the throttle setting and the propeller control (if equipped) should be set to the cruise power setting and the airplane trimmed. After allowing time for engine temperatures to stabilize, adjust the mixture control as required.

In the performance of climbing turns, the following factors should be considered.

- With a constant power setting, the same pitch attitude and airspeed cannot be maintained in a bank as in a straight climb due to the increase in the total lift required.
- The degree of bank should not be too steep. A steep bank significantly decreases the rate of climb. The bank should always remain constant.
- It is necessary to maintain a constant airspeed and constant rate of turn in both right and left turns. The coordination of all flight controls is a primary factor.
- At a constant power setting, the airplane will climb at a slightly shallower climb angle because some of the lift is being used to turn the airplane.
- Attention should be diverted from fixation on the airplane's nose and divided equally among inside and outside references.

There are two ways to establish a climbing turn. Either establish a straight climb and then turn, or enter the climb and turn simultaneously. Climbing turns should be used when climbing to the local practice area. Climbing turns allow better visual scanning, and it is easier for other pilots to see a turning aircraft.

In any turn, the loss of vertical lift and increased induced drag, due to increased angle of attack,

becomes greater as the angle of bank is increased. So shallow turns should be used to maintain an efficient rate of climb.

All the factors that affect the airplane during level (constant altitude) turns will affect it during climbing turns or any other training maneuver. It will be noted that because of the low airspeed, aileron drag (adverse yaw) will have a more prominent effect than it did in straight-and-level flight and more rudder pressure will have to be blended with aileron pressure to keep the airplane in coordinated flight during changes in bank angle. Additional elevator back pressure and trim will also have to be used to compensate for centrifugal force, for the loss of vertical lift, and to keep pitch attitude constant.

During climbing turns, as in any turn, the loss of vertical lift and induced drag due to increased angle of attack becomes greater as the angle of bank is increased, so shallow turns should be used to maintain an efficient rate of climb. If a medium or steep banked turn is used, climb performance will be degraded.

Common errors in the performance of climbs and climbing turns are:

- Attempting to establish climb pitch attitude by referencing the airspeed indicator, resulting in "chasing" the airspeed.
- Applying elevator pressure too aggressively, resulting in an excessive climb angle.
- Applying elevator pressure too aggressively during level-off resulting in negative "G" forces.
- Inadequate or inappropriate rudder pressure during climbing turns.
- Allowing the airplane to yaw in straight climbs, usually due to inadequate right rudder pressure.
- Fixation on the nose during straight climbs, resulting in climbing with one wing low.
- Failure to initiate a climbing turn properly with use of rudder and elevators, resulting in little turn, but rather a climb with one wing low.
- Improper coordination resulting in a slip which counteracts the effect of the climb, resulting in little or no altitude gain.
- Inability to keep pitch and bank attitude constant during climbing turns.
- Attempting to exceed the airplane's climb capability.

## DESCENTS AND DESCENDING TURNS

When an airplane enters a descent, it changes its flight-path from level to an inclined plane. It is important that

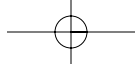

the pilot know the power settings and pitch attitudes that will produce the following conditions of descent.

**PARTIAL POWER DESCENT**—The normal method of losing altitude is to descend with partial power. This is often termed “cruise” or “enroute” descent. The airspeed and power setting recommended by the airplane manufacturer for prolonged descent should be used. The target descent rate should be 400–500 f.p.m. The airspeed may vary from cruise airspeed to that used on the downwind leg of the landing pattern. But the wide range of possible airspeeds should not be interpreted to permit erratic pitch changes. The desired airspeed, pitch attitude, and power combination should be preselected and kept constant.

**DESCENT AT MINIMUM SAFE AIRSPEED**—A minimum safe airspeed descent is a nose-high, power assisted descent condition principally used for clearing obstacles during a landing approach to a short runway. The airspeed used for this descent condition is recommended by the airplane manufacturer and normally is no greater than  $1.3 V_{SO}$ . Some characteristics of the minimum safe airspeed descent are a steeper than normal descent angle, and the excessive power that may be required to produce acceleration at low airspeed should “mushing” and/or an excessive rate of descent be allowed to develop.

**GLIDES**—A glide is a basic maneuver in which the airplane loses altitude in a controlled descent with little or no engine power; forward motion is maintained by gravity pulling the airplane along an inclined path and the descent rate is controlled by the pilot balancing the forces of gravity and lift.

Although glides are directly related to the practice of power-off accuracy landings, they have a specific operational purpose in normal landing approaches, and forced landings after engine failure. Therefore, it is necessary that they be performed more subconsciously than other maneuvers because most of the time during their execution, the pilot will be giving full attention to details other than the mechanics of performing the maneuver. Since glides are usually performed relatively close to the ground, accuracy of their execution and the formation of proper technique and habits are of special importance.

Because the application of controls is somewhat different in glides than in power-on descents, gliding maneuvers require the perfection of a technique somewhat different from that required for ordinary power-on maneuvers. This control difference is caused primarily by two factors—the absence of the usual propeller slipstream, and the difference in the relative effectiveness of the various control surfaces at slow speeds.

The glide ratio of an airplane is the distance the airplane will, with power off, travel forward in relation to the altitude it loses. For instance, if an airplane travels 10,000 feet forward while descending 1,000 feet, its glide ratio is said to be 10 to 1.

The glide ratio is affected by all four fundamental forces that act on an airplane (weight, lift, drag, and thrust). If all factors affecting the airplane are constant, the glide ratio will be constant. Although the effect of wind will not be covered in this section, it is a very prominent force acting on the gliding distance of the airplane in relationship to its movement over the ground. With a tailwind, the airplane will glide farther because of the higher groundspeed. Conversely, with a headwind the airplane will not glide as far because of the slower groundspeed.

Variations in weight do not affect the glide angle provided the pilot uses the correct airspeed. Since it is the lift over drag (L/D) ratio that determines the distance the airplane can glide, weight will not affect the distance. The glide ratio is based only on the relationship of the aerodynamic forces acting on the airplane. The only effect weight has is to vary the time the airplane will glide. The heavier the airplane the higher the airspeed must be to obtain the same glide ratio. For example, if two airplanes having the same L/D ratio, but different weights, start a glide from the same altitude, the heavier airplane gliding at a higher airspeed will arrive at the same touchdown point in a shorter time. Both airplanes will cover the same distance, only the lighter airplane will take a longer time.

Under various flight conditions, the drag factor may change through the operation of the landing gear and/or flaps. When the landing gear or the flaps are extended, drag increases and the airspeed will decrease unless the pitch attitude is lowered. As the pitch is lowered, the glidepath steepens and reduces the distance traveled. With the power off, a windmilling propeller also creates considerable drag, thereby retarding the airplane’s forward movement.

Although the propeller thrust of the airplane is normally dependent on the power output of the engine, the throttle is in the closed position during a glide so the thrust is constant. Since power is not used during a glide or power-off approach, the pitch attitude must be adjusted as necessary to maintain a constant airspeed.

The best speed for the glide is one at which the airplane will travel the greatest forward distance for a given loss of altitude in still air. This *best glide speed* corresponds to an angle of attack resulting in the least drag on the airplane and giving the best lift-to-drag ratio ( $L/D_{MAX}$ ). [Figure 3-17]

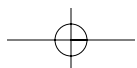

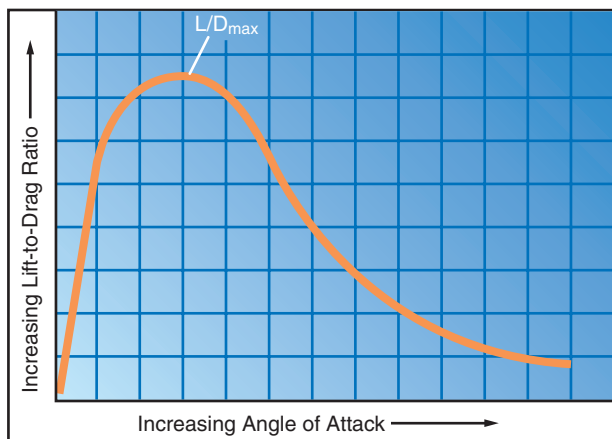

Figure 3-17.  $L/D_{MAX}$ .

Any change in the gliding airspeed will result in a proportionate change in glide ratio. Any speed, other than the best glide speed, results in more drag. Therefore, as the glide airspeed is reduced or increased from the optimum or best glide speed, the glide ratio is also changed. When descending at a speed below the best glide speed, induced drag increases. When descending at a speed above best glide speed, parasite drag increases. In either case, the rate of descent will increase. [Figure 3-18]

This leads to a cardinal rule of airplane flying that a student pilot must understand and appreciate: The pilot must never attempt to “stretch” a glide by applying back-elevator pressure and reducing the airspeed below the airplane’s recommended best glide speed. Attempts to stretch a glide will invariably result in an increase in the rate and angle of descent and may precipitate an inadvertent stall.

To enter a glide, the pilot should close the throttle and advance the propeller (if so equipped) to low pitch (high r.p.m.). A constant altitude should be held with back pressure on the elevator control until the airspeed decreases to the recommended glide speed. Due to a decrease in downwash over the horizontal stabilizer as power is reduced, the airplane’s nose will tend to immediately begin to lower of its own accord to an atti-

tude lower than that at which it would stabilize. The pilot must be prepared for this. To keep pitch attitude constant after a power change, the pilot must counteract the immediate trim change. If the pitch attitude is allowed to decrease during glide entry, excess speed will be carried into the glide and retard the attainment of the correct glide angle and airspeed. Speed should be allowed to dissipate before the pitch attitude is decreased. This point is particularly important in so-called clean airplanes as they are very slow to lose their speed and any slight deviation of the nose downwards results in an immediate increase in airspeed. Once the airspeed has dissipated to normal or best glide speed, the pitch attitude should be allowed to decrease to maintain that speed. This should be done with reference to the horizon. When the speed has stabilized, the airplane should be retrimmed for “hands off” flight.

When the approximate gliding pitch attitude is established, the airspeed indicator should be checked. If the airspeed is higher than the recommended speed, the pitch attitude is too low, and if the airspeed is less than recommended, the pitch attitude is too high; therefore, the pitch attitude should be readjusted accordingly referencing the horizon. After the adjustment has been made, the airplane should be retrimmed so that it will maintain this attitude without the need to hold pressure on the elevator control. *The principles of attitude flying require that the proper flight attitude be established using outside visual references first, then using the flight instruments as a secondary check.* It is a good practice to always retrim the airplane after each pitch adjustment.

A stabilized power-off descent at the best glide speed is often referred to as a *normal* glide. The flight instructor should demonstrate a normal glide, and direct the student pilot to memorize the airplane’s angle and speed by visually checking the airplane’s attitude with reference to the horizon, and noting the pitch of the sound made by the air passing over the structure, the pressure on the controls, and the feel of

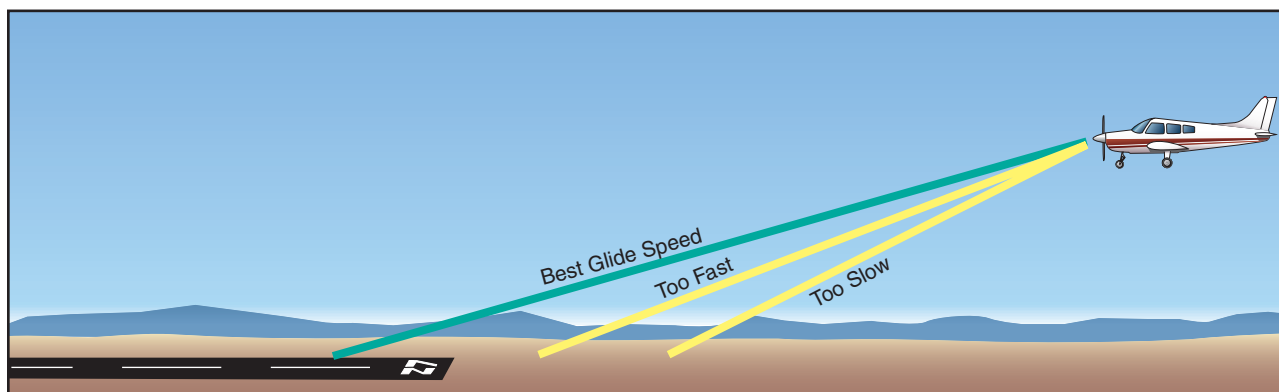
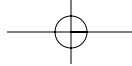

Figure 3-18. Best glide speed provides the greatest forward distance for a given loss of altitude.



the airplane. Due to lack of experience, the beginning student may be unable to recognize slight variations of speed and angle of bank immediately by vision or by the pressure required on the controls. Hearing will probably be the indicator that will be the most easily used at first. The instructor should, therefore, be certain that the student understands that an increase in the pitch of sound denotes increasing speed, while a decrease in pitch denotes less speed. When such an indication is received, the student should consciously apply the other two means of perception so as to establish the proper relationship. The student pilot must use all three elements consciously until they become habits, and must be alert when attention is diverted from the attitude of the airplane and be responsive to any warning given by a variation in the feel of the airplane or controls, or by a change in the pitch of the sound.

After a good comprehension of the normal glide is attained, the student pilot should be instructed in the differences in the results of normal and “abnormal” glides. Abnormal glides being those conducted at speeds other than the normal best glide speed. Pilots who do not acquire an understanding and appreciation of these differences will experience difficulties with accuracy landings, which are comparatively simple if the fundamentals of the glide are thoroughly understood.

Too fast a glide during the approach for landing invariably results in floating over the ground for varying distances, or even overshooting, while too slow a glide causes undershooting, flat approaches, and hard touchdowns. A pilot without the ability to recognize a normal glide will not be able to judge where the airplane will go, or can be made to go, in an emergency. Whereas, in a normal glide, the flight-path may be sighted to the spot on the ground on which the airplane will land. This cannot be done in any abnormal glide.

**GLIDING TURNS**—The action of the control system is somewhat different in a glide than with power, making gliding maneuvers stand in a class by themselves and require the perfection of a technique different from that required for ordinary power maneuvers. The control difference is caused mainly by two factors—the absence of the usual slipstream, and the difference or relative effectiveness of the various control surfaces at various speeds and particularly at reduced speed. The latter factor has its effect exaggerated by the first, and makes the task of coordination even more difficult for the inexperienced pilot. These principles should be thoroughly explained in order that the student may be alert to the necessary differences in coordination.

After a feel for the airplane and control touch have been developed, the necessary compensation will be

automatic; but while any mechanical tendency exists, the student will have difficulty executing gliding turns, particularly when making a practical application of them in attempting accuracy landings.

Three elements in gliding turns which tend to force the nose down and increase glide speed are:

- Decrease in effective lift due to the direction of the lifting force being at an angle to the pull of gravity.
- The use of the rudder acting as it does in the entry to a power turn.
- The normal stability and inherent characteristics of the airplane to nose down with the power off.

These three factors make it necessary to use more back pressure on the elevator than is required for a straight glide or a power turn and, therefore, have a greater effect on the relationship of control coordination.

When recovery is being made from a gliding turn, the force on the elevator control which was applied during the turn must be decreased or the nose will come up too high and considerable speed will be lost. This error will require considerable attention and conscious control adjustment before the normal glide can again be resumed.

In order to maintain the most efficient or normal glide in a turn, more altitude must be sacrificed than in a straight glide since this is the only way speed can be maintained without power. Turning in a glide decreases the performance of the airplane to an even greater extent than a normal turn with power.

Still another factor is the difference in rudder action in turns with and without power. In power turns it is required that the desired recovery point be anticipated in the use of controls and that considerably more pressure than usual be exerted on the rudder. In the recovery from a gliding turn, the same rudder action takes place but without as much pressure being necessary. The actual displacement of the rudder is approximately the same, but it seems to be less in a glide because the resistance to pressure is so much less due to the absence of the propeller slipstream. This often results in a much greater application of rudder through a greater range than is realized, resulting in an abrupt stoppage of the turn when the rudder is applied for recovery. This factor is particularly important during landing practice since the student almost invariably recovers from the last turn too soon and may enter a cross-control condition trying to correct the landing with the rudder alone. This results in landing from a skid that is too easily mistaken for drift.

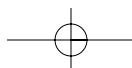

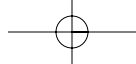

There is another danger in excessive rudder use during gliding turns. As the airplane skids, the bank will increase. This often alarms the beginning pilot when it occurs close to the ground, and the pilot may respond by applying aileron pressure toward the outside of the turn to stop the bank. At the same time, the rudder forces the nose down and the pilot may apply back-elevator pressure to hold it up. If allowed to progress, this situation may result in a fully developed cross-control condition. A stall in this situation will almost certainly result in a spin.

The level-off from a glide must be started before reaching the desired altitude because of the airplane's downward inertia. The amount of lead depends on the rate of descent and the pilot's control technique. With too little lead, there will be a tendency to descend below the selected altitude. For example, assuming a 500-foot per minute rate of descent, the altitude must be led by 100 – 150 feet to level off at an airspeed higher than the glide speed. At the lead point, power should be increased to the appropriate level flight cruise setting so the desired airspeed will be attained at the desired altitude. The nose tends to rise as both airspeed and downwash on the tail section increase. The pilot must be prepared for this and smoothly control the pitch attitude to attain level flight attitude so that the level-off is completed at the desired altitude.

Particular attention should be paid to the action of the airplane's nose when recovering (and entering) gliding turns. The nose must not be allowed to describe an arc with relation to the horizon, and particularly it must not be allowed to come up during recovery from turns, which require a constant variation of the relative pressures on the different controls.

Common errors in the performance of descents and descending turns are:

- Failure to adequately clear the area.
- Inadequate back-elevator control during glide entry resulting in too steep a glide.
- Failure to slow the airplane to approximate glide speed prior to lowering pitch attitude.
- Attempting to establish/maintain a normal glide solely by reference to flight instruments.
- Inability to sense changes in airspeed through sound and feel.
- Inability to stabilize the glide (chasing the airspeed indicator).
- Attempting to “stretch” the glide by applying back-elevator pressure.
- Skidding or slipping during gliding turns due to inadequate appreciation of the difference in rudder action as opposed to turns with power.
- Failure to lower pitch attitude during gliding turn entry resulting in a decrease in airspeed.
- Excessive rudder pressure during recovery from gliding turns.
- Inadequate pitch control during recovery from straight glides.
- “Ground shyness”—resulting in cross-controlling during gliding turns near the ground.
- Failure to maintain constant bank angle during gliding turns.

## PITCH AND POWER

No discussion of climbs and descents would be complete without touching on the question of what controls altitude and what controls airspeed. The pilot must understand the effects of both power and elevator control, working together, during different conditions of flight. The closest one can come to a formula for determining airspeed/altitude control that is valid under all circumstances is a basic principle of attitude flying which states:

“At any pitch attitude, the amount of power used will determine whether the airplane will climb, descend, or remain level at that attitude.”

Through a wide range of nose-low attitudes, a descent is the only possible condition of flight. The addition of power at these attitudes will only result in a greater rate of descent at a faster airspeed.

Through a range of attitudes from very slightly nose-low to about 30° nose-up, a typical light airplane can be made to climb, descend, or maintain altitude depending on the power used. In about the lower third of this range, the airplane will descend at idle power without stalling. As pitch attitude is increased, however, engine power will be required to prevent a stall. Even more power will be required to maintain altitude, and even more for a climb. At a pitch attitude approaching 30° nose-up, all available power will provide only enough thrust to maintain altitude. A slight increase in the steepness of climb or a slight decrease in power will produce a descent. From that point, the least inducement will result in a stall.

