



*LMQ*

---

# Operators Manual

---



Phone (207) 899-1714

Fax (207) 228-1890

[www.infinitysolutionsmfg.com](http://www.infinitysolutionsmfg.com)



Infinity Solutions Manufacturing

192 Gannett Drive South Portland, ME 04106

(207) 899-1714

## A Message to Our Customers

---

Thank you for purchasing the **LMQ**. This **Pressure Seal System** is the result of over 30 years of experience in the document processing industry. Through interfacing with customers like yourself and from hands-on experience in the field our **Research and Development Team** has focused on a solution that provides both the dependability you expect from today's technology while returning operational efficiency to your organization.

The result of our experience and research is a powerful tool to improve your bottom line. We hope that you enjoy the product. User comments and suggestions are always welcomed by our development team.

- Vestido apropiadamente. Nunca funcione la unidad con la ropa floja, joyería, y contenga el pelo largo. Los artículos flojos tales como ropa, joyería, y pelo largo podían conseguir en las piezas móviles que causaban daños corporales.
- Advertencia: No funcione el sistema del sello de presión mientras que cualquiera cubre o las placas se quita del dobléz. Si despejando un atasco de papel, siga por favor terminantemente las líneas de la guía en la sección de la investigación de averías del manual.

## Seguridad Del Operador

- **Repase y siga por favor todas las medidas de seguridad para asegurar la operación segura del equipo.** El usuario es responsable de condiciones de funcionamiento seguras.
- ⚠ **Advertencia:** No procure manejar el equipo solamente. Él requiere a dos personas manejar y levantar el equipo del empaquetado.
- ⚠ **Advertencia:** esta unidad contiene piezas móviles de trabajo. Reloj para las etiquetas engomadas de la precaución, de la advertencia, del grado eléctrico para las condiciones de funcionamiento apropiadas y la seguridad del usuario (símbolos enumerados abajo)
- **Nunca quite los protectores o los interruptores de la seguridad del producto.** El retiro de protectores o del interruptor hará la unidad funcionar incorrectamente y podría dar lugar a daños corporales.
- **Tape el cable eléctrico en 115 VAC 60 hertzios de enchufe.** El voltaje hasta 120 voltios puede estar presente dentro de la unidad del sello de presión.
- **El cable eléctrico y el enchufe deben ser accesibles para la desconexión siempre.**
- **Sepa apagar la unidad del sello de presión en caso de que de la emergencia.**
- **Esta unidad se equipa de una cuerda eléctrica puesta a tierra 3 alambres.** Si se daña la cuerda de la fuente, debe ser substituida por una cuerda especial disponible del fabricante o de su agente del servicio.
- **Guarde todas las manos, dedos, y objetos ausentes de piezas móviles.** Nunca procure alcanzar en la máquina con la energía encendido. Dé vuelta a la energía apagado y desconecte el cable eléctrico antes de la limpieza o del mantenimiento del producto. Lesión puede ocurrir si las instrucciones apropiadas no se siguen.
- Todo el mantenimiento en piezas se debe realizar solamente cerca y técnico autorizado del servicio de Infinity Solutions usando solamente piezas de recambio aprobadas Infinity Solutions.
- Mantenga el producto ausente de calor extremo o de condiciones mojadas.
- Alarma de la estancia. Nunca funcione la unidad mientras que está cansado, soñoliento, o bajo influencia de la medicación, de drogas o del alcohol. La falta de seguir estas instrucciones podría causar daños corporales severos.

## Operator Safety

Parlez-Vous Francias? Voir page 16

Hablas Espanol? Ver Página 18

- **Please review and follow all the safety precautions to ensure safe equipment operation.** The user is responsible for safe operating conditions. Read all operating instructions prior to operating machine.
- ⚠ **Warning:** Do not attempt to handle the equipment alone. It requires two people to handle and lift the equipment out of the packaging.
- ⚠ **Warning:** This unit contains moving parts. Watch for **Caution**, **Warning**, and **Electrical** stickers detailing proper operating conditions and user safety.
- **Never remove guards or product safety switches.** Removal of guards or switches will cause the unit to run improperly and can result in personal injury.
- **Keep all hands, fingers and objects away from moving parts.** Never attempt to reach into the machine while the power is on. Turn off the machine and disconnect the power cord before cleaning or servicing the machine, and before removing either fold plate. Injury may occur if proper operating procedure is not followed.
- **Plug the power cord into 115 VAC 60 Hz outlet only.** Voltage up to 120 volts will not damage the machine. (Acceptable voltage range is 110 volts to 120 volts maximum)
- The Power Cord and Plug must be accessible at all times for disconnection.
- This unit is equipped with a 3-Wire grounded electrical cord. If the cord becomes damaged and needs to be replaced, it must be replaced with an authorized part available through the manufacturer or an authorized service agent.
- All machine maintenance should be performed only by factory authorized service personnel using factory authorized replacement parts. Contact your reseller for more information.
- Keep product away from extreme heat & moisture.
- Never operate Machine while tired, drowsy, or under the influence of medication, drugs, or alcohol. Failure to do so can result in personal injury.

Never operate unit with loose clothing or jewelry. Contain all long hair and neck ties prior to operating machine. Failure to do so could result in clothing, jewelry, or hair becoming entangled in moving parts

# Table of Contents

---

<b>A Message to Our Customers</b> .....	<b>ii</b>
<b>Operator Safety</b> .....	<b>iii</b>
<b>Table of Contents</b> .....	<b>iv</b>
<b>Introduction</b> .....	<b>1</b>
<b>Unpacking &amp; Setup</b> .....	<b>2</b>
Unpacking .....	2
Setup .....	3
<b>Machine Overview</b> .....	<b>4</b>
Machine Diagram .....	4
Capabilities .....	4
Fold Plates .....	5
<b>Machine Operation</b> .....	<b>6</b>
Identifying Your Fold .....	6
Feed Table Setup .....	6
Setting the Paper Guide Width .....	6
Setting the Feed Gauge .....	7
Loading the Feed Table .....	8
Setting the Fold Plates .....	9
Running the LMQ .....	10
<b>Maintenance</b> .....	<b>11</b>
<b>Troubleshooting</b> .....	<b>12</b>
Automatically Clearing a Paper Jam .....	12
Manually Clearing a Paper Jam .....	12
Diagnosing the Paper Jam .....	13
Misaligned Folds .....	13
Paper Feed Problems .....	14
Double Feeds .....	14
Won't Feed .....	14
Machine Won't Run .....	15
<b>Sûreté D'Opérateur</b> .....	<b>16</b>
<b>Seguridad Del Operador</b> .....	<b>18</b>

- Robe convenablement. N'actionnez jamais l'unité avec l'habillement lâche, bijoux, et contenez les longs cheveux. Les articles lâches tels que l'habillement, les bijoux, et les longs cheveux ont pu obtenir dans les pièces mobiles causant des blessures.
- Avertissement : N'actionnez pas le système de joint de pression tandis qu'en couvre ou des plats de pli sont enlevés. Si en dégagant un bourrage papier, suivez svp strictement les lignes de guide dans la section de dépannage du manuel.

## Sûreté D'Opérateur

- **Passez en revue et veuillez suivez toutes les mesures de sécurité pour assurer l'opération sûre d'équipement.** L'utilisateur est responsable des conditions de fonctionnement sûres.
- ⚠ **Avertissement:** N'essayez pas de manipuler seul l'équipement. Il exige de deux personnes de manipuler et soulever l'équipement hors de l'emballage.
- ⚠ **Avertissement:** cette unité contient les pièces mobiles fonctionnantes. Montre pour des autocollants d'attention, d'avertissement, d'estimation électrique pour des conditions de fonctionnement appropriées et la sûreté d'utilisateur (symboles énumérés ci-dessous)
- **N'enlevez jamais les gardes ou les commutateurs de sécurité du produit.** Le déplacement des gardes ou du commutateur fera fonctionner l'unité incorrectement et a pu avoir comme conséquence des blessures.
- **Branchez le cordon de secteur à des 115 VCA 60 hertz de sortie.** La tension jusqu'à 120 volts peut être présente dans l'unité de joint de pression.
- **Le cordon et la prise de secteur doivent être accessibles pour le débranchage à tout moment.**
- **Savez couper l'unité de joint de pression en cas d'urgence.**
- **Cette unité est équipée d'une corde électrique fondée 3 par fils.** Si la corde d'approvisionnement est endommagée, elle doit être remplacée par une corde spéciale fournie par le fabricant ou son agent de service.
- **Gardez tous les mains, doigts, et objets partis des pièces mobiles.** N'essayez jamais d'atteindre dans la machine avec la puissance dessus. Coupez le courant et débranchez le cordon de secteur avant le nettoyage ou l'entretien de produit. Les dommages peuvent se produire si des instructions appropriées ne sont pas suivies.
- Tout l'entretien sur des pièces devrait seulement être exécuté près et technicien autorisé de service de Infinity Solutions en utilisant seulement les pièces de rechange approuvées par Infinity Solutions.
- Maintenez le produit parti de la chaleur extrême ou des conditions humides.
- Alerte de séjour. N'actionnez jamais l'unité tandis que fatigué, assoupi, ou sous l'influence du médicament, des drogues ou de l'alcool. Le manque de suivre ces instructions a pu causer des blessures graves.

## Introduction

The **LMQ** is designed to fold and seal perforated pressure seal self mailers only and can process up to 3000 documents per hour. Patented folding & sealing technologies ensure a good seal on every form and a clean fold every time. The adjustable fold plates allow the machine to meet your changing document processing requirements. Below are the detailed machine specs.

<b>Feed System</b>	Bottom Feed Friction Belt	
<b>Drive System</b>	A.C. Fixed	
<b>Electrical</b>	115V AC 60 Hz 3A	
<b>Paper Sizes</b>	Length up to 14", width up to 8.5"	
<b>Fold Patterns</b>	11" Half (V) 11" Letter (C) 11" Eccentric C 11" Z 11" Eccentric Z (EZ)	14" Half (V) 14" C 14" Return Envelope (EC) 14" Z 14" Eccentric Z (EZ)
<b>Speed</b>	3000 Documents Per Hour Fixed Continuous	
<b>Duty Cycle</b>	25,000 Per Month	
<b>Dimensions</b>	Height 14", Width 12", Depth 19"	
<b>Weight</b>	65 Lbs.	

## Unpacking & Setup

### Unpacking

When opening the **LMQ** packaging, inspect it for any shipping damage. The shipper should be notified at once if there is any serious damage. Please keep packing material for depot service return shipment.

- ⚠ **Warning:** Do not attempt to remove the equipment from the packaging alone. Two people are required at all times to move the equipment.
- ⚠ **Avertissement:** N'essayez pas de manipuler seul l'équipement. Il exige de deux personnes de manipuler et soulever l'équipement hors de l'emballage.
- ⚠ **Advertencia:** No procure manejar el equipo solamente. Requiere a dos personas manejar & levantar el equipo del empaquetado.

Ensure that the following items are present in the packaging:

1. This manual (1)
2. Infinity Solutions® LMQ (1)
3. AC Power Cord (1)
4. Upper & Lower Fold Plates (1 each)
5. Catch Tray
6. Tool Kit
  - a. Breaker bar &  $\frac{7}{16}$ " Socket
  - b.  $\frac{3}{16}$ " T-Handle Hex Driver

If any items are missing please contact your reseller before continuing.

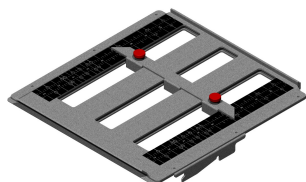

Figure 1: Upper Fold Plate

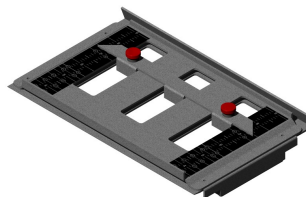

Figure 2: Lower Fold Plate



Figure 3: LMQ

### Machine Won't Run

If your machine won't run when the run/stop switch is operated:

1. Check that the machine **Breaker Power Switch** is not in the tripped position. If it is, press it in. If the breaker button will not stay pressed in, wait a minute and try again.
2. Check that the **Access Panel** on the side cover opposite the control panel is properly in place.
3. Make sure the power switch by the power cord is in the **On** position.
4. Double-check that the power cord is properly connected to the machine and an appropriate socket [see Machine Setup].
5. Check that the wall socket which the machine is connected to is functioning properly.

**NOTE: Intermittent or Inconsistent Voltage from the power source can cause a number of operating issues with this equipment and a constant 115V AC at 60hz is required.**

Once you've identified which fold plate needs to be adjusted, remove it from the machine. If the fold is crooked, check to make sure that the paper stop is parallel to the front edge of the fold plate. Check that the indicator points on the paper stop indicate the same reading on the two scales of the fold plate. Also check the feed table to make sure that paper guides are snug against the paper stack.

If the fold is just a bit off of the perforation, adjust the paper stop by the amount that the fold is off. If the fold is happening early, then move the paper stop away from the open end of the fold plate. If the fold is happening late, then move the paper stop towards the open end of the fold plate.

## Paper Feed Problems

### Double Feeds

If you're having problems feeding two forms at a time occasionally:

1. Turn the **Feed Gauge Adjustment Screw** [see Figure 10] ¼ turn counter-clockwise.
2. Try running the forms again.
3. If the problem persists:
  - a) Try another ¼ turn on the **Feed Gauge Adjustment Screw**.
  - b) Try reducing the size of the paper stack on the **Feed Table**.
  - c) Try resetting the **Feed Gauge**.

### Won't Feed

If your machine won't feed forms through:

1. Try reducing the size of the paper stack on the **Feed Table**.
2. Try resetting the **Feed Gauge**.

## Setup

- ⚠ **Warning:** Do not attempt to remove the equipment from the packaging alone. Two people are required at all times to move the equipment.
- ⚠ **Avertissement:** N'essayez pas de manipuler seul l'équipement. Il exige de deux personnes de manipuler et soulever l'équipement hors de l'emballage.
- ⚠ **Advertencia:** No procure manejar el equipo solamente. Requiere a dos personas manejar & levantar el equipo del empaquetado.

Place the **LMQ** on a sturdy table or cart. Check to verify that both fold plates are properly installed [see Figure 4 & 5]. Both fold plates should rest snugly on the placement pins.



Figure 4: Upper Fold Plate in Proper Position

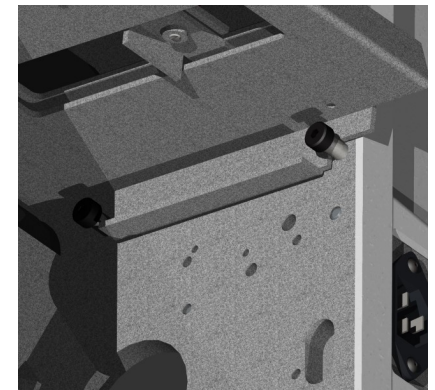

Figure 5: Lower Fold Plate in Proper Position

Insert the power cord into the machine first, and then into a standard 115V AC 60 Hz outlet.

- ⚠ The power cord must be accessible for disconnect.
- ⚠ **Avertissement:** Le cordon et la prise de secteur doivent être accessibles pour le débranchage à tout moment. Si le cordon de secteur est les dommages sont doivent être remplacés avec la corde d'approbation de fabricants pour assurer des estimations appropriées de tension.
- ⚠ **Advertencia:** El cable eléctrico y el enchufe deben ser accesibles para la desconexión siempre. Si es el cable eléctrico el daños es se deben substituir por la cuerda de la aprobación de los fabricantes para asegurar grados apropiados del voltaje.

## Machine Overview

### Machine Diagram

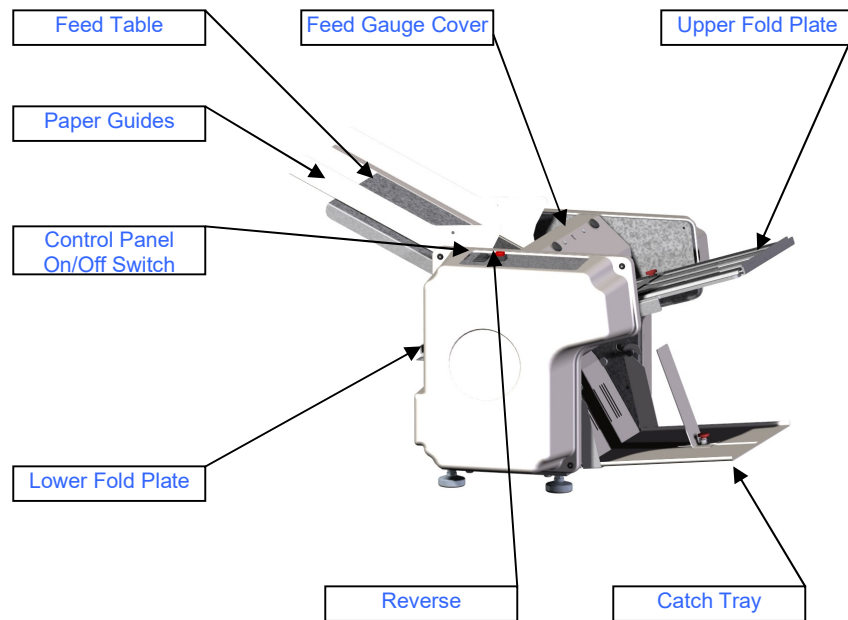

Figure 6: Machine Diagram

### Capabilities

Your **LMQ** is designed from the ground up to be a versatile folding and sealing machine. Its capabilities include:

- Folding perforated pressure seal self mailers from 20lb to 80lb stock.
- Folding all standard fold patterns [see Table 1].
- Single fold capability: when the bottom fold plate is in the half fold position, the upper fold plate can be set to lengths other than the standard **V Fold** depending on your special needs.

### Diagnosing the Paper Jam

Table 3 outlines the different problems which cause paper jams and the symptoms which will help you to identify the cause.

Problem	Double Feed	Buckled Form	Bad Fold
Symptom	Unfold the form that caused the jam, you will find that it is actually two forms folded together.	There will be an extra fold in form near the correct fold location.	The form which caused the jam will be folded crooked.
Causes	<ul style="list-style-type: none"> <li>• Bad Feed Gauge Setting</li> <li>• Too much paper on the feed table</li> </ul>	<ul style="list-style-type: none"> <li>• Wrong fold plate setting</li> </ul>	<ul style="list-style-type: none"> <li>• Feed Table Paper Guide set improperly</li> <li>• Fold Plates set improperly</li> </ul>
Solution	<ul style="list-style-type: none"> <li>• ¼ Turn CCW on feed gauge adjust screw</li> </ul>	<ul style="list-style-type: none"> <li>• Check both fold plates. Make sure they are set to the correct mark on the scale.</li> </ul>	<ul style="list-style-type: none"> <li>• Check both fold plates. Make sure that both paper stops are square.</li> </ul>

Table 3: Paper Jam Diagnostics

### Misaligned Folds

If your forms are running through the machine OK but they're folding a little bit crooked or are not folding right on the perforation, you need to tweak the fold plate settings. The location of perforations on forms generally fluctuates by about 1/16" in either direction. Forms manufacturers do this to avoid the forms sticking together too much. Because of this fluctuation, it is sometimes necessary to fine tune the placement of the paper stop on one of the fold plates.

The first step is to identify which fold plate is misaligned. Watch the form as it is fed into the machine, and then compare it to the finished form. If you're having trouble visualizing which fold is off, refer to the section **Loading the Feed Table** above.



## Troubleshooting

### Automatically Clearing a Paper Jam

If paper becomes jammed in the machine:

1. Remove all paper from the **Feed Table**.
2. If the **Breaker Power Switch** has tripped (light is off) then flip into the on (lighted) position.
3. Remove the **Lower Fold Plate**.
4. Press the **Reverse** button.
5. The paper should exit from the back (where the lower fold plate normally sits). If it does not, try pressing the **Reverse** button again. If the paper is not moving or you cannot see it, then you need to manually clear the jam [see next section].
6. Replace the Lower Fold Plate.

### Manually Clearing a Paper Jam

1. Disconnect the power cord from the machine.
- ⚠ **Make sure that the power cord has been disconnected before continuing!**
2. Remove all paper from the **Feed Table**.
3. Remove the **Lower Fold Plate** from the machine.
4. Remove the access panel in the side cover.
5. Place the **Breaker Bar** socket over the hex end of the #3 roller.
6. Rotate the breaker bar clockwise until the jammed form is out of the machine.
7. Replace the lower fold plate.
8. Replace the paper on the feed table.
9. Return the breaker bar to the toolkit.
10. Replace the side cover access panel.
11. Make sure that the **power switch** is in the **off** position.
12. Connect the power cord to the machine.

### Standard Controls

- The **Reverse** button is used to clear a jam.
- The **Run** button is used to start and stop the machine

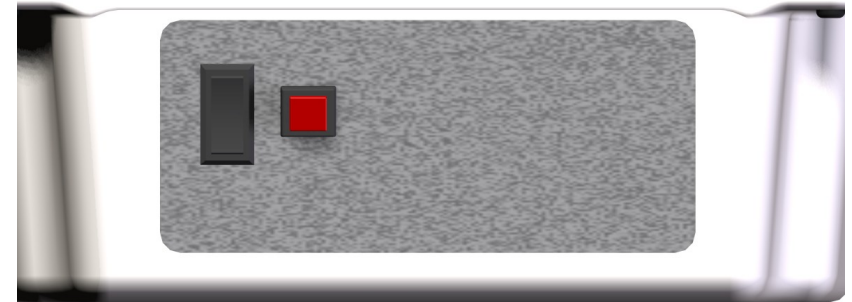

### Fold Plates

The **LMQ** is equipped with adjustable fold plates. The red thumb screws can be loosened to allow you to move the paper stop to the correct position for your form and then tightened to hold the stop in place. All standard folds are marked on the scales of both the upper and lower fold plates. Set both fold plates to the desired setting (i.e. 11" Z) in order to perform that fold. See **Machine Operation** for more information.

## Machine Operation

### Identifying Your Fold

1. Identify your paper size. 11" forms are the standard letter size; 14" forms are the standard legal size. Measure the form if necessary.
2. Identify the fold shape from Table 1. Note that **Eccentric Z** (EZ) folds are a similar shape as the standard **Z** fold, but the lengths of the folds are not equal.

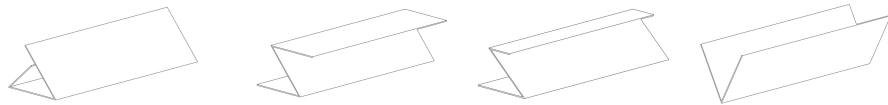

C Fold	Z Fold	EZ Fold	V Fold
--------	--------	---------	--------

Table 1: Fold Types

### Feed Table Setup

#### Setting the Paper Guide Width

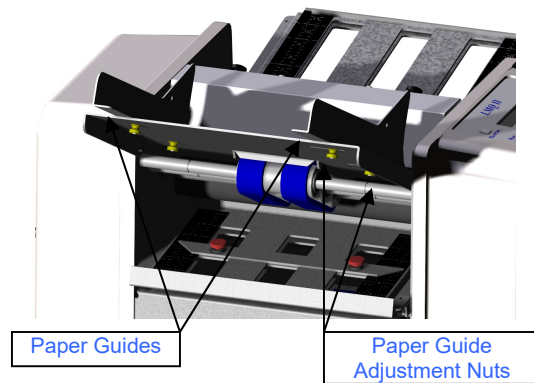

Figure 7: Feed Table Diagram

To set the width of the **Feed Table Paper Guides** [see Figure 9]:

1. Loosen the brass **Paper Guide** adjustment screws. Don't fully remove them. 1-2 turns counter clockwise will loosen them.

## Maintenance

Regular maintenance on the **LMQ** will ensure that the machine continues to function properly and will extend the life of the machine. Perform the following steps every 10,000 forms or once a month:

1. Disconnect the power cord from the machine.
2. Remove both fold plates.
3. Vacuum any paper dust or toner that has accumulated on the feed table and on the rollers.
- ⚠ **Make sure that the power cord has been disconnected before continuing!**
4. Open the access panel in the side cover opposite the control panel.
5. Insert the 7/16" socket at the end of the breaker bar over the hex shaped end on the #3 roller. This bar can now be used to rotate the rollers.
6. Clean the **stainless steel rollers** with a household cleaner such as **Oops** in order to remove any accumulated toner. As you clean, use the breaker bar to rotate the rollers so that the entire roller surface is cleaned.
7. Clean the **rubber rollers** and the **feed belts** using a **rubber roll rejuvenator** [available at your local office supply store]. Use the breaker bar to rotate the rolls and feed belt as you clean so that all the rubber surfaces are cleaned.
8. Return the breaker bar to the toolkit and replace the access panel.
9. Replace the fold plates.
10. Make sure that the **power switch** is in the **off** position.
11. Connect the power cord to the machine.

5. Tighten the thumb screws, being careful that the paper stop does not slide out of square.
6. Return the Fold Plate to the machine, making sure that it is resting properly on the placement pins [see Setup Procedure].
  - a. If you are doing a **V Fold**, replace the **Lower Fold Plate** backwards, so that the flat face is facing in and the slot is facing out.

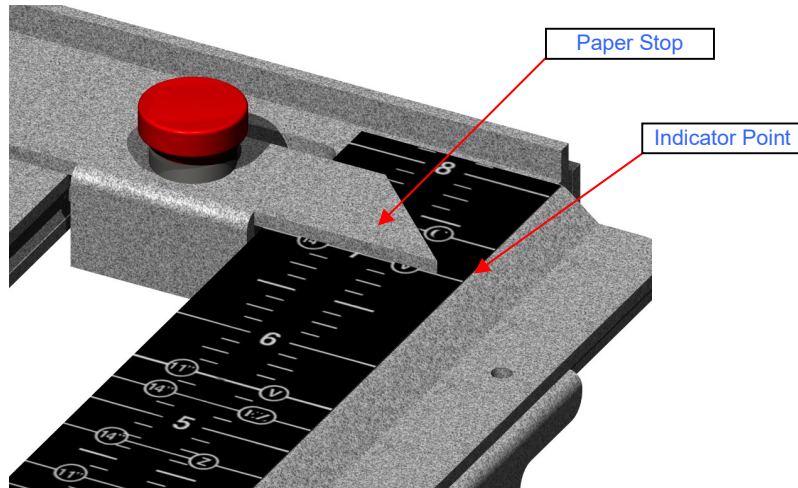

**Figure 9: Paper Stop Alignment**

For a custom form, the fold plate scales measure distance in inches from the fold, so the paper stop can be set to the appropriate measurement. If you are unclear about the figures to use, you can measure the lengths of the folds on your form (the distance from the perforations or fold marks to the edge of the paper) or contact your form supplier for more information.

## Running the LMQ

### Standard Controls

- The **Reverse** button is used to clear a jam.
- The **Run** button is used to start and stop the machine

2. Place a ½” stack of the form to be run on the feed table.
3. Line the paper stack up against the stationary paper guide.
4. Push the moveable paper guide up against the paper stack so that all the paper is aligned and the paper guide is snug against the side of the stack.
5. Hold the moveable guide in place with one hand and tighten the adjustment nuts with the other.

### Setting the Feed Gauge

To properly set the **Feed Gauge System** [see Figure 10]:

- ⚠ Make sure that the **power switch** is in the **off** position.

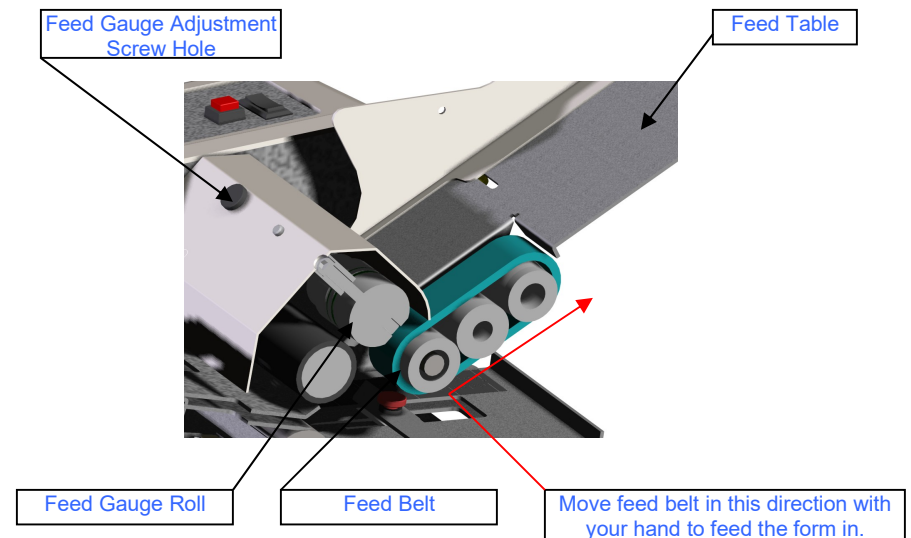

**Figure 8: Feed Gauge Cross Section View**

1. Remove all paper from the feed table.
2. Insert the provided  $\frac{3}{16}$ ” **T-Handle Hex Driver** into **Feed Gauge Adjustment Screw**.
3. Turn the T-Handle  $\frac{1}{4}$  turn clockwise to loosen the **Feed Gauge Wheel**.
4. Place 1 form on the feed table and hand feed the form about 2” into the machine by moving the feed belt with your hand.
5. Turn the T-Handle  $\frac{1}{4}$  turn counter-clockwise.

6. Pull the paper out of the machine. You should feel resistance, but not too much. Repeat steps 4-6 until there is a moderate amount of resistance when pulling the form out. If it feels too tight, turn the T-Handle  $\frac{1}{4}$  turn clockwise.
7. Return the T-Handle to the toolkit.

### Loading the Feed Table

Before loading the feed table, square up the stack of paper you are going to load by placing it on edge on a flat surface. Place the stack onto the table so that the front of the stack butts up against the feed gauge cover [do not push hard].

The proper orientation of the paper when loaded onto the feed table depends on the type of fold you are doing and the layout of your form. Table 2 shows the order in which folds will be performed when run through the machine with the right hand paper edge being loaded into the machine first (red arrow shows paper path). All forms should be loaded with glue on the leading edge facing up (the glue is usually visible as yellow, blue or red stripes around the edge of the form). With **Z & EZ Folds** you have multiple ways to load the form and still have glue on the leading edge facing up, either one will work. With **EZ Folds** though, care must be taken to ensure that the upper fold plate is set to the proper length for the leading fold (the bottom fold plate setting remains the same either way).

### Feed Table Capacities

- 11" Forms: 250 Sheets
- 14" Forms: 200 Sheets

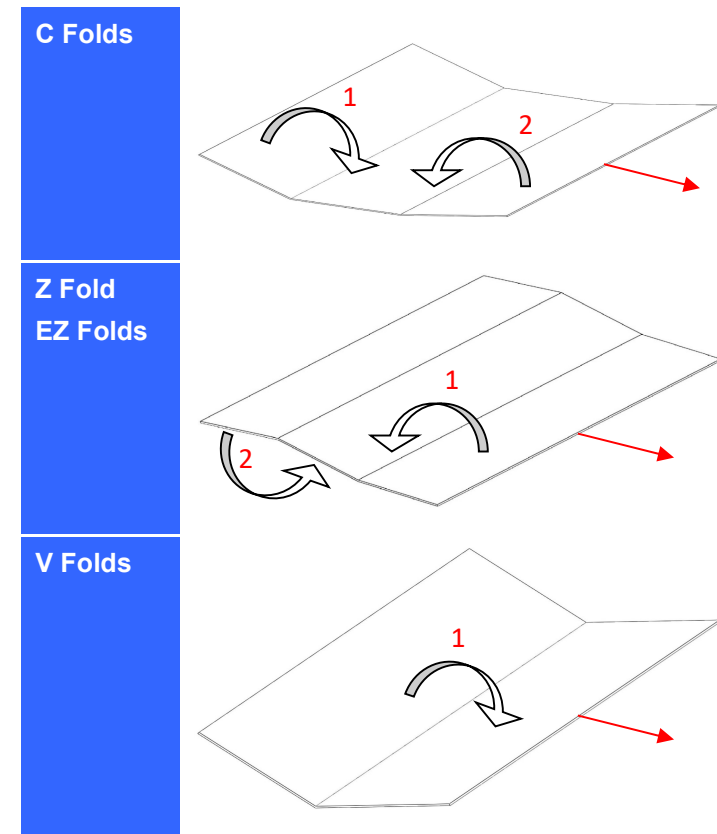

Table 2: Paper Loading & Fold Order

### Setting the Fold Plates

To set a fold plate:

1. Remove the fold plate from the machine.
2. Loosen the thumb screws by turning counter-clockwise
3. Line up the tips on both sides of the paper stop with the appropriate line on the scale so that the appropriate white line on the scale is just visible [see Figure 11].
  - a. If you are doing a **V Fold**, you do not have to set the paper stop on the **Lower Fold Plate**.
4. Make sure that the paper stop is setup square by double-checking that the scales on both sides show the same fold selected or the same inch reading.