

## TS-940S - LDMOS PA Installation Instructions - June 2023

### Pre-Installation WARNINGS:

- *Be really careful about PA POWER polarity. Reverse polarity on this board will permanently damage the PA board!*
- *Please make sure that the new PA board is fully secured to the chassis before powering it up and that heat sink compound has been properly applied according to the images on the following pages and the online video at [k6iok.com](http://k6iok.com).*
- *When measuring voltages on the PA board, be very careful. Surface mounted parts are difficult to measure and components are extremely difficult to replace.*
- *Do NOT adjust the 2 potentiometers on the board. These are pre-adjusted at the factory and do not require adjustment. Mis-adjustment will permanently damage the board.*
- *There should be 2 jumpers installed on the JP2 & JP3 headers during normal operation. The (JP1) header should not have a jumper applied and is for factory use only.*
- *Make sure that you always have a fan connected and running on the heatsink at all times when RF is applied to this amplifier board. LDMOS devices generate a considerable amount of heat and this heat must be dissipated to avoid damage. Remember to connect the PA fan to the fan output on the new AVR Board so that the fan runs continually. As long as this heat is continually removed, the board will be just fine!*

**NOTE:** We highly recommend that you do not install this upgrade unless you have previously installed the K6IOK Power supply upgrade first. This is not to sell more product, but to make sure that clean 28 Volt power is applied to this PA Upgrade board to avoid damage.

### Unpacking the kit:

Unpack the kit and make sure that you have the following components:

- The TS-940S PA Upgrade Board with LDMOS device pre-installed and bias adjusted
- 1 ea. - Heat spreader made of solid copper
- 4 ea. - Black installation washers (spacers)
- 5 ea. - M3 x 10mm Stainless Steel machine mounting screws
- 1 ea. - 3 pin header plug with single Red wire on TXC pin
- 1 ea. - Tube of Heat sink compound
- This instruction Manual

### TS-940S or TS-930S - Installing the NEW PA board onto the heat sink and adding the Heat Spreader – No Insulators required

After you have removed everything from the original Heat sink, Use alcohol or other cleaning solution to completely clean the original heat sink compound from the heat sink as shown. The 3 pads with the RED line around them in the diagram are the only 3 that require heat sink compound under the heat spreader. These locations are all grounded so there is no need for insulators of any kind. Before mounting the heat spreader on the heat sink, spread a small amount of heat sink compound on each of the 3 mounting locations shown to the right.



On the MRF101AN device, you should fully cover the back side of the LDMOS part as well (top side of the heat spreader) with heat sink compound before installing the screws (as seen on the picture below) – Figure 1.

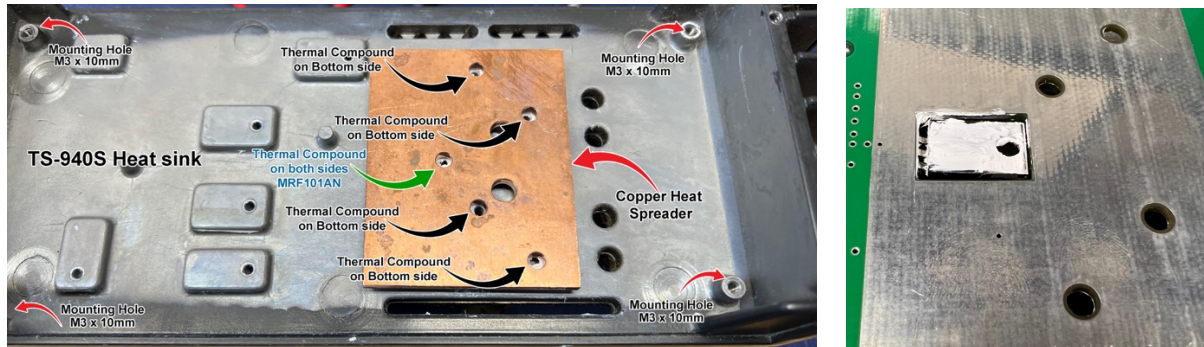
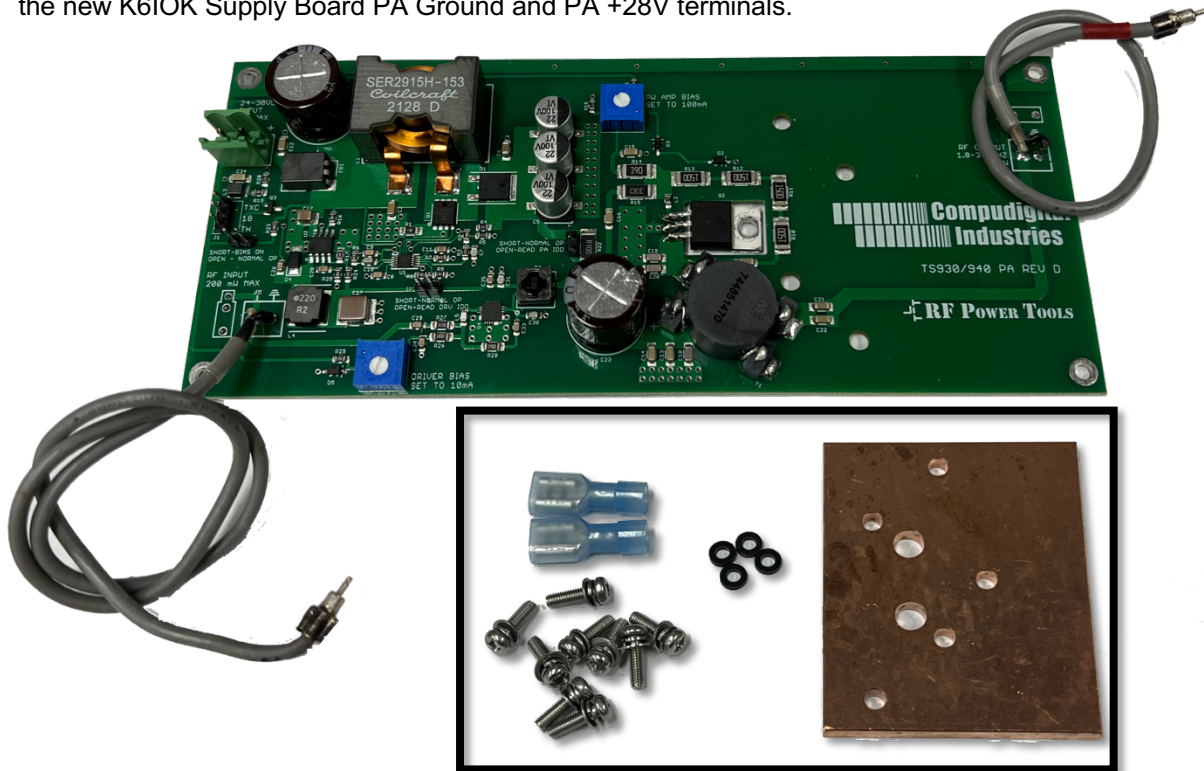

**Figure 1**

**Installing RF Input and Output cables on the NEW PA board before installation**

There are 4 cables that must be installed on the TS-940S & TS-930. RF input, RF Output, Txc and Power must be connected. The long coax cable (left) is for the input signal, and the short coax cable (right) is the output. On the TS-940S, these cables are soldered in. (Use the original cables from your original PA Board) On the TS-930S, the most PA boards have plugs installed. When soldering these cables onto the TS-940S models, make sure you pay attention to the Ground side and signal side. The signal side normally is the one with the clear insulation.

The power connection is pre-cable on the New PA board. This red and black/brown power cable ties to the new K6IOK Supply Board PA Ground and PA +28V terminals.



*Heat Spreader & Accessory Kit Parts*

## TS-940S PA - Mounting the Board on the Heat Sink

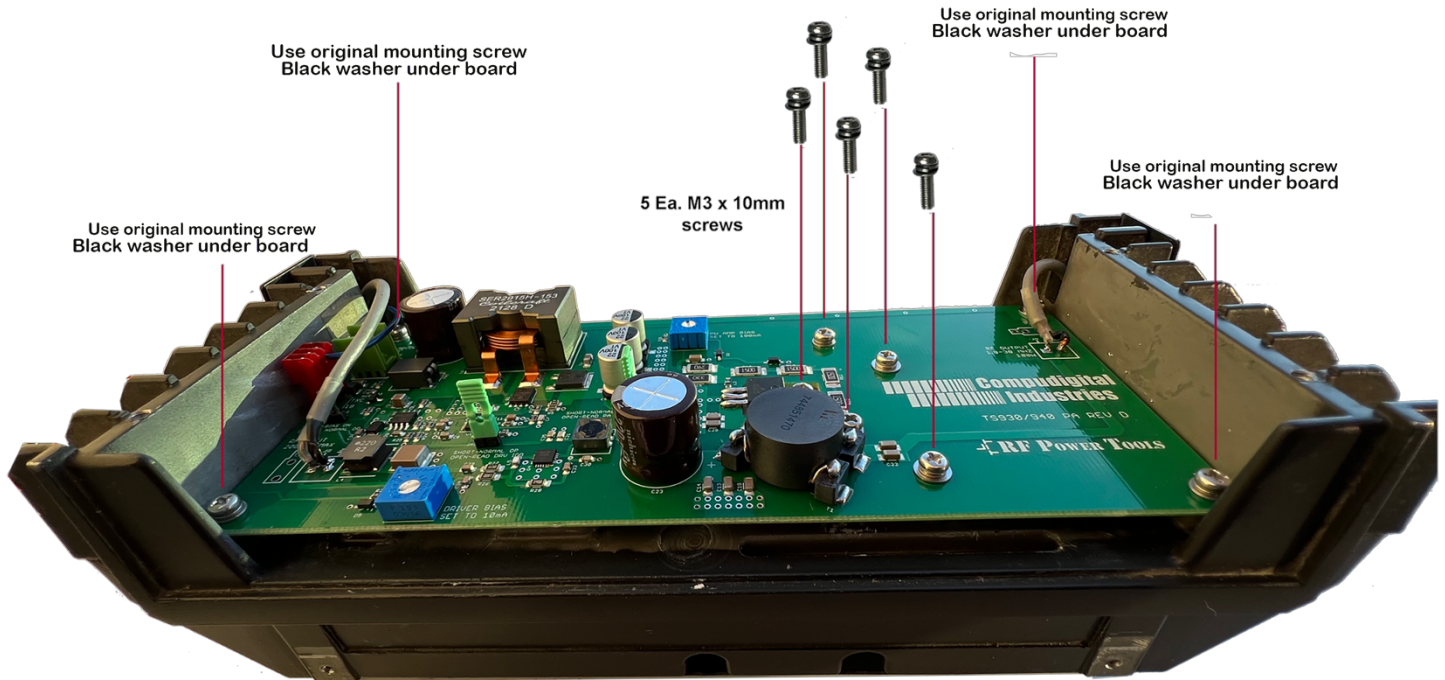

### 9 Mounting screw locations

Figure 2

After spreading the heat sink compound onto the heatsink locations, place the 4 fiber washers under the board in the 4 corners, and loosely install the original mounting screws into the 4 corners. Next, place the M3 x 10mm screw into the MRF101AN Tab loosely. Install the other 4 screws into the heat sink. Then 1 by 1, tighten the screws so that all 5 screws are tight. There is no need to over tighten these screws but do make sure that the MRF101AN screw is good and snug. This assures a good heat transfer to the copper heat spreader. The 4 corner mounting screws just need to be snug, not tight.

### Cable Routing

After installing all of the screws, you need to properly route the cables to the fan side of the heat sink to connect to the radio. You should have 3 cables, RF input, Tx/C, and Power to route to the fan side of the PA. Route them as shown on the images below. If you are keeping the original fan, route that cable with this bundle as well.

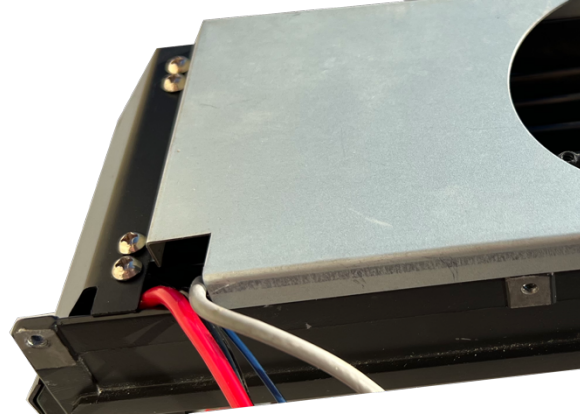
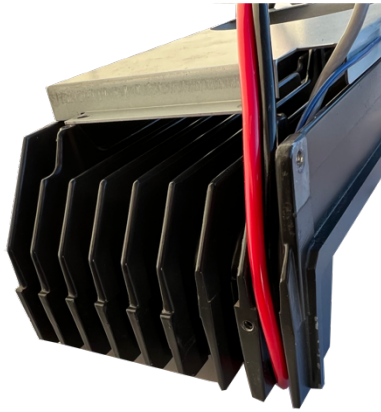

On the filter board, the transmit “Key” line is marked as TXC (as shown on the Figure 4 picture). We supply you with a 3 pin header with only 1 red cable connected with this upgrade (shown on the left Fig 3). This Red cable should be connected to the existing Red cable that was originally plugged into the filter board as shown on in figure 4 on the right. Simply splice the RED wire from the upgrade kit (Figure 3) to the Red wire on the original 3 pin header plug (Figure 4). The Black and Blue wires on the filter board are no longer used with this upgrade.



Figure 3

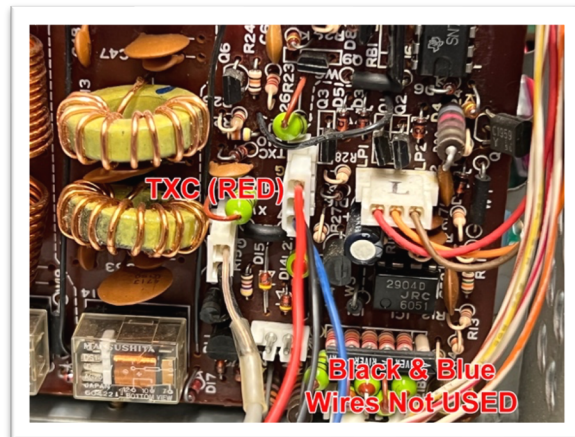

Figure 4

### ***Theory of Operation***

This new LDMOS PA board for the TS-930S and TS-940S transceivers uses the latest LDMOS Power amplifier device, MRF-101. These devices run at 50+ Volts which is supplied by the surface mount circuitry on the left side of the board. The 28V Supply voltage is converted to about 53V by this circuitry. Typical output voltage of the regulator is set to about 53.5V.

There is an RF pre-amplifier also built into the board which provides the proper drive to excite the MRF101AN LDMOS Power amplifier. This board is designed to accept up to 200mw (+10db) of drive from the radio and based on the input signal, drive the output to approximately 100 watts.

As with any other PA Device, heat is one of the most critical things to watch. **Make sure that you always have the PA fan running while you are transmitting, no matter how much power you are running.** The LDMOS chip is a stout device but excessive heat is a killer! The stock fan on both the TS-930S and TS-940S are perfect for keeping these devices cool. We have noticed that some of these stock fans are

failing so we are preparing a fan upgrade kit that allows you to install a new fan between the PA module and the filter board. We have the fan kit available for the TS-940 and are working on a kit for the TS-930.

### RF Output

The maximum 100 watt output is fed directly to the filter board on the TS-930 and TS-940. We are constantly asked about creating a power amplifier board that runs more power but remember that the filter board on the output of this amplifier is only rated at 100 watts. Running more power will damage everything past the PA board.

### IMPORTANT! TS-940S and TS-930S ALC (Automatic Level Control)

When Kenwood designed these radios, they created a PA Board that was actually capable of much more power than the radio is rated for. If you run the original board without the ALC, you will absolutely damage the drivers and/or finals. As we all know, the repair parts are no longer available for the original PA.

The purpose of the ALC is to sample the output power and if the output level gets too high, or the SWR (reflected power) gets too high, the ALC circuitry then responds by turning the drive level down to protect the PA from damage. **So no matter what you do, don't disconnect the ALC circuit.**

You might find that after you install the new PA board, your ALC acts differently than you are used to. In some cases, the ALC meter indication will understate or overstate the ALC levels. **Or more commonly, there will be no indication at all.** But the most important thing to remember that on the old PA or the new one, whenever you see ALC activity on the meter while transmitting, the amp is being folded back by the ALC circuit and the power level is being reduced. So by running your ALC at a high level, you are not accomplishing anything! Please also remember that those who have owned the radio before you bought it may have changed the ALC level internally and/or other levels and this can also effect your ALC readings.

**Be nice to your finals and run them at a nice easy level. If you are looking for more power, use an external amplifier!**

So keep in mind that for the cleanest signal, it is best to run the power and audio levels to a point where the ALC meter is just starting to move.

### Let's Wrap it all up - Testing

Now that you have installed the new board onto the heat sink, lets fire this up for the first time.

- First, make sure that the power cable coming from the new PA board is plugged into the new K6IOK power supply board using the correct polarity. Red(+) and Black or Brown(-).
- Check to make sure that the 3 pin connector that comes from the new PA Board is plugged into the Filter Board – (Board with all of the relays) on the TS-940. There should be only 1 RED cable coming off of the 3 pin connector. And that RED wire goes to the 3 pin connector called TXC on the Filter Board. The other 2 original wires are not used.
- Make sure that the RF in and out connections to the New PA are correct. On some radios, these 2 connections are soldered onto the new board. Make sure the shield is tied to Ground and the center conductor is tied to the "RF" side on both the input and output.
- Be sure that the jumpers at JP2 and JP3 are installed on the New PA board. There should be no jumper on the JP1 connector. (Factory use only)

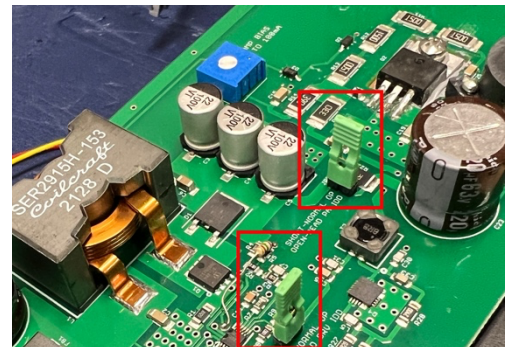

Figure 5

## TESTING THE NEW PA

- Turn the Power control and the Mic level control all of the way counterclockwise on the radio
- Hook a dummy load to the antenna connector and a wattmeter inline if available
- Turn on the power switch

### PA Board DC High Voltage Pre-Test

Next, grab a voltmeter and check to make sure you have approximately 53 volts from ground to the output transformer as shown to the right in receive mode. If you have about 53V there, that is an indication that the power supply section of the new PA is working as it is supposed to. (Figure 6)

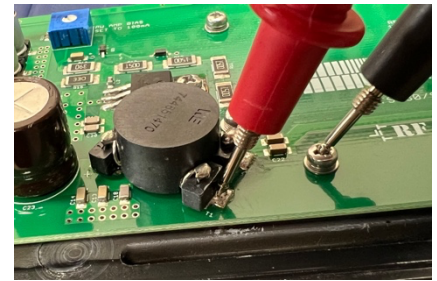

Figure 6

### Functional testing

- Place the transceiver in CW mode
- While the radio is powered up, make sure that the fan on the back of the PA unit is running. If not, make sure it is plugged into the fan connector on the K6IOK supply upgrade board. Again, the PA fan must be running before applying RF power to the new amplifier. Pictured on the right is our new TS-940 fan upgrade which replaces the original fan. This new fan is only 15mm thick making it perfect for use on the TS-940 PA and very quiet. (Figure 7)



Figure 7

- Key the transmitter, and then turn the carrier level on the top of the radio up to about 50 watts for about 1 minute. After 1 minute, unkey the transmitter. The current level (IC) during transmit is expected to be less than 7 amps.
- Check the temperature on heat sink to make sure it is starting to get warm. It takes time for the heatsink to start radiating heat so be patient. If after 1 minute, of transmitting, the heat sink starts heating up, that is a great sign that everything is working as it should.
- If this check is successful, you can then turn the power up to 100 watts for a short time and check all of the levels.

We hope you enjoy the new PA upgrade. It has taken substantial time to design, test, and document the installation of this kit. If you have any troubles installing or using this kit, please contact us!

**Please be sure to watch the installation videos at <https://k6iok.com/videos>. There are installation videos for all of our products at this site that make installation much easier.**

**Because this is a brand new product, you might see an issue with something in this document or in the installation video where I have missed something. If so, please feel free to call and let me know. Thank you,**

**Jeff Hilliard AK6OK**

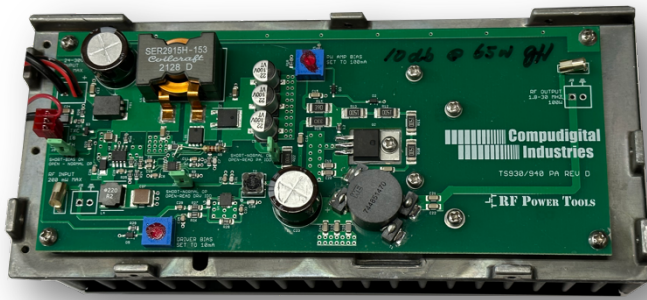

*TS-930 PA Completed*



*TS-940 PA Completed*

**CHECK OUT OUR NEW CONNECTOR & CABLE PRODUCTS!**



This is our new BNC to TMP (Female) Test Cable. The TMP connectors are very difficult to find and very expensive when you can. As far as we know, this type of test cable is not offered anywhere. This cable allows you to check the input or output of your amplifiers without trying to fashion up a temporary fix to accept a TMP male. Available in 1 or 2 pack. Purchase yours at [k6iok.com/cables](http://k6iok.com/cables)

**Price \$24.00 each / \$42.00 for 2 (Part number TMPF-BNC)**



To the left is our new BNC to TMP (Male) Test cable. These are perfect for interfacing signals from your Kenwood or other manufacturers radios to your test equipment.

**Price \$24.00 each / \$42.00 for 2 (Part number TMPM-BNC)**